



An Oshkosh Corporation Company



---

# **Illustrated Parts Manual**

## **Compact Crawler**

**X20JP/1**

**X20JP/2**

**X600AJ/1**

**X600AJ/2**



---

**3121614**  
July 21, 2016

# PARTS FINDER

**Search Website  
by Part Number**



**Search Manual  
Library For Parts  
Manual & Lookup Part  
Numbers – Purchase  
or Request Quote**

**Search Manuals**

Enter your information to help us find the right parts manual for your machine.

\* Brand:

\* Model:

\* Serial:

\* Part Number:

SEARCH

**Can't Find Part or  
Manual? Request Help  
by Manufacturer,  
Model & Description**

**Parts Order Form**

Please fill in the following information to help us find the right part for your machine.

Manufacturer:	<input type="text"/>
Model:	<input type="text"/>
Description:	<input type="text"/>
Part Number:	<input type="text"/>
Quantity:	<input type="text"/>
Notes:	<input type="text"/>

Submit

Discount-Equipment.com is your online resource for quality parts & equipment.

Florida: **561-964-4949** Outside Florida TOLL FREE: **877-690-3101**

**Need parts?**

Click on this link: <http://www.discount-equipment.com/category/5443-parts/> and choose one of the options to help get the right parts and equipment you are looking for. Please have the machine model and serial number available in order to help us get you the correct parts. If you don't find the part on the website or on one of the online manuals, please fill out the request form and one of our experienced staff members will get back to you with a quote for the right part that your machine needs.

We sell worldwide for the brands: Genie, Terex, JLG, MultiQuip, Mikasa, Essick, Whiteman, Mayco, Toro Stone, Diamond Products, Generac Magnum, Airman, Haulotte, Barreto, Power Blanket, Nifty Lift, Atlas Copco, Chicago Pneumatic, Allmand, Miller Curber, Skyjack, Lull, Skytrak, Tsurumi, Husquvarna Target, Stow, Wacker, Sakai, Mi-T-M, Sullair, Basic, Dynapac, MBW, Weber, Bartell, Bennar Newman, Haulotte, Ditch Runner, Menegotti, Morrison, Contec, Buddy, Crown, Edco, Wyco, Bomag, Laymor, EZ Trench, Bil-Jax, F.S. Curtis, Gehl Pavers, Heli, Honda, ICS/PowerGrit, IHI, Partner, Imer, Clipper, MMD, Koshin, Rice, CH&E, General Equipment, Amida, Coleman, NAC, Gradall, Square Shooter, Kent, Stanley, Tamco, Toku, Hatz, Kohler, Robin, Wisconsin, Northrock, Oztec, Toker TK, Rol-Air, APT, Wylie, Ingersoll Rand / Doosan, Innovatech, Con X, Ammann, Mecalac, Makinex, Smith Surface Prep, Small Line, Wanco, Yanmar



 SOTTOCARRO CINGOLATO

RAUPENFAHRWERK 

 TRACKED UNDERCARRIAGE

CARRO DE ORUGAS 

 CHENILLARD

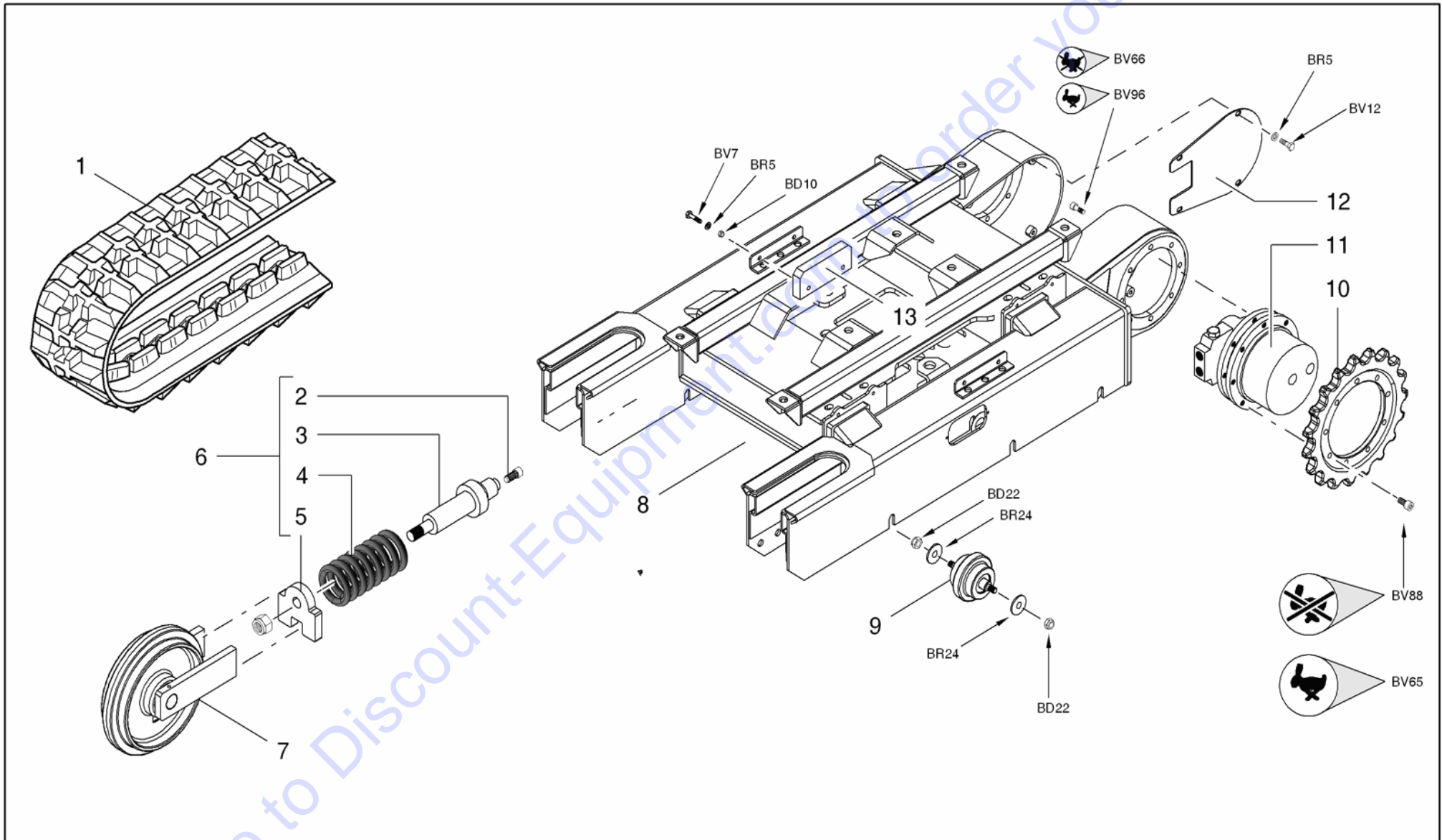





 SOTTOCARRO CINGOLATO

 RAUPENFAHRWERK

 TRACKED UNDERCARRIAGE

 CARRO DE ORUGAS

 CHENILLARD

POS	Codice	Q.tà	 Descrizione	 Description	 Designation	 Benennung	 Descripción
1	257215L0	2 NR	CINGOLO IN GOMMA BASSO PROFILO PT10	RUBBER TRUCK LOW PROFILE PT10	RUBBER TRACK LOW PROFILE PT10	GUMMIKETTE LOW PROFILE PT10	CAUCHO PISTA DE BAJO PERFIL PT10
1	257215LB	2 NR	CINGOLO IN GOMMA BASSO PROFILO ANTITRACCIA PT10	RUBBER TRUCK LOW PROFILE NO MARKING PT10	RUBBER TRACK LOW PROFILE ANTI-PT10	GUMMIKETTE LOW PROFILE ANTI-PT10	CAUCHO PISTA DE BAJO PERFIL ANTI-PT10
2	03149200	1 NR	VALVOLA IDRAULICA	HYDRAULIC VALVE	VALVE HYDRAULIQUE	HYDRAULIKVENTIL	VÁLVULA HIDRÁULICA
3	10681670	1 NR	CILINDRO	CYLINDER	VÉRIN	ZYLINDER	CILINDRO
4	03024801	1 NR	MOLLA	SPRING	RESSORT	FEDER	MUELLE
5	04635800	1 NR	PIASTRA	PLATE	PLATINE	PLATTE	PLACA
6	147306Y1	2 NR	SUPPORTO TENDICINGOLO	IDLER SUPPORT	SUPPORT TENDEUR CHENILLE	KETTENSANNH ALTERUNG	SOPORTE TENSOR ORUGA
7	147309H2	2 NR	RUOTA TENDICINGOLO	IDLER WHEEL	ROUE TENDEUR DE CHENILLE	RAUPENSPANNRAD	RUEDA TENSOR ORUGA
8	17249100	1 NR	SOTTOCARRO CINGOLATO	TRACKED UNDERCARRIAGE	CHENILLARD	RAUPENFAHRWERK	CARRO CON ORUGAS
9	147310H2	6 NR	RULLO INFERIORE	CARRIER ROLLER	ROULEAU INFÉRIEUR	TRAGROLLE	RODILLO INFERIOR





 SOTTOCARRO CINGOLATO

 RAUPENFAHRWERK

 TRACKED UNDERCARRIAGE

 CARRO DE ORUGAS

 CHENILLARD

POS Codice	Q.tà	 Descrizione	 Description	 Designation	 Benennung	 Descripción
10 257225H2	2 NR	RUOTA MOTRICE	DRIVE WHEEL	ROUE D'ENTRAINEMENT	ANTRIEBSRAD	RUEDAS
11 25218200	2 NR	MOTORIDUTTORE	GEAR MOTOR	MOTORÉDUCTEUR	GETRIEBEMOTOR	MOTORREDUCTOR
11 273305H2	2 NR	MOTORIDUTTORE	GEAR MOTOR	MOTORÉDUCTEUR	GETRIEBEMOTOR	MOTORREDUCTOR
12 073135H2	2 NR	COPERCHIO MOTORI CARRO	COVER TRUCK MOTORS	COUVERTURE MOTEURS DE CAMION	COVER LKW-MOTOREN	CUBRIR LOS MOTORES DE CAMIONES
13 07313400	2 NR	PATTINO GUIDACINGOLO SUPERIORE	PAD GUIDE TRACK TOP	EMPEIGNE GUIDACINGOLO	SCHUHOBERTEIL S GUIDACINGOLO	ZAPATO ALTO GUIDACINGOLO

Go to Discount-Equipment.com to order your parts

 ALLARGAMENTO IDRAULICO

 HYDRAULIC EXTENSION



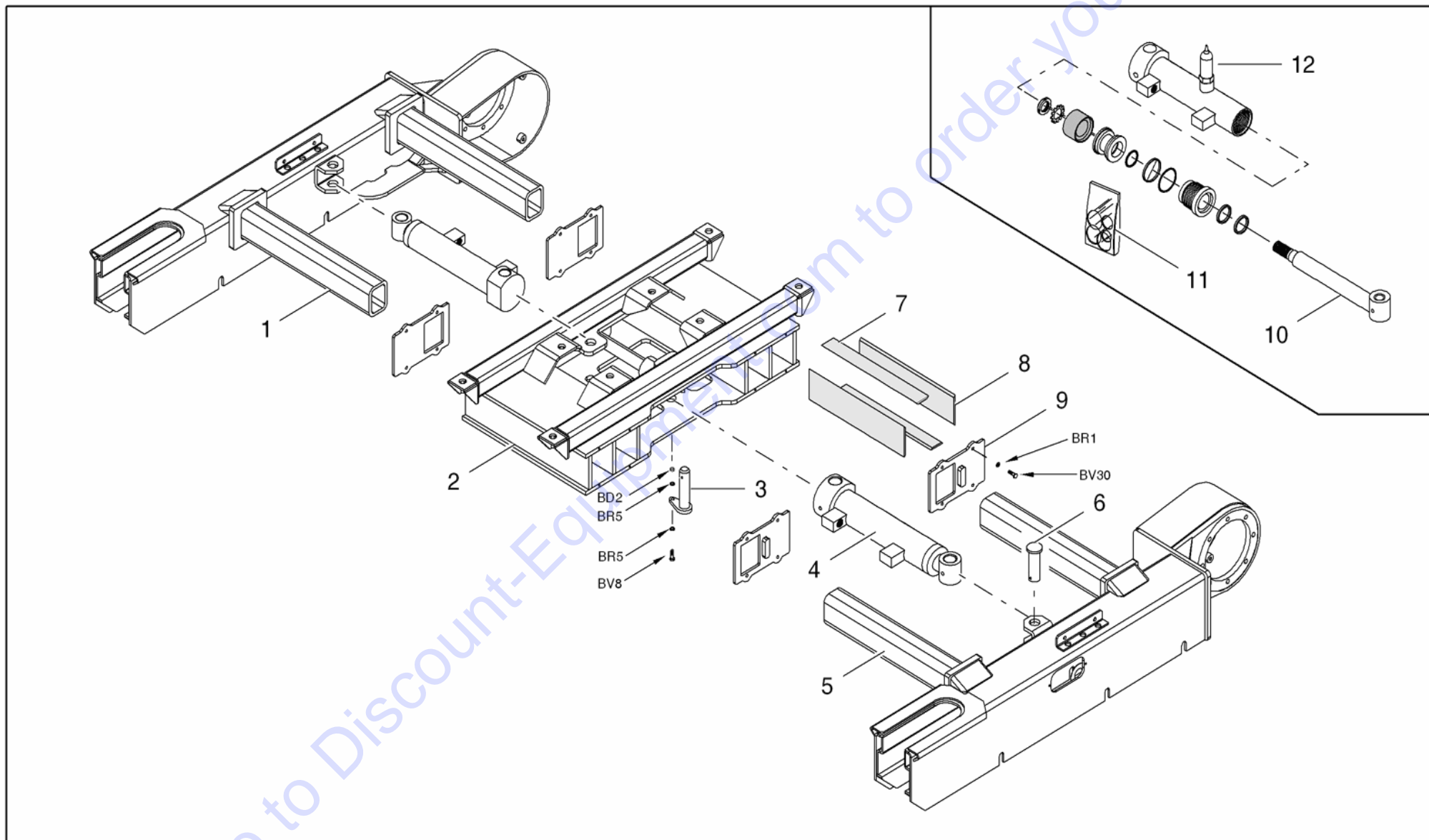

 ECARTEMENT HYDRAULIQUE

HYDR. SPURWEITENVER STELLEINRICHTUNG 

EXTENSION HIDRAULICA 



 ALLARGAMENTO IDRAULICO
HYDR. SPURWEITENVER STELLEINRICHTUNG 
 HYDRAULIC EXTENSION
EXTENSION HIDRAULICA 
 ECARTEMENT HYDRAULIQUE





POS Codice	Q.tà	 Descrizione	 Description	 Designation	 Benennung	 Descripción
1 37249400	1 NR	LONGHERONE DESTRO	RIGHT SIDE MEMBER UNDERCARRIAGE	LONGERON DROIT	RIGHT LAENGSTRAEGE R	MIEMBRO DEL LADO DERECHO
2 37249100	1 NR	STRUTTURA CENTRALE SOTTOCARRO	CENTRAL STRUCTURE UNDERCARRIAGE	UNDERTRUCK DE STRUCTURE CENTRALE	ZENTRALE STRUKTUR UNDERTRUCK	UNDERTRUCK ESTRUCTURA CENTRAL
3 06023800	2 NR	SPINA FONDELLO ALLARGAMENTO	BOTTOM PLUG ENLARGEMENT	BAS PLUG ELARGISSEMENT	UNTEN PLUG ERWEITERUNG	BASE ENCHUFE AMPLIACIÓN
4 27227400	2 NR	CILINDRO ALLARGAMENTO SOTTOCARRO	CYLINDER ENLARGEMENT UNDERCARRIAGE	UNDERTRUCK D'ELARGISSEMENT BOUTEILLE	ZYLINDER ERWEITERUNG UNDERTRUCK	UNDERTRUCK AMPLIACIÓN DEL CILINDRO
4 272274H2	2 NR	CILINDRO ALLARGAMENTO SOTTOCARRO	CYLINDER ENLARGEMENT UNDERCARRIAGE	UNDERTRUCK D'ELARGISSEMENT BOUTEILLE	ZYLINDER ERWEITERUNG UNDERTRUCK	UNDERTRUCK AMPLIACIÓN DEL CILINDRO
5 37249500	1 NR	LONGHERONE SINISTRO	LEFT SIDE MEMBER UNDERCARRIAGE	LONGERON DROIT	RIGHT LAENGSTRAEGE R	MIEMBRO DEL LADO DERECHO
6 04256300	2 NR	SPINA	PIN	CHEVILLE	STIFT	CLAVIJA
7 07278300	8 NR	GUIDA ALLARGAMENTO	EXPANSION GUIDE	GLISSIÈRE ÉLARGISSEMENT	FÜHRUNGSVERB REITERUNG	GUÍA DE EXTENSIÓN



 ALLARGAMENTO IDRAULICO

 HYDR. SPURWEITENVER STELLEINRICHTUNG 
 HYDRAULIC EXTENSION

 EXTENSION HIDRAULICA 
 ECARTEMENT HYDRAULIQUE

POS Codice	Q.tà	 Descrizione	 Description	 Designation	 Benennung	 Descripción
8 07278200	8 NR	GUIDA ALLARGAMENTO	EXPANSION GUIDE	GLISSIÈRE ÉLARGISSEMENT	FÜHRUNGSVERB REITERUNG	GUÍA DE EXTENSIÓN
9 372768H2	4 NR	COPERCHIO GUIDE ALLARGAMENTO	ENLARGEMENT GUIDE COVER	ELARGISSEMENT GUIDE COUVERTURE	ERWEITERUNG GUIDE COVER	GUÍA DE AMPLIACIÓN COVER
10 2722740001	1 NR	STELO ALLARGAMENTO CARRO	ROD CYLINDER ENLARGEMENT	TIGE D'EXTENSION CAMION	VERLÄNGERUNG SSTANGE TRUCK	EXTENSION ROD TRUCK
11 2722740002	1 NR	KIT GUARNIZIONI CILINDRO ALLARGAMENTO CARRO	ENLARGEMENT CYLINDER GASKET KIT	ÉLARGISSEMENT CAMION KIT CYLINDRE JOINT	ERWEITERUNG CYLINDER GASKET KIT TRUCK	PLIACIÓN DE JUNTAS CILINDRO TRUCK KIT
12 17329500	2 NR	MICROINTERRUTT ORE ALLARGAMENTO CARRO N/O COMPLETO DI CAVO E CONNETTORE	WIDENING SYSTEM MICRO SWITCH N/O CONTACT WITH CABLE AND CONNECTOR	MICRO INTERRUPTEUR ELARGISSEMENT AVEC CABLE ET CONNECTEUR	MIKROSCHALTER SPURVERBREITE RUNG MIT KABEL UND STECKER	MICROINTERRUP TOR ENSANCHAMIENT O CON CABLE Y CONECTOR

 BASE TORRETTA

ARBEITSTURM 



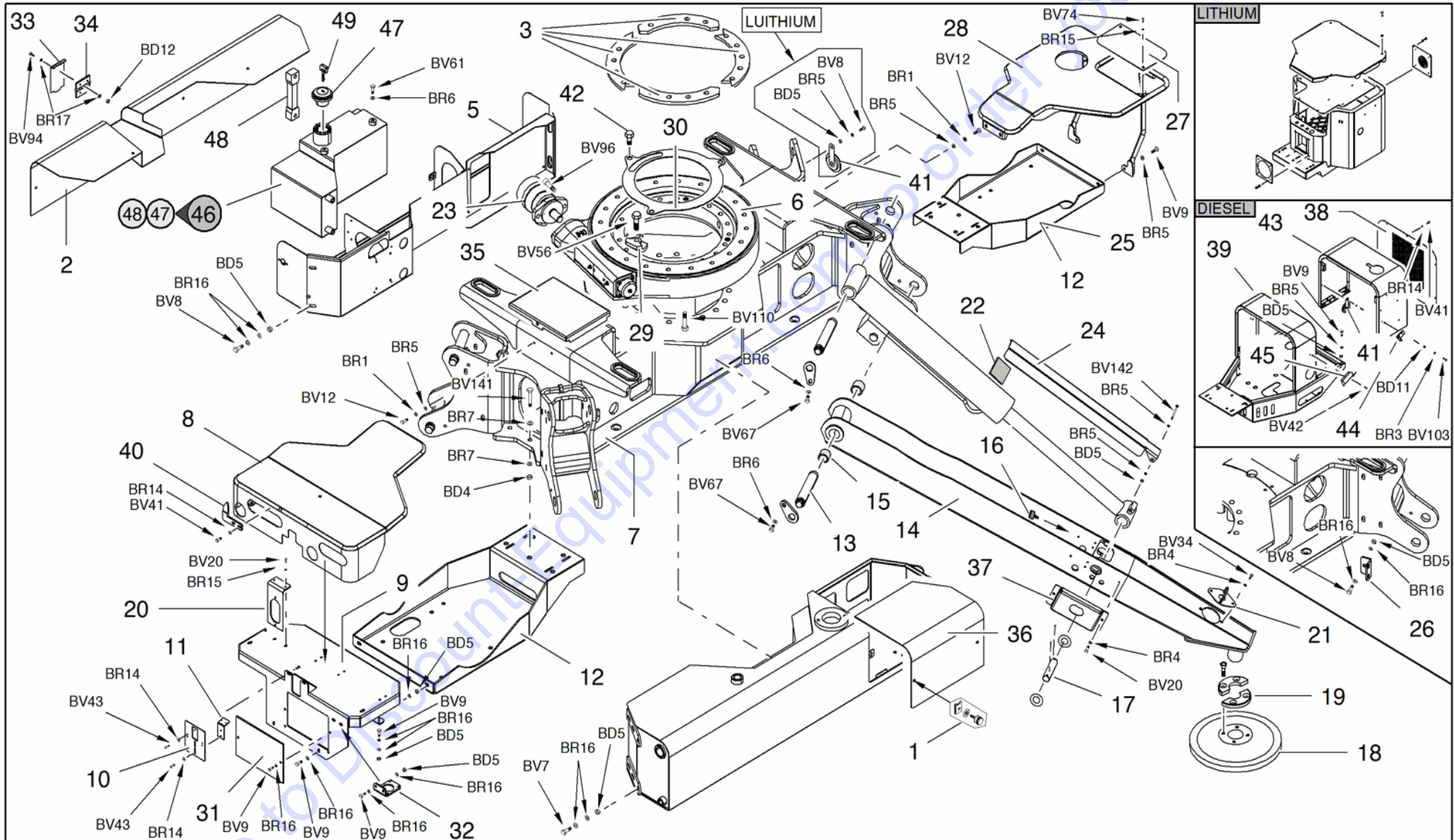

 TURRET BASE

BASE TORRETTA GIRATORIA 

 BASE TOURELLE







 BASE TORRETTA
ARBEITSTURM 
 TURRET BASE
BASE TORRETA GIRATORIA 
 BASE TOURELLE





POS Codice	Q.tà	 Descrizione	 Description	 Designation	 Benennung	 Descripcìon
1 07343200	5 NR	VITE IMPERDIBILE ZIGRINATA CORTA	SHORT IMPERDIBLE KNURLED SCREW	VIS IMPERDABLE	SCHRAUBE	TORNILLO IMPERDIBLE
1 07343300	5 NR	RICETTACOLO PER VITE IMPERDIBILE	RECEPTACLE FOR IMPERDIBLE SCREW	PRISE DE VIS POUR VIS IMPERDABLE	AUFNAHME FÜR SCHRAUBE	REFUGIO TORNILLO IMPERDIBLE
1 07343400	5 NR	AGGANCIO PER VITE IMPERDIBILE	COUPLING FOR IMPERDIBLE SCREW	CROCHET VIS IMPERDABLE	HAKEN FÜR SCHRAUBE	GANCHO TORNILLO IMPERDIBLE

Go to Discount-Equipment.com to order your parts





 BASE TORRETTA
ARBEITSTURM 
 TURRET BASE
BASE TORRETA GIRATORIA 
 BASE TOURELLE

POS Codice	Q.tà	 Descrizione	 Description	 Designation	 Benennung	 Descripción
2 17312400	1 NR	COPERCHIO COMPONENTI ELETTRICI VERSIONE DIESEL	ELECTRICAL COMPONENTS COVER DIESEL VERSION	COUVERTURE COMPOSANTS ÉLECTRIQUES DIESEL	COVER ELEKTROKOMPO NENTEN DIESEL	CUBRIR LOS COMPONENTES ELÉCTRICOS DIESEL
2 172726J0	1 NR	COPERCHIO COMPONENTI ELETTRICI	COVER ELECTRICAL COMPONENTS	COUVRIR LES COMPOSANTS ÉLECTRIQUES	COVER ELEKTROKOMPO NENTEN	CUBRIR LOS COMPONENTES ELÉCTRICOS
2 173124J0	1 NR	COPERCHIO COMPONENTI ELETTRICI VERSIONE DIESEL	ELECTRICAL COMPONENTS COVER DIESEL VERSION	COUVERTURE COMPOSANTS ÉLECTRIQUES DIESEL	COVER ELEKTROKOMPO NENTEN DIESEL	CUBRIR LOS COMPONENTES ELÉCTRICOS DIESEL
2 376837J2	1 NR	COPERCHIO COMPONENTI ELETTRICI LL2010 BENZINA MK2 (FROM C170000893)	COVER FOR ELECTRICAL ELEMENTS LL2010 GASOLINE MK2 (FROM C170000893)	COUVERTE MK2 (FROM C170000893)	DECKEL MK2 (FROM C170000893)	TAPA MK2 (FROM C170000893)
2 376838J2	1 NR	COPERCHIO COMPONENTI ELETTRICI LL2010 DIESEL MK2 (FROM C170000893)	COVER FOR ELECTRICAL ELEMENTS LL2010 DIESEL MK2 (FROM C170000893)	COUVERTE MK2 (FROM C170000893)	DECKEL MK2 (FROM C170000893)	TAPA MK2 (FROM C170000893)





 BASE TORRETTA
ARBEITSTURM 
 TURRET BASE
BASE TORRETA GIRATORIA 
 BASE TOURELLE

POS Codice	Q.tà	 Descrizione	 Description	 Designation	 Benennung	 Descripción
3 176090Y1	1 NR	KIT 4 SPESSORI FISSAGGIO SUPPORTO BRACCI 15MM CATAFORESI	KIT 4 THICKNESSES FIXING SUPPORT ARMS 15MM	KIT 4 CALES	KIT VON 4 STÄRKEN	KIT 4 ESPEORES
5 372721H1	1 NR	SCATOLA COMPONENTI ELETTRICI SALDATA	ELECTRICAL COMPONENTS SEALED BOX	COMPOSANTS ÉLECTRIQUES BOÎTE SCELLÉE	ELEKTROKOMPO NENTEN SEALED BOX	COMPONENTES ELÉCTRICOS CAJA SELLADA
5 372721J0	1 NR	SCATOLA COMPONENTI ELETTRICI SALDATA	ELECTRICAL COMPONENTS SEALED BOX	COMPOSANTS ÉLECTRIQUES BOÎTE SCELLÉE	ELEKTROKOMPO NENTEN SEALED BOX	COMPONENTES ELÉCTRICOS CAJA SELLADA
5 372721J2	1 NR	SCATOLA COMPONENTI ELETTRICI SALDATA	ELECTRICAL COMPONENTS SEALED BOX	COMPOSANTS ÉLECTRIQUES BOÎTE SCELLÉE	ELEKTROKOMPO NENTEN SEALED BOX	COMPONENTES ELÉCTRICOS CAJA SELLADA
6 264593H2	1 NR	RALLA	FIFTH WHEEL	COURONNE DENTÉE	DREHKRANZ	TEJUELO
7 372514H2	1 NR	ASSIEME BASE SALDATA	BASE WELDED ASSEMBLY	BASE SOUDÉS ENSEMBLE	BASE ZUSAMMENGESC HWEISST	BASE SOLDADAS ENTRE SÍ





 BASE TORRETTA
ARBEITSTURM 
 TURRET BASE
BASE TORRETA GIRATORIA 
 BASE TOURELLE

POS Codice	Q.tà	 Descrizione	 Description	 Designation	 Benennung	 Descripción
8 372772H2	1 NR	PROTEZIONE DISTRIBUTORI BASE SALDATA	WELDED COVER FOR GROUND HYDRAULIC DISTRIBUTOR	GUARD BASE SOUDÉE DISTRIBUTEURS	GUARD BASE GESCHWEISSTE DISTRIBUTEURS	GUARDIA BASE SOLDADA DISTRIBUIDORES
8 372772J0	1 NR	PROTEZIONE DISTRIBUTORI BASE SALDATA	WELDED COVER FOR GROUND HYDRAULIC DISTRIBUTOR	GUARD BASE SOUDÉE DISTRIBUTEURS	GUARD BASE GESCHWEISSTE DISTRIBUTEURS	GUARDIA BASE SOLDADA DISTRIBUIDORES
8 372772J2	1 NR	PROTEZIONE DISTRIBUTORI BASE SALDATA	WELDED COVER FOR GROUND HYDRAULIC DISTRIBUTOR	GUARD BASE SOUDÉE DISTRIBUTEURS	GUARD BASE GESCHWEISSTE DISTRIBUTEURS	GUARDIA BASE SOLDADA DISTRIBUIDORES
9 072699H1	1 NR	SUPPORTO	SUPPORT	SOUTIEN	SUPPORT	APOYO
9 072699J0	1 NR	SUPPORTO	SUPPORT	SOUTIEN	SUPPORT	APOYO
9 072699J2	1 NR	SUPPORTO	SUPPORT	SOUTIEN	SUPPORT	APOYO
10 061187Y1	1 NR	PIASTRA	PLATE	PLAQUE	PLATTE	PLACA
11 061185Y1	1 NR	LAMIERA PIEGATA	FOLDED PLATE	TÔLE PLIÉE	BLECH GEBOGEN	CHAPA DOBLADA

 BASE TORRETTA
ARBEITSTURM 
 TURRET BASE
BASE TORRETTA GIRATORIA 
 BASE TOURELLE





POS Codice	Q.tà	 Descrizione	 Description	 Designation	 Benennung	 Descripción
12 372691H1	1 NR	SUPPORTO MOTORE BENZINA	PETROL ENGINE SUPPORT	ESSENCE SUPPORT MOTEUR	BENZINMOTOR SUPPORT	MOTOR DE GASOLINA DE APOYO
12 372691J0	2 NR	SUPPORTO MOTORE BENZINA	PETROL ENGINE SUPPORT	ESSENCE SUPPORT MOTEUR	BENZINMOTOR SUPPORT	MOTOR DE GASOLINA DE APOYO
12 372691J0	1 NR	SUPPORTO MOTORE BENZINA	PETROL ENGINE SUPPORT	ESSENCE SUPPORT MOTEUR	BENZINMOTOR SUPPORT	MOTOR DE GASOLINA DE APOYO
12 372691J2	1 NR	SUPPORTO MOTORE BENZINA	PETROL ENGINE SUPPORT	ESSENCE SUPPORT MOTEUR	BENZINMOTOR SUPPORT	MOTOR DE GASOLINA DE APOYO
12 372691J2	2 NR	SUPPORTO MOTORE BENZINA	PETROL ENGINE SUPPORT	ESSENCE SUPPORT MOTEUR	BENZINMOTOR SUPPORT	MOTOR DE GASOLINA DE APOYO
13 07131600	4 NR	SPINA	PIN	CHEVILLE	STIF	CLAVIJA
14 17252700	4 NR	STABILIZZATORE COMPLETO	COMPLETE STABILIZER	STABILISATEUR COMPLET	STABILIZER KOMPLETT	ESTABILIZADOR COMPLETO
14 172527J0	4 NR	STABILIZZATORE COMPLETO	COMPLETE STABILIZER	STABILISATEUR COMPLET	STABILIZER KOMPLETT	ESTABILIZADOR COMPLETO
14 176835J2	4 NR	STABILIZZATORE COMPLETO MK2 (FROM C170000893)	COMPLETE STABILIZER MK2 (FROM C170000893)	STABILISATEUR COMPLET MK2 (FROM C170000893)	STABILIZER KOMPLETT MK2 (FROM C170000893)	ESTABILIZADOR COMPLETO MK2 (FROM C170000893)

 BASE TORRETTA
ARBEITSTURM 
 TURRET BASE
BASE TORRETA GIRATORIA 
 BASE TOURELLE





POS Codice	Q.tà	 Descrizione	 Description	 Designation	 Benennung	 Descripcìon
15 06586200	2 NR	BOCCOLA	BUSH	DOUILLE	BUCHSE	CASQUILLO
16 05876400	4 NR	ANTIVIBRANTE	ANTI-VIBRATING	ANTI - VIBRANT	VIBRATIONSDÄM PFER	ANTIVIBRANTE
17 07270400	4 NR	SPINA	PIN	CHEVILLE	STIF	CLAVIJA
18 05446300	4 NR	DISCO	DISK	DISQUE	SCHEIBE	DISCO
19 073147Y1	8 NR	SEMIFLANGIA	HALF FLANGE	DEMI-BRIDE	HALB FLANSCH	SEMI BRIDA
20 06891000	1 NR	STAFFA	BRACKET	ÉTRIER	HALTEBÜGEL	ESTRIBO
20 076966H3	1 NR	CARTER PROTEZIONE CENTRALINO MK2 (DA C170000893)	CARTER PROTECTION SWITCHBOARD MK2 (FROM C170000893)			
21 37270200	4 NR	SUPPORTO SPIA STABILIZZATORE	LIGHT STABILIZER SUPPORT	LUMIÈRE DE SOUTIEN DE STABILISATION	LICHTSCHUTZMIT TEL SUPPORT	LUZ DE SOPORTE ESTABILIZADOR
21 376018H2	4 NR	SUPPORTO SPIA STABILIZZATORE (FOR LL2010-X20JP-X6 00AJ MK2 FROM C170000893)	OUTRIGGER LIGHT SUPPORT (FOR LL2010-X20JP-X6 00AJ MK2 FROM C170000893)	SUPPORT LUMIÈRE STABILISATEUR (FOR LL2010-X20JP-X6 00AJ MK2 FROM C170000893)	LICHTHALTERUN G (FOR LL2010-X20JP-X6 00AJ MK2 FROM C170000893)	SOPORTE LUZ (FOR LL2010-X20JP-X6 00AJ MK2 FROM C170000893)







 BASE TORRETTA
ARBEITSTURM 
 TURRET BASE
BASE TORRETTA GIRATORIA 
 BASE TOURELLE

POS Codice	Q.tà	 Descrizione	 Description	 Designation	 Benennung	 Descripción
22 07495600	0,28 NR	GOMMA ADESIVA DI PROTEZIONE	RUBBER ADHESIVE PROTECTION	GOMME ADHESIVE DE PROTECTION	SCHUTZ-KLEBEG UMMI	GOMA ADHESIVA DE PROTECCIÓN
23 261308H2	1 NR	MOTORE DI ROTAZIONE	ROTARY MOTOR	MOTEUR DE ROTATION	ROTATIONSMOTO R	MOTOR DE ROTACIÓN
23 275993H2	1 NR	MOTORE DI ROTAZIONE MK2 (DA C170000893)	ROTARY MOTOR MK2 (FROM C170000893)	MOTEUR DE ROTATION MK2 (FROM C170000893)	ROTATIONSMOTO R MK2 (FROM C170000893)	MOTOR DE ROTACIÓN MK2 (FROM C170000893)
24 072700H2	4 NR	CARTER DI PROTEZIONE	PROTECTION COVER	CARTER DE PROTECTION	CARTER VON SCHUTZ	CARTER DE PROTECCIÓN
25 372843H1	1 NR	SUPPORTO MOTORE DIESEL	DIESEL ENGINE SUPPORT	DIESEL SUPPORT MOTEUR	DIESEL MOTOR SUPPORT	MOTOR DIESEL DE APOYO
25 372843J0	1 NR	SUPPORTO MOTORE DIESEL	DIESEL ENGINE SUPPORT	DIESEL SUPPORT MOTEUR	DIESEL MOTOR SUPPORT	MOTOR DIESEL DE APOYO
25 372843J2	1 NR	SUPPORTO MOTORE DIESEL	DIESEL ENGINE SUPPORT	DIESEL SUPPORT MOTEUR	DIESEL MOTOR SUPPORT	MOTOR DIESEL DE APOYO
26 055629H3	1 NR	STAFFA	BRACKET	ÉTRIER	HALTEBÜGEL	ESTRIBO
27 07141100	1 NR	COPERCHIO FILTRO ARIA MOTORE HONDA	AIR FILTER COVER HONDA MOTOR	COUVERCLE	DECKEL	TAPA





 BASE TORRETTA
ARBEITSTURM 
 TURRET BASE
BASE TORRETA GIRATORIA 
 BASE TOURELLE

POS Codice	Q.tà	 Descrizione	 Description	 Designation	 Benennung	 Descripció
28 172776J0	1 NR	ASSIEME PROTEZIONE MOTORE BENZINA COMPLETA	ASSEMBLY PETROL ENGINE COMPLETE PROTECTION	PROTECTION MOTEUR ESSENCE COMPLET	BENZINMOTOR VOLLSTÄNDIGEN SCHUTZ	MOTOR DE GASOLINA DE PROTECCIÓN COMPLETA
28 172776J2	1 NR	ASSIEME PROTEZIONE MOTORE BENZINA COMPLETA	ASSEMBLY PETROL ENGINE COMPLETE PROTECTION	PROTECTION MOTEUR ESSENCE COMPLET	BENZINMOTOR VOLLSTÄNDIGEN SCHUTZ	MOTOR DE GASOLINA DE PROTECCIÓN COMPLETA
29 065511Y1	1 NR	FERMO	RETAINER	ARRÊT	HALTERUNG	BLOQUE
30 072786Y1	1 NR	ANELLO DI RISCONTRO PER SENSORE ROTAZIONE	RING FEEDBACK SENSOR FOR ROTATION	RING SONDE DE JAUGE POUR LA ROTATION	RING-SENSOR FÜR DIE DREHUNG	ANILLO SENSOR DE CALIBRE DE ROTACIÓN
31 072839H3	1 NR	CARTER	COVER	PLAT	FLAT	CARTER
32 06958700	1 NR	PIEGATO FISSAGGIO SPINA ELETTRICA 16A	FIXING FOLDED ELECTRIC PLUG 16A	TÔLE PLIÉE	BLECH GEBOGEN	CHAPA DOBLADA
33 072282H1	1 NR	COPERCHIO	COVER	COUVERCLE	DECKEL	TAPA
33 072282J0	1 NR	COPERCHIO	COVER	COUVERCLE	DECKEL	TAPA
33 072282J2	1 NR	COPERCHIO	COVER	COUVERCLE	DECKEL	TAPA





 BASE TORRETTA
ARBEITSTURM 
 TURRET BASE
BASE TORRETTA GIRATORIA 
 BASE TOURELLE

POS Codice	Q.tà	 Descrizione	 Description	 Designation	 Benennung	 Descripción
34 07178700	4 NR	CERNIERA CON CONTROLLO DELLA POSIZIONE	HINGES WITH POSITION CONTROL	CHARNIÈRE	SCHARNIER	BISAGRA
34 07189900	1 NR	CERNIERA A OSCILLAZIONE LIBERA	HINGE SWING FREE	CHARNIÈRE	SCHARNIER	BISAGRA
35 073505H2	2 NR	PIEGATO SPESSORE VANO FORCHE	BENT FORKS SHAFT THICKNESS			
36 072690J2	1 NR	COPERCHIO	COVER	COUVERTURE	DECKEL	CUBIERTA
37 072703H2	4 NR	CARTER DI PROTEZIONE	PROTECTION COVER	CARTER DE PROTECTION	CARTER VON SCHUTZ	CARTER DE PROTECCIÓN
38 372846H1	1 NR	COPERCHIO RADIATORE MOTORE DIESEL	DIESEL ENGINE RADIATOR COVER	BOUCHON DE RADIATEUR MOTEUR DIESEL	KÜHLERVERSCH LUSS DIESEL MOTOR	RADIADOR CAP MOTOR DIESEL
38 372846J0	1 NR	COPERCHIO RADIATORE MOTORE DIESEL	DIESEL ENGINE RADIATOR COVER	BOUCHON DE RADIATEUR MOTEUR DIESEL	KÜHLERVERSCH LUSS DIESEL MOTOR	RADIADOR CAP MOTOR DIESEL
38 372846J2	1 NR	COPERCHIO RADIATORE MOTORE DIESEL	DIESEL ENGINE RADIATOR COVER	BOUCHON DE RADIATEUR MOTEUR DIESEL	KÜHLERVERSCH LUSS DIESEL MOTOR	RADIADOR CAP MOTOR DIESEL

 BASE TORRETTA
ARBEITSTURM 
 TURRET BASE
BASE TORRETA GIRATORIA 
 BASE TOURELLE

POS Codice	Q.tà	 Descrizione	 Description	 Designation	 Benennung	 Descripción
39 372845H1	1 NR	PROTEZIONE RIMOVIBILE MOTORE DIESEL	REMOVABLE PROTECTION DIESEL ENGINE	AMOVIBLE PROTECTION MOTEUR DIESEL	REMOVABLE SCHUTZ DIESEL MOTOR	PROTECCIÓN DESMONTABLE MOTOR DIESEL
39 372845J0	1 NR	PROTEZIONE RIMOVIBILE MOTORE DIESEL	REMOVABLE PROTECTION DIESEL ENGINE	AMOVIBLE PROTECTION MOTEUR DIESEL	REMOVABLE SCHUTZ DIESEL MOTOR	PROTECCIÓN DESMONTABLE MOTOR DIESEL
39 372845J2	1 NR	PROTEZIONE RIMOVIBILE MOTORE DIESEL	REMOVABLE PROTECTION DIESEL ENGINE	AMOVIBLE PROTECTION MOTEUR DIESEL	REMOVABLE SCHUTZ DIESEL MOTOR	PROTECCIÓN DESMONTABLE MOTOR DIESEL
40 058537D2	1 NR	INDICE ALLINEAMENTO	ALIGNMENT INDICATOR	INDICATEUR D'ALIGNEMENT	AUSRICHTUNGS- ANZEIGE	INDICADOR ALINEACIÓN
41 04834500	1 NR	AVVISATORE ACQUSTICO	ACOUSTIC ALARM	BUZZER	SUMMER	ZUMBADOR
42 06550100	1 NR	VITE M16X20 TESTA RIBASSATA	REDUCED HEAD SCREW M16X20	BAISSE VIS À TÊTE M16X20	GESENKTEN KOPF SCREW M16X20	BAJADO TORNILLO CABEZA M16X20
43 372844H1	1 NR	PROTEZIONE FISSA MOTORE DIESEL	DIESEL ENGINE PROTECTION	DIESEL PROTECTION MOTEUR FIXE	DIESEL MOTOR SCHUTZ FIXED	PROTECCIÓN DEL MOTOR DIESEL FIJO
43 372844J0	1 NR	PROTEZIONE FISSA MOTORE DIESEL	DIESEL ENGINE PROTECTION	DIESEL PROTECTION MOTEUR FIXE	DIESEL MOTOR SCHUTZ FIXED	PROTECCIÓN DEL MOTOR DIESEL FIJO
43 372844J2	1 NR	PROTEZIONE FISSA MOTORE DIESEL	DIESEL ENGINE PROTECTION	DIESEL PROTECTION MOTEUR FIXE	DIESEL MOTOR SCHUTZ FIXED	PROTECCIÓN DEL MOTOR DIESEL FIJO

 BASE TORRETTA
ARBEITSTURM 
 TURRET BASE
BASE TORRETTA GIRATORIA 
 BASE TOURELLE

POS Codice	Q.tà	 Descrizione	 Description	 Designation	 Benennung	 Descripción
44 05442500	2 NR	RISCONTRO	FASTENER LOCATOR	PLAQUE POUR AGRAFAGE	ANSCHLAG	GANCHO
45 05442600	2 NR	CHIUSURA A GANCIO	HOOK FASTENING	FERMETURE À CROCHET	HAKENVERSCHL USS	GANCHO DE CIERRE
46 173126H3	1 NR	SERBATOIO GASOLIO	DIESEL TANK	RÉSERVOIR DE GASOIL	DIESELTANK	DEPÓSITO DE GASÓLEO
46 173126J0	1 NR	SERBATOIO GASOLIO	DIESEL TANK	RÉSERVOIR DE GASOIL	DIESELTANK	DEPÓSITO DE GASÓLEO
47 25731300	1 NR	TAPPO	CAP	BOUCHON	VERSCHLUSS	TAPÓN
48 07313100	1 NR	LIVELLO GASOLIO	GAS OIL LEVEL	NIVEAU GASOIL	KRAFTSTOFFSTA ND	NIVEL GASÓLEO
49 05656400	2 NR	CHIAVE TAPPO DIESEL	KEY DIESEL CAP	CLÉ	SCHLÜSSEL	LLAVE

 SERBATOIO OLIO

ÖLTANK 

 OIL TANK

DEPÓSITO DE ACEITE 

 RÉSERVOIR D'HUILE

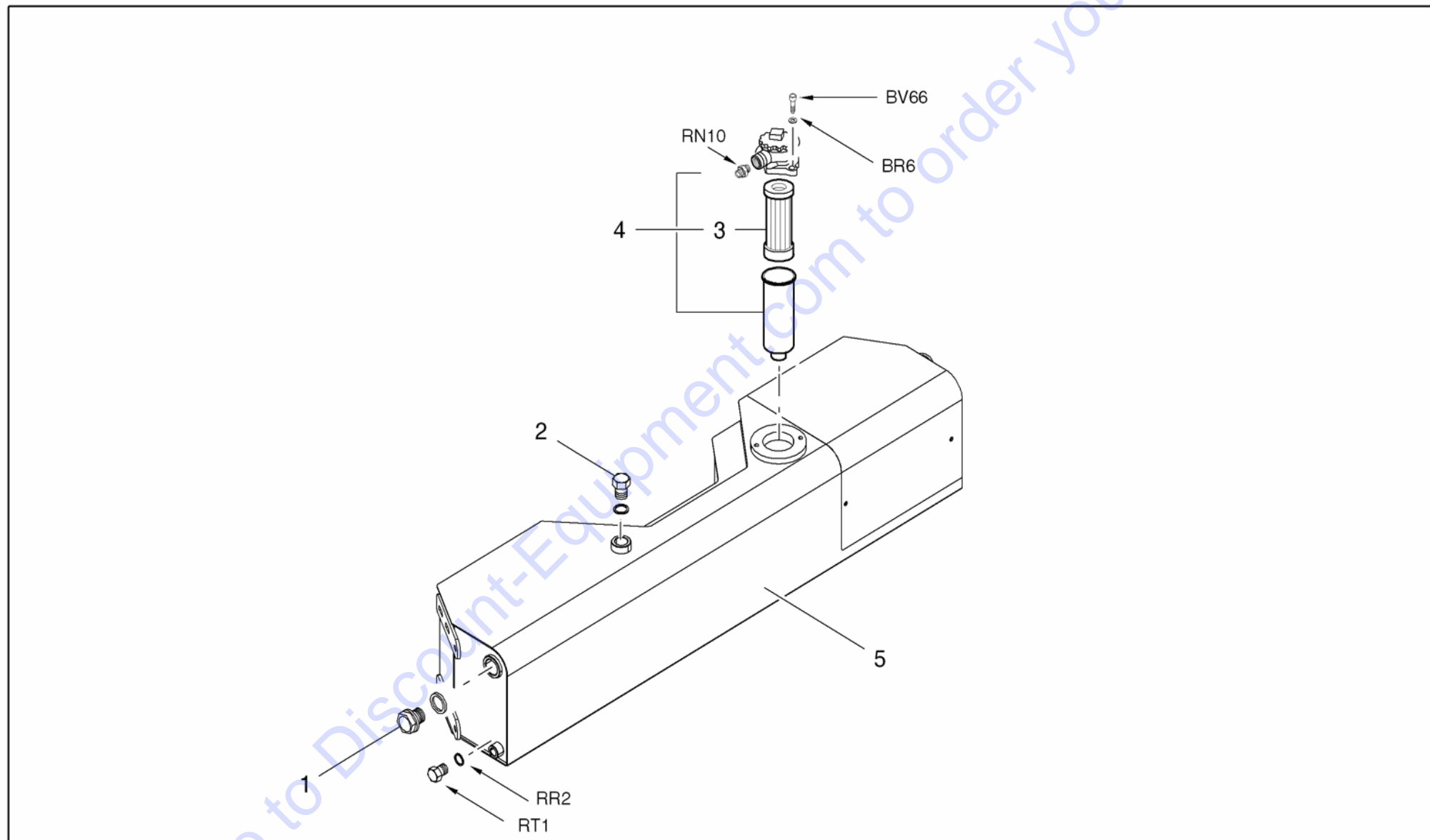





 SERBATOIO OLIO

 ÖLTANK

 OIL TANK

 DEPÓSITO DE ACEITE

 RÉSERVOIR D'HUILE

POS Codice	Q.tà	 Descrizione	 Description	 Designation	 Benennung	 Descripción
1 05061800	1 NR	LIVELLO OLIO	OIL LEVEL	NIVEAU HUILE	ÖLSTAND	NIVEL ACEITE
2 05611800	1 NR	TAPPO OLIO	OIL PLUG	BOUCHON D'HUILE	ÖLDECKEL	TAPÓN ACEITE
3 05120200	1 NR	CARTUCCIA FILTRO OLIO IDRAULICO	OIL FILTER INSERT	CARTOUCHE FILTRE À HUILE	ÖLFILTEREINSAT Z	CARTUCHO FILTRO ACEITE
4 15120100	1 NR	FILTRO OLIO IDRAULICO COMPLETO	COMPLETE HYDRAULIC OIL FILTER	FILTRE À HUILE	HYDARULIKÖLFIL TER	FILTRO ACEITE HIDRÁULICO
5 172661H1	1 NR	SERBATOIO OLIO COMPLETO	OIL TANK COMPLETE	HUILE COMPLETE	OIL TANK COMPLETE	ACEITE COMPLETA
5 172661J0	1 NR	SERBATOIO OLIO COMPLETO LL2010	OIL TANK COMPLETE	HUILE COMPLETE	OIL TANK COMPLETE	ACEITE COMPLETA
5 172661J2	1 NR	SERBATOIO OLIO COMPLETO LL2010	OIL TANK COMPLETE	HUILE COMPLETE	OIL TANK COMPLETE	ACEITE COMPLETA

 PRIMO BRACCIO

ERSTER AUSLEGERARM 

 FIRST ARM

PRIMO BRAZO 

 PREMIER BRAS

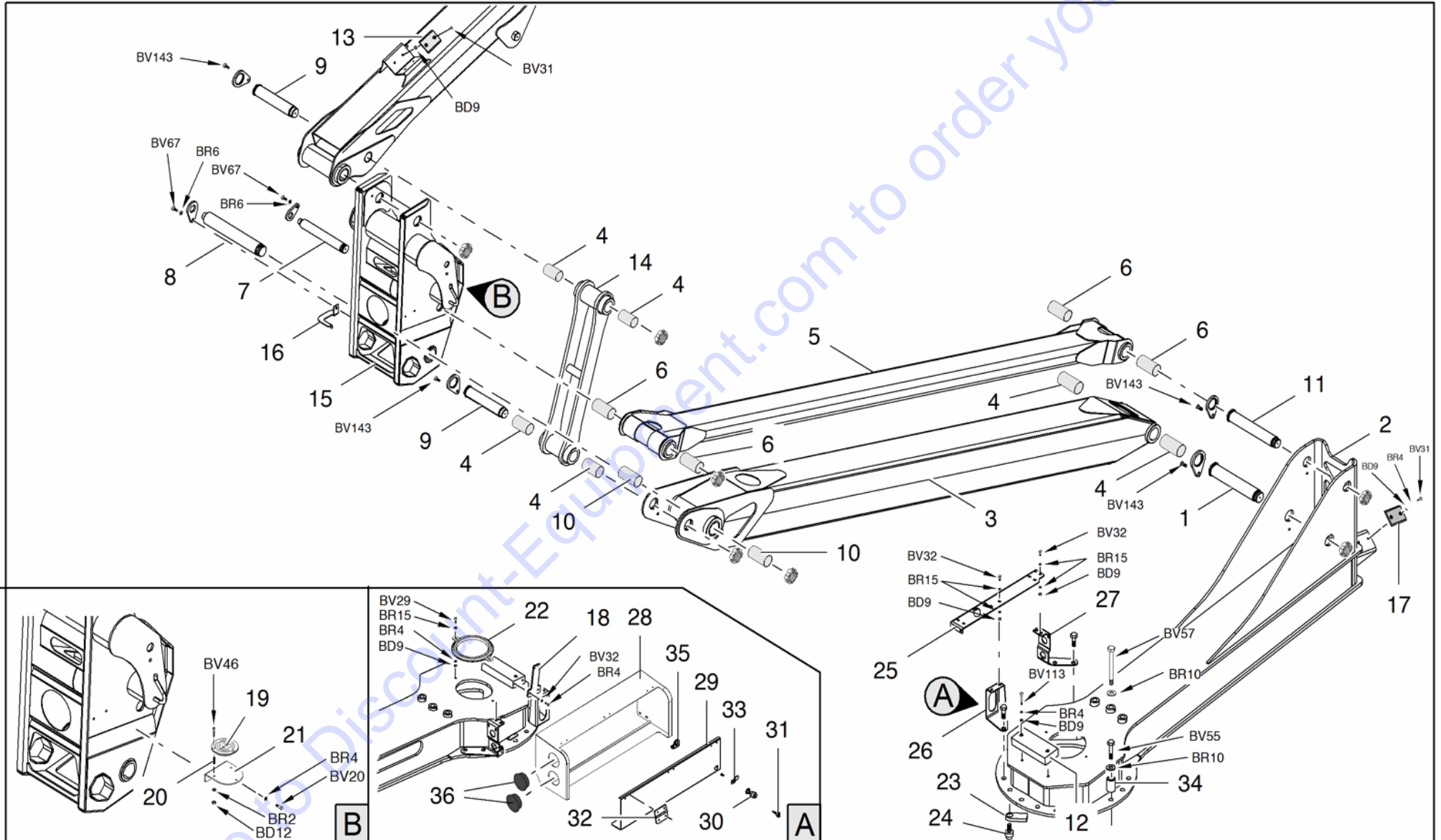







 PRIMO BRACCIO

 ERSTER AUSLEGERARM





 FIRST ARM

 PRIMO BRAZO





 PREMIER BRAS

POS Codice	Q.tà	 Descrizione	 Description	 Designation	 Benennung	 Descripción
1 07270500	1 NR	SPINA	PIN	CHEVILLE	STIF	CLAVIJA
2 372623H1	1 NR	SUPPORTO BRACCI	SUPPORT MAIN BOOM	BRAS DE SOUTIEN	TRAGARME	LOS BRAZOS DE SOPORTE
2 372623J0	1 NR	SUPPORTO BRACCI	SUPPORT MAIN BOOM	BRAS DE SOUTIEN	TRAGARME	LOS BRAZOS DE SOPORTE
2 372623J1	1 NR	SUPPORTO BRACCI	SUPPORT MAIN BOOM	BRAS DE SOUTIEN	TRAGARME	LOS BRAZOS DE SOPORTE
3 172613H1	1 NR	PRIMO BRACCIO	FIRST ARM	PREMIER BRAS	ERSTER AUSLEGERARM	PRIMO BRAZO
3 172613J0	1 NR	PRIMO BRACCIO	FIRST ARM	PREMIER BRAS	ERSTER AUSLEGERARM	PRIMO BRAZO
3 172613J1	1 NR	PRIMO BRACCIO	FIRST ARM	PREMIER BRAS	ERSTER AUSLEGERARM	PRIMO BRAZO
4 07256800	2 NR	BOCCOLA	BUSH	DOUILLE	BUCHSE	CASQUILLO
4 07256800	4 NR	BOCCOLA	BUSH	DOUILLE	BUCHSE	CASQUILLO
5 172635H1	1 NR	TIRANTE PRIMO BRACCIO	FIRST ARM TIE ROD	TIRANT	TURMGESTÄNGE	TIRANTE
5 172635J0	1 NR	TIRANTE	TIE ROD	TIRANT	TURMGESTÄNGE	TIRANTE
5 172635J1	1 NR	TIRANTE PRIMO BRACCIO	FIRST ARM TIE ROD	TIRANT	TURMGESTÄNGE	TIRANTE
6 06434200	4 NR	BOCCOLA	BUSH	DOUILLE	BUCHSE	CASQUILLO





 PRIMO BRACCIO
ERSTER AUSLEGERARM 
 FIRST ARM
PRIMO BRAZO 
 PREMIER BRAS

POS Codice	Q.tà	 Descrizione	 Description	 Designation	 Benennung	 Descripcìon
7 07271000	1 NR	SPINA	PIN	CHEVILLE	STIF	CLAVIJA
8 07270900	1 NR	SPINA	PIN	CHEVILLE	STIF	CLAVIJA
9 07271400	2 NR	SPINA	PIN	CHEVILLE	STIF	CLAVIJA
9 07271400	1 NR	SPINA	PIN	CHEVILLE	STIF	CLAVIJA
10 07262200	2 NR	BOCCOLA	BUSH	DOUILLE	BUCHSE	CASQUILLO
11 07270600	1 NR	SPINA	PIN	CHEVILLE	STIF	CLAVIJA
12 07314000	1 NR	TAMPONE APPOGGIO PRIMO BRACCIO	BUFFER SUPPORT FIRST ARM	TAMPON DE SUPPORT PREMIER BRAS	PUFFER ARMHALTERUNG	TAMPÓN PRIMER BRAZO
13 07314500	2 NR	TAMPONE APPOGGIO TERZO BRACCIO	THIRD ARM PAD SUPPORT	TAMPON	PUFFER	TAMPÓN

 PRIMO BRACCIO
ERSTER AUSLEGERARM 
 FIRST ARM
PRIMO BRAZO 
 PREMIER BRAS

POS Codice	Q.tà	 Descrizione	 Description	 Designation	 Benennung	 Descripción
14 172632J1	1 NR	BIELLA PRIMO-SECONDO BRACCIO COMPLETA	TIEROD FIRST-SECOND BOOMS	ROD PREMIERS DEUXIÈME BRAS COMPLET	ROD ERSTE ZWEITE-VOLL ARM	BARRA DE PRIMER SEGUNDO BRAZO COMPLETO
14 172632H1	1 NR	BIELLA PRIMO-SECONDO BRACCIO COMPLETA	TIEROD FIRST-SECOND BOOMS	ROD PREMIERS DEUXIÈME BRAS COMPLET	ROD ERSTE ZWEITE-VOLL ARM	BARRA DE PRIMER SEGUNDO BRAZO COMPLETO
14 172632J0	1 NR	BIELLA PRIMO-SECONDO BRACCIO COMPLETA	TIEROD FIRST-SECOND BOOMS	TIGE PREMIER DEUXIEME BRAS REMPHIR	ROD ERSTE ZWEITE- ARM VOLL	BARRA PRIMERA SEGUNDA ARM COMPLETE
15 372569H1	1 NR	RINVIO 1°-2° BRACCIO	UPRIGHT 1ST-2ND BOOMS	REFERENCE 1 ° -2 ° ARM	REFERENCE 1 ° -2 ° ARM	REFERENCIA 1 ° -2 ° ARM
15 372569J0	1 NR	RINVIO 1°-2° BRACCIO	UPRIGHT 1ST-2ND BOOMS	REFERENCE 1 ° -2 ° ARM	REFERENCE 1 ° -2 ° ARM	REFERENCIA 1 ° -2 ° ARM
15 372569J1	1 NR	RINVIO 1°-2° BRACCIO	UPRIGHT 1ST-2ND BOOMS	REFERENCE 1 ° -2 ° ARM	REFERENCE 1 ° -2 ° ARM	REFERENCIA 1 ° -2 ° ARM
16 073000D2	1 NR	INDICATORE DI ALLINEAMENTO MOBILE	MOVABLE ALIGNMENT INDICATOR	AFFICHAGE DE L'ALIGNEMENT DE LA TELEPHONE MOBILE	ALIGNMENT INDIKATOR MOBILE	ALINEACIÓN DE INDICADOR DE MÓVIL
17 05849000	2 NR	PATTINO	SLIDE BLOCK	PATIN	GLEITBLOCK	PATÍN

 PRIMO BRACCIO
ERSTER AUSLEGERARM 
 FIRST ARM
PRIMO BRAZO 
 PREMIER BRAS

POS Codice	Q.tà	 Descrizione	 Description	 Designation	 Benennung	 Descripción
18 073141H3	1 NR	STAFFA FISSAGGIO MICROINTERRUTT ORE	BRACKET MICROSWITCH	MICRO SUPPORT DE L'INTERRUPTEUR	MICRO SWITCH BRACKET	SOPORTE FIJACIÓN MICRO
19 05427200	1 NR	LIVELLA	LEVEL	NIVEAU	WASSERWAAGE	NIVEL DE BURBUJA
20 05444800	3 NR	MOLLA	SPRING	RESSORT	FEDER	MUELLE
21 058832H3	1 NR	SUPPORTO	SUPPORT	SUPPORT	HALTERUNG	SOPORTE
22 069590H3	1 NR	PROTEZIONE	PROTECTION	PROTECTION	SCHUTZ	PROTECCIÓN
23 064422Y1	1 NR	FERMO	RETAINER	ARRÊT	HALTEVORRICHT UNG	BLOQUE
24 064423Y1	1 NR	PERNO	PIN	GOUJON	ZAPFEN	PERNIO
25 072773H3	1 NR	SUPPORTO (FOR LL1775-X17JP-X5 00AJ MK2 FROM C170000893)	SUPPORT (FOR LL1775-X17JP-X5 00AJ MK2 FROM C170000893)	SOUTIEN (FOR LL1775-X17JP-X5 00AJ MK2 FROM C170000893)	SUPPORT (FOR LL1775-X17JP-X5 00AJ MK2 FROM C170000893)	APOYO (FOR LL1775-X17JP-X5 00AJ MK2 FROM C170000893)





 PRIMO BRACCIO

 ERSTER AUSLEGERARM





 FIRST ARM

 PRIMO BRAZO





 PREMIER BRAS

POS Codice	Q.tà	 Descrizione	 Description	 Designation	 Benennung	 Descripción
26 07277400	1 NR	STAFFA POSTERIORE SUPPORTO DISTRIBUTORE	REAR BRACKET MOUNT DISTRIBUTOR	ARRIÈRE SUPPORT DE MONTAGE DISTRIBUTEUR	REAR BRACKET MOUNT DISTRIBUTOR	REAR MOUNT BRACKET HÄNDLER
26 077096H3	1 NR	STAFFA POSTERIORE SUPPORTO DISTRIBUTORE LL2010 MK2 (FROM C170000893)	REAR SUPPORT BRACKET DISTRIBUTOR LL2010 MK2 (FROM C170000893)			
27 07277500	1 NR	STAFFA ANTERIORE SUPPORTO DISTRIBUTORE	FRONT BRACKET MOUNT DISTRIBUTOR	FRONT MOUNT SUPPORT DISTRIBUTEUR	FRONT MOUNT BRACKET HÄNDLER	FRONT MOUNT SOPORTE DISTRIBUIDOR
27 077097H3	1 NR					
28 373142H2	1 NR	CARTER DISTRIBUTORE BRACCI (FOR LL1775-X17JP-X5 00AJ MK2 FROM C170000893)	PROTECTION BOOM HYDRAULIC DISTRIBUTOR (FOR LL1775-X17JP-X5 00AJ MK2 FROM C170000893)	PROTECTION DISTRIBUTEUR (FOR LL1775-X17JP-X5 00AJ MK2 FROM C170000893)	SCHUTZ VENTILBLOCK (FOR LL1775-X17JP-X5 00AJ MK2 FROM C170000893)	PROTECCION DISTRIBUIDOR (FOR LL1775-X17JP-X5 00AJ MK2 FROM C170000893)

 PRIMO BRACCIO
ERSTER AUSLEGERARM 
 FIRST ARM
PRIMO BRAZO 
 PREMIER BRAS

POS Codice	Q.tà	 Descrizione	 Description	 Designation	 Benennung	 Descripción
29 073144H2	1 NR	COPERCHIO (FOR LL1775-X17JP-X5 00AJ MK2 FROM C170000893)	COVER (FOR LL1775-X17JP-X5 00AJ MK2 FROM C170000893)	COUVERTURE (FOR LL1775-X17JP-X5 00AJ MK2 FROM C170000893)	DECKUNG (FOR LL1775-X17JP-X5 00AJ MK2 FROM C170000893)	COBERTURA (FOR LL1775-X17JP-X5 00AJ MK2 FROM C170000893)
29 07505900	1 NR	COPERCHIO SENZA CHIAVE VERSIONE ANSI (FOR LL1775-X17JP-X5 00AJ MK2 FROM C170000893)	COVER WITHOUT KEY ANSI VERSION (FOR LL1775-X17JP-X5 00AJ MK2 FROM C170000893)	COUVERTURE (FOR LL1775-X17JP-X5 00AJ MK2 FROM C170000893)	COVER (FOR LL1775-X17JP-X5 00AJ MK2 FROM C170000893)	CUBIERTA (FOR LL1775-X17JP-X5 00AJ MK2 FROM C170000893)
29 075059H2	1 NR	COPERCHIO SENZA CHIAVE VERSIONE ANSI (FOR LL1775-X17JP-X5 00AJ MK2 FROM C170000893)	COVER WITHOUT KEY ANSI VERSION (FOR LL1775-X17JP-X5 00AJ MK2 FROM C170000893)	COUVERTURE SANS CLÉ (FOR LL1775-X17JP-X5 00AJ MK2 FROM C170000893)	DECKUNG OHNE SCHLÜSSEL (FOR LL1775-X17JP-X5 00AJ MK2 FROM C170000893)	COBERTURA SIN LLAVE (FOR LL1775-X17JP-X5 00AJ MK2 FROM C170000893)
30 07178800	1 NR	SERRATURA	LOCK	SERRURE	SCHLOSS	CERRADURA
31 07298800	1 NR	CHIAVE PER SERRATURA POSTAZIONE COMANDO A TERRA	KEY TO THE LOCK ON THE GROUND CONTROL POSITION	CLÉ	SCHLÜSSEL	LLAVE

 PRIMO BRACCIO
ERSTER AUSLEGERARM 
 FIRST ARM
PRIMO BRAZO 
 PREMIER BRAS

POS Codice	Q.tà	 Descrizione	 Description	 Designation	 Benennung	 Descripcìon
32 07178700	3 NR	CERNIERA CON CONTROLLO DELLA POSIZIONE	HINGES WITH POSITION CONTROL	CHARNIÈRE	SCHARNIER	BISAGRA
33 07178900	1 NR	CAMMA PER SERRATURA DISASSAMENTO 3.2	CAM LOCK FOR OFFSET 3.2	CAME	NOCKEN	LEVA
34 06551600	20 NR	PINZA	PLIERS	PINCE	KLEMME	PINZA
35 073138Y1	1 NR	SUPPORTO SERRATURA	LOCK SUPPORT	SUPPORT SERRURE	SCHLOSSHALTE RUNG	SOPORTE CERRADURA
36 06838700	2 NR	TAPPO	CAP	BOUCHON	VERSCHLUSS	TAPÓN

Go to Discount-Equipment.com to order your parts

 SECONDO BRACCIO

ZWEITER AUSLEGERARM 

 SECOND ARM

SEGUNDO BRAZO 

 SECOND BRAS

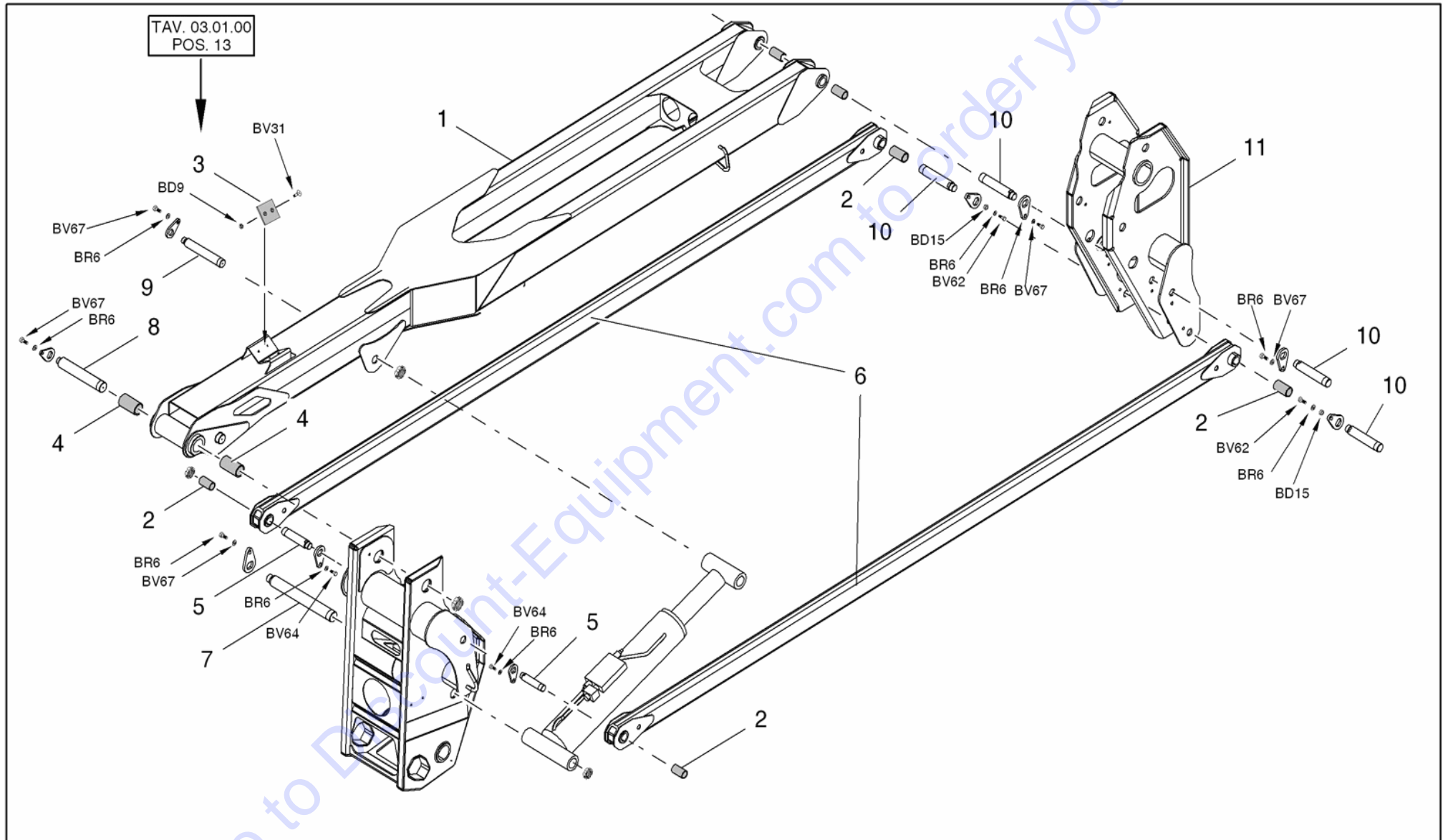













 SECONDO BRACCIO

 ZWEITER AUSLEGERARM 
 SECOND ARM

 SEGUNDO BRAZO 
 SECOND BRAS

POS	Codice	Q.tà	 Descrizione	 Description	 Designation	 Benennung	 Descripcìon
1	172545H1	1 NR	SECONDO BRACCIO COMPLETO	SECOND BOOM	ARM DEUXIÈME COMPLETE	ARM COMPLETE SECOND	ARM SEGUNDO COMPLETO
1	172545J0	1 NR	SECONDO BRACCIO COMPLETO	SECOND BOOM	ARM DEUXIÈME COMPLETE	GEMÄß ARM AUSVERKAUFT	SEGÚN BRAZO COMPLETAR
1	172545J1	1 NR	SECONDO BRACCIO COMPLETO	SECOND BOOM	ARM DEUXIÈME COMPLETE	ARM COMPLETE SECOND	ARM SEGUNDO COMPLETO
2	06326300	1 NR	BOCCOLA	BUSH	DOUILLE	BUCHSE	CASQUILLO
2	06326300	4 NR	BOCCOLA	BUSH	DOUILLE	BUCHSE	CASQUILLO
4	06422100	2 NR	BOCCOLA	BUSH	DOUILLE	LUFTÖFFNUNG	BOQUILLA AIRE
5	07271200	2 NR	SPINA	PIN	CHEVILLE	STIF	CLAVIJA

 SECONDO BRACCIO
ZWEITER AUSLEGERARM 
 SECOND ARM
SEGUNDO BRAZO 
 SECOND BRAS

POS Codice	Q.tà	 Descrizione	 Description	 Designation	 Benennung	 Descripción
6 172656H1	2 NR	TIRANTE SECONDO BRACCIO COMPLETO	TIE ROD SECOND BOOM	TIE DEUXIÈME ARM SOLD OUT	TIE ZWEITE ARM AUSVERKAUFT	TIE SEGUNDO ARM TERMINADO
6 172656J0	2 NR	TIRANTE SECONDO BRACCIO COMPLETO	TIE ROD SECOND BOOM	TIE DEUXIÈME ARM SOLD OUT	TIE ZWEITE ARM AUSVERKAUFT	TIE SEGUNDO ARM TERMINADO
6 172656J1	2 NR	TIRANTE SECONDO BRACCIO COMPLETO	TIE ROD SECOND BOOM	TIE DEUXIÈME ARM SOLD OUT	TIE ZWEITE ARM AUSVERKAUFT	TIE SEGUNDO ARM TERMINADO
7 07271100	1 NR	SPINA	PIN	CHEVILLE	STIF	CLAVIJA
8 07271300	1 NR	SPINA	PIN	CHEVILLE	STIF	CLAVIJA
9 07271500	1 NR	SPINA	PIN	CHEVILLE	STIF	CLAVIJA
10 07271600	4 NR	SPINA	PIN	CHEVILLE	STIF	CLAVIJA
11 372515H1	1 NR	RINVIO 2°-3° BRACCIO	UPRIGHT 2ND-3RD BOOMS	REFERENCE 2 ° -3 ° ARM	REFERENZ 2 ° -3 ° ARM	REFERENCIA 2 ° -3 ° ARM
11 372515J0	1 NR	RINVIO 2°-3° BRACCIO	UPRIGHT 2ND-3RD BOOMS	REFERENCE 2 ° -3 ° ARM	REFERENZ 2 ° -3 ° ARM	REFERENCIA 2 ° -3 ° ARM
11 372515J1	1 NR	RINVIO 2°-3° BRACCIO	UPRIGHT 2ND-3RD BOOMS	REFERENCE 2 ° -3 ° ARM	REFERENZ 2 ° -3 ° ARM	REFERENCIA 2 ° -3 ° ARM

 TERZO BRACCIO

THIRD AUSLEGERARM 

 THIRD ARM

TERCERO BRAZO 



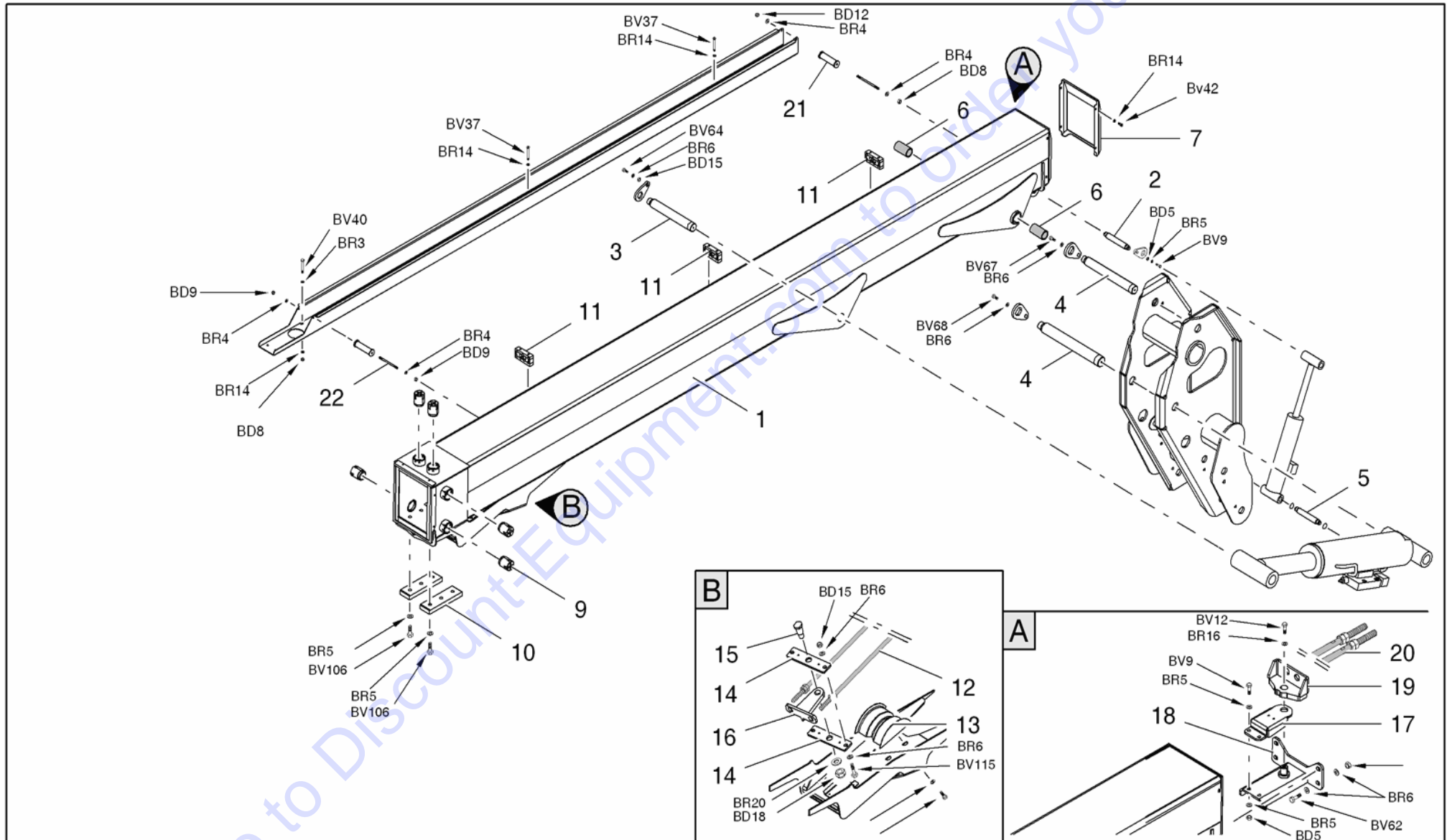

 TIERS BRAS



 TERZO BRACCIO

 THIRD AUSLEGERARM 
 THIRD ARM





 TERCERO BRAZO 
 TIERS BRAS

POS Codice	Q.tà	 Descrizione	 Description	 Designation	 Benennung	 Descripcìon
1 172275H1	1 NR	TERZO BRACCIO	THIRD ARM	TROISIÈME BRAS	DRITTER AUSLEGERARM	TERCER BRAZO
1 172275J0	1 NR	TERZO BRACCIO	THIRD ARM	TROISIÈME BRAS	DRITTER AUSLEGERARM	TERCER BRAZO
1 172275J1	1 NR	TERZO BRACCIO	THIRD ARM	TROISIÈME BRAS	DRITTER AUSLEGERARM	TERCER BRAZO
2 06230600	1 NR	SPINA	PIN	CHEVILLE	STIFT	CLAVIJA
3 07278800	1 NR	SPINA	PIN	CHEVILLE	STIF	CLAVIJA
4 07271700	2 NR	SPINA	PIN	CHEVILLE	STIF	CLAVIJA
5 06867600	1 NR	SPINA	PIN	CHEVILLE	STIFT	CLAVIJA
6 06422200	2 NR	BOCCOLA	BUSH	DOUILLE	BUCHSE	CASQUILLO
7 072481H3	1 NR	CARTER CHIUSURA TERZO BRACCIO	COVER THIRD ARM	COUVERTURE TROISIEME BRAS	COVER DRITTEN ARM	COBERTURA DO BRAÇO TERCEIRO
8 072472H3	1 NR	PIEGATO SUPPORTO CATENARIA	BENT SUPPORT	CHAINE SUPPORT	SUPPORT CHAIN	APOYO A LA CADENA
9 07246000	12 NR	PATTINO IN PLASTICA	SLIDE BLOCK	PATIN	GLEITBLOCK	PATIN
10 07246700	2 NR	PATTINO IN PLASTICA	SLIDE BLOCK	PATIN	GLEITELEMENT	PATIN

 TERZO BRACCIO

 THIRD AUSLEGERARM 
 THIRD ARM

 TERCERO BRAZO 
 TIERS BRAS

POS Codice	Q.tà	 Descrizione	 Description	 Designation	 Benennung	 Descripción
11 07284000	4 NR	MORSETTO FERMA TUBI	CLAMP	PIPE CLAMP ARRÊTS	BOHRROHRKLEM ME STOPPT	ABRAZADERA SE DETIENE
12 07247100	2 NR	FUNE RIENTRO SFILO	ROPE EXTENSION IN	CABLE EXTENSION DE SORTIE	KABELVERLÄNG ERUNG AUSGANG	CABLE DE EXTENSIÓN DE SALIDA
13 06306200	1 NR	SLITTA	SLIDE	COULISSEAU	SCHLITTEN	CORREDERA
14 066189Y1	2 NR	LAMA DI FISSAGGIO	FIXING BLADE	LAME DE FIXAGE	BEFESTIGUNGSS CHILD	LAMA FIJACIÓN
15 06619000	1 NR	PERNO	PIN	GOUJON	ZAPFEN	PERNIO
16 366192Y1	1 NR	PIATTO CONTENIMENTO FUNI	PLATE FOR CABLES	PLAQUE POUR CÂBLES	SEILHALTER	PLACA PARA CABLES
17 063061Y1	1 NR	SUPPORTO	SUPPORT	SUPPORT	HALTERUNG	SOPORTE
18 363078Y1	1 NR	SUPPORTO	SUPPORT	SUPPORT	HALTERUNG	SOPORTE
19 363074Y1	1 NR	BILANCERE	ROCKER ARM	BALANCIER	KIPPEBEL	BALANCÍN
20 07247000	2 NR	FUNE SFILO USCITA	ROPE FOR EXTENSION EXIT	CABLE EXTENSION DE SORTIE	CABLE EXTENSION OUTPUT	CABLE DE EXTENSIÓN DE SALIDA
21 06518800	2 NR	DISTANZIALE	SPACER	ENTRETOISE	DISTANZSTÜCK	DISTANCIADOR
22 06518900	3 NR	TIRANTE	TIE ROD	TIRANT	TURMGESTÄNGE	TIRANTE

 PRIMO SFILÒ

ERSTER TELESKOPARM 



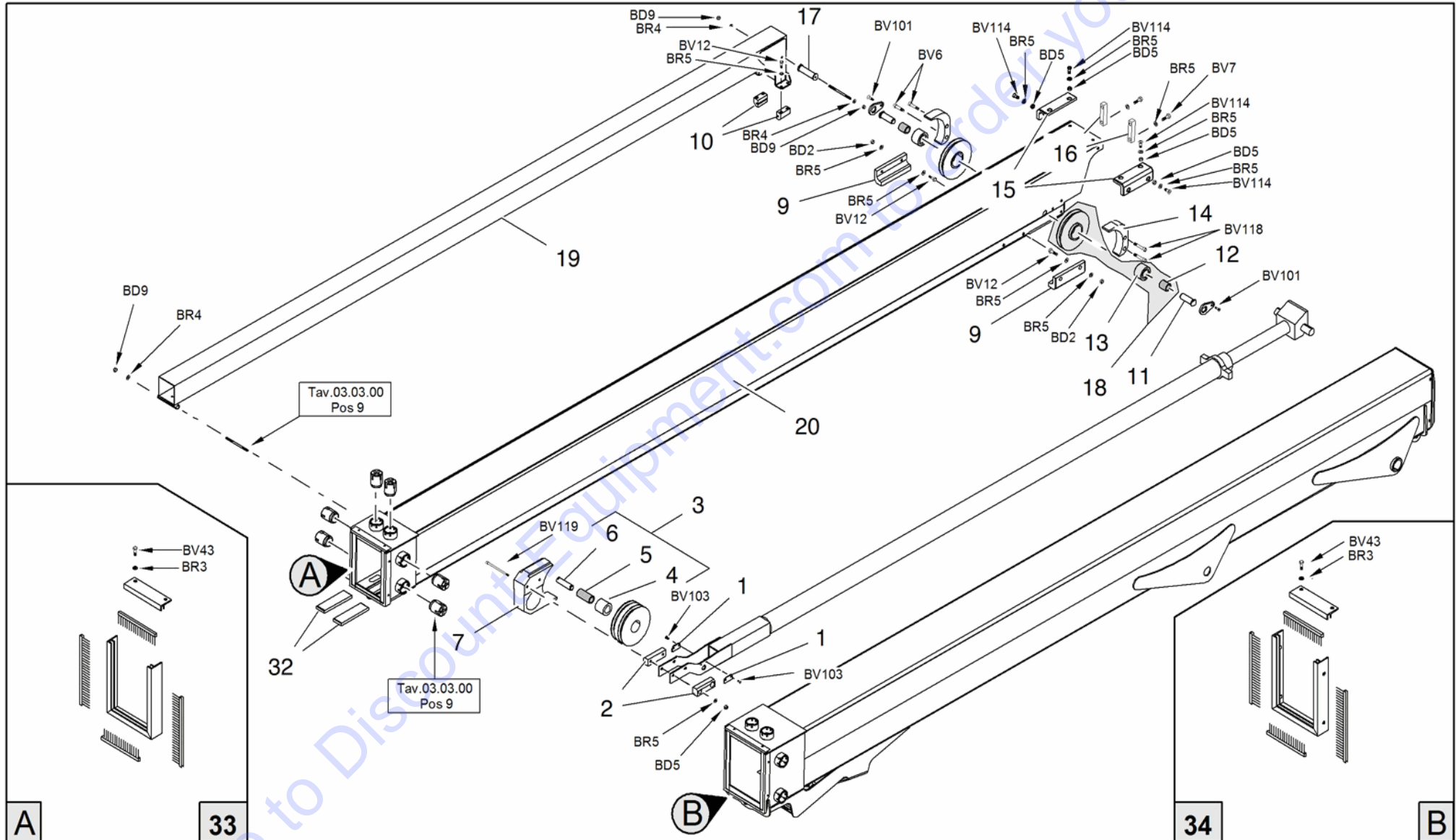

 FIRST EXTENSION ARM

PRIMO BRAZO DE EXTENSION 





 PREMIER BRAS D'EXTRACTION



 PRIMO SFILÒ
ERSTER TELESKOPARM 
 FIRST EXTENSION ARM
PRIMO BRAZO DE EXTENSION 
 PREMIER BRAS D'EXTRACTION

POS Codice	Q.tà	 Descrizione	 Description	 Designation	 Benennung	 Descripción
1 072787Y1	2 NR	PIATTO	PLATE	PLATEAU	PLATTE	PLACA
2 06308800	2 NR	PATTINO	SLIDE BLOCK	PATIN	GLEITBLOCK	PATÍN
3 16510800	1 NR	PULEGGIA	PULLEY	POULIE	SCHEIBE	POLEA
4 06321100	1 NR	BOCCOLA	BUSH	DOUILLE	BUCHSE	CASQUILLO
5 06422400	1 NR	BOCCOLA	BUSH	DOUILLE	BUCHSE	CASQUILLO
6 06309900	1 NR	SPINA	PIN	CHEVILLE	STIFT	CLAVIJA
7 07246900	1 NR	PATTINO IN PLASTICA	SLIDE BLOCK	PLASTIQUE DE CHAUSSURE	SCHUH KUNSTSTOFF	PLÁSTICO DE ZAPATOS
9 07246400	2 NR	PATTINO IN PLASTICA	SLIDE BLOCK	PLASTIQUE DE CHAUSSURE	SCHUH KUNSTSTOFF	PLÁSTICO DE ZAPATOS
10 06624100	2 NR	GUIDA	GUIDE	GLISSIÈRE	FÜHRUNG	GUÍA
11 07271900	2 NR	SPINA	PIN	CHEVILLE	STIF	CLAVIJA
12 06422300	1 NR	BOCCOLA	BUSH	DOUILLE	BUCHSE	CASQUILLO
13 06321200	1 NR	BOCCOLA	BUSH	DOUILLE	BUCHSE	CASQUILLO
14 06623000	2 NR	PATTINO	SLIDE BLOCK	PATIN	GLEITBLOCK	PATÍN
15 07246300	2 NR	PATTINO IN PLASTICA	SLIDE BLOCK	PLASTIQUE DE CHAUSSURE	SCHUH KUNSTSTOFF	PLÁSTICO DE ZAPATOS
16 063040Y2	4 NR	PIATTO	PLATE	PLATEAU	PLATTE	PLACA

 PRIMO SFILO
ERSTER TELESKOPARM 
 FIRST EXTENSION ARM
PRIMO BRAZO DE EXTENSION 
 PREMIER BRAS D'EXTRACTION

POS Codice	Q.tà	 Descrizione	 Description	 Designation	 Benennung	 Descripción
17 06539700	1 NR	RULLO	ROLLER	ROULEAU	ROLLE	RODILLO
18 16710000	2 NR	PULEGGIA	PULLEY	POULIE	SCHEIBE	POLEA
19 372475H3	1 NR	SUPPORTO CATENARIA SU PRIMO SFILO	SUPPORT CABLE HOLDER CHAIN ON FIRST EXTENSION BOOM	APPUI AERIEN SUR PREMIÈRE EXTENSION	OBENLIEGENDE SUPPORT ON ERSTE ERWEITERUNG	APOYO SUPERIOR EN PRIMERA AMPLIACIÓN
20 372451H1	1 NR	PRIMO SFILO	FIRST EXTENSION BOOM	PREMIÈRE PROLONGATION	ERSTE ERWEITERUNG	PRIMERA AMPLIACIÓN
20 372451J0	1 NR	PRIMO SFILO	FIRST EXTENSION BOOM	PREMIÈRE PROLONGATION	ERSTE ERWEITERUNG	PRIMERA AMPLIACIÓN
20 372451J2	1 NR	PRIMO SFILO	FIRST EXTENSION BOOM	PREMIÈRE PROLONGATION	ERSTE ERWEITERUNG	PRIMERA AMPLIACIÓN
32 07246800	2 NR	PATTINO IN PLASTICA	SLIDE BLOCK	PATIN	GLEITELEMENT	PATIN
33 17248500	1 NR	KIT SPAZZOLE PRIMO SFILO LL2010	BRUSHES KIT	KIT BROSSES	BÜRSTENSATZ	KIT CEPILLOS
35 17248800	1 NR	KIT SPAZZOLE TERZO BRACCIO LL2010	BRUSHES KIT	KIT BROSSES	BÜRSTENSATZ	KIT CEPILLOS



 SECONDO SFILLO

ZWEITER TELESKOPARM 

 SECONDO EXTENSION ARM



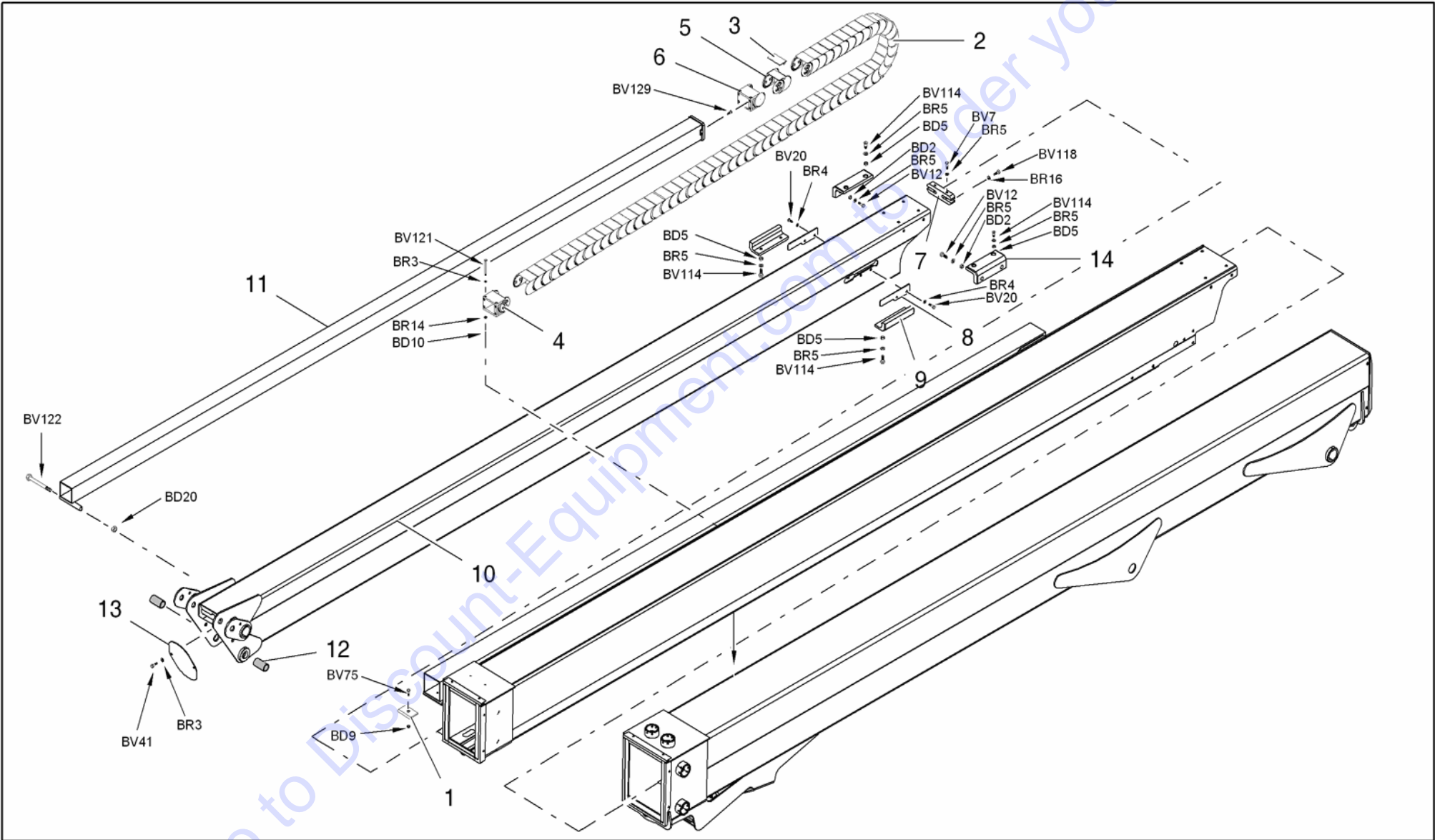

SEGUNDO BRAZO TELESCÓPICO 

 DEUXIÈME BRAS D'EXTRACTION







Go to Discount-Equipment.com to order your parts

 SECONDO SFILO
ZWEITER TELESKOPARM 
 SECONDO EXTENSION ARM
SEGUNDO BRAZO TELESCÓPICO 
 DEUXIÈME BRAS D'EXTRACTION

POS Codice	Q.tà	 Descrizione	 Description	 Designation	 Benennung	 Descripción
1 06586300	1 NR	PATTINO	SLIDE BLOCK	PATIN	GLEITBLOCK	PATÍN
2 27247900	1 NR	CATENA PORTACAVI	CABLE-HOLDER CHAIN	CHAÎNE PORTE-CÂBLES	KABELHALTERK ETTE	CADENA PORTACABLES
3 2646160001	1 NR	COPERCHIO CATENA PORTACAVI	COVER CABLE-HOLDER CHAIN	COUVERCLE	DECKEL	TAPA
4 2646160002	1 NR	ATTACCO FEMMINA CATENA PORTACAVI	FEMALE COUPLING CABLE-HOLDER CHAIN	RACCORD FEMELLE	AUFSTECKANSC HLUSS	EMPALME HEMBRA
5 2646160003	1 NR	MAGLIA CATENA PORTACAVI	CABLE-HOLDER CHAIN LINK	MAILLOT CHAÎNE	KETTENGLIED	ESLABÓN CADENA
6 2646160004	1 NR	ATTACCO MASCHIO CATENA PORTACAVI	MALE COUPLING CABLE-HOLDER CHAIN	RACCORD MÂLE	STECKANSCHLU SS	EMPALME MACHO
7 062962Y2	1 NR	PIASTRA	PLATE	PLATINE	PLATTE	PLACA
8 062967Y1	2 NR	COPERCHIO	COVER	COUVERCLE	DECKEL	TAPA
9 07246600	2 NR	PATTINO IN PLASTICA	SLIDE BLOCK	PLASTIQUE DE CHAUSSURE	SCHUH KUNSTSTOFF	PLÁSTICO DE ZAPATOS

 SECONDO SFILO
ZWEITER TELESKOPARM 
 SECONDO EXTENSION ARM
SEGUNDO BRAZO TELESCÓPICO 
 DEUXIÈME BRAS D'EXTRACTION

POS Codice	Q.tà	 Descrizione	 Description	 Designation	 Benennung	 Descripción
10 172267H1	1 NR	SECONDO SFILO	SECOND EXTENSION ARM	SECOND BRAS D'EXTRACTION	ZWEITER TELESKOPARM	SEGUNDO BRAZO DE EXTENSIÓN
10 172267J0	1 NR	SECONDO SFILO	SECOND EXTENSION ARM	SECOND BRAS D'EXTRACTION	ZWEITER TELESKOPARM	SEGUNDO BRAZO DE EXTENSIÓN
10 172267J2	1 NR	SECONDO SFILO	SECOND EXTENSION ARM	SECOND BRAS D'EXTRACTION	ZWEITER TELESKOPARM	SEGUNDO BRAZO DE EXTENSIÓN
11 372478H3	1 NR	SUPPORTO CATENARIA SU SECONDO SFILO	SUPPORT CABLE HOLDER CHAIN ON SECOND EXTENSION BOOM	APPUI AERIEN SUR SECONDE EXTENSION	O BENLIEGENDE SUPPORT ON ZWEITE VERLÄNGERUNG	APOYO SUPERIOR EN SEGUNDA AMPLIACIÓN
12 06900700	2 NR	BOCCOLA	BUSH	DOUILLE	BUCHSE	CASQUILLO
13 072842H3	1 NR	COPERCHIO	COVER	COUVERTURE	DECKUNG	COBERTURA
14 07246500	2 NR	PATTINO IN PLASTICA	SLIDE BLOCK	PLASTIQUE DE CHAUSSURE	SCHUH KUNSTSTOFF	PLÁSTICO DE ZAPATOS

 SUPPORTO CESTO

HALTERUNG ARBEITSKORB 

 BASKET SUPPORT

SOPORTE CESTA 



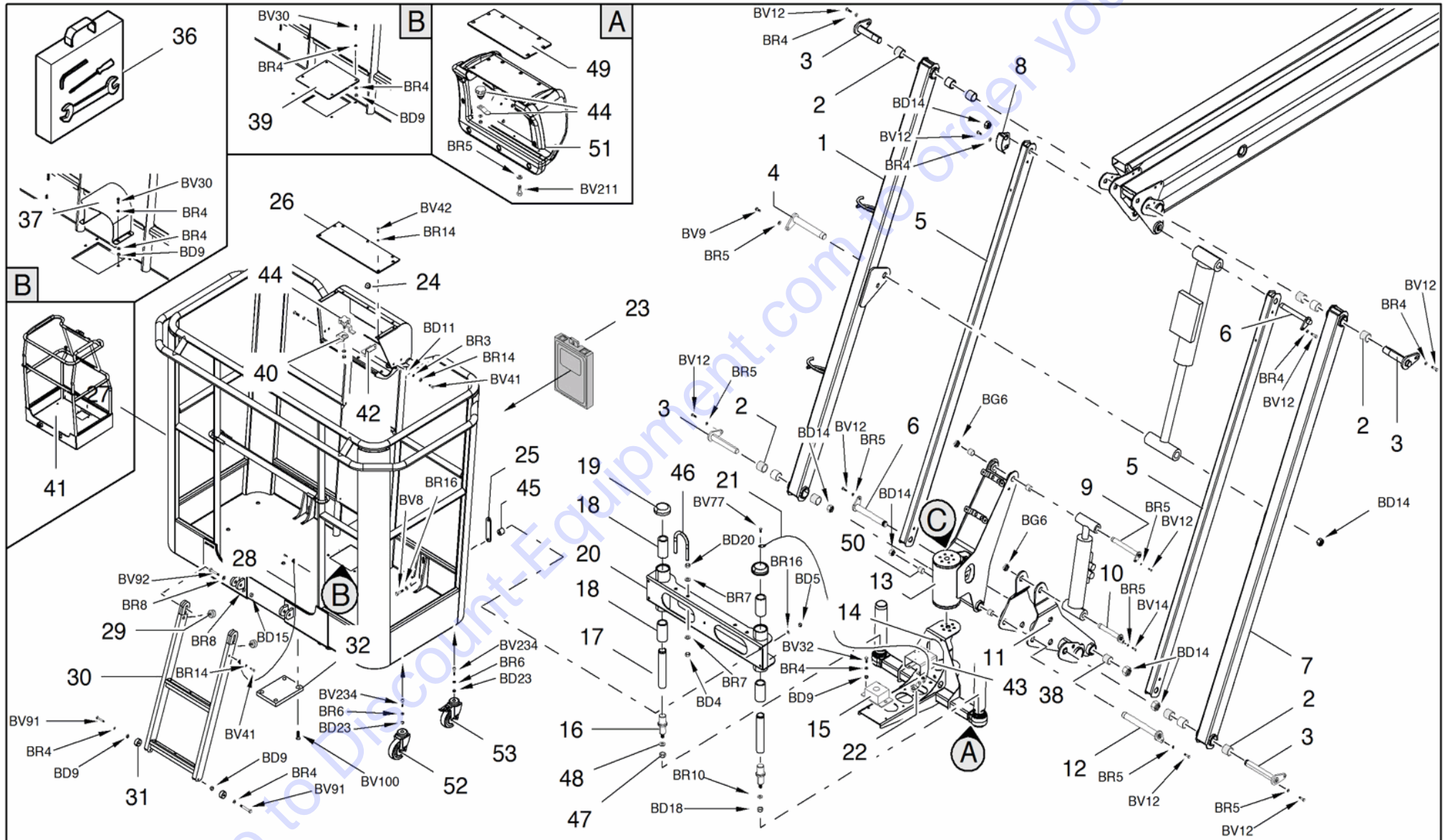

 PANIER CUPPORT



 SUPPORTO CESTO

 HALTERUNG ARBEITSKORB 
 BASKET SUPPORT





 SOPORTE CESTA 
 PANIER CUPPORT

POS Codice	Q.tà	 Descrizione	 Description	 Designation	 Benennung	 Descripcìon
1 170948H1	1 NR	BRACCIO JIB COMPLETO	COMPLETE JIB ARM	FLÉCHETTE BRAS COMPLÈTE	ARM - SCHWENKARM	BRAZO JIB COMPLETO
1 170948J0	1 NR	BRACCIO JIB COMPLETO DX	COMPLETE JIB ARM RIGHT	FLÉCHETTE BRAS COMPLÈTE	ARM - SCHWENKARM	BRAZO JIB COMPLETO
1 170948J2	1 NR	BRACCIO JIB COMPLETO DX	COMPLETE JIB ARM RIGHT	BRAS JIB DROITE COMPLÈTE	KORBARM RECHTS	BRAZO JIB DERECHA COMPLETO
2 06272600	4 NR	BOCCOLA	BUSH	DOUILLE	BUCHSE	CASQUILLO
3 07093500	4 NR	SPINA	PIN	CHEVILLE	STIFT	CLAVIJA
4 07093800	1 NR	SPINA	PIN	CHEVILLE	STIFT	CLAVIJA
5 359447J0	2 NR	TIRANTE JIB	TIE ROD JIB	TIRANT	TURMGESTÄNGE	TIRANTE
5 359447J2	2 NR	TIRANTE JIB	TIE ROD JIB	TIRANT	ZUGSTANGE	TIRANTE
6 07093600	2 NR	SPINA	PIN	CHEVILLE	STIFT	CLAVIJA
7 170947H1	1 NR	BRACCIO JIB COMPLETO	COMPLETE JIB ARM	FLÉCHETTE BRAS COMPLÈTE	ARM - SCHWENKARM	BRAZO JIB COMPLETO
7 170947J0	1 NR	BRACCIO JIB COMPLETO SX	COMPLETE JIB ARM LEFT	FLÉCHETTE BRAS COMPLÈTE	ARM - SCHWENKARM	BRAZO JIB COMPLETO
7 170947J2	1 NR	BRACCIO JIB COMPLETO SX	COMPLETE JIB ARM LEFT	BRAS JIB GAUCHE	KORBARM LINKS	BRAZO JIB IZQUIERDA
8 372264H3	1 NR	CAMMA MICRO JIB	MICROSWITCH CAM JIB	CAME	NOCKEN	LEVA

 SUPPORTO CESTO

 HALTERUNG ARBEITSKORB 
 BASKET SUPPORT





 SOPORTE CESTA 
 PANIER CUPPORT

POS Codice	Q.tà	 Descrizione	 Description	 Designation	 Benennung	 Descripción
9 07093700	1 NR	SPINA	PIN	CHEVILLE	STIFT	CLAVIJA
10 06235600	1 NR	SPINA	PIN	CHEVILLE	STIFT	CLAVIJA
11 166242H1	1 NR	RINVIO	TRANSMISSION	RENOI	VORGELEGE	REENVIO
11 166242J0	1 NR	RINVIO JIB	UPRIGHT JIB	RENOI	VORGELEGE	REENVIO
11 166242J2	1 NR	RINVIO JIB	UPRIGHT JIB	RENOI	VORGELEGE	REENVIO
12 06235700	1 NR	SPINA	PIN	CHEVILLE	STIFT	CLAVIJA
13 2648910002	1 NR	KIT GUARNIZIONI	SEAL KIT	KIT DE JOINTS	DICHTUNGSSATZ	KIT DE JUNTAS
13 271778H2	1 NR	MOTORE DI ROTAZIONE RAL5015	ROTARY MOTOR RAL5015	MOTEUR DE ROTATION RAL5015	MOTORDREHZA H L RAL5015	MOTOR ROTACIÓN RAL5015
13 271778J0	1 NR	MOTORE DI ROTAZIONE	ROTARY MOTOR	MOTEUR DE ROTATION	ROTATIONSMOTO R	MOTOR DE ROTACIÓN
14 371463H2	1 NR	ASSIEME SUPPORTO CESTO PERNI DIAM.50 RAL5015	TOGETHER SUPPORT PINS BASKET DIAM.50 RAL5015	ENSEMBLE SUPPORT PINS BASKET DIAM.50 RAL5015	TOGETHER AUFLAGESTIFTE BASKET DIAM.50 RAL5015	JUNTOS APOYO PINS CESTA DIAM.50 RAL5015
14 371463J0	1 NR	ASSIEME SUPPORTO CESTO PERNI DIAM.50	BASKET ASSEMBLY SUPPORT PINS Ø50	ENSEMBLE SUPPORT PANIER	TOGETHER STÜTZKORBS	JUNTOS SOPORTE DE LA CESTA
15 056187H3	1 NR	COPERCHIO	BOX	COUVERCLE	DECKEL	TAPA

 SUPPORTO CESTO

 HALTERUNG ARBEITSKORB 
 BASKET SUPPORT





 SOPORTE CESTA 
 PANIER CUPPORT

POS Codice	Q.tà	 Descrizione	 Description	 Designation	 Benennung	 Descripción
16 07190900	2 NR	VITE TE DIN960 CI 8.8 M16X1.5X115 FORATA GEOMET321 PLUS XL	TE SCREW DIN960 CI 8.8 M16X1.5X115 GEOMET321 PERFORATED PLUS XL	VIS TE DIN960 CI 8,8 M16X1.5X115 FORE PLUS GEOMET321 XL	TE SCHRAUBE DIN960 CI 8,8 M16X1.5X115 GEOMET321 PERFORATED PLUS XL	TE TORNILLO DIN960 CI 8,8 M16X1.5X115 GEOMET321 PERFORADA XL
17 07146500	2 NR	PERNO SUPPORTO CESTO DIAM.50	PIN SUPPORT BASKET Ø50	AXE DIAM.50 PANIER DE SOUTIEN	BOLZEN KORBHALTERUN G	CLAVIJA CESTA
18 27146200	4 NR	CUSCINETTO LINEARE A SFERE 50-100	LINEAR BALL BEARING 50-100	ROULEMENT LINEAIRE 50-100	LINEAR-KUGELLA GER 50-100	COJINETE DE BOLAS 50-100
19 07146400	2 NR	TAPPO CHIUSURA PERNI SUPPORTO CESTO DIAM.50	CAP PINS BASKET SUPPORT Ø50	BOUCHON	VERSCHLUSS	TAPÓN
20 371459H2	1 NR	SLITTA FISSAGGIO CESTO PERNI DIAM.50	SLIDE BASKET MOUNTING BOLTS Ø50	COULISSEAU	SCHLITTEN	CORREDERA
21 06665000	2 NR	FUNE	CABLE	CÂBLE	SEIL	CABLE
22 07052900	1 NR	STAFFA	BRACKET	ÉTRIER	HALTEBÜGEL	ESTRIBO
23 05643600	1 NR	CASSETTA PORTAMANUALE	MANUAL BOX	BOÎTE PORTE-MANUEL	BEDIENUNGSANL EITUNGSFACH	CAJA PORTAMANUAL

 SUPPORTO CESTO

 HALTERUNG ARBEITSKORB 
 BASKET SUPPORT

 SOPORTE CESTA 
 PANIER CUPPORT





POS Codice	Q.tà	 Descrizione	 Description	 Designation	 Benennung	 Descripción
24 06477600	1 NR	MAGNETE Ø20 CON FORO M3	MAGNETO Ø20 WITH M3 HOLE	AIMANT	MAGNET	IMÁN
24 06477600	3 NR	MAGNETE Ø20 CON FORO M3	MAGNETO Ø20 WITH M3 HOLE	AIMANT	MAGNET	IMÁN
25 072398H3	2 NR	PIASTRA FISSAGGIO CESTO (SOLO MACCHINE MODELLO JP E JA E X17J)	FIXING PLATE BASKET (ONLY MACHINES MODEL JP AND JA AND X17J)	PLATE FIXATION DRUM	PLATE BEFESTIGUNG DRUM	PLACA FIJACIÓN TAMBOR
26 07190600	1 NR	COPERTURA SUPPORTO TELECOMANDO (SOLO MACCHINE MODELLO JP E JA E X17J)	COVER SUPPORT REMOTE CONTROL (ONLY MACHINES MODEL JP AND JA AND X17J)	COUVERTURE SUPPORT DE LA TELECOMMANDE	COVER FERNBEDIENUNG SHALTER	CUBIERTA SOPORTE DE CONTROL REMOTO
27 27177700	1 NR	CESTO BIPOSTO 230KG (SOLO MACCHINE MODELLO JP E JA)	BASKET 2 PERSON 230KG (ONLY MACHINES MODEL JP AND JA)	PANIER 2 PERSONNES	2 MANN-ARBEITSK ORB	CESTA 2 PERSONAS
27 27589300	1 NR	CESTO BIPOSTO 230KG PER MK2 (DA C170000893)	BASKET 2 PERSON 230KG FOR MK2 (FROM C170000893)	PANIER 2 PERSONNES FOR MK2 (FROM C170000893)	2 MANN-ARBEITSK ORB FOR MK2 (FROM C170000893)	CESTA 2 PERSONAS FOR MK2 (FROM C170000893)



 SUPPORTO CESTO

 HALTERUNG ARBEITSKORB 
 BASKET SUPPORT





 SOPORTE CESTA 
 PANIER CUPPORT

POS Codice	Q.tà	 Descrizione	 Description	 Designation	 Benennung	 Descripcìon
28 06598500	1 NR	FUNE	CABLE	CÂBLE	SEIL	CABLE
29 05475900	2 NR	ANTIVIBRANTE	ANTI-VIBRATING	ANTI - VIBRANT	VIBRATIONSDÄM PFER	ANTIVIBRANTE
30 36585800	1 NR	SCALETTA	LADDER	ÉCHELLE REPLIABLE	LEITER	ESCALERA PLEGABLE
31 06585900	2 NR	ROTELLINA	SMALL ROLLER	ROULETTE	RÄDCHEN	RUEDECILLA
32 058600H3	1 NR	PIASTRA	PLATE	PLAQUE	PLATTE	PLACA
37 06418600	1 NR	PROTEZIONE	PROTECTION	PROTECTION	SCHUTZ	PROTECCIÓN
38 06701800	2 NR	BOCCOLA	BUSH	DOUILLE	BUCHSE	CASQUILLO
40 07190800	1 NR	STAFFA FISSAGGIO CHIUSURA BLOCCAGGIO TELECOMANDO (SOLO MACCHINE MODELLO JP E JA E X17J)	BRACKET LOCKING REMOTE CONTROL (ONLY MACHINES MODEL JP AND JA AND X17J)	FIN DE SUPPORT DE BLOCAGE TELECOMMANDE	BRACKET END EINRASTEN FERNBEDIENUNG	SOPORTE DE FIN DE BLOQUEO DE CONTROL REMOTO
41 17668800	1 NR	CESTO MONOPOSTO COMPLETO PER X17JP-X20JP	COMPLETE ONE PERSON BASKET	PANIER COMPLET UNE PERSONNE	1-MAN ARBEITSKORB KOMPLETT	CESTA 1 PERSONA
41 27673500	1 NR					

 SUPPORTO CESTO

 HALTERUNG ARBEITSKORB 
 BASKET SUPPORT

 SOPORTE CESTA 
 PANIER CUPPORT

POS Codice	Q.tà	 Descrizione	 Description	 Designation	 Benennung	 Descripcìon
42 07190500	1 NR	PIEGATO BLOCCAGGIO TELECOMANDO (SOLO MACCHINE MODELLO JP E JA E X17J)	BENDED LOCKING REMOTE CONTROL (ONLY MACHINES MODEL JP AND JA AND X17J)	BENT BLOCAGE TELECOMMANDE	BENT EINRASTEN FERNBEDIENUNG	BENT BLOQUEO DE CONTROL REMOTO
43 072404H3	1 NR	SUPPORTO PEDALE	PEDAL SUPPORT PLATE	TÔLE PLIÉE	HALTERUNG	SOPORTE
44 07192700	1 NR	CHIUSURA A VOLANTINO CON LEVA PIEGATA (SOLO MACCHINE MODELLO JP E JA E X17J)	LOCKING WHEEL WITH BENT LEVER (ONLY MACHINES MODEL JP AND JA AND X17J)	POIGNEE DE BLOCAGE	KUGELVERSCHL USS	POMO DE BLOQUEO
45 07239700	2 NR	DISTANZIALE PER VITI M8 SUPPORTO BASKET (ONLY MACHINES MODELLO JP E JA E X17J)	SPACER SCREW M8 SUPPORT BASKET (ONLY MACHINES MODEL JP AND JA AND X17J)	ENTRETOISE	DISTANZSTÜCK	DISTANCIADOR
46 07031800	2 NR	TUBO	PIPE	TUYAU	ROHR	TUBO

# PARTS FINDER

**Search Website  
by Part Number**



**Search Manual  
Library For Parts  
Manual & Lookup Part  
Numbers – Purchase  
or Request Quote**

**Search Manuals**

Enter your information to search for a manual or parts manual for your equipment.

\* Brand:

\* Model:

\* Serial:

\* Part Number:

SEARCH

**Can't Find Part or  
Manual? Request Help  
by Manufacturer,  
Model & Description**

**Parts Order Form**

Please fill in the following information to request help finding a part or manual.

Manufacturer:

Model:

Description:

Quantity:

Part Number:

Part Name:

Part Description:

Part Category:

Part Location:

Part Status:

Part Condition:

Part Material:

Part Color:

Part Weight:

Part Dimensions:

Part Price:

Part Notes:

Submit

Discount-Equipment.com is your online resource for quality parts & equipment.

Florida: **561-964-4949** Outside Florida TOLL FREE: **877-690-3101**

**Need parts?**





Click on this link: <http://www.discount-equipment.com/category/5443-parts/> and choose one of the options to help get the right parts and equipment you are looking for. Please have the machine model and serial number available in order to help us get you the correct parts. If you don't find the part on the website or on one of the online manuals, please fill out the request form and one of our experienced staff members will get back to you with a quote for the right part that your machine needs.

We sell worldwide for the brands: Genie, Terex, JLG, MultiQuip, Mikasa, Essick, Whiteman, Mayco, Toro Stone, Diamond Products, Generac Magnum, Airman, Haulotte, Barreto, Power Blanket, Nifty Lift, Atlas Copco, Chicago Pneumatic, Allmand, Miller Curber, Skyjack, Lull, Skytrak, Tsurumi, Husquvarna Target, Stow, Wacker, Sakai, Mi-T-M, Sullair, Basic, Dynapac, MBW, Weber, Bartell, Bennar Newman, Haulotte, Ditch Runner, Menegotti, Morrison, Contec, Buddy, Crown, Edco, Wyco, Bomag, Laymor, EZ Trench, Bil-Jax, F.S. Curtis, Gehl Pavers, Heli, Honda, ICS/PowerGrit, IHI, Partner, Imer, Clipper, MMD, Koshin, Rice, CH&E, General Equipment, Amida, Coleman, NAC, Gradall, Square Shooter, Kent, Stanley, Tamco, Toku, Hatz, Kohler, Robin, Wisconsin, Northrock, Oztec, Toker TK, Rol-Air, APT, Wylie, Ingersoll Rand / Doosan, Innovatech, Con X, Ammann, Mecalac, Makinex, Smith Surface Prep, Small Line, Wanco, Yanmar

 SUPPORTO CESTO

 HALTERUNG ARBEITSKORB 
 BASKET SUPPORT

 SOPORTE CESTA 
 PANIER CUPPORT

POS Codice	Q.tà	 Descrizione	 Description	 Designation	 Benennung	 Descripción
47 07193000	2 NR	DADO AD INTAGLI UNI5593 CI 8 M16X1.5 GEOMET321 PLUS XL	NUT M16X1.5 NOTCHES UNI5593 CI 8 GEOMET321 PLUS XL	ÉCROU UNI5593 CI 8 M16X1.5 GEOMET321 PLUS XL	MUTTER UNI5593 CI 8 M16X1.5 GEOMET321 PLUS XL	TUERCA UNI5593 CI 8 M16X1.5 GEOMET321 PLUS XL
48 07192600	2 NR	RONDELLA SPECIALE HV 300 - D 17X48X6 GEOMET321/A+P LUS XL	SPECIAL WASHER HV 300 - 17X48X6 GEOMET321 D / A + PLUS XL	RONDELLE SPECIALE HV 300 - 17X48X6 GEOMET321 D / A + PLUS XL	SCHEIBE HV 300 - 17X48X6 GEOMET321 D / A + PLUS XL	ARANDELA ESPECIAL HV 300 - 17X48X6 GEOMET321 D / A + PLUS XL
49 07690700	1 NR	PROTEZIONE TRASPARENTE	PROTECTION	PROTECTION	SCHUTZ	PROTECCIÓN
50 06272700	1 NR	BOCCOLA	BUSH	DOUILLE	BUCHSE	CASQUILLO
50 06272700	2 NR	BOCCOLA	BUSH	DOUILLE	BUCHSE	CASQUILLO
51 17569900	1 NR	PROTEZIONE TELECOMANDO	PROTECTION REMOTE CONTROL	PROTECTION	SCHUTZ	PROTECCIÓN
52 07687300	2 NR	RUOTE INFERIORI PER CESTO	LOWER WHEEL	ROULEAU INFERIEUR	UNTERES RAD	RUEDA INFERIOR
53 07751100	2 NR	RUOTE INFERIORI PER CESTO CON FRENO	LOWER WHEELS FOR BASKET WITH BRAKE			

 ACCOPPIAMENTO MOTORE DIESEL- POMPA

 DIESEL ENGINE COUPLING - PUMP

 ACCOUPLEMENT MOTEUR DIESEL - POMPE

PUMPEN / DIESELMOTOR KUPPLUNG 

ACOPLAMIENTO MOTOR DIESEL- BOMBA 

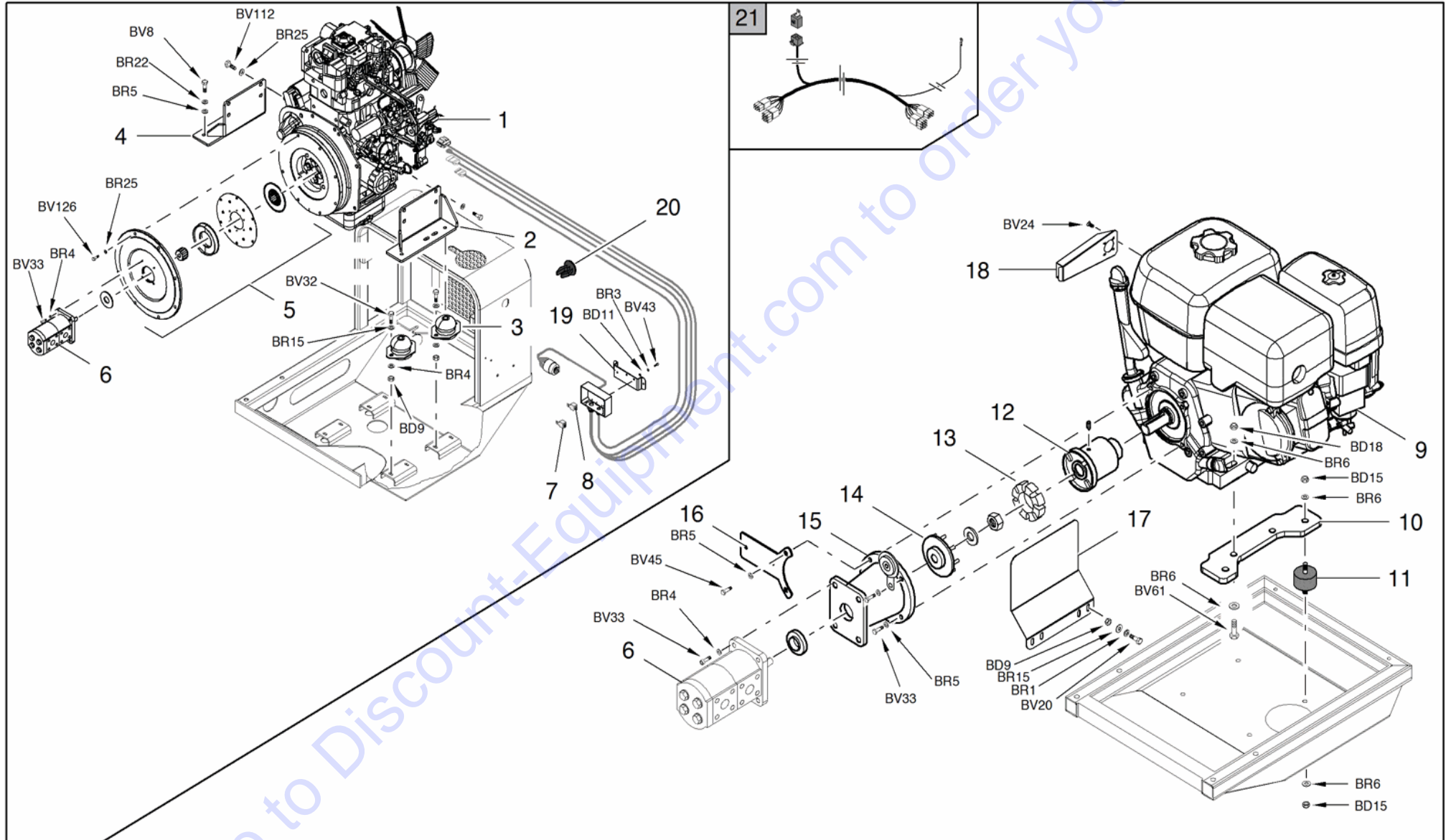





 ACCOPPIAMENTO MOTORE DIESEL- POMPA

PUMPEN / DIESELMOTOR KUPPLUNG 

 DIESEL ENGINE COUPLING - PUMP

ACOPLAMIENTO MOTOR DIESEL- BOMBA 

 ACCOUPLEMENT MOTEUR DIESEL - POMPE

POS Codice	Q.tà	 Descrizione	 Description	 Designation	 Benennung	 Descripcìon
1 26458100	1 NR	MOTORE DIESEL 14HP (NO CARB-EPA CERT)	DIESEL ENGINE 14HP (NO CARB-EPA CERT)	MOTEUR DIESEL	DIESELMOTOR	MOTOR DIESEL
2 063134Y1	1 NR	SUPPORTO	SUPPORT	SUPPORT	HALTERUNG	SOPORTE
3 06458400	4 NR	ANTIVIBRANTE	ANTI-VIBRATING	ANTI - VIBRANT	VIBRATIONSDÄM PFER	ANTIVIBRANTE
4 063135Y1	1 NR	SUPPORTO	SUPPORT	SUPPORT	HALTERUNG	SOPORTE
5 26458500	1 NR	ACCOPPIAMENT O MOTORE DIESEL - POMPA	DIESEL ENGINE COUPLING - PUMP	ACCOUPLEMENT MOTEUR DIESEL - POMPE	PUMPEN / DIESELMOTOR KUPPLUNG	ACOPLAMIENTO MOTOR DIESEL- BOMBA
6 14615200	1 NR	POMPA IDRAULICA	HYDRAULIC PUMP	POMPE HYDRAULIQUE	HYDRAULIKPUMP E	BOMBA HYDRÁULICA
7 1730720002	1 NR	RELE' COMANDO MOTORE DIESEL	RELAY 'CONTROL DIESEL ENGINE	CONTROLE MOTEUR DIESEL RELAY '	RELAY 'CONTROL DIESEL MOTOR	RELE 'CONTROL DE MOTOR DIESEL
8 1730720003	1 NR	FUSIBILE A LAMA 70A	FUSE BLADE 70A	FUSE BLADE 70A	FUSE BLADE 70A	HOJA FUSE 70A





 ACCOPPIAMENTO MOTORE DIESEL- POMPA

PUMPEN / DIESELMOTOR KUPPLUNG 

 DIESEL ENGINE COUPLING - PUMP

ACOPLAMIENTO MOTOR DIESEL- BOMBA 

 ACCOUPLEMENT MOTEUR DIESEL - POMPE

POS Codice	Q.tà	 Descrizione	 Description	 Designation	 Benennung	 Descripcìon
9 25952600	1 NR	MOTORE BENZINA	PETROL ENGINE	MOTEUR A ESSÉNCÉ	BENZINMOTOR	MOTOR DE GASOLINA
9 27676500	1 NR	MOTORE HONDA IGX440 MODIFICATO SENZA BLOCCHETTO CHIAVE DI ACCENSIONE MK2 (FROM C170000893)	HONDA MOTOR IGX440 MODIFIED WITHOUT IGNITION SWITCH MK2 (FROM C170000893)			
10 059551H2	2 NR	PIATTO HONDA IGX440	PLATE HONDA IGX440	PLATEAU HONDA IGX440	PLATTE HONDA IGX440	PLACA HONDA IGX440
11 05535300	4 NR	ANTIVIBRANTE VERSIONE BENZINA	ANTI-VIBRATING GASOLINE VERSION	ANTI - VIBRANT	VIBRATIONS DÄM PFER	ANTIVIBRANTE
12 04310200	1 NR	SEMIGIUNTO	HALF COUPLING	DEMI-JOINT	HALBVERBINDUNG G	SEMI-ACOPLAMIENTO
13 04310100	1 NR	INSERTO IN GOMMA	RUBBER INSERT	INSERT EN CAOUTCHOUC	GUMMIEINSATZ	INSERTO DE GOMA
14 04615300	1 NR	GIUNTO	COUPLING	JOINT	VERBINDUNG	ACOPLAMIENTO
15 04310300	1 NR	LANTERNA	LANTERN	LANTERNE	BUCHSE	LINTERNA
16 061177H2	1 NR	STAFFA	BRACKET	ÉTRIER	HALTEBÜGEL	ESTRIBO
17 061907H2	1 NR	PROTEZIONE	PROTECTION	PROTECTION	SCHUTZ	PROTECCIÓN





 ACCOPPIAMENTO MOTORE DIESEL- POMPA

PUMPEN / DIESELMOTOR KUPPLUNG 

 DIESEL ENGINE COUPLING - PUMP

ACOPLAMIENTO MOTOR DIESEL- BOMBA 

 ACCOUPLEMENT MOTEUR DIESEL - POMPE

POS Codice	Q.tà	 Descrizione	 Description	 Designation	 Benennung	 Descripción
18 05922000	1 NR	DEFLETTORE	DEFLECTOR	DÉFLECTEUR	ABWEISER	DEFLECTOR
19 073265Y1	1 NR	PIEGATO FISSAGGIO COMPONENTI ELETTRICI	FIXING FOLDED ELECTRICAL COMPONENTS	FIXATION DES COMPOSANTS ÉLECTRIQUES PLIE	BEFESTIGUNG GEFALTETEN ELEKTROKOMPO NENTEN	FIJACIÓN DE COMPONENTES ELÉCTRICOS PLEGABLES
20 07690400	1 NR	TAPPO IN PLASTICA PER FORO DA Ø=22-30MM	PLASTIC CAP Ø=22-30MM FOR CLOSING HOLES			
21 17535700	1 NR	KIT RELE' AGGIUNTIVO PER SPEGNIMENTO MOTORE HONDA IGX440	ADDITIONAL RELAY KIT FOR POWER-OFF HONDA MOTOR IGX440	RELAIS	RELAIS	RELÉ



 RICAMBI MOTORE DIESEL

 ENGINE SPARE PARTS DIESEL

 PIÈCES DÉTACHÉES DU MOTEUR DIESEL

MOTORERSATZTEILE DIESEL 



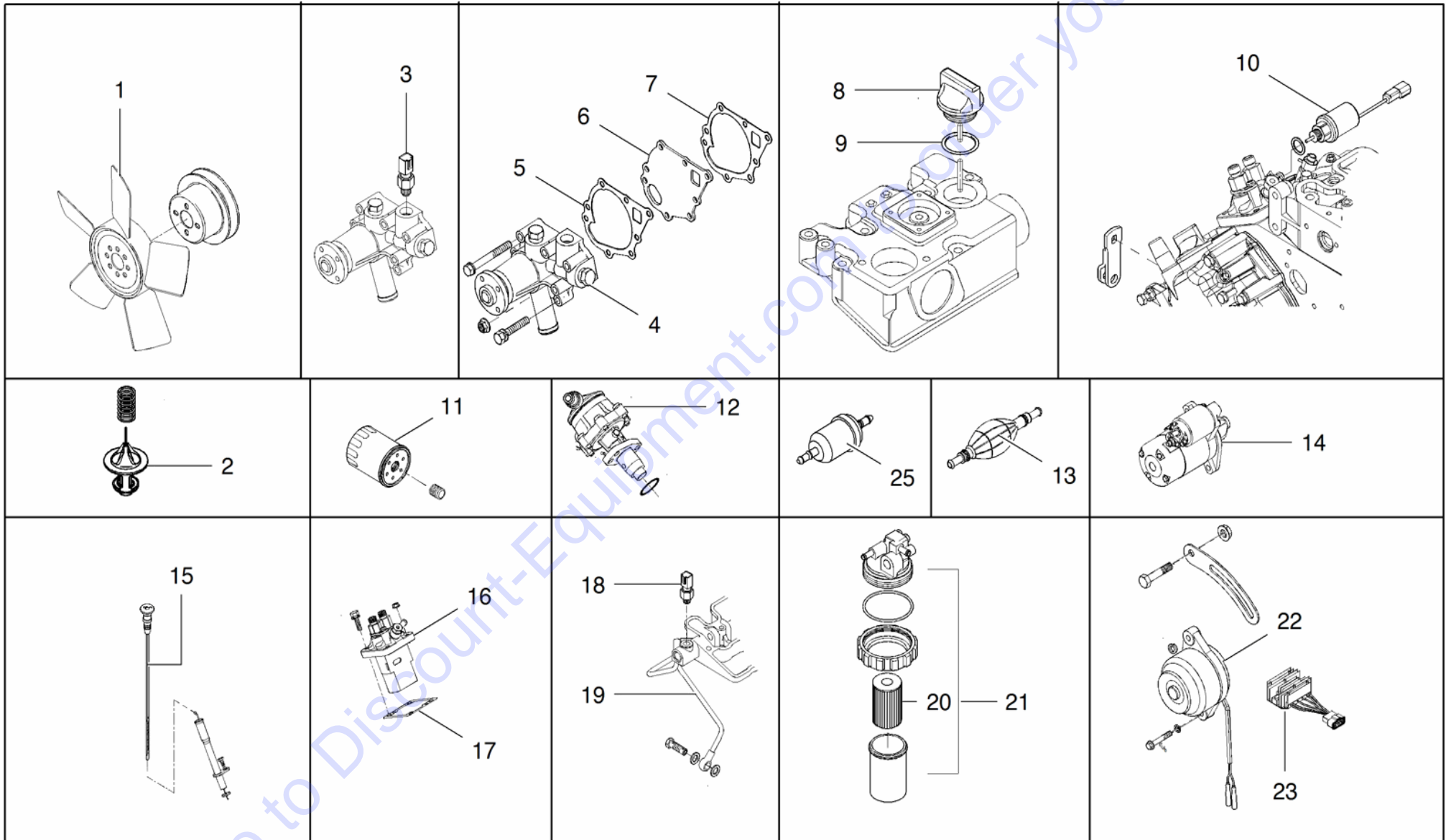

REPUESTOS MOTOR DIESEL 



 RICAMBI MOTORE DIESEL

 MOTORERSATZTEILE DIESEL 
 ENGINE SPARE PARTS DIESEL





 REPUESTOS MOTOR DIESEL 
 PIÈCES DÉTACHÉES DU MOTEUR DIESEL

POS Codice	Q.tà	 Descrizione	 Description	 Designation	 Benennung	 Descripción
1 2645810008	1 NR	VENTOLA	FAN	VENTILATEUR	LÜFTERRAD	VENTILADOR
2 2645810007	1 NR	TERMOSTATO	THERMOSTAT	THERMOSTAT	TEMPERATURRE GLER	TERMÓSTATO
3 2645810019	1 NR	BULBO TEMPERATURA ACQUA	WATER TEMPERATURE BULB	BOULE TEMPÉRATURE EAU	WASSERTEMPER ATURKUGEL	CUBETA TEMPERATURA AGUA
4 2645810023	1 NR	POMPA ACQUA	WATER PUMP	POMPE À EAU	WASSERPUMPE	BOMBA DE AGUA
5 2645810009	1 NR	GUARNIZIONE	GASKET	JOINT	DICHTUNG	GUARNICIÓN
6 2645810006	1 NR	PIASTRA	PLATE	PLATINE	PLATTE	PLACA
7 2645810010	1 NR	GUARNIZIONE	GASKET	JOINT	DICHTUNG	GUARNICIÓN
8 2645810016	1 NR	TAPPO OLIO	OIL PLUG	BOUCHON D'HUILE	ÖLDECKEL	OLIEDOP
9 2645810001	1 NR	GUARNIZIONE	GASKET	JOINT	DICHTUNG	GUARNICIÓN
10 2645810020	1 NR	SOLENOIDE	SOLENOID	SOLENOÏDE	SOLENOID	SOLENOIDE
11 04271000	1 NR	FILTRO OLIO	OIL FILTER	FILTRE À HUILE	ÖLFILTER	FILTRO ACEITE
12 2645810021	1 NR	POMPA ALIMENTAZIONE GASOLIO	GAS OIL FUEL PUMP	POMPE D'ALIMENTATION DIESEL	DIESEL FÖRDERPUMPE	BOMBA DEALIMENTACIÓ N GASOLEO
13 2645810022	1 NR	POMPANTE ALIMENTAZIONE GASOLIO	GAS OIL FUEL PUMP	POMPE D'ALIMENTATION GASOIL	KRAFTSTOFFVE RSORGUNGSPU MPE	BOMBA DE ALIMENTACIÓ GASOLEO

 RICAMBI MOTORE DIESEL

 MOTORERSATZTEILE DIESEL 
 ENGINE SPARE PARTS DIESEL

 REPUESTOS MOTOR DIESEL 
 PIÈCES DÉTACHÉES DU MOTEUR DIESEL

POS Codice	Q.tà	 Descrizione	 Description	 Designation	 Benennung	 Descripción
14 2645810012	1 NR	MOTORINO AVVIAMENTO	STARTER MOTOR	DÉMARREUR	ANLASSER	MOTOR DE ARRANQUE
15 2645810015	1 NR	ASTINA LIVELLO OLIO	OIL DIPSTICK	TIPE NIVEAU HUILE	ÖLSTANDSTAB	VARILLA NIVEL ACEITE
16 2645810003	1 NR	POMPA INIEZIONE	INJECTION PUMP	POMPE D'INJECTION	EINSPRITZPUMPE	EINSPRITZPUMPE
17 2645810004	1 NR	GUARNIZIONE	GASKET	JOINT	DICHTUNG	GUARNICIÓN
18 2645810013	1 NR	BULBO PRESSIONE OLIO	BULB	BOULE	OILTEMPERATUU RBOL	CUBETA
19 2645810005	1 NR	TUBO	PIPE	TUYAU	ROHR	TUBO
20 04089800	1 NR	CARTUCCIA FILTRO OLIO	OIL FILTER CARTRIDGE	CARTOUCHE FILTRE À HUILE	ÖLFILTEREINSAT Z	FILTRO DE ACEITE
21 2645810002	1 NR	FILTRO GASOLIO	GAS OIL FILTER	FILTRE À GASOIL	KRAFTSTOFFFIL TER	FILTRO GASÓLEO
22 2645810011	1 NR	ALTERNATORE	ALTERNATOR	ALTERNATEUR	WECHSELSTROM GENERATOR	ALTERNADOR
23 2645810014	1 NR	REGOLATORE DI TENSIONE	VOLTAGE REGULATOR	RÉGULATEUR DE TENSION	SPANNUNGSREG LER	REGULADOR DE TENSIÓN
25 05006700	1 NR	FILTRO GASOLIO CON RETE FB13 PER MOTORE PERKINS	IN-LINE DIESEL FILTER VT3000-VT4000	FILTRE GASOIL	DIESELFILTER IN-LINIE VT3000-VT4000	FILTRO GASOLEO

 RICAMBI MOTORE DIESEL

 ENGINE SPARE PARTS DIESEL

 PIÈCES DÉTACHÉES DU MOTEUR DIESEL

MOTORERSATZTEILE DIESEL 



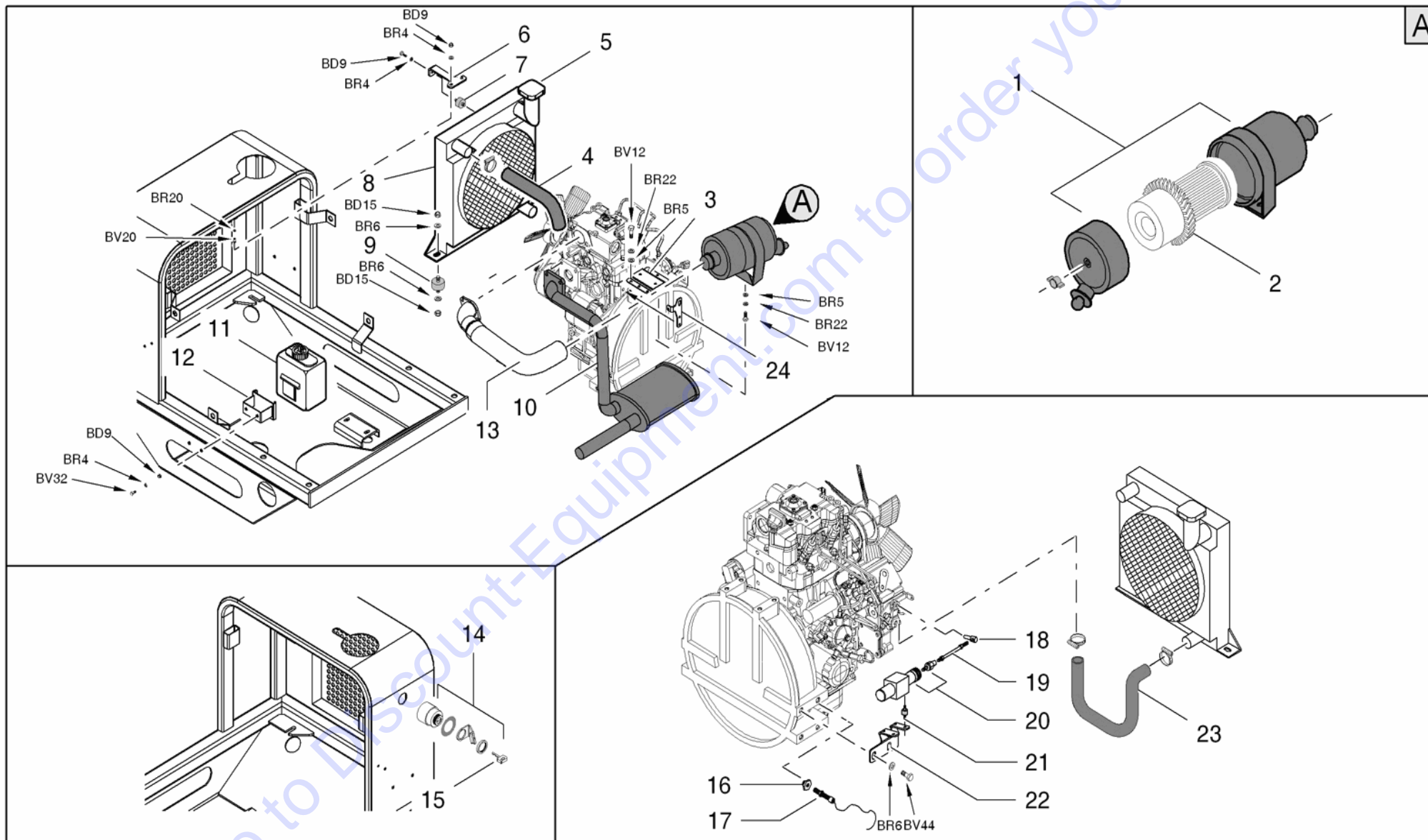

REPUESTOS MOTOR DIESEL 



 RICAMBI MOTORE DIESEL

 MOTORERSATZTEILE DIESEL 
 ENGINE SPARE PARTS DIESEL





 REPUESTOS MOTOR DIESEL 
 PIÈCES DÉTACHÉES DU MOTEUR DIESEL

POS Codice	Q.tà	 Descrizione	 Description	 Designation	 Benennung	 Descripción
1 25659000	1 NR	FILTRO ARIA	AIR FILTER	FILTER À AIR	LUFTFILTER	FILTRO AIRE
2 04091400	1 NR	CARTUCCIA FILTRO ARIA	AIR FILTER CARTRIDGE	CARTOUCHE FILTRE À AIR	LUFTFILTEREINS ATZ	CARTUCHO FILTRO DE AIRE
3 073266Y1	1 NR	PIEGATO FISSAGGIO FILTRO ARIA	FIXING BENDED AIR FILTER	FIXATION PLIE FILTRE A AIR	BEFESTIGUNG GEFALTETEN AIR FILTER	FIJACIÓN DE FILTRO DE AIRE FOLDED
4 04125900	1 NR	MANICOTTO	SLEEVE	MANCHON	MUFFE	MANGUITO
5 2645830001	1 NR	TAPPO	CAP	BOUCHON	VERSCHLUSS	TAPÓN
6 064699Y1	1 NR	STAFFA	BRACKET	ÉTRIER	HALTEBÜGEL	ESTRIBO
7 05689400	1 NR	ANTIVIBRANTE Ø20 H=15 FILETTO M6X18	ANTIVIBRATION Ø20 H = 15 M6X18	ANTI - VIBRANT	VIBRATIONSDÄM PFER	ANTIVIBRANTE
8 27313000	1 NR	RADIATORE	RADIATOR	RADIATEUR	KÜHLER	RADIATOR
9 06145700	2 NR	ANTIVIBRANTE	ANTI-VIBRATING	ANTI - VIBRANT	VIBRATIONSDÄM PFER	ANTIVIBRANTE
10 07286500	1 NR	MARMITTA	MUFFLER	SILENCIEUX	ABBLASDÄMPFE R	SILENCIADOR
11 25779900	1 NR	VASCHETTA ACQUA	WATER RESERVOIR	BASSINET EAU	WASSERBECKE N	PILA AQUA

 RICAMBI MOTORE DIESEL

 MOTORERSATZTEILE DIESEL 
 ENGINE SPARE PARTS DIESEL

 REPUESTOS MOTOR DIESEL 
 PIÈCES DÉTACHÉES DU MOTEUR DIESEL

POS Codice	Q.tà	 Descrizione	 Description	 Designation	 Benennung	 Descripción
12 372847Y1	1 NR	SUPPORTO VASCHETTA ESPANSIONE RADIATORE	SUPPORT RADIATOR EXPANSION TANK	SUPPORT RADIATEUR EXPANSION TANK	SUPPORT KÜHLER EXPANSION TANK	SOPORTE RADIADOR TANQUE DE EXPANSIÓN
13 07326800	1 NR	TUBO ASPIRAZIONE MOTORE DIESEL ARIA	DIESEL ENGINE AIR INTAKE PIPE	TUYAU D'ASPIRATION	SAUGSCHLAUCH	MANGUERA DE ASPIRACIÓN
14 27041300	1 NR	INTERRUTTORE A CHIAVE PRERISCALDO ANTI-RIAVVIO	KEY SWITCH HEATING ANTI-RESTART	KEY CHAUFFAGE DE CONTACT ANTI-REDÉMARR AGE	KEY SWITCH HEIZUNG ANTI-NEUSTART	CLAVE DE CALEFACCIÓN INTERRUPTOR ANTI-ARRANQUE
15 2704130001	1 NR	CHIAVE PER INTERRUTTORE PRERISCALDO ANTI-RIAVVIO DIESEL	KEY FOR SWITCH HEATING ANTI-RESTART	CLE CHAUFFAGE DIESEL ANTI-REDÉMARR AGE	KEY SWITCH HEIZUNG DIESEL ANTI-NEUSTART	LLAVE DE CALEFACCIÓN DIESEL ANTI-ARRANQUE
16 06518200	1 NR	ADATTATORE	ADAPTER	ADAPTATEUR	ADAPTER	ADAPTADOR
17 26514900	1 NR	SENSORE	SENSOR	CAPTEUR	SENSOR	SENSOR
18 06471500	1 NR	PERNO	PIN	GOIJON	ZAPFEN	PERNIO
19 06471400	1 NR	TIRANTE	TIE ROD	TIRANT	TURMGESTÄNGE	TIRANTE
20 26551500	1 NR	PISTONE	PISTON	PISTON	KOLBEN	PISTÓN
21 06551400	4 NR	ANTIVIBRANTE	ANTI-VIBRATING	ANTI - VIBRANT	VIBRATIONS DÄM PFER	ANTIVIBRANTE





 RICAMBI MOTORE DIESEL

MOTORERSATZTEILE DIESEL 

 ENGINE SPARE PARTS DIESEL

REPUESTOS MOTOR DIESEL 

 PIÈCES DÉTACHÉES DU MOTEUR DIESEL

POS Codice	Q.tà	 Descrizione	 Description	 Designation	 Benennung	 Descripcìon
22 065513Y1	1 NR	STAFFA	BRACKET	ÉTRIER	HALTEBÜGEL	ESTRIBO
23 05476400	1 NR	MANICOTTO	SLEEVE	MANCHON	MUFFE	MANGUITO
24 073267Y1	1 NR	PIEGATO FISSAGGIO FILTRO DIESEL	FIXING BENDED FILTER DIESEL	FIXATION PLIE FILTRE À GAZOLE	BEFESTIGUNG FALTENFILTERS DIESEL	FIJACIÓN DE DOBLADO FILTRO DIESEL

Go to Discount-Equipment.com to order your parts

 RICAMBI MOTORE BENZINA

 ENGINE SPARE PARTS GASOLINE

 PIÈCES DÉTACHÉES DU MOTEUR PETROL

MOTORERSATZTEILE BENZIN 

REPUESTOS MOTOR GASOLINA 

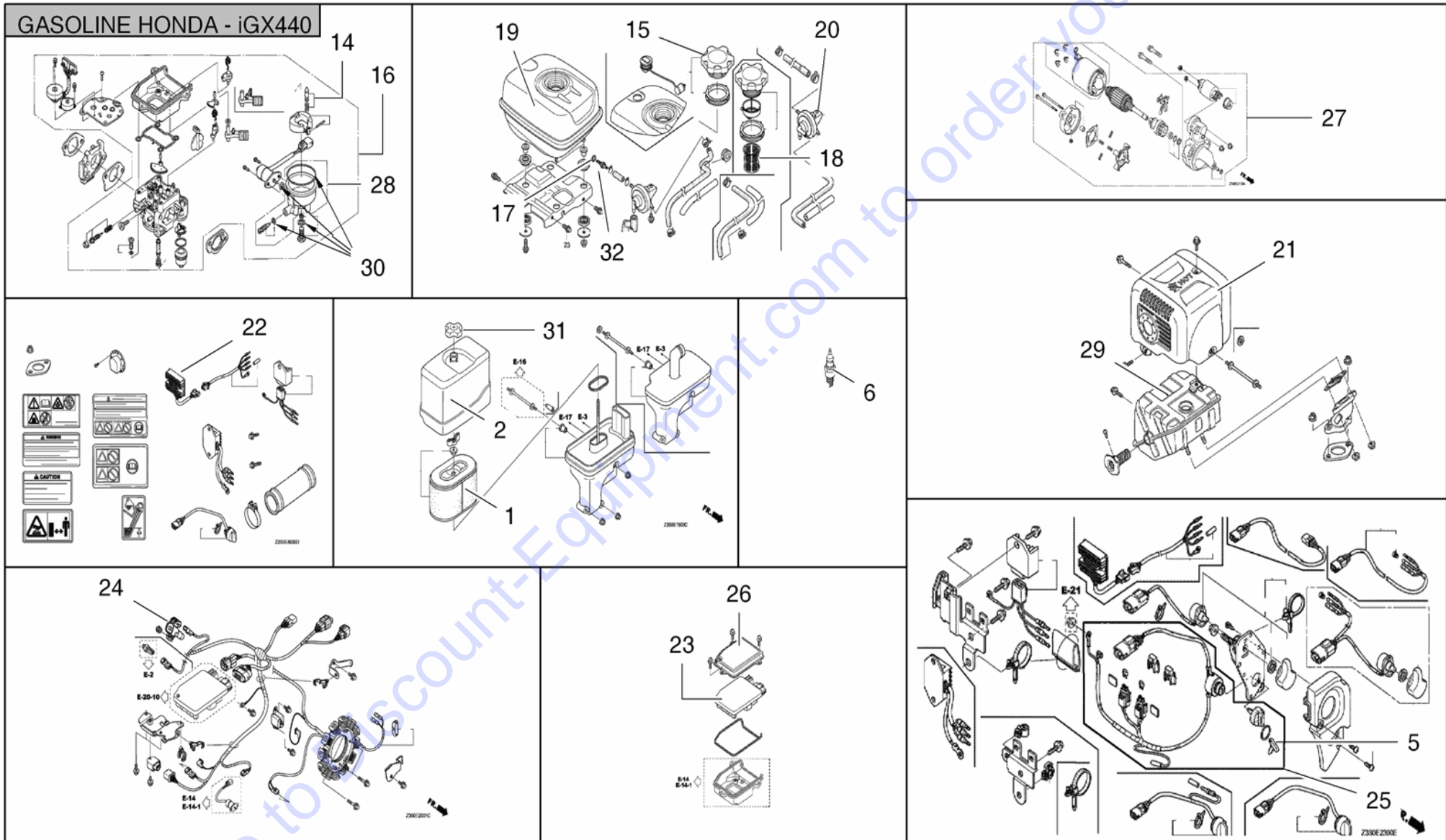







 RICAMBI MOTORE BENZINA

 MOTORERSATZTEILE BENZIN 
 ENGINE SPARE PARTS GASOLINE





 REPUESTOS MOTOR GASOLINA 
 PIÈCES DÉTACHÉES DU MOTEUR PETROL

POS Codice	Q.tà	 Descrizione	 Description	 Designation	 Benennung	 Descripcìon
1 2595260001	1 NR	FILTRO ARIA	AIR FILTER	FILTER À AIR	LUFTFILTER	FILTRO AIRE
2 2595260002	1 NR	COPERCHIO	COVER	COUVERCLE	DECKEL	TAPA
5 2595260003	1 NR	CHIAVE ACCENSIONE MOTORE	KEY IGNITION ENGINE	CLÉ MOTEUR D'ALLUMAGE	ZÜNDUNGSSCHA LTER ENGINE	MOTOR LLAVE
6 2595260004	1 NR	CANDELA ACCENSIONE	SPARKING PLUG	BOUGIE ÉLECTRIQUE	ZÜNDKERZE	BUJÍA ENCENDIDO
14 2558640008	1 NR	SPILLO	SPILLO	AIGUILLE	NADEL	AGUJA
15 2558640012	1 NR	TAPPO SERBATOIO BENZINA	FUEL TANK CAP	BOUCHON RESERVOIR CARBURANT	TANKDECKEL	TANQUE CAP
16 2595260005	1 NR	CARBURATORE PER IGX440	CARBURETOR FOR IGX440	CARBURATEUR POUR IGX440	VERGASER FÜR IGX440	CARBURADOR PARA IGX440
17 2558640031	1 NR	O-RING PER FILTRO BENZINA	O-RING FOR FUEL FILTER	O-RING POUR FILTRE A CARBURANT	O-RING FÜR KRAFTSTOFF FILTER	ANILLO DE FILTRO DE COMBUSTIBLE
18 2595260006	1 NR	FILTRO BENZINA SERBATOIO	FILTER FUEL TANK	RESERVOIR DE CARBURANT FILTRE	FILTER FUEL TANK	TANQUE DE COMBUSTIBLE FILTRO
19 2595260008	1 NR	SERBATOIO BENZINA IGX440IU	FUEL TANK IGX440IU	RESERVOIR DE CARBURANT IGX440IU	FUEL TANK IGX440IU	TANQUE DE COMBUSTIBLE IGX440IU

 RICAMBI MOTORE BENZINA

 MOTORERSATZTEILE BENZIN 
 ENGINE SPARE PARTS GASOLINE





 REPUESTOS MOTOR GASOLINA 
 PIÈCES DÉTACHÉES DU MOTEUR PETROL

POS Codice	Q.tà	 Descrizione	 Description	 Designation	 Benennung	 Descripción
20 2595260007	1 NR	ASSIEME RUBINETTO AUTOMATICO CARBURANTE	AUTOMATIC FUEL VALVE ASSEMBLY	ROBINET AUTOMATIQUE	AUTOMATISCHER WASSERHAHN	GRIFO AUTOMÁTICO
21 2595260009	1 NR	PROTEZIONE MARMITTA HONDA IGX440	PROTECTION MUFFLER HONDA IGX440	PROTECTION D'ECHAPPEMEN T	HITZESCHUTZGIT TER	PROTECCIÓN DEL SILENCIADOR
22 2595260012	1 NR	REGOLATORE MOTORI HONDA IGX440	REGULATOR HONDA MOTORS IGX440	REGULATEUR	REGULATOR	REGULADOR
23 2595260013	1 NR	SCHEDA CARBURATORE GX440	BOARD CARBURETOR GX440	CARTE DE CARBURANT	VERGASER KARTE	TARJETA DE COMBUSTIBLE
24 2595260024	1 NR	BOBINA ACCENSIONE MOTORE IGX440	IGNITION COIL MOTOR IGX440	BOBINE D'ALLUMAGE MOTEUR IGX440	ZÜNDSPULE MOTOR IGX440	BOBINA MOTOR IGX440
25 2595260015	1 NR	ASSIEME INTERUTTORI MOTORE IGX440 DA MATRICOLA MOTORE N°1002823	MOTOR ASSEMBLY SWITCHES IGX440 FROM ENGINE SERIAL N ° 1002823	COMMUTATEURS MOTEUR IGX440	SCHALTER MOTOR IGX440	INTERRUPTORES MOTOR IGX440
26 2595260014	1 NR	COPERCHIO CARBURATORE GX440	COVER CARBURETOR GX440	COVER CARBURATEUR GX440	COVER VERGASER GX440	CUBIERTA CARBURADOR GX440

 RICAMBI MOTORE BENZINA

 MOTORERSATZTEILE BENZIN 
 ENGINE SPARE PARTS GASOLINE

 REPUESTOS MOTOR GASOLINA 
 PIÈCES DÉTACHÉES DU MOTEUR PETROL

POS Codice	Q.tà	 Descrizione	 Description	 Designation	 Benennung	 Descripción
27 2595260025	1 NR	MOTORINO AVVIAMENTO MOTORE HONDA IGX440	STARTER MOTOR HONDA IGX440	STARTER MOTOR HONDA IGX440	STARTER MOTOR HONDA IGX440	MOTOR HONDA IGX440
28 2595260027	1 NR	VASCHETTA CARBURATORE	TANK CARBURATOR	TANQUE DE COMBUSTÍVEL	FUEL TANK	TANQUE DE COMBUSTIBLE
29 2595260028	1 NR	MARMITTA PER HONDA 440	SILENCER FOR HONDA 440	SILENCIEUX POUR HONDA 440	MUFFLER FÜR HONDA 440	SILENCIADOR PARA HONDA 440
30 2595260026	1 NR	KIT GUARNIZIONI CARBURATORE	CARBURATOR GASKET KIT	CARBURETOR TROUSSE DE JOINT	VERGASERDICH SATZ KIT	CARBURADOR KIT DE JUNTAS
31 2595260029	1 NR	DADO PER COPERCHIO FILTRO ARIA	NUT FOR AIR FILTER COVER	NUT POUR FILTRE A AIR COVER	NUT FOR LUFTFILTERDEC KEL	TUERCA DE FILTRO DE AIRE CUBIERTA
32 2598600002	1 NR	RACCORDO PER SERBATOIO	FITTING FOR TANK	MONTAGE DE RÉSERVOIR	PASSEND FÜR TANK	MONTAJE DE TANQUE

Go to DiscountEquipment.com to order your parts

 MOTORE ELETTRICO

E-MOTOR 

 ELECTRIC MOTOR

MOTOR ELÉCTRICO 

 MOTEUR ÉLECTRIQUE

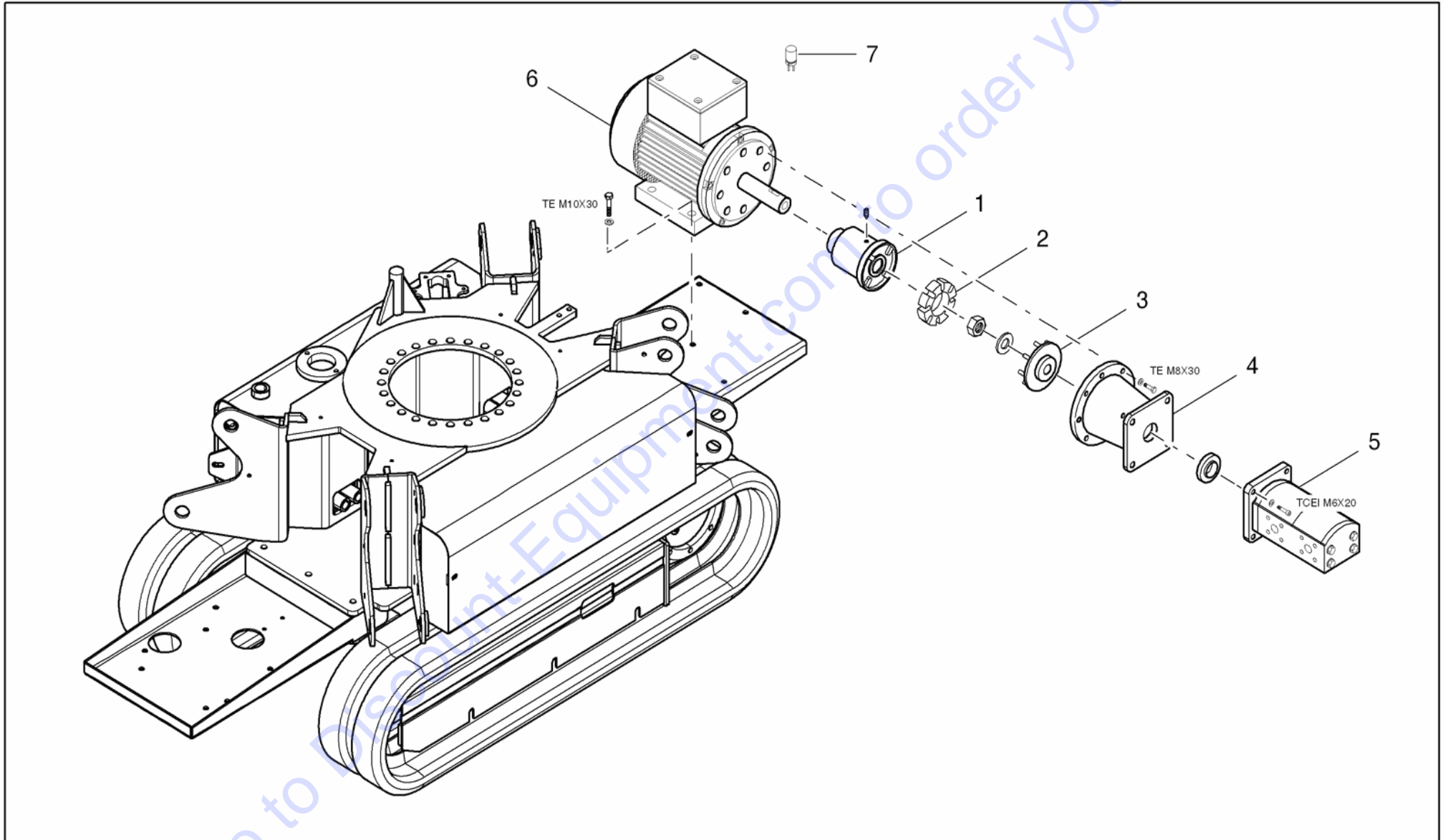





 MOTORE ELETTRICO

E-MOTOR 





 ELECTRIC MOTOR

MOTOR ELÉCTRICO 

 MOTEUR ÉLECTRIQUE

POS Codice	Q.tà	 Descrizione	 Description	 Designation	 Benennung	 Descripción
1 05563400	1 NR	SEMIGIUNTO VERSIONE MOTORE ELETTRICO STANDARD	HALF COUPLING ELECTRIC MOTOR STANDARD VERSION	DEMI-JOINT	HALBKUPPLUNG	SEMI-ACOPLAMIE NTO
1 06997800	1 NR	SEMIGIUNTO VERSIONE LITIO	HALF COUPLING LITHIUM VERSION	DEMI-JOINT	HALBKUPPLUNG	SEMI-ACOPLAMIE NTO
2 04310100	1 NR	INSERTO IN GOMMA	RUBBER INSERT	INSERT EN CAOUTCHOUC	GUMMIEINSATZ	INSERTO DE GOMA
3 04615300	1 NR	GIUNTO	COUPLING	JOINT	VERBINDUNG	ACOPLAMIENTO
4 05510200	1 NR	LANTERNA	LANTERN	LANTERNE	LATERNE	LINTERNA
5 14615200	1 NR	POMPA IDRAULICA	HYDRAULIC PUMP	POMPE HYDRAULIQUE	HYDRAULIKPUMP E	BOMBA HYDRÁULICA
5 25526300	1 NR	POMPA IDRAULICA	HYDRAULIC PUMP	POMPE HYDRAULIQUE	HYDRAULIKPUMP E	BOMBA HYDRÁULICA
5 26328100	1 NR	POMPA IDRAULICA PER MOTORE 120V	HYDRAULIC PUMP FOR ELECTRIC MOTOR 120V	POMPE HYDRAULIQUE	HYDRAULIKPUMP E	BOMBA HYDRÁULICA

 MOTORE ELETTRICO
E-MOTOR 
 ELECTRIC MOTOR
MOTOR ELÉCTRICO 
 MOTEUR ÉLECTRIQUE

POS Codice	Q.tà	 Descrizione	 Description	 Designation	 Benennung	 Descripción
6 25510100	1 NR	MOTORE ELETTRICO 230V 50HZ	ELECTRIC MOTOR 230V 50HZ	MOTEUR ÉLECTRIQUE 230V 50HZ	E-MOTOR 230V 50HZ	MOTOR ELÉCTRICO 230V 50HZ
6 25576400	1 NR	MOTORE ELETTRICO 110V	ELECTRIC MOTOR 110V	MOTEUR ÉLECTRIQUE 110V	E-MOTOR 110V	MOTOR ELÉCTRICO 110V
6 26328300	1 NR	MOTORE ELETTRICO 120V 60HZ 1.2KW 16A	ELECTRIC MOTOR 120V 60HZ 1.2KW 16A	MOTEUR ÉLECTRIQUE	E-MOTOR	MOTOR ELÉCTRICO
6 26948000	1 NR	MOTORE ELETTRICO 3500W LITHIUM 72V	ELECTRIC MOTOR 3500W LITHIUM 72V	MOTEUR ÉLECTRIQUE 3500W LITHIUM 72V	E-MOTOR 3500W LITHIUM 72V	MOTOR ELÉCTRICO 3500W LITHIUM 72V
6 27691100	1 NR	MOTORE ELETTRICO 230V 50HZ MK2 (DA C170000893)	ELECTRIC MOTOR 230V 50HZ MK2 (FROM C170000893)	MOTEUR ÉLECTRIQUE 230V 50HZ MK2 (FROM C170000893)	E-MOTOR 230V 50HZ MK2 (FROM C170000893)	MOTOR ELÉCTRICO 230V 50HZ MK2 (FROM C170000893)





 MOTORE ELETTRICO

E-MOTOR 

 ELECTRIC MOTOR

MOTOR ELÉCTRICO 

 MOTEUR ÉLECTRIQUE

POS	Codice	Q.tà	 Descrizione	 Description	 Designation	 Benennung	 Descripcìon
7	2551010001	1 NR	CONDENSATORE 230V MF80 D=55	CONDENSER 230V MF80 D=55	CONDENSATEUR	KONDENSATOR	CONDENSADOR
7	2557640001	1 NR	CONDENSATORE 110V MF200 D=65	CAPACITOR 110V MF200 D=65	CONDENSATEUR	CAPACITOR	CAPACITOR
7	2557640002	1 NR	CONDENSATORE 110V MF500	CAPACITOR 110V MF500	CONDENSATEUR	CAPACITOR	CAPACITOR
7	2632830001	1 NR	CONDENSATORE PER MOTORE 120V MF120 D=55	CAPACITOR MOTOR 120V MF120 D = 55	CONDENSATEUR	KONDENSATOR	CONDENSADOR
7	2632830002	1 NR	CONDENSATORE PER MOTORE 120V MF160 D=60	CAPACITOR MOTOR 120V MF160 D = 60	CONDENSATEUR	KONDENSATOR	CONDENSADOR

Go to Discount-Equipment.com to order your parts

 IMPIANTO IDRAULICO MANDATE E SCARICO

HYDRAULIKANLAGE VORLÄUFE UND RÜCKLAUF 

 SUPPLY AND DISCHARGE HYDRAULIC SYSTEM

INSTALACIÓN HIDRÁULICA IMPULSIONES Y DESCARGA 

 SYSTÈME HYDRAULIQUE REFOULEMENT ET DÉCHARGEME

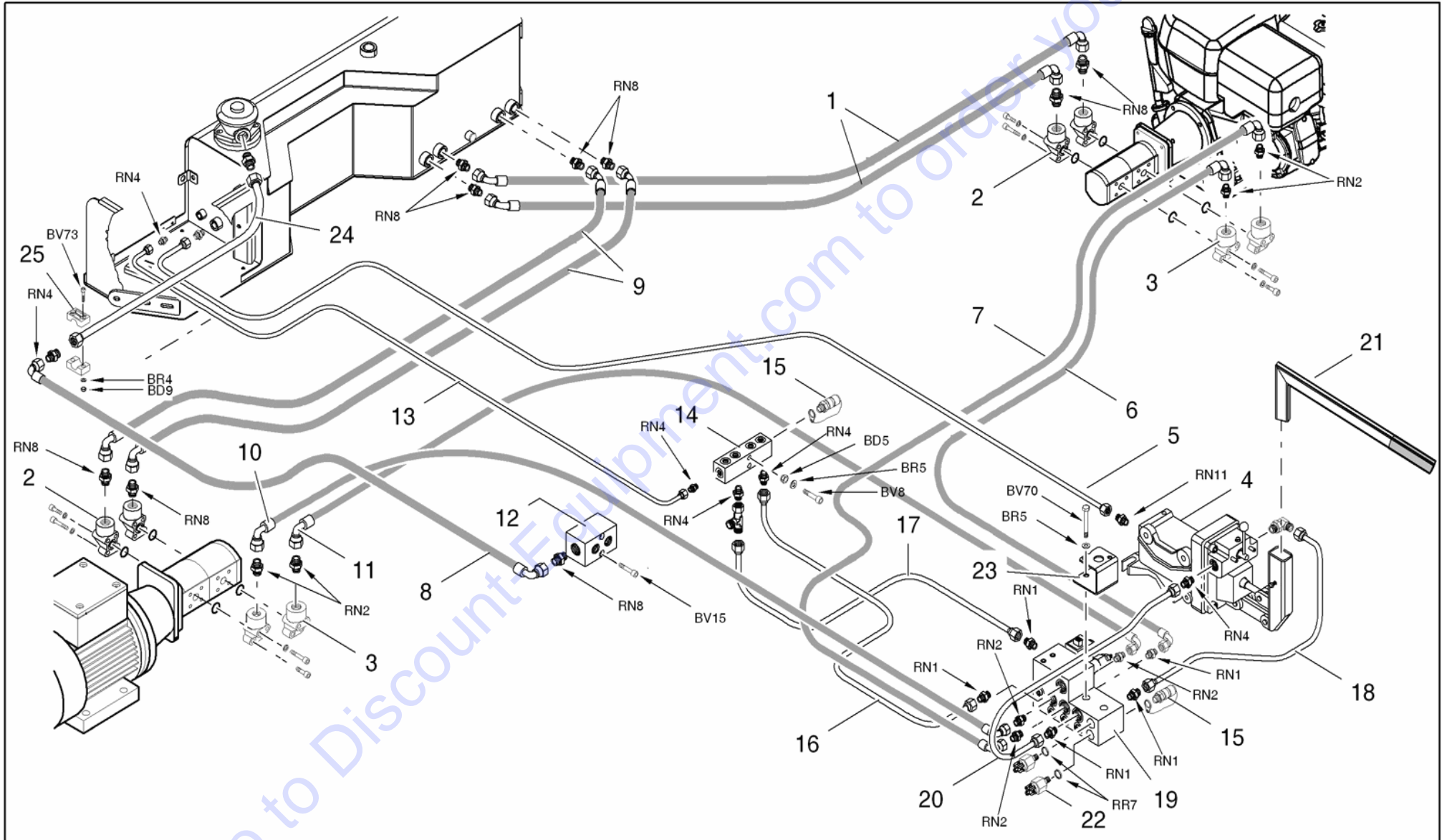







 IMPIANTO IDRAULICO MANDATE E SCARICO

 HYDRAULIKANLAGE VORLÄUFE UND RÜCKLAUF 
 SUPPLY AND DISCHARGE HYDRAULIC SYSTEM

 INSTALACIÓN HIDRÁULICA IMPULSIONES Y DESCARGA 
 SYSTÈME HYDRAULIQUE REFOULEMENT ET DÉCHARGEME

POS Codice	Q.tà	 Descrizione	 Description	 Designation	 Benennung	 Descripción
1 07301500	2 NR	TUBO FLESSIBILE	FLEXIBLE PIPE	TUYAU FLEXIBLE	SCHLAUCH	TUBO FLEXIBLE
2 04845400	2 NR	FLANGIA 1/2"G	FLANGE 1/2"G	BRIDE 1/2"G	FLANSCH 1/2"G	BRIDA 1/2"G
3 04048100	2 NR	FLANGIA 3/8" G	FLANGE 3/8" G	BRIDE 3/8" G	FLANSCH 3/8" G	BRIDA 3/8" G
4 26459400	1 NR	POMPA A MANO	HAND PUMP	POMPE MANUELLE	HANDPUMPE	BOMBA DE MANO
5 07267600	1 NR	TUBO RIGIDO	RIGID PIPE	TUYAU RIGIDE	ROHR	TUBO RÍGIDO
6 07301900	1 NR	TUBO FLESSIBILE	FLEXIBLE PIPE	TUYAU FLEXIBLE	SCHLAUCH	TUBO FLEXIBLE
7 07302000	1 NR	TUBO FLESSIBILE	FLEXIBLE PIPE	TUYAU FLEXIBLE	SCHLAUCH	TUBO FLEXIBLE
8 07301700	1 NR	TUBO FLESSIBILE	FLEXIBLE PIPE	TUYAU FLEXIBLE	SCHLAUCH	TUBO FLEXIBLE
9 07301600	2 NR	TUBO FLESSIBILE	FLEXIBLE PIPE	TUYAU FLEXIBLE	SCHLAUCH	TUBO FLEXIBLE
10 07302100	1 NR	TUBO FLESSIBILE	FLEXIBLE PIPE	TUYAU FLEXIBLE	SCHLAUCH	TUBO FLEXIBLE
11 07302200	1 NR	TUBO FLESSIBILE	FLEXIBLE PIPE	TUYAU FLEXIBLE	SCHLAUCH	TUBO FLEXIBLE
12 05497500	1 NR	BLOCCHETTO TUBI	HOSES BLOCK	BLOC TUYAUX	ROHRBLOCK	BLOQUE TUBOS
13 07267500	1 NR	TUBO RIGIDO	RIGID PIPE	TUYAU RIGIDE	ROHR	TUBO RÍGIDO
14 04707700	2 NR	COLLETTORE	MANIFOLD	COLLECTEUR	KOLLEKTOR	COLECTOR
15 03014400	2 NR	PROVA PRESSIONE 1/4" G	PRESSURE TEST 1/4" G	PREUVE PRESSION 1/4" G	DRUCKKONTROL LE 1/4" G	PRUEBA PRESIÓN 1/4" G





 IMPIANTO IDRAULICO MANDATE E SCARICO

HYDRAULIKANLAGE VORLÄUFE UND RÜCKLAUF 

 SUPPLY AND DISCHARGE HYDRAULIC SYSTEM

INSTALACIÓN HIDRÁULICA IMPULSIONES Y DESCARGA 

 SYSTÈME HYDRAULIQUE REFOULEMENT ET DÉCHARGEME

POS Codice	Q.tà	 Descrizione	 Description	 Designation	 Benennung	 Descripción
16 07267400	1 NR	TUBO RIGIDO	RIGID PIPE	TUYAU RIGIDE	ROHR	TUBO RÍGIDO
16 07502700	1 NR	TUBO RIGIDO	RIGID PIPE	TUYAU RIGIDE	ROHR	TUBO RÍGIDO
17 07345600	1 NR	TUBO RIGIDO	RIGID PIPE	TUYAU RIGIDE	ROHR	TUBO RÍGIDO
18 07267100	1 NR	TUBO RIGIDO	RIGID PIPE	TUYAU RIGIDE	ROHR	TUBO RÍGIDO
19 16478200	1 NR	VALVOLA IDRAULICA	HYDRAULIC VALVE	VALVE HYDRAULIQUE	HYDRAULIKVENTI L	VÁLVULA HIDRÁULICA
20 07267200	1 NR	TUBO RIGIDO	RIGID PIPE	TUYAU RIGIDE	ROHR	TUBO RÍGIDO
21 16517700	1 NR	LEVA	LEVER	LEVIER	HEBEL	PALANCA
22 26964400	2 NR	PRESSOSTATO	PRESSURE SWITCH	PRESSOSTAT	DRUCKSCHALTE R	PRESÓSTATO
23 07268800	1 NR	SUPPORTO	SUPPORT	SOUTIEN	SUPPORT	APOYO
23 075025Y1	1 NR	SUPPORTO	SUPPORT	SOUTIEN	SUPPORT	APOYO
24 07267000	1 NR	TUBO RIGIDO	RIGID PIPE	TUYAU RIGIDE	ROHR	TUBO RÍGIDO
25 04096900	2 NR	MORSETTO	CLAMP	ÉTAU	KLEMME	ABRAZADERA

 IMPIANTO IDRAULICO MANDATE E SCARICO

HYDRAULIKANLAGE VORLÄUFE UND RÜCKLAUF 

 SUPPLY AND DISCHARGE HYDRAULIC SYSTEM

INSTALACIÓN HIDRÁULICA IMPULSIONES Y DESCARGA 

 SYSTÈME HYDRAULIQUE REFOULEMENT ET DÉCHARGEMENT

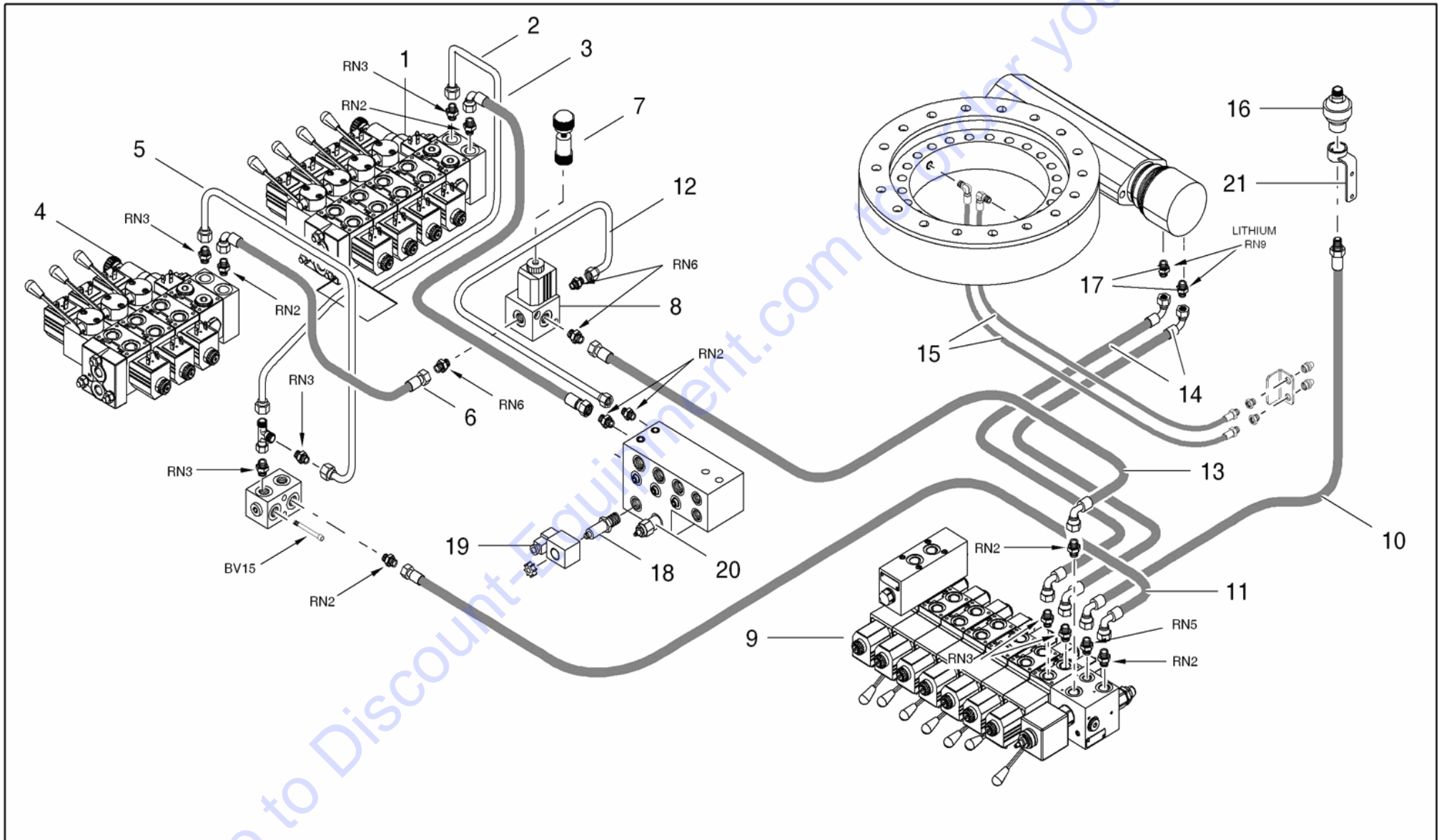





 IMPIANTO IDRAULICO MANDATE E SCARICO

HYDRAULIKANLAGE VORLÄUFE UND RÜCKLAUF 

 SUPPLY AND DISCHARGE HYDRAULIC SYSTEM

INSTALACIÓN HIDRÁULICA IMPULSIONES Y DESCARGA 

 SYSTÈME HYDRAULIQUE REFOULEMENT ET DÉCHARGEMENT

POS Codice	Q.tà	 Descrizione	 Description	 Designation	 Benennung	 Descripción
1 27299100	1 NR	DISTRIBUTORE LC STABILIZZATORI-T RAINO 4 ELEMENTI CON LEVE EMERGENZA A PULSANTE	HYDRAULIC DISTRIBUTOR STABILIZERS-TRA CKS 4 PARTS WITH LEVERS EMERGENCY BUTTON	DISTRIBUTEUR HYDRAULIQUE	HYDRAULIKVENTI LBLOCK	DISTRIBUIDOR HIDRÁULICO
2 07269300	1 NR	TUBO RIGIDO	RIGID PIPE	TUYAU RIGIDE	ROHR	TUBO RÍGIDO
3 07302800	1 NR	TUBO FLESSIBILE	FLEXIBLE PIPE	TUYAU FLEXIBLE	SCHLAUCH	TUBO FLEXIBLE
4 27299000	1 NR	DISTRIBUTORE LC STABILIZZATORI-T RAINO 3 ELEMENTI CON LEVE EMERGENZA A PULSANTE	HYDRAULIC DISTRIBUTOR STABILIZERS-TRA CKS 3 PARTS WITH LEVERS EMERGENCY BUTTON	DISTRIBUTEUR HYDRAULIQUE	HYDR. REGELSTEUERG ERÄT	DISTRIBUIDOR HIDRÁULICO
5 07269200	1 NR	TUBO RIGIDO	RIGID PIPE	TUYAU RIGIDE	ROHR	TUBO RÍGIDO
6 07302900	1 NR	TUBO FLESSIBILE	FLEXIBLE PIPE	TUYAU FLEXIBLE	SCHLAUCH	TUBO FLEXIBLE
7 25908400	1 NR	DISPOSITIVO DI COMANDO MANUALE IDRAULICO	HAND CONTROL HYDRAULIC	COMMANDE HYDRAULIQUE	HYDRAULISCHER ANTRIEB	COMANDO HIDRÁULICO





 IMPIANTO IDRAULICO MANDATE E SCARICO

HYDRAULIKANLAGE VORLÄUFE UND RÜCKLAUF 

 SUPPLY AND DISCHARGE HYDRAULIC SYSTEM

INSTALACIÓN HIDRÁULICA IMPULSIONES Y DESCARGA 

 SYSTÈME HYDRAULIQUE REFOULEMENT ET DÉCHARGEMENT

POS Codice	Q.tà	 Descrizione	 Description	 Designation	 Benennung	 Descripción
8 25732900	1 NR	DEVIATORE IDRAULICO	HYDRAULIC DIVERTER	DÉVIATEUR	WECHSELSCHLEISER	DESVIADOR
9 27323500	1 NR	DISTRIBUTORE IDRAULICO 7 ELEMENTI PARTE AEREA CON PULSANTE	HYDRAULIC DISTRIBUTOR 7 ELEMENTS AERIAL PART WITH BUTTON	DISTRIBUTEUR HYDRAULIQUE	HYDRAULISCHER VERTEILER	DISTRIBUIDOR HIDRÁULICO
9 27533400	1 NR	DISTRIBUTORE IDRAULICO 7 ELEMENTI PARTE AEREA CON PULSANTE (FOR LL1775-X17JP-X5 00AJ-LL2010-X20 JP-X600AJ MK2 FROM C170000893)	HYDRAULIC DISTRIBUTOR 7 ELEMENTS AERIAL PART WITH BUTTON (FOR LL1775-X17JP-X5 00AJ-LL2010-X20 JP-X600AJ MK2 FROM C170000893)	DISTRIBUTEUR HYDRAULIQUE (FOR LL1775-X17JP-X5 00AJ-LL2010-X20 JP-X600AJ MK2 FROM C170000893)	HYDRAULISCHER VERTEILER (FOR LL1775-X17JP-X5 00AJ-LL2010-X20 JP-X600AJ MK2 FROM C170000893)	DISTRIBUIDOR HIDRÁULICO (FOR LL1775-X17JP-X5 00AJ-LL2010-X20 JP-X600AJ MK2 FROM C170000893)
10 07302400	1 NR	TUBO FLESSIBILE	FLEXIBLE PIPE	TUYAU FLEXIBLE	SCHLAUCH	TUBO FLEXIBLE
11 07302600	1 NR	TUBO FLESSIBILE	FLEXIBLE PIPE	TUYAU FLEXIBLE	SCHLAUCH	TUBO FLEXIBLE
12 07267300	1 NR	TUBO RIGIDO	RIGID PIPE	TUYAU RIGIDE	ROHR	TUBO RÍGIDO
12 07502600	1 NR	TUBO RIGIDO	RIGID PIPE	TUYAU RIGIDE	ROHR	TUBO RÍGIDO
13 07302700	1 NR	TUBO FLESSIBILE	FLEXIBLE PIPE	TUYAU FLEXIBLE	SCHLAUCH	TUBO FLEXIBLE
14 07302500	2 NR	TUBO FLESSIBILE	FLEXIBLE PIPE	TUYAU FLEXIBLE	SCHLAUCH	TUBO FLEXIBLE





 IMPIANTO IDRAULICO MANDATE E SCARICO

HYDRAULIKANLAGE VORLÄUFE UND RÜCKLAUF 

 SUPPLY AND DISCHARGE HYDRAULIC SYSTEM

INSTALACIÓN HIDRÁULICA IMPULSIONES Y DESCARGA 

 SYSTÈME HYDRAULIQUE REFOULEMENT ET DÉCHARGEMENT

POS Codice	Q.tà	 Descrizione	 Description	 Designation	 Benennung	 Descripción
15 07302300	2 NR	TUBO FLESSIBILE	FLEXIBLE PIPE	TUYAU FLEXIBLE	SCHLAUCH	TUBO FLEXIBLE
16 26062200	1 NR	ACCUMULATORE	ACCUMULATOR	ACCUMULTEUR	AKKUMULATOR	ACUMULADOR
17 07057000	2 NR	RACCORDO	FITTING	RACCORD	ANSCHLUSS	CONEXIÓN
18 1647820003	1 NR	ELETTROVALVOL A	SOLENOID VALVE	ÉLECTROVANNE	MAGNETVENTIL	ELECTROVÁLVU LA
20 1647820001	1 NR	VALVOLA IDRAULICA	HYDRAULIC VALVE	VALVE HYDRAULIQUE	HYDRAULIKVENTI L	VÁLVULA HIDRÁULICA
21 36470800	1 NR	SUPPORTO	SUPPORT	SUPPORT	HALTERUNG	SOPORTE

 **DISTRIBUTORI IDRAULICI**

**HYDRAULISCHE REGELSTEUERGERÄTE** 



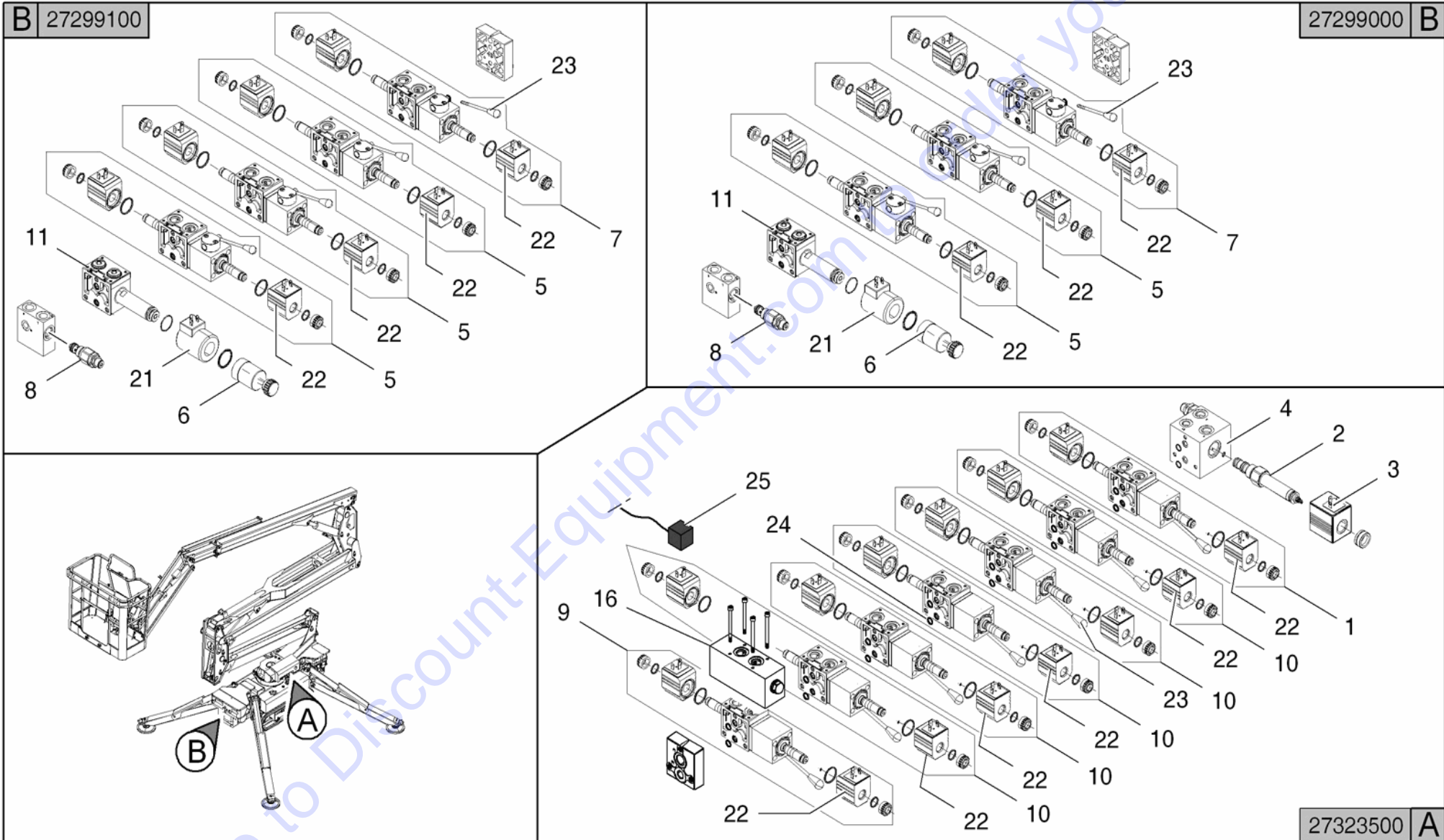

 **HYDRAULIC DISTRIBUTORS**

**DISTRIBUIDORES HIDRÁULICOS** 

 **DISTRIBUTEURS HYDRAULIQUES**



 DISTRIBUTORI IDRAULICI
HYDRAULISCHE REGELSTEUERGERÄTE 
 HYDRAULIC DISTRIBUTORS
DISTRIBUIDORES HIDRÁULICOS 
 DISTRIBUTEURS HYDRAULIQUES





POS Codice	Q.tà	 Descrizione	 Description	 Designation	 Benennung	 Descripción
1 2666800007	1 NR	SEZIONE DISTRIBUTORE ROTAZIONE AEREA AB CHIUSO	CONTROL VALVE SECTION AERIAL ROTATION AB CLOSED	CORPS	GEHÄUSE	CUERPO
2 07325200	1 NR	VALVOLA PROPORZIONALE (CARTUCCIA) PARTE AEREA PIATTAFORME CON RITORNO A MOLLA COMPLETA DI PULSANTE	PROPORTIONAL VALVE AERIAL PARTS WITH SPRING RETURN COMPLETE BUTTON	SOUPAPE PROPORTIONELL E	PROPORTIONALV ENTIL	VALVULA PROPORCIONAL
3 06037900	1 NR	BOBINA PER VALVOLA PROPORZIONALE PARTE AEREA	COIL PROPORTIONAL VALVE FOR AERIAL PART	BOBINE	SPULE	BOBINA
4 2719290001	1 NR	SEZIONE DISTRIBUTORE SOLO CORPO METALLICO	CONTROL VALVE SECTION ONLY METAL BODY	CORPS	GEHÄUSE	CUERPO
5 2645900005	1 NR	SEZIONE DISTRIBUTORE AB CHIUSO CON LEVA (LATO A) E BOBINA	VALVE BLOCK SECTION AB CLOSED WITH LEVER (SIDE A) AND COIL	SECTION DISTRIBUTEUR	VENTILBLOCKSE KTION	SECCIÓN DISTRIBUIDOR







 DISTRIBUTORI IDRAULICI

 HYDRAULISCHE REGELSTEUERGERÄTE 
 HYDRAULIC DISTRIBUTORS





 DISTRIBUIDORES HIDRÁULICOS 
 DISTRIBUTEURS HYDRAULIQUES



POS Codice	Q.tà	 Descrizione	 Description	 Designation	 Benennung	 Descripción
6 07324900	1 NR	COMANDO MANUALE EMERGENZA CON RITORNO A MOLLA	EMERGENCY MAUAL CONTROL WITH SPRING RETURN	COMMANDE MANUEL D'URGENCE	MANUELLES ANTRIEB FÜR NOTSTAND	MANDO MANUAL DE EMERGENCIA
7 2645900006	1 NR	SEZIONE DISTRIBUTORE ABT CON LEVA (LATO A) E BOBINA	VALVE BLOCK SECTION ABT WITH LEVER (SIDE A) AND COIL	SECTION DISTRIBUTEUR	VENTILBLOCKSE KTION	SECCIÓN DISTRIBUIDOR
8 2645900002	1 NR	CARTUCCIA VALVOLA DI MASSIMA PRESSIONE	CARTRIDGE PRESSURE RELIEF VALVE	CARTOUCHE SOUPAPE DE SÉCURITÉ	PARTONE ÜBERDRUCKVEN TIL	CATUCHO VÁLVULA LIMITADORA DE PRESIÓN
9 2666800006	1 NR	SEZIONE DISTRIBUTORE ABT CON LEVA (LATO B 180°) E BOBINA	SECTION DISTRIBUTOR ABT WITH LEVER (SIDE B 180°) AND COIL	CORPS	GEHÄUSE	CUERPO
10 2666800005	1 NR	SEZIONE DISTRIBUTORE AB CHIUSO CON LEVA (LATO B 180°) E BOBINA	SECTION DISTRIBUTOR AB CHIUSO WITH LEVER (SIDE B 180°) AND COIL	CORPS	GEHÄUSE	CUERPO



 DISTRIBUTORI IDRAULICI
HYDRAULISCHE REGELSTEUERGERÄTE 
 HYDRAULIC DISTRIBUTORS
DISTRIBUIDORES HIDRÁULICOS 
 DISTRIBUTEURS HYDRAULIQUES

POS Codice	Q.tà	 Descrizione	 Description	 Designation	 Benennung	 Descripción
11 2729900001	1 NR	VALVOLA PROPORZIONALE TRAINI CON BOBINA E SENZA COMANDO MANUALE A MOLLA	PROPORTIONAL VALVE FOR TRACK WITH COIL AND WITHOUT MANUAL SPRING	SOUPAPE PROPORTIONELL E	PROPORTIONALV ENTIL	VÁLVULA PROPORCIONAL
16 2585560004	1 NR	BLOCCO VALVOLA BILANCIAMENTO BRACCI SU DISTRIBUTORI PARTE AEREA	BALANCING VALVE BLOCK BOOMS OF DISTRIBUTORS AERIAL PART	BLOC SOUPAPE	VENTILSPERRE	BLOQUE VÁLVULA
21 06037100	1 NR	BOBINA PER VALVOLA PROPORZIONALE PARTE CARRO	COIL PROPORTIONAL VALVE FOR UNDERCARRIAG E	BOBINE	SPULE	BOBINA
22 05913800	1 NR	BOBINA PER ON-OFF	COIL FOR ON-OFF	BOBINE	SPULE	BOBINA
23 07300200	1 NR	LEVA DISTRIBUTORE	LEVER HYDRAULIC DISTRIBUTOR	LEVIER	HEBEL	PALANCA
24 2585560005	1 NR	O-RING	O-RING	O-RING	O-RING	O-RING

 DISTRIBUTORI IDRAULICI
HYDRAULISCHE REGELSTEUERGERÄTE 
 HYDRAULIC DISTRIBUTORS
DISTRIBUIDORES HIDRÁULICOS 
 DISTRIBUTEURS HYDRAULIQUES

POS Codice	Q.tà	 Descrizione	 Description	 Designation	 Benennung	 Descripción
25 1730720001	1 NR	ELETTROVALVOL A ON-OFF CON LED	SOLENOID ON-OFF WITH LED	ELECTROVANNE ON-OFF AVEC LED	SOLENOID ON-OFF WITH LED	SOLENOIDE ON-OFF CON LED
26 2753340004	1 NR	ELEMENTO DISTRIBUTORE COMPLETO DI PROPORZIONALE PARTE AEREA CON LEVA ROSSA (LATO 1)	VALVE BLOCK ELEMENT	ELEMENT DISTRIBUTEUR	VENTILBLOCKSA TZ	ELEMENTO DISTRIBUIDOR
27 2753340003	1 NR	LEVA ROSSA DISTRIBUTORE	RED LEVER HYDRAULIC DISTRIBUTOR	LEVIER	HEBEL	PALANCA
28 2753340001	1 NR	SEZIONE DISTRIBUTORE AB CHIUSO CON LEVA (LATO 1) E BOBINA	SECTION DISTRIBUTOR AB CLOSED WITH LEVER (SIDE 1) AND COIL	SECTION DISTRIBUTEUR	VENTILBLOCKSE KTION	SECCIÓN DISTRIBUIDOR
29 2753340002	1 NR	SEZIONE DISTRIBUTORE ABT CON LEVA (LATO 1) E BOBINA	SECTION DISTRIBUTOR ABT WITH LEVER (SIDE 1) AND COIL	SECTION DISTRIBUTEUR	VENTILBLOCKSE KTION	SECCIÓN DISTRIBUIDOR

 IMPIANTO IDRAULICO TRAZIONE  
 HYDRAULIC SYSTEM FOR TRACTION  
 SYSTÈME HYDRAULIQUE DE TRACTION

HYDRAULIKANLAGE ANTRIEB   
INSTALACIÓN HIDRÁULICA TRACCIÓN 

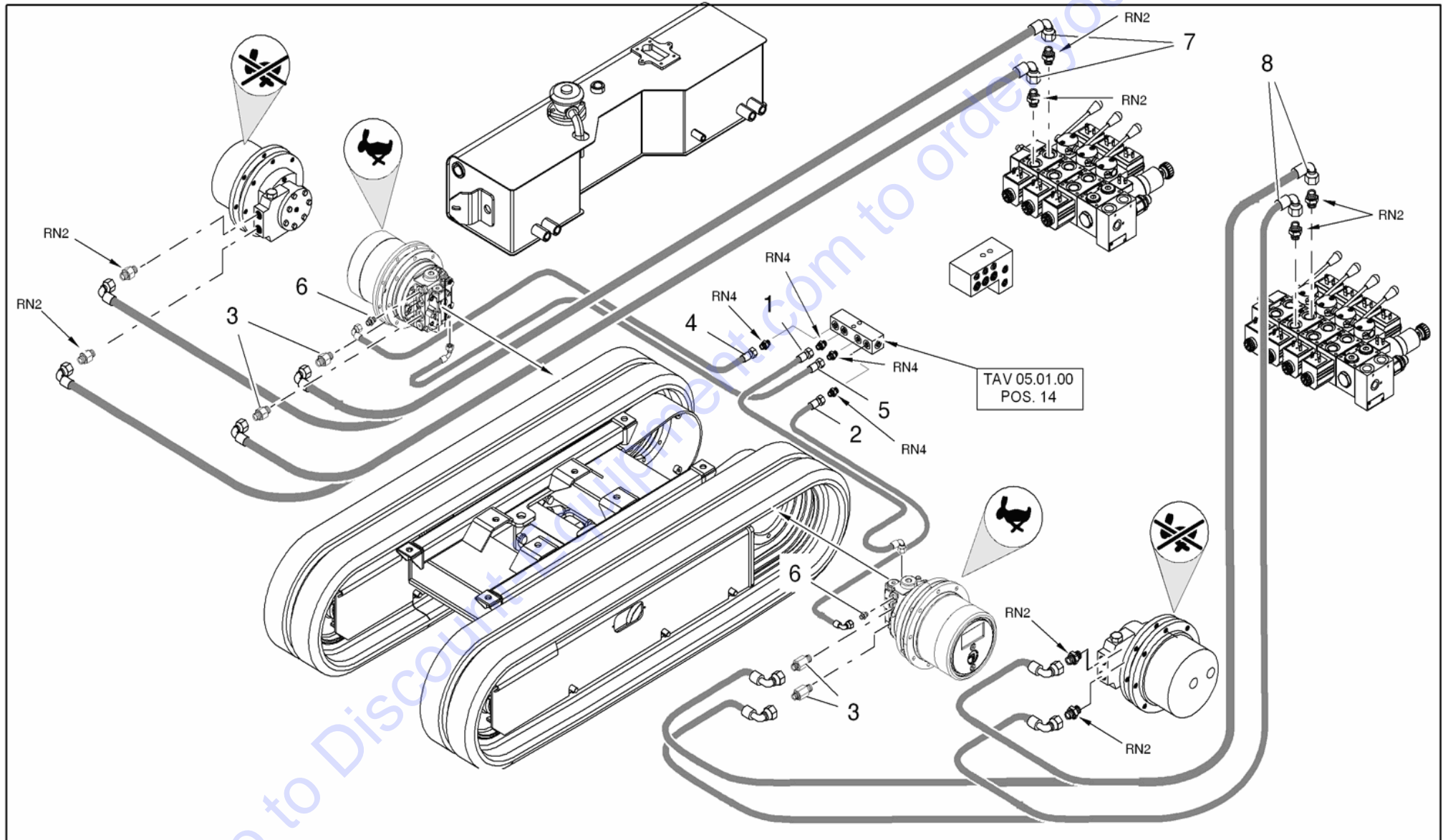





 IMPIANTO IDRAULICO TRAZIONE

HYDRAULIKANLAGE ANTRIEB 

 HYDRAULIC SYSTEM FOR TRACTION

INSTALACIÓN HIDRÁULICA TRACCIÓN 

 SYSTÈME HYDRAULIQUE DE TRACTION

POS Codice	Q.tà	 Descrizione	 Description	 Designation	 Benennung	 Descripción
1 07305000	1 NR	TUBO FLESSIBILE	FLEXIBLE PIPE	TUYAU FLEXIBLE	SCHLAUCH	TUBO FLEXIBLE
2 07304900	1 NR	TUBO FLESSIBILE	FLEXIBLE PIPE	TUYAU FLEXIBLE	SCHLAUCH	TUBO FLEXIBLE
3 05093900	4 NR	RACCORDO 12L-3/8 JIS ESAGONO 22 H40	12L-FITTING 3/8 JIS HEX22 H40	RACCORD	ANSCHLUSS	CONEXIÓN
4 07305100	1 NR	TUBO FLESSIBILE	FLEXIBLE PIPE	TUYAU FLEXIBLE	SCHLAUCH	TUBO FLEXIBLE
5 07304800	1 NR	TUBO FLESSIBILE	FLEXIBLE PIPE	TUYAU FLEXIBLE	SCHLAUCH	TUBO FLEXIBLE
6 05093800	2 NR	RACCORDO	FITTING	RACCORD	ANSCHLUSS	CONEXIÓN
7 07300900	2 NR	TUBO FLESSIBILE	FLEXIBLE PIPE	TUYAU FLEXIBLE	SCHLAUCH	TUBO FLEXIBLE
8 07300800	2 NR	TUBO FLESSIBILE	FLEXIBLE PIPE	TUYAU FLEXIBLE	SCHLAUCH	TUBO FLEXIBLE

Go to Discount-Equipment.com to order your parts

 IMPIANTO IDRAULICO ALLARGAMENTO CARRO

HYDRAULIKANLAGE VERBREITERUNG WAGEN 

 HYDRAULIC SYSTEM UNDERCARRIAGE EXPANSION

INSTALACIÓN HIDRAULICA ENSANCHAMIENTO CARRO 

 SYSTÈME HYDRAULIQUE EXTENSION DU CHARIOT

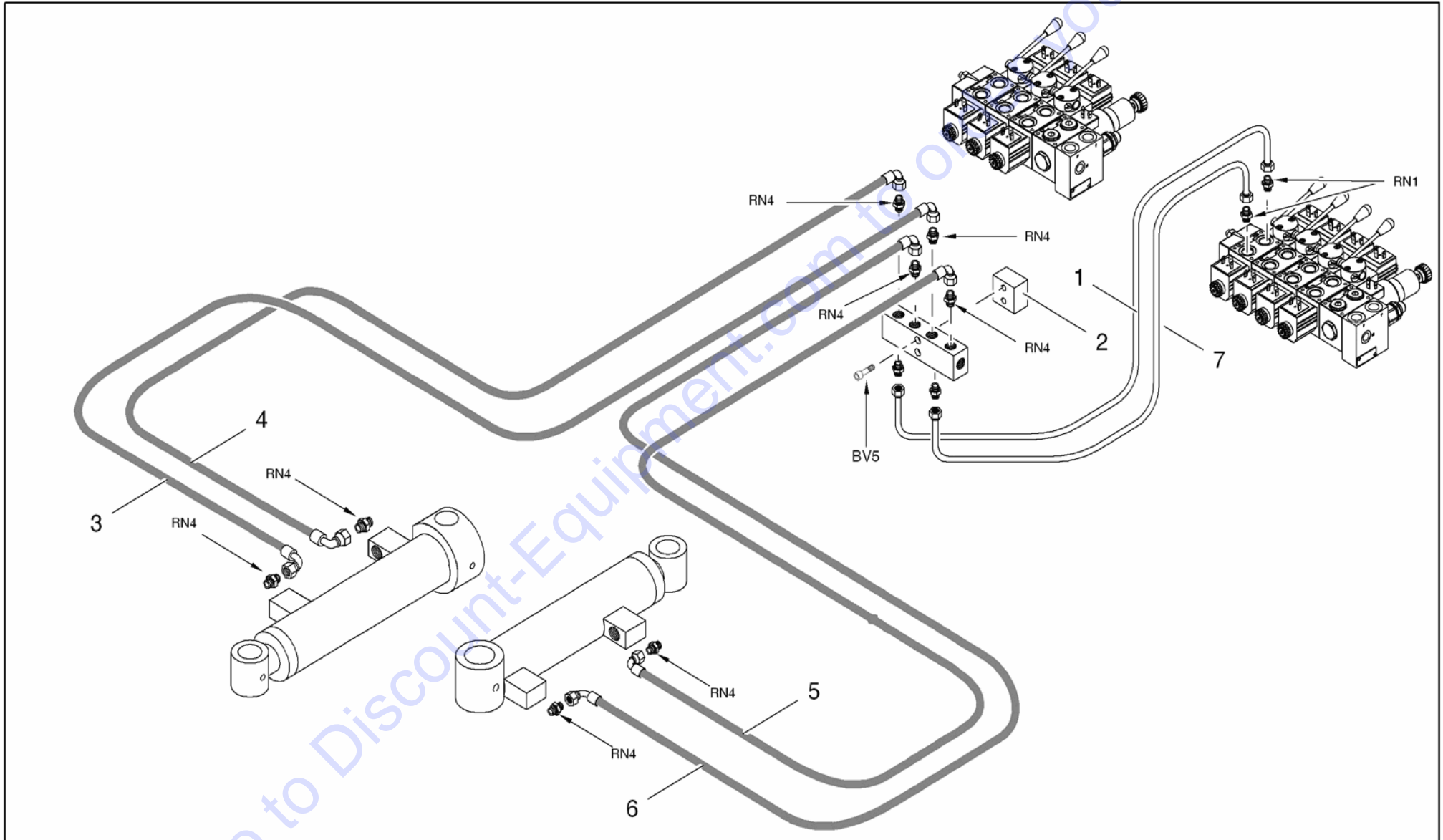





 IMPIANTO IDRAULICO ALLARGAMENTO CARRO

HYDRAULIKANLAGE VERBREITERUNG WAGEN 

 HYDRAULIC SYSTEM UNDERCARRIAGE EXPANSION

INSTALACIÓN HIDRAULICA ENSANCHAMIENTO CARRO 

 SYSTÈME HYDRAULIQUE EXTENSION DU CHARIOT

POS Codice	Q.tà	 Descrizione	 Description	 Designation	 Benennung	 Descripción
1 07269400	1 NR	TUBO RIGIDO	RIGID PIPE	TUYAU RIGIDE	ROHR	TUBO RÍGIDO
2 07172500	1 NR	DISTANZIALE	SPACER	ENTRETOISE	DISTANZSCHEIBE	SEPARADOR
3 07301200	1 NR	TUBO FLESSIBILE	FLEXIBLE PIPE	TUYAU FLEXIBLE	SCHLAUCH	TUBO FLEXIBLE
4 07301300	1 NR	TUBO FLESSIBILE	FLEXIBLE PIPE	TUYAU FLEXIBLE	SCHLAUCH	TUBO FLEXIBLE
5 07301100	1 NR	TUBO FLESSIBILE	FLEXIBLE PIPE	TUYAU FLEXIBLE	SCHLAUCH	TUBO FLEXIBLE
6 07301000	1 NR	TUBO FLESSIBILE	FLEXIBLE PIPE	TUYAU FLEXIBLE	SCHLAUCH	TUBO FLEXIBLE
7 07269500	1 NR	TUBO RIGIDO	RIGID PIPE	TUYAU RIGIDE	ROHR	TUBO RÍGIDO

Go to Discount-Equipment.com to order your parts

 IMPIANTO IDRAULICO STABILIZZATORI

ABSTÜTZUNG ABSTÜTZUNGSHYDRAULIKZYLIND 

 STABILIZERS HYDRAULIC SYSTEM

INSTALACIÓN HIDRAULICA ESTABILIZADORS 

 INSTALLATION HYDRAULIQUE STABILISATERS

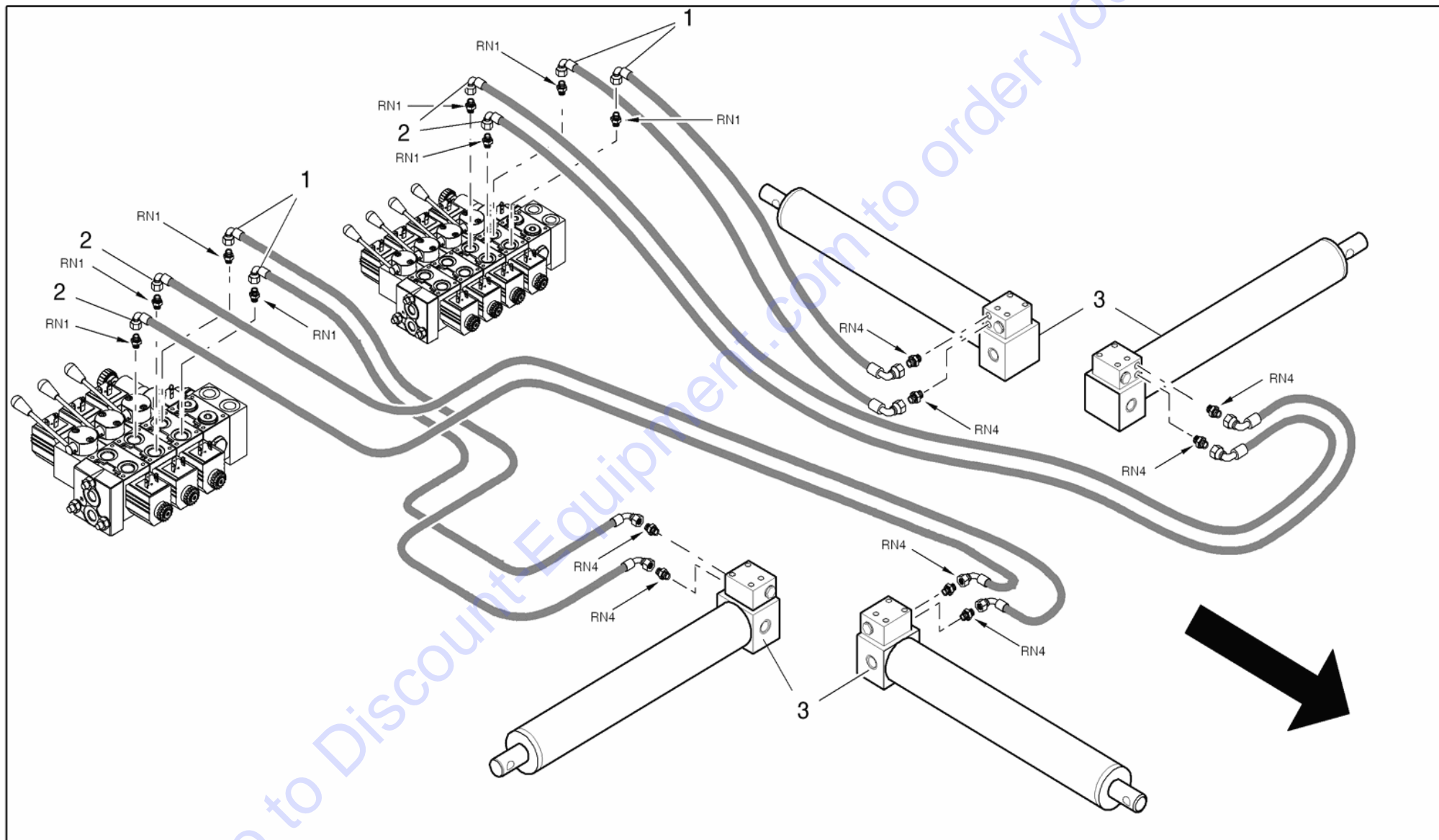







 IMPIANTO IDRAULICO STABILIZZATORI

ABSTÜTZUNG ABSTÜTZUNGSHYDRAULIKZYLIND 

 STABILIZERS HYDRAULIC SYSTEM

INSTALCIÓN HIDRAULICA ESTABILIZADORS 

 INSTALLATION HYDRAULIQUE STABILISATERS

POS Codice	Q.tà	 Descrizione	 Description	 Designation	 Benennung	 Descripció
1 07301400	4 NR	TUBO FLESSIBILE	FLEXIBLE PIPE	TUYAU FLEXIBLE	SCHLAUCH	TUBO FLEXIBLE
2 07301800	4 NR	TUBO FLESSIBILE	FLEXIBLE PIPE	TUYAU FLEXIBLE	SCHLAUCH	TUBO FLEXIBLE
3 27226100	4 NR	CILINDRO STABILIZZATORE LL2010	CYLINDER OUTRIGGER	DÉTENDEUR DE LA BOUTEILLE LL2010	FLASCHENDRUC KMINDERER LL2010	CILINDRO ESTABILIZADOR LL2010
3 272261H2	4 NR	CILINDRO STABILIZZATORE LL2010	CYLINDER OUTRIGGER	DÉTENDEUR DE LA BOUTEILLE LL2010	FLASCHENDRUC KMINDERER LL2010	CILINDRO ESTABILIZADOR LL2010

Go to Discount-Equipment.com to order your parts

 IMPIANTO IDRAULICO 1-2 BRACCI

 1-2 ARMS HYDRAULIC SYSTEM



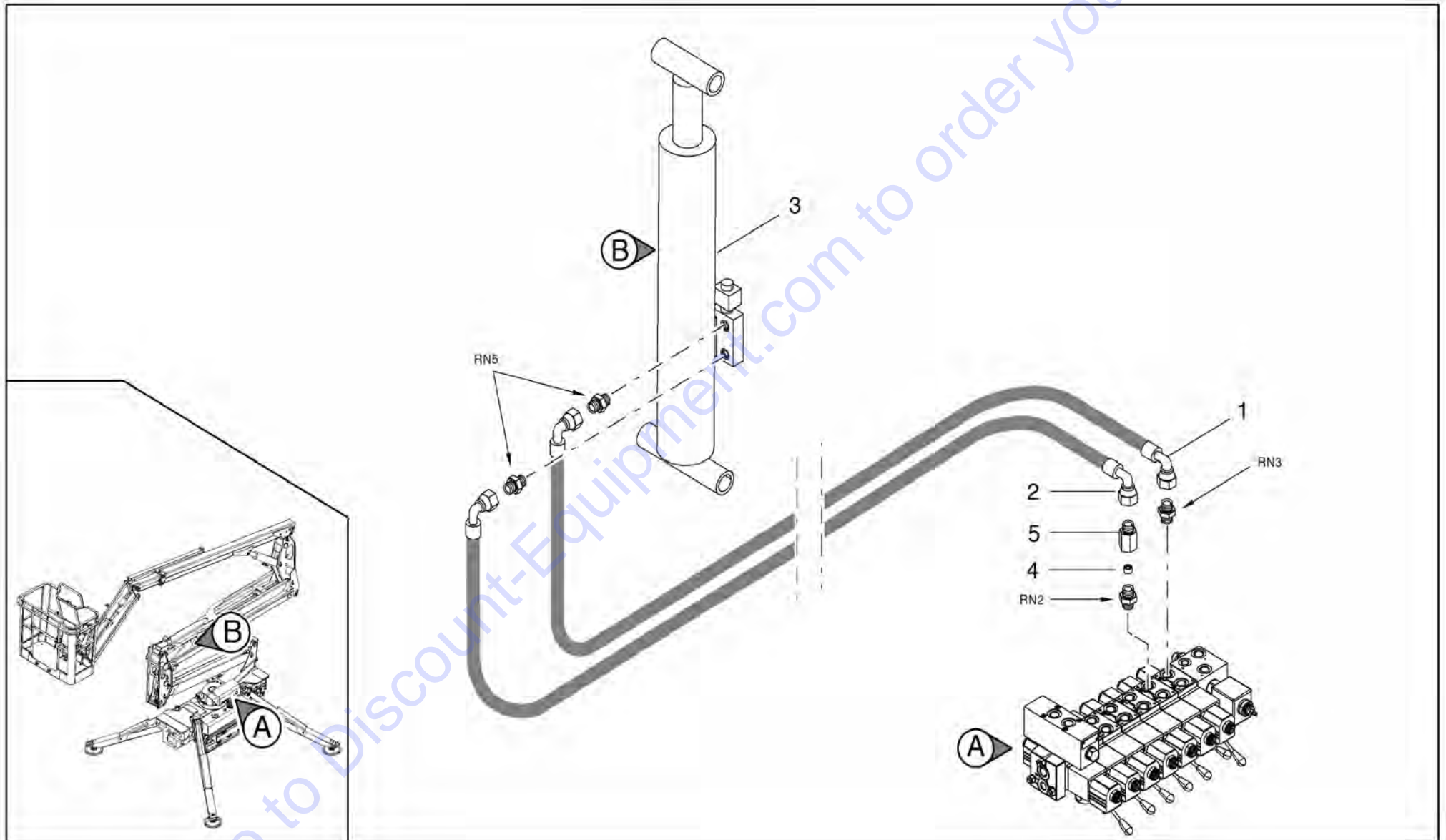

 SYSTÈME HYDRAULIQUE 1-2 BRAS

HYDRAULIKANLAGE 1-2 ARM 

INSTALACIÓN HIDRÁULICA 1-2 BRAZOS 



 IMPIANTO IDRAULICO 1-2 BRACCI
HYDRAULIKANLAGE 1-2 ARM 
 1-2 ARMS HYDRAULIC SYSTEM
INSTALACIÓN HIDRÁULICA 1-2 BRAZOS 
 SYSTÈME HYDRAULIQUE 1-2 BRAS

POS Codice	Q.tà	 Descrizione	 Description	 Designation	 Benennung	 Descripción
1 07303000	1 NR	TUBO FLESSIBILE	FLEXIBLE PIPE	TUYAU FLEXIBLE	SCHLAUCH	TUBO FLEXIBLE
1 07722300	1 NR	TUBO FLESSIBILE MK2 (FROM C170000893)	FLEXIBLE PIPE MK2 (FROM C170000893)	TUYAU FLEXIBLE MK2 (FROM C170000893)	SCHLAUCH MK2 (FROM C170000893)	TUBO FLEXIBLE MK2 (FROM C170000893)
2 07303100	1 NR	TUBO FLESSIBILE	FLEXIBLE PIPE	TUYAU FLEXIBLE	SCHLAUCH	TUBO FLEXIBLE
2 07722400	1 NR	TUBO FLESSIBILE MK2 (FROM C170000893)	FLEXIBLE PIPE MK2 (FROM C170000893)	TUYAU FLEXIBLE MK2 (FROM C170000893)	SCHLAUCH MK2 (FROM C170000893)	TUBO FLEXIBLE MK2 (FROM C170000893)
3 27225900	1 NR	CILINDRO 1° E 2° BRACCIO	FIRST AND SECOND ARM CYLINDER	CYLINDRE 1IER ET 2ÈME BRAS	ZYLINDER 1. U. 2. ARM	CILINDRO PRIMERO Y SEGUNDO BRAZO
3 272259H2	1 NR	CILINDRO 1° E 2° BRACCIO	FIRST AND SECOND ARM CYLINDER	CYLINDRE 1IER ET 2ÈME BRAS	ZYLINDER 1. U. 2. ARM	CILINDRO PRIMERO Y SEGUNDO BRAZO
4 07688500	1 NR	PASTIGLIA VNR STROZZATA 3/8 FORO DA Ø=2MM	VALVE	SOUPAPE	VENTIL	VALVULA
5 07688400	1 NR	RACCORDO PROLUNGA M-F 3/8 H=30 FILETTO UTILE 25	FITTING	RACCORD	ANSCHLUSS	CONEXIÓN

 IMPIANTO IDRAULICO 3 BRACCIO

HYDRAULIKANLAGE 3 ARM 



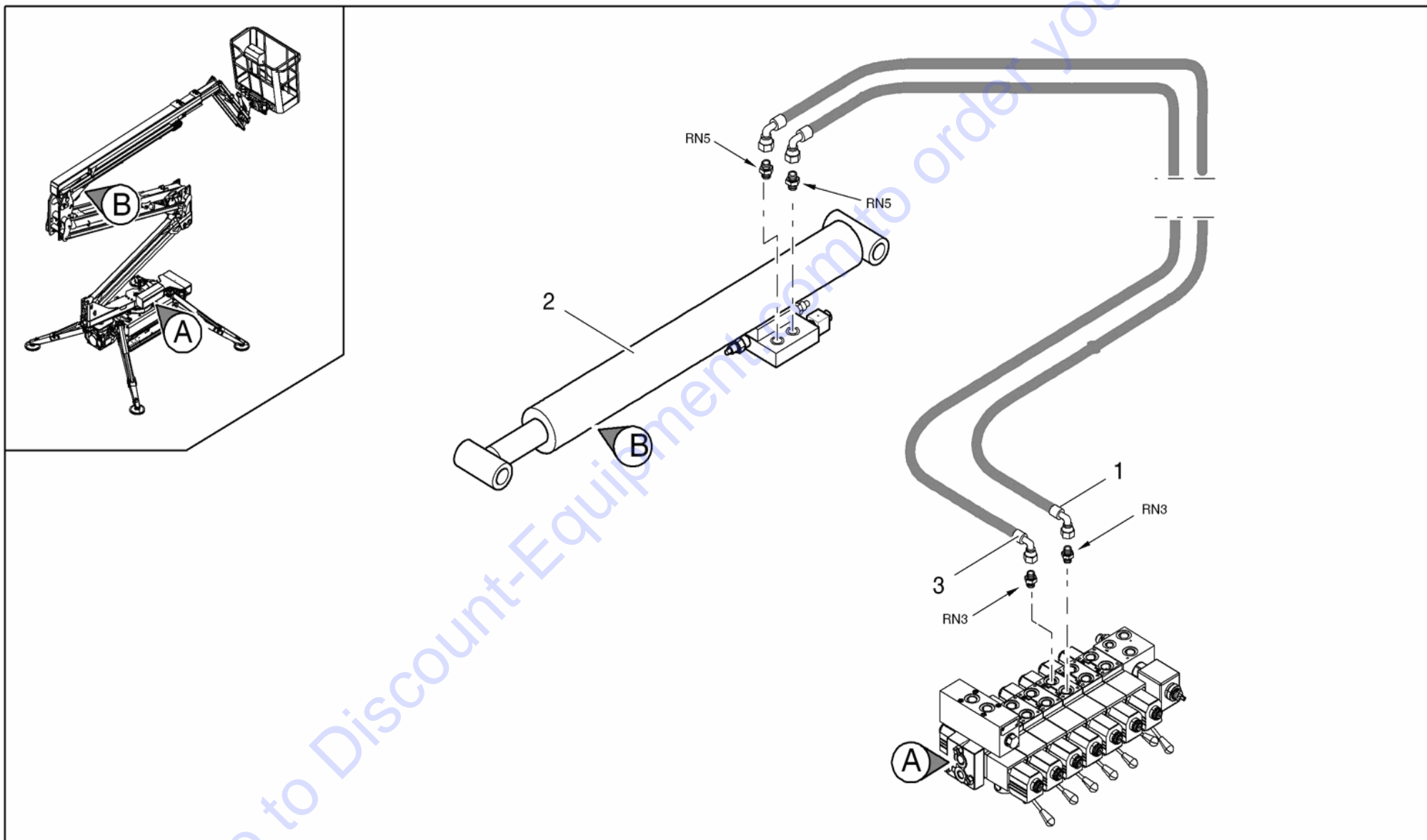

 3 ARM HYDRAULIC SYSTEM

INSTALACIÓN HIDRÁULICA 3 BRAZO 

 SYSTÈME HYDRAULIQUE 3 BRAS



 IMPIANTO IDRAULICO 3 BRACCIO
HYDRAULIKANLAGE 3 ARM 
 3 ARM HYDRAULIC SYSTEM
INSTALACIÓN HIDRÁULICA 3 BRAZO 
 SYSTÈME HYDRAULIQUE 3 BRAS

POS	Codice	Q.tà	 Descrizione	 Description	 Designation	 Benennung	 Descripción
1	07721600	1 NR	TUBO FLESSIBILE MK2 (FROM C170000893)	FLEXIBLE PIPE MK2 (FROM C170000893)	TUYAU FLEXIBLE MK2 (FROM C170000893)	SCHLAUCH MK2 (FROM C170000893)	TUBO FLEXIBLE MK2 (FROM C170000893)
1	07303500	1 NR	TUBO FLESSIBILE	FLEXIBLE PIPE	TUYAU FLEXIBLE	SCHLAUCH	TUBO FLEXIBLE
1	07720600	1 NR	TUBO FLESSIBILE MK2 (FROM C170000893)	FLEXIBLE PIPE MK2 (FROM C170000893)	TUYAU FLEXIBLE MK2 (FROM C170000893)	SCHLAUCH MK2 (FROM C170000893)	TUBO FLEXIBLE MK2 (FROM C170000893)
2	27226000	1 NR	CILINDRO 3° BRACCIO	THIRD ARM CYLINDER	CYLINDRE 3ÈME BRAS	ZYLINDER 3. ARM	CILINDRO 3ER BRAZO
2	272260H2	1 NR	CILINDRO 3° BRACCIO	THIRD ARM CYLINDER	CYLINDRE 3ÈME BRAS	ZYLINDER 3. ARM	CILINDRO 3ER BRAZO
3	07303400	1 NR	TUBO FLESSIBILE	FLEXIBLE PIPE	TUYAU FLEXIBLE	SCHLAUCH	TUBO FLEXIBLE
3	07720500	1 NR	TUBO FLESSIBILE MK2 (FROM C170000893)	FLEXIBLE PIPE MK2 (FROM C170000893)	TUYAU FLEXIBLE MK2 (FROM C170000893)	SCHLAUCH MK2 (FROM C170000893)	TUBO FLEXIBLE MK2 (FROM C170000893)
3	07721500	1 NR	TUBO FLESSIBILE MK2 (FROM C170000893)	FLEXIBLE PIPE MK2 (FROM C170000893)	TUYAU FLEXIBLE MK2 (FROM C170000893)	SCHLAUCH MK2 (FROM C170000893)	TUBO FLEXIBLE MK2 (FROM C170000893)

 IMPIANTO IDRAULICO SFILATO

 TELESCOPIC HYDRAULIC SYSTEM

 TELESCOPIQUE HIDRAULIQUE

TELESKOPHYDRAULIK 



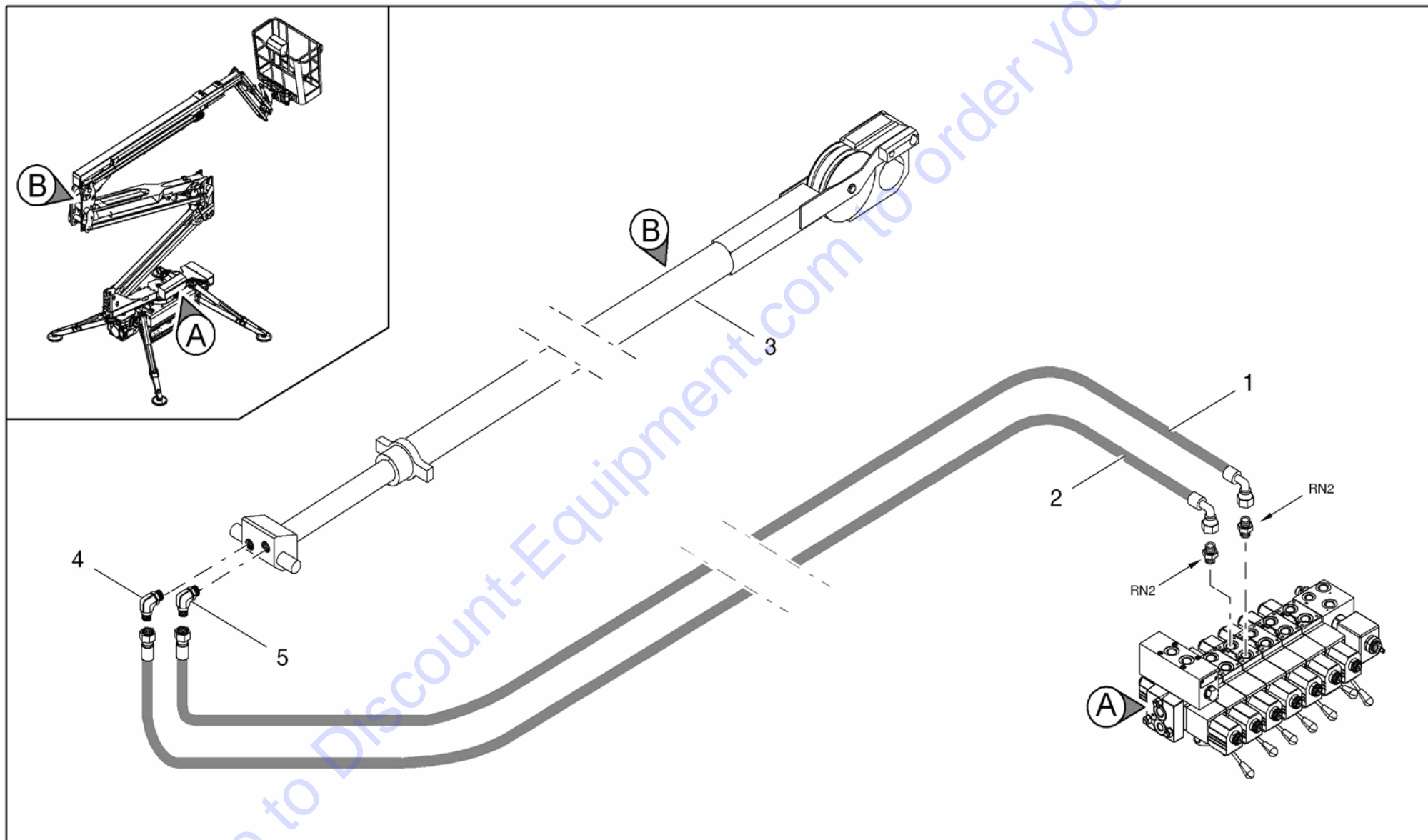

INSTALACIÓN EXTENSIÓN HIDRÁULICA 



 IMPIANTO IDRAULICO SFILO

 TELESKOPHYDRAULIK 
 TELESCOPIC HYDRAULIC SYSTEM

 INSTALACIÓN EXTENSIÓN HIDRÁULICA 
 TELESCOPIQUE HIDRAULIQUE

POS Codice	Q.tà	 Descrizione	 Description	 Designation	 Benennung	 Descripción
1 07304100	1 NR	TUBO FLESSIBILE	FLEXIBLE PIPE	TUYAU FLEXIBLE	SCHLAUCH	TUBO FLEXIBLE
1 07721200	1 NR	TUBO FLESSIBILE MK2 (FROM C170000893)	FLEXIBLE PIPE MK2 (FROM C170000893)	TUYAU FLEXIBLE MK2 (FROM C170000893)	SCHLAUCH MK2 (FROM C170000893)	TUBO FLEXIBLE MK2 (FROM C170000893)
1 07722200	1 NR	TUBO FLESSIBILE MK2 (FROM C170000893)	FLEXIBLE PIPE MK2 (FROM C170000893)	TUYAU FLEXIBLE MK2 (FROM C170000893)	SCHLAUCH MK2 (FROM C170000893)	TUBO FLEXIBLE MK2 (FROM C170000893)
2 07304000	1 NR	TUBO FLESSIBILE	FLEXIBLE PIPE	TUYAU FLEXIBLE	SCHLAUCH	TUBO FLEXIBLE
2 07721100	1 NR	TUBO FLESSIBILE MK2 (FROM C170000893)	FLEXIBLE PIPE MK2 (FROM C170000893)	TUYAU FLEXIBLE MK2 (FROM C170000893)	SCHLAUCH MK2 (FROM C170000893)	TUBO FLEXIBLE MK2 (FROM C170000893)
2 07722100	1 NR	TUBO FLESSIBILE MK2 (FROM C170000893)	FLEXIBLE PIPE MK2 (FROM C170000893)	TUYAU FLEXIBLE MK2 (FROM C170000893)	SCHLAUCH MK2 (FROM C170000893)	TUBO FLEXIBLE MK2 (FROM C170000893)
3 272262H2	1 NR	CILINDRO SFILO	EXTENSION CYLINDER	EXTENSION DU CYLINDRE	ZYLINDERVERLÄ NGERUNG	EXTENSION DE CILINDRO
4 04995000	1 NR	RACCORDO	FITTING	RACCORD	ANSCHLUSS	CONEXIÓN
5 05510300	1 NR	CURVA	CURVE	COURBE	KURVE	CURVA

 IMPIANTO JIB

 JIB HYDRAULIC SYSTEM

 SYSTÈME HYDRAULIQUE JIB

ZYLINDER JIB ARM 

INSTALACIÓN HIDRÁULICA JIB 

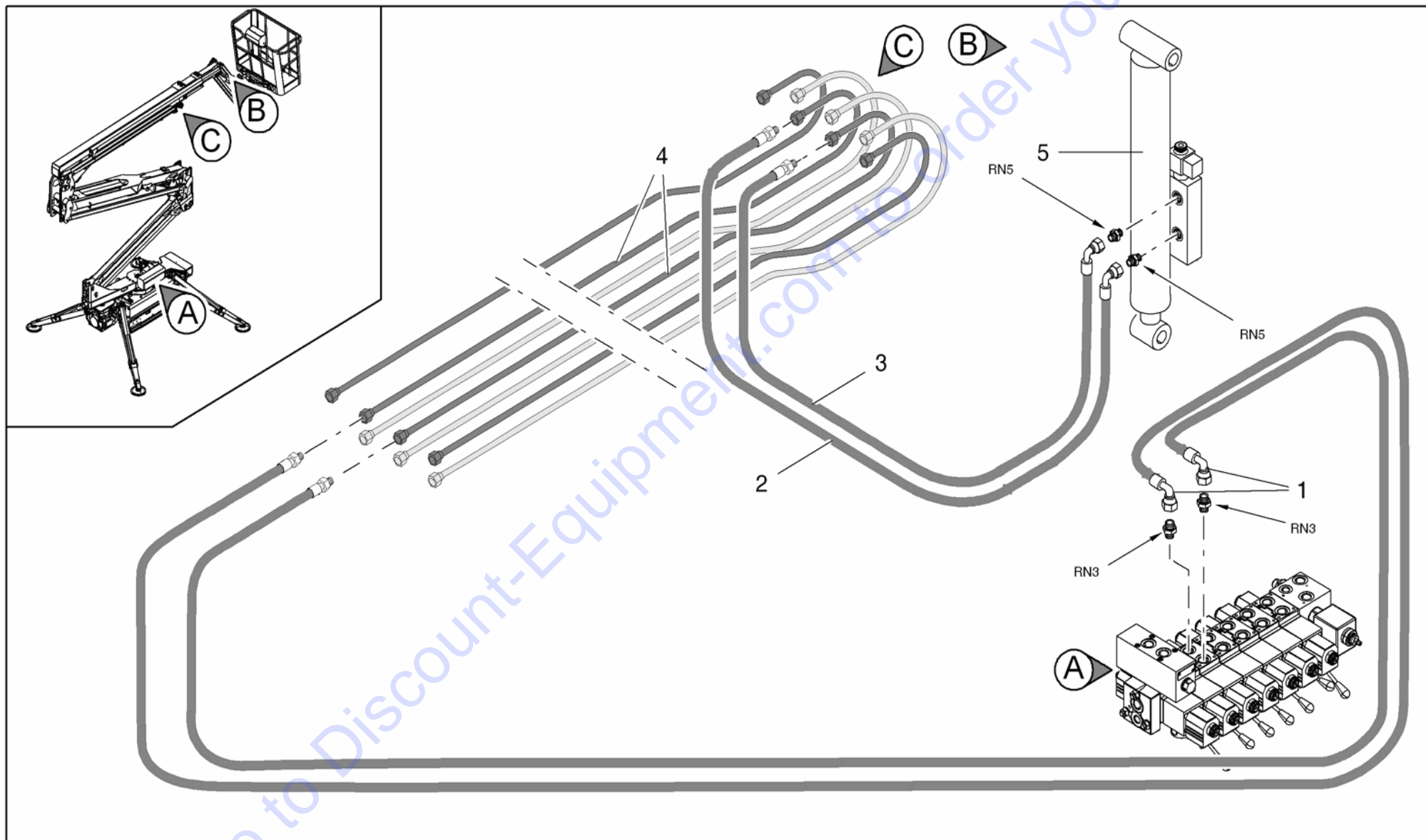







 IMPIANTO JIB

 ZYLINDER JIB ARM

 JIB HYDRAULIC SYSTEM

 INSTALACIÓN HIDRÁULICA JIB

 SYSTÈME HYDRAULIQUE JIB

POS Codice	Q.tà	 Descrizione	 Description	 Designation	 Benennung	 Descripcìon
1 07303700	2 NR	TUBO FLESSIBILE	FLEXIBLE PIPE	TUYAU FLEXIBLE	SCHLAUCH	TUBO FLEXIBLE
1 07720700	2 NR	TUBO FLESSIBILE MK2 (FROM C170000893)	FLEXIBLE PIPE MK2 (FROM C170000893)	TUYAU FLEXIBLE MK2 (FROM C170000893)	SCHLAUCH MK2 (FROM C170000893)	TUBO FLEXIBLE MK2 (FROM C170000893)
1 07721700	2 NR	TUBO FLESSIBILE MK2 (FROM C170000893)	FLEXIBLE PIPE MK2 (FROM C170000893)	TUYAU FLEXIBLE MK2 (FROM C170000893)	SCHLAUCH MK2 (FROM C170000893)	TUBO FLEXIBLE MK2 (FROM C170000893)
2 07304300	1 NR	TUBO FLESSIBILE	FLEXIBLE PIPE	TUYAU FLEXIBLE	SCHLAUCH	TUBO FLEXIBLE
3 07304200	1 NR	TUBO FLESSIBILE	FLEXIBLE PIPE	TUYAU FLEXIBLE	SCHLAUCH	TUBO FLEXIBLE
4 07266700	2 NR	TUBO RIGIDO	RIGID PIPE	TUYAU RIGIDE	ROHR	TUBO RÍGIDO
5 27069500	1 NR	CILINDRO JIB	JIB CYLINDER	CYLINDRE SECT.TÉLESCOP	TELESKOPZYLIN DER	CIL. BRAZO TELESCÓP.
5 270695H2	1 NR	CILINDRO JIB	JIB CYLINDER	CYLINDRE JIB	KORBARMZYLIND ER	CILINDRO JIB

 IMPIANTO IDRAULICO LIVELLAMENTO

 LEVELING CYLINDERS HYDRAULIC SYSTEM

 SYSTÈME HYDRAULIQUE CYLINDRES BRAS

HYDRAULIKANLAGE ZYLINDER ARM 



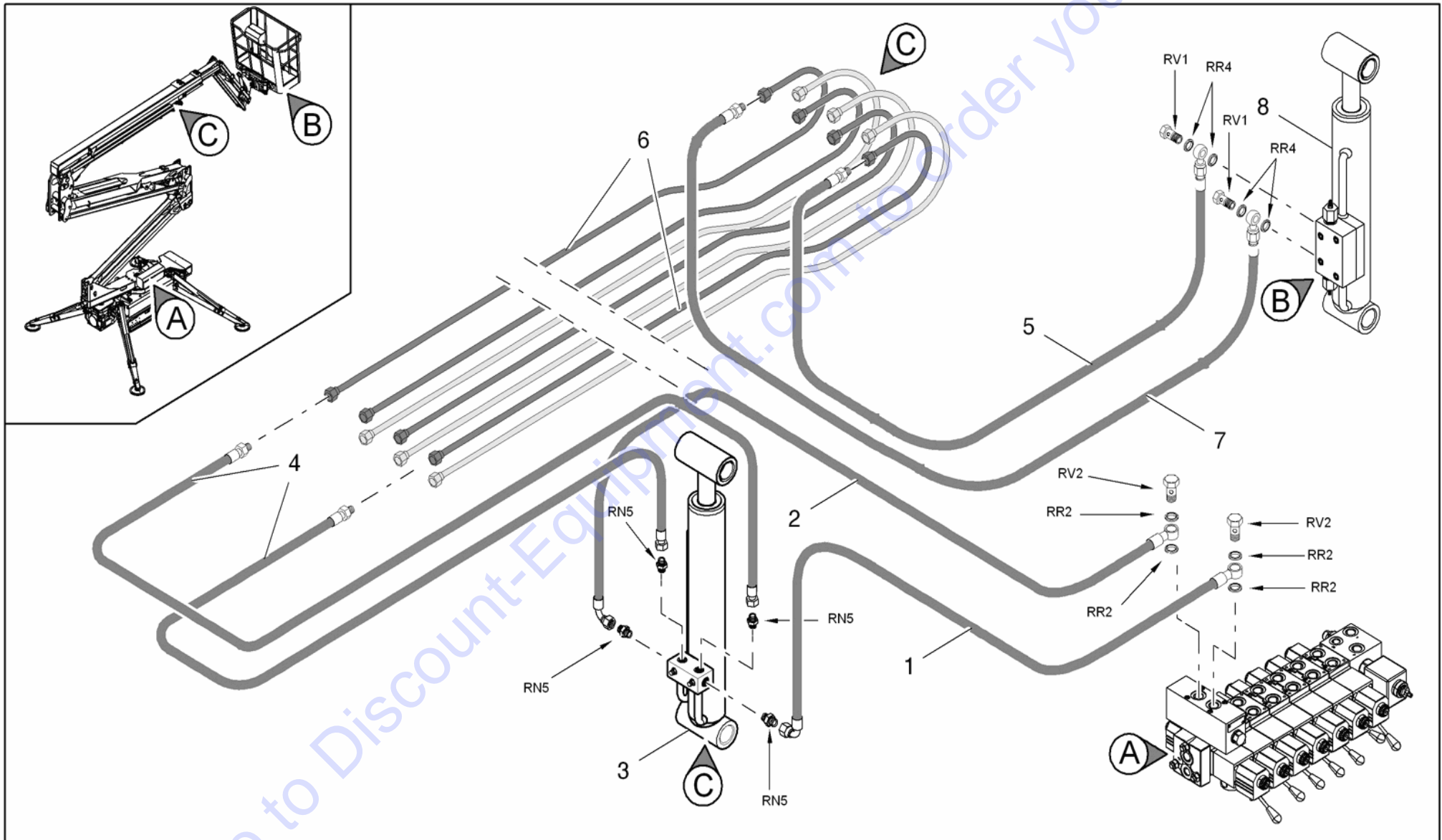

INSTALACIÓN HIDRÁULICA CILINDROS BRAZOS 



 IMPIANTO IDRAULICO LIVELLAMENTO

 HYDRAULIKANLAGE ZYLINDER ARM 
 LEVELING CYLINDERS HYDRAULIC SYSTEM

 INSTALACIÓN HIDRÁULICA CILINDROS BRAZOS 
 SYSTÈME HYDRAULIQUE CYLINDRES BRAS

POS Codice	Q.tà	 Descrizione	 Description	 Designation	 Benennung	 Descripción
1 07303200	1 NR	TUBO FLESSIBILE	FLEXIBLE PIPE	TUYAU FLEXIBLE	SCHLAUCH	TUBO FLEXIBLE
1 07720300	1 NR	TUBO FLESSIBILE MK2 (FROM C170000893)	FLEXIBLE PIPE MK2 (FROM C170000893)	TUYAU FLEXIBLE MK2 (FROM C170000893)	SCHLAUCH MK2 (FROM C170000893)	TUBO FLEXIBLE MK2 (FROM C170000893)
1 07721300	1 NR	TUBO FLESSIBILE MK2 (FROM C170000893)	FLEXIBLE PIPE MK2 (FROM C170000893)	TUYAU FLEXIBLE MK2 (FROM C170000893)	SCHLAUCH MK2 (FROM C170000893)	TUBO FLEXIBLE MK2 (FROM C170000893)
2 07303300	1 NR	TUBO FLESSIBILE	FLEXIBLE PIPE	TUYAU FLEXIBLE	SCHLAUCH	TUBO FLEXIBLE
2 07720400	1 NR	TUBO FLESSIBILE MK2 (FROM C170000893)	FLEXIBLE PIPE MK2 (FROM C170000893)	TUYAU FLEXIBLE MK2 (FROM C170000893)	SCHLAUCH MK2 (FROM C170000893)	TUBO FLEXIBLE MK2 (FROM C170000893)
2 07721400	1 NR	TUBO FLESSIBILE MK2 (FROM C170000893)	FLEXIBLE PIPE MK2 (FROM C170000893)	TUYAU FLEXIBLE MK2 (FROM C170000893)	SCHLAUCH MK2 (FROM C170000893)	TUBO FLEXIBLE MK2 (FROM C170000893)
3 27069300	1 NR	CILINDRO LIVELLAMENTO CESTO	LEVELLING CYLINDER	CYLINDRE SECT.TÉLESCOP	TELESKOPZYLIN DER	CIL. BRAZO TELESCÓP.
3 270693H2	1 NR	CILINDRO LIVELLAMENTO CESTO	BASKET LEVELLING CYLINDER	CYLINDRE NIVELLEMENT PANIER	ZYLINDER KORBNIVELLIERU NG	CILINDRO NIVELACIÓN CESTA
4 07303600	2 NR	TUBO FLESSIBILE	FLEXIBLE PIPE	TUYAU FLEXIBLE	SCHLAUCH	TUBO FLEXIBLE
5 07304500	1 NR	TUBO FLESSIBILE	FLEXIBLE PIPE	TUYAU FLEXIBLE	SCHLAUCH	TUBO FLEXIBLE
6 07266600	2 NR	TUBO RIGIDO	RIGID PIPE	TUYAU RIGIDE	ROHR	TUBO RÍGIDO





 IMPIANTO IDRAULICO LIVELLAMENTO

HYDRAULIKANLAGE ZYLINDER ARM 

 LEVELING CYLINDERS HYDRAULIC SYSTEM

INSTALACIÓN HIDRÁULICA CILINDROS BRAZOS 

 SYSTÈME HYDRAULIQUE CYLINDRES BRAS

POS Codice	Q.tà	 Descrizione	 Description	 Designation	 Benennung	 Descripción
7 07304400	1 NR	TUBO FLESSIBILE	FLEXIBLE PIPE	TUYAU FLEXIBLE	SCHLAUCH	TUBO FLEXIBLE
8 27315100	1 NR	CILINDRO LIVELLAMENTO CESTO SU CESTO	LEVELING CYLINDER BASKET ON BASKET	CYLINDRE SUR LEVEL BASKET BASKET	NIVELLIERZYLIND ER	CILINDRO DE NIVEL DE BASKET BASKET
8 273151H2	1 NR	CILINDRO LIVELLAMENTO CESTO SU CESTO	LEVELING CYLINDER BASKET ON BASKET	CYLINDRE NIVELLEMENT PANIER SUR PANIER	ZYLINDER KORBNIVELLIERU NG	CILINDRO NIVELACIÓN CESTA

Go to Discount-Equipment.com to Order your Parts

# PARTS FINDER

**Search Website  
by Part Number**



**Search Manual  
Library For Parts  
Manual & Lookup Part  
Numbers – Purchase  
or Request Quote**

**Search Manuals**

Enter your information to help us find the right parts manual for your machine.

\* Brand:

\* Model:

\* Serial:

\* Part Number:

SEARCH

**Can't Find Part or  
Manual? Request Help  
by Manufacturer,  
Model & Description**

**Parts Order Form**

Please fill in the following information to help us find the right part for your machine.

Manufacturer:	<input type="text"/>
Model:	<input type="text"/>
Description:	<input type="text"/>
Part Number:	<input type="text"/>
Quantity:	<input type="text"/>
Notes:	<input type="text"/>

Submit

Discount-Equipment.com is your online resource for quality parts & equipment.

Florida: **561-964-4949** Outside Florida TOLL FREE: **877-690-3101**

**Need parts?**

Click on this link: <http://www.discount-equipment.com/category/5443-parts/> and choose one of the options to help get the right parts and equipment you are looking for. Please have the machine model and serial number available in order to help us get you the correct parts. If you don't find the part on the website or on one of the online manuals, please fill out the request form and one of our experienced staff members will get back to you with a quote for the right part that your machine needs.

We sell worldwide for the brands: Genie, Terex, JLG, MultiQuip, Mikasa, Essick, Whiteman, Mayco, Toro Stone, Diamond Products, Generac Magnum, Airman, Haulotte, Barreto, Power Blanket, Nifty Lift, Atlas Copco, Chicago Pneumatic, Allmand, Miller Curber, Skyjack, Lull, Skytrak, Tsurumi, Husquvarna Target, Stow, Wacker, Sakai, Mi-T-M, Sullair, Basic, Dynapac, MBW, Weber, Bartell, Bennar Newman, Haulotte, Ditch Runner, Menegotti, Morrison, Contec, Buddy, Crown, Edco, Wyco, Bomag, Laymor, EZ Trench, Bil-Jax, F.S. Curtis, Gehl Pavers, Heli, Honda, ICS/PowerGrit, IHI, Partner, Imer, Clipper, MMD, Koshin, Rice, CH&E, General Equipment, Amida, Coleman, NAC, Gradall, Square Shooter, Kent, Stanley, Tamco, Toku, Hatz, Kohler, Robin, Wisconsin, Northrock, Oztec, Toker TK, Rol-Air, APT, Wylie, Ingersoll Rand / Doosan, Innovatech, Con X, Ammann, Mecalac, Makinex, Smith Surface Prep, Small Line, Wanco, Yanmar

 IMPIANTO IDRAULICO ROTAZIONE CESTO

 CAGE ROTATION HYDRAULIC SYSTEM

 SYSTÈME HYDRAULIQUE ROTATION PANIER

HYDRAULIKANLAGE KORBSCHWENKUNG 

INSTALACIÓN HIDRÁULICA ROTACIÓN CESTA 

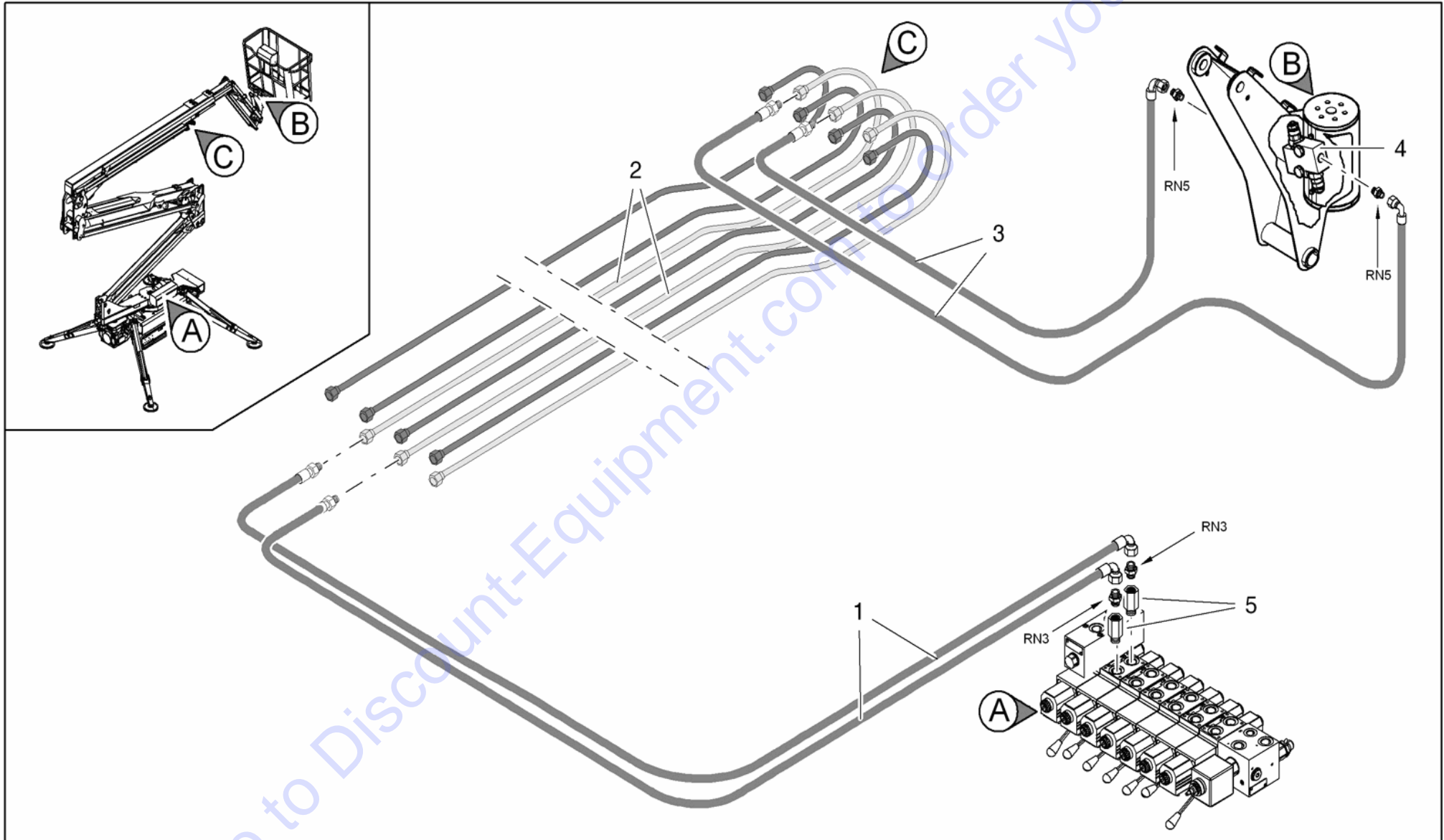





 IMPIANTO IDRAULICO ROTAZIONE CESTO

 HYDRAULIKANLAGE KORBSCHWENKUNG

 CAGE ROTATION HYDRAULIC SYSTEM

 INSTALACIÓN HIDRÁULICA ROTACIÓN CESTA

 SYSTÈME HYDRAULIQUE ROTATION PANIER

POS	Codice	Q.tà	 Descrizione	 Description	 Designation	 Benennung	 Descripción
1	07303800	2 NR	TUBO FLESSIBILE	FLEXIBLE PIPE	TUYAU FLEXIBLE	SCHLAUCH	TUBO FLEXIBLE
1	07720800	1 NR	TUBO FLESSIBILE MK2 (FROM C170000893)	FLEXIBLE PIPE MK2 (FROM C170000893)	TUYAU FLEXIBLE MK2 (FROM C170000893)	SCHLAUCH MK2 (FROM C170000893)	TUBO FLEXIBLE MK2 (FROM C170000893)
1	07720900	1 NR	TUBO FLESSIBILE MK2 (FROM C170000893)	FLEXIBLE PIPE MK2 (FROM C170000893)	TUYAU FLEXIBLE MK2 (FROM C170000893)	SCHLAUCH MK2 (FROM C170000893)	TUBO FLEXIBLE MK2 (FROM C170000893)
1	07721800	1 NR	TUBO FLESSIBILE MK2 (FROM C170000893)	FLEXIBLE PIPE MK2 (FROM C170000893)	TUYAU FLEXIBLE MK2 (FROM C170000893)	SCHLAUCH MK2 (FROM C170000893)	TUBO FLEXIBLE MK2 (FROM C170000893)
1	07721900	1 NR	TUBO FLESSIBILE MK2 (FROM C170000893)	FLEXIBLE PIPE MK2 (FROM C170000893)	TUYAU FLEXIBLE MK2 (FROM C170000893)	SCHLAUCH MK2 (FROM C170000893)	TUBO FLEXIBLE MK2 (FROM C170000893)
2	07266800	2 NR	TUBO RIGIDO	RIGID PIPE	TUYAU RIGIDE	ROHR	TUBO RÍGIDO
3	07304600	2 NR	TUBO FLESSIBILE	FLEXIBLE PIPE	TUYAU FLEXIBLE	SCHLAUCH	TUBO FLEXIBLE
4	2648910001	1 NR	VALVOLA IDRAULICA	HYDRAULIC VALVE	VALVE HYDRAULIQUE	HYDRAULIKVENTI L	VÁLVULA HIDRÁULICA
5	03149500	2 NR	RACCORDO A COLONNA 3/8" H=20	EXTENSION 3/8" H=20	RACCORD	ANSCHLUSS	CONEXIÓN

 IMPIANTO IDRAULICO ARIA COMPRESSA

 COMPRESSED AIR HYDRAULIC SYSTEM

 SYSTÈME HYDRAULIQUE AIR COMPRIMÉ

HYDRAULIKANLAGE DRUCKLUFT 

INSTALACIÓN HIDRÁULICA AIRE COMPRIMIDO 

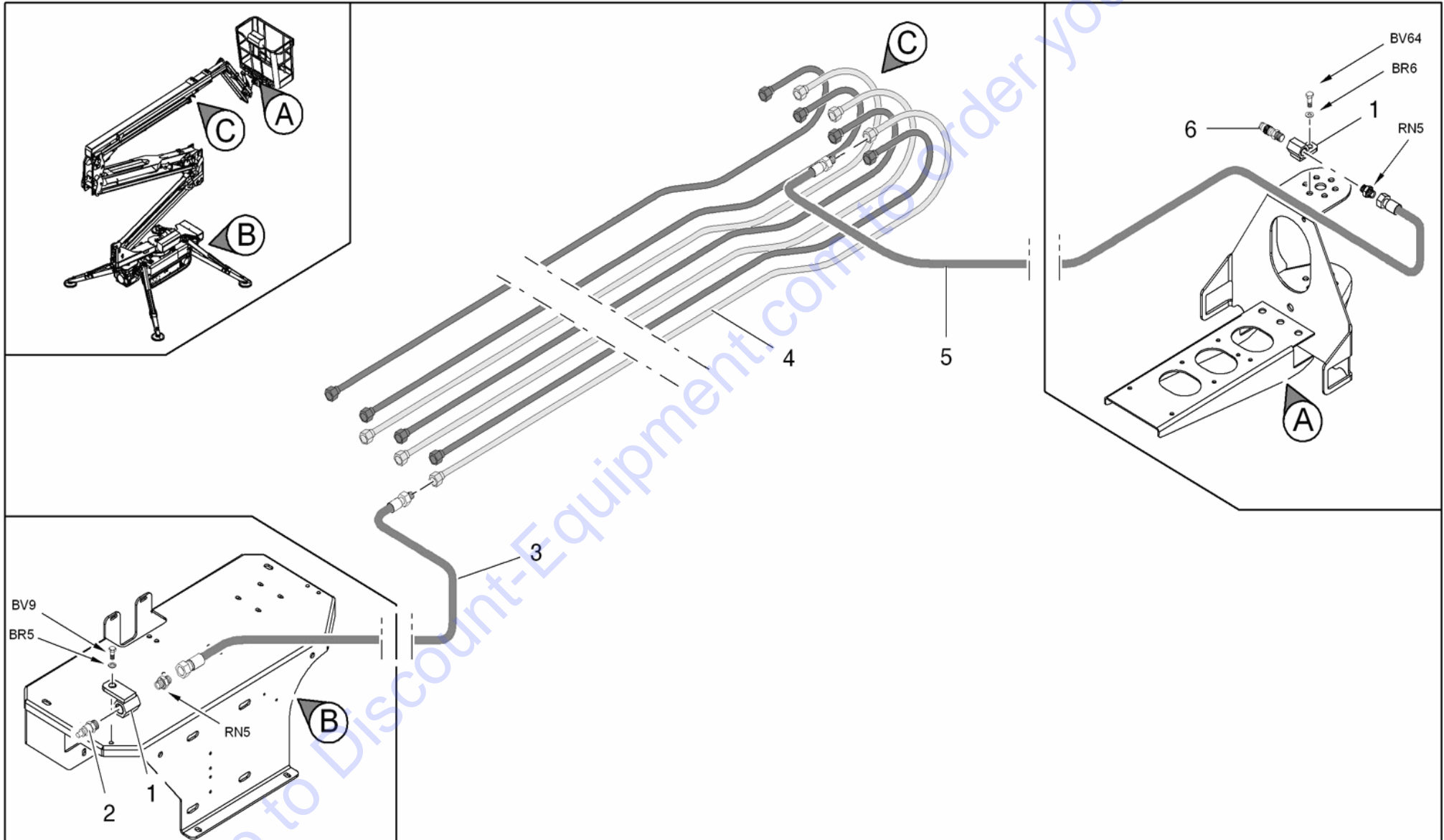







 IMPIANTO IDRAULICO ARIA COMPRESSA

HYDRAULIKANLAGE DRUCKLUFT 

 COMPRESSED AIR HYDRAULIC SYSTEM

INSTALACIÓN HIDRÁULICA AIRE COMPRIMIDO 

 SYSTÈME HYDRAULIQUE AIR COMPRIMÉ

POS Codice	Q.tà	 Descrizione	 Description	 Designation	 Benennung	 Descripcìon
1 04845100	1 NR	SUPPORTO	SUPPORT	SUPPORT	HALTERUNG	SOPORTE
2 05509900	1 NR	INNESTO RAPIDO	QUICK COUPLING	RACCORD RAPIDE	SCHNELLKUPPLUNG	CONEXIÓN RÁPIDA
3 07303900	1 NR	TUBO FLESSIBILE	FLEXIBLE PIPE	TUYAU FLEXIBLE	SCHLAUCH	TUBO FLEXIBLE
3 07721000	1 NR	TUBO FLESSIBILE MK2 (FROM C170000893)	FLEXIBLE PIPE MK2 (FROM C170000893)	TUYAU FLEXIBLE MK2 (FROM C170000893)	SCHLAUCH MK2 (FROM C170000893)	TUBO FLEXIBLE MK2 (FROM C170000893)
3 07722000	1 NR	TUBO FLESSIBILE MK2 (FROM C170000893)	FLEXIBLE PIPE MK2 (FROM C170000893)	TUYAU FLEXIBLE MK2 (FROM C170000893)	SCHLAUCH MK2 (FROM C170000893)	TUBO FLEXIBLE MK2 (FROM C170000893)
4 07266900	1 NR	TUBO RIGIDO	RIGID PIPE	TUYAU RIGIDE	ROHR	TUBO RÍGIDO
5 07304700	1 NR	TUBO FLESSIBILE	FLEXIBLE PIPE	TUYAU FLEXIBLE	SCHLAUCH	TUBO FLEXIBLE
6 05580200	1 NR	RUBINETTO	FAUCET	ROBINET	WASSERHAHN	GRIFO

 CILINDRI

 CYLINDERS

 CYLINDRES

ZYLINDER 

CILINDROS 

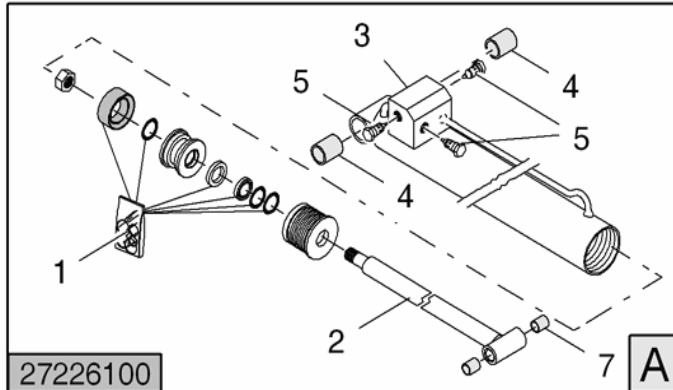

27226100

A

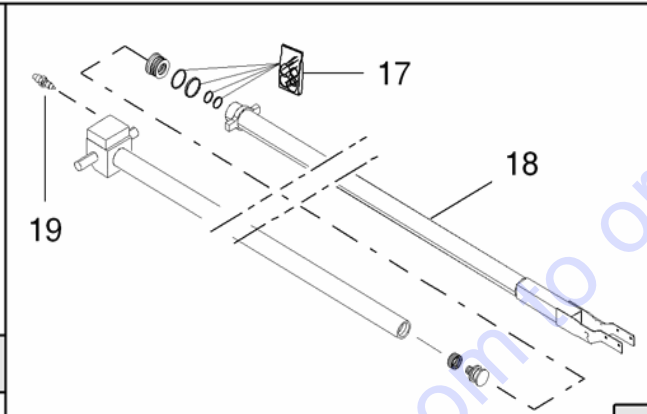

27226200

D

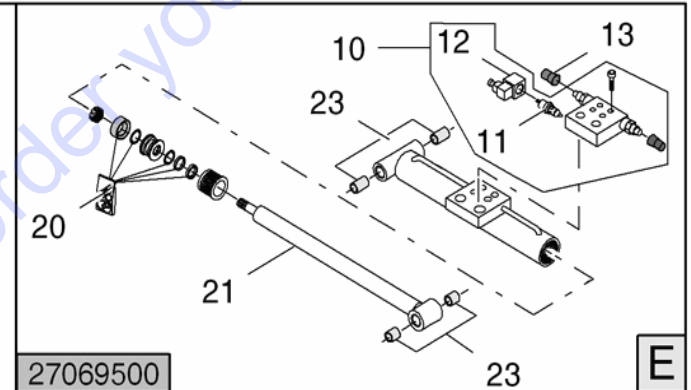

27069500

E

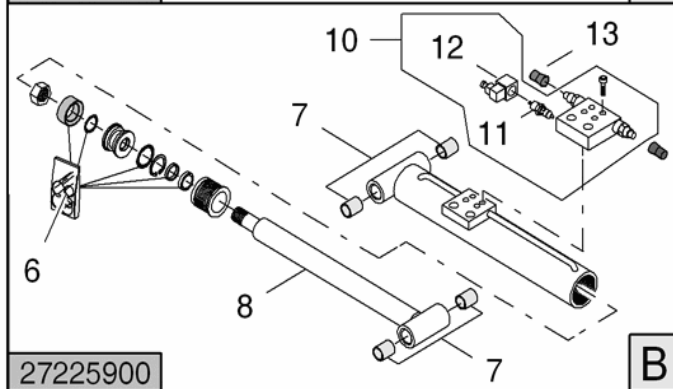

27225900

B

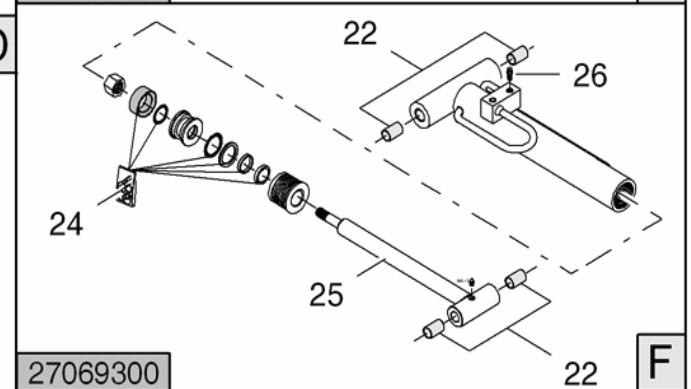
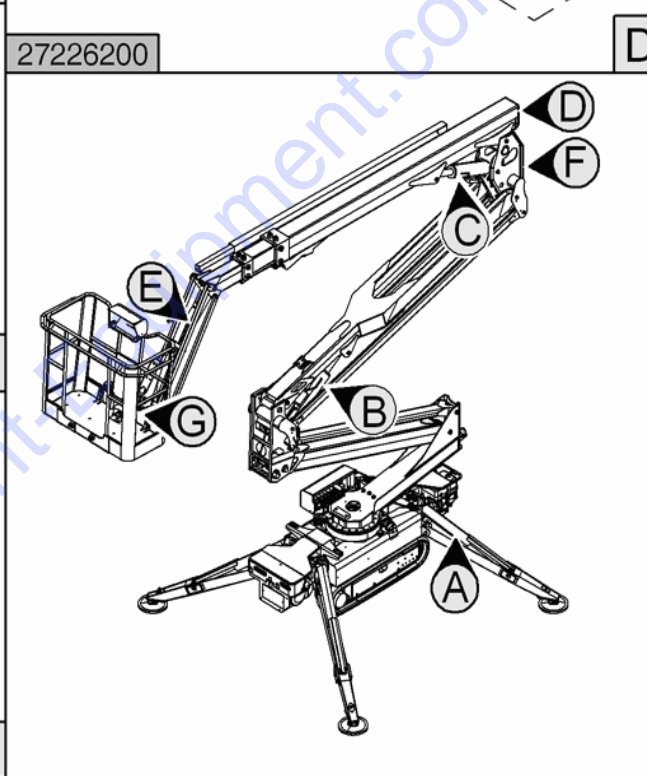

27069300

F

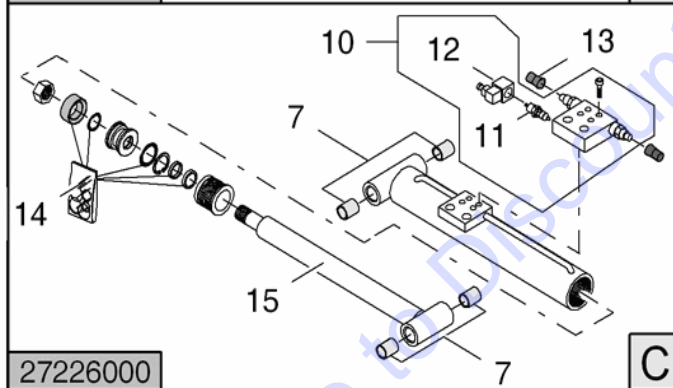

27226000



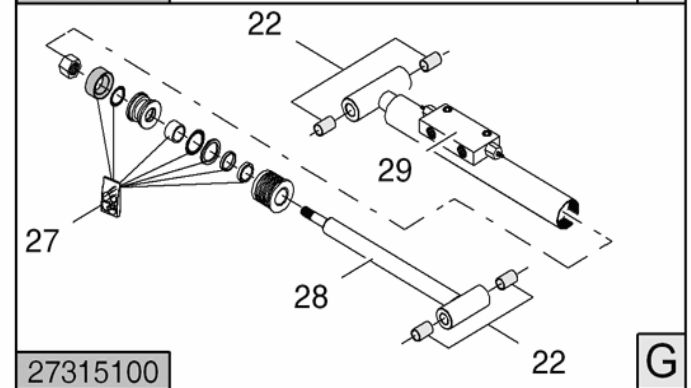

C



27315100

G





 CILINDRIZYLINDER  CYLINDERSCILINDROS  CYLINDRES

POS Codice	Q.tà	 Descrizione	 Description	 Designation	 Benennung	 Descripción
1 2722610001	1 NR	KIT GUARNIZIONI	GASKET KIT	KIT JOINTS	DICHTUNGSSATZ	KIT GUARNICIÓNES
2 2722610002	1 NR	STELO	ROD	TIGE	SCHAFT	VÁSTAGO
3 2705540002	1 NR	BLOCCHETTO	BLOCK	BLOC	BLOCK	BLOQUE
4 2627880005	4 NR	BOCCOLA	BUSH	DOUILLE	BUCHSE	CASQUILLO
5 1541150011	3 NR	VALVOLA IDRAULICA	HYDRAULIC VALVE	VALVE HYDRAULIQUE	HYDRAULIKVENTIL	VÁLVULA HIDRÁULICA
6 2722590001	1 NR	KIT GUARNIZIONI	GASKET KIT	KIT JOINTS	DICHTUNGSSATZ	KIT GUARNICIÓNES
7 2644250003	4 NR	BOCCOLA	BUSH	DOUILLE	BUCHSE	CASQUILLO
8 2722590002	1 NR	STELO	ROD	TIGE	SCHAFT	VÁSTAGO
10 26119300	1 NR	VALVOLA IDRAULICA	HYDRAULIC VALVE	VALVE HYDRAULIQUE	HYDRAULIKVENTIL	VÁLVULA HIDRÁULICA
11 0552550001	1 NR	ELETTROVALVOLA	SOLENOID VALVE	ÉLECTROVANNE	MAGNETVENTIL	ELECTROVÁLVULA
12 0552550003	1 NR	BOBINA	COIL	BOBINE	SPULE	BOBINA
13 05576200	6 NR	PROTEZIONE	PROTECTION	PROTECTION	SCHUTZ	PROTECCIÓN
14 2722600001	1 NR	KIT GUARNIZIONI	GASKET KIT	KIT JOINTS	DICHTUNGSSATZ	KIT GUARNICIÓNES
15 2722600002	1 NR	STELO	ROD	TIGE	SCHAFT	VÁSTAGO

 CILINDRI

 ZYLINDER 
 CYLINDERS





 CILINDROS 
 CYLINDRES

POS Codice	Q.tà	 Descrizione	 Description	 Designation	 Benennung	 Descripción
17 2722620001	1 NR	KIT GUARNIZIONI	GASKET KIT	KIT JOINTS	DICHTUNGSSATZ	KIT GUARNICIONES
18 2722620002	1 NR	STELO	ROD	TIGE	SCHAFT	VÁSTAGO
19 2706900003	1 NR	BLOCCO VALVOLA RIGENERATRICE CILINDRO SFILO	CYLINDER VALVE EXTENSION REGENERATIVE	SERRURE A CYLINDRE REGENERATIVE EXTENSION VALVE	SCHLIESSZYLINDER VALVE EXTENSION REGENERATIVE	QUEO DEL CILINDRO DE EXTENSIÓN DE LA VÁLVULA REGENERATIVA
20 2706950001	1 NR	KIT GUARNIZIONI CILINDRO JIB	SEAL KIT CYLINDER JIB	KIT DE JOINTS	DICHTUNGSSATZ	KIT JUNTAS CILINDRO JIB
21 2706950002	1 NR	STELO CILINDRO JIB	ROD CYLINDER JIB	TIGE DE CYLINDRE JIB	KORBARM ZYLINDERSCHAFT	VASTAGO CILINDRO JIB
22 2627890006	4 NR	BOCCOLA	BUSH	DOUILLE	BUCHSE	CASQUILLO
23 2627910006	4 NR	BOCCOLA	BUSH	DOUILLE	BUCHSE	CASQUILLO
24 2706930001	1 NR	KIT GUARNIZIONI CILINDRO LIVELLAMENTO SU RINVIO	CYLINDER GASKET KIT	KIT DE JOINTS CYLINDRE NIVELLEMENT	DICHTSATZ ZYLINDER AUSNIVELLIERUNG	KIT DE JUNTAS CILINDRO NIVELACIÓN
25 2706930002	1 NR	STELO CILINDRO LIVELLAMENTO SU RINVIO	ROD CYLINDER	TIGE CYLINDRE	ZYLINDERSCHAFT	VASTAGO CILINDRO
26 2588290008	2 NR	VITE	SCREW	VIS	SCHRAUBE	TORNILLO

 CILINDRI

 ZYLINDER 
 CYLINDERS

 CILINDROS 
 CYLINDRES

POS Codice	Q.tà	 Descrizione	 Description	 Designation	 Benennung	 Descripcìon
27 2706940001	1 NR	KIT GUARNIZIONI CILINDRO LIVELLAMENTO SU CESTO	CYLINDER GASKET KIT	KIT DE JOINTS CYLINDRE NIVELLEMENT	DICHTSATZ	KIT JUNTAS
28 2706940002	1 NR	STELO CILINDRO LIVELLAMENTO SU CESTO	BASKET LEVELING CYLINDER ROD ON BASKET	CYLINDRE TIGE	ZYLINDERSCHAF T	VASTAGO CILINDRO
29 2731510003	1 NR	VALVOLA IDRAULICA	HYDRAULIC VALVE	VALVE HYDRAULIQUE	HYDRAULIKVENTI L	VÁLVULA HIDRÁULICA

Go to Discount-Equipment.com to order your parts

 COMPONENTI IMPIANTO ELETTRICO

KOMPONENTEN ELEKTROANLAGE 

 ELECTRICAL SYSTEM COMPONENTS

COMPONENTES INSTALACIÓN ELÉCTRICA 

 COMPOSANTS INSTALLATION ÉLECTRIQUE

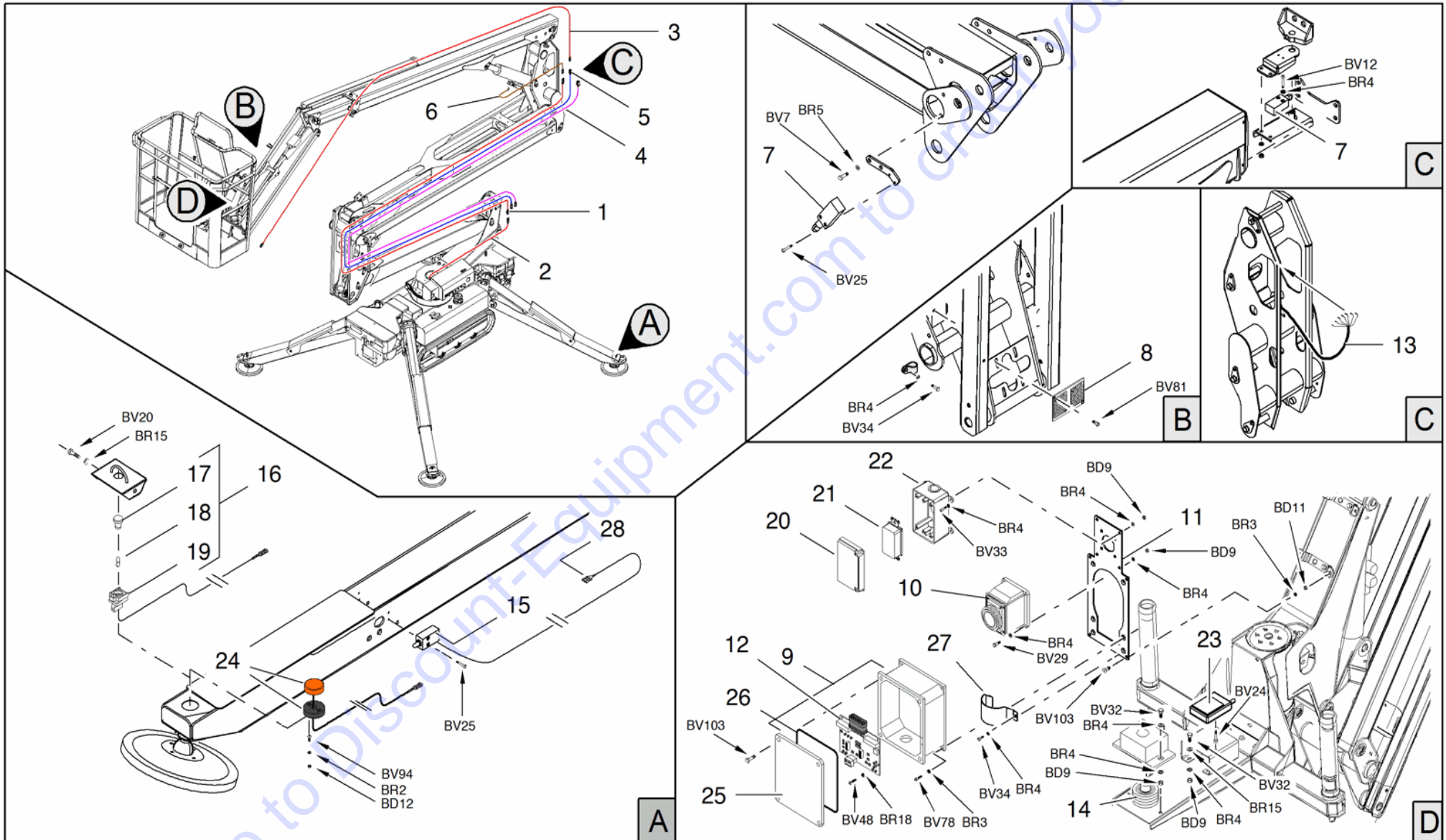





 COMPONENTI IMPIANTO ELETTRICO

 KOMponenten ELEKTROANLAGE

 ELECTRICAL SYSTEM COMPONENTS

 COMPONENTES INSTALACIÓN ELÉCTRICA

 COMPOSANTS INSTALLATION ÉLECTRIQUE

POS Codice	Q.tà	 Descrizione	 Description	 Designation	 Benennung	 Descripción
1 1764290001	1 NR	CAVO PROLUNGA 220-110V DA PRIMO BRACCIO A 3 BRACCIO MK2 (DA C170000893)	EXTENSION CABLE 220V-110V FROM 1 BOOM TO 3 BOOM MK2 (FROM C170000893)			
2 1764290002	1 NR	CAVO PROLUNGA 220-110V DA BASE A PRIMO BRACCIO MK2 (DA C170000893)	EXTENSION CABLE 220V-110V FROM BASE TO 1 BOOM MK2 (FROM C170000893)			
3 1764300001	1 NR	CAVO PROLUNGA 220-110V SFILO MK2 (DA C170000893)	EXTENSION CABLE 220V-110V EXTENSION BOOM MK2 (FROM C170000893)			
4 1764300002	1 NR	CAVO PROLUNGA 7POLI DA 1 BRACCIO A 3 BRACCIO MK2 (DA C170000893)	EXTENSION CABLE 7WAY FROM 1 BOOM TO 3 BOOM MK2 (FROM C170000893)			





 COMPONENTI IMPIANTO ELETTRICO

 KOMponenten ELEKTROANLAGE

 ELECTRICAL SYSTEM COMPONENTS

 COMPONENTES INSTALACIÓN ELÉCTRICA

 COMPOSANTS INSTALLATION ÉLECTRIQUE

POS Codice	Q.tà	 Descrizione	 Description	 Designation	 Benennung	 Descripción
5 1764300003	1 NR	CAVO PROLUNGA DISCESA DI EMERGENZA DA 1 BRACCIO A 3 BRACCIO MK2 (DA C170000893)	EXTENSION CABLE EMERGENCY LOWER FROM 1 BOOM TO 3 BOOM MK2 (FROM C170000893)			
6 1730720094	1 NR	CAVO COMPLETO PER SENSORE DI POSIZIONE 3 CILINDRO BRACCIO	CABLE ASSEMBLY FOR POSITION SENSOR 3 BOOM CYLINDER	CÂBLE COMPLET POUR CAPTEUR DE POSITION 3° CYLINDRE BRAS	KABEL KOMPLETT FÜR POSITIONSENS OR 3. AUSLEGERARM-Z YLINDER	CABLE COMPLETO PARA SENSOR DE POSICIÓN 3ERO CILINDRO BRAZO
6 1764300004	1 NR	CAVO SENSORE CILINDRO 3 BRACCIO MK2 (DA C170000893)	CABLE CYLINDER SENSOR 3 BOOM MK2 (FROM C170000893)			
7 1591270003	1 NR	MICROINTERRUT TORE 2 CONTATTI NC TESTINA ROTELLA ACCIAIO CAVO LUNGO 2 METRI	MICROSWITCH 2 NC CONTACTS HEAD STEEL WHEEL LONG CABLE 2M	MICROINTERRUP TEUR	MIKROSCHALTER	MICROINTERRUP TOR
8 1679890001	1 NR	CATARIFRANGEN TE 100X100 MM	REFLECTOR 100X100 MM	CATADIOPTRE	REFLEKTOR	CATADIÓPTRICO







 COMPONENTI IMPIANTO ELETTRICO

 KOMponenten ELEKTROANLAGE

 ELECTRICAL SYSTEM COMPONENTS

 COMPONENTES INSTALACIÓN ELÉCTRICA

 COMPOSANTS INSTALLATION ÉLECTRIQUE

POS Codice	Q.tà	 Descrizione	 Description	 Designation	 Benennung	 Descripción
9 1730720007	1 NR	SCATOLA ALLUMINIO PER SCHEDA CELLA DI CARICO COMPLETA DI IMPIANTO, CONNETTORI E COPERCHIO	BOX ALUMINUM LOAD CELL CARD COMPLETE SYSTEM, CONNECTORS AND COVER			
9 1764250002	1 NR	SCATOLA ALLUMINIO PER SCHEDA CELLA DI CARICO COMPLETA DI IMPIANTO, CONNETTORI E COPERCHIO MK2 (DA C170000893)	BOX ALUMINUM LOAD CELL CARD COMPLETE SYSTEM, CONNECTORS AND COVER MK2 (FROM C170000893)			
9 17644500	1 NR	SCATOLA ALLUMINIO PER SCHEDA CELLA DI CARICO IMPIANTI CON DOPPIO CONNETTORE PER SENSORE CELLA	BOX ALUMINUM SHEET LOAD CELL SYSTEMS WITH DUAL SENSOR CONNECTOR FOR CELL	BOÎTE ÉLECTRIQUE	ELEKTROGEHÄU SE	CAJA ELÉCTRICA





 COMPONENTI IMPIANTO ELETTRICO

 KOMONENTEN ELEKTROANLAGE

 ELECTRICAL SYSTEM COMPONENTS

 COMPONENTES INSTALACIÓN ELÉCTRICA

 COMPOSANTS INSTALLATION ÉLECTRIQUE

POS Codice	Q.tà	 Descrizione	 Description	 Designation	 Benennung	 Descripción
10 1585570005	1 NR	PRESA ELETTRICA 230V	ELECTRICAL SOCKET 230V	PRISE ÉLECTRIQUE	STECKDOSE	ENCHUFE ELÉCTRICO
10 1591700002	1 NR	PRESA ELETTRICA 110V	ELECTRICAL SOCKET 110V	PRISE ÉLECTRIQUE 110V	STECKDOSE 110V	ENCHUFE ELÉCTRICO 110V
11 07173300	1 NR	PIASTRA VERSIONE CE	PLATE CE VERSION	PLATINE	PLATTE	PLACA
11 07173800	1 NR	PIASTRA VERSIONE ANSI	PLATE ANSI VERSION	PLATINE	PLATTE	PLACA
11 076710H3	1 NR	LAMIERA FISSAGGIO SCATOLA MK2 (DA C170000893)	PROTECTION RAL9005 MK2 (FROM C170000893)	PROTECTION RAL9005 MK2 (FROM C170000893)	SCHUTZ RAL9005 MK2 (FROM C170000893)	PROTECCION RAL9005 MK2 (FROM C170000893)
11 076860H3	1 NR	LAMIERA FISSAGGIO SCATOLA MK2 (DA C170000893)	PLATE MK2 (FROM C170000893)	PLAQUE MK2 (FROM C170000893)	PLATTE MK2 (FROM C170000893)	PLACA MK2 (FROM C170000893)





 COMPONENTI IMPIANTO ELETTRICO

KOMPONENTEN ELEKTROANLAGE 

 ELECTRICAL SYSTEM COMPONENTS

COMPONENTES INSTALACIÓN ELÉCTRICA 

 COMPOSANTS INSTALLATION ÉLECTRIQUE

POS Codice	Q.tà	 Descrizione	 Description	 Designation	 Benennung	 Descripcìon
12 17770300	1 NR	SCHEDA CELLA DI CARICO 4-20MA RESINATA (MK2)	ELECTRONIC BOARD LOAD SENSOR 4-20MA (MK2)	CARTE ÉLECTRONIQUE (MK2)	ELEKTRONISCHE PLATINE (MK2)	PLACA ELECTRÓNICA (MK2)
12 27480300	1 NR	SCHEDA ELETTRONICA SENSORE DI CARICO (PERFORMANCE- PLUS-AUSTRALIA )	ELECTRONIC BOARD LOAD SENSOR (PERFORMANCE- PLUS-AUSTRALIA )	CARTE ÉLECTRONIQUE	ELEKTRONISCHE PLATINE	PLACA ELECTRÓNICA
13 1730720008	1 NR	CAVO 7 POLI LL1775/200 DA BASE A CESTO	7-POLE CABLE LL1775/200 FROM BASE TO BASKET			





 COMPONENTI IMPIANTO ELETTRICO

 KOMponentEN ELEKTROANLAGE

 ELECTRICAL SYSTEM COMPONENTS

 COMPONENTES INSTALACIÓN ELÉCTRICA

 COMPOSANTS INSTALLATION ÉLECTRIQUE

POS Codice	Q.tà	 Descrizione	 Description	 Designation	 Benennung	 Descripción
14 1730720095	1 NR	SENSORE CELLA DI CARICO COMPLETA DI CAVO E CONNETTORE CABLATO PERFORMANCE E PLUS	SENSOR LOAD CELL COMPLETE WIRED CABLE AND CONNECTOR FOR PERFORMANCE AND PLUS	CAPTEUR CELLULE DE CHARGE COMPLÈTE DE CÂBLE ET CONNECTEUR AVEC CÂBLAGE PERFORMANCE ET PLUS	KORBLASTSENS OR KOMPLETT MIT KABEL UND VERBINDER FÜR PERFORMANCE UND PLUS	SENSOR CÉLULA DE CARGA COMPLETA DE CABLE Y CONECTOR CABLEADO PERFORMANCE Y PLUS
14 17669800	1 NR	SENSORE CELLA DI CARICO 4-20MA COMPLETO DI CAVO E CONNETTORI M12 (MK2)	SENSOR LOAD CELL 4-20MA WITH CABLE AND CONNECTORS M12 (MK2 VERSION)	CELLULE DE CHARGE (MK2)	MESSDOSE (MK2)	CÉLULA DE CARGA (MK2)
14 25611500	1 NR	CELLA DI CARICO	LOAD CELL	CELLULE DE CHARGE	MESSDOSE	CÉLULA DE CARGA
15 1591270011	1 NR	MICROINTERRUTTORE 2 CONTATTI NC TESTINA A PULSANTE CAVO LUNGO 2 METRI	MICROSWITCH 2 NC CONTACTS BUTTON HEAD LONG CABLE 2M	MICROINTERRUTTEUR	MIKROSCHALTER	MICROINTERRUTTOR
16 1556350001	4 NR	LUCE STABILIZZATORE	STABILIZER LIGHT	LUMIÈRE STABILISATEUR	ABSTÜTZUNGSB ELEUCHTUNG	LUZ ESTABILIZADOR
16 1556350001	1 NR	LUCE STABILIZZATORE	STABILIZER LIGHT	LUMIÈRE STABILISATEUR	ABSTÜTZUNGSB ELEUCHTUNG	LUZ ESTABILIZADOR





 COMPONENTI IMPIANTO ELETTRICO

 KOMONENTEN ELEKTROANLAGE

 ELECTRICAL SYSTEM COMPONENTS

 COMPONENTES INSTALACIÓN ELÉCTRICA

 COMPOSANTS INSTALLATION ÉLECTRIQUE

POS Codice	Q.tà	 Descrizione	 Description	 Designation	 Benennung	 Descripción
17 1556350034	1 NR	SPIA	PILOT LIGHT	TÉMOIN	KONTROLLLEUC HTE	INDICADOR LUMINOSO
18 1556350035	1 NR	LAMPADINA	LAMP	AMPOULE	GLÜHBIRNE	BOMBILLA
19 1556350036	1 NR	CORPO	BODY	CORPS	GEHÄUSE	CUERPO
20 27073800	1 NR	COVER PRESE USA AL CESTO, RECEPTACLE BOX PART N°:1671207	COVER US SOCKETS TO BASKET, RECEPTACLE BOX PART N°:1671207	PRETECTION	SCHUTZ	PROTECCIÓN
21 27073900	1 NR	PLUG PRESE USA AL CESTO, RECEPTACLE PART N°:4460346	US SOCKETS TO BASKET, RECEPTACLE PART N°:4460346	PRISE	STECKDOSE	ENCHUFE
22 27073700	1 NR	BOX PRESE USA AL CESTO, RECEPTACLE PART N°:0861731	US SOCKET BOX TO BASKET, RECEPTACLE PART N°:0861731	BOX PRISES	SCHACHTEL STECKDOSEN	CAJA ENCHUFES
23 27031700	1 NR	INTERUTTORE A PEDALE	FOOT SWITCH	INTERRUPTEUR	FUßSCHALTER	INTERRUPTOR
24 1757250023	1 NR	SPIA STABILIZZATORE LED COMPLETA DI CONNETTORE	LED LIGHT	TEMOIN LED	KONTROLLLAMP E	INDICADOR LED





 COMPONENTI IMPIANTO ELETTRICO

 KOMponenten ELEKTROANLAGE

 ELECTRICAL SYSTEM COMPONENTS

 COMPONENTES INSTALACIÓN ELÉCTRICA

 COMPOSANTS INSTALLATION ÉLECTRIQUE

POS Codice	Q.tà	 Descrizione	 Description	 Designation	 Benennung	 Descripción
25 07141700	1 NR	COPERCHIO SCATOLA CELLA DI CARICO IN ALLUMINIO	BOX COVER ALUMINUM LOAD CELL	COUVERCLE DE LA BOÎTE ALUMINIUM	SCHACHTELDEC KEL ALUMINIUM	TAPA CAJA DE ALUMINIO
26 07141800	1 NR	GUARNIZIONE SCATOLA CELLA DI CARICO IN ALLUMINIO	SEAL BOX ALUMINUM LOAD CELL	JOINT	DICHTUNG	SELLO
27 075163H3	1 NR	PROTEZIONE CONNETTORI SCATOLA CELLA DICARICO MK2 (DA C170000893)	PROTECTION LOAD CELL CONNECTOR MK2 (FROM C170000893)	PROTECTION CONNECTEURS BOITE CELLULE DE CHARGE MK2 (FROM C170000893)	ABDECKUNG MK2 (FROM C170000893)	PROTECCION MK2 (FROM C170000893)
27 075914B8	1 NR	PROTEZIONE CONNETTORI SCATOLA CELLA DICARICO AFTERMARKET	PROTECTION LOAD CELL CONNECTOR AFTER MARKET	PROTECTION CONNECTEURS BOITE CELLULE DE CHARGE	ABDECKUNG	PROTECCION





 COMPONENTI IMPIANTO ELETTRICO

KOMPONENTEN ELEKTROANLAGE 

 ELECTRICAL SYSTEM COMPONENTS

COMPONENTES INSTALACIÓN ELÉCTRICA 

 COMPOSANTS INSTALLATION ÉLECTRIQUE

POS Codice	Q.tà	 Descrizione	 Description	 Designation	 Benennung	 Descripción
28 1730720085	1 NR	CAVO STABILIZZATORE COMPLETO DI CONNETTORE E MICRO	STABILIZER CABLE WITH CONNECTOR AND MICRO	CONNECTEUR AVEC STABILISATEUR ET MICRO	KABELSTECKER MIT STABILISATOR UND MICRO	CABLE CONECTOR CON ESTABILIZADOR Y MICRO
28 1764250005	1 NR	CAVO STABILIZZATORE COMPLETO DI CONNETTORE E MICRO PER LUCE A LED MK2 (DA C170000893)	STABILIZER CABLE WITH CONNECTOR AND MICRO FOR LED MK2 (FROM C170000893)	CONNECTEUR AVEC STABILISATEUR ET MICRO LED MK2 (FROM C170000893)	KABELSTECKER MIT STABILISATOR UND MICRO LED MK2 (FROM C170000893)	CABLE CONECTOR CON ESTABILIZADOR Y MICRO LED MK2 (FROM C170000893)

Go to Discount-Equipment.com to order your parts

 COMPONENTI IMPIANTO ELETTRICO

 ELECTRICAL SYSTEM COMPONENTS

 COMPOSANTS INSTALLATION ÉLECTRIQUE

KOMPONENTEN ELEKTROANLAGE 

COMPONENTES INSTALACIÓN ELÉCTRICA 

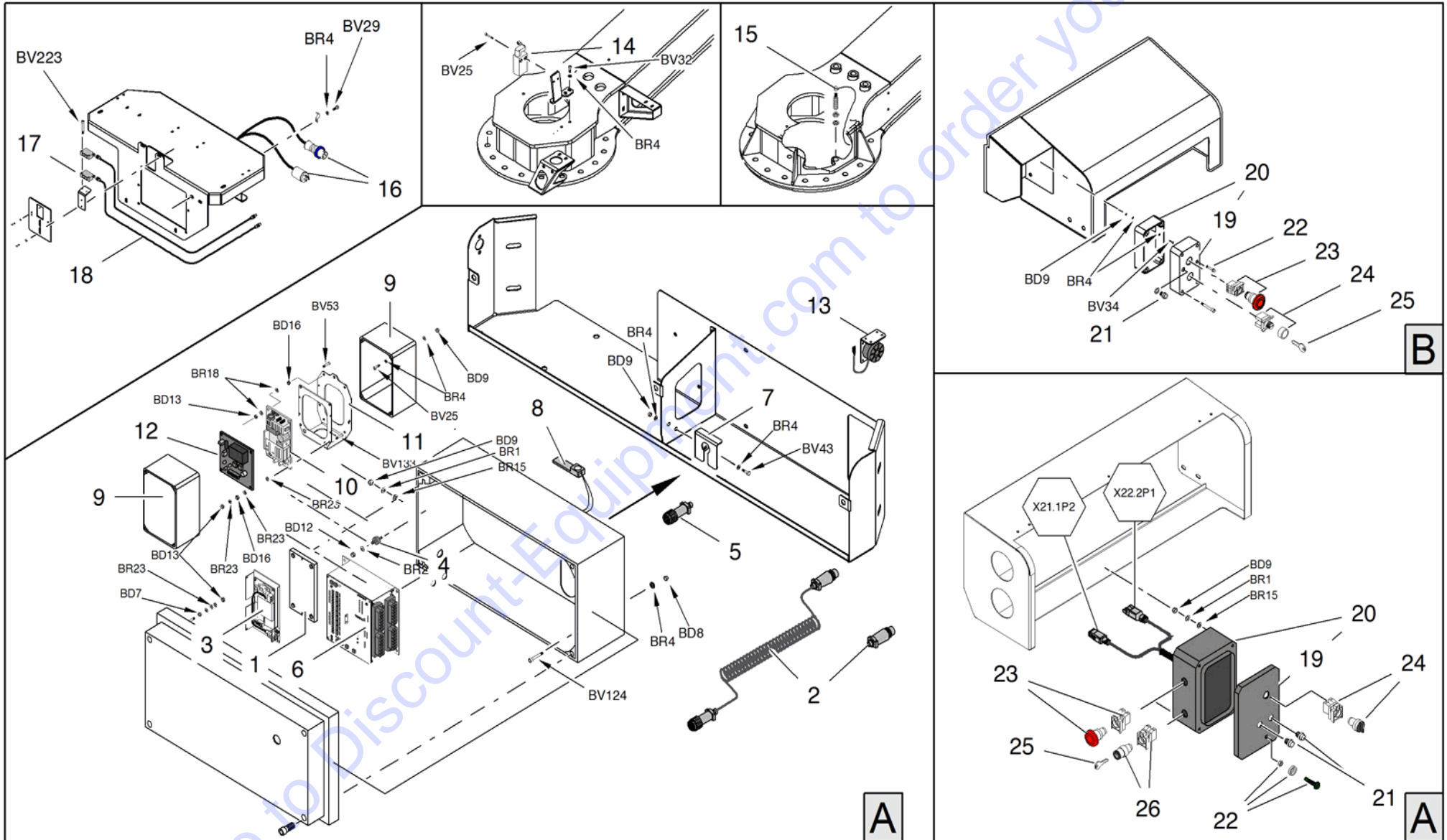







 COMPONENTI IMPIANTO ELETTRICO

 KOMponenten ELEKTROANLAGE 
 ELECTRICAL SYSTEM COMPONENTS

 COMPONENTES INSTALACIÓN ELÉCTRICA 
 COMPOSANTS INSTALLATION ÉLECTRIQUE

POS Codice	Q.tà	 Descrizione	 Description	 Designation	 Benennung	 Descripción
1 07396000	1 NR	PIASTRA ADATTAMENTO	PLATE ADAPTER	REGLAGE DE LA PLAQUE	FUSSPLATTENVE RSTELLUNG	AJUSTE DE LA PLACA
2 17264200	1 NR	CAVO TELECOMANDO COMPLETO PER OPTIONAL	COMPLETE REMOTE CONTROL CABLE FOR OPTIONAL	CÂBLE TÉLÉCOMMANDE COMPLET	FERNBEDIENUNG SKABEL KOMPLETT	CABLE TELECOMANDO COMPLETO
3 27321800	1 NR	SCHEDA MODEM CON NUOVO PROCESSORE (SUPPORTO A RICAMBIO 07396000) PER MACCHINE AUSTRALIA E PLUS	MODEM CARD WITH NEW CPU (MOUNTING SPARE PARTS 07396000) FOR AUSTRALIAN AND PLUS MACHINES	CARTE MODEM AVEC UN NOUVEAU PROCESSEUR	MODEMKARTE MIT NEUEN PROZESSOR	MODEM TARJETA CON NUEVO PROCESADOR
4 1730720018	1 NR	ANTIVIBRANTE SCATOLA GENERALE SUPPORTO SCHEDA MASTER CIAM	ANTI-VIBRATING ELEMENT	INSERT EN CAOUTCHOUC	VIBRATIONSDÄM PFER	ANTIVIBRACION
5 17306800	1 NR	CONNETTORE COMPLETO PER TELECOMANDO A TERRA E SERVICE	COMPLETE CONNECTOR FOR REMOTE CONTROL ON THE GROUND AND SERVICE	CONNECTEUR COMPLET	VERBINDER	CONECTOR





 COMPONENTI IMPIANTO ELETTRICO

 KOMponenten ELEKTROANLAGE

 ELECTRICAL SYSTEM COMPONENTS

 COMPONENTES INSTALACIÓN ELÉCTRICA

 COMPOSANTS INSTALLATION ÉLECTRIQUE

POS Codice	Q.tà	 Descrizione	 Description	 Designation	 Benennung	 Descripción
6 17506700	1 NR	KIT BANCO PROGRAMMAZIO NE SCHEDE PIATTAFORME	PROGRAMMATIO N KIT	KIT PROGRAMMATIO N	PROGRAMMATIO NSATZ	KIT PROGRAMACION
6 27179900	1 NR	SCHEDA ELETTRONICA NUOVO PROCESSORE (PER MACCHINE AUSTRALIA E PLUS) (+17172600 SE FORNITA A RICAMBIO CON SOFTWARE INSTALLATO)	ELECTRONIC BOARD NEW CPU (FOR AUSTRALIAN AND PLUS MACHINES) (+17172600 IF SUPPLIED PARTS WITH SOFTWARE INSTALLED)	FICHE ÉLECTRONIQUE	ELEKTRONISCHE PLATINE	TARJETA ELECTRÓNICA
6 27180000	1 NR	SCHEDA ELETTRICA NUOVO PROCESSORE VERSIONE LITIO (+17172600 SE FORNITA A RICAMBIO CON SOFTWARE INSTALLATO)	ELECTRIC BOARD NEW CHIP LITHIUM VERSION (+17172600 IF SUPPLIED PARTS WITH SOFTWARE INSTALLED)	FICHE ÉLECTRIQUE	ELEKTRISCHE PLATINE	TARJETA ELÉCTRICA
7 073181Y1	1 NR	STAFFA	BRACKET	ÉTRIER	HALTEBÜGEL	ESTRIBO





 COMPONENTI IMPIANTO ELETTRICO

 KOMponenten ELEKTROANLAGE

 ELECTRICAL SYSTEM COMPONENTS

 COMPONENTES INSTALACIÓN ELÉCTRICA

 COMPOSANTS INSTALLATION ÉLECTRIQUE

POS Codice	Q.tà	 Descrizione	 Description	 Designation	 Benennung	 Descripción
8 27396100	1 NR	ANTENNA	AERIAL	ANTENNE	ANTENNE	ANTENA
9 17348200	1 NR	SCATOLA ELETTRICA SWITCHING (A PARTIRE DA C170000340 PER MACCHINE ANSI)	SWITCHING ELECTRICAL BOX (FROM C170000340 FOR ANSI MACHINES)	BOÎTE ÉLECTRIQUE	ELEKTROGEHÄU SE	CAJA ELÉCTRICA
10 27249800	1 NR	ALIMENTATORE SWITCHING (DA C170000340 PER MACCHINE ANSI)	SWITCHING POWER SUPPLY (FROM C170000340 FOR ANSI MACHINES)	TRANSFORMATE UR	TRANSFORMATO R	TRANSFORMADO R
11 07243300	1 NR	LAMIERA SUPPORTO SCHEDE E SWITCHING (DA C170000340 PER MACCHINE ANSI)	BRAKET FOR CARD AND SWITCHING (FROM C170000340 FOR ANSI MACHINES)	SUPPORT	HALTERUNG	SOPORTE
12 17722600	1 NR	SCHEDE ELETTRONICA	ELECTRONIC BOARD	FICHE ÉLECTRIQUE	ELEKTRONISCHE PLATINE	PLACA ELECTRÓNICA
13 06639100	1 NR	AVVISATORE ACUSTICO	ACOUSTIC ALARM	BUZZER	SUMMER	ZUMBADOR





 COMPONENTI IMPIANTO ELETTRICO

 KOMONENTEN ELEKTROANLAGE

 ELECTRICAL SYSTEM COMPONENTS

 COMPONENTES INSTALACIÓN ELÉCTRICA

 COMPOSANTS INSTALLATION ÉLECTRIQUE

POS	Codice	Q.tà	 Descrizione	 Description	 Designation	 Benennung	 Descripción
14	1590900003	1 NR	MICROINTERRUTTORE 2 CONTATTI NC TESTINA BRACCIO DISASSATO E ROTELLA IN PLASTICA CAVO LUNGO 2 METRI	2 NC CONTACTS MICROSWITCH HEAD OFFSET ARM AND WHEEL PLASTIC LONG CABLE 2M	MICROINTERRUPTEUR	MIKROSCHALTER	MICROINTERRUPTOR
15	1651290010	1 NR	SENSORE DI PROSSIMITÀ	PROXIMITY SENSOR	CAPTEUR DE PROXIMITÉ	NÄHERUNGSSENSOR	SENSOR DE PROXIMIDAD
16	1556350013	1 NR	SPINA FISSA 230V 90°	PLUG 230V 90°	CHEVILLE	STIF	CLAVIJA
16	1556350064	1 NR	SPINA FISSA 110V 90°	PLUG 110V 90°	CHEVILLE	STIF	CLAVIJA
16	1757250001	1 NR	SPINA VOLANTE 230V 16A	FREE PLUG 230V 16A	FICHE	STECKER	ENCHUFE
16	27074000	1 NR	TERMINAL PRESA USA A TERRA, CONN PLUG PART N°:4460138	TERMINAL GROUND SOCKET USA, CONN PLUG PART N °: 4460138	CONNECTEUR	VERBINDER	CONECTOR
17	1591270001	1 NR	FOTOCELLULA	PHOTOCELL	CELLULE PHOTO-ÉLECTRIQUE	PHOTOZELLE	FOTOCÉLULA





 COMPONENTI IMPIANTO ELETTRICO

KOMPONENTEN ELEKTROANLAGE 

 ELECTRICAL SYSTEM COMPONENTS

COMPONENTES INSTALACIÓN ELÉCTRICA 

 COMPOSANTS INSTALLATION ÉLECTRIQUE

POS Codice	Q.tà	 Descrizione	 Description	 Designation	 Benennung	 Descripcìon
18 159127000101	1 NR	CAVO ELETTRICO	ELECTRIC CABLE	CÂBLE ÉLECTRIQUE	ELEKTROKABEL	CABLE ELÉCTRICO
19 175726002401	1 NR	COPERCHIO SCATOLA STOP A TERRA DIESEL LL2614-X26JP-X7 70AJ	BOX COVER	COUVERCLE BOÎTE	KASTENABDECK UNG	TAPA DE CAJA
19 175727000201	1 NR	COPERCHIO SCATOLA STOP A TERRA LITHIUM 83V	BOX COVER	COUVERCLE BOÎTE	KASTENABDECK UNG	TAPA DE CAJA

Go to Discount-Equipment.com to order your parts





 COMPONENTI IMPIANTO ELETTRICO

 KOMONENTEN ELEKTROANLAGE

 ELECTRICAL SYSTEM COMPONENTS

 COMPONENTES INSTALACIÓN ELÉCTRICA

 COMPOSANTS INSTALLATION ÉLECTRIQUE

POS Codice	Q.tà	 Descrizione	 Description	 Designation	 Benennung	 Descripcìon
20 1730720011	1 NR	SCATOLA STOP A TERRA BENZINA/DIESEL COMPLETA DI CABLAGGIO E CONNETTORE	BOX GROUND STOP PETROL / DIESEL COMPLETE WIRING AND CONNECTOR			
20 173072001101	1 NR	SCATOLA VUOTA STOP A TERRA BENZINA/DIESEL	BOX GROUND STOP PETROL / DIESEL	BOÎTE	GEHÄUSE	CAJA
20 1730720093	1 NR	SCATOLA STOP A TERRA LITHIUM COMPLETA DI CABLAGGIO E CONNETTORE	BOX GROUND STOP LITHIUM COMPLETE WIRING AND CONNECTOR			
20 1757260024	1 NR	SCATOLA STOP A TERRA DIESEL LL2614-X26JP-X7 70AJ COMPLETA DI CABLAGGIO E CONNETTORE	BOX WITH WIRING	BOÎTE AVEC CÂBLAGE	KASTEN MIT VERKABELUNG	CAJA CON CABLEADO
20 175726002402	1 NR	COPERCHIO SCATOLA STOP A TERRA DIESEL LL2614-X26JP-X7 70AJ	BOX COVER	COUVERCLE BOÎTE	KASTENABDECK UNG	TAPA DE CAJA





 COMPONENTI IMPIANTO ELETTRICO

KOMPONENTEN ELEKTROANLAGE 

 ELECTRICAL SYSTEM COMPONENTS

COMPONENTES INSTALACIÓN ELÉCTRICA 

 COMPOSANTS INSTALLATION ÉLECTRIQUE

POS Codice	Q.tà	 Descrizione	 Description	 Designation	 Benennung	 Descripcìon
20 1757270002	1 NR	SCATOLA STOP A TERRA LITHIUM 83V COMPLETA DI CABLAGGIO E CONNETTORE	BOX WITH WIRING	BOÎTE AVEC CÂBLAGE	KASTEN MIT VERKABELUNG	CAJA CON CABLEADO
21 1628400001	1 NR	PULSANTE	BUTTON	BOUTON	DRUCKKNOPF	BOTÓN
22 1730720005	1 NR	SPIA VERDE PARTE AEREA GRANDE	BIG GREEN LIGHT AERIAL PART	VOYANT	KONTROLLLEUC HTE	INDICADOR
23 1591270004	1 NR	PULSANTE	BUTTON	BOUTON	DRUCKKNOPF	BOTÓN
24 1556350068	1 NR	SELETTORE A LEVA 3 POSIZIONI	3 POSITION LEVER SWITCH	SÉLECTEUR	WÄHLSCHALTER	SELECTOR
25 1651290015	1 NR	CHIAVE	KEY	CLÉ	SCHLÜSSEL	LLAVE
26 1692150001	1 NR	BLOCCHETTO	BLOCK	BLOC	BLOCK	BLOQUE

 IMPIANTO ELETTRICO

ELEKTRISCHE ANLAGE 

 ELECTRICAL SYSTEM

INSTALACIÓN ELÉCTRICA 

 INSTALLATION ÉLECTRIQUE

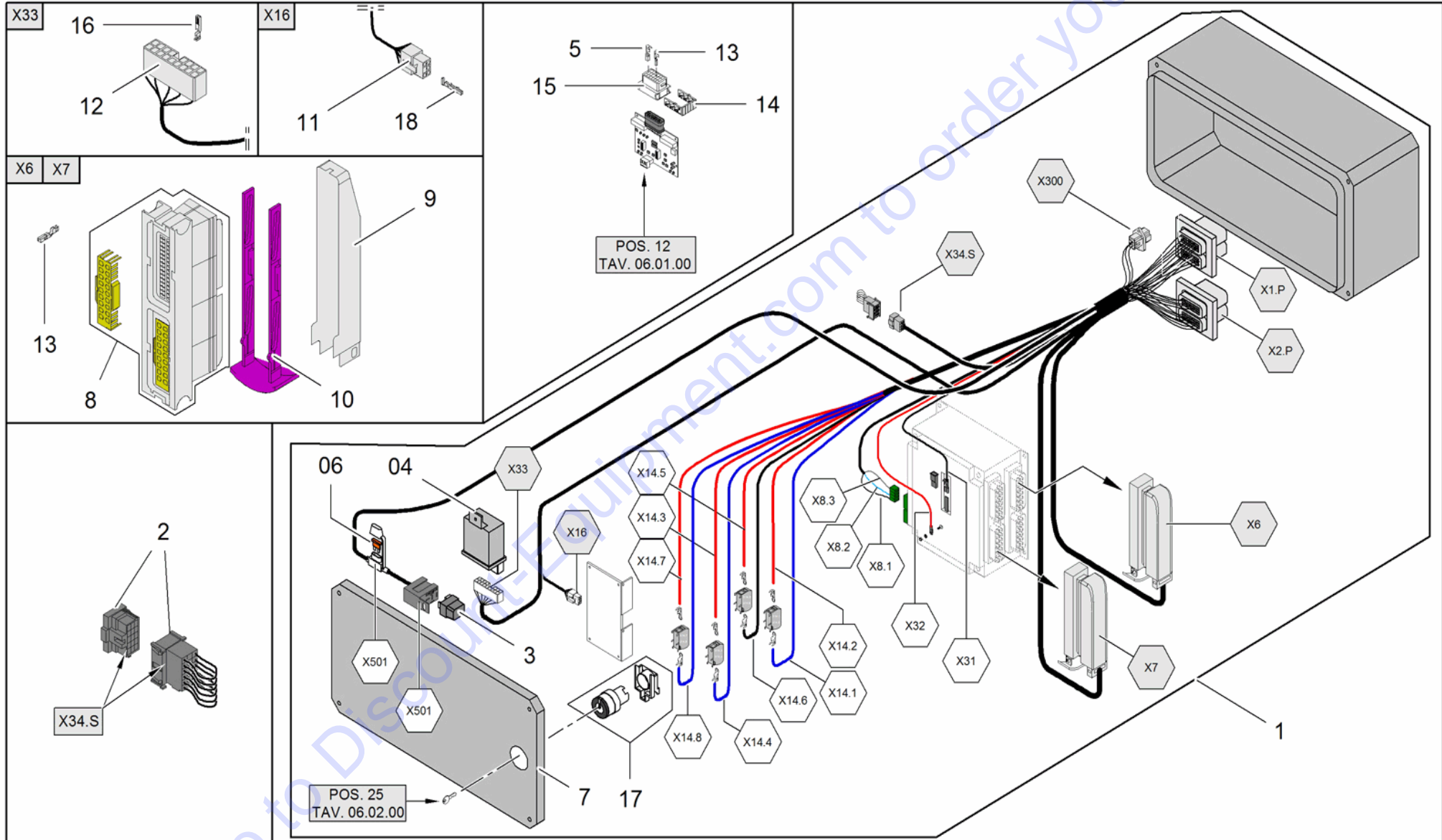







 IMPIANTO ELETTRICO

ELEKTRISCHE ANLAGE 





 ELECTRICAL SYSTEM

INSTALACIÓN ELÉCTRICA 





 INSTALLATION ÉLECTRIQUE

POS Codice	Q.tà	 Descrizione	 Description	 Designation	 Benennung	 Descripcìon
1 1730720009	1 NR	SCATOLA GENERALE IMPIANTO ELETTRICO COMPLETA DI CABLAGGIO,CON NETTORI E COPERCHIO	MAIN BOX ELECTRICAL WIRING COMPLETE WITHCONNECTO RS AND COVER			
1 1764250003	1 NR	SCATOLA GENERALE IMPIANTO ELETTRICO COMPLETA DI CABLAGGIO,CON NETTORI E COPERCHIO MK2 (DA C170000893)	MAIN BOX ELECTRICAL WIRING COMPLETE WITHCONNECTO RS AND COVER MK2 (FROM C170000893)			





 IMPIANTO ELETTRICO
ELEKTRISCHE ANLAGE 
 ELECTRICAL SYSTEM
INSTALACIÓN ELÉCTRICA 
 INSTALLATION ÉLECTRIQUE

POS Codice	Q.tà	 Descrizione	 Description	 Designation	 Benennung	 Descripción
2 1730720012	1 NR	CONNETTORE PONTE VERSIONE BENZINA	CONNECTOR BRIDGE VERSION PETROL			
2 1730720013	1 NR	CONNETTORE PONTE VERSIONE DIESEL 14RPM (LL2010)	CONNECTOR BRIDGE VERSION DIESEL 14RPM (LL2010)			
2 1730720073	15 NR	TERMINALE MASCHIO D.0,5-1 MM (X34)	TERMINAL MALE D.0 0.5 TO 1 MM (X34)	BORNE MALE D.0 0,5 A 1 MM (X34)	TERMINAL MALE D.0 0,5 BIS 1 MM (X34)	TERMINAL MACHO D.0 0,5 A 1 MM (X34)
2 1730720074	10 NR	TERMINALE MASCHIO D.1,5-2,5 MM (X34)	TERMINAL MALE D.1 0.5 TO 2, 5 MM (X34)	BORNE MALE D.1 0,5 A 2, 5 MM (X34)	TERMINAL MALE D.1 0,5 BIS 2, 5 MM (X34)	TERMINAL MACHO D.1 0,5 A 2, 5 MM (X34)
2 1730720075	15 NR	TERMINALE FEMMINA D 0,5-1 MM (X34)	TERMINAL FEMALE D 0.5-1 MM (X34)	BORNE FEMELLE D 0,5-1 MM (X34)	TERMINAL FEMALE D 0,5-1 MM (X34)	TERMINAL HEMBRA D 0.5-1 MM (X34)
2 1730720076	10 NR	TERMINALE FEMMINA D 1,5-2,5 MM (X34)	TERMINAL FEMALE D 1.5-2.5 MM (X34)	BORNE FEMELLE D 1,5-2,5 MM (X34)	TERMINAL FEMALE D 1,5-2,5 MM (X34)	TERMINAL HEMBRA D 1.5 A 2.5 MM (X34)
2 1730720090	1 NR	CONNETTORE PONTE VERSIONE LITIO 72V	CONNECTOR BRIDGE VERSION LITHIUM 72V	CONNEXION PONT 72V VERSION DU LITHIUM	STECKVERBINDE R BRÜCKE 72V LITHIUM VERSION	CONECTOR PUENTE VERSIÓN DE LITIO 72V

 IMPIANTO ELETTRICO
ELEKTRISCHE ANLAGE 
 ELECTRICAL SYSTEM
INSTALACIÓN ELÉCTRICA 
 INSTALLATION ÉLECTRIQUE

POS Codice	Q.tà	 Descrizione	 Description	 Designation	 Benennung	 Descripción
3 1739150059	1 NR	RELE' MICRO PER MONTAGGIO INTERNO SCATOLA 12V CON DIODO	MICRO RELAY 'FOR INTERNAL MOUNTING BOX WITH DIODE 12V	RELAIS MICRO POUR MONTAGE INTÉRIEUR BOÎTIER 12V AVEC DIODE	RELAIS MICROSCHALTER IM 12V KASTEN MIT DIODE	RELÉ MICRO PARA MONTAJE INTERNO CAJA 12V CON DIODO
4 1730720004	1 NR	CENTRALINA 4 RELE' REGOLAZIONE RPM	RELAY BOX 4 'RPM ADJUSTMENT	BOÎTE RELAIS DE COMMANDE	RELAIS SCHACHTEL 4 RPM	CAJA RELÉ 4 RPM
5 17473800	6 NR	PUNTALINO FEMMINA PER CONNETTORE 24 VIE SCHEDA CELLA DI CARICO D=2.8	FERRULE FEMALE CONNECTOR 24 WAY BOARD LOAD CELL D = 2.8	EMBOUT FEMELLE POUR CONNECTEUR 24 VOIES CARTE CELLULE DE CHARGE D=2.8	VERSCHRAUBUN G BUCHSE FÜR 24-WEGE-VERBIN DER KORBLAST-PLATI NE D=2,8	PUNTAL HEMBRA PARA CONECTOR 24 VÍAS CELULA DE CARGA D=2.8
5 17473800	1 NR	PUNTALINO FEMMINA PER CONNETTORE 24 VIE SCHEDA CELLA DI CARICO D=2.8	FERRULE FEMALE CONNECTOR 24 WAY BOARD LOAD CELL D = 2.8	EMBOUT FEMELLE POUR CONNECTEUR 24 VOIES CARTE CELLULE DE CHARGE D=2.8	VERSCHRAUBUN G BUCHSE FÜR 24-WEGE-VERBIN DER KORBLAST-PLATI NE D=2,8	PUNTAL HEMBRA PARA CONECTOR 24 VÍAS CELULA DE CARGA D=2.8
6 05760800	1 NR	FUSIBILE 7,5 A	FUSE 7,5 A	FUSIBLE 7,5 A	SICHERUNG 7,5 A	FUSIBLE 7,5 A
7 1730720010	1 NR	COPERCHIO SCATOLA GENERALE IMPIANTO ELETTRICO	MAIN BOX ELECTRIC COVER			

 IMPIANTO ELETTRICO
ELEKTRISCHE ANLAGE 
 ELECTRICAL SYSTEM
INSTALACIÓN ELÉCTRICA 
 INSTALLATION ÉLECTRIQUE

POS Codice	Q.tà	 Descrizione	 Description	 Designation	 Benennung	 Descripción
8 17306000	1 NR	PARTE DI CONNETTORE	CONNECTOR PART	CONNECTEUR	VERBINGER	CONECTADOR
9 17306100	1 NR	COPERCHIO	COVER	COUVERCLE	DECKEL	TAPA
10 17306200	1 NR	SLITTA	SLIDE	COULISSEAU	SCHLITTEN	CORREDERA
11 07503600	1 NR	CONNETTORE PORTA FEMMINE 6 VIE PER MODEM	PORT CONNECTOR 6 WAY FEMALE FOR MODEM	CONNECTEUR PORTE-FEMELLE S 6 VOIES POUR MODEM	VERBINDER	CONECTOR
12 1730720077	1 NR	CONNETTORE 17 VIE M CENTRALINA RELE' RPM (X33)	CONNECTOR	CONNECTEUR	VERBINDER	CONECTADOR
13 17306300	18 NR	PUNTALINO FEMMINA PER CONNETTORE 56 VIE SCHEDA MASTER D=1.5	FERRULE FEMALE CONNECTOR 56 WAY MAIN BOARD D = 1.5	BUTÉE FEMELLE CONNECTEUR 56 VOIES CARTE MASTER D = 1.5	AUFLAGESTIFT BUCHSE 56-WEGE-VERBIN DER MASTERPLATINE D = 1.5	CONECTOR PUNTA HEMBRA 56 VÍAS TARJETA MASTER D=1,5
13 17306300	1 NR	PUNTALINO FEMMINA PER CONNETTORE 56 VIE SCHEDA MASTER D=1.5	FERRULE FEMALE CONNECTOR 56 WAY MAIN BOARD D = 1.5	BUTÉE FEMELLE CONNECTEUR 56 VOIES CARTE MASTER D = 1.5	AUFLAGESTIFT BUCHSE 56-WEGE-VERBIN DER MASTERPLATINE D = 1.5	CONECTOR PUNTA HEMBRA 56 VÍAS TARJETA MASTER D=1,5





 IMPIANTO ELETTRICO

 ELEKTRISCHE ANLAGE

 ELECTRICAL SYSTEM

 INSTALACIÓN ELÉCTRICA

 INSTALLATION ÉLECTRIQUE

POS Codice	Q.tà	 Descrizione	 Description	 Designation	 Benennung	 Descripcìon
14 17473700	1 NR	SLITTA PER CONNETTORE 24 VIE	SLIDE FOR 24-WAY CONNECTOR	COULISSEAU	SCHLITTEN	CORREDERA
15 17473600	1 NR	PARTE DI CONNETTORE 24VIE	CONNECTOR PART 24 WAY	CONNECTEUR	VERBINGER	CONECTADOR
16 1730720078	20 NR	CONTATTO FEMMINA (X33)	CONTACT FEMALE (X33)	CONTACT FEMELLE (X33)	CONTACT FEMALE (X33)	CONTACTO HEMBRA (X33)
16 1730720078	1 NR	CONTATTO FEMMINA (X33)	CONTACT FEMALE (X33)	CONTACT FEMELLE (X33)	CONTACT FEMALE (X33)	CONTACTO HEMBRA (X33)
17 1585570006	1 NR	SELETTORE	SELECTOR	SÉLECTEUR	WÄHLSCHALTER	SELECTOR
18 07503700	1 NR	PUNTALINO FEMMINA PER CONNETTORE MODEM	CLAMP	BORNE	KLEMME	BORNE

Go to Discount-Equipment.com to order your parts

 COMPONENTI IMPIANTO ELETTRICO LITIO

KOMPONENTEN ELEKTROANLAGE LITHIUM 

 ELECTRICAL SYSTEM COMPONENTS LITHIUM

COMPONENTES INSTALACIÓN ELÉCTRICA LITHIUM 

 COMPOSANTS INSTALLATION ÉLECTRIQUE LITHIUM

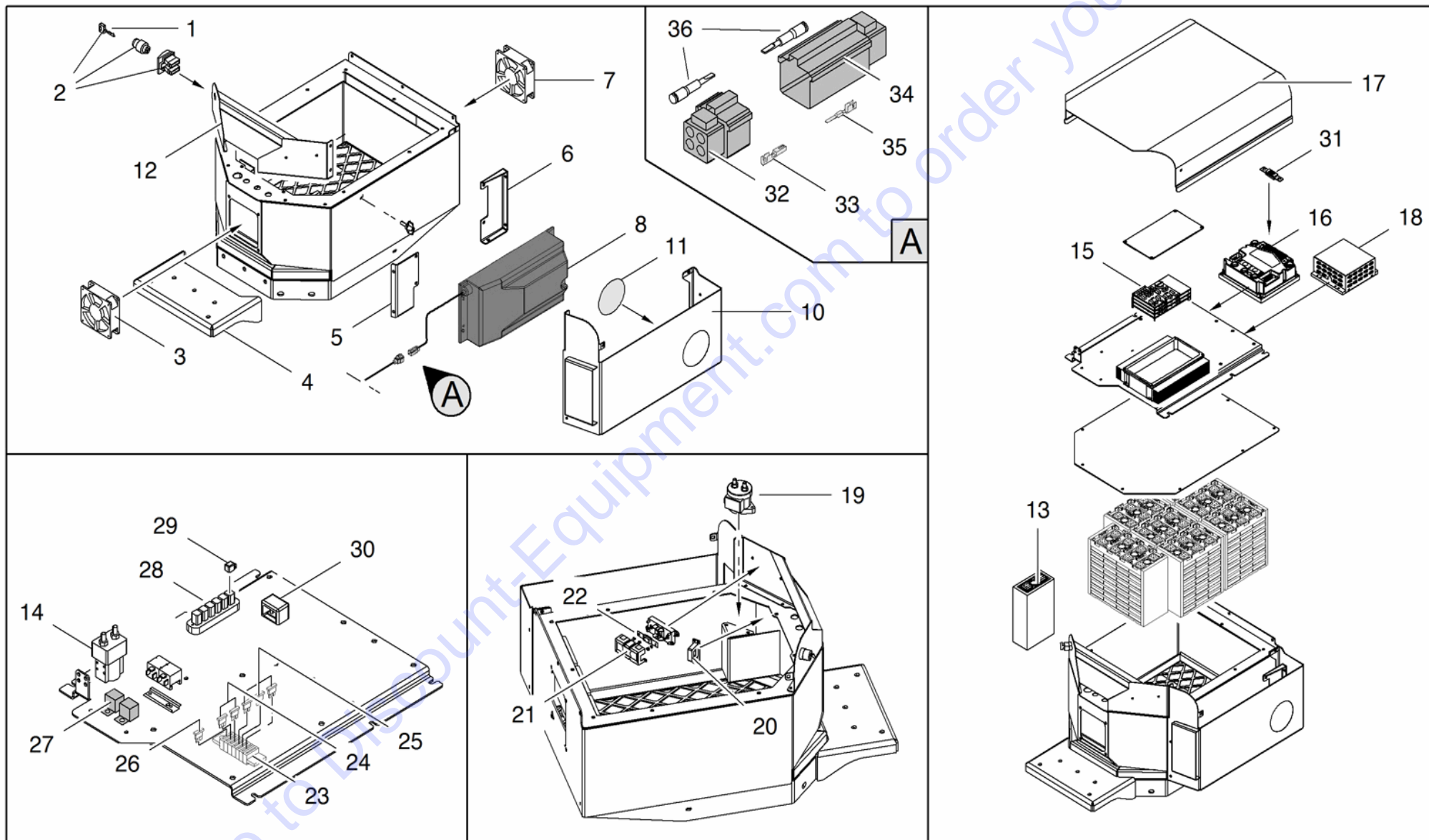





 COMPONENTI IMPIANTO ELETTRICO LITIO

 KOMONENTEN ELEKTROANLAGE LITHIUM

 ELECTRICAL SYSTEM COMPONENTS LITHIUM

 COMPONENTES INSTALACIÓN ELÉCTRICA LITHIUM

 COMPOSANTS INSTALLATION ÉLECTRIQUE LITHIUM

POS Codice	Q.tà	 Descrizione	 Description	 Designation	 Benennung	 Descripción
2 1730720091	1 NR	BLOCCHETTO CHIAVE COMPLETO DI CHIAVE PER PACCHI LITIO PERFORMANCE (PLUS)	KEY BLOCK COMPLETE WITH KEY FOR LITHIUM PERFORMANCE (PLUS)	BLOC CLÉ COMPLÈTE	KEY BLOCK COMPLETE	BLOQUE CLAVE COMPLETO
3 1690690001	1 NR	VENTOLA ANTERIORE	FRONT FAN	VENTILATEUR	LÜFTERRAD	VENTILADOR
7 1690690002	1 NR	VENTOLA POSTERIORE	REAR FAN	VENTILATEUR	LÜFTERRAD	VENTILADOR
8 26947800	1 NR	CARICA BATTERIA LITIO 230V	BATTERY CHARGER LITHIUM 230V	CHARGE BATTERIE	BATTERIELADER	CARGA BATERÍAS
8 27085100	1 NR	CARICABATTERIE 72V-110V LITHIUM	LITHIUM BATTERY CHARGER 72V-110V	LITHIUM BATTERIE 72V-110V	BATTERIELADEG ERÄT 72V-110V LITHIUM	CARGADOR DE BATERÍA 72V-110V LITIO
8 27604200	1 NR	CARICABATTERIE 80V-240V LITHIUM	LITHIUM BATTERY CHARGER 80V-240V	LITHIUM BATTERIE 80V-240V	BATTERIELADEG ERÄT 80V-240V LITHIUM	CARGADOR DE BATERÍA 80V-240V LITIO





 COMPONENTI IMPIANTO ELETTRICO LITIO

 KOMponenten ELEKTROANLAGE LITHIUM

 ELECTRICAL SYSTEM COMPONENTS LITHIUM

 COMPONENTES INSTALACIÓN ELÉCTRICA LITHIUM

 COMPOSANTS INSTALLATION ÉLECTRIQUE LITHIUM





POS Codice	Q.tà	 Descrizione	 Description	 Designation	 Benennung	 Descripción
10 37496300	1 NR	SALDATO PROTEZIONE CARICABATTERIE LL2010, X20JP	WELDED PROTECTION FOR BATTERY CHARGER LL2010, X20JP, X600AJ	PROTECTION SAUDÉE CHARGEUR DE BATTERIE LL201, X20JP	SCHUTZ FÜR BATTERIELADEG ERÄT LL2010, X20JP, X600AJ	PROTECCIÓN CARGADOR DE BATERÍAS LL2010, X20JP
10 37634600	1 NR	SALDATO PER CASSONE LITHIUM LL2010 X20JP	SUPPORT	SUPPORT	HALTERUNG	SOPORTE
11 07377300	1 NR	PROTEZIONE TRASPARENTE LED CARICABATTERIE PACCO LITIO 72V	TRANSPARENT PROTECTION CHARGER LED	PROTECTION TRANSPARENT	TRANSPARENT SCHUTZART	PROTECCIÓN TRANSPARENTE
12 37496200	1 NR	SALDATO PROTEZIONE SUPERIORE CASSONE LITHIUM LL2010, X20JP	UPPER PROTECTION FOR LITHIUM BOX LL2010, X20JP, X600AJ	PROTECTION SUPÉRIEUR SAUDÉE CAISSON LITHIUM LL2010, X20JP	OBERSCHUTZ FÜR LITHIUM KASTEN LL2010, X20JP	PROTECCIÓN SUPERIOR CAJÓN LITHIUM LL2010, X20JP
13 1742410001	1 NR	CELLA LITIO VERSIONE B	LITHIUM CELL VERSION B	CELLULE LITHIUM UNIQUE B	LITHIUM EINZELZELLE B	CELDA BATERIA LITIO VERSION B
14 26429300	1 NR	TELERUTTORE	REMOTE-CONTR OL SWITCH	TÉLÉRUPTEUR	FERNSCHALTER	TELERUPTOR



 COMPONENTI IMPIANTO ELETTRICO LITIO

 KOMponenten ELEKTROANLAGE LITHIUM 
 ELECTRICAL SYSTEM COMPONENTS LITHIUM

 COMPONENTES INSTALACIÓN ELÉCTRICA LITHIUM 
 COMPOSANTS INSTALLATION ÉLECTRIQUE LITHIUM

POS Codice	Q.tà	 Descrizione	 Description	 Designation	 Benennung	 Descripcìon
15 1737990001	1 NR	BMS 72V NUOVA VERSIONE (DA C170000352)	BMS 72V NEW VERSION (FROM C170000352)	BMS 72V	BMS 72V	BMS 72V
15 1737990002	1 NR	CONTATTI A CRIMPARE C PER BMS	FERRULE CRIMP C FOR BMS			
15 1737990003	1 NR	CONTATTI A CRIMPARE F PER BMS	FERRULE CRIMP F FOR BMS			
15 1737990004	1 NR	HOUSING F CAN 4VIE PER BMS	HOUSING F CAN 4 WAY FOR BMS			
15 1737990005	1 NR	HOUSING F OPTO POWER 8VIE PER BMS	HOUSING F OPTO POWER 8 WAY FOR BMS			
15 1737990006	1 NR	HOUSING F VOLTAGE 20VIE PER BMS	HOUSING F VOLTAGE 20 WAY FOR BMS			
15 1737990007	1 NR	HOUSING C NO OPTO SIGNAL 18VIE PER BMS	HOUSING C NO OPTO SIGNAL 18 WAY FOR BMS			
15 1737990008	1 NR	HOUSING C OPTO SIGNAL 14VIE FOR BMS	HOUSING C OPTO SIGNAL 14 WAY FOR BMS			
15 1737990009	1 NR	HOUSING C TEMPERATURE 16VIE FOR BMS	HOUSING C TEMPERATURE 16 WAY FOR BMS			





 COMPONENTI IMPIANTO ELETTRICO LITIO

 KOMONENTEN ELEKTROANLAGE LITHIUM

 ELECTRICAL SYSTEM COMPONENTS LITHIUM

 COMPONENTES INSTALACIÓN ELÉCTRICA LITHIUM





 COMPOSANTS INSTALLATION ÉLECTRIQUE LITHIUM

POS Codice	Q.tà	 Descrizione	 Description	 Designation	 Benennung	 Descripción
16 26947600	1 NR	INVERTER	INVERTER	INVERTER	INVERTER	INVERTER
17 07496100	1 NR	COPERCHIO SUPERIORE PER CASSONE LITHIUM LL2010, X20JP	UPPER COVER FOR LITHIUM BOX LL2010, X20JP, X600AJ	COUVERCLE SUPÉRIEUR POUR CAISSON LITHIUM LL2010, X20JP, X600AJ	OBERDECKEL FÜR LITHIUM-BOX LL2010, X20JP, X600AJ	TAPA SUPERIOR PARA CAJÓN LITHIUM LL2010, X20JP
17 07634900	1 NR	COPERCHIO	COVER	COUVERCLE	DECKEL	TAPA
18 26947900	1 NR	TRASFORMATORE	TRANSFORMER	TRANSFORMATEUR	TRANSFORMATORE	TRANSFORMADOR
19 1690690020	1 NR	TELERUTTORE	REMOTE-CONTROL SWITCH	TÉLÉRUPTEUR	FERNSCHALTER	TELERUPTOR
20 1735210002	1 NR	TRASDUTTORE DI CORRENTE (DA C170000330)	CURRENT TRANSDUCER (FROM C170000330)	TRANSFORMATEUR D'INTENSITÉ (DA C170000330)	STROMMESSUMFORMER (DA C170000330)	TRANSDUCTOR DE CORRIENTE ELÉCTRICA (DA C170000330)
21 1690690009	1 NR	COPERCHIO	COVER	COUVERCLE	DECKEL	TAPA
22 1690690011	1 NR	FUSIBILE 160A	FUSE 160A	FUSIBLE 160A	SICHERUNG 160A	FUSIBLE 160A
23 1690690003	1 NR	BLOCCHETTO	FUSE HOLDERS BLOCK	BLOC	BLOCK	BLOQUE
24 05760600	1 NR	FUSIBILE 3A	FUSE 3A	FUSIBLE 3A	SICHERUNG 3A	FUSIBLE 3A
25 05760900	1 NR	FUSIBILE 10A	FUSE 10A	FUSIBLE 10A	SICHERUNG 10A	FUSIBLE 10A
26 05760800	1 NR	FUSIBILE 7,5 A	FUSE 7,5 A	FUSIBLE 7,5 A	SICHERUNG 7,5 A	FUSIBLE 7,5 A

 COMPONENTI IMPIANTO ELETTRICO LITIO

 KOMponenten ELEKTROANLAGE LITHIUM 
 ELECTRICAL SYSTEM COMPONENTS LITHIUM

 COMPONENTES INSTALACIÓN ELÉCTRICA LITHIUM 
 COMPOSANTS INSTALLATION ÉLECTRIQUE LITHIUM

POS Codice	Q.tà	 Descrizione	 Description	 Designation	 Benennung	 Descripción
27 1690690005	1 NR	RELE'è	RELAY	RELAIS	RELAIS	RELÉ
28 1730720087	1 NR	CONNETTORE DERIVAZIONE CAN	JUNCTION CONNECTOR CAN	CONNECTEUR	VERBINDER	CONECTOR
29 1730720086	1 NR	TAPPO CONNETTORE 2 VIE	CONNECTOR PLUG 2 WAY	BOUCHON CONNECTEUR	VERSCHLUSS VERBINDER	TAPA CONECTOR
30 1730720088	1 NR	ISOLATORE CONNESSIONE MASSA	INSULATOR EARTH CONNECTION	ISOLATEUR	ISOLATOR	AISLADOR
31 2694760001	1 NR	FUSIBILE	FUSE	FUSIBLE	SICHERUNG	FUSIBLE
32 1757250009	1 NR	CONNETTORE PORTA FEMMINE 4 VIE MOLEX 220-110V 20-25A	CONNECTOR	CONNECTEUR	VERBINDER	CONECTOR
33 1757250011	1 NR	PUNTALINO	FERRULE	EMBOUT	ZWINGE	PUNTERA
34 1757250010	1 NR	CONNETTORE PORTA MASCHI 4 VIE MOLEX 220-110V 20-25A	CONNECTOR	CONNECTEUR	VERBINDER	CONECTOR
35 1757250013	1 NR	PUNTALINO MASCHIO PER CONNETTORE 4 VIE MOLEX 220-110V 20-25A	FERRULE	EMBOUT	ZWINGE	PUNTERA





 COMPONENTI IMPIANTO ELETTRICO LITIO

KOMPONENTEN ELEKTROANLAGE LITHIUM 

 ELECTRICAL SYSTEM COMPONENTS LITHIUM

COMPONENTES INSTALACIÓN ELÉCTRICA LITHIUM 

 COMPOSANTS INSTALLATION ÉLECTRIQUE LITHIUM

POS Codice	Q.tà	 Descrizione	 Description	 Designation	 Benennung	 Descripcìon
36 1757250012	1 NR	TAPPO PER CHIUSURA FORI SU CONNETTORE 4 VIE MOLEX 220-110V 20-25A	CAP	BOUCHON	DECKEL	TAPA

Go to Discount-Equipment.com to order your parts

 TELECOMANDO

FERNSTEUERUNG 

 REMOTE CONTROL

TELECOMANDO 



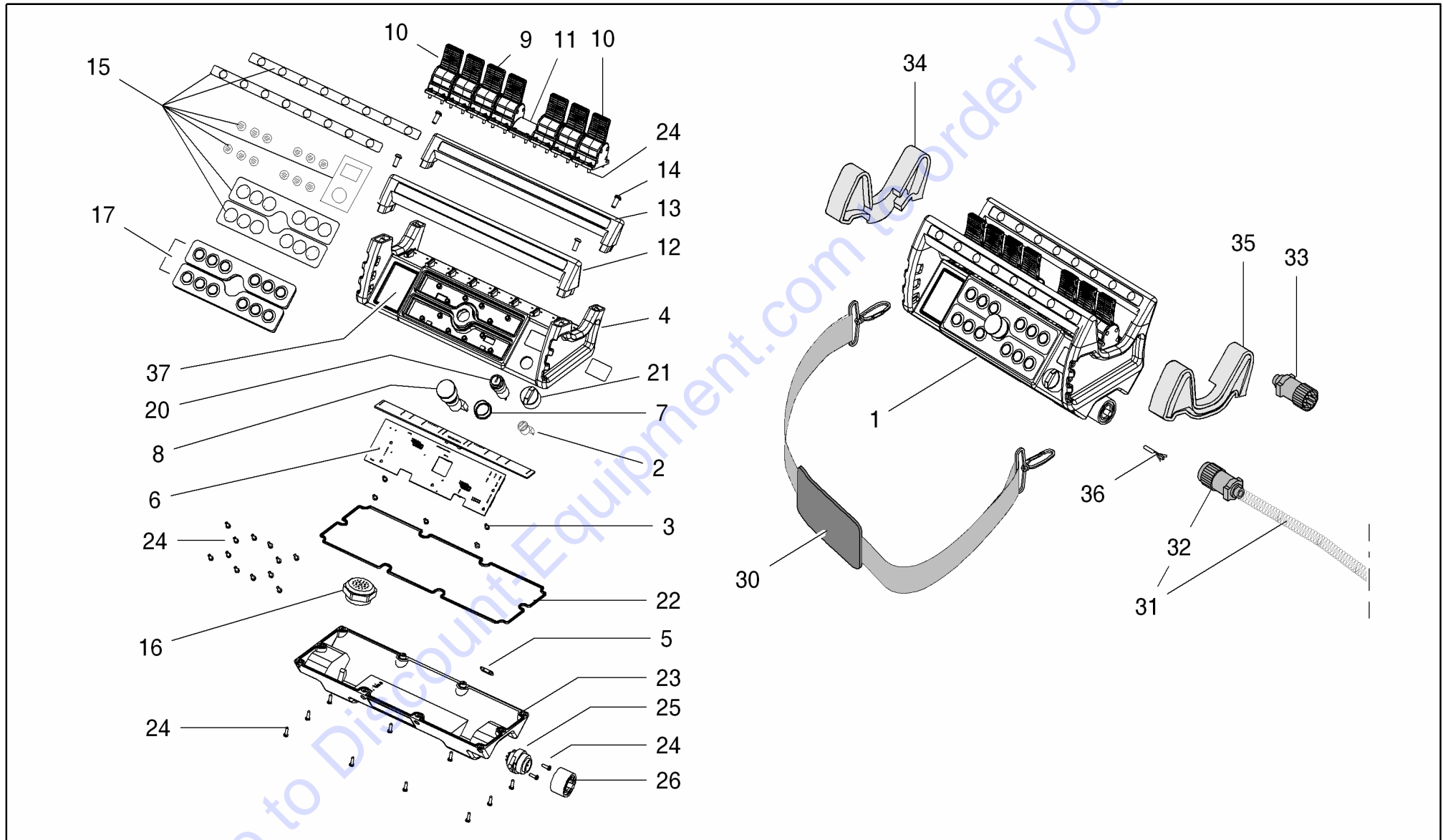

 TÉLÉCOMMANDE



 TELECOMANDO

 FERNSTEUERUNG 
 REMOTE CONTROL

 TELECOMANDO 
 TÉLÉCOMMANDE





POS Codice	Q.tà	 Descrizione	 Description	 Designation	 Benennung	 Descripcìon
1 27237400	1 NR	TELECOMANDO CASE GRIGIO	REMOTE CONTROL GREY CASE	TÉLÉCOMMANDE	FERNSTEUERUN G	TELECOMANDO
2 07359400	1 NR	CONTATTO PER STOP EMERGENZA TELECOMANDO 3S	CONTACT FOR EMERGENCY STOP REMOTE CONTROL 3S	CONTACTE POUR ARRET D'URGENCE	KONTAKT FÜR NOTSTOP	CONTACTO PARA PARADA DE EMERGENCIA
3 2646170003	5 NR	VITI SCHEDA ELETTRONICA	ELECTRONIC BOARD SCREWS	VIS	SCHRAUBEN	TORNILLOS

Go to Discount-Equipment.com to order your parts

 TELECOMANDO

 FERNSTEUERUNG 
 REMOTE CONTROL





 TELECOMANDO 
 TÉLÉCOMMANDE

POS Codice	Q.tà	 Descrizione	 Description	 Designation	 Benennung	 Descripcìon
4 2723740001	1 NR	COPERCHIO SUPERIORE TELECOMANDO CASE GRIGIO + DISPLAY E PULSANTI (PER RICAMBIO È NECESSARIO IL SN DEL TELECOMANDO)	TOP COVER REMOTE CONTROL CASE GREY + DISPLAY AND BUTTONS (AS SPARE IS COMPULSORY THE SN OF REMOTE CONTROL)	COUVERCLE	DECKEL	TAPA
4 2723740002	1 NR	COPERCHIO SUPERIORE TELECOMANDO CASE GRIGIO SOLO COPERCHIO, SENZA COMPONENTI E SENZA DISPLAY	TOP COVER REMOTE CONTROL CASE GREY ONLY CASE, WITHOUT COMPONENTS AND DISPLAY	COUVERCLE	DECKEL	TAPA
5 07359500	1 NR	CONTATTO REED INTERNO TELECOMANDO 3S	REED CONTACT INTERNAL REMOTE 3S	REED CONTACT INTÉRIEUR 3S DISTANCE	REEDKONTAKT INDOOR REMOTE 3S	CONTACTO REED 3S REMOTO DE INTERIOR
6 2646170002	1 NR	SCHEDA ELETTRONICA PER TELECOMANDO	ELECTRONIC BOARD FOR REMOTE CONTROL	FICHE ÉLECTRIQUE	ELEKTRONISCHE PLATINE	PLACA ELECTRÓNICA
7 2646170007	1 NR	ANELLO	RING	BAGUE	RING	ANILLO

 TELECOMANDO

 FERNSTEUERUNG 
 REMOTE CONTROL

 TELECOMANDO 
 TÉLÉCOMMANDE





POS Codice	Q.tà	 Descrizione	 Description	 Designation	 Benennung	 Descripción
8 2646170008	1 NR	PULSANTE EMERGENZA	EMERGENCY BUTTON	BOUTON D'URGENCE	NOTSTOP KNOPF	PULSADOR DE EMERGENCIA
9 17550700	1 NR	KIT PROTEZIONE IN GOMMA PER JOYSTICK NERA	PROTECTION KIT	PROTECTION KIT	GUMMISCHUTZ KIT	PROTECCIÓN DE GOMA
9 2646170009	6 NR	LEVA NERA	LEVER BLACK	LEVIER	HEBEL	PALANCA
10 17550800	1 NR	KIT PROTEZIONE IN GOMMA PER JOYSTICK ROSSA	PROTECTION	PROTECTION	GUMMISCHUTZ	PROTECCION DE GOMA
10 2646170010	2 NR	LEVA ROSSA	LEVER RED	LEVIER	HEBEL	PALANCA
12 2646170013	1 NR	IMPUGNATURA INFERIORE	GRIP LOWER PART	POIGNÉE	GRIFF	EMPUÑADURA
13 2646170012	1 NR	IMPUGNATURA SUPERIORE	GRIP UPPER PART	POIGNÉE	GRIFF	EMPUÑADURA
14 2646170014	4 NR	VITE	SCREW	VIS	SCHRAUBE	TORNILLO
15 27005200	1 NR	KIT ADESIVI	DECALS KIT	KIT AUTOCOLLANTS	KLEBERSATZ	KIT PEGATINAS
16 2646170027	1 NR	CICALINO COMPLETO DI SCHEDA ELETTRONICA TELECOMANDO	BEEPER FOR REMOTE CONTROL	BUZZER	SUMMER	ZUMBADOR COMPLETO DE TARJETA ELECTRÓNICA TELEMANDO
17 2646170017	1 NR	PULSANTI	BUTTONS	BOUTONS	DRUCKKNÖPFE	BOTONES



 TELECOMANDO

 FERNSTEUERUNG 
 REMOTE CONTROL





 TELECOMANDO 
 TÉLÉCOMMANDE

POS Codice	Q.tà	 Descrizione	 Description	 Designation	 Benennung	 Descripció
20 2683930001	1 NR	INTERRUTTORE	SWITCH	INTERRUPTEUR	SCHALTER	INTERRUPTOR
21 2683930002	1 NR	CHIAVE ACCENSIONE	IGNITION KEY	CLÉ DE DÉMARRAGE	ZÜNDSCHLÜSSE L	LLAVE DE ENCENDIDO
22 2646170022	1 NR	GUARNIZIONE	GASKET	JOINT	DICHTUNG	GUARNICIÓN
23 2646170023	1 NR	COPERCHIO INFERIORE	COVER LOWER PART	COUVERCLE	DECKEL	TAPA
24 2646170024	56 NR	VITE	SCREW	VIS	SCHRAUBE	TORNILLO
25 2646170025	1 NR	CONNETTORE	CONNECTOR	CONNECTEUR	VERBINGER	CONECTOR
26 2646170026	1 NR	COPERCHIO CONNETTORE	COVER CONNECTOR	COUVERCLE	DECKEL	TAPA
30 2646170030	1 NR	CINGHIA	BELT	COURROIE	RIEMEN	CORREA
31 17235800	1 NR	CAVO TELECOMANDO COMPLETO IIIS /200	COMPLETE REMOTE CONTROL CABLE IIIS /200	CÂBLE COMPLET TÉLÉCOMMANDE IIIS /200	FERNBEDIENUNG SKABEL KOMPLETT IIIS /200	CABLE TELECOMANDO COMPLETO IIIS /200
32 2646170032	1 NR	CONNETTORE COLLEGAMENTO TELECOMANDO	CONNECTOR FOR REMOTE CONTROL	CONNECTEUR	VERBINGER	CONECTOR
33 1684540001	1 NR	DISPOSITIVO DI COMANDO PER ABILITAZIONE EMERGENZA A TERRA	CONTROL DEVICE FOR ACTIVATING THE EMERGENCY GROUND	DISPOSITIF DE COMMANDE EN CAS D'URGENCE	STEUERVORRICHTUNG IM NOTFALL	DISPOSITIVO DE CONTROL DE EMERGENCIA

 TELECOMANDO

 FERNSTEUERUNG 
 REMOTE CONTROL

 TELECOMANDO 
 TÉLÉCOMMANDE

POS Codice	Q.tà	 Descrizione	 Description	 Designation	 Benennung	 Descripcìon
34 07027200	1 NR	PROTEZIONE SINISTRA	LEFT PROTECTION	PROTECTION GAUCHE	ABDECKUNG LINKS	PROTECCIÓN IZQUIERDA
35 07027100	1 NR	PROTEZIONE DESTRA	RIGHT PROTECTION	PROTECTION DROITS	ABDECKUNG RECHTS	PROTECCIÓN DERECHA
36 27283000	1 NR	PUNTALINO FEMMINA PER CONNETTORE TELECOMANDO	TERMINAL FEMALE CONNECTOR FOR REMOTE CONTROL	CONNECTEUR FEMELLE	VERBINDUNG	CONECTOR
36 2728300001	1 NR	PUNTALINO MASCHIO PER CONNETTORE TELECOMANDO	TERMINAL MALE CONNECTOR FOR REMOTE CONTROL	CONNECTEUR	VERBINDER	CONECTOR
37 07320200	1 NR	SCHERMO LCD (PER RICAMBIO È NECESSARIO IL SN DEL TELECOMANDO)	DISPLAY (AS SPARE IS COMPULSORY THE SN OF REMOTE CONTROL)	ÉCRAN	DISPLAY	PANTALLA

 IMPIANTO ELETTRICO

ELEKTRISCHE ANLAGE 

 ELECTRICAL SYSTEM

INSTALACIÓN ELÉCTRICA 

 INSTALLATION ÉLECTRIQUE

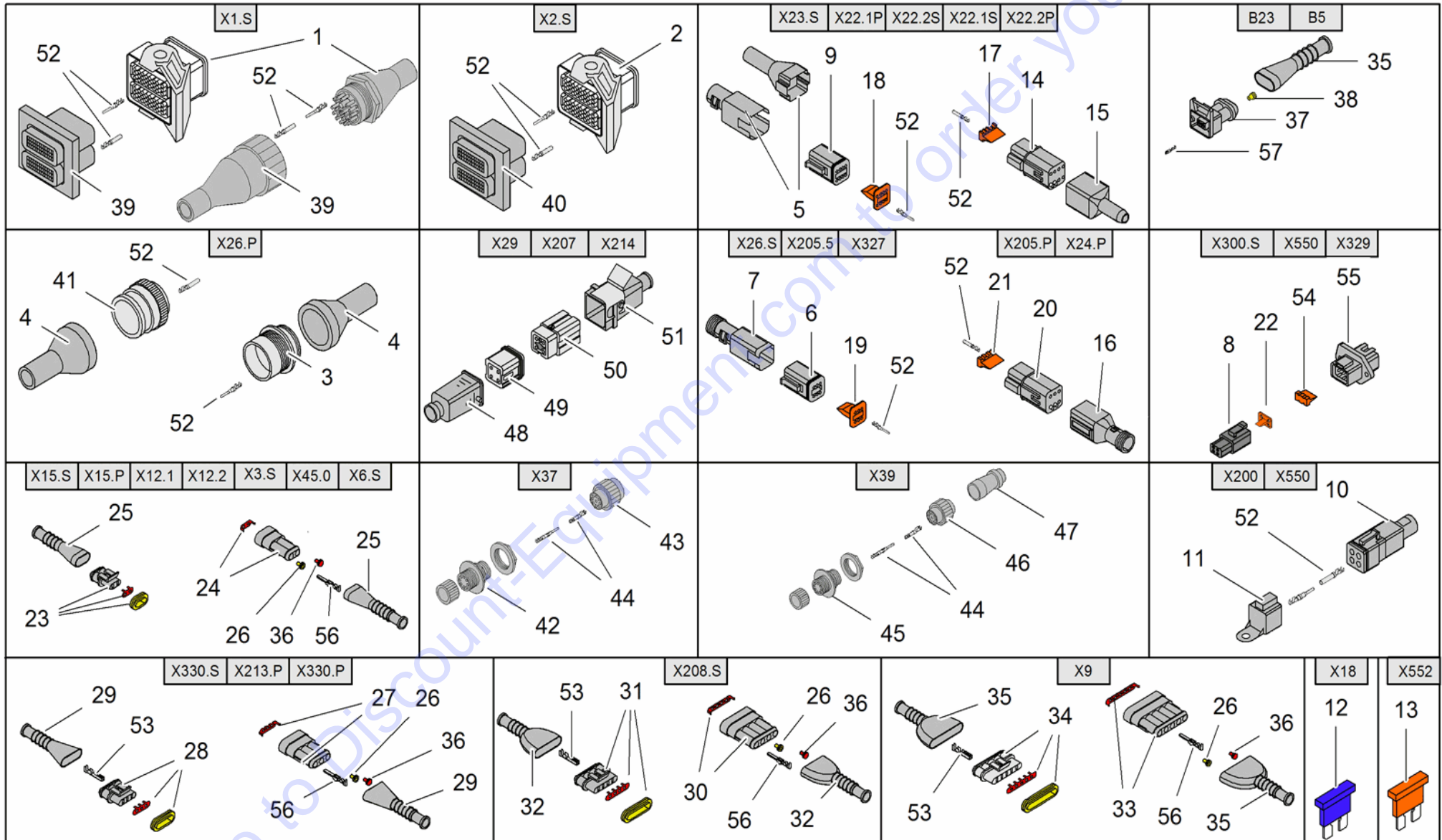





 IMPIANTO ELETTRICO

 ELEKTRISCHE ANLAGE

 ELECTRICAL SYSTEM

 INSTALACIÓN ELÉCTRICA

 INSTALLATION ÉLECTRIQUE

POS Codice	Q.tà	 Descrizione	 Description	 Designation	 Benennung	 Descripción
1 1730720066	1	NR				
1 1764250004	1	NR CONNETTORE ROTONDO 47VIE PM (X1) MK2 (DA C170000893)	CONNECTOR WAY ROUND PM (X1) MK2 (FROM C170000893)	CONNECTEUR MK2 (FROM C170000893)	VERBINDER MK2 (FROM C170000893)	CONECTADOR MK2 (FROM C170000893)
2 1730720067	1	NR CONNETTORE 64VIE PM (X2) POLAR "A"	CONNECTOR	CONNECTEUR	VERBINDER	CONECTADOR
3 1730720051	1	NR CONNETTORE 29 VIE M MOTORE (X26)	CONNECTOR	CONNECTEUR	VERBINDER	CONECTOR
4 1730720054	2	NR CAPPuccio POSTERIORE	CAP	CAPUCHON	KAPPE	CAPUCHO
4 1730720054	1	NR CAPPuccio POSTERIORE	CAP	CAPUCHON	KAPPE	CAPUCHO
5 1730720035	1	NR COVER POSTERIORE RIGIDA PER CONNETTORE 8 VIE MASCHIO	PROTECTION	PROTECTION	SCHUTZ	PROTECCION
5 1757250025	1	NR CAPPuccio POSTERIORE PER CONNETTORE MASCHIO	CAP	CAPUCHON	KAPPE	TAPA





 IMPIANTO ELETTRICO

 ELEKTRISCHE ANLAGE





 ELECTRICAL SYSTEM

 INSTALACIÓN ELÉCTRICA

 INSTALLATION ÉLECTRIQUE

POS Codice	Q.tà	 Descrizione	 Description	 Designation	 Benennung	 Descripción
6 1730720037	1 NR	CONNETTORE 6 VIE MASCHIO	6-WAY MALE CONNECTOR	CONNECTEUR 6 VOIES MÂLE	6-WEGE-VERBIN DER	CONECTOR 6 VÍAS
7 1730720039	1 NR	COVER POSTERIORE RIGIDA PER CONNETTORE 6 VIE MASCHIO	PROTECTION	PROTECTION	SCHUTZ	PROTECCION
8 1757250028	1 NR	CONNETTORE 4 VIE MASCHIO DEUTSCH PF POTENZA 25A	4-WAY MALE CONNECTOR 25A	CONNECTEUR 4 VOIES MÂLE 25A	4-WEGE-VERBIN DER STIFT 25A	CONECTOR 4 VÍAS MACHO 25A
9 1730720033	1 NR	CONNETTORE 8 VIE MASCHIO	8-WAY MALE CONNECTOR	CONNECTEUR 8 VOIES MÂLE	8-WEGE-VERBIN DER STIFT	CONECTOR 8 VÍAS MACHO
10 1763330001	1 NR	CONNETTORE 4 VIE MASCHIO DEUTSCH	4-WAY MALE CONNECTOR DEUTSCH	CONNECTEUR 4 VOIES MÂLE DEUTSCH	4-WEGE-VERBIN DER STIFT DEUTSCH	CONECTOR 4 VÍAS MACHO DEUTSCH
11 1763330002	1 NR	CAPPUCCIO FRONTALE CONNETTORE 4 VIE MASCHIO DEUTSCH	CAP FOR 4-WAY MALE CONNECTOR DEUTSCH	PAC CONNECTEUR 4 VOIES MÂLE DEUTSCH	CAP 4-WEGE-VERBIN DER STIFT DEUTSCH	CAP CONECTOR 4 VÍAS MACHO DEUTSCH
12 07700700	1 NR	FUSIBILE A LAMA 25A	FUSE 25A	FUSIBLE 25A	SICHERUNG 25A	FUSIBLE 25A
13 05760700	1 NR	FUSIBILE A LAMA 5A	FUSE 5A	FUSIBLE 5A	SICHERUNG 5A	FUSIBLE 5A

 IMPIANTO ELETTRICO
ELEKTRISCHE ANLAGE 
 ELECTRICAL SYSTEM
INSTALACIÓN ELÉCTRICA 
 INSTALLATION ÉLECTRIQUE

POS Codice	Q.tà	 Descrizione	 Description	 Designation	 Benennung	 Descripción
14 1730720029	1 NR	CONNETTORE 8 VIE FEMMINA	8-WAY FEMALE CONNECTOR	CONNECTEUR 8 VOIES FEMELLE	8-WEGE-VERBIN DER BÜCHSE	CONECTOR 8 VÍAS HEMBRA
15 1730720031	1 NR	COVER POSTERIORE RIGIDA PER CONNETTORE 8 VIE FEMMINA	PROTECTION	PROTECTION	SCHUTZ	PROTECCION
15 1757250026	1 NR	CAPPUCCIO POSTERIORE PER CONNETTORE FEMMINA	CAP	CAPUCHON	KAPPE	TAPA
16 1730720084	1 NR	COVER POSTERIORE RIGIDA PER CONNETTORE 6 VIE FEMMINA	PROTECTION	PROTECTION	SCHUTZ	PROTECCION
16 1757250027	1 NR	CAPPUCCIO POSTERIORE PER CONNETTORE 6 VIE FEMMINA	CAP	CAPUCHON	KAPPE	TAPA
17 1730720030	1 NR	PIASTRINA DI BLOCCAGGIO CONNETTORE 8 VIE FEMMINA	PLATE	PLAQUE	PLATTE	PLACA

# PARTS FINDER

**Search Website  
by Part Number**



**Search Manual  
Library For Parts  
Manual & Lookup Part  
Numbers – Purchase  
or Request Quote**

**Search Manuals**

Enter your information to help us find the right parts manual for your machine.

\* Brand:

\* Model:

\* Serial:

\* Part Number:

SEARCH

**Can't Find Part or  
Manual? Request Help  
by Manufacturer,  
Model & Description**

**Parts Order Form**

Please fill in the following information to help us find the right part for your machine.

Manufacturer:	<input type="text"/>
Model:	<input type="text"/>
Description:	<input type="text"/>
Part Number:	<input type="text"/>
Quantity:	<input type="text"/>
Notes:	<input type="text"/>

SEARCH

Discount-Equipment.com is your online resource for quality parts & equipment.





Florida: **561-964-4949** Outside Florida TOLL FREE: **877-690-3101**

**Need parts?**

Click on this link: <http://www.discount-equipment.com/category/5443-parts/> and choose one of the options to help get the right parts and equipment you are looking for. Please have the machine model and serial number available in order to help us get you the correct parts. If you don't find the part on the website or on one of the online manuals, please fill out the request form and one of our experienced staff members will get back to you with a quote for the right part that your machine needs.

We sell worldwide for the brands: Genie, Terex, JLG, MultiQuip, Mikasa, Essick, Whiteman, Mayco, Toro Stone, Diamond Products, Generac Magnum, Airman, Haulotte, Barreto, Power Blanket, Nifty Lift, Atlas Copco, Chicago Pneumatic, Allmand, Miller Curber, Skyjack, Lull, Skytrak, Tsurumi, Husquvarna Target, Stow, Wacker, Sakai, Mi-T-M, Sullair, Basic, Dynapac, MBW, Weber, Bartell, Bennar Newman, Haulotte, Ditch Runner, Menegotti, Morrison, Contec, Buddy, Crown, Edco, Wyco, Bomag, Laymor, EZ Trench, Bil-Jax, F.S. Curtis, Gehl Pavers, Heli, Honda, ICS/PowerGrit, IHI, Partner, Imer, Clipper, MMD, Koshin, Rice, CH&E, General Equipment, Amida, Coleman, NAC, Gradall, Square Shooter, Kent, Stanley, Tamco, Toku, Hatz, Kohler, Robin, Wisconsin, Northrock, Oztec, Toker TK, Rol-Air, APT, Wylie, Ingersoll Rand / Doosan, Innovatech, Con X, Ammann, Mecalac, Makinex, Smith Surface Prep, Small Line, Wanco, Yanmar

 IMPIANTO ELETTRICO
ELEKTRISCHE ANLAGE 
 ELECTRICAL SYSTEM
INSTALACIÓN ELÉCTRICA 
 INSTALLATION ÉLECTRIQUE

POS Codice	Q.tà	 Descrizione	 Description	 Designation	 Benennung	 Descripción
18 1730720034	1 NR	PIASTRINA DI BLOCCAGGIO CONNETTORE 8 VIE MASCHIO	PLATE	PLAQUE	PLATTE	PLACA
19 1730720038	1 NR	PIASTRINA DI BLOCCAGGIO CONNETTORE 6 VIE MASCHIO	PLATE	PLAQUE	PLATTE	PLACA
20 1730720041	1 NR	CONNETTORE 6 VIE FEMMINA	6-WAY FEMALE CONNECTOR	CONNECTEUR 6 VOIES FEMELLE	6-WEGE-VERBIN DER BUCHSE	CONNECTOR 6 VÍAS HEMBRA
21 1730720042	1 NR	PIASTRA BLOCCAGGIO CONNETTORE 6 VIE FEMMINA	CONNECTOR	CONNECTEUR	VERBINDER	CONNECTADOR
22 1757250029	1 NR	PIASTRINA DI BLOCCAGGIO CONNETTORE 4 VIE M POTENZA 25A	PLATE	PLAQUE	PLATTE	PLACA
23 1757250031	1 NR	CONNETTORE SUPERSEAL PF 2 VIE	CONNECTOR	CONNECTEUR	VERBINDER	CONNECTADOR







 IMPIANTO ELETTRICO

 ELEKTRISCHE ANLAGE





 ELECTRICAL SYSTEM

 INSTALACIÓN ELÉCTRICA

 INSTALLATION ÉLECTRIQUE

POS Codice	Q.tà	 Descrizione	 Description	 Designation	 Benennung	 Descripción
24 1730720024	1 NR	CONNETTORE 12 VIE F SCATOLA CELLA	CONNECTOR 12 WAY FEMALE CELL BOX			
24 1757250032	1 NR	CONNETTORE SUPERSEAL PM 2 VIE	CONNECTOR	CONNECTEUR	VERBINDER	CONECTADOR
25 1757250033	1 NR	CAPPUCCIO POSTERIOERE CONNETTORE SUPERSEAL 2 VIE	CAP	CAPUCHON	KAPPE	CAPUCHO
26 1757250043	1 NR	GOMMINO TENUTA PER CAVI CONNETTORI SUPERSEAL	RUBBER SEAL	JOINT EN CAOUTCHOUC	GUMMIDICHTUNG	JUNTA DE GOMA
27 1757250035	1 NR	CONNETTORE SUPERSEAL PM 3 VIE	CONNECTOR	CONNECTEUR	VERBINDER	CONECTADOR
28 1757250034	1 NR	CONNETTORE SUPERSEAL PF 3 VIE	CONNECTOR	CONNECTEUR	VERBINDER	CONECTADOR
29 1757250036	1 NR	CAPPUCCIO POSTERIOERE CONNETTORE SUPERSEAL 3 VIE	CAP	CAPUCHON	KAPPE	CAPUCHO

 IMPIANTO ELETTRICO
ELEKTRISCHE ANLAGE 
 ELECTRICAL SYSTEM
INSTALACIÓN ELÉCTRICA 
 INSTALLATION ÉLECTRIQUE

POS Codice	Q.tà	 Descrizione	 Description	 Designation	 Benennung	 Descripción
30 1757250038	1 NR	CONNETTORE SUPERSEAL PM 4 VIE	CONNECTOR	CONNECTEUR	VERBINDER	CONECTADOR
31 1757250037	1 NR	CONNETTORE SUPERSEAL PF 4 VIE	CONNECTOR	CONNECTEUR	VERBINDER	CONECTADOR
32 1757250039	1 NR	CAPPUCCIO POSTERIORE CONNETTORE SUPERSEAL 4 VIE	CAP	CAPUCHON	KAPPE	CAPUCHO
33 1757250041	1 NR	CONNETTORE SUPERSEAL PM 5 VIE	CONNECTOR	CONNECTEUR	VERBINDER	CONECTADOR
34 1757250040	1 NR	CONNETTORE SUPERSEAL PF 5 VIE	CONNECTOR	CONNECTEUR	VERBINDER	CONECTADOR
35 1757250042	1 NR	CAPPUCCIO POSTERIOERE CONNETTORE SUPERSEAL 5-6 VIE	CAP	CAPUCHON	KAPPE	CAPUCHO
36 1757250046	1 NR	GOMMINO TENUTA TAPPO PER CONNETTORI SUPERSEAL	RUBBER SEAL	JOINT EN CAOUTCHOUC	GUMMIDICHTUNG	JUNTA DE GOMA





 IMPIANTO ELETTRICO

 ELEKTRISCHE ANLAGE





 ELECTRICAL SYSTEM

 INSTALACIÓN ELÉCTRICA





 INSTALLATION ÉLECTRIQUE

POS Codice	Q.tà	 Descrizione	 Description	 Designation	 Benennung	 Descripción
37 1757250044	1 NR	CONNETTORE JPT 2 VIE PER ELETTRICITÀ	CONNECTOR	CONNECTEUR	VERBINDER	CONECTADOR
38 1757250045	1 NR	GOMMINO TENUTA PER CAVI CONNETTORI JPT	RUBBER SEAL	JOINT EN CAOUTCHOUC	GUMMIDICHTUNG	JUNTA DE GOMA
39 1730720064	1 NR	CONNETTORE 50VIE PF (X1)	CONNECTOR 50 WAY PF (X1)			
39 1764250006	1 NR	CONNETTORE ROTONDO 47VIE PF (X1) MK2 (DA C170000893)	CONNECTOR 47 WAY ROUND PF (X1) MK2 (FROM C170000893)	CONNECTEUR MK2 (FROM C170000893)	VERBINDER MK2 (FROM C170000893)	CONECTADOR MK2 (FROM C170000893)
40 1730720065	1 NR	CONNETTORE 64VIE PF (X2) POLAR A	CONNECTOR	CONNECTEUR	VERBINDER	CONECTADOR
41 1730720059	1 NR	CONNETTORE 29 VIE F MOTORE (X26)	CONNECTOR	CONNECTEUR	VERBINDER	CONECTADOR
42 1730720019	1 NR	CONNETTORE 19 VIE F SCATOLA CELLA (X37)	CONNECTOR 19 WAY FEMALE CELL BOX (X 37)			
43 1730720020	1 NR	CONNETTORE 19 VIE M SCATOLA CELLA (X37)	CONNECTOR 19 WAY MALE CELL BOX (X 37)			

 IMPIANTO ELETTRICO
ELEKTRISCHE ANLAGE 
 ELECTRICAL SYSTEM
INSTALACIÓN ELÉCTRICA 
 INSTALLATION ÉLECTRIQUE

POS Codice	Q.tà	 Descrizione	 Description	 Designation	 Benennung	 Descripción
44 1730720022	1 NR	TERMINALE MASCHIO 16A (X37)	TERMINAL MALE 16A (X37)	MALE TERMINAL	TERMINAL MALE	MALE TERMINAL
44 1730720022	19 NR	TERMINALE MASCHIO 16A (X37)	TERMINAL MALE 16A (X37)	MALE TERMINAL	TERMINAL MALE	MALE TERMINAL
44 1730720023	1 NR	TERMINALE FEMMINA 16A (X37)	TERMINAL FEMALE 16A (X37)	BORNE FEMELLE	TERMINAL FEMALE	TERMINAL HEMBRA
44 1730720023	19 NR	TERMINALE FEMMINA 16A (X37)	TERMINAL FEMALE 16A (X37)	BORNE FEMELLE	TERMINAL FEMALE	TERMINAL HEMBRA
44 1730720025	7 NR	TERMINALE F 0,25-0,50 MMQ (X39)	TERMINAL F 0.25-0.50 MMQ (X39)	TERMINAL	TERMINAL	TERMINAL
44 1730720025	15 NR	TERMINALE F 0,25-0,50 MMQ (X39)	TERMINAL F 0.25-0.50 MMQ (X39)	TERMINAL	TERMINAL	TERMINAL
44 1730720025	1 NR	TERMINALE F 0,25-0,50 MMQ (X39)	TERMINAL F 0.25-0.50 MMQ (X39)	TERMINAL	TERMINAL	TERMINAL
44 1730720027	10 NR	TERMINALE M 0,25-0,50 MMQ (X39)	TERMINAL M 0.25-0.50 MMQ (X39)	TERMINAL	TERMINAL	TERMINAL

 IMPIANTO ELETTRICO
ELEKTRISCHE ANLAGE 
 ELECTRICAL SYSTEM
INSTALACIÓN ELÉCTRICA 
 INSTALLATION ÉLECTRIQUE

POS Codice	Q.tà	 Descrizione	 Description	 Designation	 Benennung	 Descripción
44 1730720027	1 NR	TERMINALE M 0,25-0,50 MMQ (X39)	TERMINAL M 0.25-0.50 MMQ (X39)	TERMINAL	TERMINAL	TERMINAL
44 1730720027	15 NR	TERMINALE M 0,25-0,50 MMQ (X39)	TERMINAL M 0.25-0.50 MMQ (X39)	TERMINAL	TERMINAL	TERMINAL
44 1730720027	7 NR	TERMINALE M 0,25-0,50 MMQ (X39)	TERMINAL M 0.25-0.50 MMQ (X39)	TERMINAL	TERMINAL	TERMINAL
46 1730720026	1 NR	CONNETTORE 12 VIE M SCATOLA CELLA (X39)	CONNECTOR 12 WAY MALE BOX CELL (X39)			
47 1730720028	1 NR	FERMA CAVO CONNETTORE 12 VIE M SCATOLA CELLA (X39)	LOCK CABLE CONNECTOR 12 WAY MALE BOX CELL (X39)			
48 1730720083	1 NR	CUSTODIA 3 POLI GRIGIA VOLANTE PER CONN.PM 4+1VIE 230/110V (X29)	HOUSING 3 POLE GREY FOR CONN. PM 4 + 1 WAY 230V / 110V (X29)			
49 1730720082	1 NR	FRUTTO CONN.PM 4+1VIE 230/110V (X29)	CONNECTOR PM 4 + 1 WAY 230V / 110V (X 29)			
50 1730720080	1 NR	FRUTTO CONN. PF 4+1 VIA 230/110V (X29)	CONNECTOR PF 4 + 1 WAY 230V / 110V (X 29)			





 IMPIANTO ELETTRICO

ELEKTRISCHE ANLAGE 

 ELECTRICAL SYSTEM





INSTALACIÓN ELÉCTRICA 

 INSTALLATION ÉLECTRIQUE





POS Codice	Q.tà	 Descrizione	 Description	 Designation	 Benennung	 Descripcìon
51 1730720081	1 NR	CUSTODIA 3 POLI GRIGIA CON GANCIO PER CONN. PF 4+1 VIA 230/110V (X29)	HOUSING 3 POLE GREY WITH HOOK FOR CONN. PF 4 + 1 ROUTE 230 / 110V (X29)			

Go to Discount-Equipment.com to order your parts

 IMPIANTO ELETTRICO
ELEKTRISCHE ANLAGE 
 ELECTRICAL SYSTEM
INSTALACIÓN ELÉCTRICA 
 INSTALLATION ÉLECTRIQUE





POS Codice	Q.tà	 Descrizione	 Description	 Designation	 Benennung	 Descripción
52 1730720069	1 NR	CONTATTO FEMMINA 25A CONNETTORE M CAVO 2.5-4	CONTACT FEMALE 25A MALE CONNECTOR CABLE 2.5-4	CONTACT FEMELLE 25A	KONTAKT BUCHSE 25A	CONTACT HEMBRA 25A
52 1730720031	1 NR	COVER POSTERIORE RIGIDA PER CONNETTORE 8 VIE FEMMINA	PROTECTION	PROTECTION	SCHUTZ	PROTECCION
52 1730720032	25 NR	TERMINALE MASCHIO CAVO 0.75-1.5	TERMINAL MALE CABLE 0.75-1.5	MALE TERMINAL	TERMINAL MALE	MALE TERMINAL
52 1730720032	1 NR	TERMINALE MASCHIO CAVO 0.75-1.5	TERMINAL MALE CABLE 0.75-1.5	MALE TERMINAL	TERMINAL MALE	MALE TERMINAL
52 1730720032	30 NR	TERMINALE MASCHIO CAVO 0.75-1.5	TERMINAL MALE CABLE 0.75-1.5	MALE TERMINAL	TERMINAL MALE	MALE TERMINAL
52 1730720032	10 NR	TERMINALE MASCHIO CAVO 0.75-1.5	TERMINAL MALE CABLE 0.75-1.5	MALE TERMINAL	TERMINAL MALE	MALE TERMINAL
52 1730720036	15 NR	TERMINALE FEMMINA CONNETTORE M CAVO 0.5-1	TERMINAL FEMALE MALE CONNECTOR CABLE 0.5-1	BORNE FEMELLE	TERMINAL FEMALE	TERMINAL HEMBRA

 IMPIANTO ELETTRICO
ELEKTRISCHE ANLAGE 
 ELECTRICAL SYSTEM
INSTALACIÓN ELÉCTRICA 
 INSTALLATION ÉLECTRIQUE

POS Codice	Q.tà	 Descrizione	 Description	 Designation	 Benennung	 Descripción
52 1730720036	1 NR	TERMINALE FEMMINA CONNETTORE M CAVO 0.5-1	TERMINAL FEMALE MALE CONNECTOR CABLE 0.5-1	BORNE FEMELLE	TERMINAL FEMALE	TERMINAL HEMBRA
52 1730720036	30 NR	TERMINALE FEMMINA CONNETTORE M CAVO 0.5-1	TERMINAL FEMALE MALE CONNECTOR CABLE 0.5-1	BORNE FEMELLE	TERMINAL FEMALE	TERMINAL HEMBRA
52 1730720036	10 NR	TERMINALE FEMMINA CONNETTORE M CAVO 0.5-1	TERMINAL FEMALE MALE CONNECTOR CABLE 0.5-1	BORNE FEMELLE	TERMINAL FEMALE	TERMINAL HEMBRA
52 1730720036	4 NR	TERMINALE FEMMINA CONNETTORE M CAVO 0.5-1	TERMINAL FEMALE MALE CONNECTOR CABLE 0.5-1	BORNE FEMELLE	TERMINAL FEMALE	TERMINAL HEMBRA
52 1730720040	2 NR	TERMINALE FEMMINA (X24)	TERMINAL FEMALE (X24)	BORNE FEMELLE (X24)	TERMINAL FEMALE (X24)	TERMINAL HEMBRA (X24)
52 1730720040	10 NR	TERMINALE FEMMINA (X24)	TERMINAL FEMALE (X24)	BORNE FEMELLE (X24)	TERMINAL FEMALE (X24)	TERMINAL HEMBRA (X24)
52 1730720040	1 NR	TERMINALE FEMMINA (X24)	TERMINAL FEMALE (X24)	BORNE FEMELLE (X24)	TERMINAL FEMALE (X24)	TERMINAL HEMBRA (X24)
52 1730720040	15 NR	TERMINALE FEMMINA (X24)	TERMINAL FEMALE (X24)	BORNE FEMELLE (X24)	TERMINAL FEMALE (X24)	TERMINAL HEMBRA (X24)



 IMPIANTO ELETTRICO
ELEKTRISCHE ANLAGE 
 ELECTRICAL SYSTEM
INSTALACIÓN ELÉCTRICA 
 INSTALLATION ÉLECTRIQUE

POS Codice	Q.tà	 Descrizione	 Description	 Designation	 Benennung	 Descripción
52 1730720043	15 NR	TERMINALE MASCHIO (X24) DA 0.5 A 0.75	TERMINAL MALE (X24) DA 0.5 A 0.75	BORNE MALE (X24)	TERMINAL MALE (X24)	TERMINAL MACHO (X24)
52 1730720043	1 NR	TERMINALE MASCHIO (X24) DA 0.5 A 0.75	TERMINAL MALE (X24) DA 0.5 A 0.75	BORNE MALE (X24)	TERMINAL MALE (X24)	TERMINAL MACHO (X24)
52 1730720043	10 NR	TERMINALE MASCHIO (X24) DA 0.5 A 0.75	TERMINAL MALE (X24) DA 0.5 A 0.75	BORNE MALE (X24)	TERMINAL MALE (X24)	TERMINAL MACHO (X24)
52 1730720055	10 NR	CONTATTO MASCHIO 25A CAVO 2.5-4	CONTACT MALE 25A CABLE 2.5-4	CONTACT MALE 25A	CONTACT MALE 25A	CONTACT MALE 25A
52 1730720055	1 NR	CONTATTO MASCHIO 25A CAVO 2.5-4	CONTACT MALE 25A CABLE 2.5-4	CONTACT MALE 25A	CONTACT MALE 25A	CONTACT MALE 25A
52 1730720055	5 NR	CONTATTO MASCHIO 25A CAVO 2.5-4	CONTACT MALE 25A CABLE 2.5-4	CONTACT MALE 25A	CONTACT MALE 25A	CONTACT MALE 25A
52 1730720056	5 NR	TAPPO SIZE 12-16 (X26)	CAP SIZE 12-16 (X26)	CAP TAILLE 12-16 (X26)	CAP SIZE 12-16 (X26)	CAP TAMAÑO 12-16 (X26)
52 1730720056	1 NR	TAPPO SIZE 12-16 (X26)	CAP SIZE 12-16 (X26)	CAP TAILLE 12-16 (X26)	CAP SIZE 12-16 (X26)	CAP TAMAÑO 12-16 (X26)
52 1730720056	10 NR	TAPPO SIZE 12-16 (X26)	CAP SIZE 12-16 (X26)	CAP TAILLE 12-16 (X26)	CAP SIZE 12-16 (X26)	CAP TAMAÑO 12-16 (X26)
52 1730720057	10 NR	TAPPO SIZE 16 (X26)	CAP SIZE 16 (X26)	PLUG SIZE 16 (X26)	PLUG SIZE 16 (X26)	MACHO TALLA 16 (X26)





 IMPIANTO ELETTRICO

 ELEKTRISCHE ANLAGE





 ELECTRICAL SYSTEM

 INSTALACIÓN ELÉCTRICA

 INSTALLATION ÉLECTRIQUE

POS Codice	Q.tà	 Descrizione	 Description	 Designation	 Benennung	 Descripción
52 1730720057	20 NR	TAPPO SIZE 16 (X26)	CAP SIZE 16 (X26)	PLUG SIZE 16 (X26)	PLUG SIZE 16 (X26)	MACHO TALLA 16 (X26)
52 1730720057	1 NR	TAPPO SIZE 16 (X26)	CAP SIZE 16 (X26)	PLUG SIZE 16 (X26)	PLUG SIZE 16 (X26)	MACHO TALLA 16 (X26)
52 1730720058	1 NR	CONTATTO MASCHIO 7.5A (X26)	CONTACT PIN 7.5A (X26)	CONTACT PIN 7.5A (X26)	CONTACT PIN 7.5A (X26)	CONTACT 7.5A (X26)
52 1730720058	100 NR	CONTATTO MASCHIO 7.5A (X26)	CONTACT PIN 7.5A (X26)	CONTACT PIN 7.5A (X26)	CONTACT PIN 7.5A (X26)	CONTACT 7.5A (X26)
52 1730720058	15 NR	CONTATTO MASCHIO 7.5A (X26)	CONTACT PIN 7.5A (X26)	CONTACT PIN 7.5A (X26)	CONTACT PIN 7.5A (X26)	CONTACT 7.5A (X26)
52 1730720061	1 NR	CONTATTO FEMMINA 7.5A (X26)	CONTACT FEMALE 7.5A (X26)	CONTACTER 7,5 FEMELLE (X26)	CONTACT FEMALE 7.5A (X26)	CONTACT 7.5A FEMENINO (X26)
52 1730720061	10 NR	CONTATTO FEMMINA 7.5A (X26)	CONTACT FEMALE 7.5A (X26)	CONTACTER 7,5 FEMELLE (X26)	CONTACT FEMALE 7.5A (X26)	CONTACT 7.5A FEMENINO (X26)
52 1730720061	100 NR	CONTATTO FEMMINA 7.5A (X26)	CONTACT FEMALE 7.5A (X26)	CONTACTER 7,5 FEMELLE (X26)	CONTACT FEMALE 7.5A (X26)	CONTACT 7.5A FEMENINO (X26)
52 1730720068	5 NR	TAPPO SIZE 20 (X1)	CAP SIZE 20 (X1)	PLUG SIZE 20 (X1)	PLUG SIZE 20 (X1)	TAMAÑO DE ENCHUFE 20 (X1)

 IMPIANTO ELETTRICO
ELEKTRISCHE ANLAGE 
 ELECTRICAL SYSTEM
INSTALACIÓN ELÉCTRICA 
 INSTALLATION ÉLECTRIQUE

POS Codice	Q.tà	 Descrizione	 Description	 Designation	 Benennung	 Descripción
52 1730720068	1 NR	TAPPO SIZE 20 (X1)	CAP SIZE 20 (X1)	PLUG SIZE 20 (X1)	PLUG SIZE 20 (X1)	TAMAÑO DE ENCHUFE 20 (X1)
52 1730720069	10 NR	CONTATTO FEMMINA 25A CONNETTORE M CAVO 2.5-4	CONTACT FEMALE 25A MALE CONNECTOR CABLE 2.5-4	CONTACT FEMELLE 25A	KONTAKT BUCHSE 25A	CONTACT HEMBRA 25A
53 1757250048	1 NR	PUNTALINO FEMMINA PER SUPERSEAL	FERRULE FEMALE FOR SUPERSEAL			
54 1757250030	1 NR	PIASTRINA DI BLOCCAGGIO CONNETTORE 4 VIE FEMMINA POTENZA 25A	PLATE	PLAQUE	PLATTE	PLACA
55 1757250018	1 NR	CONNETTORE 4 VIE DEUTSCH A PARETE PM POTENZA 25A (X300)	CONNECTOR	CONNECTEUR	VERBINDER	CONECTADOR
56 1757250049	1 NR	PUNTALINO MASCHIO PER SUPERSEAL	FERRULE MALE FOR SUPERSEAL			
57 1739150047	1 NR	CONTATTO FEMMINA PER CONNETTORE JPT	CONTACT FEMALE FOR CONNECTOR JPT	CONTACT FEMELLE POUR CONNECTEUR JPT	KONTAKT BUCHSE FÜR JPT VERBINDER	CONTACTO HEMBRA PARA CONECTOR JPT

 IMPIANTO ELETTRICO

ELEKTRISCHE ANLAGE 

 ELECTRICAL SYSTEM

INSTALACIÓN ELÉCTRICA 

 INSTALLATION ÉLECTRIQUE

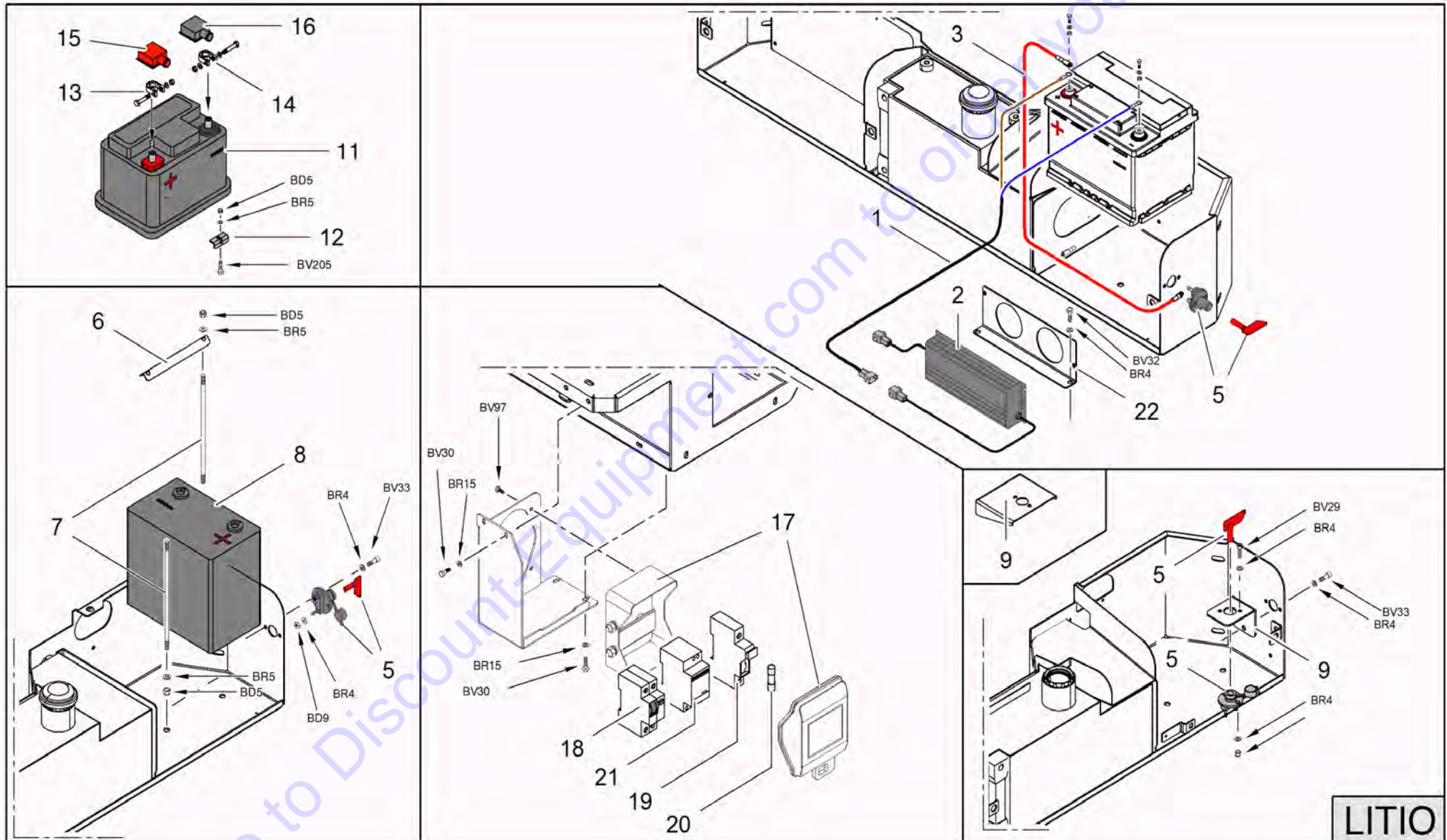





 IMPIANTO ELETTRICO

 ELEKTRISCHE ANLAGE





 ELECTRICAL SYSTEM

 INSTALACIÓN ELÉCTRICA





 INSTALLATION ÉLECTRIQUE

POS Codice	Q.tà	 Descrizione	 Description	 Designation	 Benennung	 Descripción
1 1764260002	1 NR	LINEA DA ALIMENTATORE A BATTERIA COMPLETA DI CONNETTORI E DIODO	LINE FROM CHARGER TO BATTERY WITH CONNECTORS AND DIODE			
2 1757250007	1 NR	ALIMENTATORE ELETTRONICO 285W REGOLABILE IP65 PER BATTERIE 55-75 AH COMPLETO DI CONNETTORI	ELECTRONIC BALLAST	ALIMENTATEUR ÉLECTRONIQUE	ELEKTRONISCHE S NETZGERÄT	ALIMENTADOR ELETRÓNICO
3 1764260001	1 NR	CAVO POSITIVO BATTERIA	12V BATTERY CABLE			
5 04774900	1 NR	STACCA BATTERIA	BATTERY CUT-OFF DEVICE	COUPE BATTERIE	BATTERIETRENN SCHALTER	CORTA-BATERÍA
6 05561800	1 NR	LAMIERA	PLATE	TÔLE	BLECH	CHAPA
7 06551000	2 NR	TIRANTE	TIE ROD	TIRANT	TURMGESTÄNGE	TIRANTE
8 26550700	1 NR	BATTERIA	BATTERY	BATTERIE	BATTERIE	BATERÍA

 IMPIANTO ELETTRICO
ELEKTRISCHE ANLAGE 
 ELECTRICAL SYSTEM
INSTALACIÓN ELÉCTRICA 
 INSTALLATION ÉLECTRIQUE

POS Codice	Q.tà	 Descrizione	 Description	 Designation	 Benennung	 Descripción
9 069226Y1	1 NR	SUPPORTO	SUPPORT	SUPPORT	HALTERUNG	SOPORTE
9 074167Y1	1 NR	PIEGATO PER STACCABATTERIA A MK2 (FROM C170000893)	SUPPORT FOR BATTERY CUTOFF MK2 (FROM C170000893)	SUPPORT POUR COUPE BATTERIE MK2 (FROM C170000893)	HALTERUNG FÜR BATTERIETRENN SCHALTER MK2 (FROM C170000893)	SOPORTE PARA DESCONECTADO R DE BATERÍA MK2 (FROM C170000893)
11 27668600	1 NR	BATTERIA AGM S&S 12V 60AH 680A L02	BATTERY AGM S&S 12V 60AH 680A L02	BATTERIE AGM S&S 12V 60AH 680A L02	BATTERIE AGM S&S 12V 60AH 680A L02	BATERÍA AGM S&S 12V 60AH 680A L02
12 051705Y1	2 NR	PIATTO FERMO BATTERIA	BATTERY BLOCK PLATE	PLACQUE D'ATTERT BATTERIE	BLOCKPLATTE BATTERIE	PLATO DE SUJECIÓN BATERÍA
13 1739150023	1 NR	MORSETTO POSITIVO A C PER BATTERIA M10	POSITIVE BATTERY CLAMP "C" M10	BORNE POSITIVE A C POUR BATTERIE M10	POSITIVE KLEMME FÜR BATTERIE M10	BORNE POSITIVO A C PARA BATERÍA M10
14 1739150025	1 NR	MORSETTO NEGATIVO A C PER BATTERIA M10	NEGATIVE BATTERY TERMINAL C M10	BORNE NEGATIVE A C POUR BATTERIE M10	NEGATIVE KLEMME FÜR BATTERIE M10	BORNE NEGATIVO A C PARA BATERÍA M10
15 2632920007	1 NR	COPRI POLI BATTERIA QUADRATO ROSSO	POLE BATTERY COVER RED SQUARE	POLE CACHE BATTERIE RED SQUARE	POLE BATTERY COVER RED SQUARE	TAPAS DE LA BATERIA

 IMPIANTO ELETTRICO
ELEKTRISCHE ANLAGE 
 ELECTRICAL SYSTEM
INSTALACIÓN ELÉCTRICA 
 INSTALLATION ÉLECTRIQUE

POS Codice	Q.tà	 Descrizione	 Description	 Designation	 Benennung	 Descripción
16 2632920008	1 NR	COPRI POLI BATTERIA QUADRATO NERO	POLE BATTERY COVER BLACK SQUARE	POLE BATTERIE COUVERTURE CARRÉ NOIR	POLE BATTERY COVER BLACK SQUARE	TAPAS BATERIA
17 1730720006	1 NR	SCATOLA ELETTRICA MAGNETOTERMI CO FORATA CIAM	ELECTRICAL MAGNETOTHERM IC BOX DRILLED CIAM	BOÎTE ÉLECTRIQUE	ELEKTROGEHÄU SE	CAJA ELÉCTRICA
17 1757250008	1 NR	SCATOLA ELETTRICO PLASTICA 6 MODULI BI COPERCHIO TRASPARENTE	ELECTRICAL BOX	BOÎTE ÉLECTRIQUE	SCHALTKASTEN	CAJA ELÉCTRICA
18 1556350015	1 NR	INTERUTTORE AUTOMATICO MAGNETOTERMI CO 220V	AUTOMATIC THERMAL SWITCH 220V	INTERRUPTEUR	INTERRUPTORES	INTERRUPTOR
18 1556350063	1 NR	INTERUTTORE AUTOMATICO MAGNETOTERMI CO 110-120V 25A (FINO A C170000355 MONTATO C16 SU MACCHINE 120V)	AUTOMATIC THERMAL SWITCH 110-120V 25A (UNTIL C170000355 MOUNTED C16 ON 120V MACHINES)	INTERRUPTEUR	SCHALTER	INTERRUPTOR





 IMPIANTO ELETTRICO

ELEKTRISCHE ANLAGE 

 ELECTRICAL SYSTEM



INSTALACIÓN ELÉCTRICA 



 INSTALLATION ÉLECTRIQUE

POS Codice	Q.tà	 Descrizione	 Description	 Designation	 Benennung	 Descripcìon
19 1730720015	1 NR	PORTAFUSIBILE A TUBO 220/110V	FUSE HOLDER TUBE 220/110V	BOÎTE À FUSIBLES	SICHERUNGSKA STEN	PORTAFUSIBLES
20 1730720017	1 NR	FUSIBILE A TUBO 10A	TUBE FUSE 10A	FUSIBLE	SICHERUNG	FUSIBLE
21 1757250006	1 NR	TELERUTTORE 4POLI 63A CA/CC	RELAY	RELAIS	RELAIS	RELÉ
22 076841Y1	1 NR	STAFFA FISSAGGIO ALIMENTATORE	PLATE SUPPORT BATTERY CHARGER			



Go to Discount-Equipment.com to Order your parts





-  ADESIVI
-  STICKER
-  AUTOCOLLANT

- AUFKLEBER 
- PEGATINA 



Go to [Discount-Equipment.com](http://Discount-Equipment.com) to order your parts



 ADESIVI  
 STICKER  
 AUTOCOLLANT





AUFKLEBER   
PEGATINA 



POS Codice	Q.tà	 Descrizione	 Description	 Designation	 Benennung	 Descripcìon
------------	------	---	---	---	---	---



Go to Discount-Equipment.com to order your parts





 ADESIVI  
 STICKER  
 AUTOCOLLANT



AUFKLEBER   
 PEGATINA 



POS Codice	Q.tà	 Descrizione	 Description	 Designation	 Benennung	 Descripcìon
0 06039600	8 NR	ADESIVO	STICKER	AUTOCOLLANT	AUFKLEBER	PEGATINA
0 06039700	1 NR	ADESIVO	STICKER	AUTOCOLLANT	AUFKLEBER	PEGATINA
0 06040100	8 NR	ADESIVO	STICKER	AUTOCOLLANT	AUFKLEBER	PEGATINA
0 06040500	2 NR	ADESIVO	STICKER	AUTOCOLLANT	AUFKLEBER	PEGATINA
0 06041600	1 NR	ADESIVO CARBURANTE BENZINA COLORE VERDE L=60 X 80 (**)	DECAL	AUTOCOLLANT	AUFKLEBER	PEGATINA
0 06043900	1 NR	ADESIVO	STICKER	AUTOCOLLANT	AUFKLEBER	PEGATINA
0 06056300	1 NR	ADESIVO	STICKER	AUTOCOLLANT	AUFKLEBER	PEGATINA
0 06060000	1 NR	ADESIVO	STICKER	AUTOCOLLANT	AUFKLEBER	PEGATINA
0 06086700	6 NR	ADESIVO	STICKER	AUTOCOLLANT	AUFKLEBER	PEGATINA
0 06164600	1 NR	ADESIVO	STICKER	AUTOCOLLANT	AUFKLEBER	PEGATINA
0 06164700	1 NR	ADESIVO	STICKER	AUTOCOLLANT	AUFKLEBER	PEGATINA
0 06165000	1 NR	ADESIVO	STICKER	AUTOCOLLANT	AUFKLEBER	PEGATINA
0 06214200	1 NR	ADESIVO	STICKER	AUTOCOLLANT	AUFKLEBER	PEGATINA





 ADESIVI  
 STICKER  
 AUTOCOLLANT



AUFKLEBER   
 PEGATINA 



POS Codice	Q.tà	 Descrizione	 Description	 Designation	 Benennung	 Descripcìon
0 06227200	1 NR	ADESIVO "CONTROLLARE LIVELLO OLIO MOTORE " 7 LINGUE GIALLO L=82X108 (**)	DECAL	AUTOCOLLANT	AUFKLEBER	PEGATINA
0 06232100	1 NR	ADESIVO	STICKER	AUTOCOLLANT	AUFKLEBER	PEGATINA
0 06506400	1 NR	ADESIVO	STICKER	AUTOCOLLANT	AUFKLEBER	PEGATINA
0 06520600	2 NR	ADESIVO	STICKER	AUTOCOLLANT	AUFKLEBER	PEGATINA
0 06555500	1 NR	ADESIVO	STICKER	AUTOCOLLANT	AUFKLEBER	PEGATINA
0 06555600	1 NR	ADESIVO	STICKER	AUTOCOLLANT	AUFKLEBER	PEGATINA
0 06555700	1 NR	ADESIVO	STICKER	AUTOCOLLANT	AUFKLEBER	PEGATINA
0 06555800	1 NR	ADESIVO	STICKER	AUTOCOLLANT	AUFKLEBER	PEGATINA
0 06561200	7 NR	ADESIVO	STICKER	AUTOCOLLANT	AUFKLEBER	PEGATINA
0 06561200	5 NR	ADESIVO	STICKER	AUTOCOLLANT	AUFKLEBER	PEGATINA
0 06706500	1 NR	ADESIVO	STICKER	AUTOCOLLANT	AUFKLEBER	PEGATINA
0 06840400	1 NR					
0 06998800	1 NR	ADESIVO	STICKER	AUTOCOLLANT	AUFKLEBER	PEGATINA
0 07034200	2 NR	ADESIVO	STICKER	AUTOCOLLANT	AUFKLEBER	PEGATINA





 ADESIVI  
 STICKER  
 AUTOCOLLANT



AUFKLEBER   
 PEGATINA 



POS Codice	Q.tà	 Descrizione	 Description	 Designation	 Benennung	 Descripcìon
0 07056400	4 NR	ADESIVO	STICKER	AUTOCOLLANT	AUFKLEBER	PEGATINA
0 07056700	8 NR	ADESIVO	STICKER	AUTOCOLLANT	AUFKLEBER	PEGATINA
0 07056700	6 NR	ADESIVO	STICKER	AUTOCOLLANT	AUFKLEBER	PEGATINA
0 07060500	2 NR	ADESIVO	STICKER	AUTOCOLLANT	AUFKLEBER	PEGATINA
0 07060700	2 NR	ADESIVO	STICKER	AUTOCOLLANT	AUFKLEBER	PEGATINA
0 07071000	1 NR	ADESIVO	STICKER	AUTOCOLLANT	AUFKLEBER	PEGATINA
0 07071200	4 NR	ADESIVO	STICKER	AUTOCOLLANT	AUFKLEBER	PEGATINA
0 07240300	1 NR	ADESIVO	STICKER	AUTOCOLLANT	AUFKLEBER	PEGATINA
0 07264700	1 NR	ADESIVO INDICATORE LED CARICABATTERIE 48V (Ø EST.31MM Ø INT.6 MM) VECCHIO BMS (FINO A C170000329)	DECAL	AUTOCOLLANT	AUFKLEBER	PEGATINA
0 07264800	2 NR	ADESIVO	DECAL	AUTOCOLLANT	AUFKLEBER	PEGATINA
0 07268300	4 NR	ADESIVO	DECAL	AUTOCOLLANT	AUFKLEBER	PEGATINA
0 07350300	4 NR	ADESIVO	DECAL	AUTOCOLLANT	AUFKLEBER	PEGATINA





 ADESIVI  
 STICKER  
 AUTOCOLLANT

AUFKLEBER   
 PEGATINA 

POS Codice	Q.tà	 Descrizione	 Description	 Designation	 Benennung	 Descripcìon
0 07394800	1 NR	ADESIVO INDICATORE LED CARICABATTERIE 48V (Ø EST.31MM Ø INT.6 MM) NUOVO BMS/4 (DA C170000330)	DECAL	AUTOCOLLANT	AUFKLEBER	PEGATINA
0 07495700	2 NR	ADESIVO JLG LOGO X600AJ COLORE GRIGIO PANTONE 432C L= 200X43 MM	DECAL	AUTOCOLLANT	AUFKLEBER	PEGATINA
0 07499300	1 NR	ADESIVO DON'T OPEN THE CASE SFONDO GIALLO L=60X17 MM	DECAL	AUTOCOLLANT	AUFKLEBER	PEGATINA
0 07512700	1 NR	ADESIVO ATTENZIONE! NON COLLEGARE IL COMPUTER L=75X75 MM	STICKER	AUTOCOLLANT	AUFKLEBER	PEGATINA
0 07526800	4 NR	ADESIVO REAZIONE AL SUOLO STABILIZZATORI X600AJ L= 50X50 - BIANCO	DECAL	AUTOCOLLANT	AUFKLEBER	PEGATINA

 ADESIVI  
 STICKER  
 AUTOCOLLANT

AUFKLEBER   
 PEGATINA 

POS Codice	Q.tà	 Descrizione	 Description	 Designation	 Benennung	 Descripcìon
0 07668100	1 NR	ADESIVO PULSANTI DISTRIBUTORE PARTE AEREA LL2614 L=318X52 MM	DECAL	AUTOCOLLANT	AUFKLEBER	PEGATINA
0 07668200	1 NR	ADESIVO EMERGENCY STOP E BLOCCHETTO ACCENSIONE L=85X160 MM	DECAL	AUTOCOLLANT	AUFKLEBER	PEGATINA
0 07668300	1 NR	ADESIVO	DECAL	AUTOCOLLANT	AUFKLEBER	PEGATINA
0 1001125483	3 NR	ADESIVO	STICKER	AUTOCOLLANT	AUFKLEBER	PEGATINA
0 1001125483	6 NR	ADESIVO	STICKER	AUTOCOLLANT	AUFKLEBER	PEGATINA
0 1701504	1 NR	ADESIVO	STICKER	AUTOCOLLANT	AUFKLEBER	PEGATINA
0 1701640	1 NR	ADESIVO	STICKER	AUTOCOLLANT	AUFKLEBER	PEGATINA
0 1702155	1 NR	ADESIVO	STICKER	AUTOCOLLANT	AUFKLEBER	PEGATINA
0 1703814	4 NR	ADESIVO	STICKER	AUTOCOLLANT	AUFKLEBER	PEGATINA
0 1704277	2 NR	ADESIVO	STICKER	AUTOCOLLANT	AUFKLEBER	PEGATINA

# Cod. 17107300

**KIT INTEGRAZIONE ADESIVI PER PIATTAFORME AEREE LITHIUM-ANSI**  
*INTEGRATION KIT STICKERS PLATFORMS LITHIUM-ANSI*  
**X390AJ - X500AJ - X550AJ - X600AJ - X700AJ - X770AJ**

**Da usare in aggiunta ai seguenti kit / To be use in addition to the following kits**

**X390AJ - cod.17065200**

**X500AJ - cod.17224100**

**X550AJ - cod.17065300**

**X600AJ - cod. 17485000**

**X700AJ - cod.17065400**

**X770AJ - cod.17633600**

**+ kit in lingua non inclusi nel codice generale**  
*language code not included in the standard kit*

•  
**+171073GB**

**+ 171073FR**

**+ 171073ES**

**+ 171073PT**







9



16



4

5



KIT ADESIVI - X390AJ

SET OF DECALS - X390AJ

KIT COLLANTS - X390AJ

AUFKLEBERSATZ -X390AJ

KIT ADHESIVOS -X390AJ

ADHESIEKIT -X390AJ

**cod. 17107300**

**Tav 01**

9



1



4

17

4



13



KIT ADESIVI - X390AJ

SET OF DECALS -X390AJ

KIT COLLANTS -X390AJ

AUFKLEBERSATZ -X390AJ

KIT ADHESIVOS -X390AJ

ADHESIEKIT -X390AJ

**cod. 17107300**

**Tav 02**



9



16



2



4

1

5



KIT ADESIVI - X500AJ

SET OF DECALS - X500AJ

KIT COLLANTS - X500AJ

AUFKLEBERSATZ - X500AJ

KIT ADHESIVOS - X500AJ

ADHESIEKIT - X500AJ

**cod. 17107300**

**Tav 01**

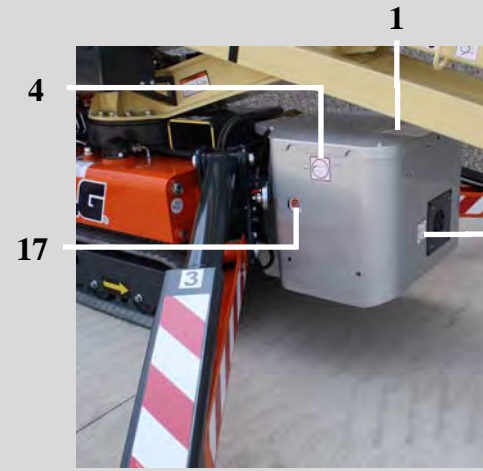

KIT ADESIVI - X500AJ

SET OF DECALS - X500AJ

KIT COLLANTS - X500AJ

AUFKLEBERSATZ - X500AJ

KIT ADHESIVOS - X500AJ

ADHESIEKIT - X500AJ

**cod. 17107300**

**Tav 02**



16



9

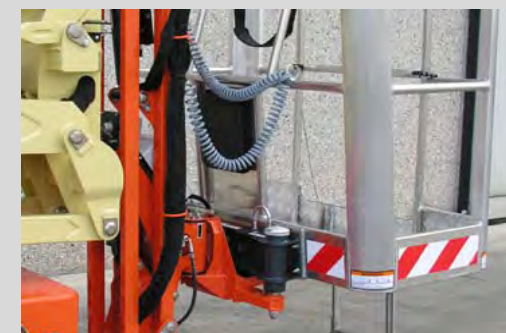

1



5



4

4



KIT ADESIVI - X550AJ

SET OF DECALS - X550AJ

KIT COLLANTS - X550AJ

AUFKLEBERSATZ - X550AJ

KIT ADHESIVOS - X550AJ

ADHESIEKIT - X550AJ

**cod. 17107300**

**Tav 01**



4  
17

9



13



KIT ADESIVI - X550AJ  
SET OF DECALS - X550AJ  
KIT COLLANTS - X550AJ

AUFKLEBERSATZ - X550AJ  
KIT ADHESIVOS - X550AJ  
ADHESIEKIT - X550AJ

**cod. 17107300**

**Tav 02**



4

5

9

16



4



2



9



2

KIT ADESIVI - X600AJ

SET OF DECALS - XX600AJ

KIT COLLANTS - X600AJ

AUFKLEBERSATZ - X600AJ

KIT ADHESIVOS - X600AJ

ADHESIEKIT - X600AJ

**cod. 17107300**

**Tav 01**





9

4



13

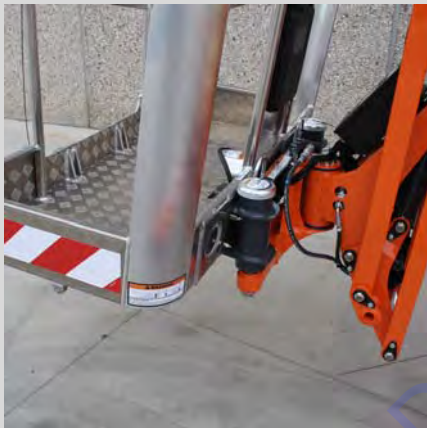

1

18

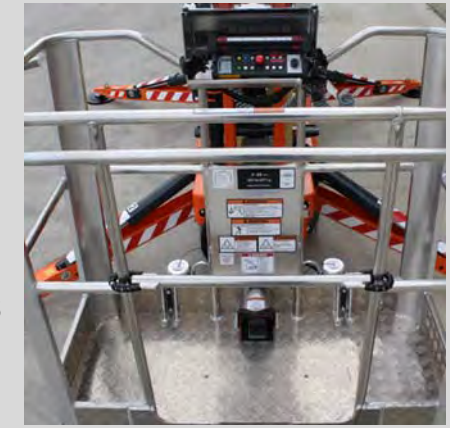

KIT ADESIVI - X600AJ

SET OF DECALS - XX600AJ

KIT COLLANTS - X600AJ

AUFKLEBERSATZ - X600AJ

KIT ADHESIVOS - X600AJ

ADHESIEKIT - X600AJ

**cod. 17107300**

**Tav 02**

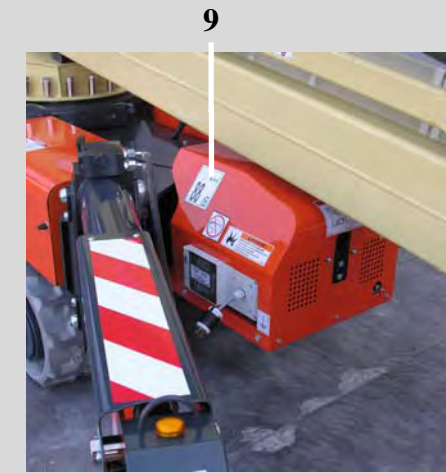

KIT ADESIVI - X700AJ

SET OF DECALS - X700AJ

KIT COLLANTS - X700AJ

AUFKLEBERSATZ - X700AJ

KIT ADHESIVOS -X700AJ

ADHESIEKIT -X700AJ

**cod. 17107300**

**Tav 01**

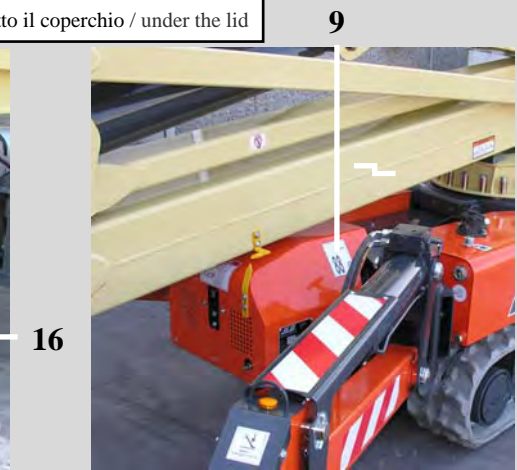
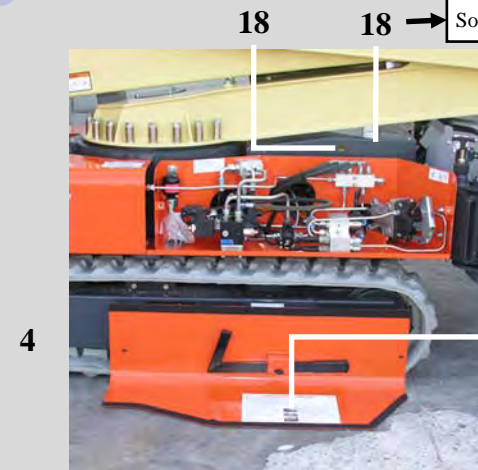

Sotto il coperchio / under the lid

KIT ADESIVI -X700AJ

SET OF DECALS -X700AJ

KIT COLLANTS -X700AJ

AUFKLEBERSATZ -X700AJ

KIT ADHESIVOS -X700AJ

ADHESIEKIT -X700AJ

**cod. 17107300**

**Tav 02**

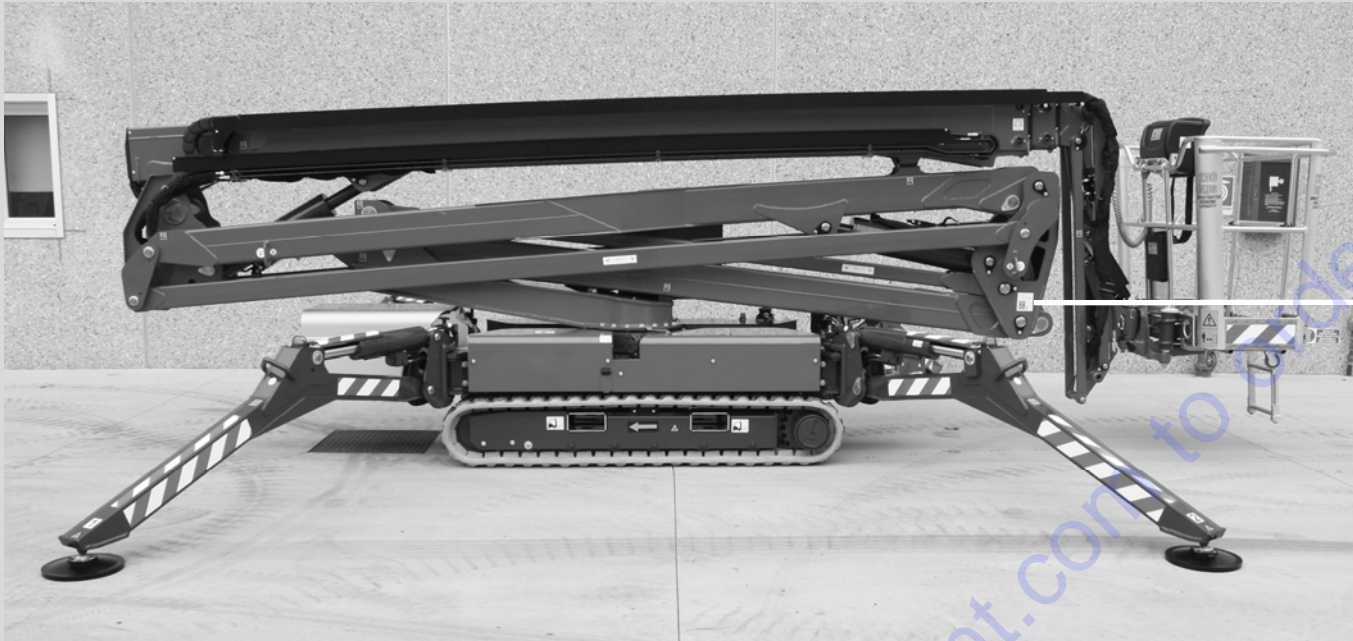

Fare foto della X770J lithium

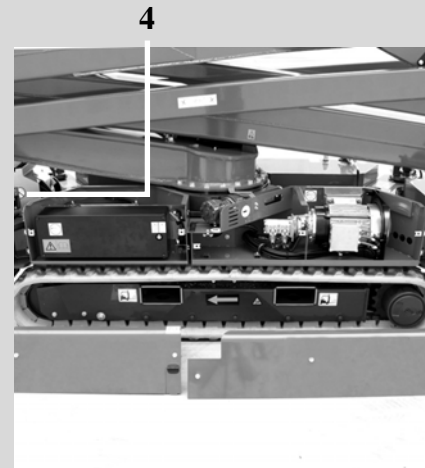
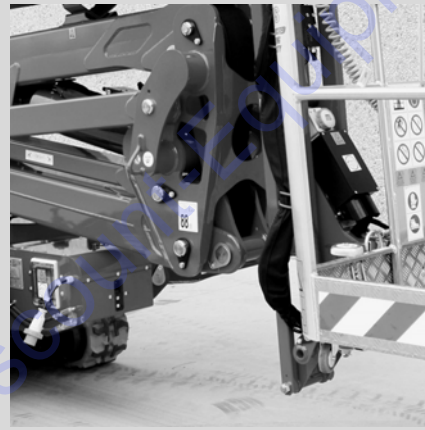

KIT ADESIVI - X770AJ

SET OF DECALS - X770AJ

KIT COLLANTS - X770AJ

AUFKLEBERSATZ - X770AJ

KIT ADHESIVOS -X770AJ

ADHESIEKIT - X770AJ

**cod. 17107300**

**Tav 01**

9



Fare foto della X770J lithium



4



16

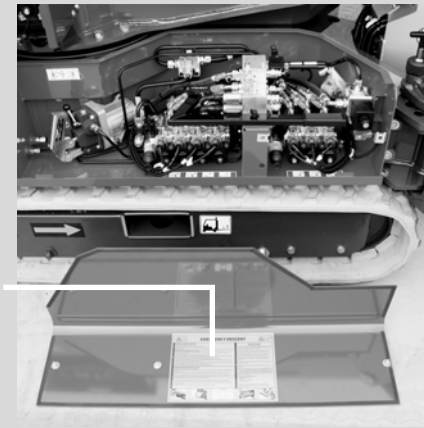

1

18

4

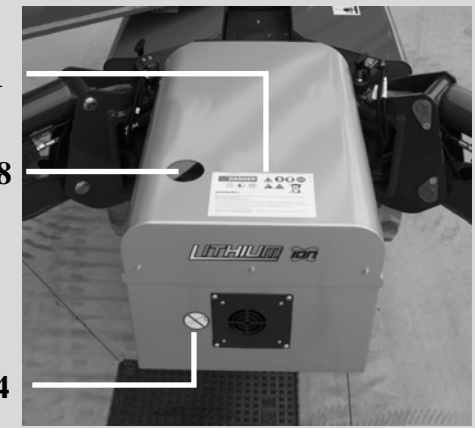

KIT ADESIVI - X770AJ

SET OF DECALS - X770AJ

KIT COLLANTS - X770AJ

AUFKLEBERSATZ - X770AJ

KIT ADHESIVOS -X770AJ

ADHESIEKIT - X770AJ

**cod. 17107300**

**Tav 02**

**Cod. 17107300**

**KIT INTEGRAZIONE ADESIVI PER PIATTAFORME AEREE LITHIUM-ANSI**  
*INTEGRATION KIT STICKERS PLATFORMS LITHIUM-ANSI*  
**X390AJ - X500AJ - X550AJ - X600AJ - X700AJ - X770AJ**

Go to [Discount-Equipment.com](https://Discount-Equipment.com) to order your parts

<b>17107300 POSIZIONE ADESIVI / POSITION STICKERS</b>	<b>IN LINGUA / LANGUAGE</b>	<b>JLG</b>
	<b>VOLTAGGIO / VOLTAGE</b>	

POS.	COD.	REV.	DESCRIZIONE / DESCRIPTION	Q.tà
01				
02				
03				
04	1001125483	A	ADESIVO JLG VIETATO LAVARE L=63,5X63,5 MM	03
05	06506400	<b>B</b>	ADESIVO " CHIAVE DI ACCENSIONE" ESTERNO Ø 49 FORO Ø 22 SERIE LITHIUM ION	01
06				
07				
08				
09	06520600	<b>B</b>	ADESIVO RUMORE 88 dB L=90x100	02
10				
11				
12				
13				
14				
15				
16				
17	07264700	A	ADESIVO INDICATORE LED CARICABATTERIE 48V (Ø EST.31MM Ø INT.6 MM) VECCHIO BMS (FINO A C170000329)	01
	07394800	A	ADESIVO INDICATORE LED CARICABATTERIE 48V (Ø EST.31MM Ø INT.6 MM) NUOVO BMS/4 (DA C170000330)	01
18	07264800	A	ADESIVO INDICATORE LED RICARICA BATTERIE Ø EST.21MM Ø INT.4 MM	02
19				

**KIT ADESIVI IN LINGUA PER / LANGUAGE KIT STICKERS FOR**

**X390AJ - X500AJ - X550AJ - X600AJ - X700AJ - X770AJ**

**Cod.**

**+ 171073GB**

**+ 171073FR**

**+ 171073ES**

**+ 171073PT**

Go to Discount-Equipment.com to order your parts



**171073\*\* POSIZIONE ADESIVI IN LINGUA /**  
**POSITION LANGUAGE STICKERS**

**IN LINGUA / LANGUAGE**

**JLG**

**VOLTAGGIO / VOLTAGE**

POS.	COD.	REV.	DESCRIZIONE / DESCRIPTION	Q.tà
	171073GB		ADESIVI PIATTAF. AEREA X390AJ - X14J - X17J - X550AJ - X19J - X700AJ - X23J - LINGUA INGLESE	
01	07107200	A	ADESIVO JLG-ANSI ATTENZIONE PERICOLO BATTERIE - ING L=210X145 MM	01
07				
10				
11				
12				
13	07107100	A	ADESIVO JL-ANSI RICARICARE LE BATTERIE DOPO L'USO ALMENO OGNI 3 MESI - ING L=50x50 MM	01
14				
15				01
16	07110300	A	ADESIVO JLG ANSI ISTRUZIONI DISCESA DI EMERG. X390AJ LITHIUM - ING L=280 X195MM	01
16	-----	A	ADESIVO JLG ANSI ISTRUZ. DISCESA DI EMERG. X500AJ / Utilizzare l' adesivo della motorizzazione con motore termico - vedere kit lingua inglese cod. 172241GB -Use the thermal sticker version - see the English language kit cod. 172241GB	01
16	07110200	A	ADESIVO JLG ANSI ISTRUZIONI DISCESA DI EMERG. X550AJ LITHIUM L=280 X195MM - GB	01
16	-----	A	ADESIVO JLG ANSI ISTRUZ. DISCESA DI EMERG. X600AJ / Utilizzare l' adesivo della motorizzazione con motore termico - vedere kit lingua inglese cod. 174850GB - Use the thermal sticker version - see the English language kit cod. 174850GB	01
16	07110100	A	ADESIVO JLG ANSI ISTRUZIONI DISCESA DI EMERG. X700AJ LITHIUM - ING L=280 X195MM	01
16	-----	A	ADESIVO JLG ANSI ISTRUZ. DISCESA DI EMERG. X770AJ / Utilizzare l' adesivo della motorizzazione con motore termico - vedere kit lingua inglese cod. 176264GB - Use the thermal sticker version - see the English language kit cod. 176264GB	01







## **Cod. 17187700**

**KIT INTEGRAZIONE ADESIVI PER PIATTAFORME AEREE LITHIUM-CE /  
INTEGRATION KIT STICKERS PLATFORMS LITHIUM-CE**

**X14J - X14J-H - X17J - X17JPLUS - X19J -  
X20JPLUS - X23J - X26JPLUS**

**Da usare in aggiunta a / To use in added to**

**X14J - cod.17063500**

**X14J-H - cod.17065000**

**X17J cod.17063700**

**X17JPLUS cod. 17242800**

**X19J cod.17063200**

**X20JPLUS cod. 17351800**

**X23J cod.17062700**

**X26JPLUS cod.17633400**

**+ kit in lingua non inclusi nel codice generale + language code not included in the standard kit**

**171877IT / 171877GB / 171877FR / 171877DE / 171877ES / 171877NL**

**171877PT / 171877SW / 171877DA / 171877NO / 171877JA**





16



KIT ADESIVI - X14J LITHIUM  
 SET OF DECALS - X14J LITHIUM  
 KIT COLLANTS - X14J LITHIUM

AUFKLEBERSATZ - X14J LITHIUM  
 KIT ADHESIVOS - X14J LITHIUM  
 ADHESIEKIT - X14J LITHIUM

**cod. 17187700**

**Tav 01**

9



13



KIT ADESIVI - X14J LITHIUM

SET OF DECALS - X14J LITHIUM

KIT COLLANTS - X14J LITHIUM

AUFKLEBERSATZ - X14J LITHIUM

KIT ADHESIVOS - X14J LITHIUM

ADHESIEKIT - X14J LITHIUM

**cod. 17187700**

**Tav 02**



# PARTS FINDER

**Search Website  
by Part Number**



**Search Manual  
Library For Parts  
Manual & Lookup Part  
Numbers – Purchase  
or Request Quote**

**Search Manuals**

Enter your information to help us find the right parts manual for your machine.

\* Brand:

\* Model:

\* Serial:

\* Part Number:

SEARCH

**Can't Find Part or  
Manual? Request Help  
by Manufacturer,  
Model & Description**

**Parts Order Form**

Please fill in the following information to help us find the right part for your machine.

Manufacturer:	<input type="text"/>
Model:	<input type="text"/>
Description:	<input type="text"/>
Part Number:	<input type="text"/>
Quantity:	<input type="text"/>
Notes:	<input type="text"/>

Submit

Discount-Equipment.com is your online resource for quality parts & equipment.

Florida: **561-964-4949** Outside Florida TOLL FREE: **877-690-3101**

**Need parts?**

Click on this link: <http://www.discount-equipment.com/category/5443-parts/> and choose one of the options to help get the right parts and equipment you are looking for. Please have the machine model and serial number available in order to help us get you the correct parts. If you don't find the part on the website or on one of the online manuals, please fill out the request form and one of our experienced staff members will get back to you with a quote for the right part that your machine needs.

We sell worldwide for the brands: Genie, Terex, JLG, MultiQuip, Mikasa, Essick, Whiteman, Mayco, Toro Stone, Diamond Products, Generac Magnum, Airman, Haulotte, Barreto, Power Blanket, Nifty Lift, Atlas Copco, Chicago Pneumatic, Allmand, Miller Curber, Skyjack, Lull, Skytrak, Tsurumi, Husquvarna Target, Stow, Wacker, Sakai, Mi-T-M, Sullair, Basic, Dynapac, MBW, Weber, Bartell, Bennar Newman, Haulotte, Ditch Runner, Menegotti, Morrison, Contec, Buddy, Crown, Edco, Wyco, Bomag, Laymor, EZ Trench, Bil-Jax, F.S. Curtis, Gehl Pavers, Heli, Honda, ICS/PowerGrit, IHI, Partner, Imer, Clipper, MMD, Koshin, Rice, CH&E, General Equipment, Amida, Coleman, NAC, Gradall, Square Shooter, Kent, Stanley, Tamco, Toku, Hatz, Kohler, Robin, Wisconsin, Northrock, Oztec, Toker TK, Rol-Air, APT, Wylie, Ingersoll Rand / Doosan, Innovatech, Con X, Ammann, Mecalac, Makinex, Smith Surface Prep, Small Line, Wanco, Yanmar

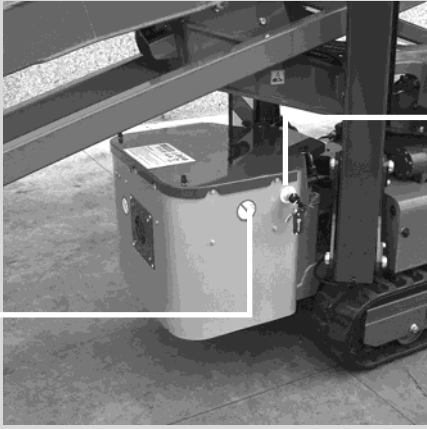
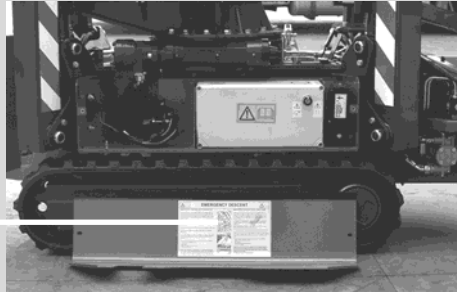

KIT ADESIVI - X17J LITHIUM

SET OF DECALS - X17J LITHIUM

KIT COLLANTS - X17J LITHIUM

AUFKLEBERSATZ - X17J LITHIUM

KIT ADHESIVOS - X17J LITHIUM

ADHESIEKIT - X17J LITHIUM

**cod. 17187700**

**Tav 01**



13

1

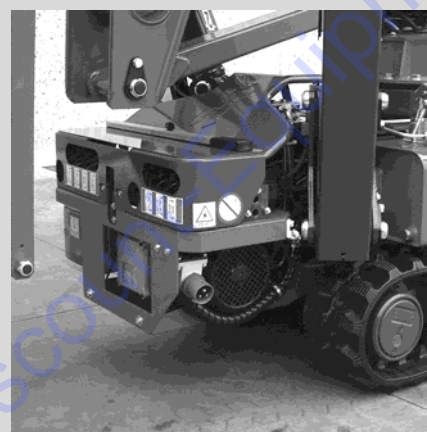

4

17

4



KIT ADESIVI - X17J LITHIUM

SET OF DECALS - X17J LITHIUM

KIT COLLANTS - X17J LITHIUM

AUFKLEBERSATZ - X17J LITHIUM

KIT ADHESIVOS - X17J LITHIUM

ADHESIEKIT - X17J LITHIUM

**cod. 17187700**

**Tav 02**



9



16



1

4

4

5



KIT ADESIVI - X17JPLUS LITHIUM

SET OF DECALS - X17JPLUS LITHIUM

KIT COLLANTS - X17JPLUS LITHIUM

AUFKLEBERSATZ - X17JPLUS LITHIUM

KIT ADHESIVOS - X17JPLUS LITHIUM

ADHESIEKIT - X17JPLUS LITHIUM

**cod. 17187700**

**Tav 01**



9



13

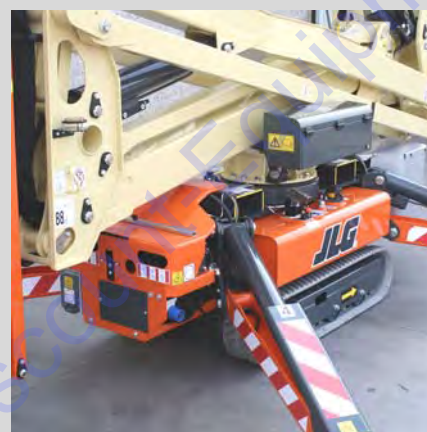

4

17



KIT ADESIVI - X17JPLUS LITHIUM

SET OF DECALS - X17JPLUS LITHIUM

KIT COLLANTS - X17JPLUS LITHIUM

AUFKLEBERSATZ - X17JPLUS LITHIUM

KIT ADHESIVOS - X17JPLUS LITHIUM

ADHESIEKIT - X17JPLUS LITHIUM

**cod. 17187700**

**Tav 02**

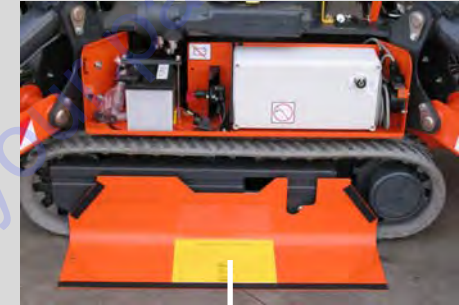

KIT ADESIVI - X19J LITHIUM  
 SET OF DECALS - X19J LITHIUM  
 KIT COLLANTS - X19J LITHIUM

AUFKLEBERSATZ - X19J LITHIUM  
 KIT ADHESIVOS - X19J LITHIUM  
 ADHESIEKIT - X19J LITHIUM

**cod. 17187700**

**Tav 01**



9

4

17



13



KIT ADESIVI - X19J LITHIUM  
 SET OF DECALS - X19J LITHIUM  
 KIT COLLANTS - X19J LITHIUM

AUFKLEBERSATZ - X19J LITHIUM  
 KIT ADHESIVOS - X19J LITHIUM  
 ADHESIEKIT - X19J LITHIUM

**cod. 17187700**

**Tav 02**



9

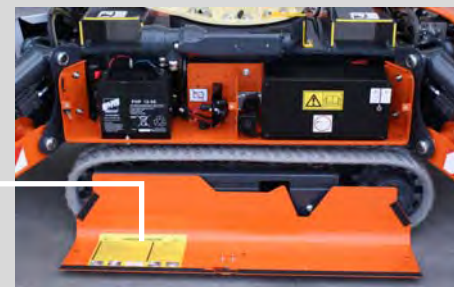

16



5



KIT ADESIVI - X20JPLUS LITHIUM

SET OF DECALS - X20JPLUS LITHIUM

KIT COLLANTS - X20JPLUS LITHIUM

AUFKLEBERSATZ - X20JPLUS LITHIUM

KIT ADHESIVOS - X20JPLUS LITHIUM

ADHESIEKIT - X20JPLUS LITHIUM

**cod. 17187700**

**Tav 01**





9



13



4

18



3



KIT ADESIVI - X20JPLUS LITHIUM

SET OF DECALS - X20JPLUS LITHIUM

KIT COLLANTS - X20JPLUS LITHIUM

AUFKLEBERSATZ - X20JPLUS LITHIUM

KIT ADHESIVOS - X20JPLUS LITHIUM

ADHESIEKIT - X20JPLUS LITHIUM

**cod. 17187700**

**Tav 02**



5

4

13

9

KIT ADESIVI - X23J LITHIUM  
 SET OF DECALS - X23J LITHIUM  
 KIT COLLANTS - X23J LITHIUM

AUFKLEBERSATZ - X23J LITHIUM  
 KIT ADHESIVOS - X23J LITHIUM  
 ADHESIEKIT - X23J LITHIUM

**cod. 17187700**

**Tav 01**

Sotto il carter / Under the hood

18

4



18



1

16



4



9



KIT ADESIVI - X23J LITHIUM

SET OF DECALS - X23J LITHIUM

KIT COLLANTS - X23J LITHIUM

AUFKLEBERSATZ - X23J LITHIUM

KIT ADHESIVOS - X23J LITHIUM

ADHESIEKIT - X23J LITHIUM

**cod. 17187700**

**Tav 02**

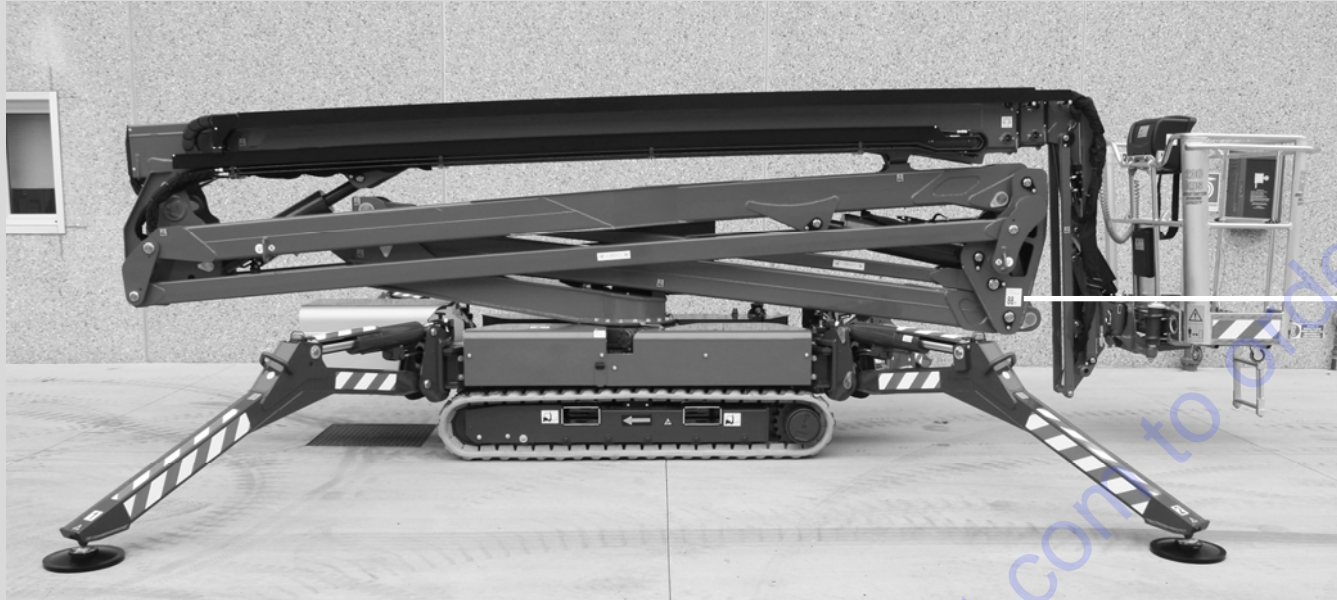

Fare foto della X26JPLUS lithium



9

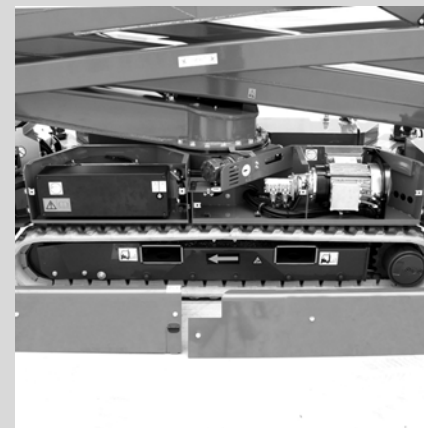
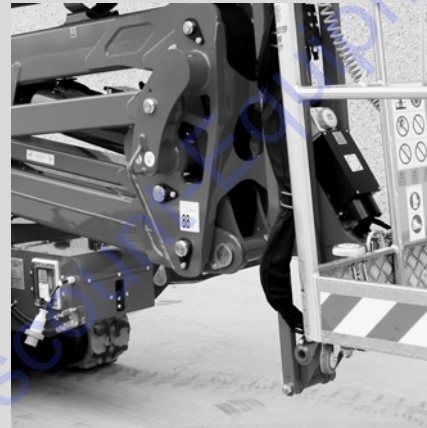

13

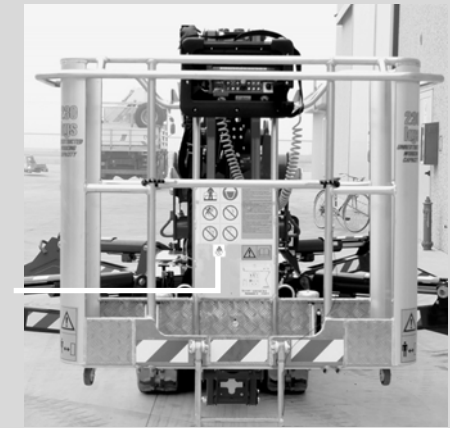

KIT ADESIVI - X26JPLUS LITHIUM

SET OF DECALS - X26JPLUS LITHIUM

KIT COLLANTS - X26JPLUS LITHIUM

AUFKLEBERSATZ - X26JPLUS LITHIUM

KIT ADHESIVOS - X26JPLUS LITHIUM

ADHESIEKIT - X26JPLUS LITHIUM

**cod. 17187700**

**Tav 01**

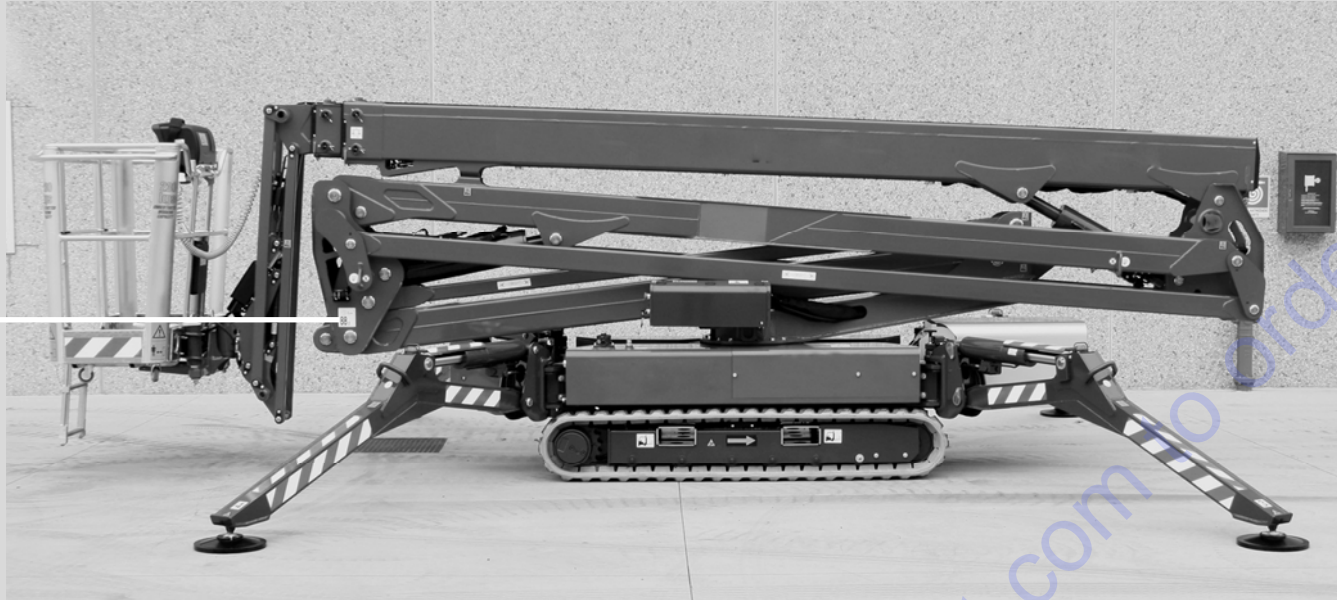

Fare foto della X26JPLUS lithium

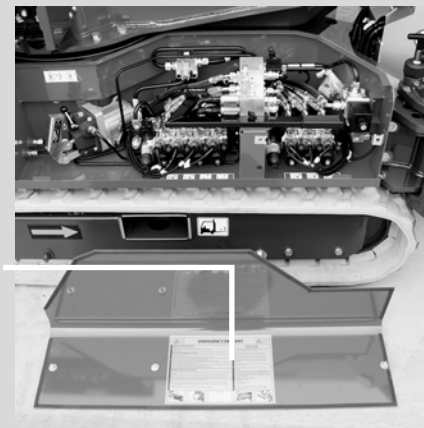
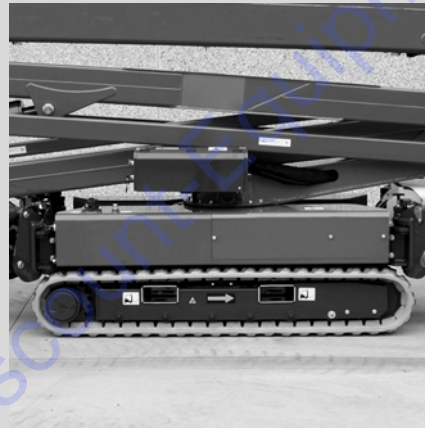

KIT ADESIVI - X26JPLUS LITHIUM

SET OF DECALS - X26JPLUS LITHIUM

KIT COLLANTS - X26JPLUS LITHIUM

AUFKLEBERSATZ - X26JPLUS LITHIUM

KIT ADHESIVOS - X26JPLUS LITHIUM

ADHESIEKIT - X26JPLUS LITHIUM

**cod. 17187700**

**Tav 02**

**Cod. 17187700**

**KIT INTEGRAZIONE ADESIVI PER PIATTAFORME AEREE LITHIUM-CE**  
*INTEGRATION KIT STICKERS PLATFORMS LITHIUM-CE*

**X14J - X14J-H - X17J - X17JPLUS - X19J - X23J - X26JPLUS**

Go to [Discount-Equipment.com](http://Discount-Equipment.com) to order your parts

<b>17187700 POSIZIONE ADESIVI 7 LINGUE / POSITION LANGUAGE STICKERS</b>	<b>IN LINGUA / LANGUAGE</b>	<b>JLG</b>
	<b>VOLTAGGIO / VOLTAGE</b>	

POS.	COD.	REV.	DESCRIZIONE / DESCRIPTION	Q.tà
01				
02				
03				
04	1001125483	A	ADESIVO JLG VIETATO LAVARE L=63,5X63,5 MM	03
05	06506400	<b>B</b>	ADESIVO " CHIAVE DI ACCENSIONE" ESTERNO Ø 49 FORO Ø 22 SERIE LITHIUM ION	01
06				
07				
08				02
09	06520600	<b>B</b>	ADESIVO RUMORE 88 dB L=90x100	02
10				
11				
12				
13				
14				
15				
16				
17	07264700	A	ADESIVO INDICATORE LED CARICABATTERIE 48V (Ø EST.31MM Ø INT.6 MM) VECCHIO BMS (FINO A C170000329)	01
	07394800	A	ADESIVO INDICATORE LED CARICABATTERIE 48V (Ø EST.31MM Ø INT.6 MM) NUOVO BMS/4 (DA C170000330)	01
18	07264800	A	ADESIVO INDICATORE LED RICARICA BATTERIE Ø EST.21MM Ø INT.4 MM	02

**KIT ADESIVI IN LINGUA PER PER PIATTAFORME AEREE LITHIUM-CE**  
*/ STICKERS KIT IN LANGUAGE FOR PLATFORMS FOR LITHIUM - CE*

**X14J - X14J-H - X17J - X17JPLUS - X19J - X20JPLUS - X23J - X26JPLUS**

**Cod.**

**171877IT**  
**171877GB**  
**171877FR**  
**171877DE**  
**171877ES**  
**171877NL**  
**171877PT**  
**171877SW**  
**171877DA**  
**171877NO**  
**171877JA**



<b>171877** POSIZIONE ADESIVI IN LINGUA / POSITION LANGUAGE STICKERS</b>	<b>IN LINGUA / LANGUAGE</b>	<b>JLG</b>
	<b>VOLTAGGIO / VOLTAGE</b>	

POS.	COD.	REV.	DESCRIZIONE / DESCRIPTION	Q.tà
	171877IT		KIT ADESIVI INTEGR. PIATT. AEREA X14J-H- X14J - X17J - X19J X23J LITHIUM - LINGUA ITALIANO	
01	07188700	A	ADESIVO JLG ATTENZIONE PERICOLO BATTERIE - ITA L=210X145 MM	01
07				
10				
11				
12				
13	07188100	A	ADESIVO JLG RICARICARE LE BATTERIE DOPO L'USO O ALMENO OGNI 3 MESI L=50x50 MM – ITA	01
14				
16 solo X14J-H	1693870003	B	ADESIVO ISTRUZIONI DISCESA EMERGENZA GL1470LI ITALIANO GIALLO L=290x175 MM (**)	01
16 solo X17J	1705720001	A	ADESIVO ISTRUZIONI DISCESA DI EMERGENZA GL14703S LITHIUM ITALIANO L=290X175 MM (**)	01
16			<b>Per le / for X14J - X17JPLUS - X19J - X20JPLUS - X23J - X26JPLUS Vedere discesa di emergenza motore termico / See emergency lowering heat engine</b>	
	171877GB		KIT ADESIVI INTEGR. PIATT. AEREA X14J-H- X14J - X17J - X19J X23J LITHIUM - LINGUA INGLESE	
01	07201700	A	ADESIVO JLG ATTENZIONE PERICOLO BATTERIE - ING L=210X145 MM	01
07				
10				
11				
12				
13	07202100	A	ADESIVO JLG-CE RICARICARE LE BATTERIE DOPO L'USO ALMENO OGNI 3 MESI - ING L=50x50 MM	01
14				
16 per X14J-H	1693870004	B	ADESIVO ISTRUZIONI DISCESA EMERGENZA GL1470LI INGLESE GIALLO L=290x175 MM	01
16 per X17J	1705720002	A	ADESIVO ISTRUZIONI DISCESA DI EMERGENZA GL14703S LITHIUM INGLESE L=290X175 MM	01
16			<b>Per le / for X14J - X17JPLUS - X19J - X20JPLUS - X23J - X26JPLUS Vedere discesa di emergenza motore termico / See emergency lowering heat engine</b>	

<b>171877** POSIZIONE ADESIVI IN LINGUA / POSITION LANGUAGE STICKERS</b>	<b>IN LINGUA / LANGUAGE</b>	<b>JLG</b>
	<b>VOLTAGGIO / VOLTAGE</b>	

POS.	COD.	REV.	DESCRIZIONE / DESCRIPTION	Q.tà
	171877FR		KIT ADESIVI INTEGR. PIATT. AEREA X14J-H- X14J - X17J - X19J X23J LITHIUM - LINGUA FRANCESE	
01	07201800	A	ADESIVO JLG ADESIVO ATTENZIONE PERICOLO BATTERIE - FRA L=210X145 MM	01
07				
10				
11				
12				
13	07202200	A	ADESIVO JLG RICARICARE LE BATTERIE DOPO L'USO ALMENO OGNI 3 MESI - FRA L=50x50 MM	01
14				
16 per X14J-H	1693870005	B	ADESIVO ISTRUZIONI DISCESA EMERGENZA GL1470LI FRANCESE GIALLO L=290x175 MM (**)	01
16 per X17J	1705720003	A	ADESIVO ISTRUZIONI DISCESA DI EMERGENZA GL14703S LITHIUM FRANCESE L=290X175 MM (**)	01
16	/	/	<b>Per le / for X14J - X17JPLUS - X19J - X20JPLUS - X23J - X26JPLUS Vedere discesa di emergenza motore termico / See emergency lowering heat engine</b>	01
	171877DE		KIT ADESIVI INTEGR. PIATT. AEREA X14J-H- X14J - X17J - X19J X23J LITHIUM - LINGUA TEDESCO	
01	07188800	A	ADESIVO JLG ATTENZIONE PERICOLO BATTERIE - TED L=210X145 MM	01
07				
10				
11				
12				
13	07188200	A	ADESIVO JLG RICARICARE LE BATTERIE DOPO L'USO O ALMENO OGNI 3 MESI L=50x50 MM –TED	01
14				
16 per X14J-H	1693870006	B	ADESIVO ISTRUZIONI DISCESA EMERGENZA GL1470LI TEDESCO GIALLO L=290x175 MM (**)	01
16 per X17J	1705720004	A	ADESIVO ISTRUZIONI DISCESA DI EMERGENZA GL14703S LITHIUM TEDESCO L=290X175 MM (**)	01
16	/	/	<b>Per le / for X14J - X17JPLUS - X19J - X20JPLUS - X23J - X26JPLUS Vedere discesa di emergenza motore termico / See emergency lowering heat engine</b>	01

<b>171877** POSIZIONE ADESIVI IN LINGUA / POSITION LANGUAGE STICKERS</b>	<b>IN LINGUA / LANGUAGE</b>	<b>JLG</b>
	<b>VOLTAGGIO / VOLTAGE</b>	

POS.	COD.	REV.	DESCRIZIONE / DESCRIPTION	Q.tà
	171877ES		KIT ADESIVI INTEGR. PIATT. AEREA X14J-H- X14J - X17J - X19J X23J LITHIUM - LINGUA SPAGNOLO	
01	07201900	A	ADESIVO JLG ATTENZIONE PERICOLO BATTERIE - SPA L=210X145 MM -	01
07				
10				
11				
12				
13	07202300	A	ADESIVO JLG RICARICARE LE BATTERIE DOPO L'USO ALMENO OGNI 3 MESI - SPA L=50x50 MM	01
14				
16 per X14J-H	1693870007	B	ADESIVO ISTRUZIONI DISCESA EMERGENZA GL1470LI SPAGNOLO GIALLO L=290x175 (**)	01
16 per X17J	1705720005	A	ADESIVO ISTRUZIONI DISCESA DI EMERGENZA GL14703S LITHIUM SPAGNOLO L=290X175 MM (**)	01
16			<b>Per le / for X14J - X17JPLUS - X19J - X20JPLUS - X23J - X26JPLUS Vedere discesa di emergenza motore termico / See emergency lowering heat engine</b>	
	171877NL		KIT ADESIVI INTEGR. PIATT. AEREA X14J-H- X14J - X17J - X19J X23J LITHIUM - LINGUA OLANDESE	
01	07188900	A	ADESIVO JLG ATTENZIONE PERICOLO BATTERIE - OLA L=210X145 MM	01
07				
10				
11				
12				
13	07188300	A	ADESIVO JLG RICARICARE LE BATTERIE DOPO L'USO O ALMENO OGNI 3 MESI L=50x50 MM – OLA	01
14				
16 per X14J-H	1693870008	B	ADESIVO ISTRUZIONI DISCESA EMERGENZA GL1470LI OLANDESE GIALLO L=290x175 MM (**)	01
16 per X17J	1705720006	A	ADESIVO ISTRUZIONI DISCESA DI EMERGENZA GL14703S LITHIUM OLANDESE L=290X175 MM (**)	01
16			<b>Per le / for X14J - X17JPLUS - X19J - X20JPLUS - X23J - X26JPLUS Vedere discesa di emergenza motore termico / See emergency lowering heat engine</b>	01

<b>171877** POSIZIONE ADESIVI IN LINGUA / POSITION LANGUAGE STICKERS</b>	<b>IN LINGUA / LANGUAGE</b>	<b>JLG</b>
	<b>VOLTAGGIO / VOLTAGE</b>	

POS.	COD.	REV.	DESCRIZIONE / DESCRIPTION	Q.tà
	171877PT		KIT ADESIVI INTEGR. PIATT. AEREA X14J-H-X14J-X17J-X19J-X23J LITHIUM - LINGUA PORTOGHESE	
01	07202000	A	ADESIVO JLG ATTENZIONE PERICOLO BATTERIE - POR L=210X145 MM	01
07				
10				
11				
12				
13	07202400	A	ADESIVO JLG RICARICARE LE BATTERIE DOPO L'USO O ALMENO OGNI 3 MESI L=50x50 MM – POR	01
14				
16 per X14J-H	1693870009	B	ADESIVO ISTRUZIONI DISCESA EMERGENZA GL1470LI PORTOGHESE GIALLO L=290x175 MM (**)	01
16 per X17J	1705720007	A	ADESIVO ISTRUZ. DISCESA DI EMERGENZA GL14703S LITHIUM PORTOGHESE L=290X175 MM (**)	01
16			<b>Per le / for X14J - X17JPLUS - X19J - X20JPLUS - X23J - X26JPLUS Vedere discesa di emergenza motore termico / See emergency lowering heat engine</b>	
	171877SW		KIT ADESIVI INTEGR. PIATT. AEREA X14J-H-X14J-X17J-X19J-X23J LITHIUM - SVEDESE	
01	07189000	A	ADESIVO JLG ATTENZIONE PERICOLO BATTERIE - SVE L=210X145 MM	01
07				
10				
11				
12				
13	07188400	A	ADESIVO JLG RICARICARE LE BATTERIE DOPO L'USO O ALMENO OGNI 3 MESI L=50x50 MM – SVE	01
14				
16 per X14J-H	1693870010	A	ADESIVO ISTRUZIONI DISCESA EMERGENZA GL1470LI SVEDESE GIALLO L=290x175 MM (**)	01
16 per X17J	1705720010	A	ADESIVO ISTRUZ. DISCESA DI EMERGENZA GL14703S LITHIUM SVEDESE L=290X175 MM (**)	01
16			<b>Per le / for X14J - X17JPLUS - X19J - X20JPLUS - X23J - X26JPLUS Vedere discesa di emergenza motore termico / See emergency lowering heat engine</b>	

<b>171877** POSIZIONE ADESIVI IN LINGUA / POSITION LANGUAGE STICKERS</b>	<b>IN LINGUA / LANGUAGE</b>	<b>JLG</b>
	<b>VOLTAGGIO / VOLTAGE</b>	

POS.	COD.	REV.	DESCRIZIONE / DESCRIPTION	Q.tà
	171877DA		KIT ADESIVI INTEGR. PIATT. AEREA X14J-H-X14J-X17J-X19J-X23J LITHIUM - LINGUA DANESE	
01	07189100	A	ADESIVO JLG ATTENZIONE PERICOLO BATTERIE - DAN L=210X145 MM	01
07				
10				
11				
12				
13	07188500	A	ADESIVO JLG RICARICARE LE BATTERIE DOPO L'USO O ALMENO OGNI 3 MESI L=50x50 MM – DAN	01
14				
16 per X14J-H	1693870011	A	ADESIVO ISTRUZIONI DISCESA EMERGENZA GL1470LI SVEDESE DANESE L=290x175 MM (**)	01
16 per X17J	1705720011	A	ADESIVO ISTRUZ. DISCESA DI EMERGENZA GL14703S LITHIUM DANESE L=290X175 MM (**)	01
16			<b>Per le / for X14J - X17JPLUS - X19J - X20JPLUS - X23J - X26JPLUS Vedere discesa di emergenza motore termico / See emergency lowering heat engine</b>	
	171877NO		KIT ADESIVI INTEGR. PIATT. AEREA X14J-H-X14J-X17J-X19J-X23J LITHIUM - LINGUA NORVEGESE	
01	07189200	A	ADESIVO JLG ATTENZIONE PERICOLO BATTERIE - NOR L=210X145 MM	01
07				
10				
11				
12				
13	07188600	A	ADESIVO JLG RICARICARE LE BATTERIE DOPO L'USO O ALMENO OGNI 3 MESI L=50x50 MM – NOR	01
14				
16 per X14J-H	1693870012	A	ADESIVO ISTRUZIONI DISCESA EMERGENZA GL1470LI NORVEGESE GIALLO L=290x175 MM (**)	01
16 per X17J	1705720012	A	ADESIVO ISTRUZ. DISCESA DI EMERGENZA GL14703S LITHIUM NORVEGESE L=290X175 MM (**)	01
16	/	/	<b>Per le / for X14J - X17JPLUS - X19J - X20JPLUS - X23J - X26JPLUS Vedere discesa di emergenza motore termico / See emergency lowering heat engine</b>	

**171877\*\* POSIZIONE ADESIVI IN LINGUA /**  
**POSITION LANGUAGE STICKERS**

**IN LINGUA / LANGUAGE**

**JLG**

**VOLTAGGIO / VOLTAGE**

POS.	COD.	REV.	DESCRIZIONE / DESCRIPTION	Q.tà
	171877JA		KIT ADESIVI INTEGR. PIATT. AEREA X14J-H- X14J - X17J - X19J X23J LITHIUM - LINGUA GIAPPONESE	
01	07341100	A	ADESIVO JLG-ANSI ATTENZIONE PERICOLO BATTERIE - JAPAN L=210X145 MM	01
07				
10				
11				
12				
13	07341200	A	ADESIVO JLG-CE RICARICARE LE BATTERIE DOPO L'USO - JAPAN L=50x50 MM	01
14				
16 per X14J-H				01
16 per X17J				
16	/	/	<b>Per le / for X14J - X17JPLUS - X19J - X20JPLUS - X23J - X26JPLUS</b> <b>Vedere discesa di emergenza motore termico / See emergency lowering heat engine</b>	
	171877PL		KIT ADESIVI INTEGR. PIATT. AEREA X14J-H- X14J - X17J - X19J X23J LITHIUM - LINGUA GIAPPONESE	
01	07508000	A	ADESIVO JLG-ANSI ATTENZIONE PERICOLO BATTERIE - POLACCO L=210X145 MM	01
07				
10				
11				
12				
13	07508100	A	ADESIVO JLG-CE RICARICARE LE BATTERIE DOPO L'USO - POLACCO L=50x50 MM	01
14				
16 per X14J-H				01
16 per X17J				
16	/	/	<b>Per le / for X14J - X17JPLUS - X19J - X20JPLUS - X23J - X26JPLUS</b> <b>Vedere discesa di emergenza motore termico / See emergency lowering heat engine</b>	

AGGIORNATO IL / UPDATED 26/10/2015

**Cod. 17351800**

**KIT ADESIVI SICUREZZA PIATTAFORMA AEREA /  
AERIAL PLATFORM KIT STICKERS SAFETY  
JLG - CE / X20JPLUS**

+ **kit in lingua non inclusi nel codice generale** + *language code not included in the standard kit*

**173518IT / 173518GB / 173518FR / 173518DE / 173518ES / 173518NL /  
173518PT / 173518DA / 173518NO / 173518SW / 173518FI**

**DA USARE CON / FOR USE WITH**

- **17351900** KIT ADESIVI COMMERCIALI PIATTAFORMA AEREA / *STICKER KITS COMMERCIAL AERIAL PLATFORM X20JPLUS*
- **17187700** KIT INTEGRAZIONE ADESIVI PIATTAFORME 3S LITHIUM /*STICKER KIT INTEGRATION PLATFORM LITHIUM X14J\_14J-H\_X17J\_X17JPLUS\_X20JPLUS\_X19J\_X23J*





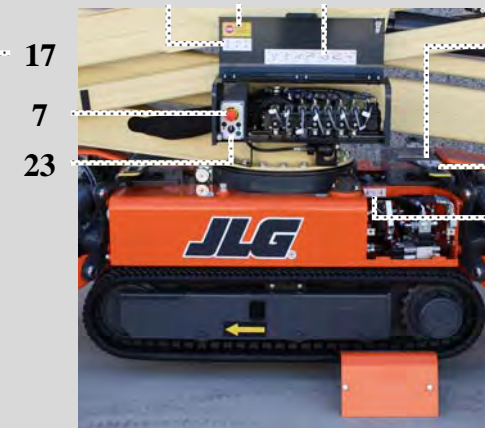
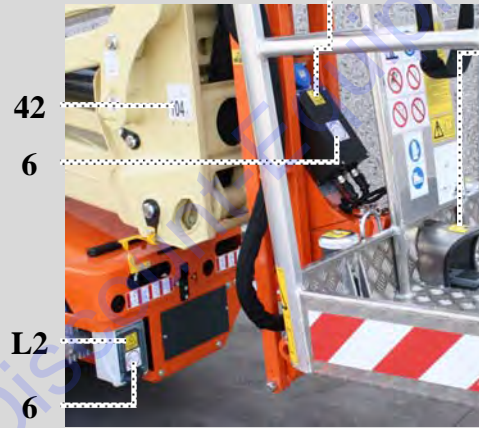
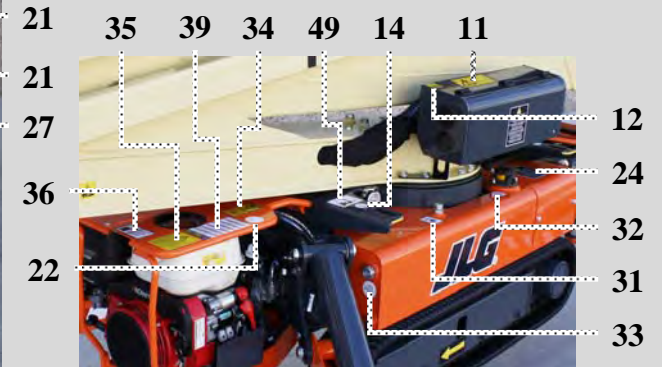
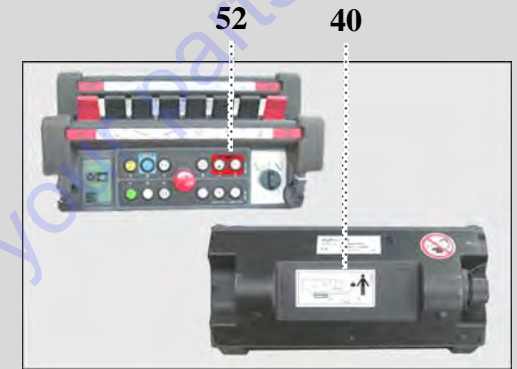
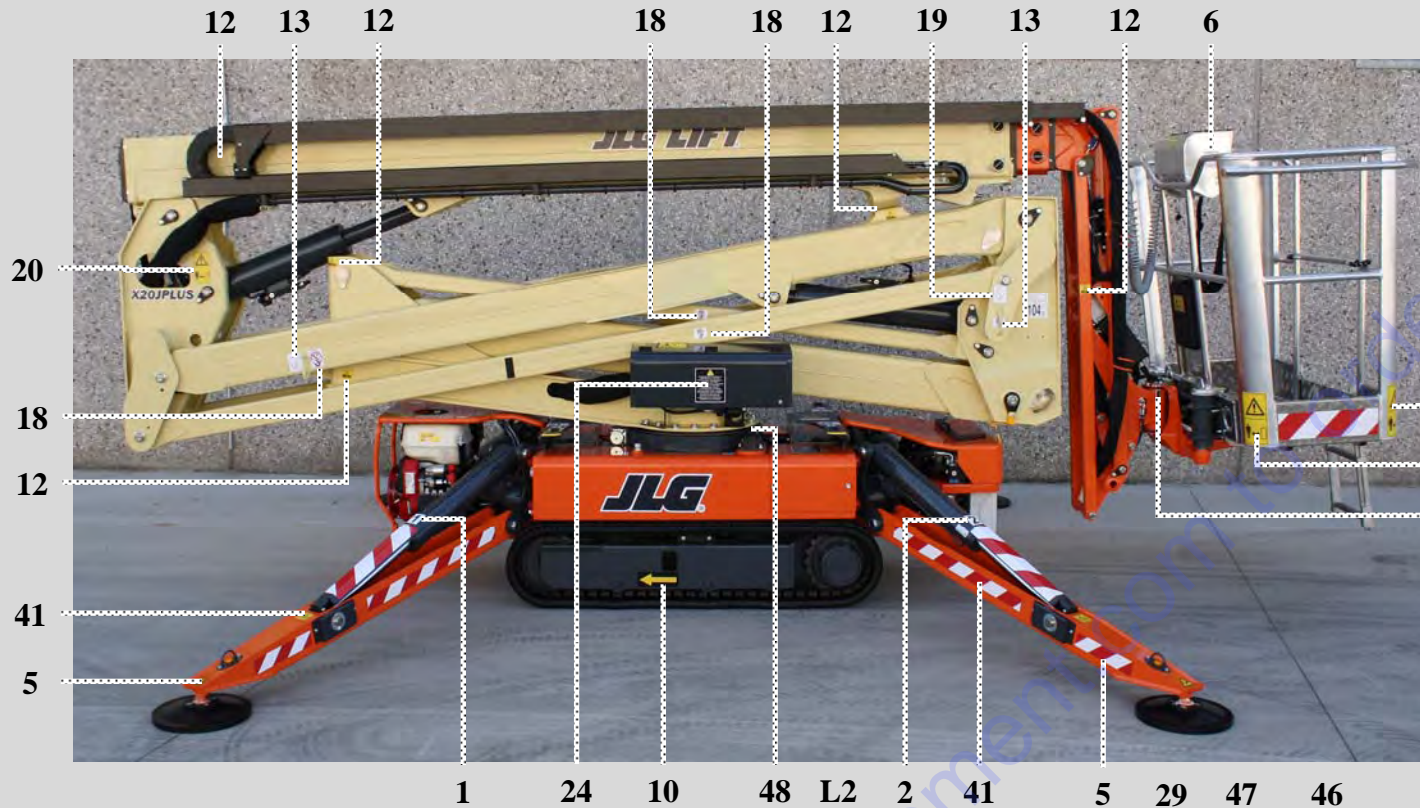

KIT ADESIVI - X20JPLUS	AUFKLEBERSATZ - X20JPLUS	<b>cod. 17351800</b>
SET OF DECALS - X20JPLUS	KIT ADHESIVOS - X20JPLUS	
KIT COLLANTS - X20JPLUS	ADHESIEKIT - X20JPLUS	<b>Tav 01</b>

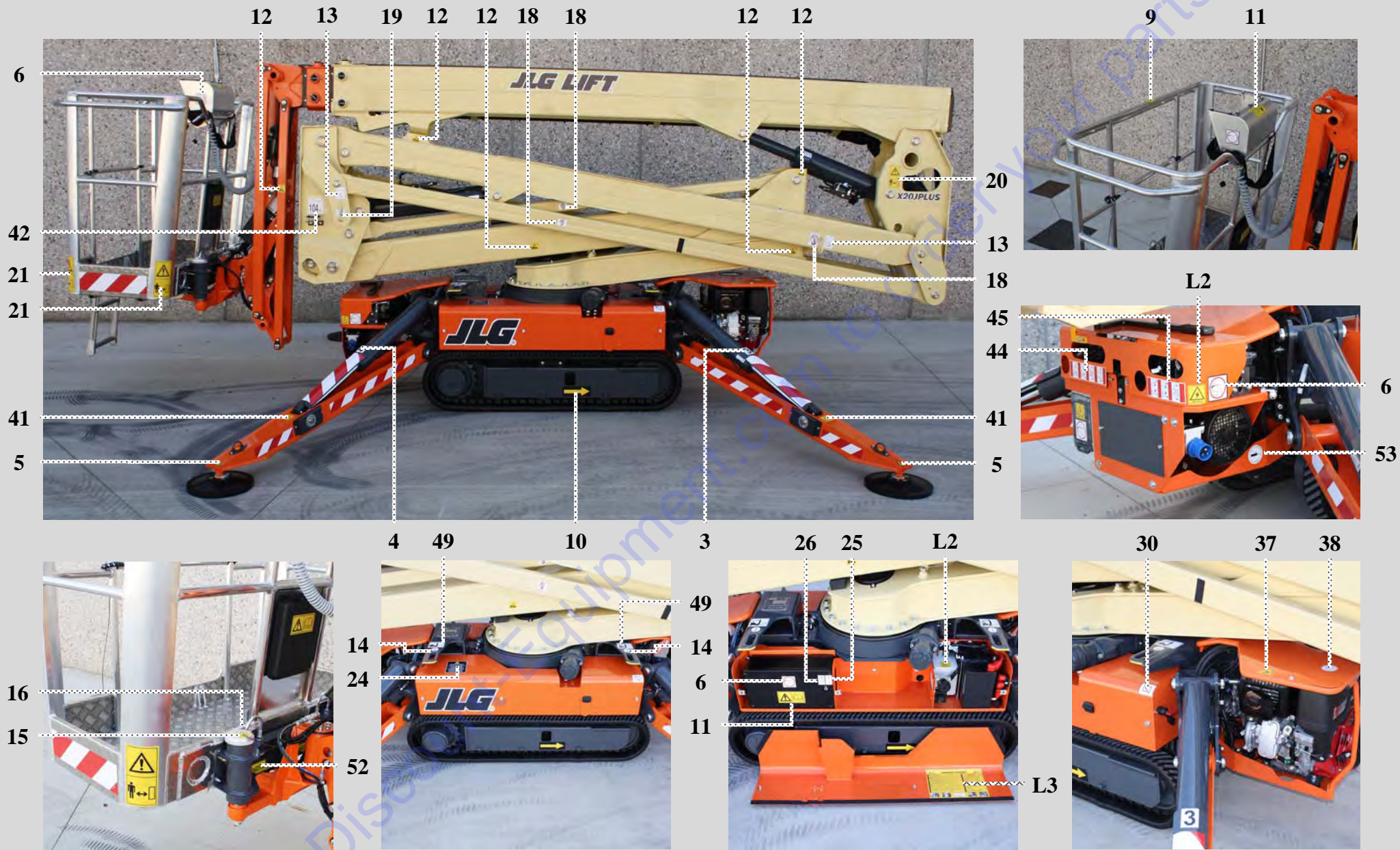

KIT ADESIVI - X20JPLUS

SET OF DECALS - X20JPLUS

KIT COLLANTS - X20JPLUS

AUFKLEBERSATZ - X20JPLUS

KIT ADHESIVOS - X20JPLUS

ADHESIEKIT - X20JPLUS

**cod. 17351800**

**Tav 02**

# MOTORE DIESEL / DIESEL ENGINE



38 50 54 11



22 34 35 37

KIT ADESIVI - X20JPLUS

SET OF DECALS - - X20JPLUS

KIT COLLANTS - - X20JPLUS

AUFKLEBERSATZ - - X20JPLUS

KIT ADHESIVOS - - X20JPLUS

ADHESIEKIT - - X20JPLUS

**cod. 17351800**

**Tav 03**

**Cod. 17351800**

**KIT ADESIVI SICUREZZA PIATTAFORMA AEREA /**  
*AERIAL PLATFORM KIT STICKERS SAFETY*

**JLG - CE / X20JPLUS**

Go to [Discount-Equipment.com](http://Discount-Equipment.com) to order your parts

**X20JPLUS COD. 17351800 POSIZIONE ADESIVI / POSITION ADHESIVE**

**JLG**

POS.	COD.	REV.	DESCRIZIONE / DESCRIPTION	Q.tà
01	06555500	A	ADESIVO NR 1 L=50X60 BIANCO	01
02	06555600	A	ADESIVO NR 2 L=50X60 BIANCO	01
03	06555700	A	ADESIVO N° 3 L=50X60 BIANCO	01
04	06555800	A	ADESIVO N° 4 L=50X60 BIANCO	01
05	06041200	A	ADESIVO SCHIACCIAMENTO PIEDI TRIANGOLARE L=53X46 GIALLO	04
06	1001125483	A	ADESIVO JLG VIETATO LAVARE L=63,5X63,5 MM (**)	06
07	1706898	A	ADESIVO JLG EMERGENCY STOP Ø EST.57,15 Ø INT. 30,58 (**)	01
08	06924300	A	ADESIVO CASCO - IMBRAGATURA - DIVIETI SERIE METAL-IIIS L= 170X250 MM	01
09	1706493	B	ADESIVO JLG SCORRIMENTO SBARRA CHIUSURA CESTO L= 76,2X25,4 MM (**)	01
10	06040500	A	ADESIVO DIREZ. TRASLAZIONE FRECCIA GIALLA SFONDO NERO L=61 X 160	02
11	06040900	A	ADESIVO LEGGERE IL MANUALE L=125 X 65 GIALLO	06
12	06041300	B	ADESIVO ATTENZIONE PERICOLO TAGLI L=35 X 40 GIALLO	11
13	1703814	A	ADESIVO JLG ATTACCO ANCORAGGIO L=55,56X76,2 MM (**)	04
14	06044000	A	ADESIVO ATTACCO SOLLEVAMENTO SFONDO BIANCO COLORE BLU Ø40 (**)	04
15	06448200	B	ADESIVO "SBLOCCARE SOLO NEI CASI PREVISTI" Ø 60 MM	02
16	1704277	A	ADESIVO JLG ATTACCO CINTURE DI SICUREZZA L= 76,2X19,05 MM	02
17	1705828	B	ADESIVO JLG INTERUTTORE PEDALE L= 69,85X54 (**)	01
18	07056700	A	ADESIVO JLG DIVIETO DI SOLLEVAMENTO L=54,88X40 (**)	06
19	1701499	A	ADESIVO JLG DIVIETO DI SOLLEVAMENTO DAL PUNTO DI ANCORAGGIO L= 55,56X76 MM (**)	02
20	07058800	A	ADESIVO PERICOLO MANTENERE LE DISTANZE L=65X130 MM	02
21	06040300	A	ADESIVO PERICOLO MANTENERE LE DISTANZE GIALLO L=100 X 200 MM (**)	04
22	1706098	B	ADESIVO JLG PERICOLO ESPLOSIONE L=63,5X117,475 MM (**)	01
23	07349200	A	ADESIVO AVVIAMENTO MOTORE DA TERRA LL2010 IIIS L=76,5X37 MM	01
24	07056800	B	ADESIVO JLG DISCESA DI EMERGENZA ALL'INTERNO L=114X130 MM (**)	03

**X20JPLUS COD. 17351800 POSIZIONE ADESIVI / POSITION ADHESIVE**

**JLG**

POS.	COD.	REV.	DESCRIZIONE / DESCRIPTION	Q.tà
25	06086000	A	ADESIVO SISTEMA BYPASS TRASLAZIONE L=30X50	01
26	06085900	A	ADESIVO SISTEMA BYPASS PARTE AEREA L=30X50	01
27	06706500	A	ADESIVO ALLINEAMENTO CESTO (2 PEZZI) L=16X50+13	01
28	06998800	A	ADESIVO DEVIATORE POMPA MANUALE PIATTAFORMA GL17.80XL L=86X34	01
29	07242000	A	ADESIVO SELETTORE 3 POSIZIONI 2° TELECOMANDO	01
30	1702155	A	ADESIVO JLG STACCABATTERIA L= 63,5X50,80 MM (**)	01
31	1701504	A	ADESIVO JLG OLIO IDRAULICO L=50,8x63,5 MM (**)	01
32	06164700	A	ADESIVO FILTRO OLIO Ø50 SFONDO BIANCO	01
33	06165000	A	ADESIVO LIVELLO OLIO IDRAULICO Ø50 SFONDO BIANCO	01
34	06060000	A	ADESIVO LIVELLO OLIO MOTORE Ø50mm	01
35	06227200	B	ADESIVO CONTROLLARE LIVELLO OLIO GIALLO L= 80x80 MM	01
36	06041600	B	ADESIVO CARBURANTE BENZINA COLORE VERDE L=60 X 80 MM	01
36	1701505	A	ADESIVO JLG CARBURANTE DIESEL L= 50,8X63,5 (**)	01
37	06056300	A	ADESIVO PERICOLO SCOTTATURE L=60X51 TRIANGOLARE SFONDO GIALLO	01
38	06164600	A	ADESIVO FILTRO ARIA Ø50 SFONDO BIANCO	01
39	06232100	B	ADESIVO ATTENZIONE BENZINA INFIAMMABILE L= 170X42 MM	01
40	07240300	B	ADESIVO DISTANZA 1m SU TELE/RADIO COMANDI	01
41	07320400	A	ADESIVO REAZIONE AL SUOLO STABILIZZATORI LL2010	04
42	07034200	B	ADESIVO RUMORE 104 dB L=90X100	02
43	07397200	A	ADESIVO JLG X20JPLUS PORTATA CESTO 2 PERSONE L=135X145 MM	01
44	1608710001	C	ADESIVO PULSANTI DISTR. A TERRA LATO SX GL17.80 L=194X50 MM	01
45	1608710002	C	ADESIVO PULSANTI DISTRIB A TERRA GL 17.80 LATO DX L= 150X50 mm	01
46	07199100	A	ADESIVO COMANDI AEREI DA TERRA LL1775	01
47	06254800	B	ADESIVO STOP EMERGENZA SFONDO GIALLO L=70X50 (**)	01

**X20JPLUS COD. 17351800 POSIZIONE ADESIVI / POSITION ADHESIVE****JLG**

POS.	COD.	REV.	DESCRIZIONE / DESCRIPTION	Q.tà
48	06922700	A	ADESIVO FRECCIA ALLINEAMENTO L=50x15 (**)	02
49	07350300	A	ADESIVO SOLLEVAMENTO PIATTAFORMA CON MULETTO L=90X70 MM	04
50	06214200	A	ADESIVO LIQUIDO REFRIGERANTE SFONDO BIANCO Ø 50	01
51	06448100	<b>B</b>	ADESIVO RIPRISTINARE I TAPPI FERMO GUIDA L= 100X35 MM	02
52	07071000	<b>B</b>	ADESIVO JLG CLAXON SU PIATTAFORME L=38,3X28,55 MM (**)	01
53	06136900	A	ADESIVO PUNTI DI INGRASSAGGIO Ø 55 mm	01
54	07508200	A	ADESIVO BLOCCHETTO ACCENSIONE MOTORE DIESEL - EST. Ø 70 - INT. Ø 35 MM	01
55				
56				
57				
58				
59				
60				
61				
62				
63				
64				
65				
66				
67				
68				
69				
70				
71	07669100	<b>B</b>	ADESIVO JLG X20JPLUS PORTATA CESTO 1 PERSONA L=135X145 MM - NON IN DISTINTA	01

# **KIT ADESIVI IN LINGUA / *LANGUAGE KIT STICKERS***

## **X20JPLUS - JLG**

**Cod. 173518IT**

**Cod. 173518GB**

**Cod. 173518FR**

**Cod. 173518DE**

**Cod. 173518ES**

**Cod. 173518NL**

**Cod. 173518PT**

**Cod. 173518SW**

**Cod. 173518DA**

**Cod. 173518NO**

**Cod. 173518FI**



**173518\*\* POSIZIONE ADESIVI IN LINGUA /**  
**POSITION LANGUAGE STICKERS**

**IN LINGUA / LANGUAGE**

**VOLTAGGIO / VOLTAGE**

POS.	COD.	REV.	DESCRIZIONE / DESCRIPTION	Q.tà
	1735181IT		ADESIVI PIATTAFORMA AEREA X20JPLUS LINGUA ITALIANO	
L1	06555300	<b>B</b>	ADESIVO USO PIATTAFORMA LINGUA ITALIANA LL 23.12 L=128X230 MM	01
L2	06561200	<b>B</b>	ADESIVO PERICOLO 230 VOLT 16A GIALLO L=47 X 47 MM	04
L3	07348900	A	ADESIVO DISCESA DI EMERGENZA LL 2010 MOTORE TERMICO E LITHIUM - ITA L=290X205 MM	01
	173518GB		ADESIVI PIATTAFORMA AEREA X20JPLUS LINGUA INGLESE	
L1	06562600	<b>B</b>	ADESIVO USO PIATTAFORMA INGLESE L=128X230 MM	01
L2	06561200	<b>B</b>	ADESIVO PERICOLO 230 VOLT 16A GIALLO L=47 X 47 MM	04
L3	073489GB	A	ADESIVO DISCESA DI EMERGENZA LL 2010 MOTORE TERMICO E LITHIUM - ING L=290X205 MM	01
	173518FR		ADESIVI PIATTAFORMA AEREA X20JPLUS LINGUA FRANCESE	
L1	06562700	<b>B</b>	ADESIVO USO PIATTAFORMA FRANCESE L=128X230 MM	01
L2	06561200	<b>B</b>	ADESIVO PERICOLO 230 VOLT 16A GIALLO L=47 X 47 MM	04
L3	073489FR	A	ADESIVO DISCESA DI EMERGENZA LL2010 MOTORE TERMICO E LITHIUM - FRA L=290X205 MM	01
	173518DE		ADESIVI PIATTAFORMA AEREA X20JPLUS LINGUA TEDESCO	
L1	06562800	<b>B</b>	ADESIVO USO PIATTAFORMA TEDESCO L=128X230 MM	01
L2	06561200	<b>B</b>	ADESIVO PERICOLO 230 VOLT 16A GIALLO L=47 X 47 MM	04
L3	073489DE	A	ADESIVO DISCESA DI EMERGENZA LL 2010 MOTORE TERMICO E LITHIUM - TED L=290X205 MM	01
	173518ES		ADESIVI PIATTAFORMA AEREA X20JPLUS LINGUA SPAGNOLO	
L1	06562900	<b>B</b>	ADESIVO USO PIATTAFORMA SPAGNOLO L=128X230 MM	01
L2	06561200	<b>B</b>	ADESIVO PERICOLO 230 VOLT 16A GIALLO L=47 X 47 MM	04
L3	073489ES	A	ADESIVO DISCESA DI EMERGENZA LL 2010 MOTORE TERMICO E LITHIUM - SPA L=290X205 MM	01

**173518\*\* POSIZIONE ADESIVI IN LINGUA /**  
**POSITION LANGUAGE STICKERS**

**IN LINGUA / LANGUAGE**

**VOLTAGGIO / VOLTAGE**

POS.	COD.	REV.	DESCRIZIONE / DESCRIPTION	Q.tà
	173518NL		ADESIVI PIATTAFORMA AEREA X20JPLUS LINGUA OLANDESE	
L1	06563000	<b>B</b>	ADESIVO USO PIATTAFORMA OLANDESE L=128X230 MM	01
L2	06561200	<b>B</b>	ADESIVO PERICOLO 230 VOLT 16A GIALLO L=47 X 47 MM	04
L3	073489NL	A	ADESIVO DISCESA DI EMERGENZA LL 2010 MOTORE TERMICO E LITHIUM - OLA L=290X205 MM	01
	173518PT		ADESIVI PIATTAFORMA AEREA X20JPLUS LINGUA PORTOGHESE	
L1	06563100	<b>B</b>	ADESIVO USO PIATTAFORMA PORTOGHESE L=128X230 MM	01
L2	06561200	<b>B</b>	ADESIVO PERICOLO 230 VOLT 16A GIALLO L=47 X 47 MM	04
L3	073489PT	A	ADESIVO DISCESA DI EMERGENZA LL2010 MOTORE TERMICO E LITHIUM - POR L=290X205 MM	01
	173518SW		ADESIVI PIATTAFORMA AEREA X20JPLUS LINGUA SVEDESE	
L1	07137300	<b>B</b>	ADESIVO USO PIATTAFORMA AEREA CINGOLATA - SVEDESE L= 128X230 MM	01
L2	06561200	<b>B</b>	ADESIVO PERICOLO 230 VOLT 16A GIALLO L=47 X 47 MM	04
L3	073489SW	A	ADESIVO DISCESA DI EMERGENZA LL2010 MOTORE TERMICO E LITHIUM - SVE L=290X205 MM	01
	173518DA		ADESIVI PIATTAFORMA AEREA X20JPLUS LINGUA DANESE	
L1	07138100	<b>B</b>	ADESIVO USO PIATTAFORMA DANESE L=128X230 MM	01
L2	06561200	<b>B</b>	ADESIVO PERICOLO 230 VOLT 16A GIALLO L=47 X 47 MM	04
L3	073489DA	A	ADESIVO DISCESA DI EMERGENZA LL 2010 MOTORE TERMICO E LITHIUM - DAN L=290X205 MM	01
	173518NO		ADESIVI PIATTAFORMA AEREA X20JPLUS LINGUA NORVEGESE	
L1	07162000	<b>B</b>	ADESIVO USO PIATTAFORMA AEREA CINGOLATA - NORVEGESE L=128X230 MM	01
L2	06561200	<b>B</b>	ADESIVO PERICOLO 230 VOLT 16A GIALLO L=47 X 47 MM	04
L3	073489NO	A	ADESIVO DISCESA DI EMERGENZA .LL 2010 MOTORE TERMICO E LITHIUM - NOR L=290X205 MM	01



AGGIORNATO IL / UPDATED 16/06/2015

**Cod. 17351900**

**KIT ADESIVI COMMERCIALI PIATTAFORMA AEREA /  
AERIAL PLATFORM KIT STICKERS COMMERCIAL  
JLG/CE - X20JPLUS**

*DA USARE CON / FOR USE WITH*

**17351800 KIT ADESIVI DI SICUREZZA PIATTAFORMA AEREA JLG/CE X20JPLUS /  
STICKER KITS SAFETY AERIAL PLATFORM X20JPLUS**



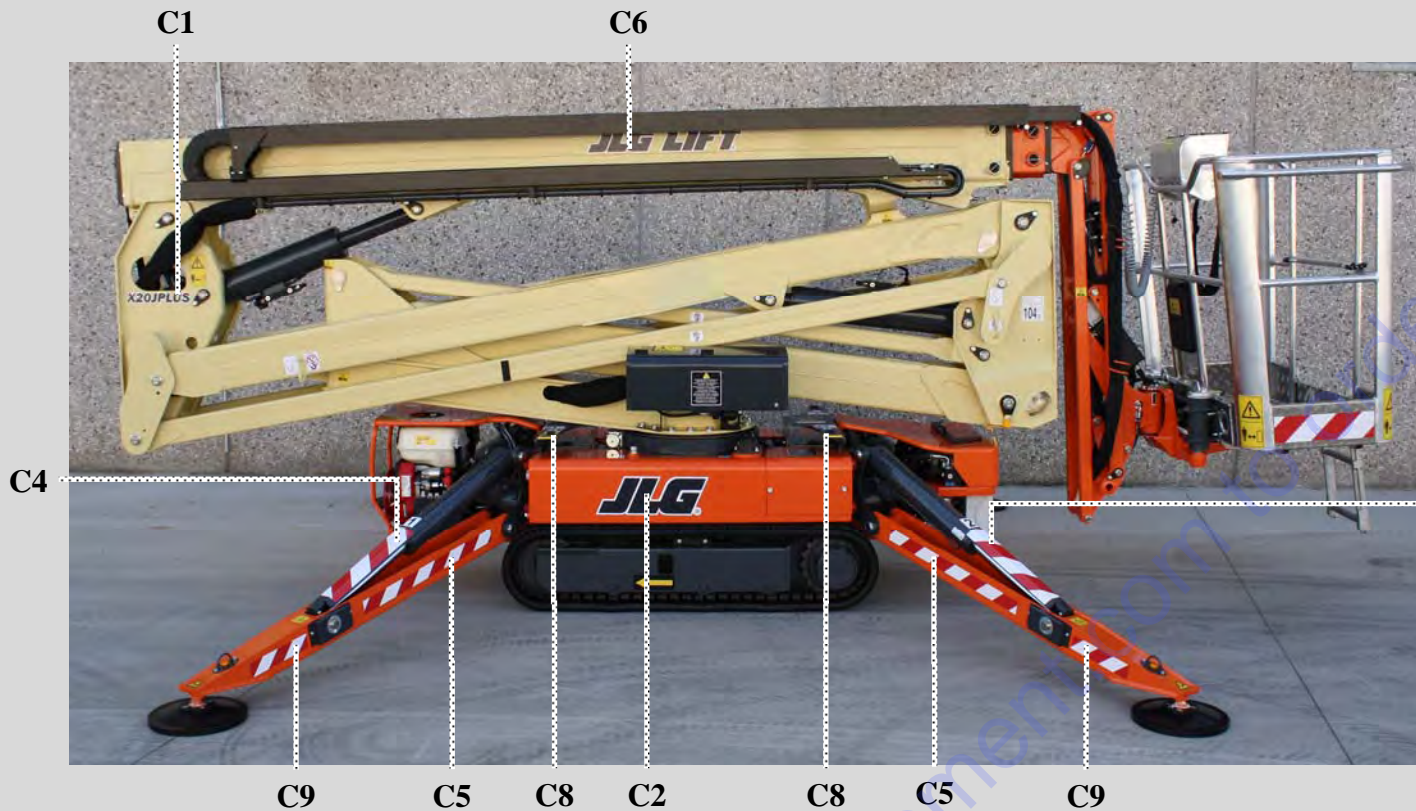

C10

KIT ADESIVI - X20JPLUS

SET OF DECALS - X20JPLUS

KIT COLLANTS - X20JPLUS

AUFKLEBERSATZ - X20JPLUS

KIT ADHESIVOS - X20JPLUS

ADHESIEKIT - X20JPLUS

**cod. 17351900**

Ed. 16/06/2015

Tav 01

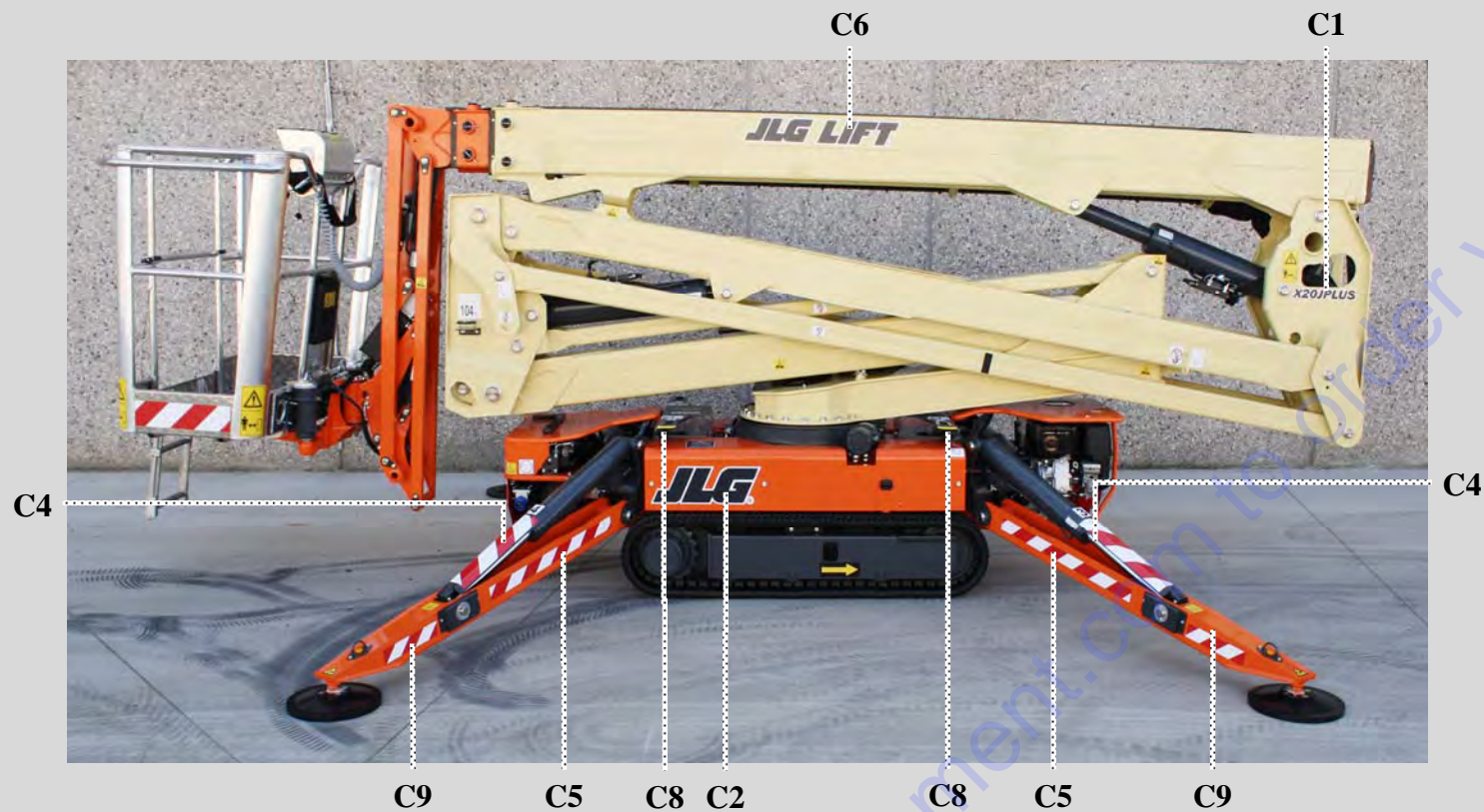

KIT ADESIVI - X20JPLUS	AUFKLEBERSATZ - X20JPLUS	<b>cod. 17351900</b>	
SET OF DECALS - X20JPLUS	KIT ADHESIVOS - X20JPLUS		
KIT COLLANTS - X20JPLUS	ADHESIEKIT - X20JPLUS	Ed. 16/06/2015	Tav 02

**Cod. 17351900**

**KIT ADESIVI COMMERCIALI PIATTAFORMA AEREA /  
*AERIAL PLATFORM KIT STICKERS COMMERCIAL***

**JLG/CE - X20JPLUS**

Go to [Discount-Equipment.com](http://Discount-Equipment.com) to order your parts



**17351900 POSIZIONE ADESIVI / POSITION ADHESIVE** **Aggiornato il / Updated 16/06/2015**

**JLG**

POS.	COD.	REV.	DESCRIZIONE / DESCRIPTION	Q.tà
C1	07396900	A	ADESIVO JLG LOGO PIATTAFORMA AEREA CINGOLATA X20JPLUS L= 270X46 MM	02
C2	07060500	A	ADESIVO LOGO JLG L=432x150MM	02
C3				
C4	06086700	A	ADESIVO CON RIGHE BIANCHE E ROSSE L=430X100 (**)	06
C5	06039600	A	ADESIVO CON RIGHE BIANCHE ROSSE L= 700 X 50 (**)	08
C6	07060600	A	ADESIVO LOGO JLG LIFT L=624x100 MM	02
C7				
C8	07268300	A	ADESIVO ATTENZIONE SOLLEVAMENTO FORCHE L=80X7 MM	04
C9	06040100	A	ADESIVO CON RIGHE BIANCHE ROSSE L= 240 X 50 (**)	08
C10	06039700	A	ADESIVO CON RIGHE BIANCHE ROSSE L= 700 X 80	01
C11				
C12				
C13				
C14				
C15				
C16				
C17				
C18				
C19				
C20				
C21				
C22				
C23				
C24				

**Cod. 17485000**

**KIT ADESIVI SICUREZZA PIATTAFORMA AEREA /  
AERIAL PLATFORM KIT STICKERS SAFETY**

**JLG / ANSI - X600AJ**

+ **Kit in lingua non inclusi nel codice generale**

+ *Language code not included in the standard kit*

**174850GB**

**174850FR**

**174850ES**

**174850PT**

**DA USARE CON / FOR USE WITH**

**17485100 KIT ADESIVI COMMERCIALI PIATTAFORMA AEREA X600AJ ANSI /  
STICKERS KIT COMMERCIAL AERIAL PLATFORM**

**17107300 KIT ADESIVI INTEGRAZIONE PER PIATTAFORME JLG-ANSI LITIUM /  
STICKER KIT FOR INTEGRATION LITIUM PLATFORM**

**X390AJ - X500AJ - X550AJ - X600AJ - X700AJ - X770AJ**

-----  
**171073\*\* KIT IN LINGUA / KIT IN LANGUAGE**



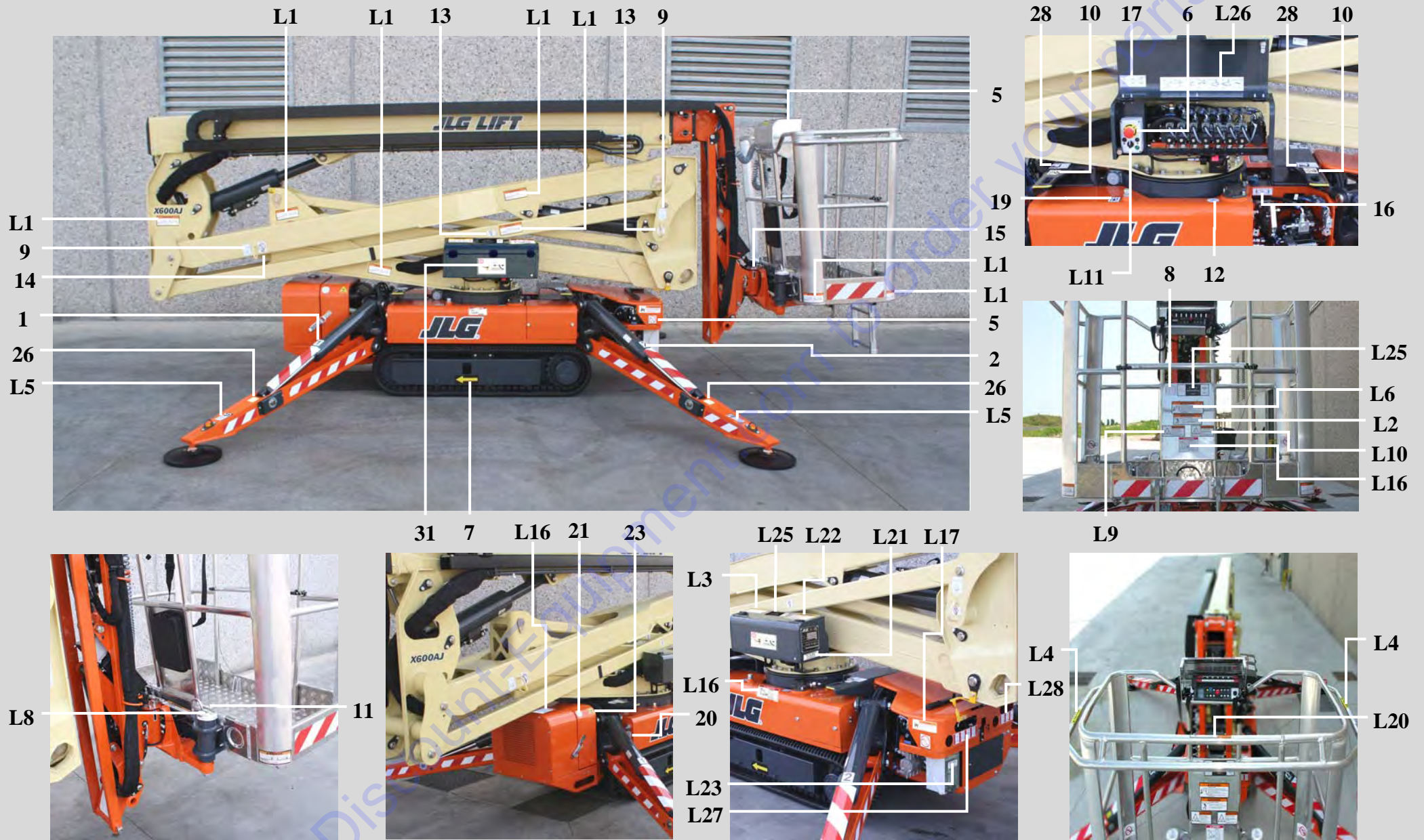

KIT ADESIVI - X600AJ

SET OF DECALS - X600AJ

KIT COLLANTS - X600AJ

AUFKLEBERSATZ - X600AJ

KIT ADHESIVOS - X600AJ

ADHESIEKIT - X600AJ

**Cod. 17485000**

**Tav 01**

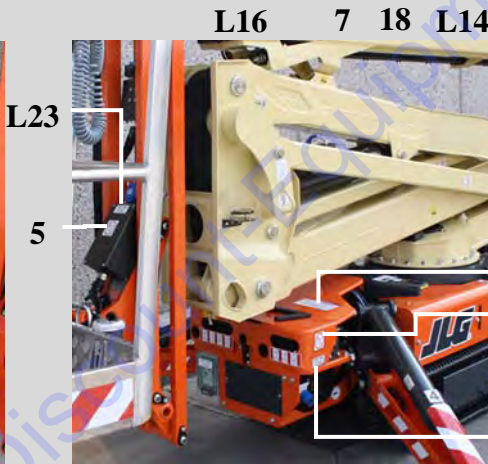
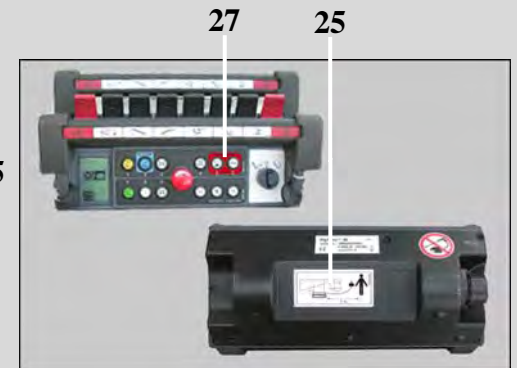
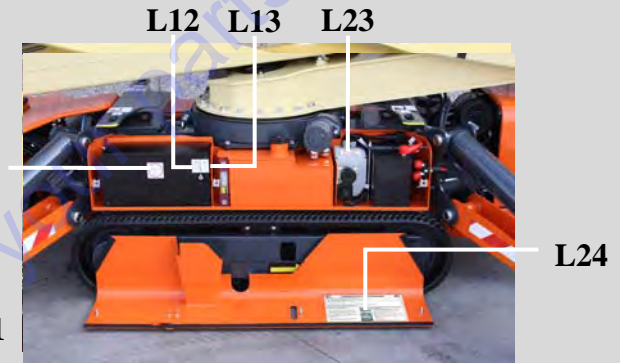
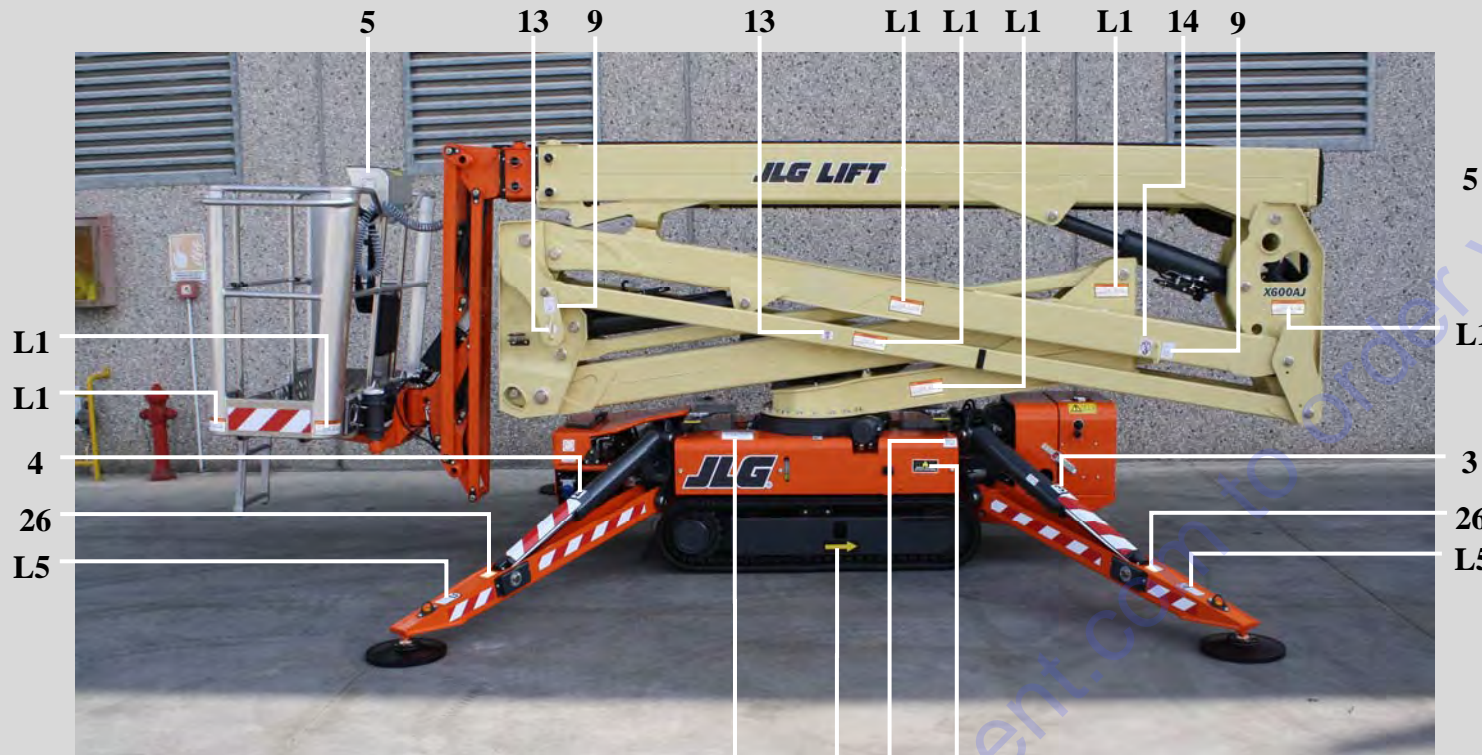

KIT ADESIVI - X600AJ

SET OF DECALS - X600AJ

KIT COLLANTS - X600AJ

AUFKLEBERSATZ - X600AJ

KIT ADHESIVOS - X600AJ

ADHESIEKIT - X600AJ

**Cod. 17485000**

Tav 02

**Cod. 17485000**

**KIT ADESIVI SICUREZZA PIATTAFORMA AEREA /  
*AERIAL PLATFORM KIT STICKERS SAFETY*  
**JLG / ANSI - X600AJ****

Go to [Discount-Equipment.com](http://Discount-Equipment.com) to order your parts

**17485000 POSIZIONE ADESIVI / POSITION STICKERS****IN LINGUA / LANGUAGE****JLG****VOLTAGGIO / VOLTAGE**

POSIZIONE	CODICE	REV.	DESCRIZIONE	QUANTITA'
01	06555500	A	ADESIVO NR 1 L=50X60 BIANCO	01
02	06555600	A	ADESIVO NR 2 L=50X60 BIANCO	01
03	06555700	A	ADESIVO N° 3 L=50X60 BIANCO	01
04	06555800	A	ADESIVO N° 4 L=50X60 BIANCO	01
05	1001125483	A	ADESIVO JLG VIETATO LAVARE L=63,5X63,5 MM	06
06	1706898	A	ADESIVO JLG EMERGENCY STOP Ø EST.57,15 Ø INT. 30,58	01
07	06040500	A	ADESIVO DIREZ. TRASLAZIONE FRECCIA GIALLA SFONDO NERO L=61 X 160	02
08	1701640	A	ADESIVO JLG LEGGERE IL MANUALE L= 69,85x69,85 MM	01
09	1703814	A	ADESIVO JLG ATTACCO ANCORAGGIO L=55,56X76,2 MM	04
10	07071200	A	ADESIVO JLG PUNTO DI SOLLEVAMENTO L= 40X66 MM	04
11	1704277	A	ADESIVO JLG ATTACCO CINTURE DI SICUREZZA L= 76,2X19,05 MM	02
12	06164700	A	ADESIVO FILTRO OILO IDRAULICO Ø SFONDO BIANCO	01
13	07056700	A	ADESIVO JLG DIVIETO DI SOLLEVAMENTO L=40X54,88	04
14	1701499	A	ADESIVO JLG DIVIETO DI SOLLEVAMENTO DAL PUNTO DI ANCORAGGIO L= 55,56X76 MM (**)	02
15	06706500	A	ADESIVO ALLINEAMENTO CESTO (2 PEZZI) L=16X50+13	01
16	06998800	A	ADESIVO DEVIATORE POMPA MANUALE PIATTAFORMA GL17.80XL L=86X34	01
17	07242000	A	ADESIVO SELETTORE 3 POSIZIONI 2° TELECOMANDO	01
18	1702155	A	ADESIVO JLG STACCABATTERIA L= 63,5X50,80 MM	01
19	1701504	A	ADESIVO JLG OLIO IDRAULICO L=50,8x63,5 MM	01
20	06165000	A	ADESIVO LIVELLO OLIO IDRAULICO Ø50 SFONDO BIANCO	01
21	06060000	A	ADESIVO LIVELLO OLIO MOTORE Ø50mm	01
22	1701542	A	ADESIVO JLG CARBURANTE BENZINA L= 101X63,5	01
	1701505	A	ADESIVO JLG CARBURANTE DIESEL L= 50,8X63,5	01
23	06056300	A	ADESIVO PERICOLO SCOTTATURE L=60X51 TRIANGOLARE SFONDO GIALLO	01





**KIT ADESIVI IN LINGUA /  
LANGUAGEKIT STICKERS  
JLG / ANSI- X600AJ**

**Cod.**

**174850GB**

**174850FR**

**174850ES**

**174850PT**

Go to Discount-Equipment.com to order your parts

174850** ADESIVI IN LINGUA / ADHESIVES IN LANGUAGE	IN LINGUA / LANGUAGE	JLG
	VOLTAGGIO / VOLTAGE	

POSIZIONE	CODICE	REV.	DESCRIZIONE	QUANTITA'
	174850GB		KIT ADESIVI SICUREZZA PIATTAFORMA AEREA X600AJ JLG / ANSI LINGUA INGLESE	
L1	07056100	A	ADESIVO JLG PERICOLO SCHIACCIAMENTO L= 140x60,71 MM	14
L2	1706387	A	ADESIVO JLG PERICOLO SCHIACCIAMENTO L=177,80x69,85 MM ( SUL CESTO )	01
L3	1706099	A	ADESIVO JLG PERICOLO SCHIACCIAMENTO L= 161,92X69,85 MM ( A TERRA )	01
L4	1702868	B	ADESIVO JLG PERICOLO SCHIACCIAMENTO MANO L= 241,30X25.40 MM ( SUL CESTO )	02
L5	07056200	A	ADESIVO JLG ATTACCO SCHIACCIAMENTO ARTO INFERIORE L= 110x60 (PRES. STABILIZZATORI )	04
L6	1706386	A	ADESIVO JLG PERICOLO CADUTE L=196,85x76,2 MM	01
L7	07051100	A	ADESIVO JLG PERICOLO CADUTA - RIPRISTINARE I TAPPI L=196,5x35 MM	01
L8	07051000	A	ADESIVO JLG PERICOLO DI CADUTA - SBLOCCARE SOLO NEI CASI PREVISTI L= 50X50 MM	02
L9	1706133	C	ADESIVO JLG PERICOLO RIBALTAMENTO L=139,7X68,85 MM	01
L10	07058600	A	ADESIVO JLG POSIZIONE STABILIZZATORI X390, X550	01
L11	07349200	A	ADESIVO AVVIAMENTO MOTORE DA TERRA LL2010 IIIS L=76,5X37 MM	01
L12	07042100	A	ADESIVO JLG SISTEMA BYPASS PARTE AEREA L=30X50	01
L13	07042200	A	ADESIVO JLG SISTEMA BYPASS TRASLAZIONE L= 30X50	01
L14	1702901	A	ADESIVO JLG ISTRUZIONI DISCESA EMERGENZA / POMPA MAUALE L=114,3x58,73MM	01
L15	3252347	B	ADESIVO JLG ATTENZIONE PEDALE L= 69,85x57,15 MM	01
L16	1706128	E	ADESIVO JLG PERICOLO DI FOLGORAZIONE L=120,65x91,50 MM	05
L17	1703813	A	ADESIVO JLG PERICOLO ESLOSIONE BATTERIE L=149,25X47,62 MM	01
L18	1704972	C	ADESIVO JLG PERICOLO ESPLOSIONE L=63,5x92,07 MM	01
L19				
L20	1706385	C	ADESIVO JLG SCORRIMENTO SBARRA CHIUSURA CESTO L=184,15X25,4 MM	01
L21	1705514	A	ADESIVO JLG CONFORMITA' CSA L= 76,20x22,22 MM	01
L22	1706135	B	ADESIVO JLG USO PIATTAFORMA (GB) L=139,70x88,90 MM	01
L23	07056400	B	ADESIVO JLG PERICOLO 120V - 60HZ L= 75x32,68 MM	04

# PARTS FINDER

**Search Website  
by Part Number**



**Search Manual  
Library For Parts  
Manual & Lookup Part  
Numbers – Purchase  
or Request Quote**

**Search Manuals**

Enter your information to help us find the right parts manual for your machine.

\* Brand:

\* Model:

\* Serial:

\* Part Number:

SEARCH

**Can't Find Part or  
Manual? Request Help  
by Manufacturer,  
Model & Description**

**Parts Order Form**

Please fill in the following information to help us find the right part for your machine.

Manufacturer:	<input type="text"/>
Model:	<input type="text"/>
Description:	<input type="text"/>
Part Number:	<input type="text"/>
Quantity:	<input type="text"/>
Notes:	<input type="text"/>

Discount-Equipment.com is your online resource for quality parts & equipment.

Florida: **561-964-4949** Outside Florida TOLL FREE: **877-690-3101**

**Need parts?**

Click on this link: <http://www.discount-equipment.com/category/5443-parts/> and choose one of the options to help get the right parts and equipment you are looking for. Please have the machine model and serial number available in order to help us get you the correct parts. If you don't find the part on the website or on one of the online manuals, please fill out the request form and one of our experienced staff members will get back to you with a quote for the right part that your machine needs.

We sell worldwide for the brands: Genie, Terex, JLG, MultiQuip, Mikasa, Essick, Whiteman, Mayco, Toro Stone, Diamond Products, Generac Magnum, Airman, Haulotte, Barreto, Power Blanket, Nifty Lift, Atlas Copco, Chicago Pneumatic, Allmand, Miller Curber, Skyjack, Lull, Skytrak, Tsurumi, Husquvarna Target, Stow, Wacker, Sakai, Mi-T-M, Sullair, Basic, Dynapac, MBW, Weber, Bartell, Bennar Newman, Haulotte, Ditch Runner, Menegotti, Morrison, Contec, Buddy, Crown, Edco, Wyco, Bomag, Laymor, EZ Trench, Bil-Jax, F.S. Curtis, Gehl Pavers, Heli, Honda, ICS/PowerGrit, IHI, Partner, Imer, Clipper, MMD, Koshin, Rice, CH&E, General Equipment, Amida, Coleman, NAC, Gradall, Square Shooter, Kent, Stanley, Tamco, Toku, Hatz, Kohler, Robin, Wisconsin, Northrock, Oztec, Toker TK, Rol-Air, APT, Wylie, Ingersoll Rand / Doosan, Innovatech, Con X, Ammann, Mecalac, Makinex, Smith Surface Prep, Small Line, Wanco, Yanmar



AGGIORNATO IL / UPDATED 24/04/2014

**Cod. 17485100 (no a ricambio/no spare kit)**

**KIT ADESIVI COMMERCIALI PIATTAFORMA AEREA /**  
*STICKERS KIT COMMERCIAL AERIAL PLATFORM*  
**JLG - X600AJ**

**DA USARE CON / FOR USE WITH**

**- 17485000 KIT ADESIVI SICUREZZAPIATTAFORMA AEREA / AERIAL PLATFORM SECURITY STICKERS KIT X600AJ ANSI**



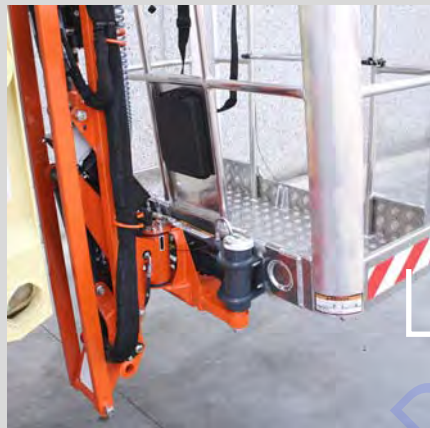
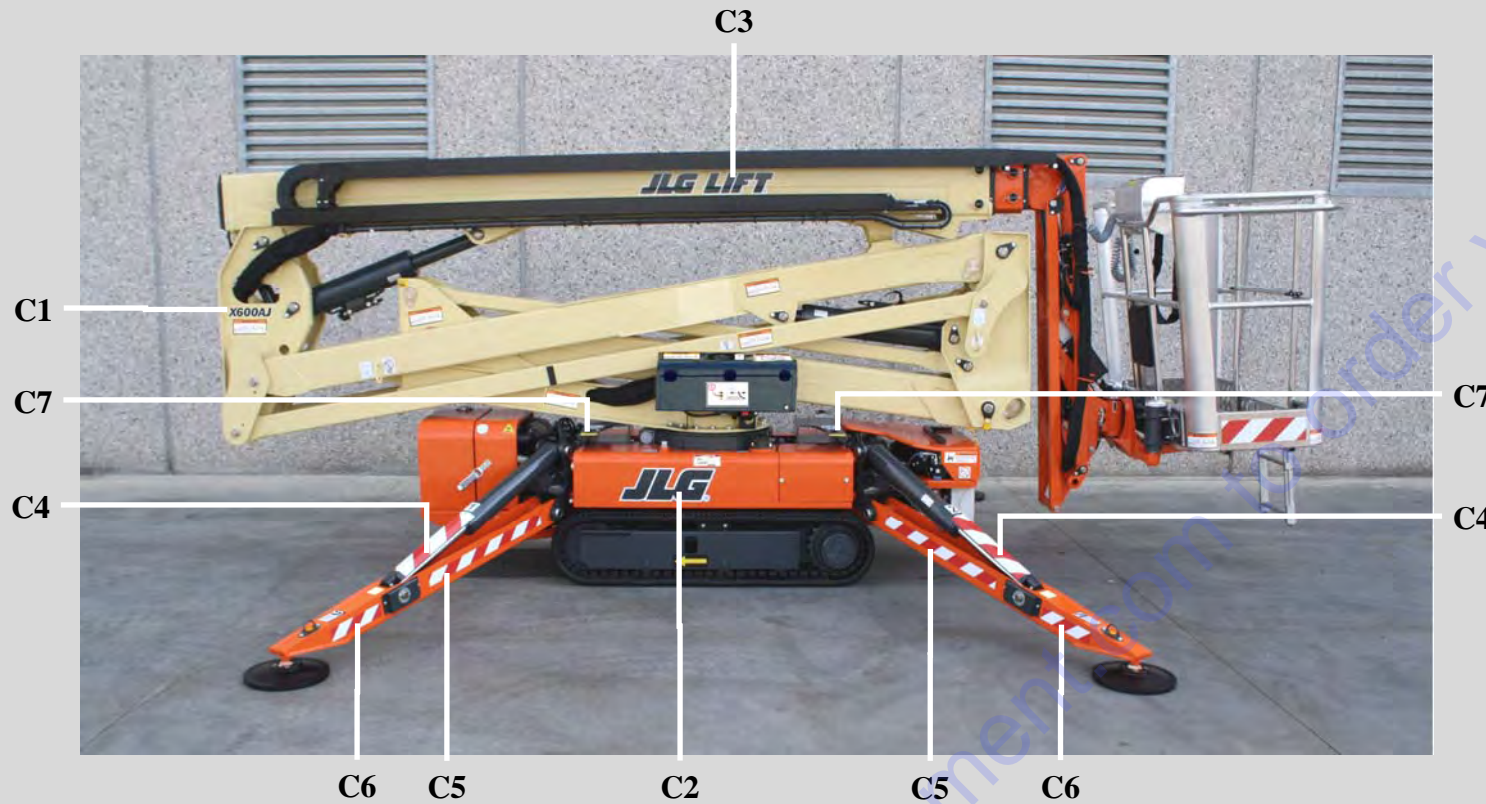

KIT ADESIVI - X600AJ

SET OF DECALS - X600AJ

KIT COLLANTS - X600AJ

AUFKLEBERSATZ - X600AJ

KIT ADHESIVOS - X600AJ

ADHESIEKIT - X600AJ

**Cod. 17485100**

Ed. 24/04/2014

Tav 01

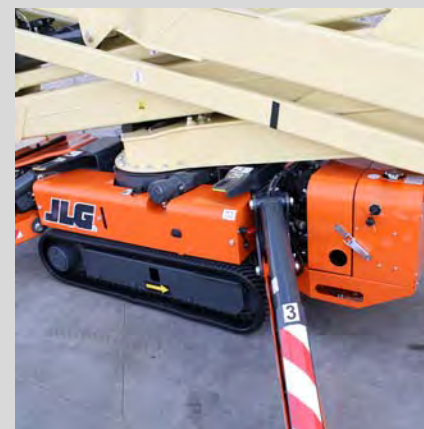
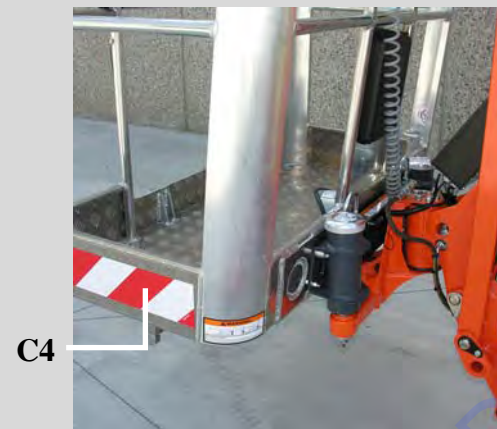
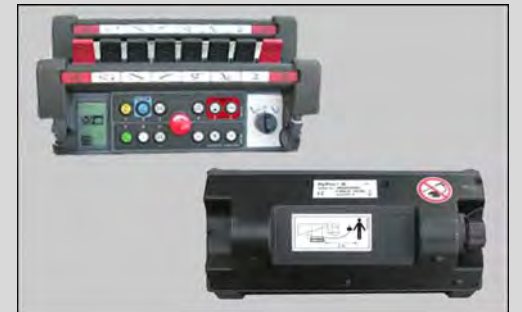
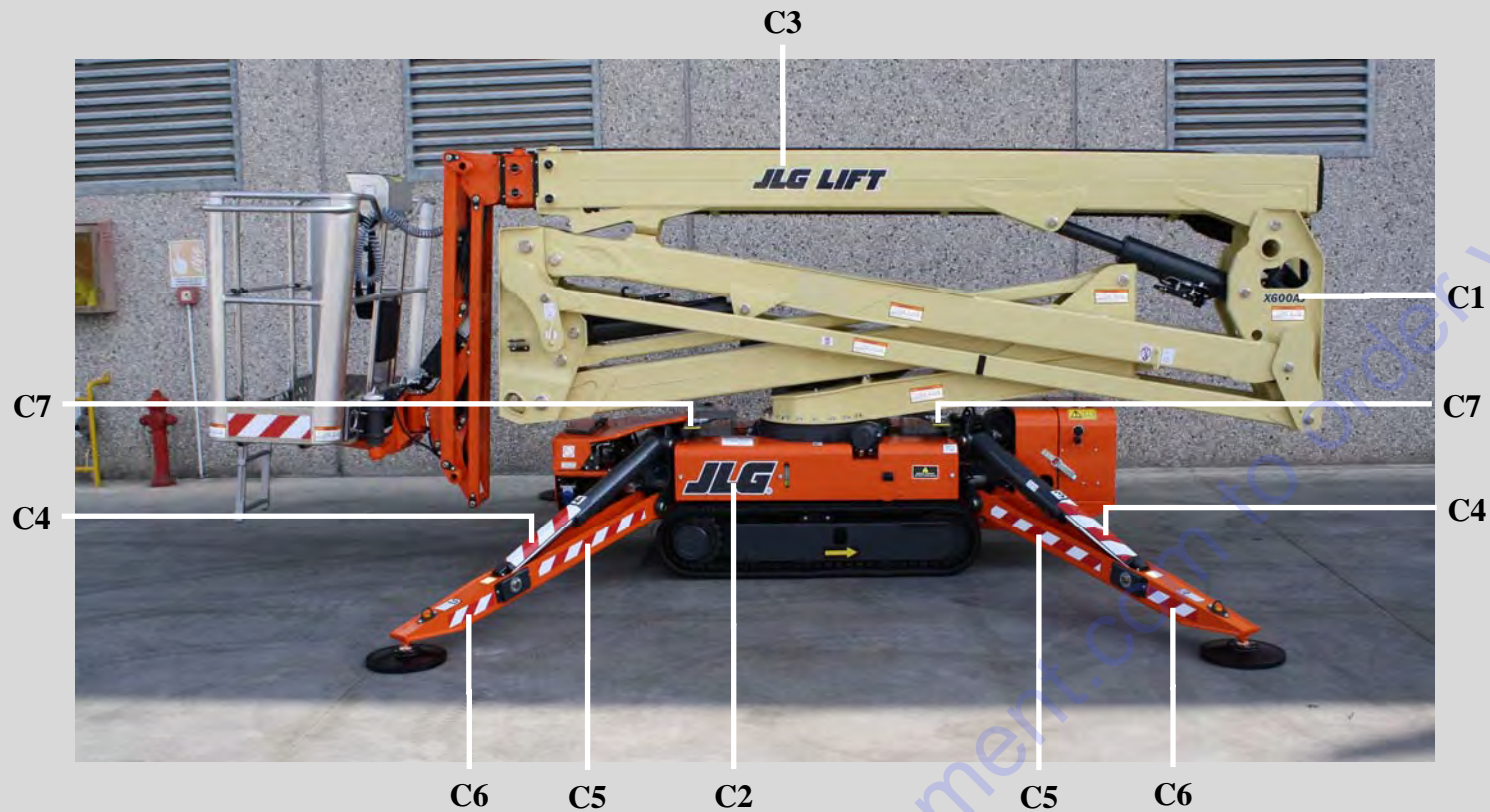

KIT ADESIVI - X600AJ

SET OF DECALS - X600AJ

KIT COLLANTS - X600AJ

AUFKLEBERSATZ - X600AJ

KIT ADHESIVOS - X600AJ

ADHESIEKIT - X600AJ

**Cod. 17485100**

Ed. 24/04/2014

Tav 02



**Cod. 17485100 (no a ricambio/no spare kit)**

**KIT ADESIVI COMMERCIALI PIATTAFORMA AEREA /  
*STICKERS KIT COMMERCIAL AERIAL PLATFORM***

**JLG / ANSI - X600AJ**

Go to Discount-Equipment.com to order your parts

**17485100 POSIZIONE ADESIVI / POSITION STICKERS**  
**JLG / ANSI - X600AJ**  
**Aggiornato il / Updated 24/04/2014**

**IN LINGUA / LANGUAGE**

**JLG**

**VOLTAGGIO / VOLTAGE**

POS.	COD.	REV.	DESCRIZIONE / DESCRIPTION	Q.tà
C1	07495700	A	ADESIVO LOGO X600AJ COLORE GRIGIO PANTONE 432C L=200X43 MM	02
C2	07060500	A	ADESIVO JLG LOGO JLG COLORE GRIGIO PANTONE 432C L=432x150MM (**)	02
C3	07060700	A	ADESIVO JLG LOGO JLG LIFT COLORE GRIGIO PANTONE 432C L=809x130 MM (**)	02
C4	06086700	A	ADESIVO CON RIGHE BIANCHE E ROSSE L=430X100 (**)	06
C5	06039600	A	ADESIVO CON RIGHE BIANCHE ROSSE L= 700 X 50 (**)	08
C6	06040100	A	ADESIVO CON RIGHE BIANCHE ROSSE L= 240 X 50 (**)	08
C7	07268300	A	ADESIVO ATTENZIONE SOLLEVAMENTO FORCHE L= 80X7 MM	04
C8	06039700	A	ADESIVO CON RIGHE BIANCHE ROSSE L= 700 X 80 (**)	01
C9				
C10				
C11				
C12				
C13				
C14				
C15				
C16				
C17				
C18				
C19				
C20				
C21				
C22				
C23				
C24				

**Cod. 17776600**

**KIT ADESIVI SICUREZZA PER PIATTAFORMA AEREA /  
*STICKERS KIT SAFETY FOR AERIAL PLATFORM*  
**JLG/CE X20JPLUS - MK2****

**+ kit in lingua non inclusi nel codice generale + language code not included in the standard kit**  
**177766IT - 177766GB - 177766FR - 177766DE - 177766ES - 177766NL -**  
**177766PT - 177766DA - 177766SW - 177766NO - 177766PL - 177766FI -**

*DA USARE CON / FOR USE WITH*

**17725300 KIT ADESIVI COMMERCIALI PIATTAFORMA AEREA X20JPLUS /**  
*STICKER KITS COMMERCIAL AERIAL PLATFORM X20JPLUS*

---

**17187700 KIT INTEGRAZIONE ADESIVI PER PIATTAFORME AEREE JLG/CE LITHIUM /**  
*INTEGRATION KIT STICKERS PLATFORMS JLG / CE LITHIUM*  
**X14J\_14J-H\_X17J\_X17JPLUS\_X20JPLUS\_X19J\_X23J\_X26JPLUS**



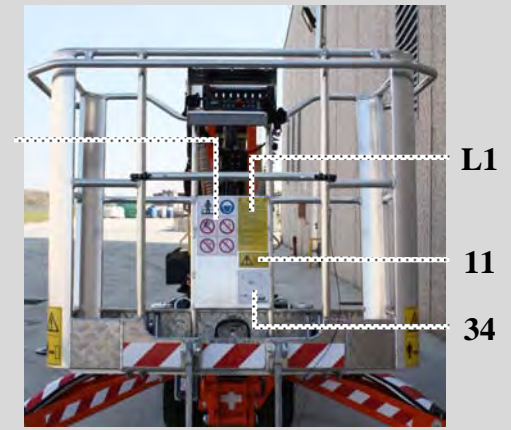
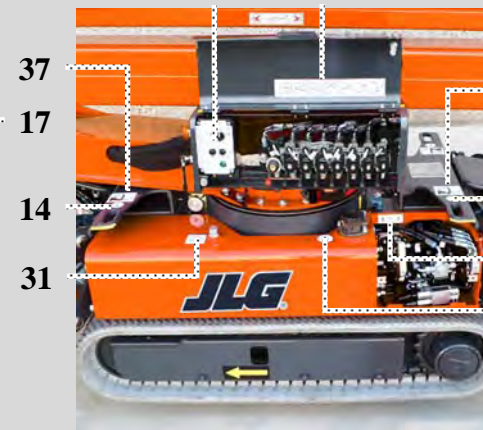
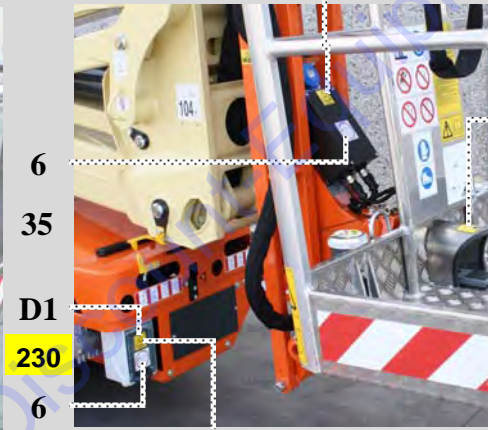
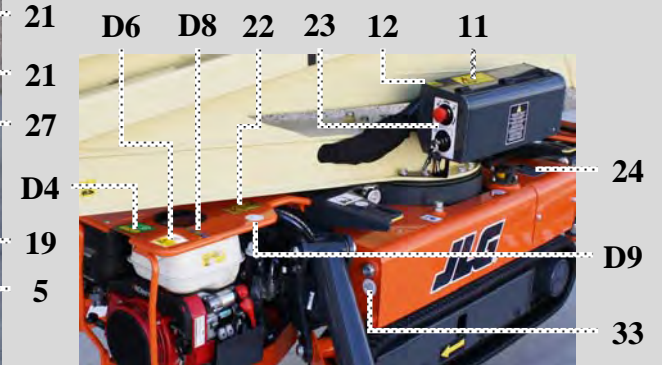
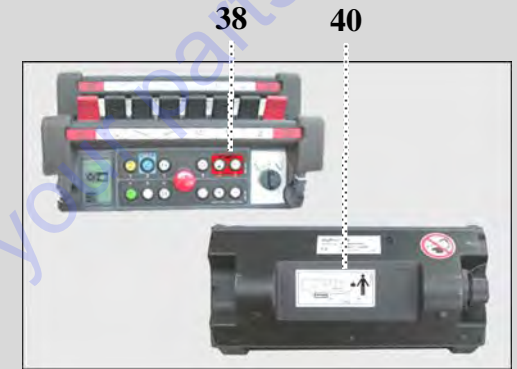
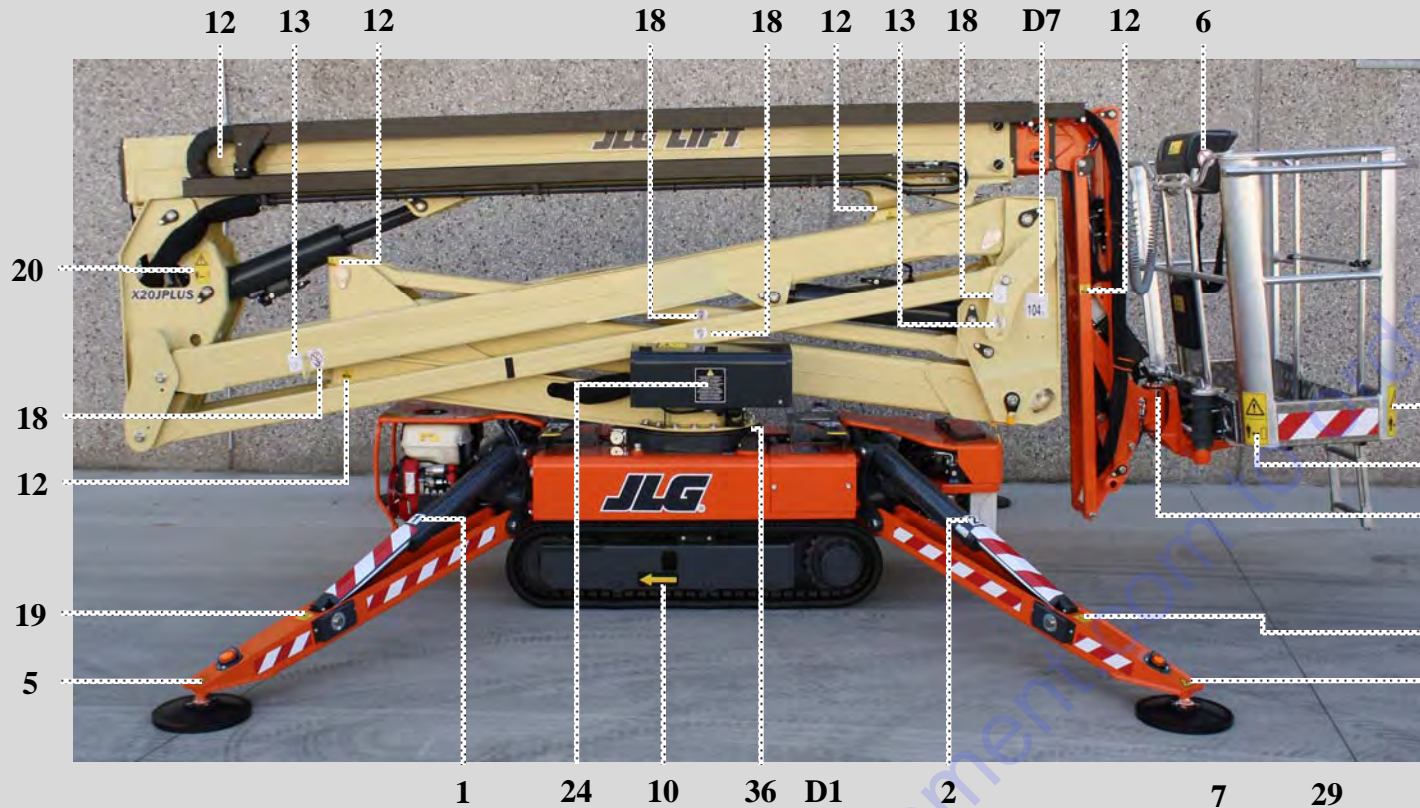

D2 110

KIT ADESIVI - JLG LIFT X20JPLUS - MK2

AUFKLEBERSATZ - JLG LIFT X20JPLUS - MK2

SET OF DECALS - JLG LIFT X20JPLUS - MK2

KIT ADHESIVOS - JLG LIFT X20JPLUS - MK2

KIT COLLANTS - JLG LIFT X20JPLUS - MK2

ADHESIEKIT - JLG LIFT X20JPLUS - MK2

**cod. 17776600**

**Tav 01**

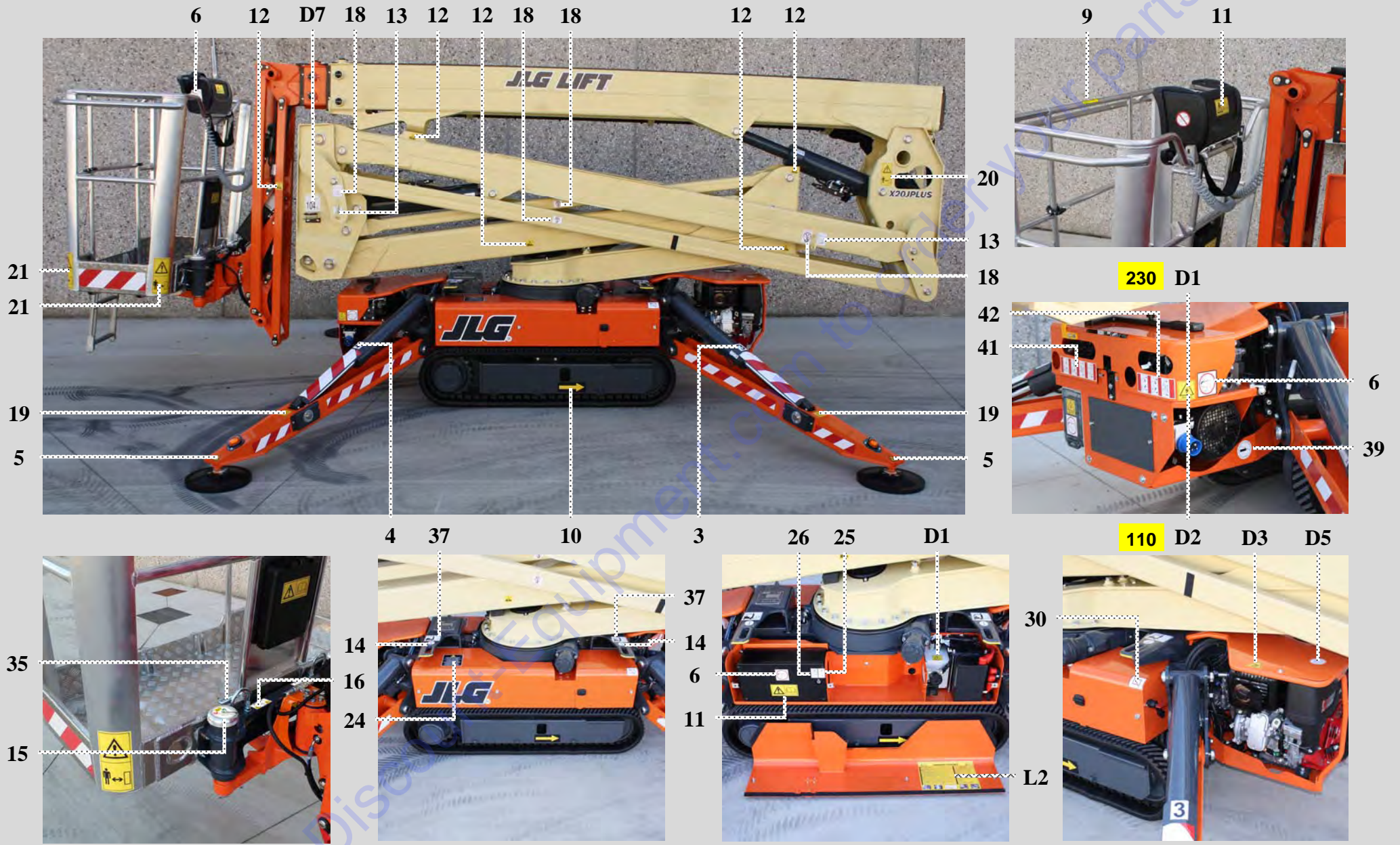

KIT ADESIVI - JLG LIFT X20JPLUS - MK2

AUFKLEBERSATZ - JLG LIFT X20JPLUS - MK2

SET OF DECALS - JLG LIFT X20JPLUS - MK2

KIT ADHESIVOS - JLG LIFT X20JPLUS - MK2

KIT COLLANTS - JLG LIFT X20JPLUS - MK2

ADHESIEKIT - JLG LIFT X20JPLUS - MK2

**cod. 17776600**

**Tav 02**

# MOTORE DIESEL / DIESEL ENGINE



D4

D5

D1

11



22

34

D6

D3

KIT ADESIVI - JLG LIFT X20JPLUS - MK2

SET OF DECALS - JLG LIFT X20JPLUS - MK2

KIT COLLANTS - JLG LIFT X20JPLUS - MK2

AUFKLEBERSATZ - JLG LIFT X20JPLUS - MK2

KIT ADHESIVOS - JLG LIFT X20JPLUS - MK2

ADHESIEKIT - JLG LIFT X20JPLUS - MK2

**cod. 17776600**

**Tav 03**

**Cod. 17776600**

**POSIZIONE ADESIVI SICUREZZA PER /  
*POSITION STICKERS COMMERCIAL FOR***

**JLG/CE X20JPLUS - MK2**

[Go to Discount-Equipment.com](http://Go to Discount-Equipment.com) [order your parts](http://order your parts)



**17776600 POSIZIONE ADESIVI / POSITION ADHESIVE**

**JLG**

POS.	COD.	REV.	DESCRIZIONE / DESCRIPTION	Q.tà
01	06555500	A	ADESIVO NR 1 L=50X60 BIANCO	01
02	06555600	A	ADESIVO NR 2 L=50X60 BIANCO	01
03	06555700	A	ADESIVO N° 3 L=50X60 BIANCO	01
04	06555800	A	ADESIVO N° 4 L=50X60 BIANCO	01
05	06041200	A	ADESIVO SCHIACCIAMENTO PIEDI TRIANGOLARE L=53X46 GIALLO	04
06	1001125483	A	ADESIVO JLG VIETATO LAVARE L=63,5X63,5 MM (**)	06
07	07668300	A	ADESIVO SELETTORE SCATOLA COMANDI TERRA / CESTO L=105x155 MM	01
08	06924300	A	ADESIVO CASCO - IMBRAGATURA - DIVIETI SERIE METAL-IIIS L= 170X250 MM	01
09	1706493	B	ADESIVO JLG SCORRIMENTO SBARRA CHIUSURA CESTO L= 76,2X25,4 MM (**)	01
10	06040500	A	ADESIVO DIREZ. TRASLAZIONE FRECCIA GIALLA SFONDO NERO L=61 X 160	02
11	06040900	A	ADESIVO LEGGERE IL MANUALE L=125 X 65 GIALLO	06
12	06041300	B	ADESIVO ATTENZIONE PERICOLO TAGLI L=35 X 40 GIALLO	11
13	1703814	A	ADESIVO JLG ATTACCO ANCORAGGIO L=55,56X76,2 MM (**)	04
14	06044000	A	ADESIVO ATTACCO SOLLEVAMENTO SFONDO BIANCO COLORE BLU Ø40 (**)	04
15	06448200	B	ADESIVO SBLOCCARE SOLO NEI CASI PREVISTI" Ø 60 MM	02
16	06448100	B	ADESIVO RIPRISTINARE I TAPPI FERMO GUIDA L= 100X35 MM	02
17	1705828	B	ADESIVO JLG INTERUTTORE PEDALE L= 69,85X54 (**)	01
18	07056700	A	ADESIVO JLG DIVIETO DI SOLLEVAMENTO L=54,88X40 (**)	08
19	07320400	A	ADESIVO REAZIONE AL SUOLO STABILIZZATORI LL2010	04
20	07058800	A	ADESIVO PERICOLO MANTENERE LE DISTANZE L=65X130 MM	02
21	06040300	A	ADESIVO PERICOLO MANTENERE LE DISTANZE GIALLO L=100 X 200 MM (**)	04
22	1706098	B	ADESIVO JLG PERICOLO ESPLOSIONE L=63,5X117,475 MM (**)	01
23	07668200	A	ADESIVO EMERGENCY STOP E BLOCCHETTO ACCENSIONE L=85x160 MM	01
24	07056800	B	ADESIVO JLG DISCESA DI EMERGENZA ALL'INTERNO L=114X130 MM (**)	03

**17776600 POSIZIONE ADESIVI / POSITION ADHESIVE**

**JLG**

POS.	COD.	REV.	DESCRIZIONE / DESCRIPTION	Q.tà
25	06086000	A	ADESIVO SISTEMA BYPASS TRASLAZIONE L=30X50	01
26	06085900	A	ADESIVO SISTEMA BYPASS PARTE AEREA L=30X50	01
27	06706500	A	ADESIVO ALLINEAMENTO CESTO (2 PEZZI) L=16X50+13	01
28	06998800	A	ADESIVO DEVIATORE POMPA MANUALE PIATTAFORMA GL17.80XL L=86X34	01
29	07668100	A	ADESIVO PULSANTI DISTRIBUTORE PARTE AEREA LL2614 L=318X52 MM	01
30	1702155	A	ADESIVO JLG STACCABATTERIA L= 63,5X50,80 MM (**)	01
31	1701504	A	ADESIVO JLG OLIO IDRAULICO L=50,8x63,5 MM (**)	01
32	06164700	A	ADESIVO FILTRO OLIO Ø50 SFONDO BIANCO	01
33	06165000	A	ADESIVO LIVELLO OLIO IDRAULICO Ø50 SFONDO BIANCO	01
34	07397200	A	ADESIVO JLG X20JPLUS PORTATA CESTO 2 PERSONE L=135X145 MM	01
35	1704277	A	ADESIVO JLG ATTACCO CINTURE DI SICUREZZA L= 76,2X19,05 MM	02
36	06922700	A	ADESIVO FRECCIA ALLINEAMENTO L=50x15 (**)	02
37	07350300	A	ADESIVO SOLLEVAMENTO PIATTAFORMA CON MULETTO L=90X70 MM	04
38	07071000	B	ADESIVO JLG CLAXON SU PIATTAFORME L=38,3X28,55 MM (**)	01
39	06136900	A	ADESIVO PUNTI DI INGRASSAGGIO Ø 55 mm	01
40	07240300	B	ADESIVO DISTANZA 1m SU TELE/RADIO COMANDI	01
41	1608710001	C	ADESIVO PULSANTI DISTR. A TERRA LATO SX GL17.80 L=194X50 MM	01
42	1608710002	C	ADESIVO PULSANTI DISTRIB A TERRA GL 17.80 LATO DX L= 150X50 mm	01
43				
44				
45				
46				
47				
48				

**17776600 POSIZIONE ADESIVI / POSITION ADHESIVE**

POS.	COD.	REV.	ADESIVI IN DISTINTA MACCHINA / STICKERS IN LIST MACHINE	Q.tà
D1	06561200	B	ADESIVO PERICOLO 230 VOLT16 AMPERE GIALLO L=47X47 MM	04
	06042400	B	ADESIVO PERICOLO 110 VOLT16 AMPERE GIALLO L=47 X 47 MM	04
	06257300	A	ADESIVO PERICOLO 240 VOLT GIALLO L=47 X 47 MM	04
D2	07668000	A	ADESIVO PERICOLO 110 VOLT 32A GIALLO L=47 X 47 MM	02
D3	06056300	A	ADESIVO PERICOLO SCOTTATURE TRIANGOLARE SFONDO GIALLO L=60X51 MM	01
D4	06041600	B	ADESIVO CARBURANTE BENZINA COLORE VERDE L=60 X 80 MM	01
	06043900	A	ADESIVO CARBURANTE DIESEL SFONDO BIANCO Ø 50 MM	01
D5	06164600	A	ADESIVO FILTRO ARIA SFONDO BIANCO Ø50 MM	01
D6	06227200	B	ADESIVO CONTROLLARE LIVELLO OLIO MOTORE L=80X80 MM	01
D7	07034200	B	ADESIVO RUMORE 104 dB L=90X100 MM	02
D8	06232100	B	ADESIVO ATTENZIONE BENZINA INFIAMMABILE L=170X42 MM	01
D9	06060000	A	ADESIVO LIVELLO OLIO MOTORE Ø50mm	01
D10	06214200	A	ADESIVO LIQUIDO REFRIGERANTE SFONDO BIANCO Ø 50	01
D11				
D12				
D13				
D14				
D15				
D16				
D17				
			<b>PER MACCHINE CON CESTO A 1 PERSONA / FOR MACHINE WITH BASKET 1 PERSONA</b>	
43	07669100	B	ADESIVO JLG X20JPLUS PORTATA CESTO 1 PERSONA L=135X145 MM - NON IN DISTINTA	01

**POSIZIONE ADESIVI IN LINGUA PER /  
*POSITION STICKERS IN LANGUAGE FOR***

**JLG/CE X20JPLUS - MK2**

**Codici / *code***

**177766IT - 177766GB - 177766FR - 177766DE -  
177766ES - 177766NL - 177766PT - 177766DA -  
177766SW - 177766NO - 177766FI -**

**177766\*\* POSIZIONE ADESIVI IN LINGUA / POSITION LANGUAGE STICKERS**

POS.	COD.	REV.	DESCRIZIONE / DESCRIPTION	Q.tà
	1777661IT		ADESIVI PIATTAFORMA AEREA X20JPLUS LINGUA ITALIANO	
L1	06555300	<b>B</b>	ADESIVO USO PIATTAFORMA LINGUA ITALIANA LL 23.12 L=128X230 MM	01
L2	07348900	A	ADESIVO DISCESA DI EMERGENZA LL 2010 MOTORE TERMICO E LITHIUM - ITA L=290X205 MM	01
	177766GB		ADESIVI PIATTAFORMA AEREA X20JPLUS LINGUA INGLESE	
L1	06562600	<b>B</b>	ADESIVO USO PIATTAFORMA INGLESE L=128X230 MM	01
L2	073489GB	A	ADESIVO DISCESA DI EMERGENZA LL 2010 MOTORE TERMICO E LITHIUM - ING L=290X205 MM	01
	177766FR		ADESIVI PIATTAFORMA AEREA X20JPLUS LINGUA FRANCESE	
L1	06562700	<b>B</b>	ADESIVO USO PIATTAFORMA FRANCESE L=128X230 MM	01
L2	073489FR	A	ADESIVO DISCESA DI EMERGENZA LL2010 MOTORE TERMICO E LITHIUM - FRA L=290X205 MM	01
	177766DE		ADESIVI PIATTAFORMA AEREA X20JPLUS LINGUA TEDESCO	
L1	06562800	<b>B</b>	ADESIVO USO PIATTAFORMA TEDESCO L=128X230 MM	01
L2	073489DE	A	ADESIVO DISCESA DI EMERGENZA LL 2010 MOTORE TERMICO E LITHIUM - TED L=290X205 MM	01
	177766ES		ADESIVI PIATTAFORMA AEREA X20JPLUS LINGUA SPAGNOLO	
L1	06562900	<b>B</b>	ADESIVO USO PIATTAFORMA SPAGNOLO L=128X230 MM	01
L2	073489ES	A	ADESIVO DISCESA DI EMERGENZA LL 2010 MOTORE TERMICO E LITHIUM - SPA L=290X205 MM	01
	177766NL		ADESIVI PIATTAFORMA AEREA X20JPLUS LINGUA OLANDESE	
L1	06563000	<b>B</b>	ADESIVO USO PIATTAFORMA OLANDESE L=128X230 MM	01
L2	073489NL	A	ADESIVO DISCESA DI EMERGENZA LL 2010 MOTORE TERMICO E LITHIUM - OLA L=290X205 MM	01

**177766\*\* POSIZIONE ADESIVI IN LINGUA / POSITION LANGUAGE STICKERS**

POS.	COD.	REV.	DESCRIZIONE / DESCRIPTION	Q.tà
	177766SW		ADESIVI PIATTAFORMA AEREA X20JPLUS LINGUA SVEDESE	
L1	07137300	B	ADESIVO USO PIATTAFORMA AEREA CINGOLATA - SVEDESE L= 128X230 MM	01
L2	073489SW	A	ADESIVO DISCESA DI EMERGENZA LL2010 MOTORE TERMICO E LITHIUM - SVE L=290X205 MM	01
	177766PT		ADESIVI PIATTAFORMA AEREA X20JPLUS LINGUA PORTOGHESE	
L1	06563100	B	ADESIVO USO PIATTAFORMA PORTOGHESE L=128X230 MM	01
L2	073489PT	A	ADESIVO DISCESA DI EMERGENZA LL2010 MOTORE TERMICO E LITHIUM - POR L=290X205 MM	01
	1177766DA		ADESIVI PIATTAFORMA AEREA X20JPLUS LINGUA DANESE	
L1	07138100	B	ADESIVO USO PIATTAFORMA DANESE L=128X230 MM	01
L2	073489DA	A	ADESIVO DISCESA DI EMERGENZA LL 2010 MOTORE TERMICO E LITHIUM - DAN L=290X205 MM	01
	177766NO		ADESIVI PIATTAFORMA AEREA X20JPLUS LINGUA NORVEGESE	
L1	07162000	B	ADESIVO USO PIATTAFORMA AEREA CINGOLATA - NORVEGESE L=128X230 MM	01
L2	073489NO	A	ADESIVO DISCESA DI EMERGENZA .LL 2010 MOTORE TERMICO E LITHIUM - NOR L=290X205 MM	01
	177766PL			
L1	07506600	A	ADESIVO USO PIATTAFORMA AEREA CINGOLATA - POLACCO L= 128X230 MM **	01
L2	073489PL		ADESIVO DISCESA DI EMERGENZA LL2010 MOTORE TERM. E LITHIUM - POL L=290X205 MM	01
	177766FI		ADESIVI PIATTAFORMA AEREA X20JPLUS LINGUA FINLANDESE	
L1	07547700	A	ADESIVO USO PIATTAFORMA AEREA CINGOLATA - FINLANDESE L= 128X230 MM	01
L2	073489FI	A	ADESIVO DISC. DI EMERGENZA LL2010 MOT. TERMICO E LITHIUM - FINLANDESE L=290X205 MM	01

**KIT ADESIVI SICUREZZA PER PIATTAFORMA AEREA /  
AERIAL PLATFORM KIT STICKERS SAFETY  
JLG / ANSI - X600AJ - MK2**

**Cod. 17777000**

**Kit in lingua non inclusi nel codice generale + *Language code not included in the standard kit***

**177770GB - 177770FR - 177770ES - 177770PT**

**DA USARE CON / FOR USE WITH**

**17485100 KIT ADESIVI COMMERCIALI PIATTAFORMA AEREA X600AJ ANSI /  
STICKERS KIT COMMERCIAL AERIAL PLATFORM**

**17107300 KIT ADESIVI INTEGRAZIONE PER PIATTAFORME JLG-ANSI LITIUM /  
STICKER KIT FOR INTEGRATION LITIUM PLATFORM  
X390AJ - X500AJ - X550AJ - X600AJ - X700AJ - X770AJ**





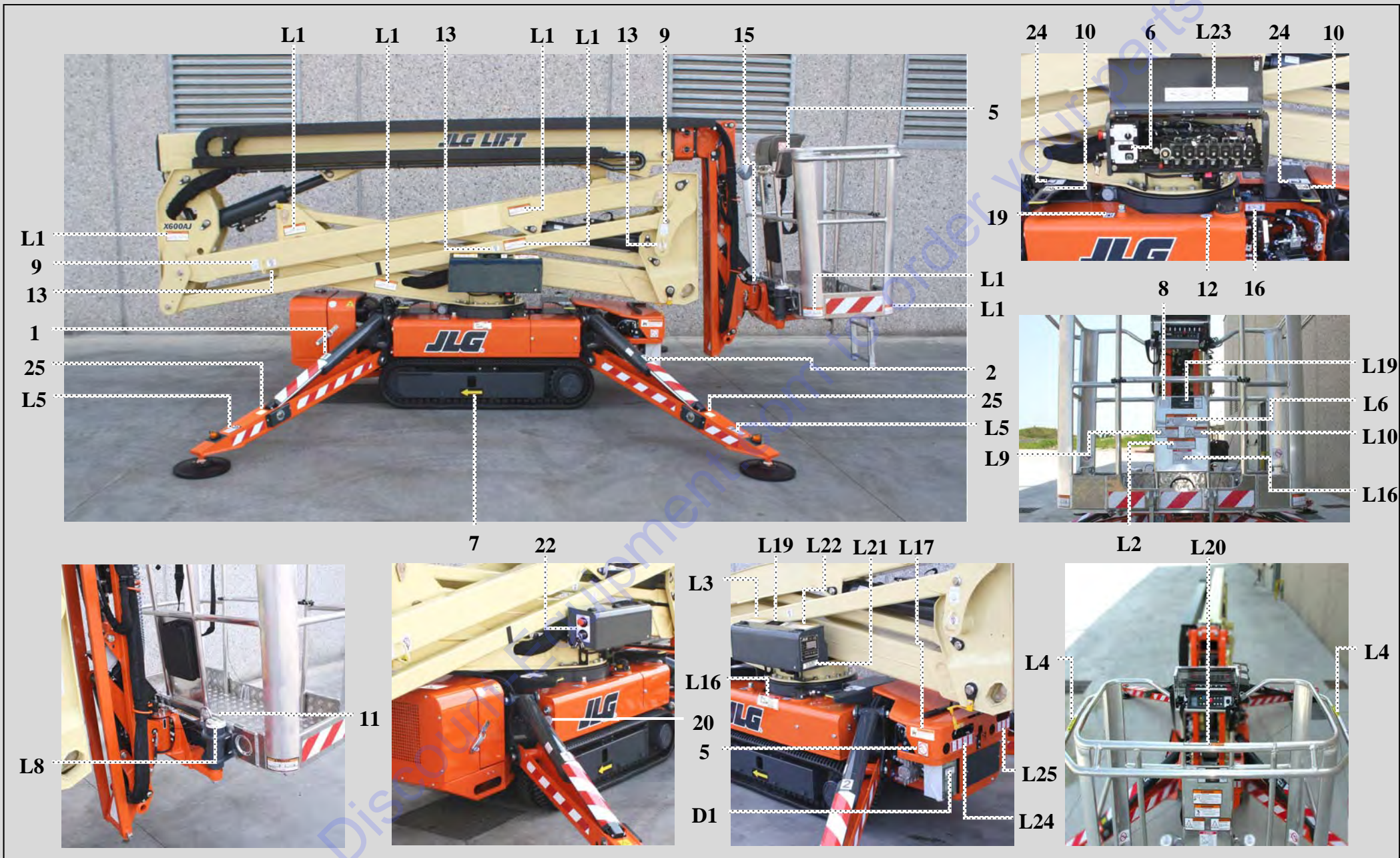

KIT ADESIVI - X600AJ - MK2	AUFKLEBERSATZ - X600AJ - MK2	<b>Cod. 17777000</b>
SET OF DECALS - X600AJ - MK2	KIT ADHESIVOS - X600AJ - MK2	
KIT COLLANTS - X600AJ - MK2	ADHESIEKIT - X600AJ - MK2	<b>Tav 01</b>

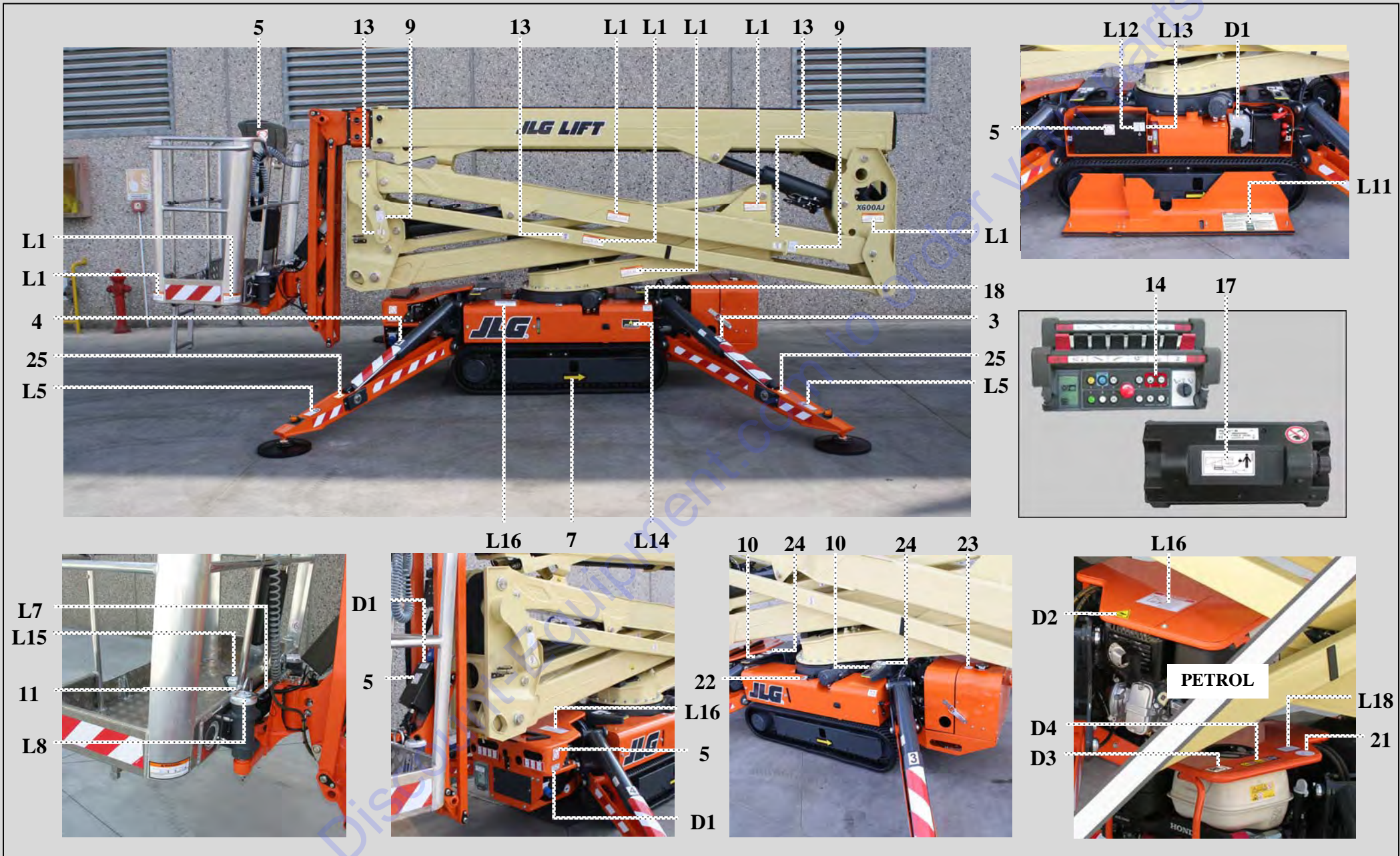

KIT ADESIVI - X600AJ - MK2	AUFKLEBERSATZ - X600AJ - MK2	<b>Cod. 17777000</b>
SET OF DECALS - X600AJ - MK2	KIT ADHESIVOS - X600AJ - MK2	
KIT COLLANTS - X600AJ - MK2	ADHESIEKIT - X600AJ - MK2	<b>Tav 02</b>

**Cod. 17777000**

**POSIZIONE ADESIVI SICUREZZA PIATTAFORMA PER /**  
*AERIAL PLATFORM KIT POSITION STICKERS SAFETY*

**JLG / ANSI - X600AJ - MK2**

Go to [Discount-Equipment.com](http://Discount-Equipment.com) to order your parts

## 17777000 POSIZIONE ADESIVI / POSITION STICKERS

JLG

POSIZIONE	CODICE	REV.	DESCRIZIONE	QUANTITA'
01	06555500	A	ADESIVO NR 1 L=50X60 BIANCO	01
02	06555600	A	ADESIVO NR 2 L=50X60 BIANCO	01
03	06555700	A	ADESIVO N° 3 L=50X60 BIANCO	01
04	06555800	A	ADESIVO N° 4 L=50X60 BIANCO	01
05	1001125483	A	ADESIVO JLG VIETATO LAVARE L=63,5X63,5 MM	06
06	07668300	A	ADESIVO SELETTORE SCATOLA COMANDI TERRA / CESTO L=105X155 MM	01
07	06040500	A	ADESIVO DIREZ. TRASLAZIONE FRECCIA GIALLA SFONDO NERO L=61 X 160	02
08	1701640	A	ADESIVO JLG LEGGERE IL MANUALE L= 69,85x69,85 MM	01
09	1703814	A	ADESIVO JLG ATTACCO ANCORAGGIO L=55,56X76,2 MM	04
10	07071200	A	ADESIVO JLG PUNTO DI SOLLEVAMENTO L= 40X66 MM	04
11	1704277	A	ADESIVO JLG ATTACCO CINTURE DI SICUREZZA L= 76,2X19,05 MM	02
12	06164700	A	ADESIVO FILTRO OILO IDRAULICO Ø SFONDO BIANCO	01
13	07056700	A	ADESIVO JLG DIVIETO DI SOLLEVAMENTO L=40X54,88	06
14	07071000	B	ADESIVO JLG CLAXON SU PIATTAFORME L=38,3X28,55	01
15	06706500	A	ADESIVO ALLINEAMENTO CESTO (2 PEZZI) L=16X50+13	01
16	06998800	A	ADESIVO DEVIATORE POMPA MANUALE PIATTAFORMA GL17.80XL L=86X34	01
17	07240300	B	ADESIVO DISTANZA 1m SU TELE/RADIO COMANDI	01
18	1702155	A	ADESIVO JLG STACCABATTERIA L= 63,5X50,80 MM	01
19	1701504	A	ADESIVO JLG OLIO IDRAULICO L=50,8x63,5 MM	01
20	06165000	A	ADESIVO LIVELLO OLIO IDRAULICO Ø50 SFONDO BIANCO	01
21	06060000	A	ADESIVO LIVELLO OLIO MOTORE Ø50mm	01
22	07668200	A	ADESIVO EMERGENCY STOP E BLOCCHETTO ACCENSIONE L=85x160 MM	01
23	06214200	A	ADESIVO LIQUIDO REFRIGERANTE SFONDO BIANCO Ø 50 MM (**)	01
24	07350300	A	ADESIVO SOLLEVAMENTO PIATTAFORMA CON MULETTO L=90X70 MM	04

**17777000 POSIZIONE ADESIVI / POSITION STICKERS****JLG**

POSIZIONE	CODICE	REV.	DESCRIZIONE	QUANTITA'
25	07526800	A	ADESIVO REAZIONE AL SUOLO STABILIZZATORI X600AJ L= 50X50 - BIANCO	04
26				
27				
28				
29				
30				
31				
32				
33				
34				
35				
36				
37				
38				
39				
40				
41				
42				
43				
44				
45				
46				
47				
48				
49				

**17777000 POSIZIONE ADESIVI / POSITION STICKERS**

**JLG**

POS.	COD.	REV.	ADESIVI IN DISTINTA MACCHINA / STICKERS IN LIST MACHINE	Q.tà
D1	07056400	B	ADESIVO JLG PERICOLO 120V - 60HZ - ING L= 75x32,68 MM __ MOD_B	04
	07056300	A	ADESIVO JLG PERICOLO 220V - 50/60HZ L= 75X18,75 MM	04
D2	06056300	A	ADESIVO PERICOLO SCOTTATURE TRIANGOLARE SFONDO GIALLO L=60X51 MM	01
D3	06041600	A	ADESIVO CARBURANTE BENZINA COLORE VERDE L=60 X 80 MM __ MOD_B	01
	1701505	A	ADESIVO JLG CARBURANTE DIESEL L= 50,8X63,5	01
D4	06232100	B	ADESIVO ATTENZIONE BENZINA INFIAMMABILE L=170X42 MM __ MOD_B	01
D5				
D6				
D7				
D8				
D9				
D10				
D11				
D12				
D13				
D14				
D15				
D16				
D17				
D18				
D19				
D20				
D21				
D22				

**POSIZIONE ADESIVI IN LINGUA PER /**  
*POSITION OF STICKERS FOR SAFETY*

**JLG/ANSI - X600AJ - MK2**

**Codici / codes**

**177770GB - 177770FR - 177770ES - 177770PT**

**177770\*\* ADESIVI IN LINGUA / ADHESIVES IN LANGUAGE**

**JLG**

POSIZIONE	CODICE	REV.	DESCRIZIONE	QUANTITA'
	177770GB		KIT ADESIVI SICUREZZA PIATTAFORMA AEREA X600AJ JLG / ANSI LINGUA INGLESE	
L1	07056100	A	ADESIVO JLG PERICOLO SCHIACCIAMENTO L= 140x60,71 MM	14
L2	1706387	A	ADESIVO JLG PERICOLO SCHIACCIAMENTO L=177,80x69,85 MM ( SUL CESTO )	01
L3	1706099	A	ADESIVO JLG PERICOLO SCHIACCIAMENTO L= 161,92X69,85 MM ( A TERRA )	01
L4	1702868	B	ADESIVO JLG PERICOLO SCHIACCIAMENTO MANO L= 241,30X25.40 MM ( SUL CESTO )	02
L5	07056200	A	ADESIVO JLG ATTACCO SCHIACCIAMENTO ARTO INFERIORE L= 110x60 (PRES. STABILIZZATORI )	04
L6	1706386	A	ADESIVO JLG PERICOLO CADUTE L=196,85x76,2 MM	01
L7	07051100	B	ADESIVO JLG PERICOLO CADUTA - RIPRISTINARE I TAPPI L=196,5x35 MM	01
L8	07051000	A	ADESIVO JLG PERICOLO DI CADUTA - SBLOCCARE SOLO NEI CASI PREVISTI L= 50X50 MM	02
L9	1706133	C	ADESIVO JLG PERICOLO RIBALTAMENTO L=139,7X68,85 MM	01
L10	07058600	A	ADESIVO JLG POSIZIONE STABILIZZATORI X390, X550	01
L11	075039GB	A	ADESIVO JLG DISCESA DI EMERGENZA X600AJ MOTORE TERMICO E LITHIUM - ING L=290X205 MM	01
L12	07042100	A	ADESIVO JLG SISTEMA BYPASS PARTE AEREA L=30X50	01
L13	07042200	A	ADESIVO JLG SISTEMA BYPASS TRASLAZIONE L= 30X50	01
L14	1702901	A	ADESIVO JLG ISTRUZIONI DISCESA EMERGENZA / POMPA MAUALE L=114,3x58,73MM	01
L15	3252347	B	ADESIVO JLG ATTENZIONE PEDALE L= 69,85x57,15 MM	01
L16	1706128	E	ADESIVO JLG PERICOLO DI FOLGORAZIONE L=120,65x91,50 MM	05
L17	1703813	A	ADESIVO JLG PERICOLO ESLOSIONE BATTERIE L=149,25X47,62 MM	01
L18	1704972	C	ADESIVO JLG PERICOLO ESPLOSIONE L=63,5x92,07 MM	01
L19	072423GB	A	ADESIVO JLG ANSI CARICO MAX IN CESTA X500AJ	02
L20	1706385	C	ADESIVO JLG SCORRIMENTO SBARRA CHIUSURA CESTO L=184,15X25,4 MM	01
L21	1705514	A	ADESIVO JLG CONFORMITA' CSA L= 76,20x22,22 MM	01
L22	1706135	B	ADESIVO JLG USO PIATTAFORMA (GB) L=139,70x88,90 MM_ _ MOD_B	01
L23	076787GB	A	ADESIVO JLG ANSI PULSANTI DISTRIBUTORE PARTE AEREA X770AJ L=318X52 MM - ING	01
L24	072425GB	A	ADESIVO JLG ANSI PULSANTI DISTRIB A TERRA X500AJ LATO SX	01



**177770\*\* ADESIVI IN LINGUA / ADHESIVES IN LANGUAGE**

**JLG**

POSIZIONE	CODICE	REV.	DESCRIZIONE	QUANTITA'
L25	072426GB	A	ADESIVO JLG ANSI PULSANTI DISTR. A TERRA LATO DX X500AJ	01
L26				
L27				
L28				
L29				
L30				
	177770FR			
	177770ES			
	177770PT			

Go to Discount-Equipment.com to order your parts

# TABELLA PERNI/SPINE (PINS TABLE)

LOCKING SYSTEM  
GHIERA  
(LOCKNUTS CODE)  
REF. TABLE BELOW

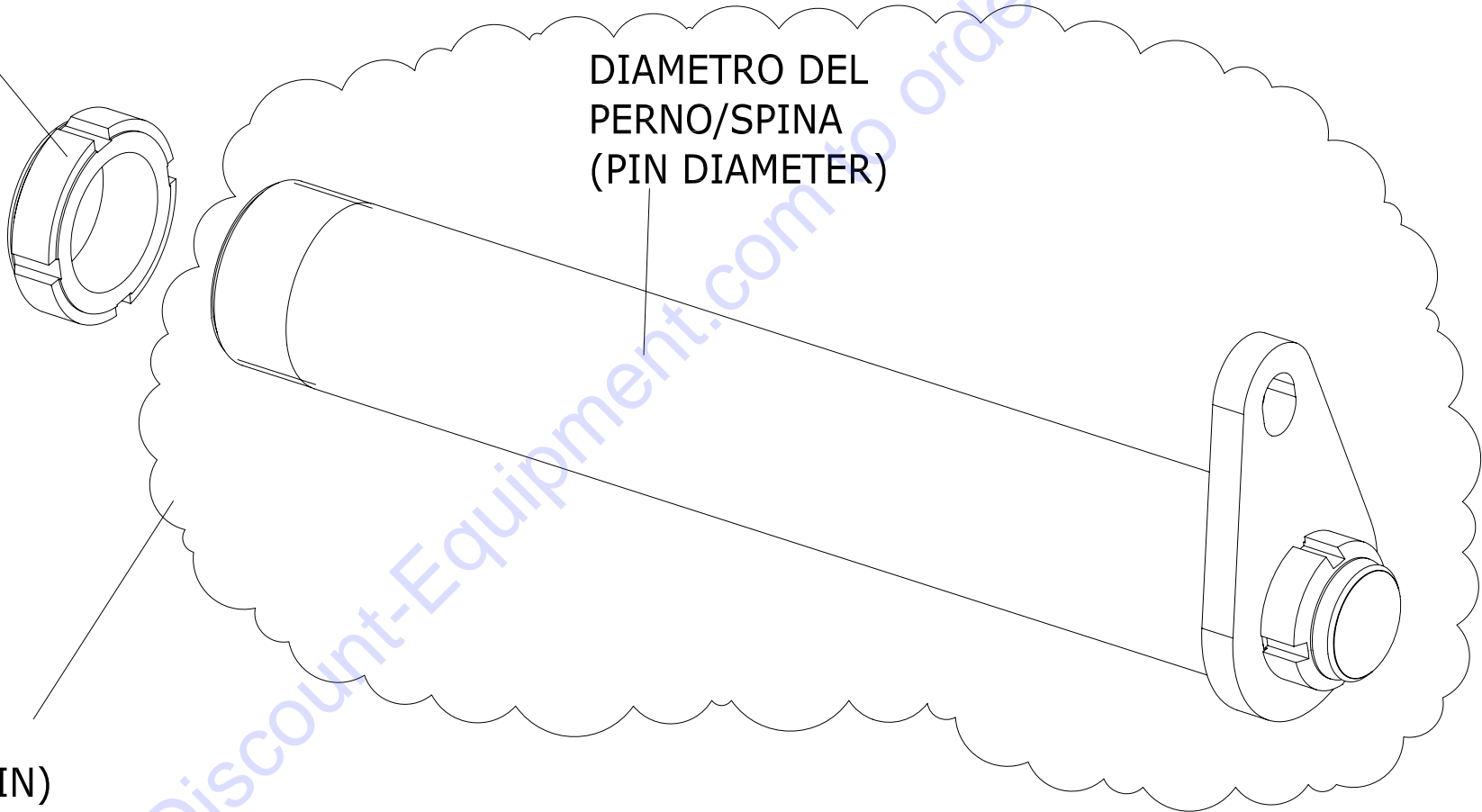

PERNO/SPINA (PIN)

IL CODICE DEL PERNO A RICAMBIO COMPRENDE LA GOCCIA MONTATA E LA GHIERA DI FISSAGGIO DELLA GOCCIA

THE CODE OF A PIN INCLUDES DROP PARTS MOUNTED AND THE LOCK NUT TO FIXING THE DROP, ALL THESE PARTS ARE SHIPPED ALREADY MOUNTED TOGETHER

<b>DIAMETRO DEL PERNO/SPINA mm SISTEMA METRICO (PIN DIAMETER mm METRIC)</b>	<b>GHIERA (LOCKNUTS CODE)</b>	<b>DADO (NUTS CODE)</b>
25	BG4	
30	BG5	
35	BG3	
40	BG2	
45	BG7	
50	BG8	
20 (DIAMETER OF THREADED PART M17 PITCH=1)	BG1	
20 (DIAMETER OF THREADED PART M20 PITCH=1)	BG6	
20 (DIAMETER OF THREADED PART M20 PITCH=1,5)	BG12	

Go to Discount-Equipment.com to Order your parts

POS	Codice	U.M.	 Descrizione	 Description
BC1	BC000100	NR	COPPIGLIA 4X40	COTTER PIN 4x40
BC2	BC000200	NR	COPPIGLIA 5X40	COTTER PIN 5x40
BC3	BC000300	NR	SEEGER ESTERNO Ø20	SEEGER EXTERNAL Ø20
BC4	BC000400	NR	SEEGER ESTERNO Ø8	SEEGER EXTERNAL Ø8
BC5	BC000500	NR	SEEGER ESTERNO Ø25	SEEGER EXTERNAL Ø25
BC6	BC000600	NR	COPPIGLIA 1,8X8	COTTER PIN 1,8X8
BC7	BC000700	NR	COPPIGLIA 4X55	COTTER PIN 4x55
BD1	BD000100	NR	Dado Esagonale Flangiato Liscio PG DIN 6923 CI 8 M 14 Z.Bianca	Hex Flange Nut DIN 6923 CI Smooth PG 8 M 14 Z. white
BD2	BD000200	NR	Dado Esagonale Basso PG DIN 936 CI 04 M 8 Z.Bianca	Low Hex nut DIN 936 PG 04 M CI 8 Z. white
BD3	BD000300	NR	Dado Esagonale Alto PG UNI 5587 CI 8 M 8 Z.Bianca	Hex Nut High PG UNI 5587 CI 8 M 8 Z. white
BD4	BD000400	NR	Dado Alto Autobloccante PG DIN 982 CI 8 M 12 Z.Bianca	High Self Locking Nut DIN 982 PG 12 CI 8 M Z. white
BD5	BD000500	NR	Dado Alto Autobloccante PG DIN 982 CI 8 M 8 Z.Bianca	High Self Locking Nut DIN 982 PG CI 8 M 8 Z. white
BD6	BD000600	NR	Dado Esagonale Alto PG UNI 5587 CI 8 M 4 Z.Bianca	Hex Nut High PG UNI 5587 M 4 CI 8 Z. white
BD7	BD000700	NR	Dado Esagonale Basso PG DIN 936 CI 04 M 6 Z.Bianca	Low Hex nut DIN 936 PG 6 CI 04 M Z. white
BD8	BD000800	NR	Dado Basso Autobloccante PG DIN 985 CI 8 M 6 Z.Bianca	Low Self-locking nut DIN 985 PG 6 CI 8 M Z. white
BD9	BD000900	NR	Dado Alto Autobloccante PG DIN 982 CI 8 M 6 Z.Bianca	High Self Locking Nut DIN 982 PG CI 8 M6 Z. white
BD10	BD001000	NR	Dado Basso Autobloccante PG DIN 985 CI 8 M 5 Z.Bianca	Low Self-locking nut DIN 985 PG CI 8 M5 Z. white
BD11	BD001100	NR	Dado Alto Autobloccante PG DIN 982 CI 8 M 5 Z.Bianca	High Self Locking Nut DIN 982 PG CI 8 M5 Z. white

POS	Codice	U.M.	 Descrizione	 Description
BD12	BD001200	NR	Dado Alto Autobloccante PG DIN 982 CI 8 M 4 Z.Bianca	High Self Locking Nut DIN 982 PG CI 8 M4 Z. white
BD13	BD001300	NR	Dado Alto Autobloccante PG DIN 982 CI 8 M 3 Z.Bianca	High Self Locking Nut DIN 982 PG CI 8 M3 Z. white
BD14	BD001400	NR	Dado Alto Autobloccante PF DIN 982 CI 8 M 20 x 1,5 Z.Bianca	High Self Locking Nut DIN 982 PF CI 8 M 20 x 1.5 Z white
BD15	BD001500	NR	Dado Alto Autobloccante PG DIN 982 CI 8 M 10 Z.Bianca	High Self Locking Nut DIN 982 PG CI 8 M10 Z. white
BD16	BD001600	NR	Dado Esagonale Alto PG UNI 5587 CI 8 M 3 Z.Bianca	Hex Nut High PG UNI 5587 CI 8 M3 Z. white
BD17	BD001700	NR	Dado Basso Autobloccante PG DIN 985 CI 8 M 8 Z.Bianca	Low Self-locking nut DIN 985 PG CI 8 M8 Z. white
BD18	BD001800	NR	Dado Alto Autobloccante PG DIN 982 CI 8 M 16 Z.Bianca	High Self Locking Nut DIN 982 PG CI 8 M16 Z. white
BD19	BD001900	NR	Dado Alto Autobloccante PF DIN 982 CI 8 M 20 x 1,5 Z.Bianca H=20 ribassato	High Self Locking Nut DIN 982 PF CI 8 M 20 x 1.5 Z White H = 20 low
BD22	BD002200	NR	Dado Alto Autobloccante PG DIN 982 CI 8 M 14 Z.Bianca	Hex Flange Nut DIN 982 CI 8 M 14 Z. white
BD23	BD002300	NR	Dado Basso Autobloccante PG DIN 985 CI 8 M 10 Z.Bianca	Low Self-locking nut DIN 985 PG CI 8 M 10 Z. white
BD24	BD002400	NR	Dado Alto Autobloccante PG DIN 982 CI 8 M 24 Z.Bianca	High Self Locking Nut DIN 982 PG CI 8 M24 Z. white
BD25	BD002500	NR	Dado Esagonale Alto PG UNI 5587 CI 8 M 6 Z.Bianca	Hex Nut High PG UNI 5587 M 6 CI 8 Z. white
BD26	BD002600	NR	Dado Esagonale Alto PG UNI 5587 CI 8 M 10 Z.Bianca	Hex Nut High PG UNI 5587 M 10 CI 8 Z. white
BD27	BD002700	NR	Dado Alto Autobloccante PG DIN 982 CI 8 M 18 Z.Bianca	High Self Locking Nut DIN 982 PG CI 8 M18 Z. white
BD28	BD002800	NR	Dado Basso Autobloccante PG DIN 985 CI 8 M 16 Z.Bianca	Low Self-locking nut DIN 985 PG CI 8 M 16 Z. white
BD29	BD002900	NR	Dado Esagonale Alto PG UNI 5587 CI 8 M 5 Z.Bianca	Hex Nut High PG UNI 5587 M 5 CI 8 Z. white
BD30	BD003000	NR	Dado Esagonale Alto PG UNI 5587 CI 12 M 5 Z.Bianca	Hex Nut High PG UNI 5587 M 5 CI 12 Z. white

POS	Codice	U.M.	 Descrizione	 Description
BD31	BD003100	NR	Dado Esagonale Alto PG UNI 5587 CI 16 M 5 Z.Bianca	Hex Nut High PG UNI 5587 M 5 CI 16 Z. white
BD32	BD003200	NR	Dado Alto Autobloccante PG DIN 982 CI 8 M 20 Z.Bianca	High Self Locking Nut DIN 982 PG CI 8 M20 Z. white
BD33	BD003300	NR	Dado Basso Autobloccante PG DIN 985 CI 8 M 12 Z.Bianca	Low Self-locking nut DIN 985 PG CI 8 M 12 Z. white
BG1	BG000100	NR	Ghiera autobloccante GN CI 6 GN 3 D. 17 x 1 Z.Bianca	Self-locking nut GN GN 3 CI 6 D. 17 x 1 Z. white
BG2	BG000200	NR	Ghiera autobloccante pesante CI 6 GUP 40 x 1,5 Z.Bianca	Self-locking nut heavy CI 6 GUP 40 x 1.5 Z white
BG3	BG000300	NR	Ghiera autobloccante pesante CI 6 GUP 35 x 1,5 Z.Bianca	Self-locking nut heavy CI 6 GUP 35 x 1.5 Z white
BG4	BG000400	NR	Ghiera autobloccante pesante CI 6 GUP 25 x 1,5 Z.Bianca	Self-locking nut heavy CI 6 GUP 25 x 1.5 Z white
BG5	BG000500	NR	Ghiera autobloccante pesante CI 6 GUP 30 x 1,5 Z.Bianca	Self-locking nut heavy CI 6 GUP 30 x 1.5 Z white
BG6	BG000600	NR	Ghiera autobloccante pesante CI 6 GUP 20 x 1 Z.Bianca	Self-locking nut heavy CI 6 GUP 20 x 1 Z. white
BG7	BG000700	NR	Ghiera autobloccante GN CI 6 GN 3 D. 45 x 1,5 Z.Bianca	NUT
BG8	BG000800	NR	Ghiera autobloccante GN CI 6 GN 3 D. 50 x 1,5 Z.Bianca	NUT
BG9	BG000900	NR	Ghiera autobloccante GN CI 6 GN 3 D. 20 x 1,5 Z.Bianca	NUT
BG10	BG001000	NR	Ghiera autobloccante ribassata CI 6 GUK 25 x 1,5 Z.Bianca	Self-locking nut lowered CI 6 GUK 25 x 1.5 Z.Bianca
BG11	BG001100	NR	Ghiera autobloccante ribassata CI 6 GUK 20 x 1 Z.Bianca	Self-locking nut lowered CI 6 GUK 20 x 1 Z.Bianca
BG12	BG001200	NR	Ghiera autobloccante ribassata CI 6 GUA 20 x 1.5 Z.Bianca	Self-locking nut lowered CI 6 GUA 20 x 1.5 Z.Bianca
BG13	BG001300	NR	Ghiera autobloccante ribassata CI 6 GUK 30 x 1.5 Z.Bianca	Self-locking nut lowered CI 6 GUK 30 x 1.5 Z.Bianca
BG14	BG001400	NR	Ghiera autobloccante ribassata CI 6 GUK 45 x 1.5 Z.Bianca	Self-locking nut lowered CI 6 GUK 45 x 1.5 Z.Bianca
BG15	BG001500	NR	Ghiera autobloccante ribassata CI 6 GUK 50 x 1.5 Z.Bianca	Self-locking nut lowered CI 6 GUK 50 x 1.5 Z.Bianca

POS	Codice	U.M.	 Descrizione	 Description
BG16	BG001600	NR	Ghiera autobloccante ribassata CI 6 GUK 55 x 1.5 Z.Bianca	Self-locking nut lowered CI 6 GUK 55 x 1.5 Z.Bianca
BI1	BI000100	NR	INSERTO ESAGONALE M6	INSERT HEX M6
BI2	BI000200	NR	INSERTO ESAGONALE M5	INSERT HEX M5
BI3	BI000300	NR	INSERTO CILINDRICO M4	INSERT M4
BI4	BI000400	NR	INSERTO CILINDRICO M6	INSERT M6
BR1	BR000100	NR	Grower sez.rett.spigoli vivi pesante UNI 9195 Acc.Molle D 6 Z.D.Bianca	Grower sez.rett. sharp heavy UNI 9195 Acc.Molle D 6 Z.D. white
BR2	BR000200	NR	Rondella Piana DIN 125-A HV100 D 4 Z.Bianca	Plain washer DIN 125-A HV100 D 4 Z. white
BR3	BR000300	NR	Rondella Piana DIN 125-A HV100 D 5 Z.Bianca	Plain washer DIN 125-A HV100 D 5 Z. white
BR4	BR000400	NR	Rondella Piana DIN 125-A HV100 D 6 Z.Bianca	Plain washer DIN 125-A HV100 D 6 Z. white
BR5	BR000500	NR	Rondella Piana DIN 125-A HV100 D 8 Z.Bianca	Plain washer DIN 125-A HV100 D 8 Z. white
BR6	BR000600	NR	Rondella Piana DIN 125-A HV100 D 10 Z.Bianca	Plain washer DIN 125-A HV100 D 10 Z. white
BR7	BR000700	NR	Rondella Piana DIN 125-A HV100 D 12 Z.Bianca	Plain washer DIN 125-A HV100 D 12 Z. white
BR8	BR000800	NR	Rosetta piana fascia larga e=3d DIN 9021 HV100 D 10 x 30 x 2,5 Z.Bianca	Wide band and flat washer DIN 9021 HV100 3d = D 10 x 30 x 2.5 Z white
BR9	BR000900	NR	Rosetta piana fascia larga e=3d DIN 9021 HV100 D 12 x 36 x 2,5 Z.Bianca	Wide band and flat washer DIN 9021 HV100 3d = D 12 x 36 x 2.5 Z white
BR10	BR001000	NR	Rondella x Carpenteria DIN 6916 HV 300 D 16 Z.Bianca	Carpentry washer DIN 6916 HV 300 D 16 Z white
BR11	BR001100	NR	Rosette speciali HV100 D 25 x 51 x 1 Z.Bianca	Special washers HV100 D 25 x 51 x 1 Z. white
BR13	BR001300	NR	Rondella dentellatura esterna DIN 6798-A Acc.Molle D 3 Z.D.Bianca	Washer external serration DIN 6798-A Acc.Molle D 3 ZD white

POS	Codice	U.M.	 Descrizione	 Description
BR14	BR001400	NR	Rosetta piana fascia larga e=3d DIN 9021 HV100 D 5 x 15 x 1,2 Z.Bianca	Wide band and flat washer DIN 9021 HV100 3d = D 5 x 15 x 1.2 Z whit
BR15	BR001500	NR	Rosetta piana fascia larga e=3d DIN 9021 HV100 D 6 x 18 x 1,5 Z.Bianca	Wide band and flat washer DIN 9021 HV100 3d = D 6 x 18 x 1.5 Z white
BR16	BR001600	NR	Rosetta piana fascia larga e=3d DIN 9021 HV100 D 8 x 24 x 2 Z.Bianca	Wide band and flat washer DIN 9021 HV100 3d = D 8 x 24 x 2 Z. white
BR17	BR001700	NR	Rosetta piana fascia larga e=3d DIN 9021 HV100 D 4 x 12 x 1 Z.Bianca	Wide band and flat washer DIN 9021 HV100 D = 3d 4 x 12 x 1 Z. white
BR18	BR001800	NR	Rondella Piana DIN 125-A NYLON D 4	Plain washer DIN 125-A NYLON D 4
BR19	BR001900	NR	Rondella Piana DIN 125-A HV100 D 3 Z.Bianca	Plain washer DIN 125-A HV100 D 3 Z. white
BR20	BR002000	NR	Rondella Piana DIN 125-A HV100 D 16 Z.Bianca	Plain washer DIN 125-A HV100 D 16 Z. white
BR21	BR002100	NR	Rosetta piana fascia larga e=3d DIN 9021 HV100 D 16 x 48 x 4 Z.Bianca	Wide band and flat washer DIN 9021 HV100 3d = D 16 x 48 x 4 Z. white
BR22	BR002200	NR	Grower sez.rett.spigoli vivi pesante UNI 9195 Acc.Molle D 8 Z.D.Bianca	Grower section. rect. sharp heavy UNI 9195 Stainless Springs D 8 Z.D. white
BR23	BR002300	NR	Rosetta piana fascia larga e=3d DIN 9021 HV100 D 3 x 12 x 1 Z.Bianca	Wide band and flat washer DIN 9021 HV100 D = 3d 3 x 12 x 1 Z. white
BR24	BR002400	NR	Rosetta piana fascia larga e=3d DIN 9021 HV100 D 14 x 42 x 3 Z.Bianca	Wide band and flat washer DIN 9021 HV100 D = 3d 14 x 42 x 3 Z. white
BR25	BR002500	NR	Grower sez.rett.spigoli vivi pesante UNI 9195 Acc.Molle D 10 Z.D.Bianca	Grower sez.rett. sharp heavy UNI 9195 Acc.Molle D 10 Z.D. white
BR26	BR002600	NR	Rondella Piana DIN 125-A D 30 Z.Bianca	Plain washer DIN 125-A D 30 Z. white
BR27	BR002700	NR	Rondella Piana DIN 125-A HV100 D 14 Z.Bianca	Plain washer DIN 125-A HV100 D 14 Z. white
BR28	BR002800	NR	Rosetta piana fascia larga D 6 x 24 x 2 Z.Bianca	Wide band and flat washer D 6 x 24 x 2 Z white
BR29	BR002900	NR	Rondella Piana DIN 125-A HV100 D 18 Z.Bianca	Plain washer DIN 125-A HV100 D 18 Z. white



POS	Codice	U.M.	 Descrizione	 Description
BR30	BR003000	NR	Rondella Piana DIN 125-A HV100 D 20 Z.Bianca	Plain washer DIN 125-A HV100 D 20 Z. white
BR31	BR003100	NR	Grower sez.rett.spigoli vivi pesante UNI 9195 Acc.Molle D 12 Z.D.Bianca	Grower sez.rett. sharp heavy UNI 9195 Acc.Molle D 12 Z.D. white
BR32	BR003200	NR	Rosette speciali HV100 D 30 x 42 x 0.5 Z.Bianca	Special washers HV100 D 30 x 42 x 0.5 Z. white
BR33	BR003300	NR	Rosette speciali HV100 D 30 x 61 x 1 Z.Bianca	Special washers HV100 D 30 x 61 x 1 Z. white
BR34	BR003400	NR	Rosette speciali HV100 D 42 x 52 x 0.2 Z.Bianca	Special washers HV100 D 42 x 52 x 0.2 Z. white
BR35	BR003500	NR	Rosette speciali HV100 D 42 x 52 x 0.3 Z.Bianca	Special washers HV100 D 42 x 52 x 0.3 Z. white
BR36	BR003600	NR	Rosette speciali HV100 D 42 x 52 x 1 Z.Bianca	Special washers HV100 D 42 x 52 x 1 Z. white
BR37	BR003700	NR	Rosette speciali HV100 D 42 x 52 x 1.5 Z.Bianca	Special washers HV100 D 42 x 52 x 1.5 Z. white
BR38	BR003800	NR	Rosette speciali HV100 D 42 x 52 x 2 Z.Bianca	Special washers HV100 D 42 x 52 x 2 Z. white
BR39	BR003900	NR	Rosetta piana fascia larga e=3d DIN 9021 HV100 D 18 x 48 x 4 Z.Bianca	Wide band and flat washer DIN 9021 HV100 3d = D 18 x 48 x 4 Z. white
BR40	BR004000	NR	Rosetta SCHNORR zincate D 6	WASHER
BR41	BR004100	NR	Grower sez.rett.spigoli vivi pesante UNI 9195 Acc.Molle D 14 Z.D.Bianca	Grower sez.rett. sharp heavy UNI 9195 Acc.Molle D 14 Z.D. white
BR42	BR004200	NR	Rondella x Carpenteria DIN 6916 HV 300 D 14 Z.Bianca	Carpentry washer DIN 6916 HV 300 D 14 Z white
BR43	BR004300	NR	Rondella x Carpenteria DIN 125-A HV 300 D 10 Z.Bianca	Carpentry washer DIN 125-A HV 300 D 10 Z white
BS1	BS000100	NR	GRANO FILETTATO M6X12	SCREW
BS2	BS000200	NR	SPINA CIL. 8x16 UNI 6364-A h6 CMT + TMP	PIN CYLINDER 8 x 16 UNI 6364-A CMT h6 + TMP
BS3	BS000300	NR	PRIGIONIERO M10X35	PIN

POS	Codice	U.M.	 Descrizione	 Description
BS4	BS000400	NR	SPINA ELASTICA 6X60 UNI 6873	PIN
BS5	BS000500	NR	SPINA ELASTICA 6X14 UNI 6873	PIN
BS6	BS000600	NR	Spina Spirol Normale DIN 7343 INOX A2 D 5x10	PIN
BS7	BS000700	NR	Rivetto alluminio Ø3x12	Aluminum rivet Ø3x12
BV1	BV000100	NR	Vite TE Parziale Filetto PG DIN 931 CI 8.8 M 8 x 80 Z.Bianca	Screw Partial Thread DIN 931 PG CI 8.8 M 8 x 80 Z. white
BV2	BV000200	NR	Vite TE Tutto Filetto PG DIN 933 CI 8.8 M 8 x 60 Z.Bianca	Screw All Thread DIN 933 PG CI 8.8 M 8 x 60 Z. white
BV3	BV000300	NR	Vite TCEI PG DIN 912 CI 8.8 M 8 x 60 Z.Bianca	Screw DIN 912 PG CI 8.8 M8 x 60 Z. white
BV4	BV000400	NR	Vite TE Parziale Filetto PG DIN 931 CI 8.8 M 8 x 50 Z.Bianca	Screw Partial Thread DIN 931 PG CI 8.8 M 8 x 50 Z. white
BV5	BV000500	NR	Vite TCEI PG DIN 912 CI 8.8 M 8 x 45 Z.Bianca	Screw DIN 912 PG CI 8.8 M8 x 45 Z. white
BV6	BV000600	NR	Vite TCEI PG DIN 912 CI 8.8 M 8 x 40 Z.Bianca	Screw DIN 912 PG CI 8.8 M8 x 40 Z.Bianca
BV7	BV000700	NR	Vite TE Tutto Filetto PG DIN 933 CI 8.8 M 8 x 35 Z.Bianca	Screw All Thread DIN 933 PG CI 8.8 M 8 x 35 Z. white
BV8	BV000800	NR	Vite TE Tutto Filetto PG DIN 933 CI 8.8 M 8 x 30 Z.Bianca	Screw All Thread DIN 933 PG CI 8.8 M 8 x 30 Z. white
BV9	BV000900	NR	Vite TE Tutto Filetto PG DIN 933 CI 8.8 M 8 x 25 Z.Bianca	Screw All Thread DIN 933 PG CI 8.8 M 8 x 25 Z. white
BV10	BV001000	NR	Vite TCEI PG DIN 912 CI 8.8 M 8 x 25 Z.Bianca	Screw DIN 912 PG CI 8.8 M8 x 25 Z. white
BV11	BV001100	NR	Vite TE Tutto Filetto PG DIN 933 CI 8.8 M 8 x 20 Z.Bianca	Screw All Thread DIN 933 PG CI 8.8 M 8 x 20 Z. white
BV12	BV001200	NR	Vite TE Tutto Filetto PG DIN 933 CI 8.8 M 8 x 16 Z.Bianca	Screw All Thread DIN 933 PG CI 8.8 M 8 x 16 Z. white
BV13	BV001300	NR	Vite TCEI PG DIN 912 CI 8.8 M 8 x 16 Z.Bianca	Screw DIN 912 PG CI 8.8 M8 x 16 Z. white
BV14	BV001400	NR	Vite TE Tutto Filetto PG DIN 933 CI 8.8 M 8 x 14 Z.Bianca	Screw All Thread DIN 933 PG CI 8.8 M 8 x 14 Z. white

POS	Codice	U.M.	 Descrizione	 Description
BV15	BV001500	NR	Vite TCEI PG DIN 912 CI 8.8 M 6 x 45 Z.Bianca	Screw DIN 912 M6 x 45 CI 8.8 Z. white
BV16	BV001600	NR	Vite TCEI PG DIN 912 CI 8.8 M 6 x 30 Z.Bianca	Screw DIN 912 M6 x 30 CI 8.8 Z. white
BV17	BV001700	NR	Vite TSPEI PG DIN 7991 CI 10.9 M 6 x 30 Z.Bianca	screw DIN 7991 CI 10.9 M 6 x 30 Z. white
BV18	BV001800	NR	Vite TE Tutto Filetto PG DIN 933 CI 8.8 M 6 x 30 Z.Bianca	Screw All Thread DIN 933 PG CI 8.8 M 6 x 30 Z. white
BV19	BV001900	NR	Vite TBEI PG ISO 7380 CI 10.9 M 6 x 30 Z.Bianca	screw ISO 7380 CI 10.9 M 6 x 30 Z. white
BV20	BV002000	NR	Vite TE Tutto Filetto PG DIN 933 CI 8.8 M 6 x 12 Z.Bianca	Screw All Thread DIN 933 PG CI 8.8 M 6 x 12 Z. white
BV21	BV002100	NR	Vite TCEI PG DIN 912 CI 8.8 M 6 x 12 Z.Bianca	Screw DIN 912 PG CI 8.8 M 6 x 12 Z. white
BV22	BV002200	NR	Vite TCEI PG DIN 912 CI 8.8 M 5 x 45 Z.Bianca	Screw DIN 912 PG CI 8.8 M 5 x 45 Z. white
BV23	BV002300	NR	Vite TE UNF ANSI B18.2.1 GR.5 5/16 x 1" Z.Bianca	Screw UNF ANSI B18.2.1 GR.5 5/16 x 1 "Z. White
BV24	BV002400	NR	Vite TC Croce PG DIN 7985 CI 4.8 M 4 x 8 Z.Bianca	Cross head screw DIN 7985 PG CI 4.8 M 4 x 8 Z. white
BV25	BV002500	NR	Vite TCEI PG DIN 912 CI 8.8 M 4 x 16 Z.Bianca	Screw DIN 912 PG CI 8.8 M 4 x 16 Z. white
BV26	BV002600	NR	Vite TCEI PG DIN 912 CI 8.8 M 6 x 50 Z.Bianca	Screw DIN 912 PG CI 8.8 M 6 x 50 Z. white
BV27	BV002700	NR	Vite TSPEI PG DIN 7991 CI 10.9 M 6 x 40 Z.Bianca	screw DIN 7991 CI 10.9 M 6 x 40 Z. white
BV28	BV002800	NR	Vite TSPEI PG DIN 7991 CI 10.9 M 6 x 25 Z.Bianca	screw DIN 7991 CI 10.9 M 6 x 25 Z. white
BV29	BV002900	NR	Vite TE Tutto Filetto PG DIN 933 CI 8.8 M 6 x 25 Z.Bianca	Screw All Thread DIN 933 PG CI 8.8 M 6 x 25 Z. white
BV30	BV003000	NR	Vite TE Tutto Filetto PG DIN 933 CI 8.8 M 6 x 22 Z.Bianca	Screw All Thread DIN 933 PG CI 8.8 M 6 x 22 Z. white
BV31	BV003100	NR	Vite TSPEI PG DIN 7991 CI 10.9 M 6 x 20 Z.Bianca	screw DIN 7991 CI 10.9 M 6 x 20 Z. white
BV32	BV003200	NR	Vite TE Tutto Filetto PG DIN 933 CI 8.8 M 6 x 20 Z.Bianca	Screw All Thread DIN 933 PG CI 8.8 M 6 x 20 Z. white

POS	Codice	U.M.	 Descrizione	 Description
BV33	BV003300	NR	Vite TCEI PG DIN 912 CI 8.8 M 6 x 20 Z.Bianca	Screw DIN 912 PG CI 8.8 M 6 x 20 Z. white
BV34	BV003400	NR	Vite TE Tutto Filetto PG DIN 933 CI 8.8 M 6 x 16 Z.Bianca	Screw All Thread DIN 933 PG CI 8.8 M 6 x 16 Z. white
BV35	BV003500	NR	Vite TBEI PG ISO 7380 CI 10.9 M 6 x 16 Z.Bianca	screw ISO 7380 CI 10.9 M 6 x 16 Z. white
BV36	BV003600	NR	Vite TCEI PG DIN 912 CI 8.8 M 5 x 8 Z.Bianca	Screw DIN 912 PG CI 8.8 M 5 x 8 Z. white
BV37	BV003700	NR	Vite TSPEI PG DIN 7991 CI 10.9 M 5 x 60 Z.Bianca	screw DIN 7991 CI 10.9 M 5 x 60 Z. white
BV38	BV003800	NR	Vite TE Parziale Filetto PG DIN 931 CI 8.8 M 5 x 60 Z.Bianca	Screw Partial Thread DIN 931 PG CI 8.8 M 5 x 60 Z. white
BV39	BV003900	NR	Vite TCEI PG DIN 912 CI 8.8 M 5 x 60 Z.Bianca	Screw DIN 912 PG CI 8.8 M 5 x 60 Z. white
BV40	BV004000	NR	Vite TE Parziale Filetto PG DIN 931 CI 8.8 M 5 x 55 Z.Bianca	Screw Partial Thread DIN 931 PG CI 8.8 M 5 x 55 Z. white
BV41	BV004100	NR	Vite TE Tutto Filetto PG DIN 933 CI 8.8 M 5 x 16 Z.Bianca	Screw All Thread DIN 933 PG CI 8.8 M 5 x 16 Z. white
BV42	BV004200	NR	Vite TC Croce PG DIN 7985 CI 4.8 M 5 x 16 Z.Bianca	Cross head screw DIN 7985 PG CI 4.8 M 5 x 16 Z. white
BV43	BV004300	NR	Vite TE Tutto Filetto PG DIN 933 CI 8.8 M 5 x 12 Z.Bianca	Screw All Thread DIN 933 PG CI 8.8 M 5 x 12 Z. white
BV44	BV004400	NR	Vite TE UNF ANSI B18.2.1 GR.5 5/16 x 1"1/4 Z.Bianca	Screw UNF ANSI B18.2.1 GR.5 5/16 x 1 "1/4 Z. White
BV45	BV004500	NR	Vite TE UNF ANSI B18.2.1 GR.5 5/16 x 1"1/4 Z.Bianca	Screw UNF ANSI B18.2.1 GR.5 5/16 x 1 "1/4 Z. White
BV46	BV004600	NR	Vite TCEI PG DIN 912 CI 8.8 M 4 x 40 Z.Bianca	Screw DIN 912 PG CI 8.8 M 4 x 40 Z. white
BV47	BV004700	NR	Vite Trilob. Autoform. TC Croce PG DIN 7500-C C15 M 4 x 40 Z.Bianca	Trilob Screw. Autoform. TC Cross PH DIN 7500-C C 15 M 4 x 40 Z. white
BV48	BV004800	NR	Vite Trilob. Autoform. TC Croce PG DIN 7500-C C15 M 4 x 20 Z.Bianca	Trilob Screw. Autoform. TC Cross PG DIN 7500-C C15 M 4 x 20 Z. white
BV49	BV004900	NR	Vite TC Croce PG DIN 7985 CI 4.8 M 4 x 16 Z.Bianca	Cross head screw DIN 7985 PG CI 4.8 M 4 x 16 Z. white

POS	Codice	U.M.	 Descrizione	 Description
BV50	BV005000	NR	VITE AUTOFIETTANTE TE C/BORDINO DIN 6928 C15 4,8X50 Z.Bianca	TAPPING SCREW TE C / BORDINO DIN 6928 C15 4.8 X50 Z. white
BV51	BV005100	NR	VITE AUTOFIETTANTE TE C/BORDINO DIN 6928 C15 4,8X25 Z.Bianca	TAPPING SCREW TE C / BORDINO DIN 6928 C15 4.8 X25 Z. white
BV52	BV005200	NR	Vite TCEI PG DIN 912 CI 12.9 M 3 x 25 Z.D.Bianca	Screw DIN 912 M 3 CI 12.9 x 25 Z.D. white
BV53	BV005300	NR	Vite TSPEI PG DIN 7991 CI 10.9 M 3 x 14 Z.Bianca	Screw DIN 7991 CI 10.9 M 3 x 14 Z. white
BV54	BV005400	NR	Vite Autofil.TC Croce DIN 7981 C15 3,5 x 6,5 Z.Bianca	Autofil.TC Cross Screw DIN 7981 C15 3.5 x 6.5 Z. white
BV55	BV005500	NR	Vite TE Parziale Filetto PG DIN 931 CI 10.9 M 16 x 55 Z.D.Bianca	Screw Partial Thread DIN 931 PG CI 10.9 M 16 x 55 ZD white
BV56	BV005600	NR	Vite TE Tutto Filetto PG DIN 933 CI 8.8 M 16 x 40 Z.Bianca	Screw All Thread DIN 933 PG CI 8.8 M 16 x 40 Z. white
BV57	BV005700	NR	Vite TE Parziale Filetto PG DIN 931 CI 10.9 M 16 x 220 Z.Deidro Bianche	Screw Partial Thread DIN 931 PG CI 10.9 M 16 x 220 Z. dehydro White
BV58	BV005800	NR	Vite TE 8.8 DIN933 M16x20 Testa Alta 8 Zn Bianca	Screw M16x20 DIN933 8.8 Head High 8 Zn White
BV59	BV005900	NR	Vite TE Tutto Filetto PG DIN 933 CI 8.8 M 12 x 16 Z.Bianca	Screw All Thread DIN 933 PG CI 8.8 M 12 x 16 Z. white
BV60	BV006000	NR	Vite TE Parziale Filetto PG DIN 931 CI 8.8 M 12 x 120 Z.Bianca	Screw Partial Thread DIN 931 PG CI 8.8 M 12 x 120 Z. white
BV61	BV006100	NR	Vite TE Parziale Filetto PG DIN 931 CI 8.8 M 10 x 50 Z.Bianca	Screw Partial Thread DIN 931 PG CI 8.8 M 10 x 50 Z. white
BV62	BV006200	NR	Vite TE Tutto Filetto PG DIN 933 CI 8.8 M 10 x 35 Z.Bianca	Screw All Thread DIN 933 PG CI 8.8 M 10 x 35 Z. white
BV63	BV006300	NR	Vite TSPEI PG DIN 7991 CI 10.9 M 10 x 30 Z.Bianca	Screw DIN 7991 CI 10.9 M 10 x 30 Z. white
BV64	BV006400	NR	Vite TE Tutto Filetto PG DIN 933 CI 8.8 M 10 x 30 Z.Bianca	Screw All Thread DIN 933 PG CI 8.8 M 10 x 30 Z. white
BV65	BV006500	NR	Vite TCEI PG DIN 912 CI 12.9 M 10 x 25 Geo 321 A	Screw DIN 912 PG CI 12.9 M 10 x 25 Geo 321 A
BV66	BV006600	NR	Vite TCEI PG DIN 912 CI 8.8 M 10 x 25 Z.Bianca	Screw DIN 912 PG CI 8.8 M 10 x 25 Z. white

POS	Codice	U.M.	 Descrizione	 Description
BV67	BV006700	NR	Vite TE Tutto Filetto PG DIN 933 CI 8.8 M 10 x 20 Z.Bianca	Screw All Thread DIN 933 PG CI 8.8 M 10 x 20 Z. white
BV68	BV006800	NR	Vite TE Tutto Filetto PG DIN 933 CI 8.8 M 10 x 18 Z.Bianca	Screw All Thread DIN 933 PG CI 8.8 M 10 x 18 Z. white
BV69	BV006900	NR	Vite Trilob. Autoform. TSP Croce PG DIN 7500-M C15 M 5 x 16 Z.Bianca	Trilob Screw. Autoform. TSP Cross PG DIN 7500-M C15 M 5 x 16 Z. white
BV70	BV007000	NR	Vite TE Parziale Filetto PG DIN 931 CI 8.8 M 8 x 70 Z.Bianca	Screw Partial Thread DIN 931 PG CI 8.8 M 8 x 70 Z. white
BV71	BV007100	NR	Vite TE Parziale Filetto PG DIN 931 CI 8.8 M 8 x 65 Z.Bianca	Screw Partial Thread DIN 931 PG CI 8.8 M 8 x 65 Z. white
BV72	BV007200	NR	Vite TE Parziale Filetto PG DIN 931 CI 8.8 M 6 x 55 Z.Bianca	Screw Partial Thread DIN 931 PG CI 8.8 M 6 x 55 Z. white
BV73	BV007300	NR	Vite TCEI PG DIN 912 CI 8.8 M 6 x 55 Z.Bianca	Screw DIN 912 PG CI 8.8 M 6 x 55 Z. white
BV74	BV007400	NR	Vite TCEI PG DIN 912 CI 8.8 M 6 x 16 Z.Bianca	Screw DIN 912 PG CI 8.8 M 6 x 16 Z. white
BV75	BV007500	NR	Vite TSPEI PG DIN 7991 CI 10.9 M 6 x 10 Z.Bianca	Screw DIN 7991 CI 10.9 M 6 x 10 Z. white
BV76	BV007600	NR	Vite TCEI PG DIN 912 CI 8.8 M 5 x 55 Z.Bianca	Screw DIN 912 PG CI 8.8 M 5 x 55 Z. white
BV77	BV007700	NR	Vite TC Croce PG DIN 7985 CI 4.8 M 6 x 16 Z.Bianca	Cross head screw DIN 7985 PG CI 4.8 M 6 x 16 Z. white
BV78	BV007800	NR	Vite Trilob. Autoform. TC Croce PG DIN 7500-C C15 M 5 x 12 Z.Bianca	Trilob Screw. Autoform. TC Cross PG DIN 7500-C C15 M 5 x 12 Z. white
BV79	BV007900	NR	Vite TE Tutto Filetto PG DIN 933 CI 8.8 M 4 x 35 Z.Bianca	Screw All Thread DIN 933 PG CI 8.8 M 4 x 35 Z. white
BV80	BV008000	NR	VITE AUTOFIETTANTE TE C/BORDINO DIN 6928 C15 4,8X35 Z.Bianca	TAPPING SCREW TE C / BORDINO DIN 6928 C15 4.8 X35 Z. white
BV81	BV008100	NR	Vite TCEI PG DIN 912 CI 12.9 M 3 x 14 Z.D.Bianca	Screw DIN 912 M 3 CI 12.9 x 14 Z.D. white
BV82	BV008200	NR	Vite TE Parziale Filetto PG DIN 931 CI 8.8 M 16 x 70 Z.Bianca	Screw Partial Thread DIN 931 PG CI 8.8 M 16 x 70 Z. white
BV83	BV008300	NR	Vite TE Parziale Filetto PG DIN 931 CI 8.8 M 16 x 260 Z.Bianca	Screw Partial Thread DIN 931 PG CI 8.8 M 16 x 260 Z. white

POS	Codice	U.M.	 Descrizione	 Description
BV84	BV008400	NR	Vite TE Parziale Filetto PG DIN 931 CI 8.8 M 12 x 110 Z.Bianca	Screw Partial Thread DIN 931 PG CI 8.8 M 12 x 110 Z. white
BV85	BV008500	NR	Vite TE Tutto Filetto PG DIN 933 CI 8.8 M 10 x 40 Z.Bianca	Screw Thread DIN 933 PG CI 8.8 M 10 x 40 Z. white
BV86	BV008600	NR	Vite TCEI PG DIN 912 CI 8.8 M 8 x 65 Z.Bianca	Screw DIN 912 PG CI 8.8 M 8 x 65 Z. white
BV87	BV008700	NR	Vite TCEI PG DIN 912 CI 8.8 M 8 x 20 Z.Bianca	Screw DIN 931 PG CI 8.8 M 10 x 40 Z. white
BV88	BV008800	NR	Vite TCEI PG DIN 912 CI 10.9 M 10 x 18 Z.Bianca	Screw DIN 912 PG CI 10.9 M 10 x 18 Z. white
BV89	BV008900	NR	Vite TCEI PG DIN 912 CI 8.8 M 8 x 70 Z.Bianca	Screw DIN 912 PG CI 8.8 M 8 x 70 Z. white
BV91	BV009100	NR	Vite TE Tutto Filetto PG DIN 933 CI 8.8 M 6 x 40 Z.Bianca	Screw All Thread DIN 933 PG CI 8.8 M 6 x 40 Z. white
BV92	BV009200	NR	Vite TE Tutto Filetto PG DIN 933 CI 8.8 M 10 x 60 Z.Bianca	Screw All Thread DIN 933 PG CI 8.8 M 10 x 60 Z. white
BV93	BV009300	NR	Vite TSPEI PG DIN 7991 CI 10.9 M 5 x 20 Z.Bianca	screw DIN 7991 CI 10.9 M 5 x 20 Z. white
BV94	BV009400	NR	Vite TC Croce PG DIN 7985 CI 4.8 M 4 x 12 Z.Bianca	Cross head screw DIN 7985 PG CI 4.8 M 4 x 12 Z. white
BV95	BV009500	NR	Vite TE Tutto Filetto PG DIN 933 CI 8.8 M 4 x 12 Z.Bianca	Screw All Thread DIN 933 PG CI 8.8 M 4 x 12 Z. white
BV96	BV009600	NR	Vite TCEI PG DIN 912 CI 12.9 M 12 x 30 Dac 320A	Screw DIN 912 CI 12.9 M 12 x 30 Dac 320A
BV97	BV009700	NR	Vite Autofil.Testa Mezza Tonda C15 4,8 x 13 Z.Bianca	Half Round Head Self Tapping Screw C15 4,8 x 13
BV98	BV009800	NR	Vite TC Croce PG DIN 7985 CI 4.8 M 4 x 14 Z.Bianca	Screw DIN 7985 CI 4.8 M 4 x 14
BV99	BV009900	NR	Vite TE Parziale Filetto PG DIN 931 CI 8.8 M 5 x 65 Z.Bianca	Screw Partial Thread DIN 931 PG CI 8.8 M 5 x 65 Z. white
BV100	BV010000	NR	Vite Autofil.Testa Mezza Tonda C15 4,8 x 16 Z.Bianca	Half Round Head Self Tapping Screw C15 4,8 x 16
BV101	BV010100	NR	Vite TSPEI PG DIN 7991 CI 10.9 M 8 x 25 Z.Bianca	screw DIN 7991 CI 10.9 M 8 x 25 Z. white
BV102	BV010200	NR	Vite TCEI PG DIN 912 CI 8.8 M 4 x 30 Z.Bianca	Screw DIN 912 PG CI 8.8 M 4 x 30 White Z

POS	Codice	U.M.	 Descrizione	 Description
BV103	BV010300	NR	Vite TSPEI PG DIN 7991 CI 10.9 M 5 x 16 Z.Bianca	Screw DIN 7991 CI 10.9 M 5 x 16 Z. white
BV104	BV010400	NR	Vite TCEI bassa PG DIN 7984 CI 10.9 M 12 x 18 Z.D.Bianca	Screw DIN 7984 low PG CI 10.9 M 12 x 18 Z. D. white
BV105	BV010500	NR	Vite TE Parziale Filetto PG DIN 931 CI 8.8 M 12 x 75 Z.Bianca	Screw Partial Thread DIN 931 PG CI 8.8 M 12 x 75 Z. white
BV106	BV010600	NR	Vite TE Tutto Filetto PG DIN 933 CI 8.8 M 8 x 22 Z.Bianca	Screw All Thread DIN 933 PG CI 8.8 M 8 x 22 Z. white
BV107	BV010700	NR	Vite TE Tutto Filetto PG DIN 933 CI 8.8 M 6 x 35 Z.Bianca	Screw All Thread DIN 933 PG CI 8.8 M 6 x 35 Z. white
BV108	BV010800	NR	Vite TE Parziale Filetto PG DIN 931 CI 8.8 M 4 x 45 Z.Bianca	Screw Partial Thread DIN 931 PG CI 8.8 M 4 x 45 Z. white
BV109	BV010900	NR	Vite TE Tutto Filetto PG DIN 933 CI 10.9 M 16 x 45 Z.D.Bianca	Screw All Thread DIN 933 PG CI 10.9 M 16 x 45 ZD white
BV110	BV011000	NR	Vite TE Parziale Filetto PG DIN 931 CI 10.9 M 16 x 100 Z.D.Bianca	Screw Partial Thread DIN 931 PG CI 10.9 M 16 x 100 ZD white
BV111	BV011100	NR	Vite TE Parziale Filetto PG DIN 931 CI 10.9 M 16 x 105 Z.D.Bianca	Screw Partial Thread DIN 931 PG CI 10.9 M 16 x 105 ZD white
BV112	BV011200	NR	Vite TE Tutto Filetto PG DIN 933 CI 8.8 M 10 x 25 Z.Bianca	Screw All Thread DIN 933 PG CI 8.8 M 10 x 25 Z. white
BV113	BV011300	NR	Vite TSPEI PG DIN 7991 CI 10.9 M 6 x 50 Z.Bianca	TSPEI PG screw DIN 7991 CI 10.9 M 6 x 50 Z. white
BV114	BV011400	NR	Vite TSPEI PG DIN 7991 CI 10.9 M 8 x 25 Z.Bianca	TSPEI PG screw DIN 7991 CI 10.9 M 8 x 25 Z. white
BV115	BV011500	NR	Vite TE Tutto Filetto PG DIN 933 CI 8.8 M 10 x 45 Z.Bianca	Screw All Thread DIN 933 PG CI 8.8 M 10 x 45 Z. white
BV116	BV011600	NR	Vite TE Tutto Filetto PG DIN 933 CI 8.8 M 5 x 8 Z.Bianca	Screw All Thread DIN 933 PG CI 8.8 M 5 x 8 Z. white
BV117	BV011700	NR	Vite TE Tutto Filetto PG DIN 933 CI 8.8 M 8 x 18 Z.Bianca	Screw All Thread DIN 933 PG CI 8.8 M 8 x 18 Z. white
BV118	BV011800	NR	Vite TE Tutto Filetto PG DIN 933 CI 8.8 M 8 x 40 Z.Bianca	Screw All Thread DIN 933 PG CI 8.8 M 8 x 40 Z. white
BV119	BV011900	NR	Vite TCEI PG DIN 912 CI 8.8 M 8 x 100 Z.Bianca	Screw DIN 912 PG CI 8.8 M 8 x 100 Z. white



POS	Codice	U.M.	 Descrizione	 Description
BV120	BV012000	NR	Vite TCEI PG DIN 912 CI 8.8 M 8 x 110 Z.Bianca	Screw DIN 912 PG CI 8.8 M 8 x 110 Z. white
BV121	BV012100	NR	Vite TE Parziale Filetto PG DIN 931 CI 8.8 M 5 x 75 Z.Bianca	Screw Partial Thread DIN 931 PG CI 8.8 M 5 x 75 Z. white
BV122	BV012200	NR	Vite TE Parziale Filetto PG DIN 931 CI 8.8 M 12 x 130 Z.Bianca	Screw Partial Thread DIN 931 PG CI 8.8 M 12 x 130 Z. white
BV123	BV012300	NR	Vite TC Croce PG DIN 7985 CI 4.8 M 4 x 8 Z.Bianca	Cross head screw DIN 7985 PG CI 4.8 M 4 x 8 Z. white
BV124	BV012400	NR	Vite TCEI PG DIN 912 CI 8.8 M 6 x 40 Z.Bianca	Screw DIN 912 PG CI 8.8 M 6 x 40 Z. white
BV125	BV012500	NR	Vite TE Tutto Filetto PG DIN 933 CI 8.8 M 4 x 20 Z.Bianca	Screw All Thread DIN 933 PG CI 8.8 M 4 x 20 Z. white
BV126	BV012600	NR	Vite TE UNC ANSI B18.2.1 GR.5 3/8 x 1" Z.Bianca	Screw UNC ANSI B18.2.1 GR.5 3/8 x 1 "Z. White
BV127	BV012700	NR	Vite TE UNC ANSI B18.2.1 GR.5 3/8 x 1" 1/4Z.Bianca	Screw UNC ANSI B18.2.1 GR.5 3/8 x 1 "1/4 Z. White
BV128	BV012800	NR	Vite TE Tutto Filetto PG DIN 933 CI 8.8 M 4 x 16 Z.Bianca	Screw All Thread DIN 933 PG CI 8.8 M 4 x 16 Z. white
BV129	BV012900	NR	Vite TCEI PG DIN 912 CI 8.8 M 5 x 16 Z.Bianca	Screw DIN 912 PG CI 8.8 M 5 x 16 Z. white
BV130	BV013000	NR	Vite TCEI PG DIN 912 CI 8.8 M 3 x 12 Z.Bianca	Screw DIN 912 PG CI 8.8 M 3 x 12 Z. white
BV131	BV013100	NR	Vite TSPEI PG DIN 7991 CI 10.9 M 5 x 30 Z.Bianca	TSPEI PG screw DIN 7991 CI 10.9 M 5 x 30 Z. white
BV132	BV013200	NR	Vite TSPEI PG DIN 7991 CI 10.9 M 5 x 55 Z.Bianca	TSPEI PG screw DIN 7991 CI 10.9 M 5 x 55 Z. white
BV133	BV013300	NR	Vite TE Tutto Filetto PG DIN 933 CI 8.8 M 3 x 25 Z.Bianca	Screw All Thread DIN 933 PG CI 8.8 M 3 x 25 Z. white
BV134	BV013400	NR	Vite TE Parziale Filetto PG DIN 931 CI 8.8 M 10 x 65 Z.Bianca	Screw Partial Thread DIN 931 PG CI 8.8 M 10 x 65 Z. white
BV135	BV013500	NR	Vite TCEI PG DIN 912 CI 8.8 M 12 x 50	Screw DIN 912 CI 9.8 M 12 x 50
BV136	BV013600	NR	Vite TSPEI PG DIN 7991 CI 10.9 M 5 x 25 Z.Bianca	TSPEI PG screw DIN 7991 CI 10.9 M 5 x 25 Z. white

POS	Codice	U.M.	 Descrizione	 Description
BV137	BV013700	NR	Vite TCEI PG DIN 912 CI 8.8 M 8 x 30	Screw DIN 912 CI 8.8 M 8 x 30
BV138	BV013800	NR	Vite TC Croce PG DIN 7985 CI 4.8 M 5 x 10 Z.Bianca	Screw DIN 7985 CI 4.8 M 5 x 10
BV139	BV013900	NR	Vite TCEI PG DIN 912 CI 12.9 M 4 x 25 Z. Bianca	Screw DIN 912 CI 12.9 M 4 x 25 Z. Withe
BV140	BV014000	NR	Vite TE Parziale Filetto PG DIN 931 CI 8.8 M 5 x 70 Z.Bianca	Screw Partial Thread DIN 931 PG CI 8.8 M 5 x 70 Z. white
BV141	BV014100	NR	Vite TE Parziale Filetto PG DIN 931 CI 8.8 M 12 x 90 Z.Bianca	Screw Partial Thread DIN 931 PG CI 8.8 M 12 x 90 Z. white
BV142	BV014200	NR	Vite TE Parziale Filetto PG DIN 931 CI 8.8 M 8 x 55 Z.Bianca	Screw Partial Thread DIN 931 PG CI 8.8 M 8 x 55 Z. white
BV143	BV014300	NR	Vite TSPEI PG DIN 7991 CI 10.9 M 10 x 20 Z.Bianca	TSPEI PG screw DIN 7991 CI 10.9 M 10 x 20 Z. white
BV144	BV014400	NR	Vite TE Tutto Filetto PG DIN 933 CI 8.8 M 12 x 20 Z.Bianca	Screw All Thread DIN 933 PG CI 8.8 M 12 x 20 Z. white
BV145	BV014500	NR	Vite TE Tutto Filetto PG DIN 933 CI 8.8 M 12 x 35 Z.Bianca	Screw All Thread DIN 933 PG CI 8.8 M 12 x 35 Z. white
BV146	BV014600	NR	Vite TE Tutto Filetto PF DIN 961 CI 8.8 M 10 x 1,25 x 25 Z.Bianca	All PF thread hex head screw DIN 961 CI 8.8 M 10 x 1,25 x 25 Z.Bianca
BV147	BV014700	NR	Vite TSPEI PG DIN 7991 CI 10.9 M 12 x 90 Z.Bianca	TSPEI PG screw DIN 7991 CI 10.9 M12 x 90 Z. white
BV148	BV014800	NR	Vite TSPEI PG DIN 7991 CI 10.9 M 6 x 16 Z.Bianca	TSPEI PG screw DIN 7991 CI 10.9 M6 x 16 Z. white
BV149	BV014900	NR	Vite TBEI PG ISO 7380 CI 10.9 M 6 x 20 Z.Bianca	Hex socket screw ISO 7380 PG CI 10.9 M 6 x 20 Z. white
BV150	BV015000	NR	Vite TE Tutto Filetto PG DIN 933 CI 10.9 M 14 x 40 Z.Bianca	Screw All Thread DIN 933 PG CI 10.9 M 14 x 40 Z. white
BV151	BV015100	NR	Vite TE Parziale Filetto PG DIN 931 CI 8.8 M 10 x 85 Z.Bianca	Screw Partial Thread DIN 931 PG CI 8.8 M 10 x 85 Z. white
BV152	BV015200	NR	Vite TE Parziale Filetto PG DIN 931 CI 8.8 M 10 x 75 Z.Bianca	Screw Partial Thread DIN 931 PG CI 8.8 M 10 x 75 Z. white
BV153	BV015300	NR	Vite TE Tutto Filetto PG DIN 933 CI 8.8 M14 x 45 Z.Bianca	Screw All Thread DIN 933 PG CI 8.8 M14 x 45 Z. white

POS	Codice	U.M.	 Descrizione	 Description
BV154	BV015400	NR	Vite TCEI PG DIN 912 CI 12.9 M 8 x 35 GEOMET 321A	Screw DIN 912 CI 12.9 M 8 x 35 GEOMET 321A
BV155	BV015500	NR	Vite TCEI PG DIN 912 CI 12.9 M 5 x 20 GEOMET 321A	Screw DIN 912 CI 12.9 M 5 x 20 GEOMET 321A
BV156	BV015600	NR	Vite TBEI PG ISO 7380 CI 10.9 M 6 x 25 Z.Bianca	Hex socket screw ISO 7380 PG CI 10.9 M 6 x 25 Z. white
BV157	BV015700	NR	Vite TBEI PG ISO 7380 CI 10.9 M 8 x 20 Z.Bianca	Hex socket screw ISO 7380 PG CI 10.9 M 8 x 20 Z. white
BV158	BV015800	NR	Vite TBEI PG ISO 7380 CI 10.9 M 6 x 70 Z.Bianca	Hex socket screw ISO 7380 PG CI 10.9 M 6 x 70 Z. white
BV159	BV015900	NR	Vite TBEI PG ISO 7380 CI 10.9 M 10 x 20 Z.Bianca	Hex socket screw ISO 7380 PG CI 10.9 M 10 x 20 Z. white
BV160	BV016000	NR	Vite TSPEI PG DIN 7991 CI 10.9 M 4 x 16 Z.Bianca	TSPEI PG screw DIN 7991 CI 10.9 M4 x 16 Z. white
BV161	BV016100	NR	Vite TCEI UNC ASME/ANSI B18.3 ASTM A 574 1/2 x 1"1/4	hex head screw TCEI UNC ASME/ANSI B18.3 ASTM A 574 1/2 x 1"1/4
BV162	BV016200	NR	Vite TCEI PG DIN 912 CI 12.9 M14 x 45 GEOMET 321A	Screw DIN 912 CI 12.9 M14 x 45 GEOMET 321A
BV163	BV016300	NR	Vite TCEI PG DIN 912 CI 8.8 M6 x 35 GEOMET 321A	Screw DIN 912 CI 8.8 M6 x 35 GEOMET 321A
BV164	BV016400	NR	Vite TCEI PG DIN 912 CI 8.8 M10 x 35 GEOMET 321A	Screw DIN 912 CI 8.8 M10 x 35 GEOMET 321A
BV165	BV016500	NR	Vite TE Tutto Filetto PG DIN 933 CI 8.8 M8 x 12 Z.Bianca	Screw All Thread DIN 933 PG CI 8.8 M8 x 12 Z. white
BV166	BV016600	NR	Vite TCEI PG DIN 912 CI 8.8 M4 x 20 GEOMET 321A	Screw DIN 912 CI 8.8 M4 x 20 GEOMET 321A
BV167	BV016700	NR	Vite TCEI PG DIN 912 CI 8.8 M4 x 20 GEOMET 321A	All PF thread hex head screw DIN 961 CI 8.8 M 12 x 1,25 x 30 Z.Bianca
BV168	BV016800	NR	Vite TE Tutto Filetto PF DIN 961 CI 8.8 M 10 x 1,25 x 30 Z.Bianca	All PF thread hex head screw DIN 961 CI 8.8 M 10 x 1,25 x 30 Z.Bianca
BV169	BV016900	NR	Vite TCEI PG DIN 912 CI 8.8 M 10 x 1,25 x 30	Screw DIN 912 CI 8.8 M10 x 1,25 x 30
BV170	BV017000	NR	Vite TE Tutto Filetto PF DIN 961 CI 8.8 M 10 x 1,25 x 30 Z.Bianca	All PF thread hex head screw DIN 961 CI 8.8 M 10 x 1,25 x 60 Z.Bianca

POS	Codice	U.M.	 Descrizione	 Description
BV171	BV017100	NR	Vite TE Tutto Filetto PF DIN 961 CI 8.8 M 12 x 1,25 x 25 Z.Bianca	All PF thread hex head screw DIN 961 CI 8.8 M 12 x 1,25 x 25 Z.Bianca
BV172	BV017200	NR	Vite TE UNC ANSI B18.2.1 GR.5 5/8 passo 11 L= 1" 1/2	UNC hex head screw ANSI B18.2.1 GR.5 5/8 11 L = 1 "1/2
BV173	BV017300	NR	Vite TE Tutto Filetto PG DIN 933 CI 8.8 M12 x 30 Z.Bianca	Screw All Thread DIN 933 PG CI 8.8 M12 x 30 Z. white
BV174	BV017400	NR	Vite TE Tutto Filetto PG DIN 933 CI 8.8 M5 x 45 Z.Bianca	Screw All Thread DIN 933 PG CI 8.8 M5 x 45 Z. white
BV175	BV017500	NR	Vite TE Tutto Filetto PG DIN 933 CI 8.8 M12 x 80 Z.Bianca	Screw All Thread DIN 933 PG CI 8.8 M12 x 80 Z. white
BV176	BV017600	NR	Vite TCEI PG DIN 912 CI 8.8 M6 x 25 GEOMET 321A	Screw DIN 912 CI 8.8 M6 x 25 GEOMET 321A
BV177	BV017700	NR	Vite TE Tutto Filetto PG DIN 933 CI 8.8 M12 x 85 Z.Bianca	Screw All Thread DIN 933 PG CI 8.8 M12 x 85 Z. white
BV178	BV017800	NR	Vite TE Tutto Filetto PG DIN 933 CI 8.8 M8 x 90 Z.Bianca	Screw All Thread DIN 933 PG CI 8.8 M8 x 90 Z. white
BV179	BV017900	NR	Vite TE Tutto Filetto PG DIN 933 CI 8.8 M5 x 40 Z.Bianca	Screw All Thread DIN 933 PG CI 8.8 M5 x 40 Z. white
BV180	BV018000	NR	Vite TE Tutto Filetto PG DIN 933 CI 8.8 M6 x 75 Z.Bianca	Screw All Thread DIN 933 PG CI 8.8 M6 x 75 Z. white
BV181	BV018100	NR	Vite TE Tutto Filetto PG DIN 933 CI 8.8 M10 x 40 Z.Bianca	Screw All Thread DIN 933 PG CI 8.8 M10 x 40 Z. white
BV182	BV018200	NR	Vite TE Tutto Filetto PG DIN 933 CI 10.9 M 16 x 70 Z.Bianca	Screw All Thread DIN 933 PG CI 10.9 M 16 x 70 Z. white
BV183	BV018300	NR	Vite TE Tutto Filetto PG DIN 933 CI 8.8 M5 x 10 Z.Bianca	Screw All Thread DIN 933 PG CI 8.8 M5 x 10 Z. white
BV184	BV018400	NR	Vite TE Tutto Filetto PG DIN 933 CI 8.8 M10 x 16 Z.Bianca	Screw All Thread DIN 933 PG CI 8.8 M10 x 16 Z. white
BV185	BV018500	NR	Vite TCEI PG DIN 912 CI 8.8 M8 x 55 GEOMET 321A	Screw DIN 912 CI 8.8 M8 x 55 GEOMET 321A
BV186	BV018600	NR	Vite TCEI PG DIN 912 CI 12.9 M10 x 30 GEOMET 321A	Screw DIN 912 CI 12.9 M10 x 30 GEOMET 321A
BV187	BV018700	NR	Vite TCEI PG DIN 912 CI 12.9 M14 x 40 GEOMET 321A	Screw DIN 912 CI 12.9 M14 x 40 GEOMET 321A
BV188	BV018800	NR	Vite TE Tutto Filetto PG DIN 933 CI 8.8 M 12 x 60 Z.Bianca	Screw All Thread DIN 933 PG CI 8.8 M12 x 60 Z. white



POS	Codice	U.M.	 Descrizione	 Description
BV189	BV018900	NR	Vite TE Tutto Filetto PG DIN 933 CI 8.8 M 12 x 55 Z.Bianca	Screw All Thread DIN 933 PG CI 8.8 M12 x 55 Z. white
BV190	BV019000	NR	Vite TE Tutto Filetto PG DIN 933 CI 8.8 M 12 x 50 Z.Bianca	Screw All Thread DIN 933 PG CI 8.8 M12 x 50 Z. white
BV191	BV019100	NR	Vite TE Tutto Filetto PG DIN 933 CI 8.8 M 16 x 50 Z.Bianca	Screw All Thread DIN 933 PG CI 8.8 M16 x 50 Z. white
BV192	BV019200	NR	Vite TE Tutto Filetto PG DIN 933 CI 8.8 M 16 x 55 Z.Bianca	Screw All Thread DIN 933 PG CI 8.8 M16 x 55 Z. white
BV193	BV019300	NR	Vite TE Parziale Filetto PG DIN 931 CI 8.8 M 10 x 55 Z.Bianca	Screw Partial Thread DIN 931 PG CI 8.8 M 10 x 55 Z. white
BV194	BV019400	NR	Vite TE Parziale Filetto PG DIN 931 CI 8.8 M 16 x 230 Z.Bianca	Screw Partial Thread DIN 931 PG CI 8.8 M 16 x 230 Z. white
BV195	BV019500	NR	Vite TE Parziale Filetto PG DIN 931 CI 8.8 M 6 x 50 Z.Bianca	Screw Partial Thread DIN 931 PG CI 8.8 M 6 x 50 Z. white
BV196	BV019600	NR	Vite TE Parziale Filetto PG DIN 931 CI 8.8 M 6 x 65 Z.Bianca	Screw Partial Thread DIN 931 PG CI 8.8 M 6 x 65 Z. white
BV197	BV019700	NR	Vite TE Parziale Filetto PG DIN 931 CI 8.8 M 8 x 45 Z.Bianca	Screw Partial Thread DIN 931 PG CI 8.8 M 8 x 45 Z. white
BV198	BV019800	NR	Vite TE Parziale Filetto PG DIN 931 CI 8.8 M 8 x 55 Z.Bianca	Screw Partial Thread DIN 931 PG CI 8.8 M 8 x 55 Z. white
BV199	BV019900	NR	Vite TE Parziale Filetto PG DIN 931 CI 8.8 M 8 x 60 Z.Bianca	Screw Partial Thread DIN 931 PG CI 8.8 M 8 x 60 Z. white
BV200	BV020000	NR	Vite TE Tutto Filetto PG DIN 933 CI 10.9 M 16 x 40 Z.Bianca	Screw All Thread DIN 933 PG CI 10.9 M 16 x 40 Z. white
BV201	BV020100	NR	Vite TSPEI PG DIN 7991 CI 10.9 M16 x 45 Z.Bianca	TSPEI PG screw DIN 7991 CI 10.9 M16 x 45 Z. white
BV202	BV020200	NR	Vite TCEI PG DIN 912 CI 12.9 M3 x 12 ZINC. iridescente Fe/Zn5IVs	Screw DIN 912 CI 12.9 M3 x 12 ZINC. iridescente Fe/Zn5IVs
BV203	BV020300	NR	Vite TC Croce PG DIN 7985 CI 4.8 M M 3 x 5 Z.Bianca	Screw DIN 7985 CI 4.8 M M 3 x 5
BV204	BV020400	NR	Vite TC Croce PG DIN 7985 CI 4.8 M M 3 x 8 Z.Bianca	Screw DIN 7985 CI 4.8 M M 3 x 8
BV205	BV020500	NR	Vite TTQST DIN 603/555 CI 4.8 M 8 x 35 Z.Bianca	TTQST Screw DIN 603/555 CL 4.8 M 8 x 35 Z. White

POS	Codice	U.M.	 Descrizione	 Description
BV206	BV020600	NR	Vite TC Croce PG DIN 7985 CI 4.8 M M 5 x 80 Z.Bianca	Screw DIN 7985 CI 4.8 M M 5 x 80
BV207	BV020700	NR	Vite TE Parziale Filetto PG DIN 931 CI 8.8 M 10 x 80 Z.Bianca	Screw Partial Thread DIN 931 PG CI 8.8 M 10 x 80 Z. white
BV208	BV020800	NR	Vite TE Tutto Filetto PG DIN 933 CI 8.8 M 16 x 35 Z.D.Bianca	Screw All Thread DIN 933 PG CI 8.8 M 16 x 35 ZD white
BV209	BV020900	NR	Vite TE Parziale Filetto PG DIN 931 CI 8.8 M 10 x 95 Z.Bianca	Screw Partial Thread DIN 931 PG CI 8.8 M 10 x 95 Z. white
BV210	BV021000	NR	Vite TE Tutto Filetto PG DIN 933 CI 8.8 M 6 x 14 Z.D.Bianca	Screw All Thread DIN 933 PG CI 8.8 M 6 x 14 ZD white
BV211	BV021100	NR	Vite TE Tutto Filetto PG DIN 933 CI 8.8 M 12 x 25 Z.D.Bianca	Screw All Thread DIN 933 PG CI 8.8 M 12 x 25 ZD white
BV212	BV021200	NR	Vite TE Tutto Filetto PG DIN 933 CI 8.8 M 4 x 14 Z.D.Bianca	Screw All Thread DIN 933 PG CI 8.8 M 4 x 14 ZD white
BV213	BV021300	NR	Vite TE Tutto Filetto PG DIN 933 CI 10.9 M 16 x 60 Z.D.Bianca	Screw All Thread DIN 933 PG CI 10.9 M 16 x 60 ZD white
BV214	BV021400	NR	Vite TE Parziale Filetto PG DIN 931 CI 8.8 M 6 x 100 Z.Bianca	Screw Partial Thread DIN 931 PG CI 8.8 M 6 x 100 Z. white
BV215	BV021500	NR	Vite TE Parziale Filetto PG DIN 931 CI 10.9 M 16 x 110 Z.D.Bianca	Screw Partial Thread DIN 931 PG CI 10.9 M 16 x 110 ZD white
BV216	BV021600	NR	Vite TE Parziale Filetto PG DIN 931 CI 10.9 M 16 x 240 Z.D.Bianca	Screw Partial Thread DIN 931 PG CI 10.9 M 16 x 240 ZD white
BV217	BV021700	NR	Vite TSPEI PG DIN 7991 CI 10.9 M 8 x 30 Z.Bianca	TSPEI PG screw DIN 7991 CI 10.9 M8 x 30 Z. white
BV218	BV021800	NR	Vite TSPEI PG DIN 7991 CI 10.9 M 5 x 6 Z.Bianca	TSPEI PG screw DIN 7991 CI 10.9 M5 x 6 Z. white
BV219	BV021900	NR	Vite TSPEI PG DIN 7991 CI 10.9 M 5 x 70 Z.Bianca	TSPEI PG screw DIN 7991 CI 10.9 M5 x 70 Z. white
BV220	BV022000	NR	Vite TSPEI PG DIN 7991 CI 10.9 M 12 x 35 Z.Bianca	TSPEI PG screw DIN 7991 CI 10.9 M12 x 35 Z. white
BV221	BV022100	NR	Vite TCEI PG DIN 912 CI 12.9 M10 x 20 GEOMET 321A	Screw DIN 912 CI 12.9 M10 x 20 GEOMET 321A
BV222	BV022200	NR	Vite TCEI PG DIN 912 CI 12.9 M8 x 90 GEOMET 321A	Screw DIN 912 CI 12.9 M8 x 90 GEOMET 321A



POS	Codice	U.M.	 Descrizione	 Description
BV223	BV022300	NR	Vite TCEI PG DIN 912 CI 12.9 M3 x 5 ZINC.	Screw DIN 912 CI 12.9 M3 x 5 ZINC.
BV224	BV022400	NR	Vite TBEI PG ISO 7380 CI 10.9 M 8 x 22 Z.Bianca	Hex socket screw ISO 7380 PG CI 10.9 M 8 x 22 Z. white
BV225	BV022500	NR	Vite TE Parziale Filetto PG DIN 931 CI 8.8 M 10 x 100 Z.Bianca	Screw Partial Thread DIN 931 PG CI 8.8 M 10 x 100 Z. white
BV226	BV022600	NR	Vite TE Parziale Filetto PG DIN 931 CI 8.8 M 10 x 110 Z.Bianca	Screw Partial Thread DIN 931 PG CI 8.8 M 10 x 110 Z. white
BV227	BV022700	NR	Vite TE Tutto Filetto PG DIN 933 CI 10.9 M 12 x 45 Z.D.Bianca	Screw All Thread DIN 933 PG CI 10.9 M 12 x 45 ZD white
BV228	BV022800	NR	Vite TE Tutto Filetto PG DIN 933 CI 10.9 M 14 x 35 Z.D.Bianca	Screw All Thread DIN 933 PG CI 10.9 M 14 x 35 ZD white
BV229	BV022900	NR	Vite TSPEI PG DIN 7991 CI 10.9 M 12 x 30 Z.Bianca	TSPEI PG screw DIN 7991 CI 10.9 M12 x 30 Z. white
BV230	BV023000	NR	Vite TE flangiata Tutto Filetto PG DIN 6921 CI 8.8 M 5 x 12 Zinconickel nero +sigillante	Flange Screw All Thread DIN 6921 PG CI 8.8 M 5 x 12 Zincnickel black +sealant
BV231	BV023100	NR	Vite TE flangiata Tutto Filetto PG DIN 6921 CI 8.8 M 6 x 16 Zinconickel nero +sigillante	Flange Screw All Thread DIN 6921 PG CI 8.8 M 6 x 16 Zincnickel black +sealant
BV232	BV023200	NR	Vite TE Tutto Filetto PG DIN 933 CI 8.8 M 5 x 25 Z.D.Bianca	Screw All Thread DIN 933 PG CI 8.8 M 5 x 25 ZD white
BV233	BV023300	NR	Vite TE Tutto Filetto PG DIN 933 CI 8.8 M 8 x 130 Z.D.Bianca	Screw All Thread DIN 933 PG CI 8.8 M 8 x 130 ZD white
BV234	BV023400	NR	Vite TBEI PG ISO 7380 CI 10.9 M 8 x 22 Z.Bianca	Hex socket screw ISO 7380 PG CI 10.9 M 8 x 22 Z. white
BV235	BV023500	NR	Vite TE Tutto Filetto PG DIN 933 CI 10.9 M 16 x 35 Z.D.Bianca	Screw All Thread DIN 933 PG CI 10.9 M 16 x 35 ZD white
BV236	BV023600	NR	Vite TE Parziale Filetto PG DIN 931 CI 8.8 M 6 x 45 Z.Bianca	Screw Partial Thread DIN 931 PG CI 8.8 M 6 x 45 Z. white
BV237	BV023700	NR	Vite TE Tutto Filetto PG DIN 933 CI 10.9 M 12 x 30 Z.D.Bianca	Screw All Thread DIN 933 PG CI 10.9 M 12 x 30 ZD white
BV238	BV023800	NR	Vite TE Parziale Filetto PG DIN 931 CI 8.8 M 16 x 90 Z.Bianca	Screw Partial Thread DIN 931 PG CI 8.8 M 16 x 90 Z. white



POS	Codice	U.M.	 Descrizione	 Description
BV239	BV023900	NR	Vite TE Parziale Filetto PG DIN 931 CI 8.8 M 12 x 65 Z.Bianca	Screw Partial Thread DIN 931 PG CI 8.8 M 12 x 65 Z. white
BV240	BV024000	NR	Vite TC Croce PG DIN 7985 CI 4.8 M 5 x 20 Z.Bianca	Screw DIN 7985 CI 4.8 M 5 x 20
BV241	BV024100	NR	Vite TSPEI PG DIN 7991 CI 10.9 M 10 x 35 Z.Bianca	TSPEI PG screw DIN 7991 CI 10.9 M 10 x 35 Z. white
BV242	BV024200	NR	Vite TSPEI PG DIN 7991 CI 10.9 M 6 x 12 Z.Bianca	TSPEI PG screw DIN 7991 CI 10.9 M 6 x 12 Z. white
BV243	BV024300	NR	Vite TE Parziale Filetto PG DIN 931 CI 8.8 M 12 x 150 Z.Bianca	Screw Partial Thread DIN 931 PG CI 8.8 M 12 x 150 Z. white
BV244	BV024400	NR	Vite TCEI PG DIN 912 CI 8.8 M5 x 50 GEOMET 321A	Screw DIN 912 CI 8.8 M5 x 50 GEOMET 321A
BV245	BV024500	NR	Vite TE Parziale Filetto PG DIN 931 CI 8.8 M 8 x 110 Z.Bianca	Screw Partial Thread DIN 931 PG CI 8.8 M 8 x 110 Z. white
BV246	BV024600	NR	Vite TE Parziale Filetto PG DIN 931 CI 8.8 M 8 x 40 Z.Bianca	Screw Partial Thread DIN 931 PG CI 8.8 M 8 x 40 Z. white
BV247	BV024700	NR	Vite TE Tutto Filetto PG DIN 933 CI 8.8 M 5 x 50 Z.D.Bianca	Screw All Thread DIN 933 PG CI 8.8 M 5 x 50 ZD white
BV248	BV024800	NR	Vite TCEI PG DIN 912 CI 8.8 M5 x 18 GEOMET 321A	Screw DIN 912 CI 8.8 M5 x 18 GEOMET 321A
BV249	BV024900	NR	Vite TSPEI PG DIN 7991 CI 10.9 M 5 x 65 Z.Bianca	TSPEI PG screw DIN 7991 CI 10.9 M 5 x 65 Z. white
BV251	BV025100	NR	Vite TSPEI PG DIN 7991 CI 10.9 M 8 x 35 Z.Bianca	TSPEI PG screw DIN 7991 CI 10.9 M 8 x 35 Z. white
BV252	BV025200	NR	Vite TE Tutto Filetto PG DIN 933 CI 10.9 M 12 x 40 Z.D.Bianca	Screw All Thread DIN 933 PG CI 10.9 M 12 x 40 ZD white
BV253	BV025300	NR	Vite TBEI PG ISO 7380 M 6 x 55 Z.Bianca	Hex socket screw ISO 7380 PG M 6 x 55 Z. white
BV254	BV025400	NR	Vite TE Tutto Filetto PG DIN 933 CI 10.9 M 10 x 35 Z.D.Bianca	Screw All Thread DIN 933 PG CI 10.9 M 10 x 35 ZD white
BV255	BV025500	NR	Vite TE Tutto Filetto PG DIN 933 CI 12.9 M 14 x 55 Z.D.Bianca	Screw All Thread DIN 933 PG CI 12.9 M 14 x 55 ZD white
BV256	BV025600	NR		





POS	Codice	U.M.	 Descrizione	 Description
BV257	BV025700	NR	Vite TE Tutto Filetto PG DIN 933 CI 8.8 M14 x 30 Z.Bianca	Screw All Thread DIN 933 PG CI 8.8 M14 x 30 Z. white
BV258	BV025800	NR	Vite TE Tutto Filetto PG DIN 933 CI 10.9 M 12 x 35 Z.D.Bianca	Screw All Thread DIN 933 PG CI 10.9 M 12 x 35 ZD white
BV259	BV025900	NR	Vite TE Tutto Filetto PG DIN 933 CI 8.8 M 16 x 45 Z.Bianca	Screw All Thread DIN 933 PG CI 8.8 M16 x 45 Z. white
BV260	BV026000	NR	Vite TCEI PG DIN 912 CI 10.9 M 12 x 30 Dac 320A	Screw DIN 912 CI 10.9 M 12 x 30 Dac 320A
BV261	BV026100	NR	Vite TCEI PG DIN 912 CI 10.9 M 12 x 20 Dac 320A	Screw DIN 912 CI 10.9 M 12 x 20 Dac 320A
BV262	BV026200	NR	Vite TCEI PG DIN 912 CI 12.9 M14 x 35 GEOMET 321A	Screw DIN 912 CI 12.9 M14 x 35 GEOMET 321A
BV263	BV026300	NR	Vite TCEI PG DIN 912 CI 12.9 M14 x 3 GEOMET 321A	Screw DIN 912 CI 12.9 M14 x 3 GEOMET 321A
BV264	BV026400	NR	Vite TSPEI PG DIN 7991 CI 10.9 M 12 x 25 Z.Bianca	TSPEI PG screw DIN 7991 CI 10.9 M12 x 25 Z. white
BV265	BV026500	NR	Vite TE Parziale Filetto PG DIN 931 CI 10.9 M 16 x 180 GEOMET 321A	Screw Partial Thread DIN 931 PG CI 10.9 M 16 x 180 GEOMET 321A
BV266	BV026600	NR	Vite TE Tutto Filetto PG DIN 933 CI 8.8 M8 x 10 Z.Bianca	Screw All Thread DIN 933 PG CI 8.8 M8 x 10 Z. white
BV267	BV026700	NR	Vite TCEI PG DIN 912 CI 8.8 M 12 x 40	Screw DIN 912 CI 9.8 M 12 x 40
BV268	BV026800	NR	Vite TE Parziale Filetto PG DIN 931 CI 8.8 M 12 x 140 Z.Bianca	Screw Partial Thread DIN 931 PG CI 8.8 M 12 x 140 Z. white



POS	Codice	U.M.	 Descrizione	 Description
RB1	RB000100	NR	DADO PER OGIVA Ø=12	NUT FOR OGIVA Ø = 12
RD1	RD000100	NR	RACCORDO CORPO A "T" EO F(DKOL)-M-M 8L	FITTING BODY A "T" EO F (DKOL) M-M-8L
RD2	RD000200	NR	RACCORDO CORPO A "T" EO F(DKOL)-M-M 10L	FITTING BODY A "T" EO F (DKOL) M-M-10L
RD3	RD000300	NR	RACCORDO CORPO A "T" EO F(DKOL)-M-M 12L	FITTING BODY A "T" EO F (DKOL) M-M-12L
RD4	RD000400	NR	RACCORDO CORPO A "T" EO F(DKOL)-M-M 15L	FITTING BODY A "T" EO F (DKOL) M-M-15L
RD5	RD000500	NR	RACCORDO CORPO A "T" EO M-F(DKOL)-M 10L	FITTING BODY A "T" EO M-F (DKOL) M-10L
RD6	RD000600	NR	RACCORDO CORPO A "T" EO M-F(DKOL)-M 12L	FITTING BODY A "T" EO M-F (DKOL) M-12L
RD7	RD000700	NR	RACCORDO CORPO A "T" EO 8L M 14*1.5	FITTING BODY A "T" EO 8L M 14 * 1.5
RD8	RD000800	NR	RACCORDO CORPO A "T" EO 10L M 16*1.5	FITTING BODY A "T" M 10L EO 16 * 1.5
RD9	RD000900	NR	RACCORDO CORPO A "T" EO 28L M 36*2	FITTING BODY A "T" M 28L EO 36 * 2
RD10	RD001000	NR	RACCORDO CORPO A "T" EO 28L M 36*2	FITTING BODY A "T" EO M-F (DKOL) M-10L
RD11	RD001100	NR	RACCORDO CORPO A "T" EO M-F(DKOL)-M 10L	FITTING BODY A "T" EO M-F (DKOL) M-10L
RD12	RD001200	NR	ADATTATORE "T" GAS M-FG-M 1/4 1/4 1/4	ADAPTOR
RG1	RG000100	NR	RACCORDO CORPO A GOMITO 10L MASCH.-FEMM. DKOL	ELBOW FITTING BODY 10L Masch.-FEMM. DKOL
RG2	RG000200	NR	RACCORDO CORPO A GOMITO 12L MASCH.-FEMM. DKOL	ELBOW FITTING BODY 12L Masch.-FEMM. DKOL
RG3	RG000300	NR	RACCORDO CORPO A GOMITO 20S MASCHIO-FEMMINA DKOS	20S BODY FITTING ELBOW MALE-FEMALE DKOS
RG4	RG000400	NR	RACCORDO CORPO A GOMITO 28L MASCHIO-FEMMINA DKOL	28L BODY FITTING ELBOW MALE-FEMALE DKOL

POS	Codice	U.M.	 Descrizione	 Description
RG5	RG000500	NR	RACCORDO A L MASCHIO-FEMMINA 1/8	BODY 90 ° M / F 1/8 "
RG6	RG000600	NR	ADATTATORE 90° BSPP M-FG 1/4	ADAPTOR
RN1	RN000100	NR	RACCORDO CORPO D'ESTREMITA' TENUTA ED 8L * 3/8 GAS *K*	END FITTING WITH SEAL ED 8L * 3/8 GAS * K *
RN2	RN000200	NR	RACCORDO CORPO D'ESTREMITA' TENUTA ED 12L * 3/8 GAS *K*	END FITTING WITH SEAL ED 12L * 3/8 GAS * K *
RN3	RN000300	NR	RACCORDO CORPO D'ESTREMITA' TENUTA ED 10L * 3/8 GAS *K*	FITTING END OF BODY 'AND SEAL 10L * 3/8 GAS * K *
RN4	RN000400	NR	RACCORDO CORPO D'ESTREMITA' TENUTA ED 8L * 1/4 GAS *K*	END FITTING WITH SEAL ED 8L * 1/4 GAS * K *
RN5	RN000500	NR	RACCORDO CORPO D'ESTREMITA'TENUTA ED 10L * 1/4 GAS *K*	FITTING END OF BODY 'AND SEAL 10L * 1/4 GAS * K *
RN6	RN000600	NR	RACCORDO CORPO D'ESTREMITA' TENUTA ED 12L * 1/4 GAS	FITTING END OF BODY 'AND SEAL 12L * 1/4 GAS
RN7	RN000700	NR	RACCORDO NIPLES GAS CON.- GAS CON. 1/4" * 1/4"	FITTING
RN8	RN000800	NR	RACCORDO CORPO D'ESTREMITA' TENUTA ED 15L * 1/2 GAS *K*	END FITTING WITH SEAL ED 15L * 1/2 * K * GAS
RN9	RN000900	NR	RACCORDO CORPO D'ESTREMITA' TENUTA ED 10L * 1/2 GAS *K*	FITTING END OF BODY 'AND SEAL 10L * 1/2 * K * GAS
RN10	RN001000	NR	RACCORDO CORPO D'ESTREMITA' TENUTA ED 15L * 3/4 GAS *K*	END FITTING WITH SEAL ED 15L * 3/4 GAS * K *
RN11	RN001100	NR	RACCORDO CORPO D'ESTREMITA' TENUTA ED 12L * 1/2 GAS *K*	END FITTING WITH SEAL ED 12L * 1/2 GAS * K *
RN12	RN001200	NR	RACCORDO CORPO D'ESTR. TENUTA ED 8L * 1/2 GAS	END FITTING WITH SEAL ED 8L * 1/2 GAS
RN13	RN001300	NR	RACCORDO CORPO D'ESTR. TENUTA ED 8L * 3/4 GAS	CONNECTOR BODY OF EXTR. SEAL AND 8L * 3/4 GAS
RN14	RN001400	NR	RACCORDO CORPO D'ESTR. TENUTA ED 12L * 3/4 GAS	CONNECTOR BODY OF EXTR. SEAL AND 12L * 3/4 GAS

POS	Codice	U.M.	 Descrizione	 Description
RN15	RN001500	NR	RACCORDO CORPO D'ESTR. TENUTA ED 15L * 3/8 GAS	END FITTING WITH SEAL ED 15L * 3/8 GAS
RN16	RN001600	NR	RACCORDO CORPO D'ESTR. TENUTA ED 22L * 3/4 GAS	END FITTING WITH SEAL ED 22L * 3/4 GAS
RN17	RN001700	NR	RACCORDO CORPO D'ESTR. TENUTA ED 28L * 3/4" GAS	END FITTING WITH SEAL ED 28L * 3/4 BSP
RN18	RN001800	NR	RACCORDO CORPO D'ESTR. TENUTA ED 20S * 3/4 GAS	CONNECTOR BODY OF EXTR. SEAL AND 20S * 3/4 GAS
RN19	RN001900	NR	RACCORDO CORPO D'ESTREMITA' 8L * M 12X1.5 ED	END FITTING 8L * M 12x1.5 ED
RN20	RN002000	NR	RACCORDO CORPO D'ESTREMITA' 8L * M 14X1.5 ED	FITTING END OF BODY 'AND 8L * M 14x1.5
RN21	RN002100	NR	RACCORDO CORPO D'ESTREMITA' 10L * M 18X1.5 ED	END FITTING 10L * M 18x1.5
RN22	RN002200	NR	RACCORDO CORPO D'ESTR. TENUTA ED 15L * M 18X1.5	CONNECTOR BODY OF EXTR. SEAL AND 15L * M 18x1.5
RN23	RN002300	NR	RACCORDO CORPO D'ESTR. TENUTA ED 15L * M 22X1.5	END FITTING WIHT SEAL ED 15L * M 22x1.5
RN24	RN002400	NR	RACCORDO CORPO D'ESTR. TENUTA ED 22L * M26X1.5	CONNECTOR BODY OF EXTR. SEAL AND 22L * M26x1.5
RN25	RN002500	NR	RACCORDO CORPO D'ESTR. TENUTA ED 20S * M27X2	CONNECTOR BODY OF EXTR. SEAL AND 20S * M27X2
RN26	RN002600	NR	RACCORDO CORPO D'ESTR. 8L * 9/16-18 UNF-2A	END FITTING 8L * 9/16-18 UNF-2A
RN27	RN002700	NR	RACCORDO CORPO D'ESTR. 12L * 3/4 -16 UNF-2A	END FITTING 12L * 3/4 -16 UNF-2A
RN28	RN002800	NR	RACCORDO CORPO D'ESTR. 20S * 1.5/16 -12 UN-2A	END FITTING 20S * 1.5/16 -12 UN-2A
RN29	RN002900	NR	RACCORDO CORPO D'ESTR. TENUTA ED 22L * M26X1.5	END FITTING WITH SEAL ED 22L * M26x1.5
RN30	RN003000	NR	RACCORDO CORPO D'ESTR. TENUTA ED 22L * M26X1.5	END FITTING WITH SEAL ED 22L * M26x1.5
RN31	RN003100	NR	RACCORDO CORPO D'ESTREMITA' TENUTA ED 6L * 1/4 GAS *K*	END FITTING WITH SEAL 1/4 BSPP 6L

POS	Codice	U.M.	 Descrizione	 Description
RN32	RN003200	NR	RACCORDO CORPO D'ESTREMITA' TENUTA ED 8L * 3/8 GAS *K*	END FITTING WITH SEAL ED 8L * 3/8 GAS * K *
RN33	RN003300	NR	NIPPLES 1/8" JIS 1/8"GAS	CAP
RN34	RN003400	NR	NIPPLES 1/4" JIS 1/4"GAS	CAP
RN35	RN003500	NR	NIPPLES 3/8" JIS 1/4"GAS	CAP
RN36	RN003600	NR	NIPPLES 3/8" JIS 1/4"GAS	CAP
RO1	RO000100	NR	OGIVA PER TUBO Ø=12	OGIVE FOR TUBE Ø = 12
RR1	RR000100	NR	RONDELLA RAME 1/4	COPPER WASHER 1/4
RR2	RR000200	NR	RONDELLA BONDED GAS 3/8" *K*	BONDED WASHER GAS 3/8 " K *
RR3	RR000300	NR	RONDELLA BONDED METRICA 12 *K*	METRIC BONDED WASHER 12 * K *
RR4	RR000400	NR	RONDELLA BONDED GAS 1/4" *K*	BONDED WASHER GAS 1/4 " K *
RR5	RR000500	NR	RONDELLA BONDED GAS 1/2" *K*	BONDED WASHER GAS 1/2 " K *
RR6	RR000600	NR	RONDELLA RAME 3/8	COPPER WASHER 3/8
RR7	RR000700	NR	RONDELLA BONDED GAS 1/8" *K*	BONDED WASHER GAS 1/8 " K *
RR8	RR000800	NR	RONDELLA BONDED GAS 1" *K*	BONDED WASHER GAS 1 " K *
RR9	RR000900	NR	RONDELLA BONDED GAS 3/4" *K*	BONDED WASHER GAS 3/4 " K *
RR10	RR001000	NR	RONDELLA BONDED GAS 1.1/4"	BONDED WASHER GAS 1.1 / 4 "
RR11	RR001100	NR	RONDELLA RAME M10	COPPER WASHER M10
RR12	RR001200	NR	RONDELLA RAME 1/2	COPPER WASHER 1/2

POS	Codice	U.M.	 Descrizione	 Description
RR13	RR001300	NR	RONDELLA BONDED M12	BONDED WASHER M12
RS1	RS000100	NR	COPPIA SEMIFLANGE SAE 6000 3/4"	PAIR 6000 SAE flange halves 3/4 "
RS2	RS000200	NR	RACC.M 20S(M30x2) - ED M 1"5/16 UNF H=33	FITTING M 20S (M30x2) - ED M 1 "5/16 UNF H = 33
RS3	RS000300	NR	RIDUZIONE M-F GAS 1" * 1/2"	REDUCING GAS M-F 1 "*" 1/2"
RS4	RS000400	NR	RACCORDO COLONNETTA M15L - 3/8" GAS H=50	COLUMN CONNECTION M15L - 3/8 "GAS H = 50
RS5	RS000500	NR	RACCORDO COLONNETTA M15L - 3/8" GAS H=96	COLUMN CONNECTION M15L - 3/8 "GAS H = 96
RS6	RS000600	NR	CODOLO M1/4" ED X FG 8L (M14X1.5)	FITTING M1 / 4 "X AND FG 8L (M14X1.5)
RS7	RS000700	NR	RIDUZIONE M-F GAS 1" * 1/2"	REDUCING GAS M-F 1 "*" 1/2"
RS8	RS000800	NR	RACCORDO CODOLO D' ESTR. FEM. DKO 12I*3/8 GAS ED	END FITTING FEM. DKO 12I*3/8 GAS ED
RS9	RS000900	NR	MANICOTTO ARIA 1/8-1/8	AIR MANIFOLD 1/8-1/8
RS10	RS001000	NR	RIDUZIONE M-F GAS 3/8" JIS 1/8" BSPP	REDUCING GAS M-F 3/8" JIS 1/8" BSPP
RS11	RS001100	NR	RACCORDO M-M 15L	FITTING M-M 15L
RS12	RS001200	NR	RACCORDO NIPLES GAS CON.- GAS CON.1/2"1/2"	FITTING 1/2" - 1/2"
RT1	RT000100	NR	TAPPO MASCHIO TE GAS 3/8" SVASATO 60° *K*	SCREW EYE FOR GAS 1/2 "H = 50
RT2	RT000200	NR	TAPPO MASCHIO ESAGONO INTERNO GAS 1/4" SVASATO 60° *K*	MALE PLUG GAS INTERNAL HEX 1/4 "FLARE 60 ° * K *
RT3	RT000300	NR	TAPPO MASCHIO TE GAS 1/2" SVASATO 60° *K*	MALE PLUG TE GAS 1/2 "FLARE 60 ° * K *
RT4	RT000400	NR	TAPPO MASCHIO TE GAS 1/4" SVASATO 60° *K*	MALE PLUG TE GAS 1/4 "FLARE 60 ° * K *

POS	Codice	U.M.	 Descrizione	 Description
RT5	RT000500	NR	TAPPO MASCHIO ESAGONO INTERNO GAS 3/8" SVASATO 60° *K*	MALE PLUG GAS INTERNAL HEX 3/8 "FLARE 60 ° * K *
RT6	RT000600	NR	TAPPO MASCHIO ESAGONO INTERNO GAS 1" SVASATO 60° *K*	MALE PLUG GAS INTERNAL HEX 1 "FLARE 60 ° * K *
RT7	RT000700	NR	TAPPO MASCHIO TE GAS 1/8" SVASATO 60° *K*	MALE PLUG TE GAS 1/8 "FLARE 60 ° * K *
RT8	RT000800	NR	TAPPO MASCHIO TE GAS 1/4" JIS	MALE PLUG TE GAS 1/4 " JIS
RV1	RV000100	NR	VITE PER OCCHIO GAS 1/4" H=29 *K*	SCREW EYE FOR GAS 1/4 "H = 29 * K *
RV2	RV000200	NR	VITE PER OCCHIO DOPPIA GAS 3/8"	SCREW EYE DOUBLE FOR GAS 3/8 "
RV3	RV000300	NR	VITE PER OCCHIO GAS 1/2" H= 50	SCREW EYE FOR GAS 1/2 "H = 50
RV4	RV000400	NR	VITE PER OCCHIO DOPPIA GAS 1/4"	DOUBLE EYE SCREW FOR GAS 1/4"
RV5	RV000500	NR	VITE PER OCCHIO GAS 3/8"	SCREW EYE FOR GAS 3/8"
RV6	RV000600	NR	VITE PER OCCHIO GAS 1/8"	SCREW EYE FOR GAS 1/8"

**CALIFORNIAN PROPOSITION 65  
BATTERY WARNING**

**Battery posts, terminals  
and related accessories  
contain lead and lead  
compounds, chemicals  
known to the State of  
California to cause cancer  
and reproductive harm.**

**Batteries also contain other  
harmful chemicals known  
to the State of California.**

**WASH HANDS  
AFTER HANDLING!**

Go to Discount-Equipment.com to order your parts



# PARTS FINDER

**Search Website  
by Part Number**



**Search Manual  
Library For Parts  
Manual & Lookup Part  
Numbers – Purchase  
or Request Quote**

**Search Manuals**

Enter your information to search for a manual or to purchase a manual or parts.

\* Brand:

\* Model:

\* Serial:

\* Part Number:

SEARCH

**Can't Find Part or  
Manual? Request Help  
by Manufacturer,  
Model & Description**

**Parts Order Form**

Please fill in the following information:

Manufacturer:

Model:

Description:

Quantity:

Part Number:

Part Name:

Part Description:

Part Category:

Part Location:

Part Status:

Part Condition:

Part Material:

Part Color:

Part Weight:

Part Dimensions:

Part Price:

Part Notes:

Submit

Discount-Equipment.com is your online resource for quality parts & equipment.

Florida: **561-964-4949** Outside Florida TOLL FREE: **877-690-3101**

**Need parts?**

Click on this link: <http://www.discount-equipment.com/category/5443-parts/> and choose one of the options to help get the right parts and equipment you are looking for. Please have the machine model and serial number available in order to help us get you the correct parts. If you don't find the part on the website or on one of the online manuals, please fill out the request form and one of our experienced staff members will get back to you with a quote for the right part that your machine needs.

We sell worldwide for the brands: Genie, Terex, JLG, MultiQuip, Mikasa, Essick, Whiteman, Mayco, Toro Stone, Diamond Products, Generac Magnum, Airman, Haulotte, Barreto, Power Blanket, Nifty Lift, Atlas Copco, Chicago Pneumatic, Allmand, Miller Curber, Skyjack, Lull, Skytrak, Tsurumi, Husquvarna Target, Stow, Wacker, Sakai, Mi-T-M, Sullair, Basic, Dynapac, MBW, Weber, Bartell, Bennar Newman, Haulotte, Ditch Runner, Menegotti, Morrison, Contec, Buddy, Crown, Edco, Wyco, Bomag, Laymor, EZ Trench, Bil-Jax, F.S. Curtis, Gehl Pavers, Heli, Honda, ICS/PowerGrit, IHI, Partner, Imer, Clipper, MMD, Koshin, Rice, CH&E, General Equipment, Amida, Coleman, NAC, Gradall, Square Shooter, Kent, Stanley, Tamco, Toku, Hatz, Kohler, Robin, Wisconsin, Northrock, Oztec, Toker TK, Rol-Air, APT, Wylie, Ingersoll Rand / Doosan, Innovatech, Con X, Ammann, Mecalac, Makinex, Smith Surface Prep, Small Line, Wanco, Yanmar