



An Oshkosh Corporation Company



Illustrated Parts Manual

Compact Crawler

X17JP/2

X17JP/3

X500AJ/2

X500AJ/3



3121602
July 21, 2016

PARTS FINDER

**Search Website
by Part Number**



**Search Manual
Library For Parts
Manual & Lookup Part
Numbers – Purchase
or Request Quote**

Search Manuals

Enter your information to search for a manual or to purchase a manual or parts.

* Brand:

* Model:

* Serial:

* Part Number:

SEARCH

**Can't Find Part or
Manual? Request Help
by Manufacturer,
Model & Description**

Parts Order Form

Please fill in the following information to request help finding a part or manual.

Manufacturer:

Model:

Description:

Quantity:

Part Number:

Part Name:

Part Description:

Part Category:

Part Location:

Part Status:

Part Condition:

Part Material:

Part Color:

Part Weight:

Part Dimensions:

Part Price:

Part Availability:

Part Lead Time:

Part Notes:

Submit

Discount-Equipment.com is your online resource for quality parts & equipment.

Florida: **561-964-4949** Outside Florida TOLL FREE: **877-690-3101**

Need parts?

Click on this link: <http://www.discount-equipment.com/category/5443-parts/> and choose one of the options to help get the right parts and equipment you are looking for. Please have the machine model and serial number available in order to help us get you the correct parts. If you don't find the part on the website or on one of the online manuals, please fill out the request form and one of our experienced staff members will get back to you with a quote for the right part that your machine needs.

We sell worldwide for the brands: Genie, Terex, JLG, MultiQuip, Mikasa, Essick, Whiteman, Mayco, Toro Stone, Diamond Products, Generac Magnum, Airman, Haulotte, Barreto, Power Blanket, Nifty Lift, Atlas Copco, Chicago Pneumatic, Allmand, Miller Curber, Skyjack, Lull, Skytrak, Tsurumi, Husquvarna Target, Stow, Wacker, Sakai, Mi-T-M, Sullair, Basic, Dynapac, MBW, Weber, Bartell, Bennar Newman, Haulotte, Ditch Runner, Menegotti, Morrison, Contec, Buddy, Crown, Edco, Wyco, Bomag, Laymor, EZ Trench, Bil-Jax, F.S. Curtis, Gehl Pavers, Heli, Honda, ICS/PowerGrit, IHI, Partner, Imer, Clipper, MMD, Koshin, Rice, CH&E, General Equipment, Amida, Coleman, NAC, Gradall, Square Shooter, Kent, Stanley, Tamco, Toku, Hatz, Kohler, Robin, Wisconsin, Northrock, Oztec, Toker TK, Rol-Air, APT, Wylie, Ingersoll Rand / Doosan, Innovatech, Con X, Ammann, Mecalac, Makinex, Smith Surface Prep, Small Line, Wanco, Yanmar

 SOTTOCARRO CINGOLATO

RAUPENFAHRWERK 

 TRACKED UNDERCARRIAGE

CARRO DE ORUGAS 

 CHENILLARD

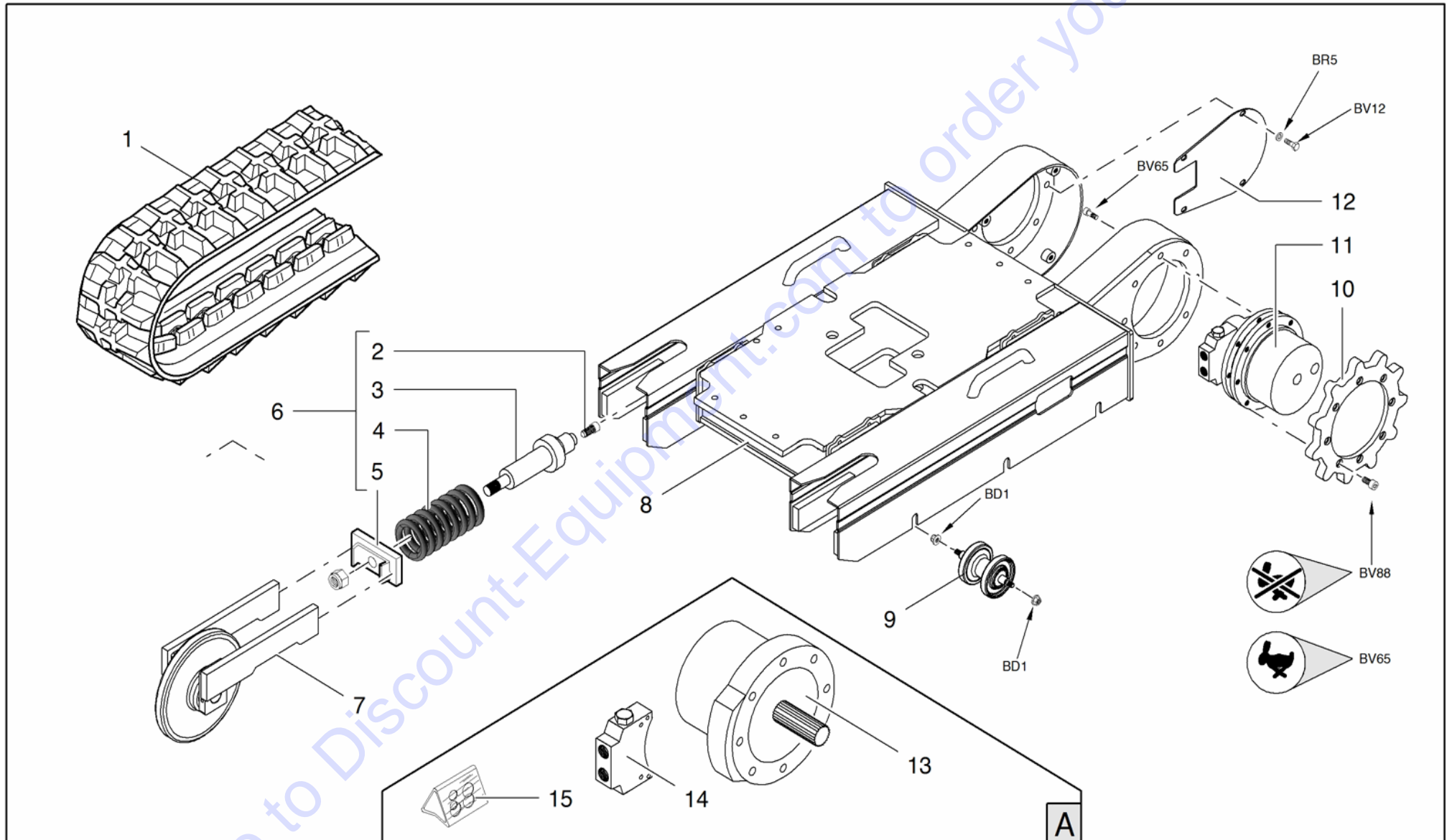





 SOTTOCARRO CINGOLATO

 RAUPENFAHRWERK

 TRACKED UNDERCARRIAGE

 CARRO DE ORUGAS

 CHENILLARD

| POS Codice | Q.tà |  Descrizione |  Description |  Designation |  Benennung |  Descripcìon |
|-------------|------|---|---|---|---|---|
| 1 053715L0 | 2 NR | CINGOLO IN GOMMA BASSO PROFILO NERO | RUBBER TRACK LOW PROFILE BLACK | CHENILLE EN CAOUTCHOUC | GUMMIRAUPE | ORUGA DE GOMA |
| 1 053715LB | 2 NR | CINGOLO IN GOMMA BASSO PROFILO ANTITRACCIA | RUBBER TRACK LOW PROFILE NO MARKING | CHENILLE EN CAOUTCHOUC | GUMMIRAUPE | ORUGA DE GOMA |
| 2 03149200 | 1 NR | VALVOLA IDRAULICA | HYDRAULIC VALVE | VALVE HYDRAULIQUE | HYDRAULIKVENTIL | VÁLVULA HIDRÁULICA |
| 3 10681670 | 1 NR | CILINDRO | CYLINDER | VÉRIN | ZYLINDER | CILINDRO |
| 4 03024800 | 1 NR | MOLLA | SPRING | RESSORT | FEDER | MUELLE |
| 5 34719500 | 1 NR | PIATTO | PLATE | PLATEAU | PLATTE | PLACA |
| 6 147534Y1 | 2 NR | SUPPORTO TENDICINGOLO | IDLER SUPPORT | SUPPORT TENDEUR CHENILLE | KETTEHSPANNERHALTER | SOPORTE TENSOR ORUGA |
| 7 153937H2 | 2 NR | RUOTA TENDICINGOLO | IDLER WHEEL | ROUE TENDEUR DE CHENILLE | RAUPENSPANNRAD | RUEDA TENSOR ORUGA |
| 8 15603000 | 1 NR | SOTTOCARRO CINGOLATO | TRACKED UNDERCARRIAGE | CHENILLARD | RAUPENFAHRWERK | CARRO CON ORUGAS |
| 9 153515H2 | 6 NR | RULLO INFERIORE | CARRIER ROLLER | ROULEAU INFÉRIEUR | UNTERE ROLLER | RODILLO INFERIOR |
| 10 055707H2 | 2 NR | RUOTA DI TRAZIONE | SPROCKET WHEEL | ROUE DE TRACTION | ANTRIEBSRAD | RUEDA DE ARRASTRE |





 SOTTOCARRO CINGOLATO

RAUPENFAHRWERK 

 TRACKED UNDERCARRIAGE

CARRO DE ORUGAS 

 CHENILLARD

| POS Codice | Q.tà |  Descrizione |  Description |  Designation |  Benennung |  Descripcìon |
|-------------|------|---|---|---|---|---|
| 11 267525H2 | 2 NR | MOTORIDUTTORE 700C2K I:32 + MAG12 VP AUTO2SPEED CON FRENO | GEAR MOTOR 700C2K I: 32 + MAG12 VP AUTO2SPEED WITH BRAKE | MOTORÉDUCTEU R | GETRIEBEMOTOR | MOTORREDUCTO R |
| 12 054868H2 | 2 NR | COPERCHIO 2 VELOCITÀ | COVER HIGH SPEED | COUVERCLE | TAPA | DEKSEL |

Go to Discount-Equipment.com to order your parts

 ALLARGAMENTO IDRAULICO

 HYDRAULIC EXTENSION



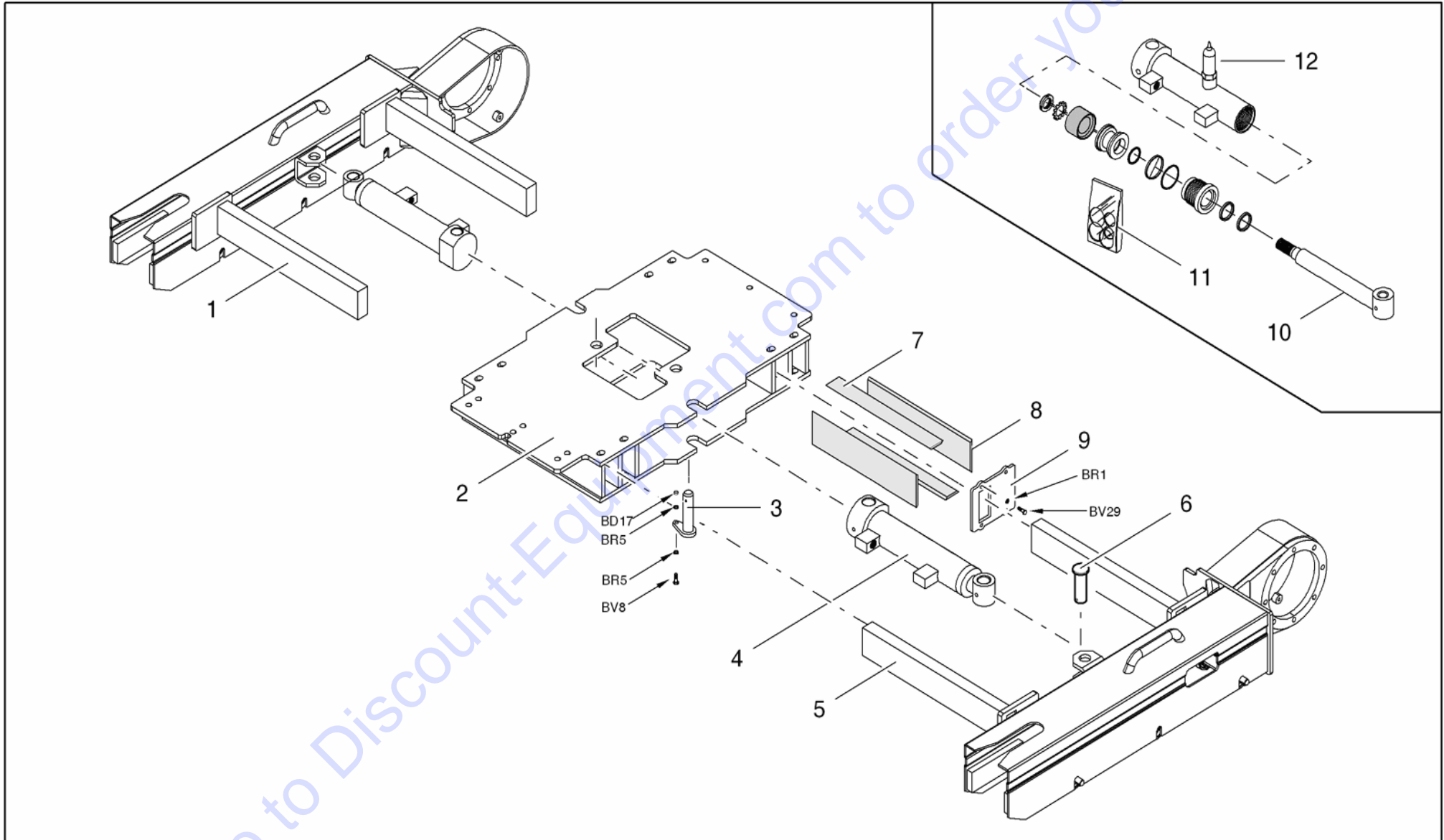

 ECARTEMENT HYDRAULIQUE

HYDR. SPURWEITENVER STELLEINRICHTUNG 

EXTENSION HIDRAULICA 







 ALLARGAMENTO IDRAULICO
HYDR. SPURWEITENVER STELLEINRICHTUNG 
 HYDRAULIC EXTENSION
EXTENSION HIDRAULICA 
 ECARTEMENT HYDRAULIQUE

| POS Codice | Q.tà |  Descrizione |  Description |  Designation |  Benennung |  Descripción |
|---------------|------|---|---|---|---|---|
| 1 35603000 | 1 NR | ASSIEME LONGHERONE DESTRO 2 VELOCITÀ | RIGHT SIDE FRAME ASSEMBLY HIGH SPEED | ENSEMBLE CHÂSSIS LATÉRAL LONGERON DROIT | LÄNGSTRÄGERB AUGRUPPE RECHTS | CONJUNTO LARGUERO DERECHO |
| 2 35385300 | 1 NR | STRUTTURA | STRUCTURE | STRUCTURE | STRUKTUR | ESTRUCTURA |
| 3 05419700 | 2 NR | SPINA | PIN | CHEVILLE | STIF | CLAVIJA |
| 4 17178100 | 2 NR | CILINDRO | CYLINDER | CYLINDER | ZYLINDER | CILINDRO |
| 4 171781H2 | 2 NR | CILINDRO | CYLINDER | CYLINDER | ZYLINDER | CILINDRO |
| 5 35603100 | 1 NR | ASSIEME LONGHERONE SINISTRO 2 VELOCITÀ | LEFT SIDE FRAME ASSEMBLY HIGH SPEED | ENSEMBLE CHÂSSIS LATÉRAL LONG. GAUCHE | LÄNGSTRÄGERB AUGRUPPE LINKS | CONJUNTO LARGUERO IZQUIERDO |
| 6 04256300 | 2 NR | SPINA | PIN | CHEVILLE | STIFT | CLAVIJA |
| 7 04624900 | 8 NR | GUIDA ALLARGAMENTO | EXPANSION GUIDE | GLISSIÈRE ÉLARGISSEMENT | FÜHRUNGSVERB REITERUNG | GUÍA DE EXTENSIÓN |
| 8 04624800 | 8 NR | GUIDA ALLARGAMENTO | EXPANSION GUIDE | GLISSIÈRE ÉLARGISSEMENT | FÜHRUNGSVERB REITERUNG | GUÍA DE EXTENSIÓN |
| 9 346108H2 | 4 NR | COPERCHIO | COVER | COUVERCLE | DECKEL | TAPA |
| 10 1717810002 | 1 NR | STELO ALLARGAMENTO CARRO | ROD CYLINDER ENLARGEMENT | TIGE D'EXTENSION CAMION | VERLÄNGERUNG SSTANGE TRUCK | EXTENSION ROD TRUCK |

 ALLARGAMENTO IDRAULICO

 HYDR. SPURWEITENVER STELLEINRICHTUNG 
 HYDRAULIC EXTENSION

 EXTENSION HIDRAULICA 
 ECARTEMENT HYDRAULIQUE

| POS Codice | Q.tà |  Descrizione |  Description |  Designation |  Benennung |  Descripción |
|---------------|------|---|---|---|---|---|
| 11 1717810001 | 1 NR | KIT GUARNIZIONI CILINDRO ALLARGAMENTO CARRO | ENLARGEMENT CYLINDER GASKET KIT | ÉLARGISSEMENT CAMION KIT CYLINDRE JOINT | ERWEITERUNG CYLINDER GASKET KIT TRUCK | PLIACIÓN DE JUNTAS CILINDRO TRUCK KIT |
| 12 17329500 | 2 NR | MICROINTERRUTT ORE ALLARGAMENTO CARRO N/O COMPLETO DI CAVO E CONNETTORE | WIDENING SYSTEM MICRO SWITCH N/O CONTACT WITH CABLE AND CONNECTOR | MICRO INTERRUPTEUR ELARGISSEMENT AVEC CABLE ET CONNECTEUR | MIKROSCHALTER SPURVERBREITE RUNG MIT KABEL UND STECKER | MICROINTERRUP TOR ENSANCHAMIENT O CON CABLE Y CONECTOR |
| 12 17329500 | 1 NR | MICROINTERRUTT ORE ALLARGAMENTO CARRO N/O COMPLETO DI CAVO E CONNETTORE | WIDENING SYSTEM MICRO SWITCH N/O CONTACT WITH CABLE AND CONNECTOR | MICRO INTERRUPTEUR ELARGISSEMENT AVEC CABLE ET CONNECTEUR | MIKROSCHALTER SPURVERBREITE RUNG MIT KABEL UND STECKER | MICROINTERRUP TOR ENSANCHAMIENT O CON CABLE Y CONECTOR |

 BASE TORRETTA

ARBEITSTURM 



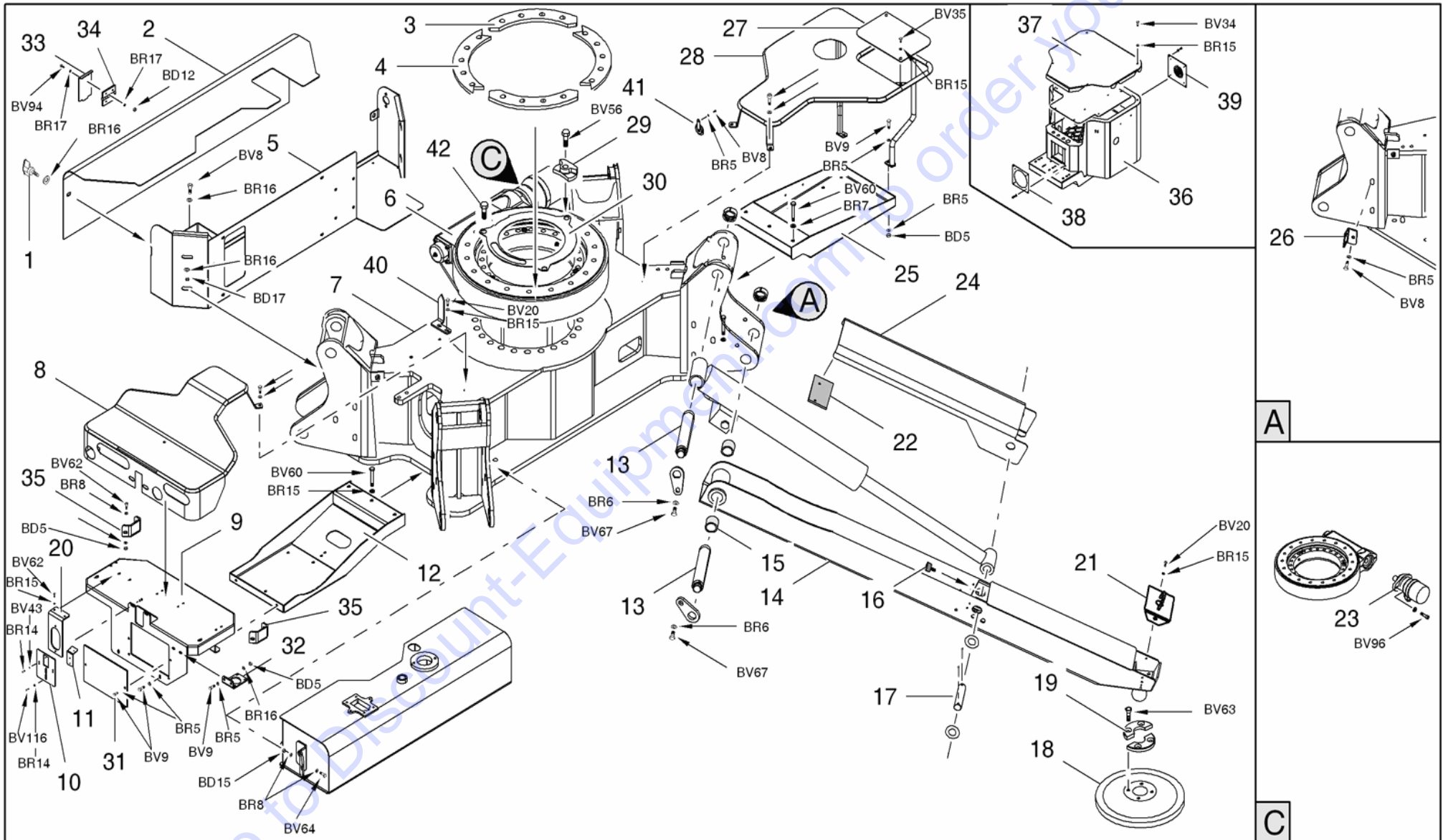

 TURRET BASE

BASE TORRETA GIRATORIA 





 BASE TOURELLE







 BASE TORRETTA
ARBEITSTURM 
 TURRET BASE
BASE TORRETA GIRATORIA 
 BASE TOURELLE

| POS Codice | Q.tà |  Descrizione |  Description |  Designation |  Benennung |  Descripción |
|------------|------|---|---|---|---|---|
| 1 05611000 | 3 NR | GALLETTO | WING NUT | ECROU PAPILLON | FLÜGELMUTTER | TUERCA DE MARIPOSA |
| 2 076839J2 | 1 NR | COPERCHIO MK2 (DA C170000893) | COVER MK2 (FROM C170000893) | | | |
| 2 372285J0 | 1 NR | SALDATO COPERCHIO COMPONENTI ELETTRICI | WELDED COVER ELECTRICAL COMPONENTS | COUVERCLE | DECKEL | TAPA |
| 3 069349Y1 | 2 NR | SPESSORE | THICKNESS | CALE | STÄRKE | ESPEJOR |
| 4 069348Y1 | 2 NR | SPESSORE | THICKNESS | CALE | STÄRKE | ESPEJOR |
| 5 376840J2 | 1 NR | SCATOLA COMPONENTI ELETTRICI MK2 (DA C170000893) | ELECTRIC COMPONENTS BOX MK2 (FROM C170000893) | BOÎTE COMPOSANTS ÉLECTRIQUES MK2 (FROM C170000893) | ELEKTROKOMPO NENTENGEHÄUS E MK2 (FROM C170000893) | CAJA DE COMPONENTES ELÉCTRICOS MK2 (FROM C170000893) |
| 5 371389J0 | 1 NR | SCATOLA ELETTRICA | ELECTRIC BOX | BOÎTE ÉLECTRIQUE | ELEKTROGEHÄU SE | CAJA ELÉCTRICA |
| 6 261191H2 | 1 NR | RALLA | FIFTH WHEEL | COURONNE DENTÉE | DREHKRANZ | TEJUELO |
| 7 371317H2 | 1 NR | BASE PIATTAFORMA | PLATFORM BASE | BASE PLATEFORME | ARBEITSBÜHNEN UNTERGESTELL | BASE PLATAFORMA |





 BASE TORRETTA
ARBEITSTURM 
 TURRET BASE
BASE TORRETA GIRATORIA 
 BASE TOURELLE

| POS Codice | Q.tà |  Descrizione |  Description |  Designation |  Benennung |  Descripción |
|-------------|------|---|---|---|---|---|
| 8 371400J0 | 1 NR | PROTEZIONE | PROTECTION | PROTECTION | SCHUTZ | PROTECCIÓN |
| 8 371400J2 | 1 NR | PROTEZIONE | PROTECTION | PROTECTION | SCHUTZ | PROTECCIÓN |
| 8 371400Y1 | 1 NR | PROTEZIONE | PROTECTION | PROTECTION | SCHUTZ | PROTECCIÓN |
| 9 068863J0 | 1 NR | LAMA DI FISSAGGIO | FIXING BLADE | LAME DE FIXAGE | BEFESTIGUNGSS CHILD | LAMA FIJACIÓN |
| 9 068863J2 | 1 NR | LAMA DI FISSAGGIO | FIXING BLADE | LAME DE FIXAGE | BEFESTIGUNGSS CHILD | LAMA FIJACIÓN |
| 10 061187Y1 | 1 NR | PIASTRA | PLATE | PLAQUE | PLATTE | PLACA |
| 11 061185Y1 | 1 NR | LAMIERA PIEGATA | FOLDED PLATE | TÔLE PLIÉE | BLECH GEBOGEN | CHAPA DOBLADA |
| 12 371398J0 | 1 NR | SUPPORTO MOTORE ELETTRICO SALDATO | WELDED SUPPORT ELECTRIC MOTOR | SUPPORT | HALTERUNG | SOPORTE |
| 12 371398J2 | 1 NR | SUPPORTO MOTORE ELETTRICO SALDATO | WELDED SUPPORT ELECTRIC MOTOR | SUPPORT | HALTERUNG | SOPORTE |
| 13 07131600 | 4 NR | SPINA | PIN | CHEVILLE | STIF | CLAVIJA |





 BASE TORRETTA
ARBEITSTURM 
 TURRET BASE
BASE TORRETA GIRATORIA 
 BASE TOURELLE

| POS Codice | Q.tà |  Descrizione |  Description |  Designation |  Benennung |  Descripcìon |
|-------------|---------|---|---|---|---|---|
| 14 171392J0 | 4 NR | STABILIZZATORE COMPLETO | COMPLETE STABILIZER | STABILISATEUR COMPLET | STABILIZER KOMPLETT | ESTABILIZADOR COMPLETO |
| 14 171392J2 | 4 NR | STABILIZZATORE COMPLETO | COMPLETE STABILIZER | STABILISATEUR COMPLET | STABILIZER KOMPLETT | ESTABILIZADOR COMPLETO |
| 15 06272800 | 2 NR | BOCCOLA | BUSH | DOUILLE | BUCHSE | CASQUILLO |
| 16 05876400 | 4 NR | ANTIVIBRANTE | ANTI-VIBRATING | ANTI - VIBRANT | VIBRATIONS DÄM PFER | ANTIVIBRANTE |
| 17 06236400 | 4 NR | SPINA | PIN | CHEVILLE | STIF | CLAVIJA |
| 18 05446300 | 4 NR | DISCO | DISK | DISQUE | SCHEIBE | DISCO |
| 19 054464Y1 | 8 NR | SEMIFLANGIA | HALF FLANGE | DEMI-BRIDE | HALB FLANSCH | SEMI BRIDA |
| 20 06891000 | 1 NR | STAFFA | BRACKET | ÉTRIER | HALTEBÜGEL | ESTRIBO |
| 20 076966H3 | 1 NR | CARTER PROTEZIONE CENTRALINO MK2 (DA C170000893) | CARTER PROTECTION SWITCHBOARD MK2 (FROM C170000893) | | | |
| 21 35933000 | 4 NR | SUPPORTO | SUPPORT | SUPPORT | HALTERUNG | SOPORTE |
| 21 376834H2 | 4 NR | SUPPORTO | SUPPORT | SUPPORT | HALTERUNG | SOPORTE |
| 22 07495600 | 0,42 NR | GOMMA ADESIVA DI PROTEZIONE | RUBBER ADHESIVE PROTECTION | GOMME ADHESIVE DE PROTECTION | SCHUTZ-KLEBEG UMMI | GOMA ADHESIVA DE PROTECCIÓN |





 BASE TORRETTA
ARBEITSTURM 
 TURRET BASE
BASE TORRETTA GIRATORIA 
 BASE TOURELLE

| POS Codice | Q.tà |  Descrizione |  Description |  Designation |  Benennung |  Descripción |
|-------------|------|---|---|---|---|---|
| 23 261308H2 | 1 NR | MOTORE DI ROTAZIONE | ROTARY MOTOR | MOTEUR DE ROTATION | ROTATIONSMOTO R | MOTOR DE ROTACIÓN |
| 23 275993H2 | 1 NR | MOTORE DI ROTAZIONE MK2 (DA C170000893) | ROTARY MOTOR MK2 (FROM C170000893) | MOTEUR DE ROTATION MK2 (FROM C170000893) | ROTATIONSMOTO R MK2 (FROM C170000893) | MOTOR DE ROTACIÓN MK2 (FROM C170000893) |
| 24 059328H2 | 2 NR | PROTEZIONE DESTRA | PROTECTION RIGHT | PROTECTION DROITE | SCHUTZ RECHT | PROTECCIÓN |
| 24 059591H2 | 2 NR | PROTEZIONE SINISTRA | PROTECTION LEFT | PROTECTION GAUCHE | SCHUTZ LINK | PROTECCIÓN |
| 25 371407J0 | 1 NR | SUPPORTO MOTORE HONDA SALDATO | WELDED SUPPORT HONDA ENGINE | SUPPORT | HALTERUNG | SOPORTE |
| 25 371407J2 | 1 NR | SUPPORTO | SUPPORT | SUPPORT | HALTERUNG | SOPORTE |
| 25 371409J0 | 1 NR | SUPPORTO | SUPPORT | SUPPORT | HALTERUNG | SOPORTE |
| 25 371409J2 | 1 NR | SUPPORTO MOTORE DIESEL | DIESEL ENGINE SUPPORT | SUPPORT | HALTERUNG | SOPORTE |
| 26 055629H3 | 1 NR | STAFFA | BRACKET | ÉTRIER | HALTEBÜGEL | ESTRIBO |
| 27 07141100 | 1 NR | COPERCHIO FILTRO ARIA MOTORE HONDA | AIR FILTER COVER HONDA MOTOR | COUVERCLE | DECKEL | TAPA |

 BASE TORRETTA
ARBEITSTURM 
 TURRET BASE
BASE TORRETA GIRATORIA 
 BASE TOURELLE

| POS Codice | Q.tà |  Descrizione |  Description |  Designation |  Benennung |  Descripcìon |
|-------------|------|---|---|---|---|---|
| 28 171449J0 | 1 NR | ASSIEME PROTEZIONE MOTORE HONDA COMPLETA | HONDA MOTOR PROTECTION | PROTECTION | SCHUTZ | PROTECCIÓN |
| 28 171449J2 | 1 NR | PROTEZIONE | PROTECTION | PROTECTION | SCHUTZ | PROTECCIÓN |
| 28 371453J0 | 1 NR | PROTEZIONE MOTORE DIESEL | PROTECTION DIESEL ENGINE | PROTECTION MOTEUR DIESEL | DIESEL MOTOR SCHUTZ | PROTECCIÓN DEL MOTOR DIESEL |
| 28 371453J2 | 1 NR | PROTEZIONE MOTORE DIESEL | PROTECTION DIESEL ENGINE | PROTECTION | SCHUTZ | PROTECCIÓN |
| 29 068911Y1 | 1 NR | FERMO | RETAINER | ARRÊT | HALTERUNG | BLOQUE |
| 30 068887Y1 | 1 NR | RISCONTRO | FASTENER LOCATOR | PLAQUE POUR AGRAFAGE | ANSCHLAG | GANCHO |
| 31 070025H2 | 1 NR | CARTER | SUMP | CARTER | KURBELGEHÄUS E | CÁRTER |
| 32 06958700 | 1 NR | PIEGATO FISSAGGIO SPINA ELETTRICA 16A | FIXING FOLDED ELECTRIC PLUG 16A | TÔLE PLIÉE | BLECH GEBOGEN | CHAPA DOBLADA |
| 33 072282J2 | 1 NR | COPERCHIO | COVER | COUVERCLE | DECKEL | TAPA |
| 33 072282J0 | 1 NR | COPERCHIO | COVER | COUVERCLE | DECKEL | TAPA |

 BASE TORRETTA
ARBEITSTURM 
 TURRET BASE
BASE TORRETTA GIRATORIA 
 BASE TOURELLE

| POS Codice | Q.tà |  Descrizione |  Description |  Designation |  Benennung |  Descripción |
|-------------|------|---|---|---|---|---|
| 34 07178700 | 4 NR | CERNIERA CON CONTROLLO DELLA POSIZIONE | HINGES WITH POSITION CONTROL | CHARNIÈRE | SCHARNIER | BISAGRA |
| 34 07189900 | 1 NR | CERNIERA A OSCILLAZIONE LIBERA | HINGE SWING FREE | CHARNIÈRE | SCHARNIER | BISAGRA |
| 35 071918H3 | 2 NR | LAMIERA PIEGATA | FOLDED PLATE | TÔLE PLIÉE | BLECH GEBOGEN | CHAPA DOBLADA |
| 36 36851000 | 1 NR | CASSONE | DUMPER BED | CAISSON | DUMPERMULDE | CAJON |
| 37 06853100 | 1 NR | COPERCHIO | COVER | COUVERCLE | DECKEL | TAPA |
| 38 06779900 | 1 NR | TAPPO VENTOLA ANTERIORE | CAP FRONT FAN | BOUCHON | VERSCHLUSS | TAPÓN |
| 39 06780800 | 1 NR | TAPPO VENTOLA POSTERIORE | CAP REAR FAN | BOUCHON | VERSCHLUSS | TAPÓN |
| 40 059679D2 | 1 NR | INDICE ALLINEAMENTO FISSO | FIXED ALIGNMENT INDICATOR | INDICATEUR D'ALIGNEMENT FIXE | FIXE AUSRICHTUNGSA NZEIGE | INDICADOR ALINEACIÓN FIJO |
| 41 04834500 | 1 NR | AVVISATORE ACQUSTICO | ACOUSTIC ALARM | BUZZER | SUMMER | ZUMBADOR |
| 42 06550100 | 1 NR | VITE M16X20 TESTA RIBASSATA | REDUCED HEAD SCREW M16X20 | BAISSE VIS À TÊTE M16X20 | GESENKTEN KOPF SCREW M16X20 | BAJADO TORNILLO CABEZA M16X20 |

🇮🇹 SERBATOIO OLIO

ÖLTANK 🇩🇪

🇬🇧 OIL TANK

DEPÓSITO DE ACEITE 🇪🇸



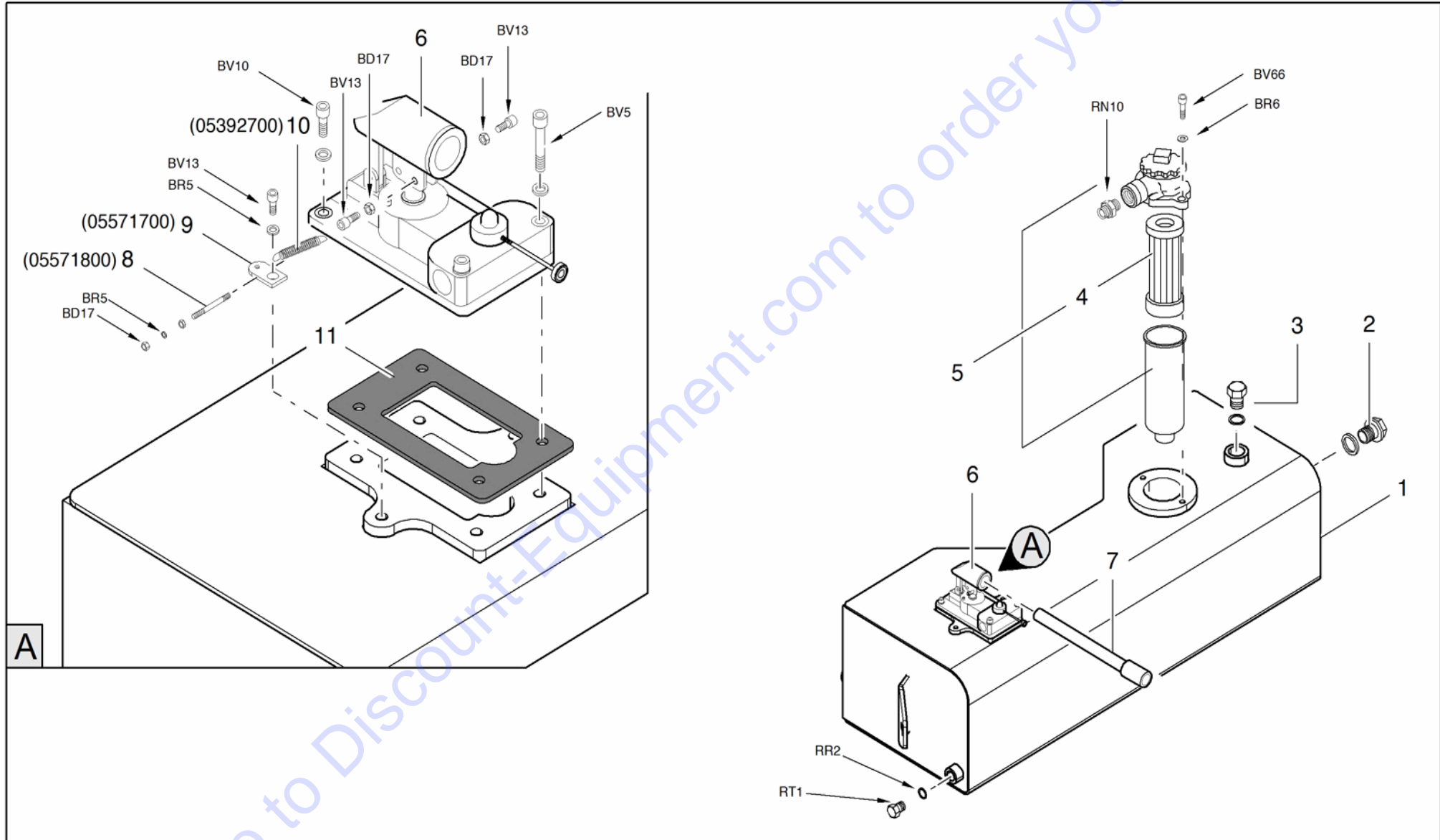

🇫🇷 RÉSERVOIR D'HUILE



 SERBATOIO OLIO

 ÖLTANK 
 OIL TANK

 DEPÓSITO DE ACEITE 
 RÉSERVOIR D'HUILE

| POS Codice | Q.tà |  Descrizione |  Description |  Designation |  Benennung |  Descripción |
|------------|------|---|---|---|---|---|
| 1 173164J0 | 1 NR | SERBATOIO OLIO | OIL TANK | RÉSERVOIR D'HUILE | ÖLTANK | DEPÓSITO DE ACEITE |
| 1 173164J2 | 1 NR | SERBATOIO OLIO | OIL TANK | RÉSERVOIR D'HUILE | ÖLTANK | DEPÓSITO DE ACEITE |
| 2 05061800 | 1 NR | LIVELLO OLIO | OIL LEVEL | NIVEAU HUILE | ÖLSTAND | NIVEL ACEITE |
| 3 05611800 | 1 NR | TAPPO OLIO | OIL PLUG | BOUCHON D'HUILE | ÖLDECKEL | TAPÓN ACEITE |
| 4 05120200 | 1 NR | CARTUCCIA FILTRO OLIO IDRAULICO | OIL FILTER INSERT | CARTOUCHE FILTRE À HUILE | ÖLFILTEREINSAT Z | CARTUCHO FILTRO ACEITE |
| 5 15120100 | 1 NR | FILTRO OLIO IDRAULICO COMPLETO | COMPLETE HYDRAULIC OIL FILTER | FILTRE À HUILE | HYDARULIKÖLFIL TER | FILTRO ACEITE HIDRÁULICO |
| 6 27316300 | 1 NR | POMPA A MANO | HAND PUMP | POMPE MANUELLE | HANDPUMPE | BOMBA DE MANO |
| 7 05521300 | 1 NR | LEVA | LEVER | LEVIER | HEBEL | PALANCA |

 PRIMO BRACCIO

ERSTER AUSLEGERARM 



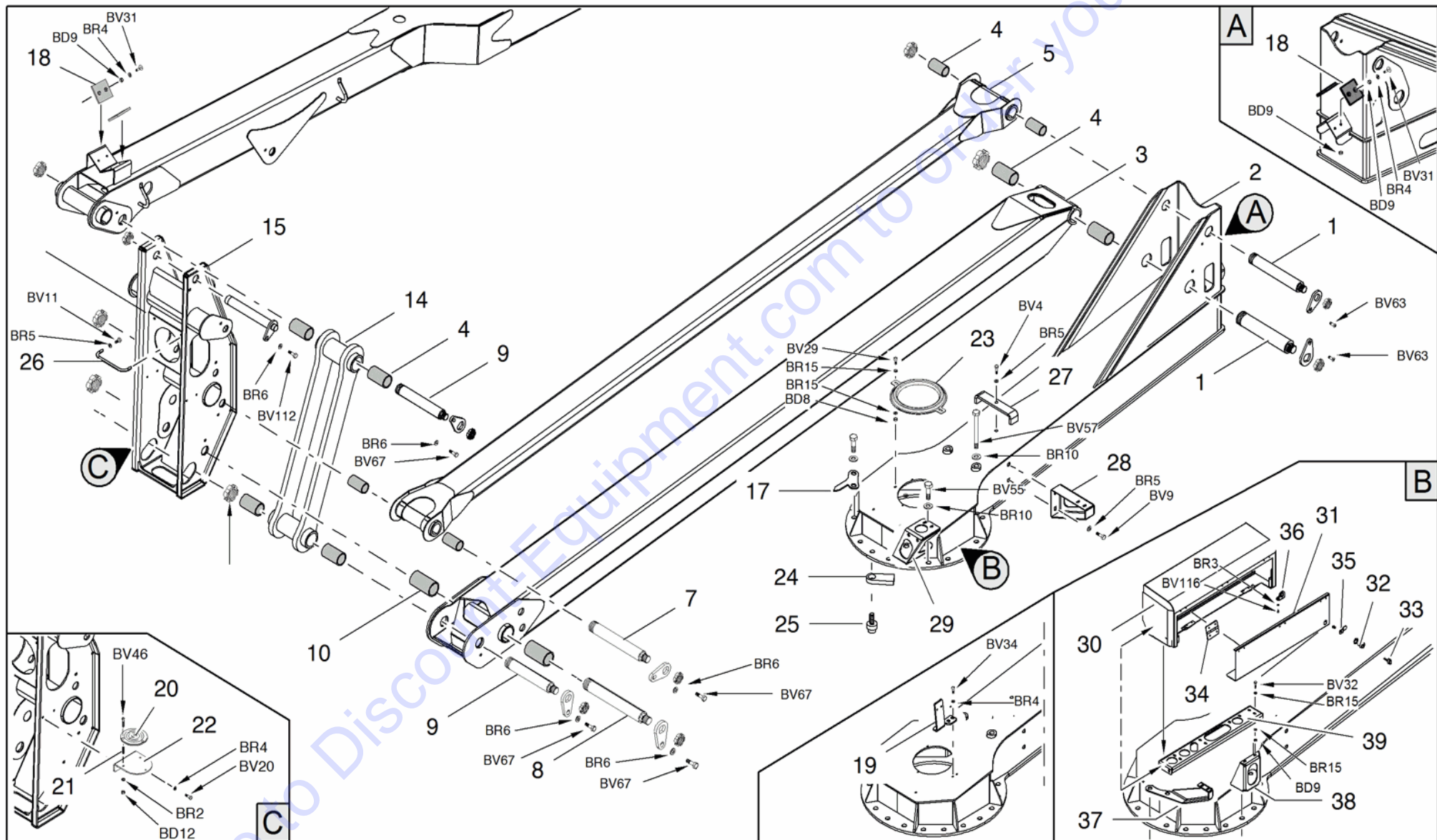

 FIRST ARM

PRIMO BRAZO 





 PREMIER BRAS







 PRIMO BRACCIO
ERSTER AUSLEGERARM 
 FIRST ARM
PRIMO BRAZO 
 PREMIER BRAS

| POS Codice | Q.tà |  Descrizione |  Description |  Designation |  Benennung |  Descripción |
|------------|------|---|---|---|---|---|
| 1 07103700 | 2 NR | SPINA | PIN | CHEVILLE | STIF | CLAVIJA |
| 2 371060J0 | 1 NR | ASSIEME SUPPORTO BRACCI | ASSEMBLY SUPPORT ARMS | ENSEMBLE BRAS DE SUPPORT | TOGETHER TRAGARME | JUNTOS APOYO DE LOS BRAZOS |
| 2 371060J1 | 1 NR | ASSIEME SUPPORTO BRACCI | ASSEMBLY SUPPORT ARMS | ENSEMBLE BRAS DE SUPPORT | TOGETHER TRAGARME | JUNTOS APOYO DE LOS BRAZOS |
| 3 171295J0 | 1 NR | PRIMO BRACCIO | FIRST ARM | PREMIER BRAS | ERSTER AUSLEGERARM | PRIMO BRAZO |
| 3 171295J1 | 1 NR | PRIMO BRACCIO | FIRST ARM | PREMIER BRAS | ERSTER AUSLEGERARM | PRIMO BRAZO |
| 4 06422200 | 4 NR | BOCCOLA | BUSH | DOUILLE | BUCHSE | CASQUILLO |
| 5 171278J0 | 1 NR | TIRANTE PRIMO BRACCIO | TIE ROD 1ST BOOM | ATTACHEZ PREMIÈRE BRAS | TIE ERSTE ARM | ATAR PRIMERO BRAZO |
| 5 171278J1 | 1 NR | BIELLA | CONNECTING ROD | BIELLE | ZEITSTEUERUNG SVERBINDUNG | BIELA |
| 7 07102200 | 1 NR | SPINA | PIN | CHEVILLE | STIF | CLAVIJA |
| 7 07102200 | 2 NR | SPINA | PIN | CHEVILLE | STIF | CLAVIJA |
| 8 07102400 | 1 NR | SPINA | PIN | CHEVILLE | STIF | CLAVIJA |
| 9 07095300 | 2 NR | SPINA | PIN | CHEVILLE | STIF | CLAVIJA |
| 9 07095300 | 1 NR | SPINA | PIN | CHEVILLE | STIF | CLAVIJA |

 PRIMO BRACCIO
ERSTER AUSLEGERARM 
 FIRST ARM
PRIMO BRAZO 
 PREMIER BRAS

| POS Codice | Q.tà |  Descrizione |  Description |  Designation |  Benennung |  Descripción |
|-------------|------|---|---|---|---|---|
| 10 07130500 | 2 NR | BOCCOLA | BUSH | DOUILLE | BUCHSE | CASQUILLO |
| 14 171270J0 | 1 NR | BIELLA | CONNECTING ROD | BIELLE | ZEITSTEUERUNG SVERBINDUNG | BIELA |
| 14 171270J1 | 1 NR | BIELLA | CONNECTING ROD | BIELLE | ZEITSTEUERUNG SVERBINDUNG | BIELA |
| 15 371286J0 | 1 NR | RINVIO 1° - 2° BRACCIO | UPRIGHT 1° - 2° BOOM | RENOI 1° - 2° BRAS | VORGELEGE 1°-2° ARM | REENVIO 1° - 2° BRAZO |
| 15 371286J1 | 1 NR | RINVIO 1° - 2° BRACCIO | 1° - 2° ARM TRANSMISSION | RENOI 1° - 2° BRAS | VORGELEGE 1°-2° ARM | REENVIO 1° - 2° BRAZO |
| 17 071531D2 | 1 NR | INDICE ALLINEAMENTO | ALIGNMENT INDICATOR | INDICATEUR D'ALIGNEMENT | AUSRICHTUNGSANZEIGE | INDICADOR ALINEACIÓN |
| 18 05849000 | 4 NR | PATTINO | SLIDE BLOCK | PATIN | GLEITBLOCK | PATÍN |
| 19 071538H3 | 1 NR | STAFFA | BRACKET | ÉTRIER | HALTEBÜGEL | ESTRIBO |
| 20 05427200 | 1 NR | LIVELLA | LEVEL | NIVEAU | WASSERWAAGE | NIVEL DE BURBUJA |
| 21 05444800 | 3 NR | MOLLA | SPRING | RESSORT | FEDER | MUELLE |
| 22 058832H3 | 1 NR | SUPPORTO | SUPPORT | SUPPORT | HALTERUNG | SOPORTE |
| 23 069590H3 | 1 NR | PROTEZIONE | PROTECTION | PROTECTION | SCHUTZ | PROTECCIÓN |
| 24 064422Y1 | 1 NR | FERMO | RETAINER | ARRÊT | HALTEVORRICHTUNG | BLOQUE |
| 25 068912Y1 | 1 NR | PERNO | PIN | GOIJON | ZAPFEN | PERNIO |

 PRIMO BRACCIO
ERSTER AUSLEGERARM 
 FIRST ARM
PRIMO BRAZO 
 PREMIER BRAS

| POS Codice | Q.tà |  Descrizione |  Description |  Designation |  Benennung |  Descripción |
|-------------|------|---|---|---|---|---|
| 26 07154000 | 1 NR | MANIGLIA | HANDLE | POIGNÉE | GRIFF | MANIJA |
| 27 060372Y2 | 1 NR | FERMO | RETAINER | ARRÊT | HALTERUNG | SUJETADOR |
| 28 07107000 | 1 NR | SUPPORTO DISTRIBUTORE DX | SUPPORT DISTRIBUTOR DX | TÔLE PLIÉE | BLECH GEBOGEN | SOPORTE DISTRIBUIDOR DX |
| 29 07124400 | 1 NR | SUPPORTO DISTRIBUTORE SX | SUPPORT DISTRIBUTOR SX | TÔLE PLIÉE | BLECH GEBOGEN | CHAPA DOBLADA |
| 30 37153600 | 1 NR | CARTER PROTEZIONE DISTRIBUTORE BRACCI | COVER FOR DISTRIBUTOR ARMS | CARTER | KURBELGEHÄUS E | CÁRTER |
| 30 373142H2 | 1 NR | CARTER DISTRIBUTORE BRACCI (FOR LL1775-X17JP-X5 00AJ MK2 FROM C170000893) | PROTECTION BOOM HYDRAULIC DISTRIBUTOR (FOR LL1775-X17JP-X5 00AJ MK2 FROM C170000893) | PROTECTION DISTRIBUTEUR (FOR LL1775-X17JP-X5 00AJ MK2 FROM C170000893) | SCHUTZ VENTILBLOCK (FOR LL1775-X17JP-X5 00AJ MK2 FROM C170000893) | PROTECCION DISTRIBUIDOR (FOR LL1775-X17JP-X5 00AJ MK2 FROM C170000893) |





 PRIMO BRACCIO

 ERSTER AUSLEGERARM





 FIRST ARM

 PRIMO BRAZO

 PREMIER BRAS

| POS Codice | Q.tà |  Descrizione |  Description |  Designation |  Benennung |  Descripción |
|-------------|------|---|---|---|---|---|
| 31 07153200 | 1 NR | COPERCHIO COMANDI PARTE AEREA | COVER AEREA CONTROLS | COUVERCLE | DECKEL | TAPA |
| 31 073144H2 | 1 NR | COPERCHIO (FOR LL1775-X17JP-X5 00AJ MK2 FROM C170000893) | COVER (FOR LL1775-X17JP-X5 00AJ MK2 FROM C170000893) | COUVERTURE (FOR LL1775-X17JP-X5 00AJ MK2 FROM C170000893) | DECKUNG (FOR LL1775-X17JP-X5 00AJ MK2 FROM C170000893) | COBERTURA (FOR LL1775-X17JP-X5 00AJ MK2 FROM C170000893) |
| 31 075059H2 | 1 NR | COPERCHIO SENZA CHIAVE VERSIONE ANSI (FOR LL1775-X17JP-X5 00AJ MK2 FROM C170000893) | COVER WITHOUT KEY ANSI VERSION (FOR LL1775-X17JP-X5 00AJ MK2 FROM C170000893) | COUVERTURE SANS CLÉ (FOR LL1775-X17JP-X5 00AJ MK2 FROM C170000893) | DECKUNG OHNE SCHLÜSSEL (FOR LL1775-X17JP-X5 00AJ MK2 FROM C170000893) | COBERTURA SIN LLAVE (FOR LL1775-X17JP-X5 00AJ MK2 FROM C170000893) |
| 31 07506000 | 1 NR | COPERCHIO COMANDI PARTE AEREA SENZA CHIAVE VERSIONE ANSI | COVER AEREA CONTROLS WITHOUT KEY ANSI VERSION | COUVERCLE | DECKEL | TAPA |
| 32 07178800 | 1 NR | SERRATURA | LOCK | SERRURE | SCHLOSS | CERRADURA |
| 33 07298800 | 1 NR | CHIAVE PER SERRATURA POSTAZIONE COMANDO A TERRA | KEY TO THE LOCK ON THE GROUND CONTROL POSITION | CLÉ | SCHLÜSSEL | LLAVE |

 PRIMO BRACCIO
ERSTER AUSLEGERARM 
 FIRST ARM
PRIMO BRAZO 
 PREMIER BRAS

| POS Codice | Q.tà |  Descrizione |  Description |  Designation |  Benennung |  Descripción |
|-------------|------|---|---|---|---|---|
| 34 07178700 | 3 NR | CERNIERA CON CONTROLLO DELLA POSIZIONE | HINGES WITH POSITION CONTROL | CHARNIÈRE | SCHARNIER | BISAGRA |
| 35 07178900 | 1 NR | CAMMA PER SERRATURA DISASSAMENTO 3.2 | CAM LOCK FOR OFFSET 3.2 | CAME | NOCKEN | LEVA |
| 36 073138Y1 | 1 NR | SUPPORTO SERRATURA | LOCK SUPPORT | SUPPORT SERRURE | SCHLOSSHALTE RUNG | SOPORTE CERRADURA |
| 37 072773H3 | 1 NR | SUPPORTO (FOR LL1775-X17JP-X5 00AJ MK2 FROM C170000893) | SUPPORT (FOR LL1775-X17JP-X5 00AJ MK2 FROM C170000893) | SOUTIEN (FOR LL1775-X17JP-X5 00AJ MK2 FROM C170000893) | SUPPORT (FOR LL1775-X17JP-X5 00AJ MK2 FROM C170000893) | APOYO (FOR LL1775-X17JP-X5 00AJ MK2 FROM C170000893) |
| 38 376848H3 | 1 NR | SUPPORTO SALDATO (FOR LL1775-X17JP-X5 00AJ MK2 FROM C170000893) | WELDED SUPPORT (FOR LL1775-X17JP-X5 00AJ MK2 FROM C170000893) | | | |
| 39 076847H3 | 1 NR | SUPPORTO (FOR LL1775-X17JP-X5 00AJ MK2 FROM C170000893) | SUPPORT (FOR LL1775-X17JP-X5 00AJ MK2 FROM C170000893) | | | |

 SECONDO BRACCIO

ZWEITER AUSLEGERARM 



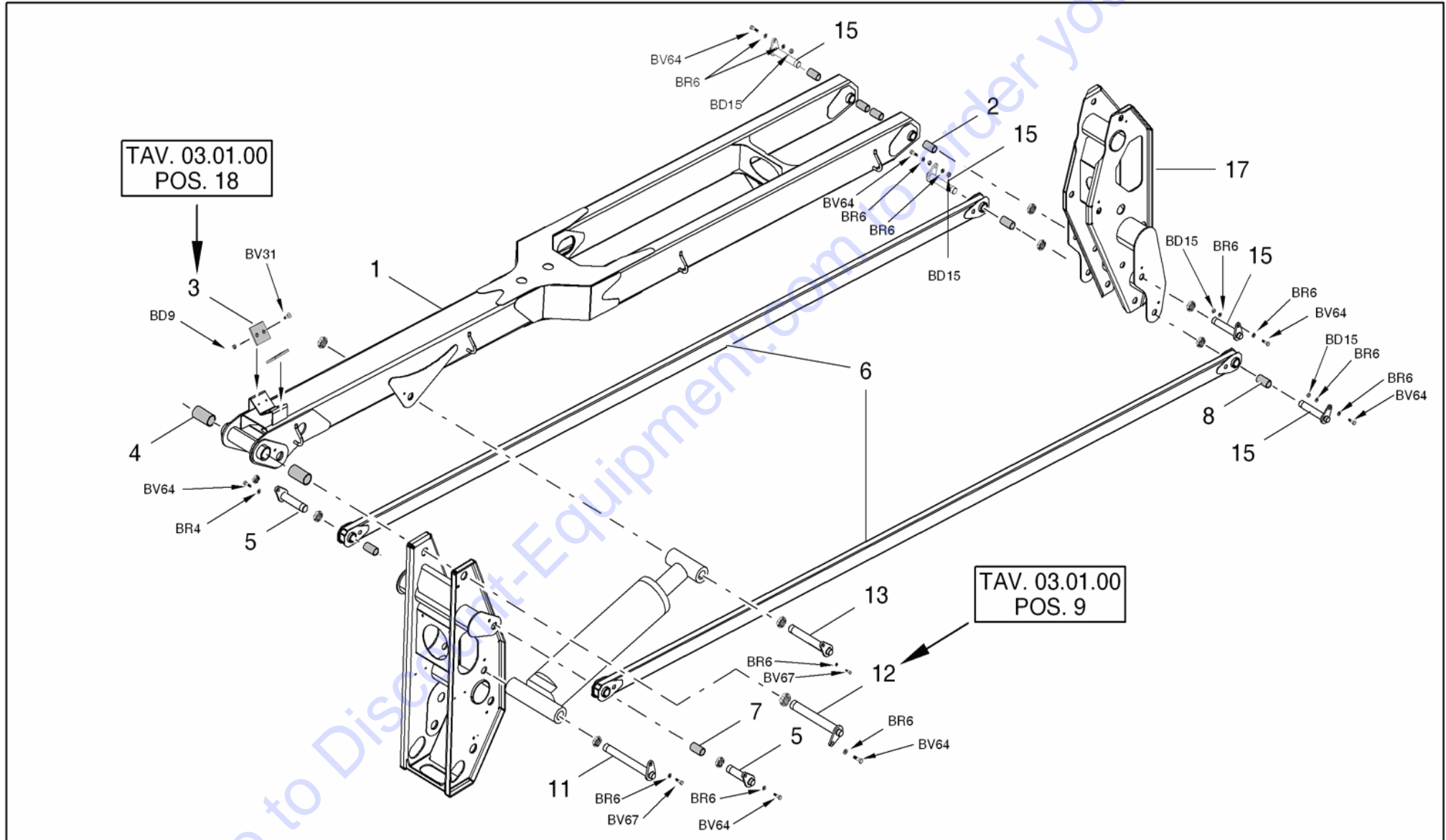

 SECOND ARM

SEGUNDO BRAZO 

 SECOND BRAS



 SECONDO BRACCIO
ZWEITER AUSLEGERARM 
 SECOND ARM
SEGUNDO BRAZO 
 SECOND BRAS

| POS Codice | Q.tà |  Descrizione |  Description |  Designation |  Benennung |  Descripción |
|-------------|------|---|---|---|---|---|
| 1 171246J0 | 1 NR | SECONDO BRACCIO COMPLETO | COMPLETE SECOND ARM | DEUXIÈME BRAS COMPLÈTE | ZWEITER ARM ERGÄNZEN | SEGUNDO BRAZO COMPLETO |
| 1 171246J1 | 1 NR | SECONDO BRACCIO COMPLETO | COMPLETE SECOND ARM | DEUXIÈME BRAS COMPLÈTE | ZWEITER ARM ERGÄNZEN | SEGUNDO BRAZO COMPLETO |
| 2 06326300 | 2 NR | BOCCOLA | BUSH | DOUILLE | BUCHSE | CASQUILLO |
| 4 06422000 | 2 NR | BOCCOLA | BUSH | DOUILLE | BUCHSE | CASQUILLO |
| 5 07095100 | 2 NR | SPINA | PIN | CHEVILLE | STIF | CLAVIJA |
| 6 171273J0 | 2 NR | TIRANTE SECONDO BRACCIO | UPRIGHT SECOND BOOM | BIELLE | ZEITSTEUERUNG SVERBINDUNG | BIELA |
| 6 171273J1 | 2 NR | BIELLA | CONNECTING ROD | BIELLE | ZEITSTEUERUNG SVERBINDUNG | BIELA |
| 7 06586200 | 2 NR | BOCCOLA | BUSH | DOUILLE | BUCHSE | CASQUILLO |
| 8 06422200 | 2 NR | BOCCOLA | BUSH | DOUILLE | BUCHSE | CASQUILLO |
| 8 06422200 | 4 NR | BOCCOLA | BUSH | DOUILLE | BUCHSE | CASQUILLO |
| 11 07102300 | 1 NR | SPINA | PIN | CHEVILLE | STIF | CLAVIJA |
| 13 07095200 | 1 NR | SPINA | PIN | CHEVILLE | STIF | CLAVIJA |
| 15 07095000 | 4 NR | SPINA | PIN | CHEVILLE | STIF | CLAVIJA |





 SECONDO BRACCIO

ZWEITER AUSLEGERARM 

 SECOND ARM

SEGUNDO BRAZO 

 SECOND BRAS

| POS Codice | Q.tà |  Descrizione |  Description |  Designation |  Benennung |  Descripcìon |
|-------------|------|---|---|---|---|---|
| 17 371038J0 | 1 NR | RINVIO 2°-3° BRACCIO | UPRIGHT 2ND-3RD BOOM | RENOI | VORGELEGE | REENVIO |
| 17 371038J1 | 1 NR | RINVIO | TRANSMISSION | RENOI | VORGELEGE | REENVIO |

Go to Discount-Equipment.com to order your parts

 TERZO BRACCIO

 THIRD ARM



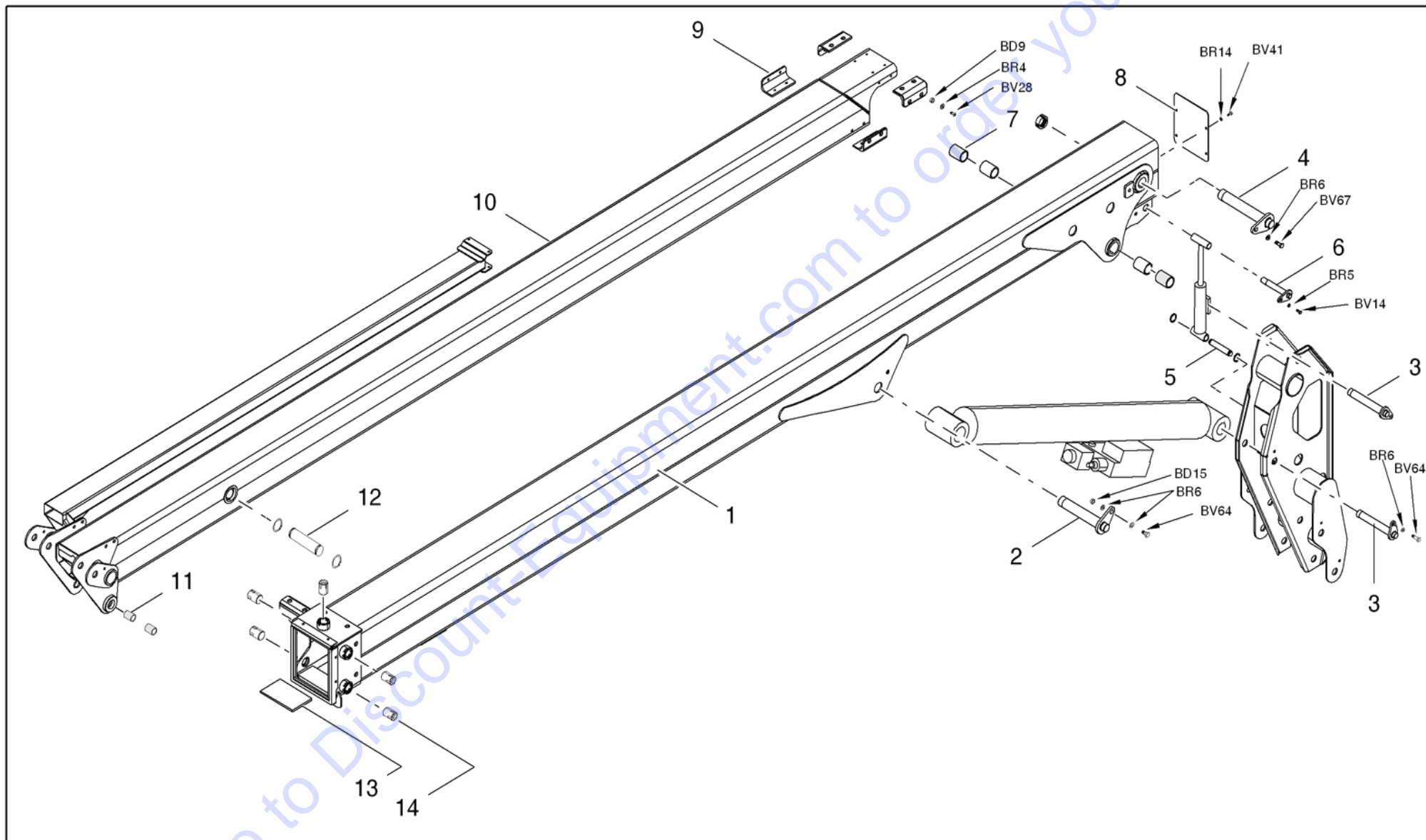

 TIERS BRAS

THIRD AUSLEGERARM 

TERCERO BRAZO 



 TERZO BRACCIO
THIRD AUSLEGERARM 
 THIRD ARM
TERCERO BRAZO 
 TIERS BRAS

| POS | Codice | Q.tà |  Descrizione |  Description |  Designation |  Benennung |  Descripcìon |
|-----|----------|------|---|---|---|---|---|
| 1 | 170955J0 | 1 NR | TERZO BRACCIO COMPLETO | COMPLETE THIRD ARM | COMPLETE TROISIÈME BRAS | KOMPLETTE DRITTEN ARM | TERCER BRAZO COMPLETO |
| 1 | 170955J1 | 1 NR | TERZO BRACCIO COMPLETO | COMPLETE THIRD ARM | COMPLETE TROISIÈME BRAS | KOMPLETTE DRITTEN ARM | TERCER BRAZO COMPLETO |
| 2 | 07093900 | 1 NR | SPINA | PIN | CHEVILLE | STIF | CLAVIJA |
| 3 | 07094900 | 2 NR | SPINA | PIN | CHEVILLE | STIF | CLAVIJA |
| 4 | 07102500 | 1 NR | SPINA | PIN | CHEVILLE | STIF | CLAVIJA |
| 5 | 06867600 | 1 NR | SPINA | PIN | CHEVILLE | STIFT | CLAVIJA |
| 6 | 06230600 | 1 NR | SPINA | PIN | CHEVILLE | STIFT | CLAVIJA |
| 7 | 06326300 | 4 NR | BOCCOLA | BUSH | DOUILLE | BUCHSE | CASQUILLO |
| 8 | 071315H3 | 1 NR | COPERCHIO POSTERIORE SFILO | BACK COVER EXTENSION | COUVERCLE | DECKEL | TAPA |
| 9 | 07178200 | 4 NR | PATTINO | SLIDE BLOCK | PATIN | GLEITBLOCK | PATÍN |
| 10 | 171049J0 | 1 NR | BRACCIO SFILO COMPLETO | COMPLETE ARM EXTENSION | BRAS EXTENSION COMPLÈTE | ARM ERWEITERUNG ERGÄNZEN | BRAZO EXTENSIÓN COMPLETO |
| 10 | 171049J2 | 1 NR | BRACCIO SFILO COMPLETO | COMPLETE ARM EXTENSION | BRAS EXTENSION COMPLÈTE | ARM ERWEITERUNG ERGÄNZEN | BRAZO EXTENSIÓN COMPLETO |
| 11 | 06900700 | 2 NR | BOCCOLA | BUSH | DOUILLE | BUCHSE | CASQUILLO |





 TERZO BRACCIO

THIRD AUSLEGERARM 

 THIRD ARM

TERCERO BRAZO 

 TIERS BRAS

| POS Codice | Q.tà |  Descrizione |  Description |  Designation |  Benennung |  Descripcìon |
|-------------|------|---|---|---|---|---|
| 12 06853800 | 1 NR | SPINA | PIN | CHEVILLE | STIF | CLAVIJA |
| 13 07101100 | 1 NR | PATTINO | SLIDE BLOCK | PATIN | GLEITBLOCK | PATÍN |
| 14 06958600 | 5 NR | PATTINO | SLIDE BLOCK | PATIN | GLEITBLOCK | PATÍN |

Go to Discount-Equipment.com to order your parts

 CATENA PORTACAVI FLESSIBILE

 FLEXIBLE CABLE-HOLDER CHAIN



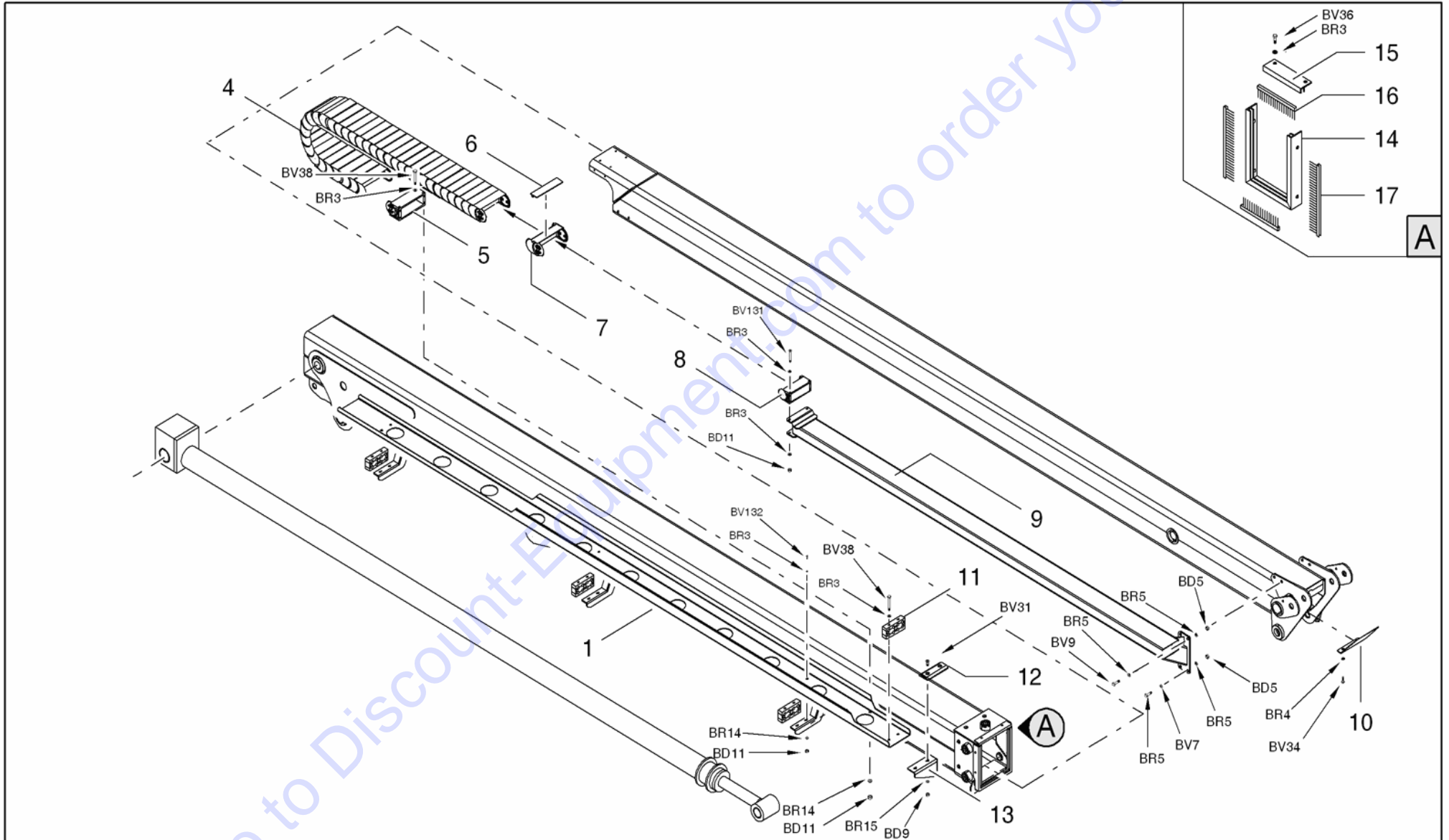

 CHAÎNE PORTE-CABLES FLEXIBLE

SCHLAUCH SCHLEPPKETTE 

CADENA PORTACABLES FLEXIBLE 



 CATENA PORTACAVI FLESSIBILE
SCHLAUCH SCHLEPPKETTE 
 FLEXIBLE CABLE-HOLDER CHAIN
CADENA PORTACABLES FLEXIBLE 
 CHAÎNE PORTE-CABLES FLEXIBLE

| POS Codice | Q.tà |  Descrizione |  Description |  Designation |  Benennung |  Descripción |
|--------------|------|---|---|---|---|---|
| 1 071005H3 | 1 NR | SUPPORTO | SUPPORT | SUPPORT | HALTERUNG | SOPORTE |
| 4 25950500 | 1 NR | CATENA PORTACAVI | CABLE-HOLDER CHAIN | CHAÎNE PORTE-CÂBLES | KABELHALTERK ETTE | CADENA PORTACABLES |
| 5 2595050001 | 1 NR | MAGLIA CATENA ATTACCO FEMMINA | CHAIN LINK FEMALE CONNECTION | MAILLOT CHAÎNE | KETTENGLIED | ESLABÓN CADENA |
| 6 2595050004 | 1 NR | COPERCHIO | COVER | COUVERCLE | DECKEL | TAPA |
| 7 2595050003 | 1 NR | MAGLIA CATENA | CHAIN LINK | MAILLOT CHAÎNE | KETTENGLIED | ESLABÓN CADENA |
| 8 2595050002 | 1 NR | MAGLIA CATENA ATTACCO MASCHIO | CHAIN LINK MALE CONNECTION | MAILLOT CHAÎNE | KETTENGLIED | ESLABÓN CADENA |
| 9 371307H3 | 1 NR | SUPPORTO | SUPPORT | SUPPORT | HALTERUNG | SOPORTE |
| 10 071314H3 | 1 NR | COPERCHIO ANTERIORE SFILO | FRONT COVER EXTENSION | COUVERCLE | DECKEL | TAPA |
| 11 07100600 | 4 NR | MORSETTO | CLAMP | BORNE | KLEMME | BORNE |
| 12 068663H3 | 1 NR | SUPPORTO | SUPPORT | SUPPORT | HALTERUNG | SOPORTE |
| 13 06867100 | 1 NR | PATTINO | SLIDE BLOCK | PATIN | GLEITBLOCK | PATÍN |





 CATENA PORTACAVI FLESSIBILE

SCHLAUCH SCHLEPPKETTE 

 FLEXIBLE CABLE-HOLDER CHAIN

CADENA PORTACABLES FLEXIBLE 

 CHAINE PORTE-CABLES FLEXIBLE

| POS Codice | Q.tà |  Descrizione |  Description |  Designation |  Benennung |  Descripcìon |
|-------------|------|---|---|---|---|---|
| 14 07101500 | 1 NR | PROFILO SPAZZOLE | PROFILE BRUSHES | TÔLE PLIÉE | BLECH GEBOGEN | CHAPA DOBLADA |
| 14 17101500 | 1 NR | KIT SPAZZOLE TERZO BRACCIO LL2010 | BRUSHES KIT | KIT BROSSES | BÜRSTENSATZ | KIT CEPILLOS |
| 15 07101600 | 1 NR | PROFILO SPAZZOLE SUPERIORE | PROFILE BRUSH TOP | CHÂSSIS | RAHMEN | BASTIDOR |
| 16 07102000 | 2 NR | SPAZZOLA ORRIZONTALE | HORIZONTAL BRUSH | BROSSE HORIZONTALE | WAAGRECHTE BÜRSTE | CEPILLO HORIZONTAL |
| 17 07102100 | 2 NR | SPAZZOLA VERTICALE | VERTICAL BRUSH | BROSSE VERTICALE | SENKRECHTE BÜRSTE | CEPILLO VERTICAL |

Go to Discount-Equipment.com to Order your parts

 SUPPORTO CESTO

HALTERUNG ARBEITSKORB 

 BASKET SUPPORT

SOPORTE CESTA 



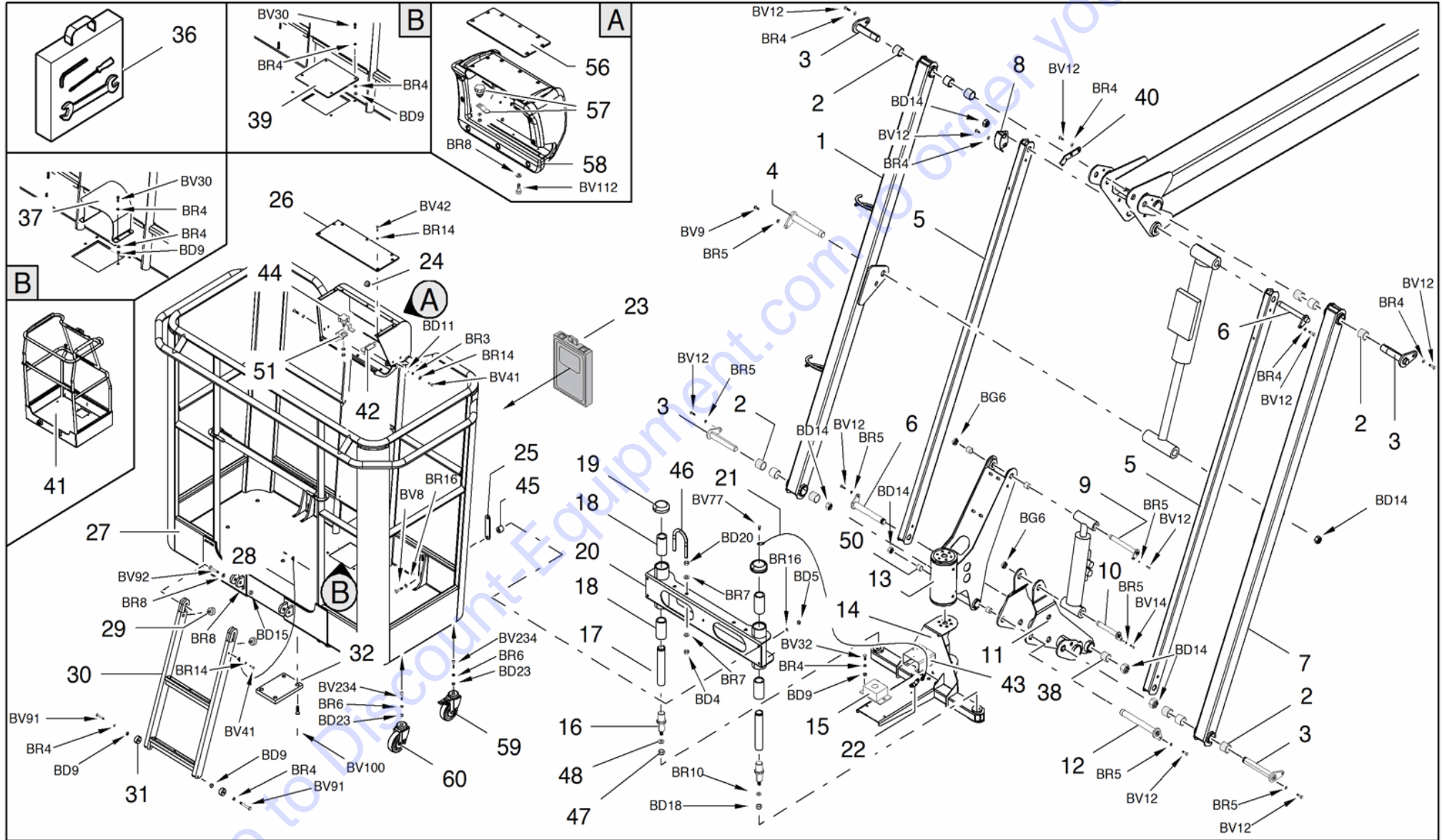

 PANIER CUPPORT



 SUPPORTO CESTO

 HALTERUNG ARBEITSKORB 
 BASKET SUPPORT





 SOPORTE CESTA 
 PANIER CUPPORT

| POS Codice | Q.tà |  Descrizione |  Description |  Designation |  Benennung |  Descripcìon |
|-------------|------|---|---|---|---|---|
| 1 170948J0 | 1 NR | BRACCIO JIB COMPLETO DX | COMPLETE JIB ARM RIGHT | FLÉCHETTE BRAS COMPLÈTE | ARM - SCHWENKARM | BRAZO JIB COMPLETO |
| 1 170948J2 | 1 NR | BRACCIO JIB COMPLETO DX | COMPLETE JIB ARM RIGHT | BRAS JIB DROITE COMPLÈTE | KORBARM RECHTS | BRAZO JIB DERECHA COMPLETO |
| 2 06272600 | 4 NR | BOCCOLA | BUSH | DOUILLE | BUCHSE | CASQUILLO |
| 3 07093500 | 4 NR | SPINA | PIN | CHEVILLE | STIFT | CLAVIJA |
| 4 07093800 | 1 NR | SPINA | PIN | CHEVILLE | STIFT | CLAVIJA |
| 5 359447J0 | 2 NR | TIRANTE JIB | TIE ROD JIB | TIRANT | TURMGESTÄNGE | TIRANTE |
| 5 359447J2 | 2 NR | TIRANTE JIB | TIE ROD JIB | TIRANT | ZUGSTANGE | TIRANTE |
| 6 07093600 | 2 NR | SPINA | PIN | CHEVILLE | STIFT | CLAVIJA |
| 7 170947J0 | 1 NR | BRACCIO JIB COMPLETO SX | COMPLETE JIB ARM LEFT | FLÉCHETTE BRAS COMPLÈTE | ARM - SCHWENKARM | BRAZO JIB COMPLETO |
| 7 170947J2 | 1 NR | BRACCIO JIB COMPLETO SX | COMPLETE JIB ARM LEFT | BRAS JIB GAUCHE | KORBARM LINKS | BRAZO JIB IZQUIERDA |
| 8 372264H3 | 1 NR | CAMMA MICRO JIB | MICROSWITCH CAM JIB | CAME | NOCKEN | LEVA |
| 9 07093700 | 1 NR | SPINA | PIN | CHEVILLE | STIFT | CLAVIJA |
| 10 06235600 | 1 NR | SPINA | PIN | CHEVILLE | STIFT | CLAVIJA |

 SUPPORTO CESTO

 HALTERUNG ARBEITSKORB 
 BASKET SUPPORT





 SOPORTE CESTA 
 PANIER CUPPORT

| POS Codice | Q.tà |  Descrizione |  Description |  Designation |  Benennung |  Descripción |
|---------------|------|---|---|---|---|---|
| 11 166242J0 | 1 NR | RINVIO JIB | UPRIGHT JIB | RENOVI | VORGELEGE | REENVIO |
| 11 166242J2 | 1 NR | RINVIO JIB | UPRIGHT JIB | RENOVI | VORGELEGE | REENVIO |
| 12 06235700 | 1 NR | SPINA | PIN | CHEVILLE | STIFT | CLAVIJA |
| 13 2648910002 | 1 NR | KIT GUARNIZIONI | SEAL KIT | KIT DE JOINTS | DICHTUNGSSATZ | KIT DE JUNTAS |
| 13 271778H2 | 1 NR | MOTORE DI ROTAZIONE RAL5015 | ROTARY MOTOR RAL5015 | MOTEUR DE ROTATION RAL5015 | MOTORDREHZA L RAL5015 | MOTOR ROTACIÓN RAL5015 |
| 13 271778J0 | 1 NR | MOTORE DI ROTAZIONE | ROTARY MOTOR | MOTEUR DE ROTATION | ROTATIONSMOTO R | MOTOR DE ROTACIÓN |
| 14 371463H2 | 1 NR | ASSIEME SUPPORTO CESTO PERNI DIAM.50 RAL5015 | TOGETHER SUPPORT PINS BASKET DIAM.50 RAL5015 | ENSEMBLE SUPPORT PINS BASKET DIAM.50 RAL5015 | TOGETHER AUFLAGESTIFTE BASKET DIAM.50 RAL5015 | JUNTOS APOYO PINS CESTA DIAM.50 RAL5015 |
| 14 371463J0 | 1 NR | ASSIEME SUPPORTO CESTO PERNI DIAM.50 | BASKET ASSEMBLY SUPPORT PINS Ø50 | ENSEMBLE SUPPORT PANIER | TOGETHER STÜTZKORBS | JUNTOS SOPORTE DE LA CESTA |
| 15 056187H3 | 1 NR | COPERCHIO | BOX | COUVERCLE | DECKEL | TAPA |
| 16 07190900 | 2 NR | VITE TE DIN960 CI 8.8 M16X1.5X115 FORATA GEOMET321 PLUS XL | TE SCREW DIN960 CI 8.8 M16X1.5X115 GEOMET321 PERFORATED PLUS XL | VIS TE DIN960 CI 8,8 M16X1.5X115 FORE PLUS GEOMET321 XL | TE SCHRAUBE DIN960 CI 8,8 M16X1.5X115 GEOMET321 PERFORATED PLUS XL | TE TORNILLO DIN960 CI 8,8 M16X1.5X115 GEOMET321 PERFORADA XL |

 SUPPORTO CESTO

 HALTERUNG ARBEITSKORB 
 BASKET SUPPORT





 SOPORTE CESTA 
 PANIER CUPPORT

| POS Codice | Q.tà |  Descrizione |  Description |  Designation |  Benennung |  Descripcìon |
|-------------|------|---|---|---|---|---|
| 17 07146500 | 2 NR | PERNO SUPPORTO CESTO DIAM.50 | PIN SUPPORT BASKET Ø50 | AXE DIAM.50 PANIER DE SOUTIEN | BOLZEN KORBHALTERUN G | CLAVIJA CESTA |
| 18 27146200 | 4 NR | CUSCINETTO LINEARE A SFERE 50-100 | LINEAR BALL BEARING 50-100 | ROULEMENT LINEAIRE 50-100 | LINEAR-KUGELLA GER 50-100 | COJINETE DE BOLAS 50-100 |
| 19 07146400 | 2 NR | TAPPO CHIUSURA PERNI SUPPORTO CESTO DIAM.50 | CAP PINS BASKET SUPPORT Ø50 | BOUCHON | VERSCHLUSS | TAPÓN |
| 20 371459H2 | 1 NR | SLITTA FISSAGGIO CESTO PERNI DIAM.50 | SLIDE BASKET MOUNTING BOLTS Ø50 | COULISSEAU | SCHLITTEN | CORREDERA |
| 21 06665000 | 2 NR | FUNE | CABLE | CÂBLE | SEIL | CABLE |
| 22 07052900 | 1 NR | STAFFA | BRACKET | ÉTRIER | HALTEBÜGEL | ESTRIBO |
| 23 05643600 | 1 NR | CASSETTA PORTAMANUALE | MANUAL BOX | BOÎTE PORTE-MANUEL | BEDIENUNGSANL EITUNGSFACH | CAJA PORTAMANUAL |
| 24 06477600 | 3 NR | MAGNETE Ø20 CON FORO M3 | MAGNETO Ø20 WITH M3 HOLE | AIMANT | MAGNET | IMÁN |
| 24 06477600 | 1 NR | MAGNETE Ø20 CON FORO M3 | MAGNETO Ø20 WITH M3 HOLE | AIMANT | MAGNET | IMÁN |

 SUPPORTO CESTO

 HALTERUNG ARBEITSKORB 
 BASKET SUPPORT





 SOPORTE CESTA 
 PANIER CUPPORT

| POS Codice | Q.tà |  Descrizione |  Description |  Designation |  Benennung |  Descripción |
|-------------|------|---|---|---|---|---|
| 25 072398H3 | 2 NR | PIASTRA FISSAGGIO CESTO (SOLO MACCHINE MODELLO JP E JA E X17J) | FIXING PLATE BASKET (ONLY MACHINES MODEL JP AND JA AND X17J) | PLATE FIXATION DRUM | PLATE BEFESTIGUNG DRUM | PLACA FIJACIÓN TAMBOR |
| 26 07190600 | 1 NR | COPERTURA SUPPORTO TELECOMANDO (SOLO MACCHINE MODELLO JP E JA E X17J) | COVER SUPPORT REMOTE CONTROL (ONLY MACHINES MODEL JP AND JA AND X17J) | COUVERTURE SUPPORT DE LA TELECOMMANDE | COVER FERNBEDIENUNG SHALTER | CUBIERTA SOPORTE DE CONTROL REMOTO |
| 27 27177700 | 1 NR | CESTO BIPOSTO 230KG (SOLO MACCHINE MODELLO JP E JA) | BASKET 2 PERSON 230KG (ONLY MACHINES MODEL JP AND JA) | PANIER 2 PERSONNES | 2 MANN-ARBEITSK ORB | CESTA 2 PERSONAS |
| 27 27589300 | 1 NR | CESTO BIPOSTO 230KG PER MK2 (DA C170000893) | BASKET 2 PERSON 230KG FOR MK2 (FROM C170000893) | PANIER 2 PERSONNES FOR MK2 (FROM C170000893) | 2 MANN-ARBEITSK ORB FOR MK2 (FROM C170000893) | CESTA 2 PERSONAS FOR MK2 (FROM C170000893) |
| 28 06598500 | 1 NR | FUNE | CABLE | CÂBLE | SEIL | CABLE |
| 29 05475900 | 2 NR | ANTIVIBRANTE | ANTI-VIBRATING | ANTI - VIBRANT | VIBRATIONSDÄM PFER | ANTIVIBRANTE |

 SUPPORTO CESTO

 HALTERUNG ARBEITSKORB 
 BASKET SUPPORT





 SOPORTE CESTA 
 PANIER CUPPORT

| POS Codice | Q.tà |  Descrizione |  Description |  Designation |  Benennung |  Descripción |
|-------------|------|--|---|---|---|---|
| 30 36585800 | 1 NR | SCALETTA | LADDER | ÉCHELLE REPLIABLE | LEITER | ESCALERA PLEGABLE |
| 31 06585900 | 2 NR | ROTELLINA | SMALL ROLLER | ROULETTE | RÄDCHEN | RUEDECILLA |
| 32 058600H3 | 1 NR | PIASTRA | PLATE | PLAQUE | PLATTE | PLACA |
| 37 06418600 | 1 NR | PROTEZIONE | PROTECTION | PROTECTION | SCHUTZ | PROTECCIÓN |
| 38 06701800 | 2 NR | BOCCOLA | BUSH | DOUILLE | BUCHSE | CASQUILLO |
| 40 072263H3 | 1 NR | STAFFA | BRACKET | ÉTRIER | HALTEBÜGEL | ESTRIBO |
| 42 07190500 | 1 NR | PIEGATO BLOCCAGGIO TELECOMANDO (SOLO MACCHINE MODELLO JP E JA E X17J) | BENDED LOCKING REMOTE CONTROL (ONLY MACHINES MODEL JP AND JA AND X17J) | BENT BLOCAGE TELECOMMANDE | BENT EINRASTEN FERNBEDIENUNG | BENT BLOQUEO DE CONTROL REMOTO |
| 43 072404H3 | 1 NR | SUPPORTO PEDALE | PEDAL SUPPORT PLATE | TÔLE PLIÉE | HALTERUNG | SOPORTE |
| 44 07192700 | 1 NR | CHIUSURA A VOLANTINO CON LEVA PIEGATA (SOLO MACCHINE MODELLO JP E JA E X17J) | LOCKING WHEEL WITH BENT LEVER (ONLY MACHINES MODEL JP AND JA AND X17J) | POIGNEE DE BLOCAGE | KUGELVERSCHL USS | POMO DE BLOQUEO |

 SUPPORTO CESTO

 HALTERUNG ARBEITSKORB 
 BASKET SUPPORT





 SOPORTE CESTA 
 PANIER CUPPORT

| POS Codice | Q.tà |  Descrizione |  Description |  Designation |  Benennung |  Descripción |
|-------------|------|---|---|---|---|---|
| 45 07239700 | 2 NR | DISTANZIALE PER VITI M8 SUPPORTO CESTO (SOLO MACCHINE MODELLO JP E JA E X17J) | SPACER SCREW M8 SUPPORT BASKET (ONLY MACHINES MODEL JP AND JA AND X17J) | ENTRETOISE | DISTANZSTÜCK | DISTANCIADOR |
| 46 07031800 | 2 NR | TUBO | PIPE | TUYAU | ROHR | TUBO |
| 47 07193000 | 2 NR | DADO AD INTAGLI UNI5593 CI 8 M16X1.5 GEOMET321 PLUS XL | NUT M16X1.5 NOTCHES UNI5593 CI 8 GEOMET321 PLUS XL | ÉCROU UNI5593 CI 8 M16X1.5 GEOMET321 PLUS XL | MUTTER UNI5593 CI 8 M16X1.5 GEOMET321 PLUS XL | TUERCA UNI5593 CI 8 M16X1.5 GEOMET321 PLUS XL |
| 48 07192600 | 2 NR | RONDELLA SPECIALE HV 300 - D 17X48X6 GEOMET321/A+P LUS XL | SPECIAL WASHER HV 300 - 17X48X6 GEOMET321 D / A + PLUS XL | RONDELLE SPECIALE HV 300 - 17X48X6 GEOMET321 D / A + PLUS XL | SCHEIBE HV 300 - 17X48X6 GEOMET321 D / A + PLUS XL | ARANDELA ESPECIAL HV 300 - 17X48X6 GEOMET321 D / A + PLUS XL |
| 50 06272700 | 1 NR | BOCCOLA | BUSH | DOUILLE | BUCHSE | CASQUILLO |
| 50 06272700 | 2 NR | BOCCOLA | BUSH | DOUILLE | BUCHSE | CASQUILLO |

 SUPPORTO CESTO

 HALTERUNG ARBEITSKORB 
 BASKET SUPPORT

 SOPORTE CESTA 
 PANIER CUPPORT

| POS Codice | Q.tà |  Descrizione |  Description |  Designation |  Benennung |  Descripción |
|-------------|------|---|---|---|---|---|
| 51 07190800 | 1 NR | STAFFA FISSAGGIO CHIUSURA BLOCCAGGIO TELECOMANDO (SOLO MACCHINE MODELLO JP E JA E X17J) | BRACKET LOCKING REMOTE CONTROL (ONLY MACHINES MODEL JP AND JA AND X17J) | FIN DE SUPPORT DE BLOCAGE TELECOMMANDE | BRACKET END EINRASTEN FERNBEDIENUNG | SOPORTE DE FIN DE BLOQUEO DE CONTROL REMOTO |
| 56 07690700 | 1 NR | PROTEZIONE TRASPARENTE | PROTECTION | PROTECTION | SCHUTZ | PROTECCIÓN |
| 57 07192700 | 1 NR | CHIUSURA A VOLANTINO CON LEVA PIEGATA (SOLO MACCHINE MODELLO JP E JA E X17J) | LOCKING WHEEL WITH BENT LEVER (ONLY MACHINES MODEL JP AND JA AND X17J) | POIGNEE DE BLOCAGE | KUGELVERSCHL USS | POMO DE BLOQUEO |
| 58 17569900 | 1 NR | PROTEZIONE TELECOMANDO | PROTECTION REMOTE CONTROL | PROTECTION | SCHUTZ | PROTECCIÓN |
| 59 07751100 | 2 NR | RUOTE INFERIORI PER CESTO CON FRENO | LOWER WHEELS FOR BASKET WITH BRAKE | | | |
| 60 07687300 | 2 NR | RUOTE INFERIORI PER CESTO | LOWER WHEEL | ROULEAU INFERIEUR | UNTERES RAD | RUEDA INFERIOR |

 ACCOPPIAMENTO MOTORE DIESEL- POMPA

PUMPEN / DIESELMOTOR KUPPLUNG 

 DIESEL ENGINE COUPLING - PUMP

ACOPLAMIENTO MOTOR DIESEL- BOMBA 

 ACCOUPLEMENT MOTEUR DIESEL - POMPE

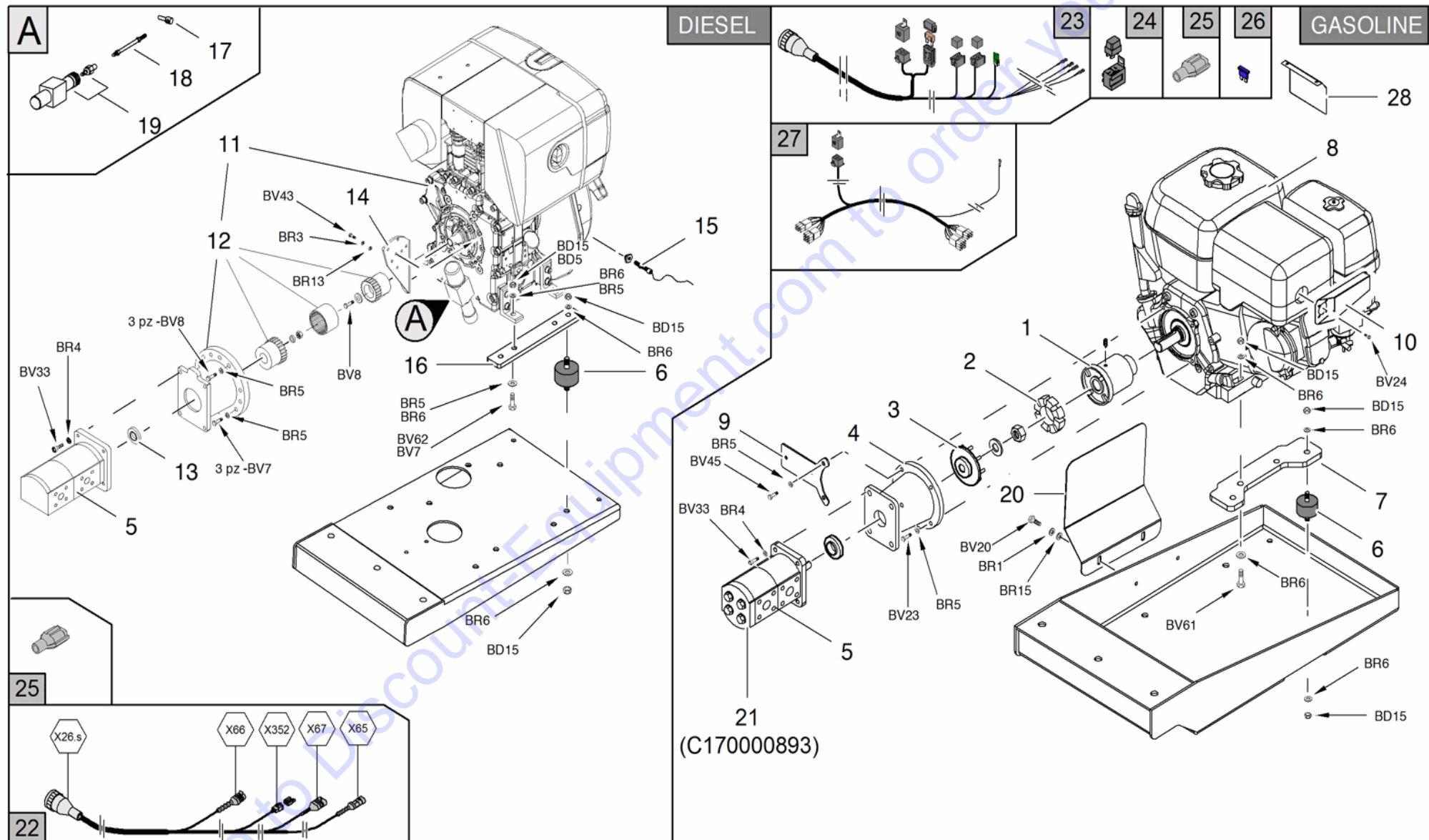





 ACCOPPIAMENTO MOTORE DIESEL- POMPA

PUMPEN / DIESELMOTOR KUPPLUNG 

 DIESEL ENGINE COUPLING - PUMP

ACOPLAMIENTO MOTOR DIESEL- BOMBA 

 ACCOUPLEMENT MOTEUR DIESEL - POMPE

| POS Codice | Q.tà |  Descrizione |  Description |  Designation |  Benennung |  Descripcìon |
|------------|------|---|---|---|---|---|
| 1 04310200 | 1 NR | SEMIGIUNTO | HALF COUPLING | DEMI-JOINT | HALBVERBINDUNG | SEMI-ACOPLAMIENTO |
| 2 04310100 | 1 NR | INSERTO IN GOMMA | RUBBER INSERT | INSERT EN CAOUTCHOUC | GUMMIEINSATZ | INSERTO DE GOMA |
| 3 04615300 | 1 NR | GIUNTO | COUPLING | JOINT | VERBINDUNG | ACOPLAMIENTO |
| 4 04310300 | 1 NR | LANTERNA | LANTERN | LANTERNE | BUCHSE | LINTERNA |
| 5 14615200 | 1 NR | POMPA IDRAULICA | HYDRAULIC PUMP | POMPE HYDRAULIQUE | HYDRAULIKPUMPE | BOMBA HYDRÁULICA |
| 6 04152400 | 4 NR | ANTIVIBRANTE VERSIONE DIESEL | ANTI-VIBRATING DIESEL VERSION | ANTI - VIBRANT | VIBRATIONSDÄMPFER | ANTIVIBRANTE |
| 6 05535300 | 4 NR | ANTIVIBRANTE VERSIONE BENZINA | ANTI-VIBRATING GASOLINE VERSION | ANTI - VIBRANT | VIBRATIONSDÄMPFER | ANTIVIBRANTE |
| 7 046393H3 | 2 NR | SUPPORTO MOTORE HONDA GX390 | SUPPORT ENGINE HONDA GX390 | SUPPORT HONDA GX390 | HALTERUNG HONDA GX390 | SOPORTE HONDA GX390 |
| 7 059551H2 | 2 NR | PIATTO HONDA IGX440 | PLATE HONDA IGX440 | PLATEAU HONDA IGX440 | PLATTE HONDA IGX440 | PLACA HONDA IGX440 |





 ACCOPPIAMENTO MOTORE DIESEL- POMPA

PUMPEN / DIESELMOTOR KUPPLUNG 

 DIESEL ENGINE COUPLING - PUMP

ACOPLAMIENTO MOTOR DIESEL- BOMBA 

 ACCOUPLEMENT MOTEUR DIESEL - POMPE

| POS | Codice | Q.tà |  Descrizione |  Description |  Designation |  Benennung |  Descripcìon |
|-----|----------|------|--|---|---|---|---|
| 8 | 25952600 | 1 NR | MOTORE BENZINA | PETROL ENGINE | MOTEUR A ESSÉNCÉ | BENZINMOTOR | MOTOR DE GASOLINA |
| 8 | 27775900 | 1 NR | MOTORE HONDA IGX390 MODIFICATO SENZA BLOCCHETTO CHIAVE DI ACCENSIONE MK2 (DA C170000893) | HONDA MOTOR IGX390 MODIFIED WITHOUT IGNITION SWITCH MK2 (FROM C170000893) | | | |
| 9 | 061177H2 | 1 NR | STAFFA | BRACKET | ÉTRIER | HALTEBÜGEL | ESTRIBO |
| 10 | 05922000 | 1 NR | DEFLETTORE | DEFLECTOR | DÉFLECTEUR | ABWEISER | DEFLECTOR |

Go to Discount-Equipment.com to order your parts





 ACCOPPIAMENTO MOTORE DIESEL- POMPA

PUMPEN / DIESELMOTOR KUPPLUNG 

 DIESEL ENGINE COUPLING - PUMP

ACOPLAMIENTO MOTOR DIESEL- BOMBA 

 ACCOUPLEMENT MOTEUR DIESEL - POMPE

| POS Codice | Q.tà |  Descrizione |  Description |  Designation |  Benennung |  Descripcìon |
|---------------|------|---|---|---|---|---|
| 11 27110400 | 1 NR | MOTORE DIESEL HATZ 10HP VERSIONE CON PREDISPOSIZION E REGOLAZIONI GIRI ELETTRONICA (NO CARB-EPA CERT) | HATZ DIESEL ENGINE 10HP VERSION WITH PREDISPOSITION TO ELECTRONIC SPEED REGULATION (NO CARB-EPA CERT) | MOTEUR DIESEL | DIESELMOTOR | MOTOR DIESEL |
| 11 27676900 | 1 NR | MOTORE DIESEL HATZ 1B40 RPM SENZA CHIAVE+ACCOP PIAMENTO (TIER3 SOLO VERS. EU, NO CARB-EPA CERT) MK2 (DA C170000893) | DIESEL ENGINE HATZ 1B40 RPM WITHOUT KEY + COUPLING (TIER3 ONLY VERS. EU, NON-EPA CARB CERT) MK2 (FROM C170000893) | | | |
| 12 2558630001 | 1 NR | ACCOPPIAMENT O MOTORE - POMPA | ENGINE COUPLING - PUMP | ACCOUPLEMENT MOTEUR - POMPE | PUMPEN-/MOTOR KUPPLUNG | ACOPLAMIENTO MOTOR - BOMBA |
| 13 05559100 | 1 NR | DISTANZIALE | SPACER | ENTRETOISE | DISTANZSTÜCK | DISTANCIADOR |
| 14 070989H2 | 1 NR | STAFFA | BRACKET | ÉTRIER | HALTEBÜGEL | HALTEBÜGEL |
| 15 26514900 | 1 NR | SENSORE | SENSOR | CAPTEUR | SENSOR | SENSOR |
| 16 057900Y1 | 2 NR | PIATTO | PLATE | PLATEAU | PLATTE | PLACA |





 ACCOPPIAMENTO MOTORE DIESEL- POMPA

PUMPEN / DIESELMOTOR KUPPLUNG 

 DIESEL ENGINE COUPLING - PUMP

ACOPLAMIENTO MOTOR DIESEL- BOMBA 

 ACCOUPLEMENT MOTEUR DIESEL - POMPE

| POS Codice | Q.tà |  Descrizione |  Description |  Designation |  Benennung |  Descripción |
|---------------|------|---|---|---|---|---|
| 17 070986Y2 | 1 NR | PERNO | PIN | GOUJON | ZAPFEN | PERNIO |
| 18 07098700 | 1 NR | TIRANTE | TIE ROD | TIRANT | TURMGESTÄNGE | TIRANTE |
| 19 26551500 | 1 NR | PISTONE | PISTON | PISTON | KOLBEN | PISTÓN |
| 20 061907H2 | 1 NR | PROTEZIONE | PROTECTION | PROTECTION | SCHUTZ | PROTECCIÓN |
| 21 25526300 | 1 NR | POMPA IDRAULICA | HYDRAULIC PUMP | POMPE HYDRAULIQUE | HYDRAULIKPUMP E | BOMBA HYDRÁULICA |
| 22 1764270001 | 1 NR | KIT IMPIANTO ELETTRICO A RICAMBIO DIESEL LL1775 MK2 (DA C170000893) | KIT ELECTRICAL SPARE FOR DIESEL LL1775 MK2 (FROM C170000893) | | | |
| 23 1776330002 | 1 NR | KIT IMPIANTO ELETTRICO A RICAMBIO BENZINA 13I LL1775 MK2 (DA C170000893) | KIT ELECTRICAL SPARE FOR GASOLINE 13I LL1775 MK2 (FROM C170000893) | | | |
| 24 1776330003 | 1 NR | RELE' MINI TYCO 12V PER CONNETTORE A TENUTA (MK2 DA C170000893) | RELAY 'MINI 12V TYCO CONNECTOR SEAL (MK2 FROM C170000893) | | | |





 ACCOPPIAMENTO MOTORE DIESEL- POMPA

PUMPEN / DIESELMOTOR KUPPLUNG 

 DIESEL ENGINE COUPLING - PUMP

ACOPLAMIENTO MOTOR DIESEL- BOMBA 

 ACCOUPLEMENT MOTEUR DIESEL - POMPE

| POS Codice | Q.tà |  Descrizione |  Description |  Designation |  Benennung |  Descripcìon |
|---------------|------|---|---|---|---|---|
| 25 1757250022 | 1 NR | TAPPO CONNETTORE YAZAKI 2 VIE CON DIODO 1.5A | PLUG | BOUCHON | DECKEL | TAPA |
| 26 05760700 | 1 NR | FUSIBILE A LAMA 5A | FUSE 5A | FUSIBLE 5A | SICHERUNG 5A | FUSIBLE 5A |
| 27 17535700 | 1 NR | KIT RELE' AGGIUNTIVO PER SPEGNIMENTO MOTORE HONDA IGX440 | ADDITIONAL RELAY KIT FOR POWER-OFF HONDA MOTOR IGX440 | RELAIS | RELAIS | RELÉ |
| 28 07798300 | 1 NR | PROTEZIONE CARBURATORE LL1775 | CARBURETOR PROTECTION FOR LL1775 | | | |

 RICAMBI MOTORE

MOTORERSATZTEILE 

 ENGINE SPARE PARTS

REPUESTOS MOTOR 

 PIÈCES DÉTACHÉES DU MOTEUR

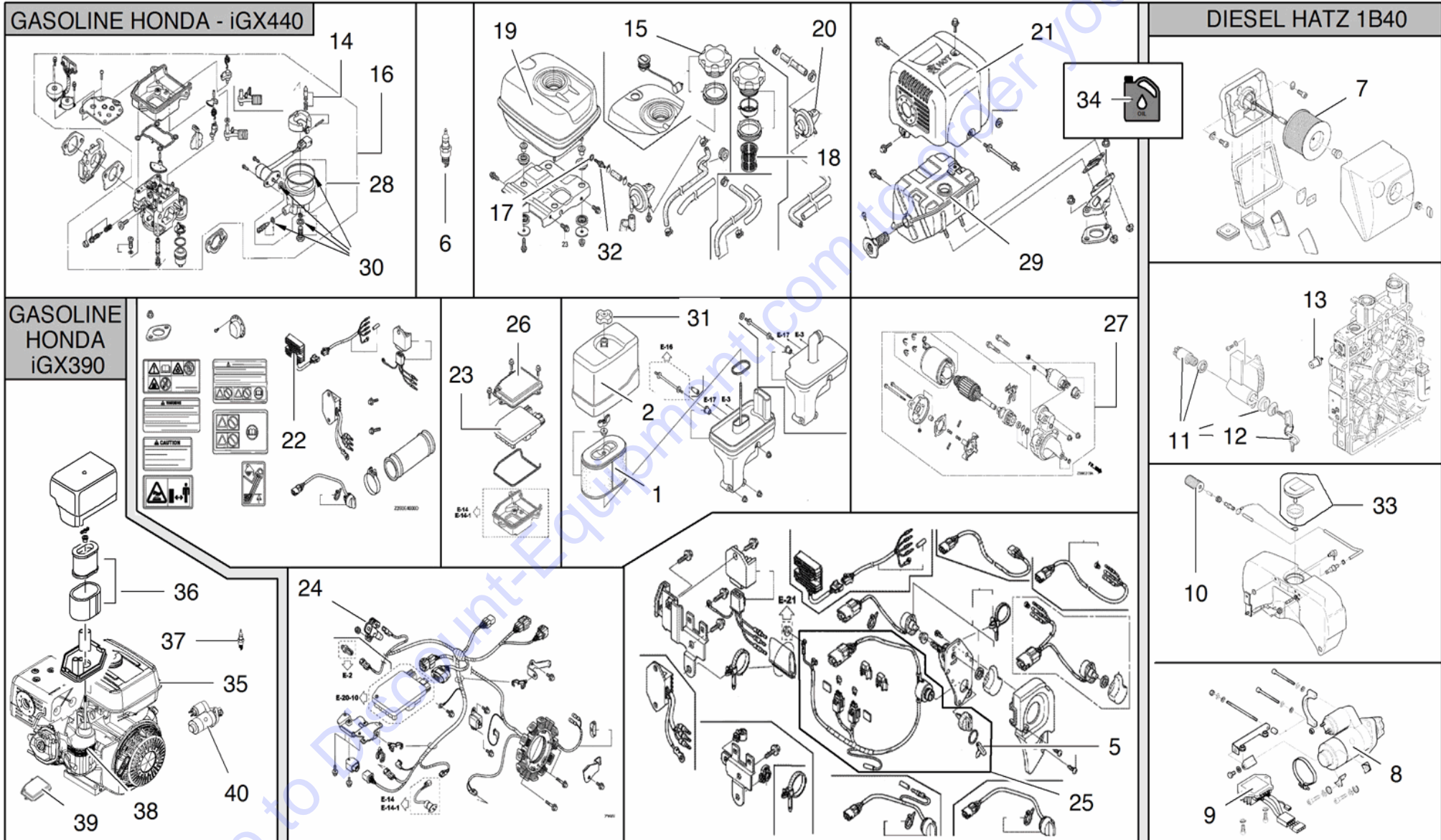





 RICAMBI MOTORE

 MOTORERSATZTEILE

 ENGINE SPARE PARTS

 REPUESTOS MOTOR

 PIÈCES DÉTACHÉES DU MOTEUR

| POS Codice | Q.tà |  Descrizione |  Description |  Designation |  Benennung |  Descripción |
|---------------|------|---|---|---|---|---|
| 1 2595260001 | 1 NR | FILTRO ARIA | AIR FILTER | FILTER À AIR | LUFTFILTER | FILTRO AIRE |
| 2 2595260002 | 1 NR | COPERCHIO | COVER | COUVERCLE | DECKEL | TAPA |
| 5 2595260003 | 1 NR | CHIAVE ACCENSIONE MOTORE | KEY IGNITION ENGINE | CLÉ MOTEUR D'ALLUMAGE | ZÜNDUNGSSCHA LTER ENGINE | MOTOR LLAVE |
| 6 2595260004 | 1 NR | CANDELA ACCENSIONE | SPARKING PLUG | BOUGIE ÉLECTRIQUE | ZÜNDKERZE | BUJÍA ENCENDIDO |
| 7 2625560002 | 1 NR | FILTRO ARIA | AIR FILTER | FILTER À AIR | LUFTFILTER | FILTRO AIRE |
| 8 2558630004 | 1 NR | MOTORINO AVVIAMENTO | STARTER MOTOR | DÉMARREUR | ANLASSER | MOTOR DE ARRANQUE |
| 9 2558630005 | 1 NR | REGOLATORE DI TENSIONE | VOLTAGE REGULATOR | RÉGULATEUR DE TENSION | SPANNUNGSREG LER | REGULADOR DE TENSIÓN |
| 9 2558630009 | 1 NR | REGOLATORE DI CORRENTE HATZ MODELLO DUCATI | CURRENT REGULATOR HATZ DUCATI MODEL | RÉGULATEUR DE TENSION MOTEUR HATZ | HYDRAULISCHER ANTRIEB | COMANDO HIDRÁULICO |
| 10 2558630003 | 1 NR | FILTRO GASOLIO | GAS OIL FILTER | FILTRE À GASOIL | KRAFTSTOFFFILT ER | FILTRO GASÓLEO |
| 11 2631430001 | 1 NR | BLOCCHETTO CHIAVE | BLOCK | BLOC | BLOCK | BLOQUE |
| 12 2631430002 | 1 NR | CHIAVE ACCENSIONE | IGNITION KEY | CLEF DE DÉMARRAGE | ZÜNDSCHLÜSSE L | CLAVE DE ENCENDIDO |
| 13 2558630008 | 1 NR | SOLENOIDE | SOLENOID | SOLENOÏDE | SOLENOID | SOLENOIDE |





 RICAMBI MOTORE

 MOTORERSATZTEILE

 ENGINE SPARE PARTS

 REPUESTOS MOTOR

 PIÈCES DÉTACHÉES DU MOTEUR

| POS Codice | Q.tà |  Descrizione |  Description |  Designation |  Benennung |  Descripción |
|---------------|------|---|---|---|---|---|
| 14 2558640008 | 1 NR | SPILLO | SPILLO | AIGUILLE | NADEL | AGUJA |
| 15 2558640012 | 1 NR | TAPPO SERBATOIO BENZINA | FUEL TANK CAP | BOUCHON RESERVOIR CARBURANT | TANKDECKEL | TANQUE CAP |
| 16 2595260005 | 1 NR | CARBURATORE PER IGX440 | CARBURETOR FOR IGX440 | CARBURATEUR POUR IGX440 | VERGASER FÜR IGX440 | CARBURADOR PARA IGX440 |
| 17 2558640031 | 1 NR | O-RING PER FILTRO BENZINA | O-RING FOR FUEL FILTER | O-RING POUR FILTRE A CARBURANT | O-RING FÜR KRAFTSTOFF FILTER | ANILLO DE FILTRO DE COMBUSTIBLE |
| 18 2595260006 | 1 NR | FILTRO BENZINA SERBATOIO | FILTER FUEL TANK | RESERVOIR DE CARBURANT FILTRE | FILTER FUEL TANK | TANQUE DE COMBUSTIBLE FILTRO |
| 19 2595260008 | 1 NR | SERBATOIO BENZINA IGX440IU | FUEL TANK IGX440IU | RESERVOIR DE CARBURANT IGX440IU | FUEL TANK IGX440IU | TANQUE DE COMBUSTIBLE IGX440IU |
| 20 2595260007 | 1 NR | ASSIEME RUBINETTO AUTOMATICO CARBURANTE | AUTOMATIC FUEL VALVE ASSEMBLY | ROBINET AUTOMATIQUE | AUTOMATISCHER WASSERHAHN | GRIFO AUTOMÁTICO |
| 21 2595260009 | 1 NR | PROTEZIONE MARMITTA HONDA IGX440 | PROTECTION MUFFLER HONDA IGX440 | PROTECTION D'ECHAPPEMENT T | HITZESCHUTZGIT TER | PROTECCIÓN DEL SILENCIADOR |
| 22 2595260012 | 1 NR | REGOLATORE MOTORI HONDA IGX440 | REGULATOR HONDA MOTORS IGX440 | REGULATEUR | REGULATOR | REGULADOR |

PARTS FINDER

**Search Website
by Part Number**



**Search Manual
Library For Parts
Manual & Lookup Part
Numbers – Purchase
or Request Quote**

Search Manuals

Enter your information to help us find the right parts manual for your machine.

* Brand:

* Model:

* Serial:

* Part Number:

SEARCH

**Can't Find Part or
Manual? Request Help
by Manufacturer,
Model & Description**

Parts Order Form

Please fill in the following information to help us find the right part for your machine.

| | |
|---------------|----------------------|
| Manufacturer: | <input type="text"/> |
| Model: | <input type="text"/> |
| Description: | <input type="text"/> |
| Part Number: | <input type="text"/> |
| Quantity: | <input type="text"/> |
| Notes: | <input type="text"/> |

Submit

Discount-Equipment.com is your online resource for quality parts & equipment.

Florida: **561-964-4949** Outside Florida TOLL FREE: **877-690-3101**

Need parts?

Click on this link: <http://www.discount-equipment.com/category/5443-parts/> and choose one of the options to help get the right parts and equipment you are looking for. Please have the machine model and serial number available in order to help us get you the correct parts. If you don't find the part on the website or on one of the online manuals, please fill out the request form and one of our experienced staff members will get back to you with a quote for the right part that your machine needs.

We sell worldwide for the brands: Genie, Terex, JLG, MultiQuip, Mikasa, Essick, Whiteman, Mayco, Toro Stone, Diamond Products, Generac Magnum, Airman, Haulotte, Barreto, Power Blanket, Nifty Lift, Atlas Copco, Chicago Pneumatic, Allmand, Miller Curber, Skyjack, Lull, Skytrak, Tsurumi, Husquvarna Target, Stow, Wacker, Sakai, Mi-T-M, Sullair, Basic, Dynapac, MBW, Weber, Bartell, Bennar Newman, Haulotte, Ditch Runner, Menegotti, Morrison, Contec, Buddy, Crown, Edco, Wyco, Bomag, Laymor, EZ Trench, Bil-Jax, F.S. Curtis, Gehl Pavers, Heli, Honda, ICS/PowerGrit, IHI, Partner, Imer, Clipper, MMD, Koshin, Rice, CH&E, General Equipment, Amida, Coleman, NAC, Gradall, Square Shooter, Kent, Stanley, Tamco, Toku, Hatz, Kohler, Robin, Wisconsin, Northrock, Oztec, Toker TK, Rol-Air, APT, Wylie, Ingersoll Rand / Doosan, Innovatech, Con X, Ammann, Mecalac, Makinex, Smith Surface Prep, Small Line, Wanco, Yanmar





 RICAMBI MOTORE

 MOTORERSATZTEILE

 ENGINE SPARE PARTS

 REPUESTOS MOTOR

 PIÈCES DÉTACHÉES DU MOTEUR

| POS Codice | Q.tà |  Descrizione |  Description |  Designation |  Benennung |  Descripción |
|---------------|------|---|---|---|---|---|
| 23 2595260013 | 1 NR | SCHEDA CARBURATORE GX440 | BOARD CARBURETOR GX440 | CARTE DE CARBURANT | VERGASER KARTE | TARJETA DE COMBUSTIBLE |
| 24 2595260024 | 1 NR | BOBINA ACCENSIONE MOTORE IGX440 | IGNITION COIL MOTOR IGX440 | BOBINE D'ALLUMAGE MOTEUR IGX440 | ZÜNDSPULE MOTOR IGX440 | BOBINA MOTOR IGX440 |
| 25 2595260015 | 1 NR | ASSIEME INTERUTTORI MOTORE IGX440 DA MATRICOLA MOTORE N°1002823 | MOTOR ASSEMBLY SWITCHES IGX440 FROM ENGINE SERIAL N ° 1002823 | COMMUTATEURS MOTEUR IGX440 | SCHALTER MOTOR IGX440 | INTERRUPTORES MOTOR IGX440 |
| 26 2595260014 | 1 NR | COPERCHIO CARBURATORE GX440 | COVER CARBURETOR GX440 | COVER CARBURATEUR GX440 | COVER VERGASER GX440 | CUBIERTA CARBURADOR GX440 |
| 27 2595260025 | 1 NR | MOTORINO AVVIAMENTO MOTORE HONDA IGX440 | STARTER MOTOR HONDA IGX440 | STARTER MOTOR HONDA IGX440 | STARTER MOTOR HONDA IGX440 | MOTOR HONDA IGX440 |
| 28 2595260027 | 1 NR | VASCHETTA CARBURATORE | TANK CARBURATOR | TANQUE DE COMBUSTÍVEL | FUEL TANK | TANQUE DE COMBUSTIBLE |
| 29 2595260028 | 1 NR | MARMITTA PER HONDA 440 | SILENCER FOR HONDA 440 | SILENCIEUX POUR HONDA 440 | MUFFLER FÜR HONDA 440 | SILENCIADOR PARA HONDA 440 |





 RICAMBI MOTORE

 MOTORERSATZTEILE

 ENGINE SPARE PARTS

 REPUESTOS MOTOR

 PIÈCES DÉTACHÉES DU MOTEUR

| POS Codice | Q.tà |  Descrizione |  Description |  Designation |  Benennung |  Descripción |
|---------------|------|---|---|---|---|---|
| 30 2595260026 | 1 NR | KIT GUARNIZIONI CARBURATORE | CARBURATOR GASKET KIT | CARBURETOR TROUSSE DE JOINT | VERGASERDICHT SATZ KIT | CARBURADOR KIT DE JUNTAS |
| 31 2595260029 | 1 NR | DADO PER COPERCHIO FILTRO ARIA | NUT FOR AIR FILTER COVER | NUT POUR FILTRE A AIR COVER | NUT FOR LUFTFILTERDEC KEL | TUERCA DE FILTRO DE AIRE CUBIERTA |
| 32 2598600002 | 1 NR | RACCORDO PER SERBATOIO | FITTING FOR TANK | MONTAGE DE RÉSERVOIR | PASSEND FÜR TANK | MONTAJE DE TANQUE |
| 33 2631430004 | 1 NR | TAPPO SERBATOIO GASOLIO | FUEL TANK CAP | BOUCHON RÉSERVOIR GASOIL HATZ 1B30-1B40 | TANKDECKEL | TAPA DEPÓSITO GASOIL |
| 35 2775200002 | 1 NR | SERBATOIO BENZINA COMPLETO HONDA IGX390 | FUEL TANK COMPLETE HONDA IGX390 | | | |
| 36 2775200001 | 1 NR | CARTUCCIA FILTRO ARIA COMPLETA HONDA IGX390 | AIR FILTER CARTRIDGE COMPLETE HONDA IGX390 | | | |
| 37 2558640032 | 1 NR | | | | | |
| 38 2775200003 | 1 NR | CARBURATORE COMPLETO HONDA IGX390 | CARBURETOR COMPLETE HONDA IGX390 | | | |





 RICAMBI MOTORE

 MOTORERSATZTEILE

 ENGINE SPARE PARTS

 REPUESTOS MOTOR

 PIÈCES DÉTACHÉES DU MOTEUR

| POS Codice | Q.tà |  Descrizione |  Description |  Designation |  Benennung |  Descripció |
|---------------|------|---|---|---|---|--|
| 39 2775200004 | 1 NR | CENTRALINA ELETTRONICA HONDA IGX390 | ELECTRONIC CONTROL UNIT HONDA IGX390 | | | |
| 40 2775200005 | 1 NR | MOTORINO DI AVVIAMENTO COMPLETO HONDA IGX390 | ELECTRIC STARTER COMPLETE HONDA IGX390 | | | |

Go to Discount-Equipment.com to order your parts

 MOTORE ELETTRICO

E-MOTOR 



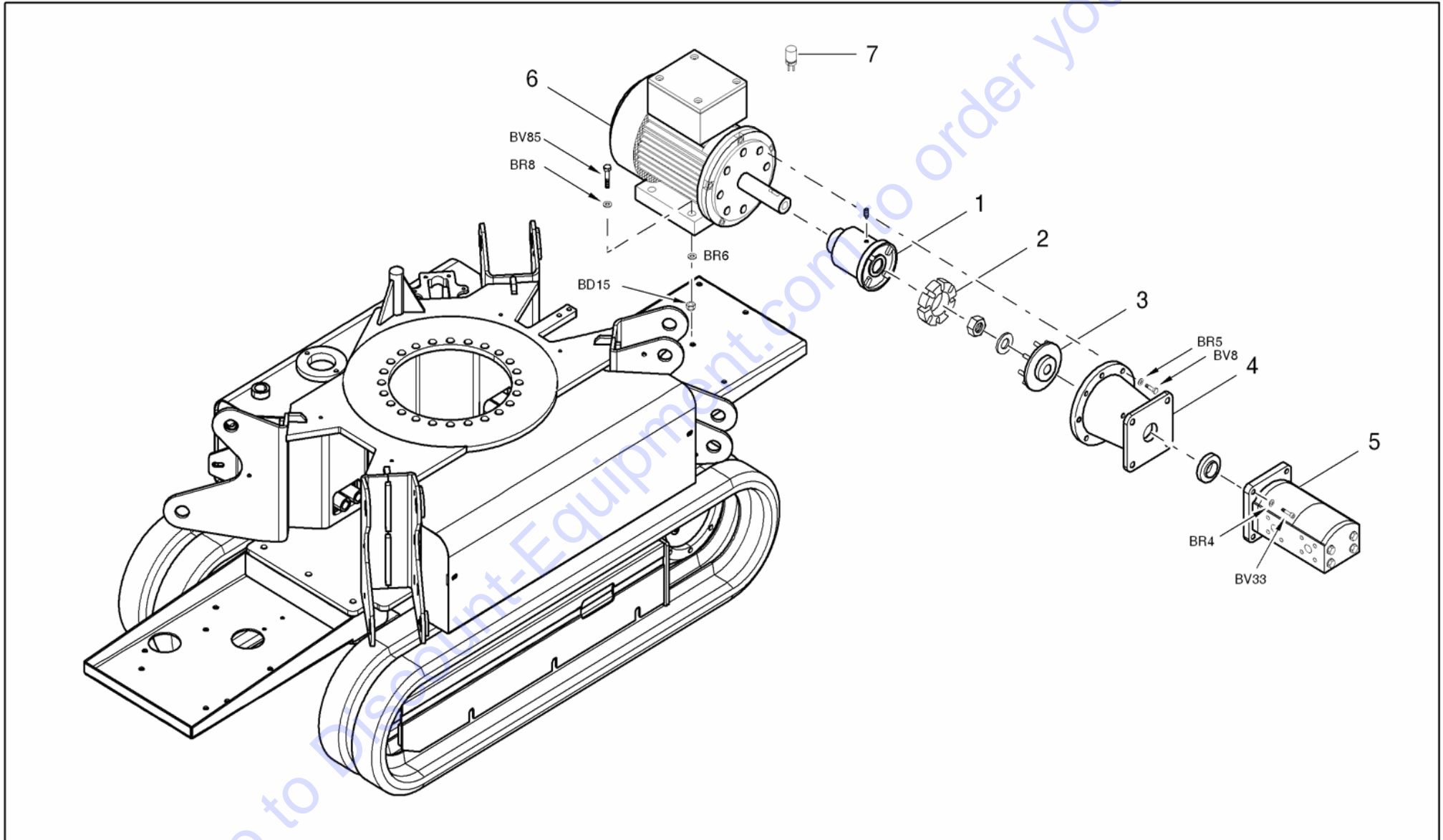

 ELECTRIC MOTOR

MOTOR ELÉCTRICO 





 MOTEUR ÉLECTRIQUE



 MOTORE ELETTRICO
E-MOTOR 
 ELECTRIC MOTOR
MOTOR ELÉCTRICO 
 MOTEUR ÉLECTRIQUE

| POS Codice | Q.tà |  Descrizione |  Description |  Designation |  Benennung |  Descripción |
|------------|------|---|---|---|---|---|
| 1 05563400 | 1 NR | SEMIGIUNTO VERSIONE MOTORE ELETTRICO STANDARD | HALF COUPLING ELECTRIC MOTOR STANDARD VERSION | DEMI-JOINT | HALBKUPPLUNG | SEMI-ACOPLAMIE NTO |
| 1 06997800 | 1 NR | SEMIGIUNTO VERSIONE LITIO | HALF COUPLING LITHIUM VERSION | DEMI-JOINT | HALBKUPPLUNG | SEMI-ACOPLAMIE NTO |
| 2 04310100 | 1 NR | INSERTO IN GOMMA | RUBBER INSERT | INSERT EN CAOUTCHOUC | GUMMIEINSATZ | INSERTO DE GOMA |
| 3 04615300 | 1 NR | GIUNTO | COUPLING | JOINT | VERBINDUNG | ACOPLAMIENTO |
| 4 05510200 | 1 NR | LANTERNA | LANTERN | LANTERNE | LATERNE | LINTERNA |
| 4 07768000 | 1 NR | LANTERNA ACCOPIAMENT O MOTORE ELETTRICO LL1775 MK2 (DA C170000893) | COUPLING ELECTRIC MOTOR LL1775 MK2 (FROM C170000893) | | | |
| 5 25526300 | 1 NR | POMPA IDRAULICA | HYDRAULIC PUMP | POMPE HYDRAULIQUE | HYDRAULIKPUMP E | BOMBA HYDRÁULICA |
| 5 26328100 | 1 NR | POMPA IDRAULICA PER MOTORE 120V | HYDRAULIC PUMP FOR ELECTRIC MOTOR 120V | POMPE HYDRAULIQUE | HYDRAULIKPUMP E | BOMBA HYDRÁULICA |

 MOTORE ELETTRICO
E-MOTOR 
 ELECTRIC MOTOR
MOTOR ELÉCTRICO 
 MOTEUR ÉLECTRIQUE

| POS | Codice | Q.tà |  Descrizione |  Description |  Designation |  Benennung |  Descripcìon |
|-----|----------|------|---|---|---|---|---|
| 6 | 25510100 | 1 NR | MOTORE ELETTRICO 230V 50HZ | ELECTRIC MOTOR 230V 50HZ | MOTEUR ÉLECTRIQUE 230V 50HZ | E-MOTOR 230V 50HZ | MOTOR ELÉCTRICO 230V 50HZ |
| 6 | 25576400 | 1 NR | MOTORE ELETTRICO 110V | ELECTRIC MOTOR 110V | MOTEUR ÉLECTRIQUE 110V | E-MOTOR 110V | MOTOR ELÉCTRICO 110V |
| 6 | 26328300 | 1 NR | MOTORE ELETTRICO 120V 60HZ 1.2KW 16A | ELECTRIC MOTOR 120V 60HZ 1.2KW 16A | MOTEUR ÉLECTRIQUE | E-MOTOR | MOTOR ELÉCTRICO |
| 6 | 26774500 | 1 NR | MOTORE ELETTRICO LITHIUM 2KW | ELECTRIC MOTOR LITHIUM 2KW | MOTEUR ÉLECTRIQUE | E-MOTOR | MOTOR ELÉCTRICO |
| 6 | 27691100 | 1 NR | MOTORE ELETTRICO 230V 50HZ MK2 (DA C170000893) | ELECTRIC MOTOR 230V 50HZ MK2 (FROM C170000893) | MOTEUR ÉLECTRIQUE 230V 50HZ MK2 (FROM C170000893) | E-MOTOR 230V 50HZ MK2 (FROM C170000893) | MOTOR ELÉCTRICO 230V 50HZ MK2 (FROM C170000893) |





 MOTORE ELETTRICO

E-MOTOR 

 ELECTRIC MOTOR

MOTOR ELÉCTRICO 

 MOTEUR ÉLECTRIQUE

| POS Codice | Q.tà |  Descrizione |  Description |  Designation |  Benennung |  Descripcìon |
|--------------|------|---|---|---|---|---|
| 7 2551010001 | 1 NR | CONDENSATORE 230V MF80 D=55 | CONDENSER 230V MF80 D=55 | CONDENSATEUR | KONDENSATOR | CONDENSADOR |
| 7 2557640001 | 1 NR | CONDENSATORE 110V MF200 D=65 | CAPACITOR 110V MF200 D=65 | CONDENSATEUR | CAPACITOR | CAPACITOR |
| 7 2557640002 | 1 NR | CONDENSATORE 110V MF500 | CAPACITOR 110V MF500 | CONDENSATEUR | CAPACITOR | CAPACITOR |
| 7 2632830001 | 1 NR | CONDENSATORE PER MOTORE 120V MF120 D=55 | CAPACITOR MOTOR 120V MF120 D = 55 | CONDENSATEUR | KONDENSATOR | CONDENSADOR |
| 7 2632830002 | 1 NR | CONDENSATORE PER MOTORE 120V MF160 D=60 | CAPACITOR MOTOR 120V MF160 D = 60 | CONDENSATEUR | KONDENSATOR | CONDENSADOR |

 IMPIANTO IDRAULICO MANDATE E SCARICO

HYDRAULIKANLAGE VORLÄUFE UND RÜCKLAUF 

 SUPPLY AND DISCHARGE HYDRAULIC SYSTEM

INSTALCIÓN HIDRÁULICA IMPULSIONES Y DESCARGA 

 SYSTÈME HYDRAULIQUE REFOULEMENT ET DÉCHARGEME

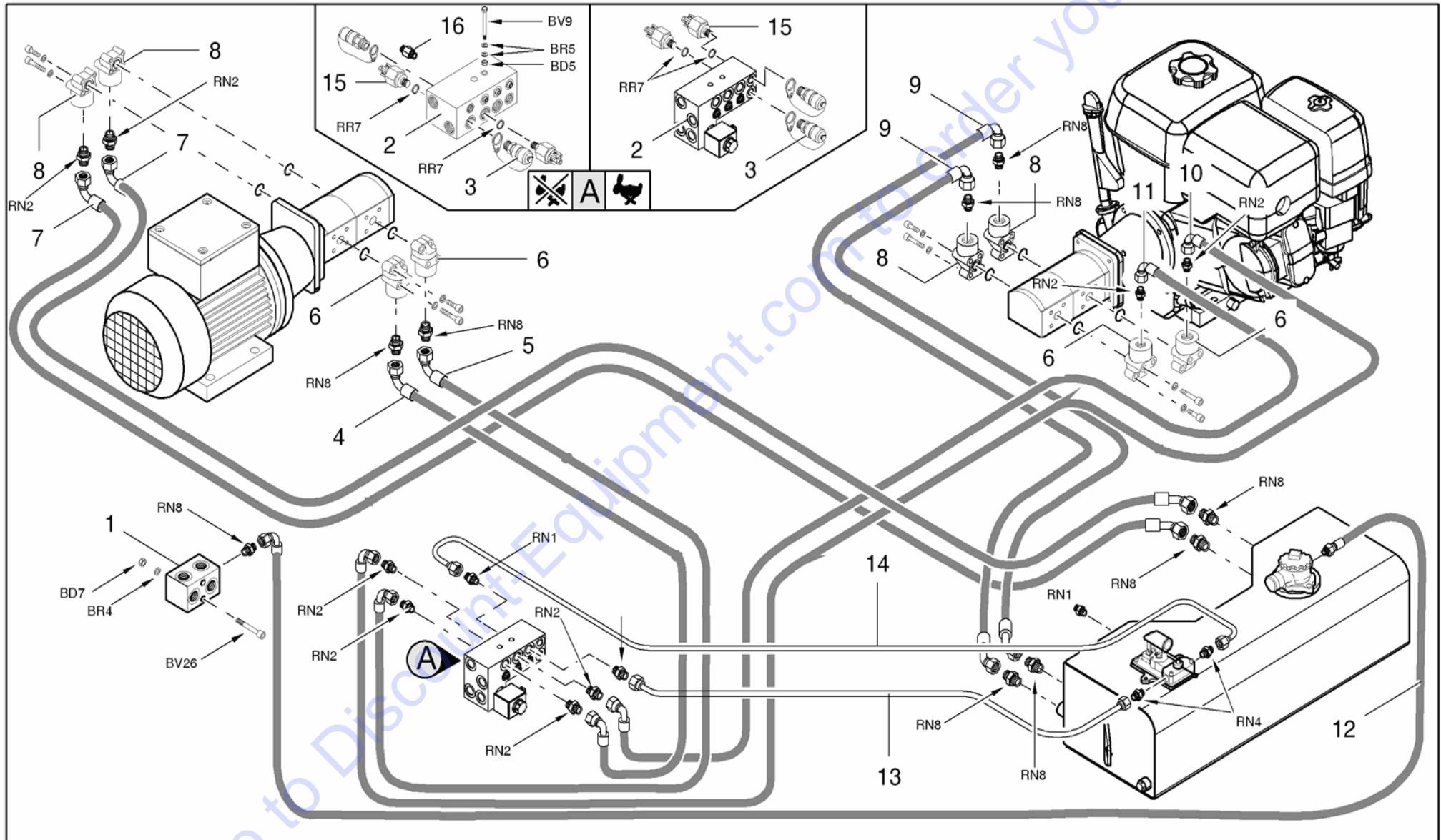





 IMPIANTO IDRAULICO MANDATE E SCARICO

HYDRAULIKANLAGE VORLÄUFE UND RÜCKLAUF 

 SUPPLY AND DISCHARGE HYDRAULIC SYSTEM

INSTALACIÓN HIDRÁULICA IMPULSIONES Y DESCARGA 

 SYSTÈME HYDRAULIQUE REFOULEMENT ET DÉCHARGEME

| POS Codice | Q.tà |  Descrizione |  Description |  Designation |  Benennung |  Descripción |
|-------------|------|---|---|---|---|---|
| 1 05497500 | 1 NR | BLOCCHETTO TUBI | HOSES BLOCK | BLOC TUYAUX | ROHRBLOCK | BLOQUE TUBOS |
| 2 16478200 | 1 NR | VALVOLA IDRAULICA | HYDRAULIC VALVE | VALVE HYDRAULIQUE | HYDRAULIKVENTI L | VÁLVULA HIDRÁULICA |
| 3 03014400 | 2 NR | PROVA PRESSIONE 1/4" G | PRESSURE TEST 1/4" G | PREUVE PRESSION 1/4" G | DRUCKKONTROL LE 1/4" G | PRUEBA PRESIÓN 1/4" G |
| 4 07165600 | 1 NR | TUBO FLESSIBILE | FLEXIBLE PIPE | TUYAU FLEXIBLE | SCHLAUCH | TUBO FLEXIBLE |
| 5 07165700 | 1 NR | TUBO FLESSIBILE | FLEXIBLE PIPE | TUYAU FLEXIBLE | SCHLAUCH | TUBO FLEXIBLE |
| 6 04048100 | 2 NR | FLANGIA 3/8" G | FLANGE 3/8" G | BRIDE 3/8" G | FLANSCH 3/8" G | BRIDA 3/8" G |
| 7 07164800 | 2 NR | TUBO FLESSIBILE | FLEXIBLE PIPE | TUYAU FLEXIBLE | SCHLAUCH | TUBO FLEXIBLE |
| 8 04845400 | 2 NR | FLANGIA 1/2"G | FLANGE 1/2"G | BRIDE 1/2"G | FLANSCH 1/2"G | BRIDA 1/2"G |
| 9 07164700 | 2 NR | TUBO FLESSIBILE | FLEXIBLE PIPE | TUYAU FLEXIBLE | SCHLAUCH | TUBO FLEXIBLE |
| 10 07165500 | 1 NR | TUBO FLESSIBILE | FLEXIBLE PIPE | TUYAU FLEXIBLE | SCHLAUCH | TUBO FLEXIBLE |
| 11 07165400 | 1 NR | TUBO FLESSIBILE | FLEXIBLE PIPE | TUYAU FLEXIBLE | SCHLAUCH | TUBO FLEXIBLE |
| 12 07164900 | 1 NR | TUBO FLESSIBILE | FLEXIBLE PIPE | TUYAU FLEXIBLE | SCHLAUCH | TUBO FLEXIBLE |
| 13 07152300 | 1 NR | TUBO RIGIDO | RIGID PIPE | TUYAU RIGIDE | ROHR | TUBO RÍGIDO |
| 14 07152400 | 1 NR | TUBO RIGIDO | RIGID PIPE | TUYAU RIGIDE | ROHR | TUBO RÍGIDO |





 IMPIANTO IDRAULICO MANDATE E SCARICO

HYDRAULIKANLAGE VORLÄUFE UND RÜCKLAUF 

 SUPPLY AND DISCHARGE HYDRAULIC SYSTEM

INSTALACIÓN HIDRÁULICA IMPULSIONES Y DESCARGA 

 SYSTÈME HYDRAULIQUE REFOULEMENT ET DÉCHARGEME

| POS Codice | Q.tà |  Descrizione |  Description |  Designation |  Benennung |  Descripción |
|-------------|------|---|---|---|---|---|
| 15 26964400 | 2 NR | PRESSOSTATO | PRESSURE SWITCH | PRESSOSTAT | DRUCKSCHALTE R | PRESÓSTATO |
| 16 04845400 | 2 NR | FLANGIA 1/2"G | FLANGE 1/2"G | BRIDE 1/2"G | FLANSCH 1/2"G | BRIDA 1/2"G |

Go to Discount-Equipment.com to order your parts

 IMPIANTO IDRAULICO MANDATE E SCARICO

HYDRAULIKANLAGE VORLÄUFE UND RÜCKLAUF 

 SUPPLY AND DISCHARGE HYDRAULIC SYSTEM

INSTALACIÓN HIDRÁULICA IMPULSIONES Y DESCARGA 

 SYSTÈME HYDRAULIQUE REFOULEMENT ET DÉCHARGEMENT

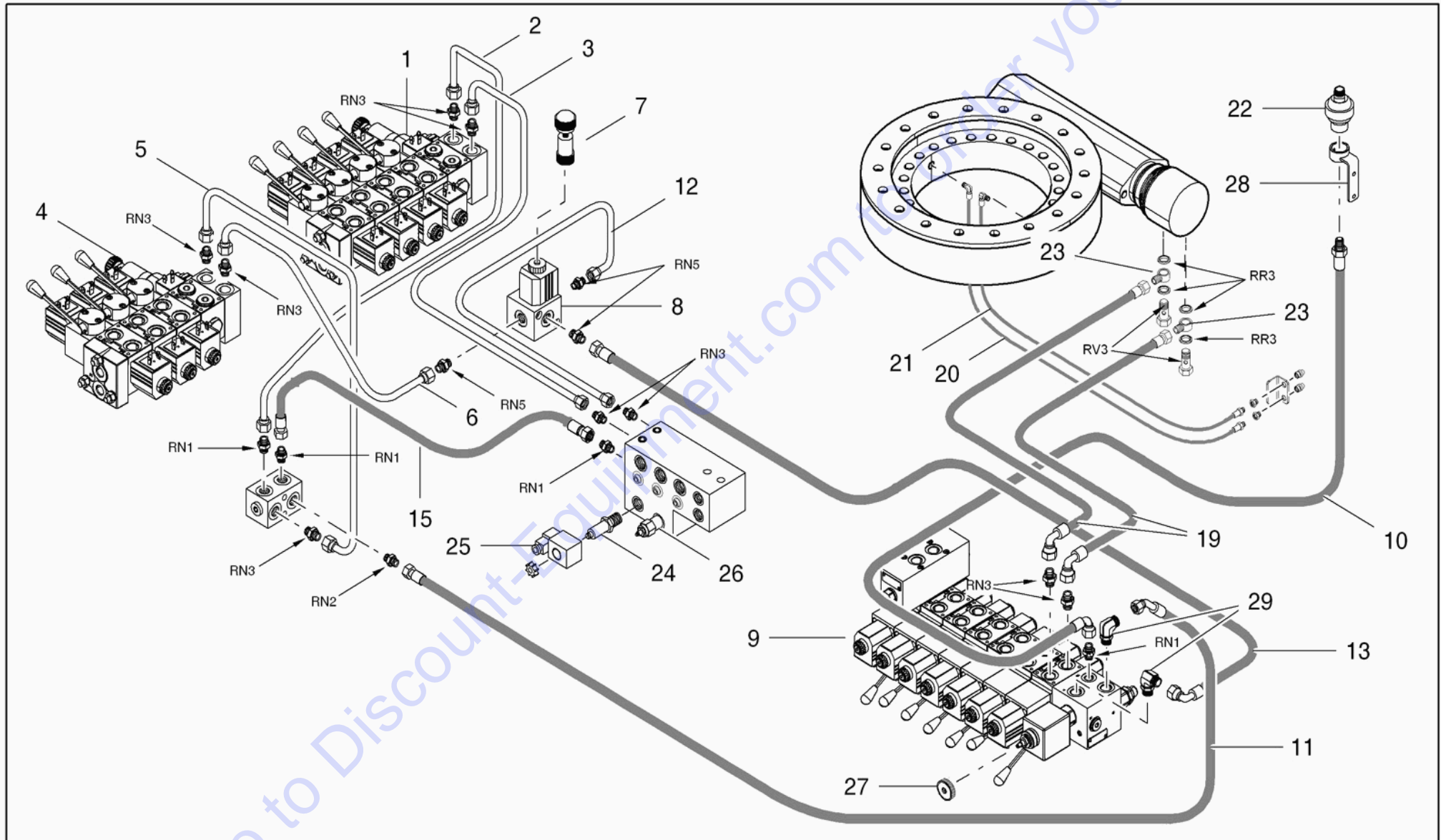





 IMPIANTO IDRAULICO MANDATE E SCARICO

HYDRAULIKANLAGE VORLÄUFE UND RÜCKLAUF 

 SUPPLY AND DISCHARGE HYDRAULIC SYSTEM

INSTALACIÓN HIDRÁULICA IMPULSIONES Y DESCARGA 

 SYSTÈME HYDRAULIQUE REFOULEMENT ET DÉCHARGEMENT

| POS Codice | Q.tà |  Descrizione |  Description |  Designation |  Benennung |  Descripción |
|------------|------|--|--|---|---|---|
| 1 27299100 | 1 NR | DISTRIBUTORE LC STABILIZZATORI-T RAINO 4 ELEMENTI CON LEVE EMERGENZA A PULSANTE | HYDRAULIC DISTRIBUTOR STABILIZERS-TRA CKS 4 PARTS WITH LEVERS EMERGENCY BUTTON | DISTRIBUTEUR HYDRAULIQUE | HYDRAULIKVENTI LBLOCK | DISTRIBUIDOR HIDRÁULICO |
| 2 07168300 | 1 NR | TUBO RIGIDO | RIGID PIPE | TUYAU RIGIDE | ROHR | TUBO RÍGIDO |
| 3 07151800 | 1 NR | TUBO RIGIDO | RIGID PIPE | TUYAU RIGIDE | ROHR | TUBO RÍGIDO |
| 4 27299000 | 1 NR | DISTRIBUTORE LC STABILIZZATORI-T RAINO 3 ELEMENTI CON LEVE EMERGENZA A PULSANTE | HYDRAULIC DISTRIBUTOR STABILIZERS-TRA CKS 3 PARTS WITH LEVERS EMERGENCY BUTTON | DISTRIBUTEUR HYDRAULIQUE | HYDR. REGELSTEUERG ERÄT | DISTRIBUIDOR HIDRÁULICO |
| 5 07151500 | 1 NR | TUBO RIGIDO | RIGID PIPE | TUYAU RIGIDE | ROHR | TUBO RÍGIDO |
| 6 07151700 | 1 NR | TUBO RIGIDO | RIGID PIPE | TUYAU RIGIDE | ROHR | TUBO RÍGIDO |
| 7 25908400 | 1 NR | DISPOSITIVO DI COMANDO MANUALE IDRAULICO | HAND CONTROL HYDRAULIC | COMMANDE HYDRAULIQUE | HYDRAULISCHER ANTRIEB | COMANDO HIDRÁULICO |





 IMPIANTO IDRAULICO MANDATE E SCARICO

HYDRAULIKANLAGE VORLÄUFE UND RÜCKLAUF 





 SUPPLY AND DISCHARGE HYDRAULIC SYSTEM

INSTALACIÓN HIDRÁULICA IMPULSIONES Y DESCARGA 

 SYSTÈME HYDRAULIQUE REFOULEMENT ET DÉCHARGEMENT

| POS Codice | Q.tà |  Descrizione |  Description |  Designation |  Benennung |  Descripción |
|-------------|------|--|--|---|---|---|
| 8 25732900 | 1 NR | DEVIATORE IDRAULICO | HYDRAULIC DIVERTER | DÉVIATEUR | WECHSELSCHLEISER | DESVIADOR |
| 9 27323500 | 1 NR | DISTRIBUTORE IDRAULICO 7 ELEMENTI PARTE AEREA CON PULSANTE | HYDRAULIC DISTRIBUTOR 7 ELEMENTS AERIAL PART WITH BUTTON | DISTRIBUTEUR HYDRAULIQUE | HYDRAULISCHER VERTEILER | DISTRIBUIDOR HIDRÁULICO |
| 9 27533400 | 1 NR | DISTRIBUTORE IDRAULICO 7 ELEMENTI PARTE AEREA CON PULSANTE (FOR LL1775-X17JP-X5 00AJ-LL2010-X20 JP-X600AJ MK2 FROM C170000893) | HYDRAULIC DISTRIBUTOR 7 ELEMENTS AERIAL PART WITH BUTTON (FOR LL1775-X17JP-X5 00AJ-LL2010-X20 JP-X600AJ MK2 FROM C170000893) | DISTRIBUTEUR HYDRAULIQUE (FOR LL1775-X17JP-X5 00AJ-LL2010-X20 JP-X600AJ MK2 FROM C170000893) | HYDRAULISCHER VERTEILER (FOR LL1775-X17JP-X5 00AJ-LL2010-X20 JP-X600AJ MK2 FROM C170000893) | DISTRIBUIDOR HIDRÁULICO (FOR LL1775-X17JP-X5 00AJ-LL2010-X20 JP-X600AJ MK2 FROM C170000893) |
| 10 07166500 | 1 NR | TUBO FLESSIBILE | FLEXIBLE PIPE | TUYAU FLEXIBLE | SCHLAUCH | TUBO FLEXIBILE |
| 11 07166700 | 1 NR | TUBO FLESSIBILE | FLEXIBLE PIPE | TUYAU FLEXIBLE | SCHLAUCH | TUBO FLEXIBILE |
| 11 07723700 | 1 NR | TUBO FLESSIBILE (MK2 FROM C170000893) | FLEXIBLE PIPE (MK2 FROM C170000893) | TUYAU FLEXIBLE (MK2 FROM C170000893) | SCHLAUCH (MK2 FROM C170000893) | TUBO FLEXIBILE (MK2 FROM C170000893) |
| 12 07151900 | 1 NR | TUBO RIGIDO | RIGID PIPE | TUYAU RIGIDE | ROHR | TUBO RÍGIDO |

 IMPIANTO IDRAULICO MANDATE E SCARICO
HYDRAULIKANLAGE VORLÄUFE UND RÜCKLAUF 
 SUPPLY AND DISCHARGE HYDRAULIC SYSTEM
INSTALACIÓN HIDRÁULICA IMPULSIONES Y DESCARGA 
 SYSTÈME HYDRAULIQUE REFOULEMENT ET DÉCHARGEMENT

| POS Codice | Q.tà |  Descrizione |  Description |  Designation |  Benennung |  Descripción |
|---------------|------|---|---|---|---|---|
| 13 07166800 | 1 NR | TUBO FLESSIBILE | FLEXIBLE PIPE | TUYAU FLEXIBLE | SCHLAUCH | TUBO FLEXIBLE |
| 13 07723800 | 1 NR | TUBO FLESSIBILE (MK2 FROM C170000893) | FLEXIBLE PIPE (MK2 FROM C170000893) | TUYAU FLEXIBLE (MK2 FROM C170000893) | SCHLAUCH (MK2 FROM C170000893) | TUBO FLEXIBLE (MK2 FROM C170000893) |
| 15 07225500 | 1 NR | TUBO FLESSIBILE | FLEXIBLE PIPE | TUYAU FLEXIBLE | SCHLAUCH | TUBO FLEXIBLE |
| 15 07738700 | 1 NR | TUBO FLESSIBILE | FLEXIBLE PIPE | TUYAU FLEXIBLE | SCHLAUCH | TUBO FLEXIBLE |
| 19 07166600 | 2 NR | TUBO FLESSIBILE | FLEXIBLE PIPE | TUYAU FLEXIBLE | SCHLAUCH | TUBO FLEXIBLE |
| 19 07723600 | 2 NR | TUBO FLESSIBILE (MK2 FROM C170000893) | FLEXIBLE PIPE (MK2 FROM C170000893) | TUYAU FLEXIBLE (MK2 FROM C170000893) | SCHLAUCH (MK2 FROM C170000893) | TUBO FLEXIBLE (MK2 FROM C170000893) |
| 20 07165800 | 1 NR | TUBO FLESSIBILE | FLEXIBLE PIPE | TUYAU FLEXIBLE | SCHLAUCH | TUBO FLEXIBLE |
| 21 07165900 | 1 NR | TUBO FLESSIBILE | FLEXIBLE PIPE | TUYAU FLEXIBLE | SCHLAUCH | TUBO FLEXIBLE |
| 22 26062200 | 1 NR | ACCUMULATORE | ACCUMULATOR | ACCUMULTEUR | AKKUMULATOR | ACUMULADOR |
| 23 05725900 | 2 NR | RACCORDO SPECIALE PER MOTORE DI ROTAZIONE (GL E VERSIONE LITHIUM) | SPECIAL FITTING FOR MOTOR ROTATION (GL VERSION AND LITHIUM) | RACCORD | ANSCHLUSS | CONEXIÓN |
| 23 07057000 | 2 NR | RACCORDO | FITTING | RACCORD | ANSCHLUSS | CONEXIÓN |
| 24 1647820003 | 1 NR | ELETTROVALVOL A | SOLENOID VALVE | ÉLECTROVANNE | MAGNETVENTIL | ELECTROVÁLVU LA |





 IMPIANTO IDRAULICO MANDATE E SCARICO

HYDRAULIKANLAGE VORLÄUFE UND RÜCKLAUF 

 SUPPLY AND DISCHARGE HYDRAULIC SYSTEM





INSTALACIÓN HIDRÁULICA IMPULSIONES Y DESCARGA 

 SYSTÈME HYDRAULIQUE REFOULEMENT ET DÉCHARGEMENT

| POS Codice | Q.tà |  Descrizione |  Description |  Designation |  Benennung |  Descripcìon |
|---------------|------|---|---|---|---|---|
| 26 1647820001 | 1 NR | VALVOLA IDRAULICA | HYDRAULIC VALVE | VALVE HYDRAULIQUE | HYDRAULIKVENTI L | VÁLVULA HIDRÁULICA |
| 28 36470800 | 1 NR | SUPPORTO | SUPPORT | SUPPORT | HALTERUNG | SOPORTE |
| 29 04995000 | 2 NR | RACCORDO | FITTING | RACCORD | ANSCHLUSS | CONEXIÓN |

Go to Discount-Equipment.com to order your parts





 DISTRIBUTORI IDRAULICI
HYDRAULISCHE REGELSTEUERGERÄTE 
 HYDRAULIC DISTRIBUTORS
DISTRIBUIDORES HIDRÁULICOS 
 DISTRIBUTEURS HYDRAULIQUES

| POS Codice | Q.tà |  Descrizione |  Description |  Designation |  Benennung |  Descripción |
|--------------|------|--|---|---|---|---|
| 1 2666800007 | 1 NR | SEZIONE DISTRIBUTORE ROTAZIONE AEREA AB CHIUSO | CONTROL VALVE SECTION AERIAL ROTATION AB CLOSED | CORPS | GEHÄUSE | CUERPO |
| 2 07325200 | 1 NR | VALVOLA PROPORZIONALE (CARTUCCIA) PARTE AEREA PIATTAFORME CON RITORNO A MOLLA COMPLETA DI PULSANTE | PROPORTIONAL VALVE AERIAL PARTS WITH SPRING RETURN COMPLETE BUTTON | SOUPAPE PROPORTIONELL E | PROPORTIONALV ENTIL | VALVULA PROPORCIONAL |
| 3 06037900 | 1 NR | BOBINA PER VALVOLA PROPORZIONALE PARTE AEREA | COIL PROPORTIONAL VALVE FOR AERIAL PART | BOBINE | SPULE | BOBINA |
| 4 2719290001 | 1 NR | SEZIONE DISTRIBUTORE SOLO CORPO METALLICO | CONTROL VALVE SECTION ONLY METAL BODY | CORPS | GEHÄUSE | CUERPO |
| 5 2645900005 | 1 NR | SEZIONE DISTRIBUTORE AB CHIUSO CON LEVA (LATO A) E BOBINA | VALVE BLOCK SECTION AB CLOSED WITH LEVER (SIDE A) AND COIL | SECTION DISTRIBUTEUR | VENTILBLOCKSE KTION | SECCIÓN DISTRIBUIDOR |





 DISTRIBUTORI IDRAULICI

 HYDRAULISCHE REGELSTEUERGERÄTE 
 HYDRAULIC DISTRIBUTORS





 DISTRIBUIDORES HIDRÁULICOS 
 DISTRIBUTEURS HYDRAULIQUES

| POS Codice | Q.tà |  Descrizione |  Description |  Designation |  Benennung |  Descripción |
|---------------|------|---|---|---|---|---|
| 6 07324900 | 1 NR | COMANDO MANUALE EMERGENZA CON RITORNO A MOLLA | EMERGENCY MAUAL CONTROL WITH SPRING RETURN | COMMANDE MANUEL D'URGENCE | MANUELLES ANTRIEB FÜR NOTSTAND | MANDO MANUAL DE EMERGENCIA |
| 7 2645900006 | 1 NR | SEZIONE DISTRIBUTORE ABT CON LEVA (LATO A) E BOBINA | VALVE BLOCK SECTION ABT WITH LEVER (SIDE A) AND COIL | SECTION DISTRIBUTEUR | VENTILBLOCKSEKTION | SECCIÓN DISTRIBUIDOR |
| 8 2645900002 | 1 NR | CARTUCCIA VALVOLA DI MASSIMA PRESSIONE | CARTRIDGE PRESSURE RELIEF VALVE | CARTOUCHE SOUPE DE SÉCURITÉ | PARTONE ÜBERDRUCKVENTIL | CATUCHO VÁLVULA LIMITADORA DE PRESIÓN |
| 9 2666800006 | 1 NR | SEZIONE DISTRIBUTORE ABT CON LEVA (LATO B 180°) E BOBINA | SECTION DISTRIBUTOR ABT WITH LEVER (SIDE B 180°) AND COIL | CORPS | GEHÄUSE | CUERPO |
| 10 2666800005 | 1 NR | SEZIONE DISTRIBUTORE AB CHIUSO CON LEVA (LATO B 180°) E BOBINA | SECTION DISTRIBUTOR AB CHIUSO WITH LEVER (SIDE B 180°) AND COIL | CORPS | GEHÄUSE | CUERPO |

 DISTRIBUTORI IDRAULICI
HYDRAULISCHE REGELSTEUERGERÄTE 
 HYDRAULIC DISTRIBUTORS
DISTRIBUIDORES HIDRÁULICOS 
 DISTRIBUTEURS HYDRAULIQUES

| POS Codice | Q.tà |  Descrizione |  Description |  Designation |  Benennung |  Descripción |
|---------------|------|---|---|---|---|---|
| 11 2729900001 | 1 NR | VALVOLA PROPORZIONALE TRAINI CON BOBINA E SENZA COMANDO MANUALE A MOLLA | PROPORTIONAL VALVE FOR TRACK WITH COIL AND WITHOUT MANUAL SPRING | SOUPAPE PROPORTIONELL E | PROPORTIONALV ENTIL | VÁLVULA PROPORCIONAL |
| 16 2585560004 | 1 NR | BLOCCO VALVOLA BILANCIAMENTO BRACCI SU DISTRIBUTORI PARTE AEREA | BALANCING VALVE BLOCK BOOMS OF DISTRIBUTORS AERIAL PART | BLOC SOUPAPE | VENTILSPERRE | BLOQUE VÁLVULA |
| 21 06037100 | 1 NR | BOBINA PER VALVOLA PROPORZIONALE PARTE CARRO | COIL PROPORTIONAL VALVE FOR UNDERCARRIAG E | BOBINE | SPULE | BOBINA |
| 22 05913800 | 1 NR | BOBINA PER ON-OFF | COIL FOR ON-OFF | BOBINE | SPULE | BOBINA |
| 23 07300200 | 1 NR | LEVA DISTRIBUTORE | LEVER HYDRAULIC DISTRIBUTOR | LEVIER | HEBEL | PALANCA |
| 24 2585560005 | 1 NR | O-RING | O-RING | O-RING | O-RING | O-RING |

 DISTRIBUTORI IDRAULICI
HYDRAULISCHE REGELSTEUERGERÄTE 
 HYDRAULIC DISTRIBUTORS
DISTRIBUIDORES HIDRÁULICOS 
 DISTRIBUTEURS HYDRAULIQUES

| POS Codice | Q.tà |  Descrizione |  Description |  Designation |  Benennung |  Descripción |
|---------------|------|---|---|---|---|---|
| 25 1730720001 | 1 NR | ELETTROVALVOL A ON-OFF CON LED | SOLENOID ON-OFF WITH LED | ELECTROVANNE ON-OFF AVEC LED | SOLENOID ON-OFF WITH LED | SOLENOIDE ON-OFF CON LED |
| 26 2753340004 | 1 NR | ELEMENTO DISTRIBUTORE COMPLETO DI PROPORZIONALE PARTE AEREA CON LEVA ROSSA (LATO 1) | VALVE BLOCK ELEMENT | ELEMENT DISTRIBUTEUR | VENTILBLOCKSA TZ | ELEMENTO DISTRIBUIDOR |
| 27 2753340003 | 1 NR | LEVA ROSSA DISTRIBUTORE | RED LEVER HYDRAULIC DISTRIBUTOR | LEVIER | HEBEL | PALANCA |
| 28 2753340001 | 1 NR | SEZIONE DISTRIBUTORE AB CHIUSO CON LEVA (LATO 1) E BOBINA | SECTION DISTRIBUTOR AB CLOSED WITH LEVER (SIDE 1) AND COIL | SECTION DISTRIBUTEUR | VENTILBLOCKSE KTION | SECCIÓN DISTRIBUIDOR |
| 29 2753340002 | 1 NR | SEZIONE DISTRIBUTORE ABT CON LEVA (LATO 1) E BOBINA | SECTION DISTRIBUTOR ABT WITH LEVER (SIDE 1) AND COIL | SECTION DISTRIBUTEUR | VENTILBLOCKSE KTION | SECCIÓN DISTRIBUIDOR |

 IMPIANTO IDRAULICO TRAZIONE

 HYDRAULIC SYSTEM FOR TRACTION

 SYSTÈME HYDRAULIQUE DE TRACTION

HYDRAULIKANLAGE ANTRIEB 

INSTALACIÓN HIDRÁULICA TRACCIÓN 

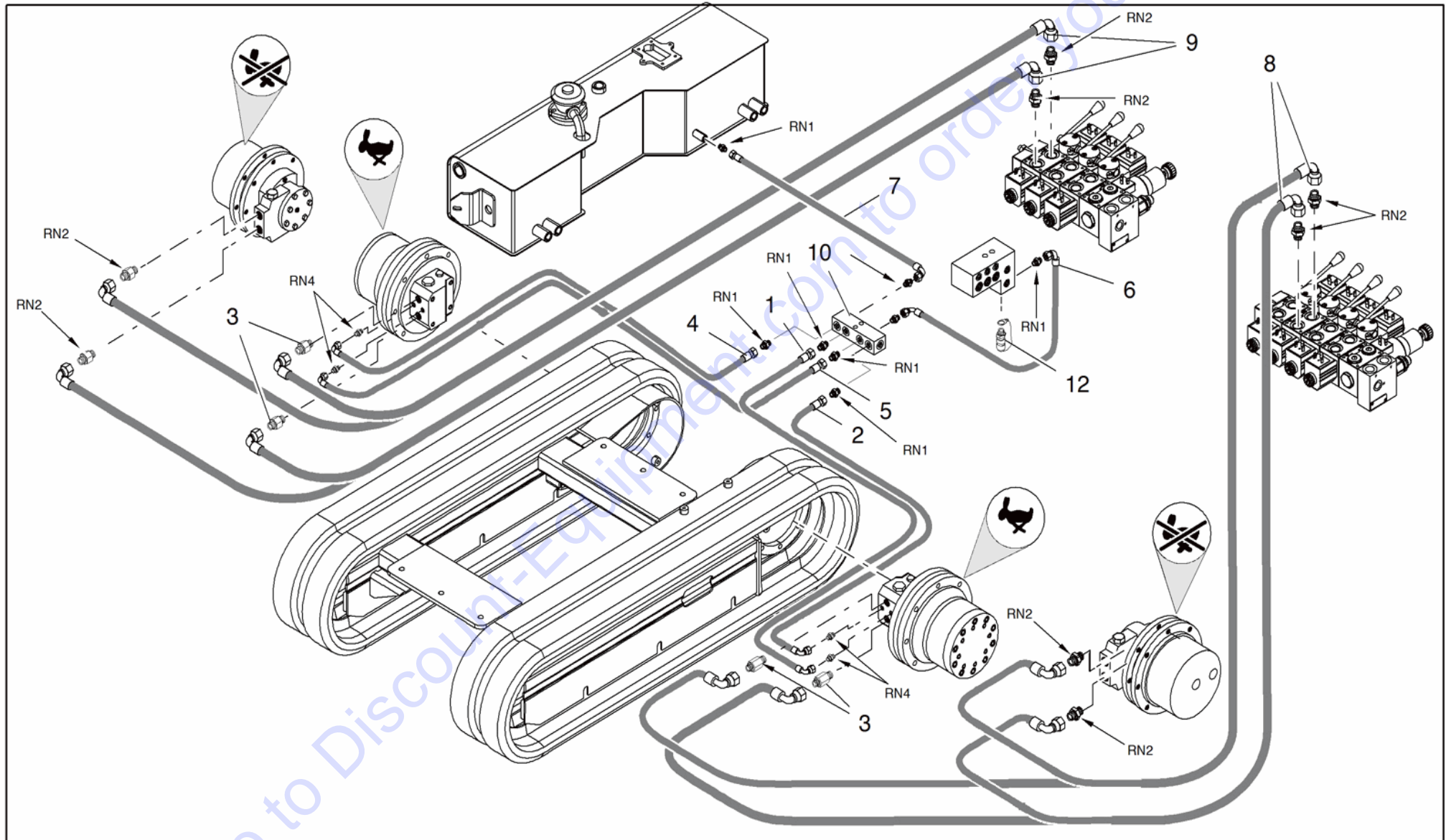





 IMPIANTO IDRAULICO TRAZIONE

HYDRAULIKANLAGE ANTRIEB 

 HYDRAULIC SYSTEM FOR TRACTION

INSTALACIÓN HIDRÁULICA TRACCIÓN 

 SYSTÈME HYDRAULIQUE DE TRACTION

| POS Codice | Q.tà |  Descrizione |  Description |  Designation |  Benennung |  Descripción |
|-------------|------|---|---|---|---|---|
| 1 07163400 | 1 NR | TUBO FLESSIBILE | FLEXIBLE PIPE | TUYAU FLEXIBLE | SCHLAUCH | TUBO FLEXIBLE |
| 2 07163200 | 1 NR | TUBO FLESSIBILE | FLEXIBLE PIPE | TUYAU FLEXIBLE | SCHLAUCH | TUBO FLEXIBLE |
| 3 05093900 | 4 NR | RACCORDO 12L-3/8 JIS ESAGONO 22 H40 | 12L-FITTING 3/8 JIS HEX22 H40 | RACCORD | ANSCHLUSS | CONEXIÓN |
| 4 07163500 | 1 NR | TUBO FLESSIBILE | FLEXIBLE PIPE | TUYAU FLEXIBLE | SCHLAUCH | TUBO FLEXIBLE |
| 5 07163300 | 1 NR | TUBO FLESSIBILE | FLEXIBLE PIPE | TUYAU FLEXIBLE | SCHLAUCH | TUBO FLEXIBLE |
| 6 07167900 | 1 NR | TUBO RIGIDO | RIGID PIPE | TUYAU RIGIDE | ROHR | TUBO RÍGIDO |
| 7 07164200 | 1 NR | TUBO FLESSIBILE | FLEXIBLE PIPE | TUYAU FLEXIBLE | SCHLAUCH | TUBO FLEXIBLE |
| 8 07163600 | 2 NR | TUBO FLESSIBILE | FLEXIBLE PIPE | TUYAU FLEXIBLE | SCHLAUCH | TUBO FLEXIBLE |
| 9 07163700 | 2 NR | TUBO FLESSIBILE | FLEXIBLE PIPE | TUYAU FLEXIBLE | SCHLAUCH | TUBO FLEXIBLE |
| 10 04707700 | 2 NR | COLLETTORE | MANIFOLD | COLLECTEUR | KOLLEKTOR | COLECTOR |
| 11 05582000 | 2 NR | RACCORDO | FITTING | RACCORD | ANSCHLUSS | CONEXIÓN |
| 12 05242300 | 1 NR | PRESA PRESSIONE 1/8" G | PRESSURE SOCKET 1/8" G | PRISE PRESSION 1/8" G | STECKDOSE KONTROLLE 1/8" G | TOMA PRESIÓN 1/8" G |

 IMPIANTO IDRAULICO ALLARGAMENTO CARRO

HYDRAULIKANLAGE VERBREITERUNG WAGEN 

 HYDRAULIC SYSTEM UNDERCARRIAGE EXPANSION

INSTALACIÓN HIDRAULICA ENSANCHAMIENTO CARRO 

 SYSTÈME HYDRAULIQUE EXTENSION DU CHARIOT

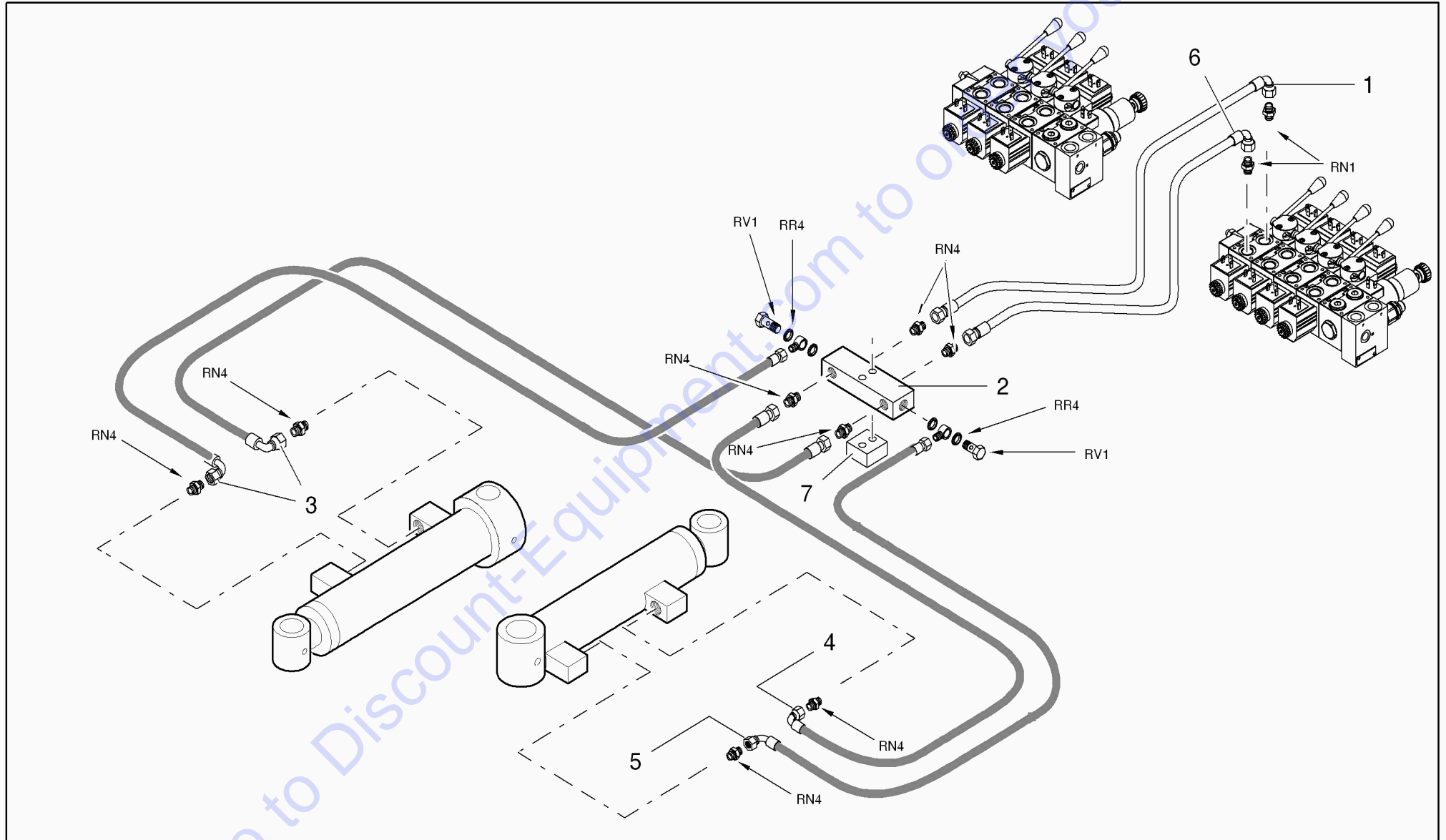





 IMPIANTO IDRAULICO ALLARGAMENTO CARRO

HYDRAULIKANLAGE VERBREITERUNG WAGEN 

 HYDRAULIC SYSTEM UNDERCARRIAGE EXPANSION

INSTALACIÓN HIDRAULICA ENSANCHAMIENTO CARRO 

 SYSTÈME HYDRAULIQUE EXTENSION DU CHARIOT

| POS Codice | Q.tà |  Descrizione |  Description |  Designation |  Benennung |  Descripción |
|------------|------|---|---|---|---|---|
| 1 07168100 | 1 NR | TUBO RIGIDO | RIGID PIPE | TUYAU RIGIDE | ROHR | TUBO RÍGIDO |
| 3 07163800 | 2 NR | TUBO FLESSIBILE | FLEXIBLE PIPE | TUYAU FLEXIBLE | SCHLAUCH | TUBO FLEXIBLE |
| 4 07164000 | 1 NR | TUBO FLESSIBILE | FLEXIBLE PIPE | TUYAU FLEXIBLE | SCHLAUCH | TUBO FLEXIBLE |
| 5 07164100 | 1 NR | TUBO FLESSIBILE | FLEXIBLE PIPE | TUYAU FLEXIBLE | SCHLAUCH | TUBO FLEXIBLE |
| 6 07168200 | 1 NR | TUBO RIGIDO | RIGID PIPE | TUYAU RIGIDE | ROHR | TUBO RÍGIDO |

Go to Discount-Equipment.com to order your parts

 IMPIANTO IDRAULICO STABILIZZATORI

ABSTÜTZUNG ABSTÜTZUNGSHYDRAULIKZYLIND 

 STABILIZERS HYDRAULIC SYSTEM

INSTALACIÓN HIDRAULICA ESTABILIZADORS 

 INSTALLATION HYDRAULIQUE STABILISATERS

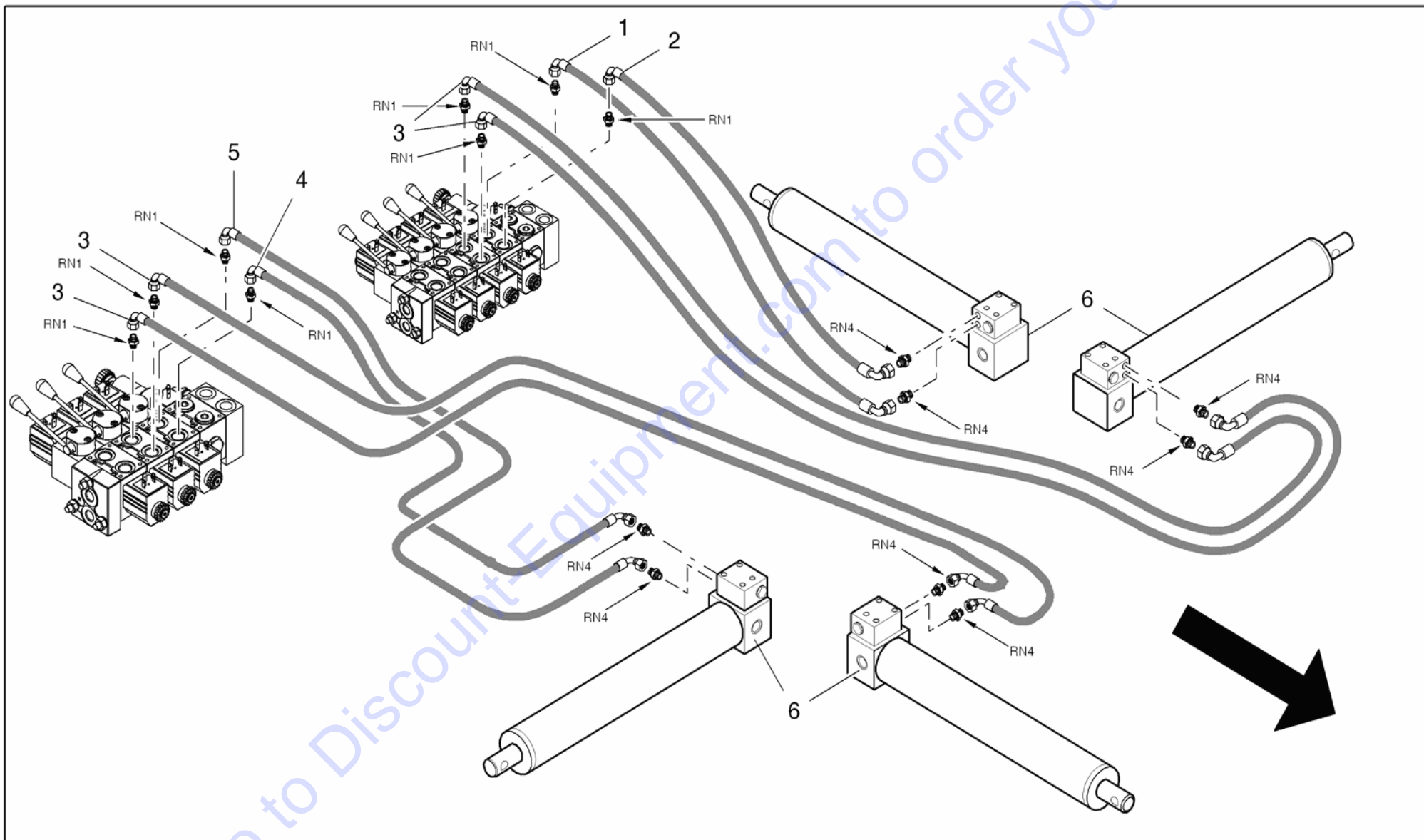





 IMPIANTO IDRAULICO STABILIZZATORI

ABSTÜTZUNG ABSTÜTZUNGSHYDRAULIKZYLIND 

 STABILIZERS HYDRAULIC SYSTEM

INSTALACIÓN HIDRAULICA ESTABILIZADORS 

 INSTALLATION HYDRAULIQUE STABILISATERS

| POS Codice | Q.tà |  Descrizione |  Description |  Designation |  Benennung |  Descripcìon |
|------------|------|---|---|---|---|---|
| 1 07164600 | 1 NR | TUBO FLESSIBILE | FLEXIBLE PIPE | TUYAU FLEXIBLE | SCHLAUCH | TUBO FLEXIBLE |
| 2 07164500 | 1 NR | TUBO FLESSIBILE | FLEXIBLE PIPE | TUYAU FLEXIBLE | SCHLAUCH | TUBO FLEXIBLE |
| 3 07165200 | 4 NR | TUBO FLESSIBILE | FLEXIBLE PIPE | TUYAU FLEXIBLE | SCHLAUCH | TUBO FLEXIBLE |
| 4 07164300 | 1 NR | TUBO FLESSIBILE | FLEXIBLE PIPE | TUYAU FLEXIBLE | SCHLAUCH | TUBO FLEXIBLE |
| 5 07164400 | 1 NR | TUBO FLESSIBILE | FLEXIBLE PIPE | TUYAU FLEXIBLE | SCHLAUCH | TUBO FLEXIBLE |
| 6 27055400 | 4 NR | CILINDRO | CYLINDER | CYLINDER | ZYLINDER | CILINDRO |
| 6 270554H2 | 4 NR | CILINDRO | CYLINDER | CYLINDER | ZYLINDER | CILINDRO |

Go to Discount-Equipment.com to order your parts

 IMPIANTO IDRAULICO 1-2 BRACCI

 1-2 ARMS HYDRAULIC SYSTEM



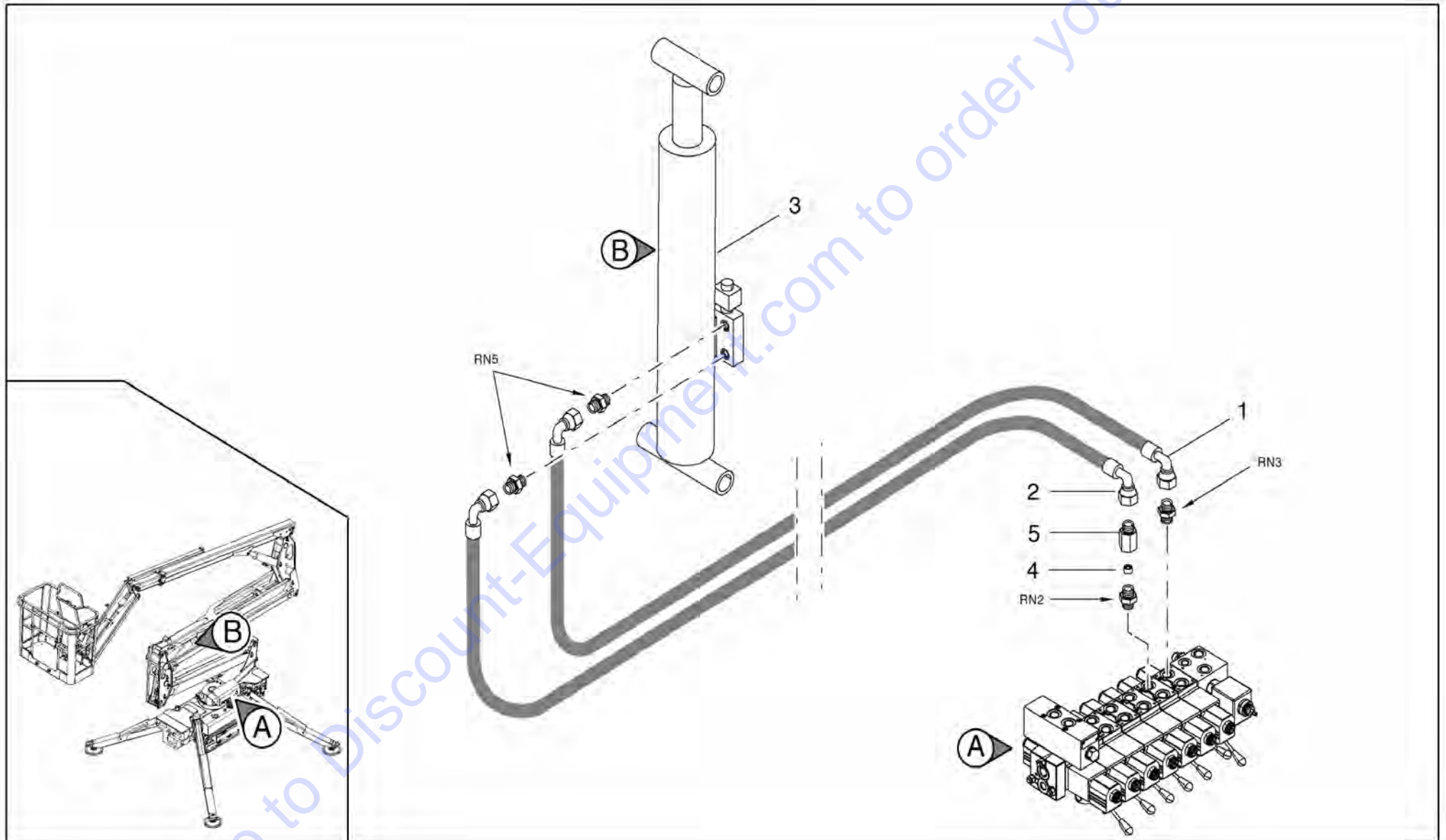

 SYSTÈME HYDRAULIQUE 1-2 BRAS

HYDRAULIKANLAGE 1-2 ARM 

INSTALACIÓN HIDRÁULICA 1-2 BRAZOS 



 IMPIANTO IDRAULICO 1-2 BRACCI
HYDRAULIKANLAGE 1-2 ARM 
 1-2 ARMS HYDRAULIC SYSTEM
INSTALACIÓN HIDRÁULICA 1-2 BRAZOS 
 SYSTÈME HYDRAULIQUE 1-2 BRAS

| POS Codice | Q.tà |  Descrizione |  Description |  Designation |  Benennung |  Descripción |
|------------|------|---|---|---|---|---|
| 1 07166000 | 1 NR | TUBO FLESSIBILE | FLEXIBLE PIPE | TUYAU FLEXIBLE | SCHLAUCH | TUBO FLEXIBLE |
| 1 07723900 | 1 NR | TUBO FLESSIBILE (MK2 FROM C170000893) | FLEXIBLE PIPE (MK2 FROM C170000893) | TUYAU FLEXIBLE (MK2 FROM C170000893) | SCHLAUCH (MK2 FROM C170000893) | TUBO FLEXIBLE (MK2 FROM C170000893) |
| 2 07166100 | 1 NR | TUBO FLESSIBILE | FLEXIBLE PIPE | TUYAU FLEXIBLE | SCHLAUCH | TUBO FLEXIBLE |
| 2 07724000 | 1 NR | TUBO FLESSIBILE (MK2 FROM C170000893) | FLEXIBLE PIPE (MK2 FROM C170000893) | TUYAU FLEXIBLE (MK2 FROM C170000893) | SCHLAUCH (MK2 FROM C170000893) | TUBO FLEXIBLE (MK2 FROM C170000893) |
| 3 27069100 | 1 NR | CILINDRO PRIMO BRACCIO | FIRST ARM CYLINDER | CYLINDRE SECT.TÉLESCOP | TELESKOPZYLIN DER | CIL. BRAZO TELESCÓP. |
| 3 270691H2 | 1 NR | CILINDRO PRIMO BRACCIO | FIRST ARM CYLINDER | CYLINDRE SECT.TÉLESCOP | TELESKOPZYLIN DER | CIL. BRAZO TELESCÓP. |
| 4 07688500 | 1 NR | PASTIGLIA VNR STROZZATA 3/8 FORO DA Ø=2MM | VALVE | SOUPAPE | VENTIL | VALVULA |
| 5 07688400 | 1 NR | RACCORDO PROLUNGA M-F 3/8 H=30 FILETTO UTILE 25 | FITTING | RACCORD | ANSCHLUSS | CONEXIÓN |

 IMPIANTO IDRAULICO 3 BRACCIO

 3 ARM HYDRAULIC SYSTEM

 SYSTÈME HYDRAULIQUE 3 BRAS

HYDRAULIKANLAGE 3 ARM 

INSTALACIÓN HIDRÁULICA 3 BRAZO 

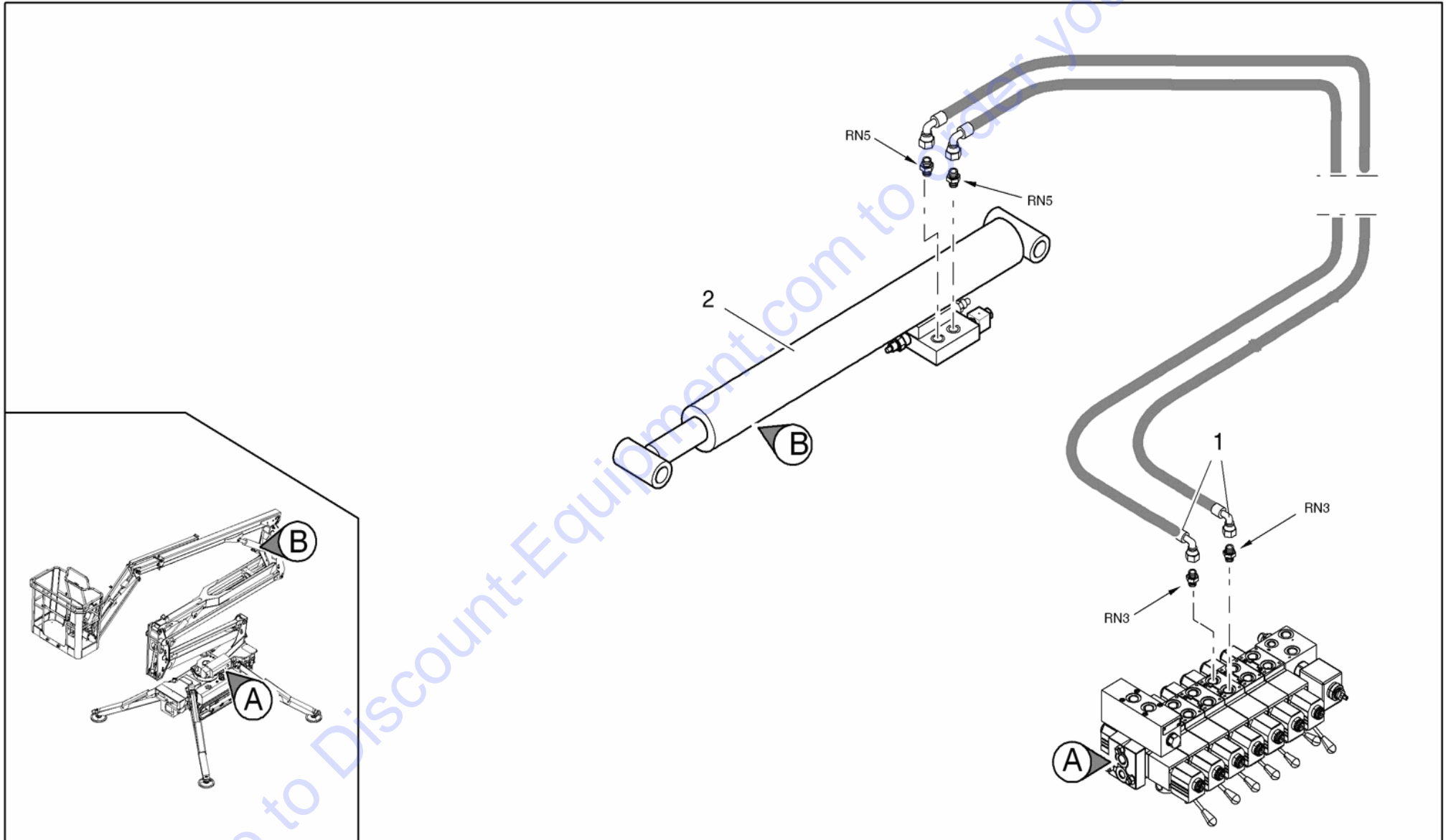





 IMPIANTO IDRAULICO 3 BRACCIO

HYDRAULIKANLAGE 3 ARM 

 3 ARM HYDRAULIC SYSTEM

INSTALACIÓN HIDRÁULICA 3 BRAZO 

 SYSTÈME HYDRAULIQUE 3 BRAS

| POS | Codice | Q.tà |  Descrizione |  Description |  Designation |  Benennung |  Descripcìon |
|-----|----------|------|---|---|---|---|---|
| 1 | 07166300 | 2 NR | TUBO FLESSIBILE | FLEXIBLE PIPE | TUYAU FLEXIBLE | SCHLAUCH | TUBO FLEXIBLE |
| 1 | 07724200 | 2 NR | TUBO FLESSIBILE (MK2 FROM C170000893) | FLEXIBLE PIPE (MK2 FROM C170000893) | TUYAU FLEXIBLE (MK2 FROM C170000893) | SCHLAUCH (MK2 FROM C170000893) | TUBO FLEXIBLE (MK2 FROM C170000893) |
| 2 | 27069200 | 1 NR | CILINDRO TERZO BRACCIO | MAIN BOOM CYLINDER | CYLINDRE SECT.TÉLESCOP | TELESKOPZYLIN DER | CIL. BRAZO TELESCÓP. |
| 2 | 270692H2 | 1 NR | CILINDRO TERZO BRACCIO | MAIN BOOM CYLINDER | CYLINDRE SECT.TÉLESCOP | TELESKOPZYLIN DER | CIL. BRAZO TELESCÓP. |

Go to Discount-Equipment.com to order your parts

 IMPIANTO IDRAULICO SFILATO

TELESKOPHYDRAULIK 

 TELESCOPIC HYDRAULIC SYSTEM

INSTALACIÓN EXTENSIÓN HIDRÁULICA 

 TELESCOPIQUE HIDRAULIQUE

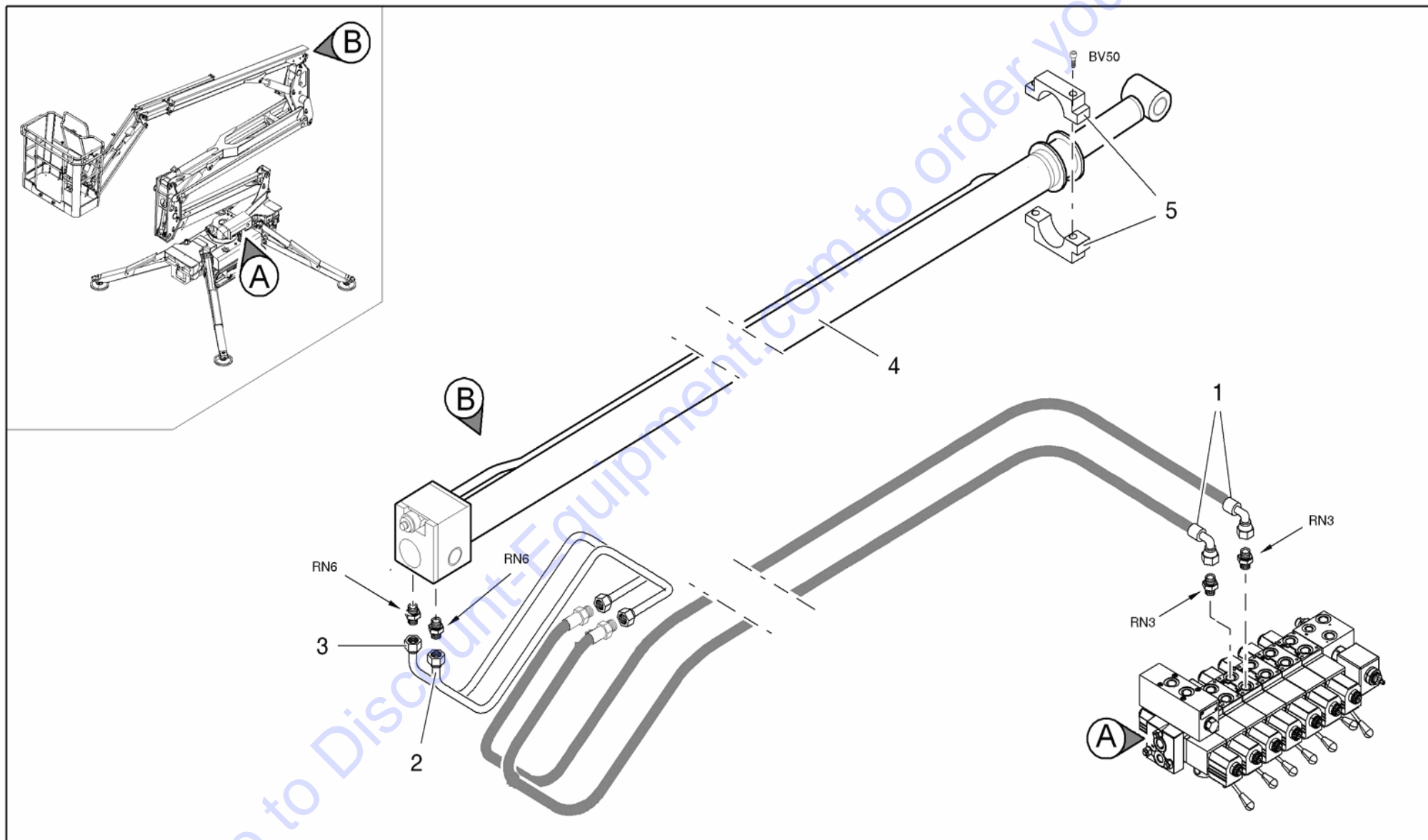





 IMPIANTO IDRAULICO SFILO

TELESKOPHYDRAULIK 

 TELESCOPIC HYDRAULIC SYSTEM

INSTALACIÓN EXTENSIÓN HIDRÁULICA 

 TELESCOPIQUE HIDRAULIQUE

| POS Codice | Q.tà |  Descrizione |  Description |  Designation |  Benennung |  Descripcìon |
|------------|------|---|---|---|---|---|
| 1 07169600 | 2 NR | TUBO FLESSIBILE | FLEXIBLE PIPE | TUYAU FLEXIBLE | SCHLAUCH | TUBO FLEXIBLE |
| 1 07724700 | 2 NR | TUBO FLESSIBILE (MK2 FROM C170000893) | FLEXIBLE PIPE (MK2 FROM C170000893) | TUYAU FLEXIBLE (MK2 FROM C170000893) | SCHLAUCH (MK2 FROM C170000893) | TUBO FLEXIBLE (MK2 FROM C170000893) |
| 2 07152500 | 1 NR | TUBO RIGIDO | RIGID PIPE | TUYAU RIGIDE | ROHR | TUBO RÍGIDO |
| 3 07152600 | 1 NR | TUBO RIGIDO | RIGID PIPE | TUYAU RIGIDE | ROHR | TUBO RÍGIDO |
| 4 270690H2 | 1 NR | CILINDRO SFILO | EXTENSION CYLINDER | CYLINDRE SECT.TÉLESCOP | TELESKOPZYLIN DER | CIL. BRAZO TELESCÓP. |
| 5 07094000 | 1 NR | PATTINO SCORRIMENTO CILINDRO SFILO | EXT CYL. SLIDE | CHEVILLE | STIF | CLAVIJA |

Go to Discount-Equipment.com to order your parts

 IMPIANTO JIB

 JIB HYDRAULIC SYSTEM

 SYSTÈME HYDRAULIQUE JIB

ZYLINDER JIB ARM 

INSTALACIÓN HIDRÁULICA JIB 

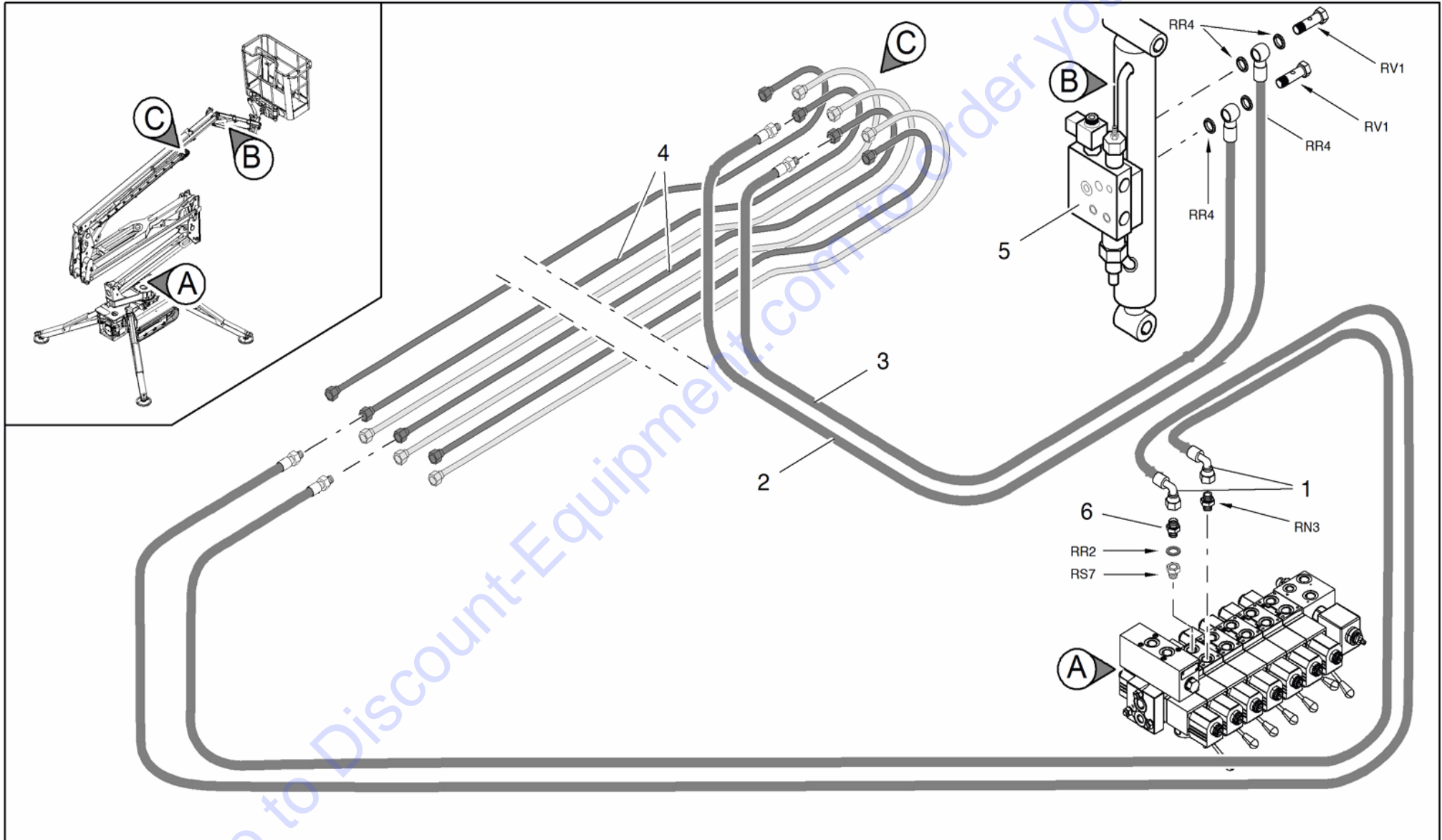





 IMPIANTO JIB

 ZYLINDER JIB ARM

 JIB HYDRAULIC SYSTEM

 INSTALACIÓN HIDRÁULICA JIB

 SYSTÈME HYDRAULIQUE JIB

| POS Codice | Q.tà |  Descrizione |  Description |  Designation |  Benennung |  Descripción |
|------------|------|---|---|---|---|---|
| 1 07167000 | 2 NR | TUBO FLESSIBILE | FLEXIBLE PIPE | TUYAU FLEXIBLE | SCHLAUCH | TUBO FLEXIBLE |
| 1 07724400 | 2 NR | TUBO FLESSIBILE (MK2 FROM C170000893) | FLEXIBLE PIPE (MK2 FROM C170000893) | TUYAU FLEXIBLE (MK2 FROM C170000893) | SCHLAUCH (MK2 FROM C170000893) | TUBO FLEXIBLE (MK2 FROM C170000893) |
| 2 07169800 | 1 NR | TUBO FLESSIBILE | FLEXIBLE PIPE | TUYAU FLEXIBLE | SCHLAUCH | TUBO FLEXIBLE |
| 3 07169700 | 1 NR | TUBO FLESSIBILE | FLEXIBLE PIPE | TUYAU FLEXIBLE | SCHLAUCH | TUBO FLEXIBLE |
| 4 07101800 | 2 NR | TUBO RIGIDO | RIGID PIPE | TUYAU RIGIDE | ROHR | TUBO RÍGIDO |
| 5 27069500 | 1 NR | CILINDRO JIB | JIB CYLINDER | CYLINDRE SECT.TÉLESCOP | TELESKOPZYLIN DER | CIL. BRAZO TELESCÓP. |
| 5 270695H2 | 1 NR | CILINDRO JIB | JIB CYLINDER | CYLINDRE JIB | KORBARMZYLIND ER | CILINDRO JIB |
| 6 06786700 | 1 NR | RACCORDO | FITTING | RACCORD | ANSCHLUSS | CONEXIÓN |

 IMPIANTO IDRAULICO LIVELLAMENTO

 LEVELING CYLINDERS HYDRAULIC SYSTEM



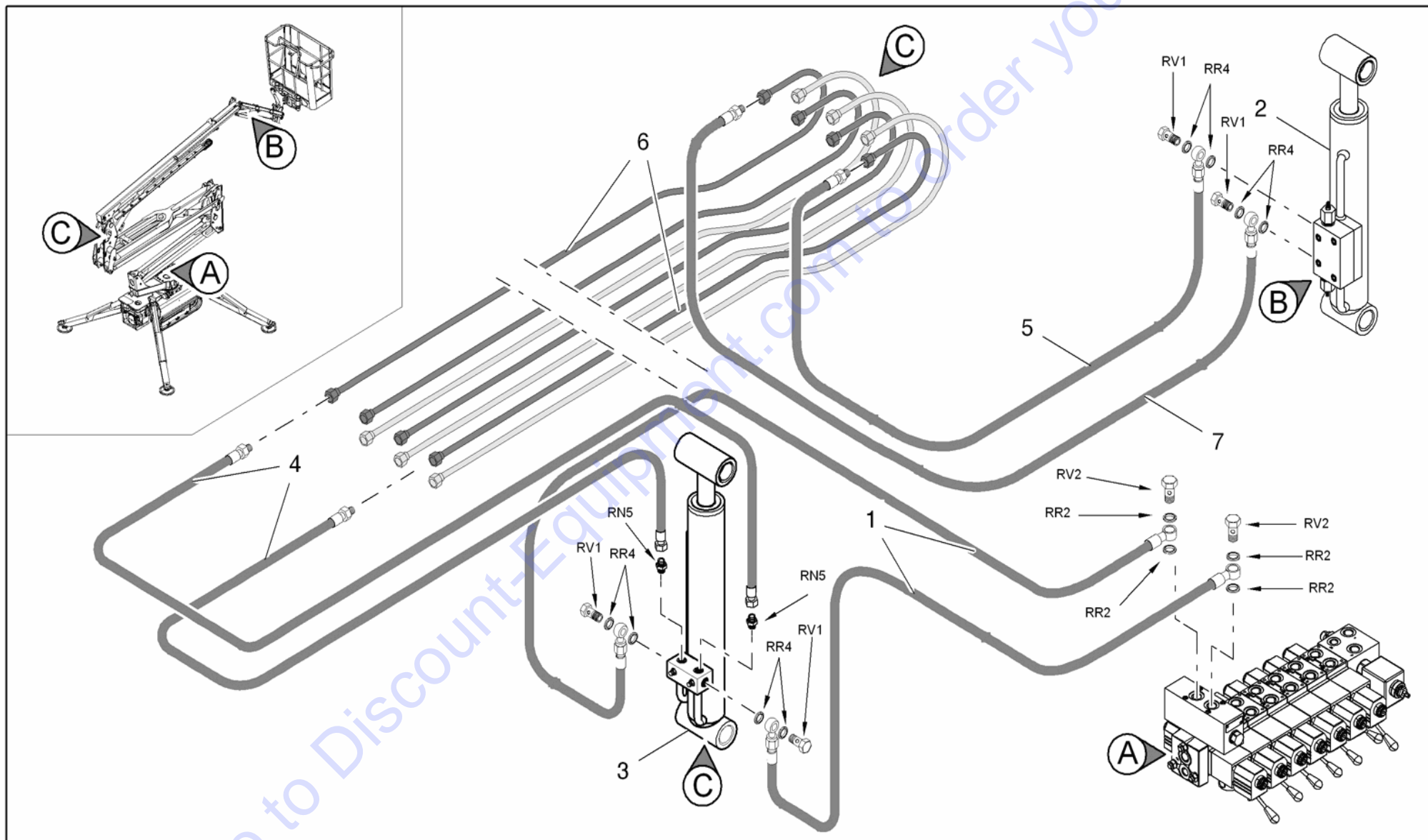

 SYSTÈME HYDRAULIQUE CYLINDRES BRAS

HYDRAULIKANLAGE ZYLINDER ARM 

INSTALACIÓN HIDRÁULICA CILINDROS BRAZOS 



 IMPIANTO IDRAULICO LIVELLAMENTO
HYDRAULIKANLAGE ZYLINDER ARM 
 LEVELING CYLINDERS HYDRAULIC SYSTEM
INSTALACIÓN HIDRÁULICA CILINDROS BRAZOS 
 SYSTÈME HYDRAULIQUE CYLINDRES BRAS

| POS | Codice | Q.tà |  Descrizione |  Description |  Designation |  Benennung |  Descripción |
|-----|----------|------|---|---|---|---|---|
| 1 | 07166200 | 2 NR | TUBO FLESSIBILE | FLEXIBLE PIPE | TUYAU FLEXIBLE | SCHLAUCH | TUBO FLEXIBLE |
| 1 | 07724100 | 2 NR | TUBO FLESSIBILE (MK2 FROM C170000893) | FLEXIBLE PIPE (MK2 FROM C170000893) | TUYAU FLEXIBLE (MK2 FROM C170000893) | SCHLAUCH (MK2 FROM C170000893) | TUBO FLEXIBLE (MK2 FROM C170000893) |
| 2 | 27315100 | 1 NR | CILINDRO LIVELLAMENTO CESTO SU CESTO | LEVELING CYLINDER BASKET ON BASKET | CYLINDRE SUR LEVEL BASKET BASKET | NIVELLIERZYLIND ER | CILINDRO DE NIVEL DE BASKET BASKET |
| 2 | 273151H2 | 1 NR | CILINDRO LIVELLAMENTO CESTO SU CESTO | LEVELING CYLINDER BASKET ON BASKET | CYLINDRE NIVELLEMENT PANIER SUR PANIER | ZYLINDER KORBNIVELLIERU NG | CILINDRO NIVELACIÓN CESTA |
| 3 | 27069300 | 1 NR | CILINDRO LIVELLAMENTO CESTO | LEVELLING CYLINDER | CYLINDRE SECT.TÉLESCOP | TELESKOPZYLIN DER | CIL. BRAZO TELESCÓP. |
| 3 | 270693H2 | 1 NR | CILINDRO LIVELLAMENTO CESTO | BASKET LEVELLING CYLINDER | CYLINDRE NIVELLEMENT PANIER | ZYLINDER KORBNIVELLIERU NG | CILINDRO NIVELACIÓN CESTA |
| 4 | 07166900 | 2 NR | TUBO FLESSIBILE | FLEXIBLE PIPE | TUYAU FLEXIBLE | SCHLAUCH | TUBO FLEXIBLE |
| 4 | 07724300 | 2 NR | TUBO FLESSIBILE (MK2 FROM C170000893) | FLEXIBLE PIPE (MK2 FROM C170000893) | TUYAU FLEXIBLE (MK2 FROM C170000893) | SCHLAUCH (MK2 FROM C170000893) | TUBO FLEXIBLE (MK2 FROM C170000893) |
| 5 | 07169900 | 1 NR | TUBO FLESSIBILE | FLEXIBLE PIPE | TUYAU FLEXIBLE | SCHLAUCH | TUBO FLEXIBLE |
| 6 | 07101700 | 2 NR | TUBO RIGIDO | RIGID PIPE | TUYAU RIGIDE | ROHR | TUBO RÍGIDO |

 IMPIANTO IDRAULICO LIVELLAMENTO

HYDRAULIKANLAGE ZYLINDER ARM 

 LEVELING CYLINDERS HYDRAULIC SYSTEM

INSTALACIÓN HIDRÁULICA CILINDROS BRAZOS 

 SYSTÈME HYDRAULIQUE CYLINDRES BRAS

| POS Codice | Q.tà |  Descrizione |  Description |  Designation |  Benennung |  Descripcìon |
|------------|------|---|---|---|---|---|
| 7 07225400 | 1 NR | TUBO FLESSIBILE | FLEXIBLE PIPE | TUYAU FLEXIBLE | SCHLAUCH | TUBO FLEXIBLE |

Go to Discount-Equipment.com to order your parts

 IMPIANTO IDRAULICO ROTAZIONE CESTO

HYDRAULIKANLAGE KORBSCHWENKUNG 

 CAGE ROTATION HYDRAULIC SYSTEM

INSTALACIÓN HIDRÁULICA ROTACIÓN CESTA 

 SYSTÈME HYDRAULIQUE ROTATION PANIER

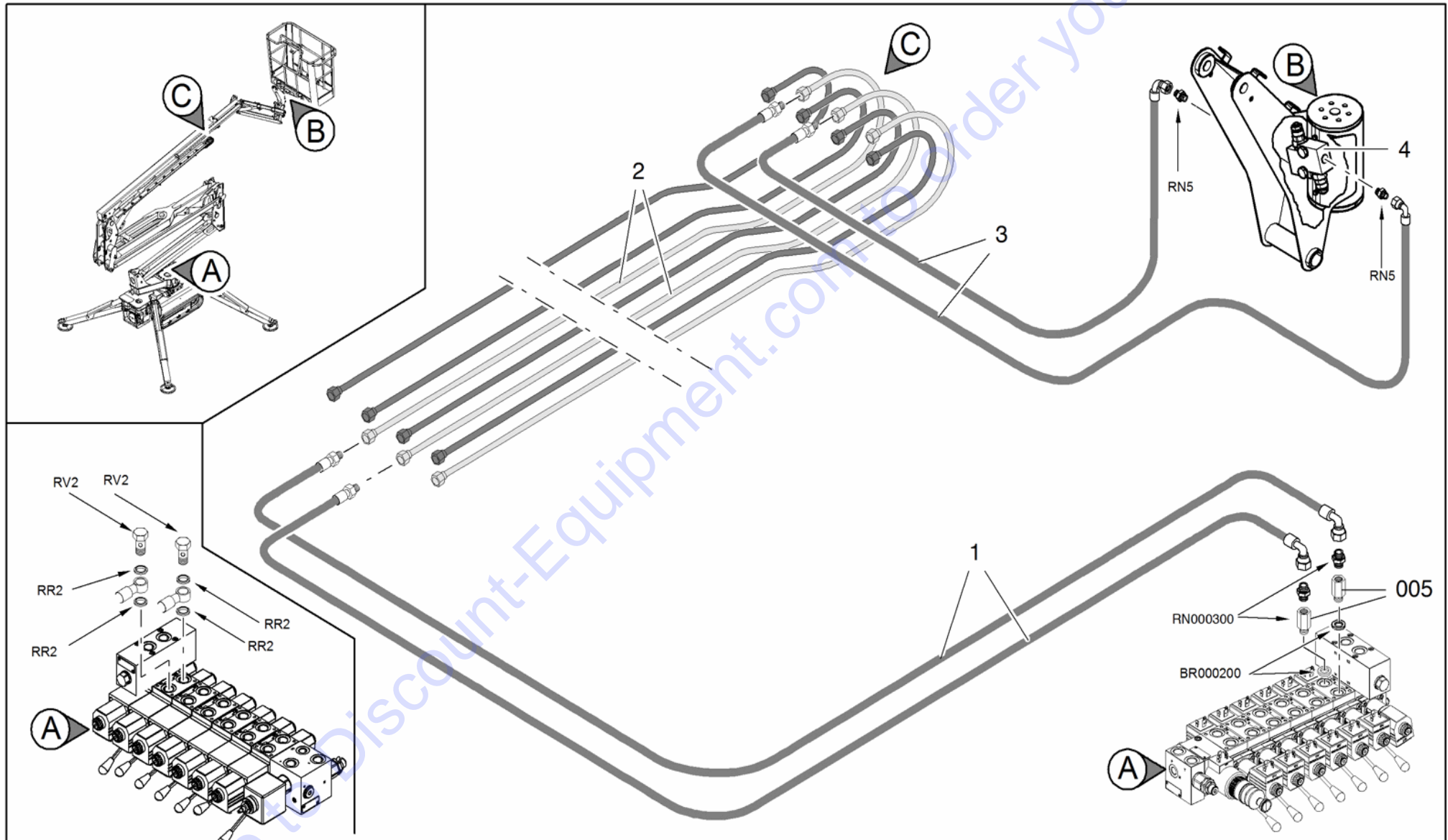





 IMPIANTO IDRAULICO ROTAZIONE CESTO

HYDRAULIKANLAGE KORBSCHWENKUNG 

 CAGE ROTATION HYDRAULIC SYSTEM

INSTALACIÓN HIDRÁULICA ROTACIÓN CESTA 

 SYSTÈME HYDRAULIQUE ROTATION PANIER

| POS | Codice | Q.tà |  Descrizione |  Description |  Designation |  Benennung |  Descripción |
|-----|------------|------|---|---|---|---|---|
| 1 | 07165300 | 2 NR | TUBO FLESSIBILE | FLEXIBLE PIPE | TUYAU FLEXIBLE | SCHLAUCH | TUBO FLEXIBLE |
| 1 | 07724500 | 2 NR | TUBO FLESSIBILE | FLEXIBLE PIPE | TUYAU FLEXIBLE | SCHLAUCH | TUBO FLEXIBLE |
| 2 | 07101400 | 2 NR | TUBO RIGIDO | RIGID PIPE | TUYAU RIGIDE | ROHR | TUBO RÍGIDO |
| 3 | 07170000 | 2 NR | TUBO FLESSIBILE | FLEXIBLE PIPE | TUYAU FLEXIBLE | SCHLAUCH | TUBO FLEXIBLE |
| 4 | 2648910001 | 1 NR | VALVOLA IDRAULICA | HYDRAULIC VALVE | VALVE HYDRAULIQUE | HYDRAULIKVENTI L | VÁLVULA HIDRÁULICA |
| 5 | 03149500 | 2 NR | RACCORDO A COLONNA 3/8" H=20 | EXTENSION 3/8" H=20 | RACCORD | ANSCHLUSS | CONEXIÓN |

Go to Discount-Equipment.com to order your parts

 IMPIANTO IDRAULICO ARIA COMPRESSA

 COMPRESSED AIR HYDRAULIC SYSTEM

 SYSTÈME HYDRAULIQUE AIR COMPRIMÉ

HYDRAULIKANLAGE DRUCKLUFT 

INSTALACIÓN HIDRÁULICA AIRE COMPRIMIDO 

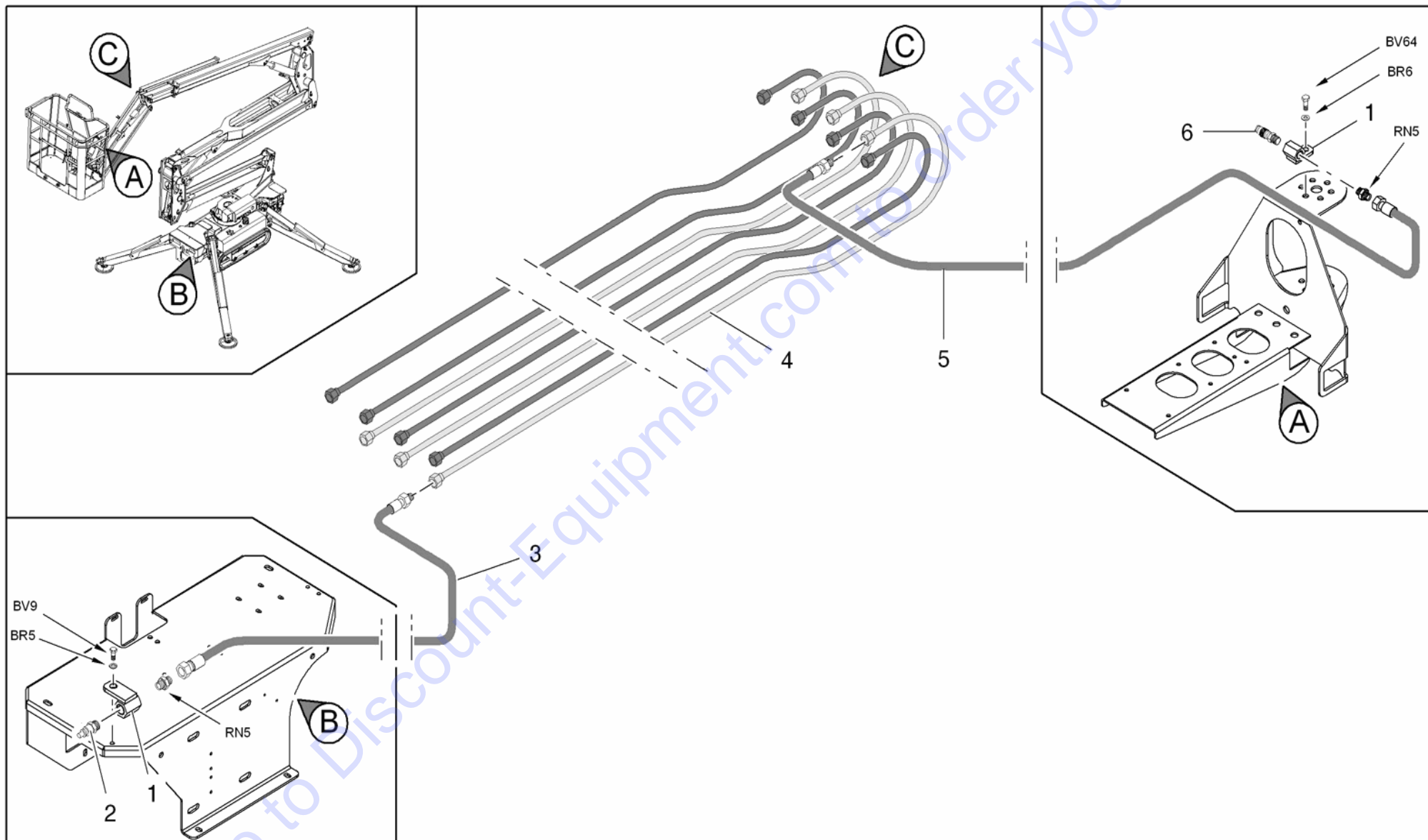





 IMPIANTO IDRAULICO ARIA COMPRESSA

HYDRAULIKANLAGE DRUCKLUFT 

 COMPRESSED AIR HYDRAULIC SYSTEM

INSTALACIÓN HIDRÁULICA AIRE COMPRIMIDO 

 SYSTÈME HYDRAULIQUE AIR COMPRIMÉ

| POS Codice | Q.tà |  Descrizione |  Description |  Designation |  Benennung |  Descripción |
|------------|------|---|---|---|---|---|
| 1 04845100 | 1 NR | SUPPORTO | SUPPORT | SUPPORT | HALTERUNG | SOPORTE |
| 2 05509900 | 1 NR | INNESTO RAPIDO | QUICK COUPLING | RACCORD RAPIDE | SCHNELLKUPPLUNG | CONEXIÓN RÁPIDA |
| 3 07169500 | 1 NR | TUBO FLESSIBILE | FLEXIBLE PIPE | TUYAU FLEXIBLE | SCHLAUCH | TUBO FLEXIBLE |
| 3 07724600 | 1 NR | TUBO FLESSIBILE | FLEXIBLE PIPE | TUYAU FLEXIBLE | SCHLAUCH | TUBO FLEXIBLE |
| 4 07101300 | 1 NR | TUBO RIGIDO | RIGID PIPE | TUYAU RIGIDE | ROHR | TUBO RÍGIDO |
| 5 07170100 | 1 NR | TUBO FLESSIBILE | FLEXIBLE PIPE | TUYAU FLEXIBLE | SCHLAUCH | TUBO FLEXIBLE |
| 6 05580200 | 1 NR | RUBINETTO | FAUCET | ROBINET | WASSERHAHN | GRIFO |

Go to Discount-Equipment.com to get your parts

 CILINDRI

 CYLINDERS

 CYLINDRES

ZYLINDER 

CILINDROS 

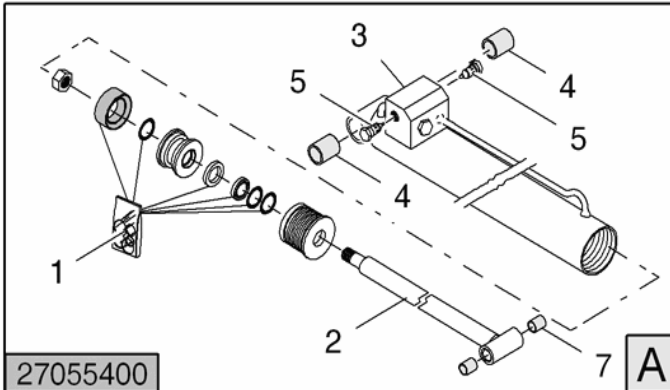

27055400

A

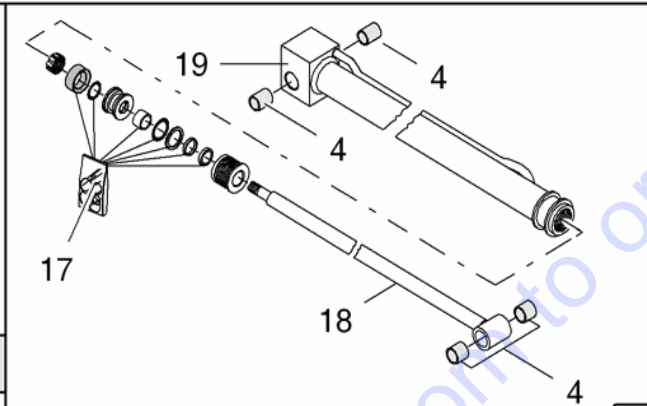

27069000

D

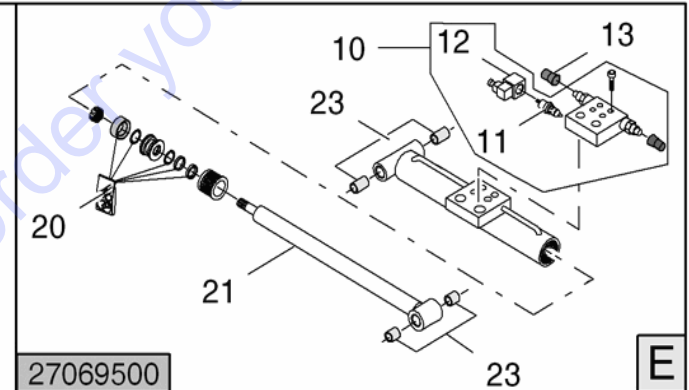

27069500

E

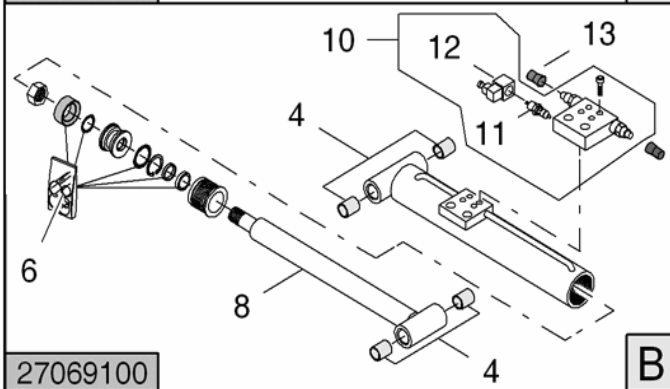

27069100

B

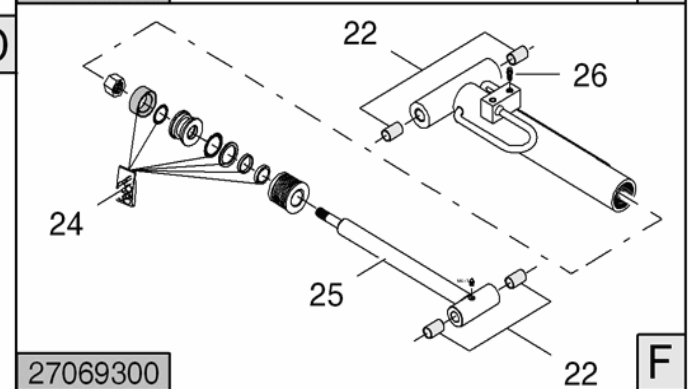
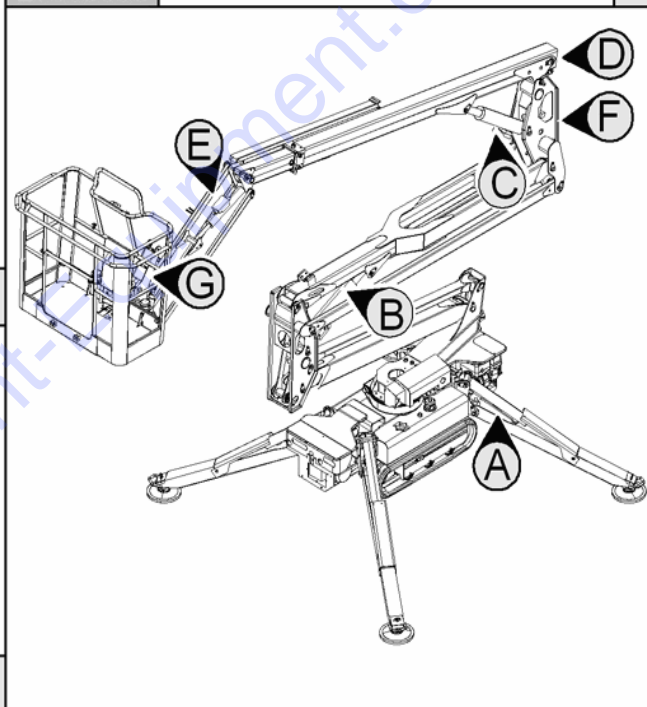

27069300

F

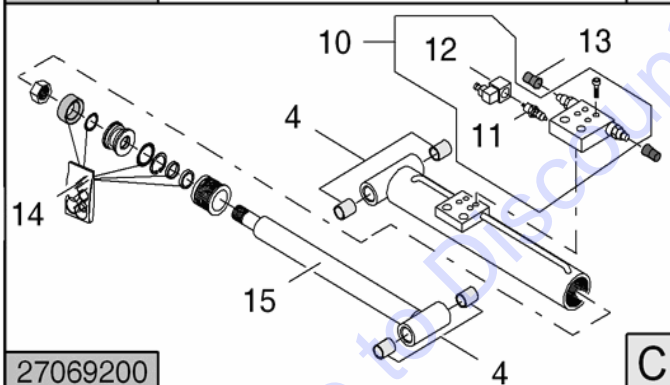

27069200

C

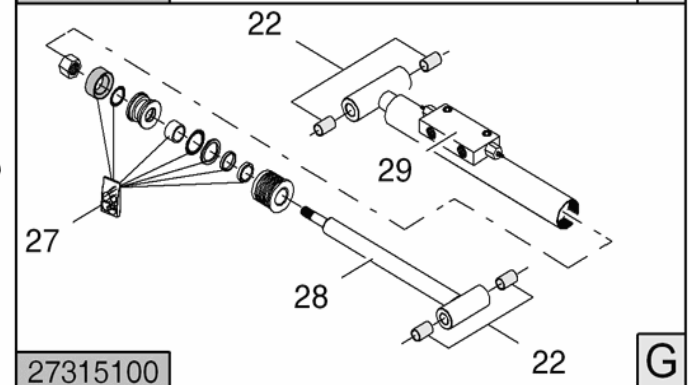





27315100

G





 CILINDRI

 ZYLINDER 
 CYLINDERS

 CILINDROS 
 CYLINDRES

| POS Codice | Q.tà |  Descrizione |  Description |  Designation |  Benennung |  Descripción |
|---------------|------|---|---|---|---|---|
| 1 2705540001 | 1 NR | KIT GUARNIZIONI | GASKET KIT | KIT JOINTS | DICHTUNGSSATZ | KIT GUARNICIONES |
| 2 2687630002 | 1 NR | STELO | ROD | TIGE | SCHAFT | VÁSTAGO |
| 3 2705540002 | 1 NR | BLOCCHETTO | BLOCK | BLOC | BLOCK | BLOQUE |
| 4 2627880005 | 1 NR | BOCCOLA | BUSH | DOUILLE | BUCHSE | CASQUILLO |
| 4 2627880005 | 4 NR | BOCCOLA | BUSH | DOUILLE | BUCHSE | CASQUILLO |
| 4 2627880005 | 2 NR | BOCCOLA | BUSH | DOUILLE | BUCHSE | CASQUILLO |
| 5 1541150011 | 3 NR | VALVOLA IDRAULICA | HYDRAULIC VALVE | VALVE HYDRAULIQUE | HYDRAULIKVENTIL | VÁLVULA HIDRÁULICA |
| 6 2706910001 | 1 NR | KIT GUARNIZIONI CILINDRO 1-2 BRACCIO | 1-2 ARM CYLINDER GASKET KIT | SEAL KIT CYLINDRE 1-2 ARM | 1-2 ARM ROLLSIEGEL BAUSÄTZE | 1-2 ARM KIT DE JUNTAS CILINDRO |
| 7 2626900002 | 2 NR | BOCCOLA | BUSH | DOUILLE | BUCHSE | CASQUILLO |
| 8 2706910002 | 1 NR | STELO CILINDRO 1-2 BRACCIO | CYLINDER 1-2 ARM ROD | TIGE DU VERIN 1-2 ARM | ROD CYLINDER 1-2 ARM | VÁSTAGO DEL CILINDRO 1-2 ARM |
| 10 26119300 | 1 NR | VALVOLA IDRAULICA | HYDRAULIC VALVE | VALVE HYDRAULIQUE | HYDRAULIKVENTIL | VÁLVULA HIDRÁULICA |
| 11 0552550001 | 1 NR | ELETTROVALVOL A | SOLENOID VALVE | ÉLECTROVANNE | MAGNETVENTIL | ELECTROVÁLVULA |
| 12 0552550003 | 1 NR | BOBINA | COIL | BOBINE | SPULE | BOBINA |





 CILINDRIZYLINDER  CYLINDERSCILINDROS  CYLINDRES

| POS Codice | Q.tà |  Descrizione |  Description |  Designation |  Benennung |  Descripción |
|---------------|------|---|---|---|---|---|
| 13 05576200 | 6 NR | PROTEZIONE | PROTECTION | PROTECTION | SCHUTZ | PROTECCIÓN |
| 14 2706920001 | 1 NR | KIT GUARNIZIONI CILINDRO 3 BRACCIO | 3 ARM CYLINDER GASKET KIT | TIGE DU VERIN 1-2 ARM | ROD CYLINDER 1-2 ARM | VÁSTAGO DEL CILINDRO 1-2 ARM |
| 15 2706920002 | 1 NR | STELO CILINDRO 3 BRACCIO | 3 ARM CYLINDER ROD | 3 BRAS DE TIGE DU VERIN | 3 ZYLINDER ROD ARM | 3 ARM VÁSTAGO DEL CILINDRO |
| 17 2706900001 | 1 NR | KIT GUARNIZIONI CILINDRO SFILO | GASKET KIT CYLINDER EXTENSION | CYLINDRE JOINT KIT D'EXTENSION | CYLINDER GASKET BAUSÄTZE EXTENSION | EXTENSION KIT DE JUNTAS CILINDRO |
| 18 2706900002 | 1 NR | STELO CILINDRO SFILO | CYLINDER EXTENSION ROD | TIGE D'EXTENSION DE CYLINDRE | KOLBENSTANGE EXTENSION | EXTENSION ROD CILINDRO |
| 19 2706900003 | 1 NR | BLOCCO VALVOLA RIGENERATRICE CILINDRO SFILO | CYLINDER VALVE EXTENSION REGENERATIVE | SERRURE A CYLINDRE REGENERATIVE EXTENSION VALVE | SCHLIESSZYLIND ER VALVE EXTENSION REGENERATIVE | QUEO DEL CILINDRO DE EXTENSIÓN DE LA VÁLVULA REGENERATIVA |
| 20 2706950001 | 1 NR | KIT GUARNIZIONI CILINDRO JIB | SEAL KIT CYLINDER JIB | KIT DE JOINTS | DICHTUNGSSATZ | KIT JUNTAS CILINDRO JIB |
| 21 2706950002 | 1 NR | STELO CILINDRO JIB | ROD CYLINDER JIB | TIGE DE CYLINDRE JIB | KORBARM ZYLINDERSCHAF T | VASTAGO CILINDRO JIB |
| 22 2627890006 | 4 NR | BOCCOLA | BUSH | DOUILLE | BUCHSE | CASQUILLO |

 CILINDRI

 ZYLINDER 
 CYLINDERS

 CILINDROS 
 CYLINDRES

| POS Codice | Q.tà |  Descrizione |  Description |  Designation |  Benennung |  Descripción |
|---------------|------|---|---|---|---|---|
| 23 2627910006 | 4 NR | BOCCOLA | BUSH | DOUILLE | BUCHSE | CASQUILLO |
| 24 2706930001 | 1 NR | KIT GUARNIZIONI CILINDRO LIVELLAMENTO SU RINVIO | CYLINDER GASKET KIT | KIT DE JOINTS CYLINDRE NIVELLEMENT | DICHTSATZ ZYLINDER AUSNIVELLIERUN G | KIT DE JUNTAS CILINDRO NIVELACIÓN |
| 25 2706930002 | 1 NR | STELO CILINDRO LIVELLAMENTO SU RINVIO | ROD CYLINDER | TIGE CYLINDRE | ZYLINDERSCHAF T | VASTAGO CILINDRO |
| 26 2588290008 | 2 NR | VITE | SCREW | VIS | SCHRAUBE | TORNILLO |
| 27 2706940001 | 1 NR | KIT GUARNIZIONI CILINDRO LIVELLAMENTO SU CESTO | CYLINDER GASKET KIT | KIT DE JOINTS CYLINDRE NIVELLEMENT | DICHTSATZ | KIT JUNTAS |
| 28 2706940002 | 1 NR | STELO CILINDRO LIVELLAMENTO SU CESTO | BASKET LEVELING CYLINDER ROD ON BASKET | CYLINDRE TIGE | ZYLINDERSCHAF T | VASTAGO CILINDRO |
| 29 2731510003 | 1 NR | VALVOLA IDRAULICA | HYDRAULIC VALVE | VALVE HYDRAULIQUE | HYDRAULIKVENTI L | VÁLVULA HIDRÁULICA |

 COMPONENTI IMPIANTO ELETTRICO

KOMPONENTEN ELEKTROANLAGE 

 ELECTRICAL SYSTEM COMPONENTS

COMPONENTES INSTALACIÓN ELÉCTRICA 

 COMPOSANTS INSTALLATION ÉLECTRIQUE

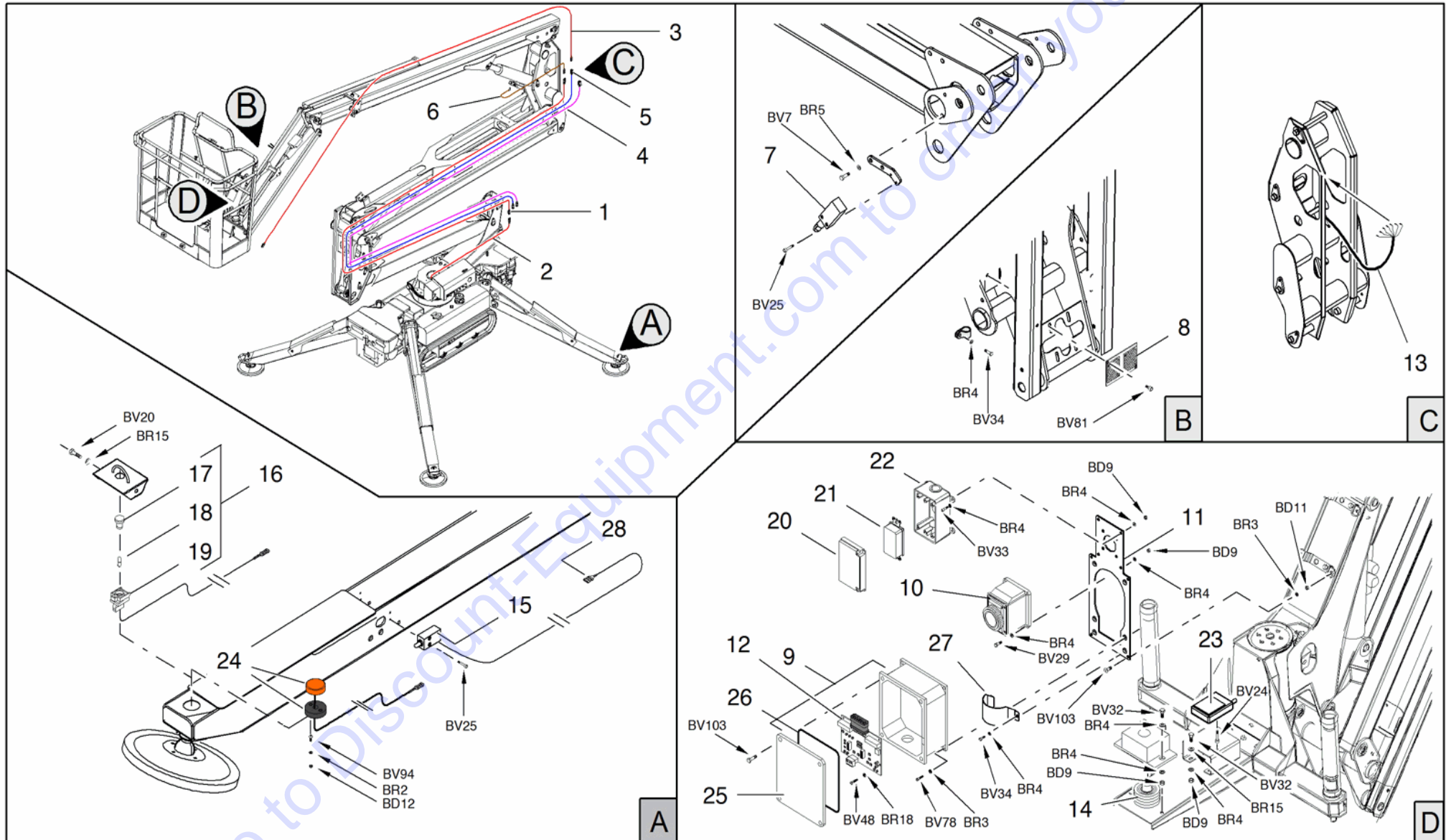





 COMPONENTI IMPIANTO ELETTRICO

 KOMponenten ELEKTROANLAGE

 ELECTRICAL SYSTEM COMPONENTS

 COMPONENTES INSTALACIÓN ELÉCTRICA

 COMPOSANTS INSTALLATION ÉLECTRIQUE

| POS Codice | Q.tà |  Descrizione |  Description |  Designation |  Benennung |  Descripción |
|--------------|------|---|---|---|---|---|
| 1 1764290001 | 1 NR | CAVO PROLUNGA 220-110V DA PRIMO BRACCIO A 3 BRACCIO MK2 (DA C170000893) | EXTENSION CABLE 220V-110V FROM 1 BOOM TO 3 BOOM MK2 (FROM C170000893) | | | |
| 2 1764290002 | 1 NR | CAVO PROLUNGA 220-110V DA BASE A PRIMO BRACCIO MK2 (DA C170000893) | EXTENSION CABLE 220V-110V FROM BASE TO 1 BOOM MK2 (FROM C170000893) | | | |
| 3 1764290003 | 1 NR | CAVO PROLUNGA 220-110V SFILO MK2 (DA C170000893) | EXTENSION CABLE 220V-110V EXTENSION BOOM MK2 (FROM C170000893) | | | |
| 4 1764290004 | 1 NR | CAVO PROLUNGA 7POLI DA 1 BRACCIO A 3 BRACCIO MK2 (DA C170000893) | EXTENSION CABLE 7WAY FROM 1 BOOM TO 3 BOOM MK2 (FROM C170000893) | | | |





 COMPONENTI IMPIANTO ELETTRICO

 KOMONENTEN ELEKTROANLAGE

 ELECTRICAL SYSTEM COMPONENTS

 COMPONENTES INSTALACIÓN ELÉCTRICA

 COMPOSANTS INSTALLATION ÉLECTRIQUE

| POS Codice | Q.tà |  Descrizione |  Description |  Designation |  Benennung |  Descripción |
|--------------|------|---|--|---|---|---|
| 5 1764290005 | 1 NR | CAVO PROLUNGA DISCESA DI EMERGENZA DA 1 BRACCIO A 3 BRACCIO MK2 (DA C170000893) | EXTENSION CABLE EMERGENCY LOWER FROM 1 BOOM TO 3 BOOM MK2 (FROM C170000893) | | | |
| 6 1730720094 | 1 NR | CAVO COMPLETO PER SENSORE DI POSIZIONE 3 CILINDRO BRACCIO | CABLE ASSEMBLY FOR POSITION SENSOR 3 BOOM CYLINDER | CÂBLE COMPLET POUR CAPTEUR DE POSITION 3° CYLINDRE BRAS | KABEL KOMPLETT FÜR POSITIONSENS OR 3. AUSLEGERARM-Z YLINDER | CABLE COMPLETO PARA SENSOR DE POSICIÓN 3ERO CILINDRO BRAZO |
| 6 1764290006 | 1 NR | CAVO SENSORE CILINDRO 3 BRACCIO MK2 (DA C170000893) | CABLE CYLINDER SENSOR 3 BOOM MK2 (FROM C170000893) | | | |
| 7 1591270003 | 1 NR | MICROINTERRUT TORE 2 CONTATTI NC TESTINA ROTELLA ACCIAIO CAVO LUNGO 2 METRI | MICROSWITCH 2 NC CONTACTS HEAD STEEL WHEEL LONG CABLE 2M | MICROINTERRUP TEUR | MIKROSCHALTER | MICROINTERRUP TOR |
| 8 1679890001 | 1 NR | CATARIFRANGEN TE 100X100 MM | REFLECTOR 100X100 MM | CATADIOPTRE | REFLEKTOR | CATADIÓPTRICO |





 COMPONENTI IMPIANTO ELETTRICO

 KOMponenten ELEKTROANLAGE

 ELECTRICAL SYSTEM COMPONENTS

 COMPONENTES INSTALACIÓN ELÉCTRICA

 COMPOSANTS INSTALLATION ÉLECTRIQUE

| POS Codice | Q.tà |  Descrizione |  Description |  Designation |  Benennung |  Descripción |
|--------------|------|---|---|---|---|---|
| 9 1730720007 | 1 NR | SCATOLA ALLUMINIO PER SCHEDA CELLA DI CARICO COMPLETA DI IMPIANTO, CONNETTORI E COPERCHIO | BOX ALUMINUM LOAD CELL CARD COMPLETE SYSTEM, CONNECTORS AND COVER | | | |
| 9 1764250002 | 1 NR | SCATOLA ALLUMINIO PER SCHEDA CELLA DI CARICO COMPLETA DI IMPIANTO, CONNETTORI E COPERCHIO MK2 (DA C170000893) | BOX ALUMINUM LOAD CELL CARD COMPLETE SYSTEM, CONNECTORS AND COVER MK2 (FROM C170000893) | | | |
| 9 17644500 | 1 NR | SCATOLA ALLUMINIO PER SCHEDA CELLA DI CARICO IMPIANTI CON DOPPIO CONNETTORE PER SENSORE CELLA | BOX ALUMINUM SHEET LOAD CELL SYSTEMS WITH DUAL SENSOR CONNECTOR FOR CELL | BOÎTE ÉLECTRIQUE | ELEKTROGEHÄU SE | CAJA ELÉCTRICA |

PARTS FINDER

**Search Website
by Part Number**



**Search Manual
Library For Parts
Manual & Lookup Part
Numbers – Purchase
or Request Quote**

Search Manuals

Enter your information to help us find the right parts manual for your equipment.

* Brand:

* Model:

* Serial:

* Part Number:

SEARCH

**Can't Find Part or
Manual? Request Help
by Manufacturer,
Model & Description**

Parts Order Form

Please fill in the following information to help us find the right part for your equipment.

| | |
|---------------|----------------------|
| Manufacturer: | <input type="text"/> |
| Model: | <input type="text"/> |
| Description: | <input type="text"/> |
| Part Number: | <input type="text"/> |
| Quantity: | <input type="text"/> |
| Notes: | <input type="text"/> |

Submit

Discount-Equipment.com is your online resource for quality parts & equipment.

Florida: **561-964-4949** Outside Florida TOLL FREE: **877-690-3101**

Need parts?

Click on this link: <http://www.discount-equipment.com/category/5443-parts/> and choose one of the options to help get the right parts and equipment you are looking for. Please have the machine model and serial number available in order to help us get you the correct parts. If you don't find the part on the website or on one of the online manuals, please fill out the request form and one of our experienced staff members will get back to you with a quote for the right part that your machine needs.

We sell worldwide for the brands: Genie, Terex, JLG, MultiQuip, Mikasa, Essick, Whiteman, Mayco, Toro Stone, Diamond Products, Generac Magnum, Airman, Haulotte, Barreto, Power Blanket, Nifty Lift, Atlas Copco, Chicago Pneumatic, Allmand, Miller Curber, Skyjack, Lull, Skytrak, Tsurumi, Husquvarna Target, Stow, Wacker, Sakai, Mi-T-M, Sullair, Basic, Dynapac, MBW, Weber, Bartell, Bennar Newman, Haulotte, Ditch Runner, Menegotti, Morrison, Contec, Buddy, Crown, Edco, Wyco, Bomag, Laymor, EZ Trench, Bil-Jax, F.S. Curtis, Gehl Pavers, Heli, Honda, ICS/PowerGrit, IHI, Partner, Imer, Clipper, MMD, Koshin, Rice, CH&E, General Equipment, Amida, Coleman, NAC, Gradall, Square Shooter, Kent, Stanley, Tamco, Toku, Hatz, Kohler, Robin, Wisconsin, Northrock, Oztec, Toker TK, Rol-Air, APT, Wylie, Ingersoll Rand / Doosan, Innovatech, Con X, Ammann, Mecalac, Makinex, Smith Surface Prep, Small Line, Wanco, Yanmar





 COMPONENTI IMPIANTO ELETTRICO

 KOMponenten ELEKTROANLAGE

 ELECTRICAL SYSTEM COMPONENTS

 COMPONENTES INSTALACIÓN ELÉCTRICA

 COMPOSANTS INSTALLATION ÉLECTRIQUE

| POS Codice | Q.tà |  Descrizione |  Description |  Designation |  Benennung |  Descripción |
|---------------|------|---|---|---|---|---|
| 10 1585570005 | 1 NR | PRESA ELETTRICA 230V | ELECTRICAL SOCKET 230V | PRISE ÉLECTRIQUE | STECKDOSE | ENCHUFE ELÉCTRICO |
| 10 1591700002 | 1 NR | PRESA ELETTRICA 110V | ELECTRICAL SOCKET 110V | PRISE ÉLECTRIQUE 110V | STECKDOSE 110V | ENCHUFE ELÉCTRICO 110V |
| 11 07173300 | 1 NR | PIASTRA VERSIONE CE | PLATE CE VERSION | PLATINE | PLATTE | PLACA |
| 11 07173800 | 1 NR | PIASTRA VERSIONE ANSI | PLATE ANSI VERSION | PLATINE | PLATTE | PLACA |
| 11 076710H3 | 1 NR | LAMIERA FISSAGGIO SCATOLA MK2 (DA C170000893) | PROTECTION RAL9005 MK2 (FROM C170000893) | PROTECTION RAL9005 MK2 (FROM C170000893) | SCHUTZ RAL9005 MK2 (FROM C170000893) | PROTECCION RAL9005 MK2 (FROM C170000893) |
| 11 076860H3 | 1 NR | LAMIERA FISSAGGIO SCATOLA MK2 (DA C170000893) | PLATE MK2 (FROM C170000893) | PLAQUE MK2 (FROM C170000893) | PLATTE MK2 (FROM C170000893) | PLACA MK2 (FROM C170000893) |





 COMPONENTI IMPIANTO ELETTRICO

 KOMponenten ELEKTROANLAGE

 ELECTRICAL SYSTEM COMPONENTS

 COMPONENTES INSTALACIÓN ELÉCTRICA

 COMPOSANTS INSTALLATION ÉLECTRIQUE

| POS Codice | Q.tà |  Descrizione |  Description |  Designation |  Benennung |  Descripció |
|---------------|------|---|---|---|---|--|
| 12 17770300 | 1 NR | SCHEDA CELLA DI CARICO 4-20MA RESINATA (MK2) | ELECTRONIC BOARD LOAD SENSOR 4-20MA (MK2) | CARTE ÉLECTRONIQUE (MK2) | ELEKTRONISCHE PLATINE (MK2) | PLACA ELECTRÓNICA (MK2) |
| 12 27480300 | 1 NR | SCHEDA ELETTRONICA SENSORE DI CARICO (PERFORMANCE- PLUS-AUSTRALIA) | ELECTRONIC BOARD LOAD SENSOR (PERFORMANCE- PLUS-AUSTRALIA) | CARTE ÉLECTRONIQUE | ELEKTRONISCHE PLATINE | PLACA ELECTRÓNICA |
| 13 1730720008 | 1 NR | CAVO 7 POLI LL1775/200 DA BASE A CESTO | 7-POLE CABLE LL1775/200 FROM BASE TO BASKET | | | |





 COMPONENTI IMPIANTO ELETTRICO

 KOMONENTEN ELEKTROANLAGE

 ELECTRICAL SYSTEM COMPONENTS

 COMPONENTES INSTALACIÓN ELÉCTRICA

 COMPOSANTS INSTALLATION ÉLECTRIQUE

| POS Codice | Q.tà |  Descrizione |  Description |  Designation |  Benennung |  Descripción |
|---------------|------|---|---|--|---|--|
| 14 1730720095 | 1 NR | SENSORE CELLA DI CARICO COMPLETA DI CAVO E CONNETTORE CABLATO PERFORMANCE E PLUS | SENSOR LOAD CELL COMPLETE WIRED CABLE AND CONNECTOR FOR PERFORMANCE AND PLUS | CAPTEUR CELLULE DE CHARGE COMPLÈTE DE CÂBLE ET CONNECTEUR AVEC CÂBLAGE PERFORMANCE ET PLUS | KORBLASTSENS OR KOMPLETT MIT KABEL UND VERBINDER FÜR PERFORMANCE UND PLUS | SENSOR CÉLULA DE CARGA COMPLETA DE CABLE Y CONECTOR CABLEADO PERFORMANCE Y PLUS |
| 14 17669800 | 1 NR | SENSORE CELLA DI CARICO 4-20MA COMPLETO DI CAVO E CONNETTORI M12 (MK2) | SENSOR LOAD CELL 4-20MA WITH CABLE AND CONNECTORS M12 (MK2 VERSION) | CELLULE DE CHARGE (MK2) | MESSDOSE (MK2) | CÉLULA DE CARGA (MK2) |
| 14 25611500 | 1 NR | CELLA DI CARICO | LOAD CELL | CELLULE DE CHARGE | MESSDOSE | CÉLULA DE CARGA |
| 15 1591270011 | 1 NR | MICROINTERRUTTORE 2 CONTATTI NC TESTINA A PULSANTE CAVO LUNGO 2 METRI | MICROSWITCH 2 NC CONTACTS BUTTON HEAD LONG CABLE 2M | MICROINTERRUTTORE | MIKROSCHALTER | MICROINTERRUTTORE |
| 16 1556350001 | 4 NR | LUCE STABILIZZATORE | STABILIZER LIGHT | LUMIÈRE STABILISATEUR | ABSTÜTZUNGSB ELEUCHTUNG | LUZ ESTABILIZADOR |
| 16 1556350001 | 1 NR | LUCE STABILIZZATORE | STABILIZER LIGHT | LUMIÈRE STABILISATEUR | ABSTÜTZUNGSB ELEUCHTUNG | LUZ ESTABILIZADOR |





 COMPONENTI IMPIANTO ELETTRICO

 KOMponenten ELEKTROANLAGE

 ELECTRICAL SYSTEM COMPONENTS

 COMPONENTES INSTALACIÓN ELÉCTRICA

 COMPOSANTS INSTALLATION ÉLECTRIQUE

| POS Codice | Q.tà |  Descrizione |  Description |  Designation |  Benennung |  Descripción |
|---------------|------|---|---|---|---|---|
| 17 1556350034 | 1 NR | SPIA | PILOT LIGHT | TÉMOIN | KONTROLLLEUC HTE | INDICADOR LUMINOSO |
| 18 1556350035 | 1 NR | LAMPADINA | LAMP | AMPOULE | GLÜHBIRNE | BOMBILLA |
| 19 1556350036 | 1 NR | CORPO | BODY | CORPS | GEHÄUSE | CUERPO |
| 20 27073800 | 1 NR | COVER PRESE USA AL CESTO, RECEPTACLE BOX PART N°:1671207 | COVER US SOCKETS TO BASKET, RECEPTACLE BOX PART N°:1671207 | PRETECTION | SCHUTZ | PROTECCIÓN |
| 21 27073900 | 1 NR | PLUG PRESE USA AL CESTO, RECEPTACLE PART N°:4460346 | US SOCKETS TO BASKET, RECEPTACLE PART N°:4460346 | PRISE | STECKDOSE | ENCHUFE |
| 22 27073700 | 1 NR | BOX PRESE USA AL CESTO, RECEPTACLE PART N°:0861731 | US SOCKET BOX TO BASKET, RECEPTACLE PART N°:0861731 | BOX PRISES | SCHACHTEL STECKDOSEN | CAJA ENCHUFES |
| 23 27031700 | 1 NR | INTERUTTORE A PEDALE | FOOT SWITCH | INTERRUPTEUR | FUßSCHALTER | INTERRUPTOR |
| 24 1757250023 | 1 NR | SPIA STABILIZZATORE LED COMPLETA DI CONNETTORE | LED LIGHT | TEMOIN LED | KONTROLLLAMP E | INDICADOR LED |





 COMPONENTI IMPIANTO ELETTRICO

 KOMponenten ELEKTROANLAGE

 ELECTRICAL SYSTEM COMPONENTS

 COMPONENTES INSTALACIÓN ELÉCTRICA

 COMPOSANTS INSTALLATION ÉLECTRIQUE

| POS Codice | Q.tà |  Descrizione |  Description |  Designation |  Benennung |  Descripción |
|-------------|------|---|---|---|---|---|
| 25 07141700 | 1 NR | COPERCHIO SCATOLA CELLA DI CARICO IN ALLUMINIO | BOX COVER ALUMINUM LOAD CELL | COUVERCLE DE LA BOÎTE ALUMINIUM | SCHACHTELDEC KEL ALUMINIUM | TAPA CAJA DE ALUMINIO |
| 26 07141800 | 1 NR | GUARNIZIONE SCATOLA CELLA DI CARICO IN ALLUMINIO | SEAL BOX ALUMINUM LOAD CELL | JOINT | DICHTUNG | SELLO |
| 27 075163H3 | 1 NR | PROTEZIONE CONNETTORI SCATOLA CELLA DICARICO MK2 (DA C170000893) | PROTECTION LOAD CELL CONNECTOR MK2 (FROM C170000893) | PROTECTION CONNECTEURS BOITE CELLULE DE CHARGE MK2 (FROM C170000893) | ABDECKUNG MK2 (FROM C170000893) | PROTECCION MK2 (FROM C170000893) |
| 27 075914B8 | 1 NR | PROTEZIONE CONNETTORI SCATOLA CELLA DICARICO AFTERMARKET | PROTECTION LOAD CELL CONNECTOR AFTER MARKET | PROTECTION CONNECTEURS BOITE CELLULE DE CHARGE | ABDECKUNG | PROTECCION |





 COMPONENTI IMPIANTO ELETTRICO

KOMPONENTEN ELEKTROANLAGE 

 ELECTRICAL SYSTEM COMPONENTS

COMPONENTES INSTALACIÓN ELÉCTRICA 

 COMPOSANTS INSTALLATION ÉLECTRIQUE

| POS Codice | Q.tà |  Descrizione |  Description |  Designation |  Benennung |  Descripción |
|---------------|------|---|---|---|---|---|
| 28 1730720085 | 1 NR | CAVO STABILIZZATORE COMPLETO DI CONNETTORE E MICRO | STABILIZER CABLE WITH CONNECTOR AND MICRO | CONNECTEUR AVEC STABILISATEUR ET MICRO | KABELSTECKER MIT STABILISATOR UND MICRO | CABLE CONECTOR CON ESTABILIZADOR Y MICRO |
| 28 1764250005 | 1 NR | CAVO STABILIZZATORE COMPLETO DI CONNETTORE E MICRO PER LUCE A LED MK2 (DA C170000893) | STABILIZER CABLE WITH CONNECTOR AND MICRO FOR LED MK2 (FROM C170000893) | CONNECTEUR AVEC STABILISATEUR ET MICRO LED MK2 (FROM C170000893) | KABELSTECKER MIT STABILISATOR UND MICRO LED MK2 (FROM C170000893) | CABLE CONECTOR CON ESTABILIZADOR Y MICRO LED MK2 (FROM C170000893) |

Go to Discount-Equipment.com to order your parts

 COMPONENTI IMPIANTO ELETTRICO

 ELECTRICAL SYSTEM COMPONENTS

 COMPOSANTS INSTALLATION ÉLECTRIQUE

KOMPONENTEN ELEKTROANLAGE 

COMPONENTES INSTALACIÓN ELÉCTRICA 

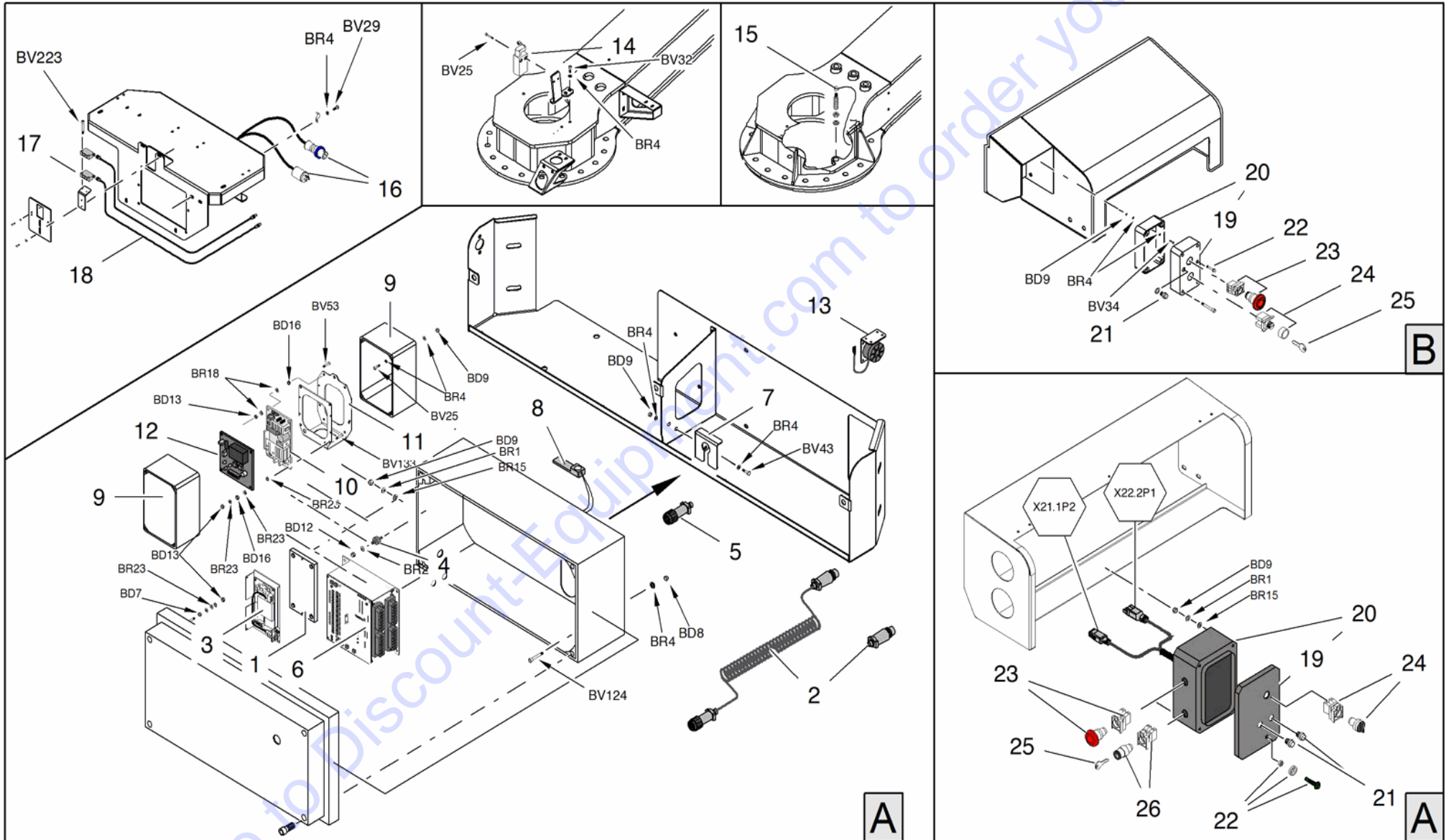





 COMPONENTI IMPIANTO ELETTRICO

 KOMONENTEN ELEKTROANLAGE

 ELECTRICAL SYSTEM COMPONENTS

 COMPONENTES INSTALACIÓN ELÉCTRICA

 COMPOSANTS INSTALLATION ÉLECTRIQUE

| POS Codice | Q.tà |  Descrizione |  Description |  Designation |  Benennung |  Descripción |
|--------------|------|--|--|---|---|---|
| 1 07396000 | 1 NR | PIASTRA ADATTAMENTO | PLATE ADAPTER | REGLAGE DE LA PLAQUE | FUSSPLATTENVE RSTELLUNG | AJUSTE DE LA PLACA |
| 2 17264200 | 1 NR | CAVO TELECOMANDO COMPLETO PER OPTIONAL | COMPLETE REMOTE CONTROL CABLE FOR OPTIONAL | CÂBLE TÉLÉCOMMANDE COMPLET | FERNBEDIENUNG SKABEL KOMPLETT | CABLE TELECOMANDO COMPLETO |
| 3 27321800 | 1 NR | SCHEDA MODEM CON NUOVO PROCESSORE (SUPPORTO A RICAMBIO 07396000) PER MACCHINE AUSTRALIA E PLUS | MODEM CARD WITH NEW CPU (MOUNTING SPARE PARTS 07396000) FOR AUSTRALIAN AND PLUS MACHINES | CARTE MODEM AVEC UN NOUVEAU PROCESSEUR | MODEMKARTE MIT NEUEN PROZESSOR | MODEM TARJETA CON NUEVO PROCESADOR |
| 4 1730720018 | 1 NR | ANTIVIBRANTE SCATOLA GENERALE SUPPORTO SCHEDA MASTER CIAM | ANTI-VIBRATING ELEMENT | INSERT EN CAOUTCHOUC | VIBRATIONSDÄM PFER | ANTIVIBRACION |
| 5 17306800 | 1 NR | CONNETTORE COMPLETO PER TELECOMANDO A TERRA E SERVICE | COMPLETE CONNECTOR FOR REMOTE CONTROL ON THE GROUND AND SERVICE | CONNECTEUR COMPLET | VERBINDER | CONECTOR |





 COMPONENTI IMPIANTO ELETTRICO

 KOMponenten ELEKTROANLAGE

 ELECTRICAL SYSTEM COMPONENTS

 COMPONENTES INSTALACIÓN ELÉCTRICA

 COMPOSANTS INSTALLATION ÉLECTRIQUE

| POS Codice | Q.tà |  Descrizione |  Description |  Designation |  Benennung |  Descripción |
|------------|------|--|---|---|---|---|
| 6 17506700 | 1 NR | KIT BANCO PROGRAMMAZIO NE SCHEDE PIATTAFORME | PROGRAMMATIO N KIT | KIT PROGRAMMATIO N | PROGRAMMATIO NSATZ | KIT PROGRAMACION |
| 6 27179900 | 1 NR | SCHEDA ELETTRONICA NUOVO PROCESSORE (PER MACCHINE AUSTRALIA E PLUS) (+17172600 SE FORNITA A RICAMBIO CON SOFTWARE INSTALLATO) | ELECTRONIC BOARD NEW CPU (FOR AUSTRALIAN AND PLUS MACHINES) (+17172600 IF SUPPLIED PARTS WITH SOFTWARE INSTALLED) | FICHE ÉLECTRONIQUE | ELEKTRONISCHE PLATINE | TARJETA ELECTRÓNICA |
| 6 27180000 | 1 NR | SCHEDA ELETTRICA NUOVO PROCESSORE VERSIONE LITIO (+17172600 SE FORNITA A RICAMBIO CON SOFTWARE INSTALLATO) | ELECTRIC BOARD NEW CHIP LITHIUM VERSION (+17172600 IF SUPPLIED PARTS WITH SOFTWARE INSTALLED) | FICHE ÉLECTRIQUE | ELEKTRISCHE PLATINE | TARJETA ELÉCTRICA |
| 7 073181Y1 | 1 NR | STAFFA | BRACKET | ÉTRIER | HALTEBÜGEL | ESTRIBO |





 COMPONENTI IMPIANTO ELETTRICO

 KOMponenten ELEKTROANLAGE

 ELECTRICAL SYSTEM COMPONENTS

 COMPONENTES INSTALACIÓN ELÉCTRICA

 COMPOSANTS INSTALLATION ÉLECTRIQUE

| POS Codice | Q.tà |  Descrizione |  Description |  Designation |  Benennung |  Descripción |
|-------------|------|---|---|---|---|---|
| 8 27396100 | 1 NR | ANTENNA | AERIAL | ANTENNE | ANTENNE | ANTENA |
| 9 17348200 | 1 NR | SCATOLA ELETTRICA SWITCHING (A PARTIRE DA C170000340 PER MACCHINE ANSI) | SWITCHING ELECTRICAL BOX (FROM C170000340 FOR ANSI MACHINES) | BOÎTE ÉLECTRIQUE | ELEKTROGEHÄU SE | CAJA ELÉCTRICA |
| 10 27249800 | 1 NR | ALIMENTATORE SWITCHING (DA C170000340 PER MACCHINE ANSI) | SWITCHING POWER SUPPLY (FROM C170000340 FOR ANSI MACHINES) | TRANSFORMATE UR | TRANSFORMATO R | TRANSFORMADO R |
| 11 07243300 | 1 NR | LAMIERA SUPPORTO SCHEDE E SWITCHING (DA C170000340 PER MACCHINE ANSI) | BRAKET FOR CARD AND SWITCHING (FROM C170000340 FOR ANSI MACHINES) | SUPPORT | HALTERUNG | SOPORTE |
| 12 17722600 | 1 NR | SCHEDE ELETTRONICA | ELECTRONIC BOARD | FICHE ÉLECTRIQUE | ELEKTRONISCHE PLATINE | PLACA ELECTRÓNICA |
| 13 06639100 | 1 NR | AVVISATORE ACUSTICO | ACOUSTIC ALARM | BUZZER | SUMMER | ZUMBADOR |





 COMPONENTI IMPIANTO ELETTRICO

 KOMONENTEN ELEKTROANLAGE

 ELECTRICAL SYSTEM COMPONENTS

 COMPONENTES INSTALACIÓN ELÉCTRICA

 COMPOSANTS INSTALLATION ÉLECTRIQUE

| POS Codice | Q.tà |  Descrizione |  Description |  Designation |  Benennung |  Descripción |
|---------------|------|--|---|---|---|---|
| 14 1590900003 | 1 NR | MICROINTERRUTTORE 2 CONTATTI NC TESTINA BRACCIO DISASSATO E ROTELLA IN PLASTICA CAVO LUNGO 2 METRI | 2 NC CONTACTS MICROSWITCH HEAD OFFSET ARM AND WHEEL PLASTIC LONG CABLE 2M | MICROINTERRUPTEUR | MIKROSCHALTER | MICROINTERRUPTOR |
| 15 1651290010 | 1 NR | SENSORE DI PROSSIMITÀ | PROXIMITY SENSOR | CAPTEUR DE PROXIMITÉ | NÄHERUNGSSENSOR | SENSOR DE PROXIMIDAD |
| 16 1556350013 | 1 NR | SPINA FISSA 230V 90° | PLUG 230V 90° | CHEVILLE | STIF | CLAVIJA |
| 16 1556350064 | 1 NR | SPINA FISSA 110V 90° | PLUG 110V 90° | CHEVILLE | STIF | CLAVIJA |
| 16 1757250001 | 1 NR | SPINA VOLANTE 230V 16A | FREE PLUG 230V 16A | FICHE | STECKER | ENCHUFE |
| 16 27074000 | 1 NR | TERMINAL PRESA USA A TERRA, CONN PLUG PART N°:4460138 | TERMINAL GROUND SOCKET USA, CONN PLUG PART N°: 4460138 | CONNECTEUR | VERBINDER | CONECTOR |
| 17 1591270001 | 1 NR | FOTOCELLULA | PHOTOCELL | CELLULE PHOTO-ÉLECTRIQUE | PHOTOZELLE | FOTOCÉLULA |





 COMPONENTI IMPIANTO ELETTRICO

KOMPONENTEN ELEKTROANLAGE 

 ELECTRICAL SYSTEM COMPONENTS

COMPONENTES INSTALACIÓN ELÉCTRICA 

 COMPOSANTS INSTALLATION ÉLECTRIQUE





| POS Codice | Q.tà |  Descrizione |  Description |  Designation |  Benennung |  Descripcìon |
|-----------------|------|---|---|---|---|---|
| 18 159127000101 | 1 NR | CAVO ELETTRICO | ELECTRIC CABLE | CÂBLE ÉLECTRIQUE | ELEKTROKABEL | CABLE ELÉCTRICO |
| 19 175726002401 | 1 NR | COPERCHIO SCATOLA STOP A TERRA DIESEL LL2614-X26JP-X7 70AJ | BOX COVER | COUVERCLE BOÎTE | KASTENABDECK UNG | TAPA DE CAJA |
| 19 175727000201 | 1 NR | COPERCHIO SCATOLA STOP A TERRA LITHIUM 83V | BOX COVER | COUVERCLE BOÎTE | KASTENABDECK UNG | TAPA DE CAJA |

Go to Discount-Equipment.com to order your parts

 COMPONENTI IMPIANTO ELETTRICO

 KOMponenten ELEKTROANLAGE 
 ELECTRICAL SYSTEM COMPONENTS





 COMPONENTES INSTALACIÓN ELÉCTRICA 
 COMPOSANTS INSTALLATION ÉLECTRIQUE

| POS Codice | Q.tà |  Descrizione |  Description |  Designation |  Benennung |  Descripcìon |
|-----------------|------|--|---|---|---|---|
| 20 1730720011 | 1 NR | SCATOLA STOP A TERRA BENZINA/DIESEL COMPLETA DI CABLAGGIO E CONNETTORE | BOX GROUND STOP PETROL / DIESEL COMPLETE WIRING AND CONNECTOR | | | |
| 20 173072001101 | 1 NR | SCATOLA VUOTA STOP A TERRA BENZINA/DIESEL | BOX GROUND STOP PETROL / DIESEL | BOÎTE | GEHÄUSE | CAJA |
| 20 1730720093 | 1 NR | SCATOLA STOP A TERRA LITHIUM COMPLETA DI CABLAGGIO E CONNETTORE | BOX GROUND STOP LITHIUM COMPLETE WIRING AND CONNECTOR | | | |
| 20 1757260024 | 1 NR | SCATOLA STOP A TERRA DIESEL LL2614-X26JP-X7 70AJ COMPLETA DI CABLAGGIO E CONNETTORE | BOX WITH WIRING | BOÎTE AVEC CÂBLAGE | KASTEN MIT VERKABELUNG | CAJA CON CABLEADO |
| 20 175726002402 | 1 NR | COPERCHIO SCATOLA STOP A TERRA DIESEL LL2614-X26JP-X7 70AJ | BOX COVER | COUVERCLE BOÎTE | KASTENABDECK UNG | TAPA DE CAJA |

 COMPONENTI IMPIANTO ELETTRICO

 KOMponenten ELEKTROANLAGE 
 ELECTRICAL SYSTEM COMPONENTS

 COMPONENTES INSTALACIÓN ELÉCTRICA 
 COMPOSANTS INSTALLATION ÉLECTRIQUE

| POS Codice | Q.tà |  Descrizione |  Description |  Designation |  Benennung |  Descripción |
|---------------|------|---|---|---|---|---|
| 20 1757270002 | 1 NR | SCATOLA STOP A TERRA LITHIUM 83V COMPLETA DI CABLAGGIO E CONNETTORE | BOX WITH WIRING | BOÎTE AVEC CÂBLAGE | KASTEN MIT VERKABELUNG | CAJA CON CABLEADO |
| 21 1628400001 | 1 NR | PULSANTE | BUTTON | BOUTON | DRUCKKNOPF | BOTÓN |
| 22 1730720005 | 1 NR | SPIA VERDE PARTE AEREA GRANDE | BIG GREEN LIGHT AERIAL PART | VOYANT | KONTROLLLEUC HTE | INDICADOR |
| 23 1591270004 | 1 NR | PULSANTE | BUTTON | BOUTON | DRUCKKNOPF | BOTÓN |
| 24 1556350068 | 1 NR | SELETTORE A LEVA 3 POSIZIONI | 3 POSITION LEVER SWITCH | SÉLECTEUR | WÄHLSCHALTER | SELECTOR |
| 25 1651290015 | 1 NR | CHIAVE | KEY | CLÉ | SCHLÜSSEL | LLAVE |
| 26 1692150001 | 1 NR | BLOCCHETTO | BLOCK | BLOC | BLOCK | BLOQUE |





 IMPIANTO ELETTRICO

ELEKTRISCHE ANLAGE 

 ELECTRICAL SYSTEM

INSTALACIÓN ELÉCTRICA 

 INSTALLATION ÉLECTRIQUE

| POS Codice | Q.tà |  Descrizione |  Description |  Designation |  Benennung |  Descripcìon |
|--------------|------|---|--|---|---|---|
| 1 1730720009 | 1 NR | SCATOLA GENERALE IMPIANTO ELETTRICO COMPLETA DI CABLAGGIO,CON NETTORI E COPERCHIO | MAIN BOX ELECTRICAL WIRING COMPLETE WITHCONNECTO RS AND COVER | | | |
| 1 1764250003 | 1 NR | SCATOLA GENERALE IMPIANTO ELETTRICO COMPLETA DI CABLAGGIO,CON NETTORI E COPERCHIO MK2 (DA C170000893) | MAIN BOX ELECTRICAL WIRING COMPLETE WITHCONNECTO RS AND COVER MK2 (FROM C170000893) | | | |





 IMPIANTO ELETTRICO

 ELEKTRISCHE ANLAGE





 ELECTRICAL SYSTEM

 INSTALACIÓN ELÉCTRICA

 INSTALLATION ÉLECTRIQUE

| POS Codice | Q.tà |  Descrizione |  Description |  Designation |  Benennung |  Descripción |
|--------------|-------|---|---|---|---|---|
| 2 1730720012 | 1 NR | CONNETTORE PONTE VERSIONE BENZINA | CONNECTOR BRIDGE VERSION PETROL | | | |
| 2 1730720014 | 1 NR | CONNETTORE PONTE VERSIONE DIESEL 10RPM (LL1775) | CONNECTOR BRIDGE VERSION DIESEL 10 (LL1775) | | | |
| 2 1730720073 | 15 NR | TERMINALE MASCHIO D.0,5-1 MM (X34) | TERMINAL MALE D.0 0.5 TO 1 MM (X34) | BORNE MALE D.0 0,5 A 1 MM (X34) | TERMINAL MALE D.0 0,5 BIS 1 MM (X34) | TERMINAL MACHO D.0 0,5 A 1 MM (X34) |
| 2 1730720074 | 10 NR | TERMINALE MASCHIO D.1,5-2,5 MM (X34) | TERMINAL MALE D.1 0.5 TO 2, 5 MM (X34) | BORNE MALE D.1 0,5 A 2, 5 MM (X34) | TERMINAL MALE D.1 0,5 BIS 2, 5 MM (X34) | TERMINAL MACHO D.1 0,5 A 2, 5 MM (X34) |
| 2 1730720075 | 15 NR | TERMINALE FEMMINA D 0,5-1 MM (X34) | TERMINAL FEMALE D 0.5-1 MM (X34) | BORNE FEMELLE D 0,5-1 MM (X34) | TERMINAL FEMALE D 0,5-1 MM (X34) | TERMINAL HEMBRA D 0.5-1 MM (X34) |
| 2 1730720076 | 10 NR | TERMINALE FEMMINA D 1,5-2,5 MM (X34) | TERMINAL FEMALE D 1.5-2.5 MM (X34) | BORNE FEMELLE D 1,5-2,5 MM (X34) | TERMINAL FEMALE D 1,5-2,5 MM (X34) | TERMINAL HEMBRA D 1.5 A 2.5 MM (X34) |
| 2 1730720089 | 1 NR | CONNETTORE PONTE VERSIONE LITIO 48V | CONNECTOR BRIDGE 48V LITHIUM VERSION | CONNEXION | CONNECTOR | CONECTOR |

 IMPIANTO ELETTRICO
ELEKTRISCHE ANLAGE 
 ELECTRICAL SYSTEM
INSTALACIÓN ELÉCTRICA 
 INSTALLATION ÉLECTRIQUE

| POS Codice | Q.tà |  Descrizione |  Description |  Designation |  Benennung |  Descripción |
|--------------|------|---|---|---|---|---|
| 2 1776330001 | 1 NR | CONNETTORE PONTE VERSIONE BENZINA MK2 (DA C170000893) | CONNECTOR BRIDGE VERSION PETROL MK2 (FROM C170000893) | | | |
| 3 1739150059 | 1 NR | RELE' MICRO PER MONTAGGIO INTERNO SCATOLA 12V CON DIODO | MICRO RELAY 'FOR INTERNAL MOUNTING BOX WITH DIODE 12V | RELAIS MICRO POUR MONTAGE INTÉRIEUR BOÎTIER 12V AVEC DIODE | RELAIS MICROSCHALTER IM 12V KASTEN MIT DIODE | RELÉ MICRO PARA MONTAJE INTERNO CAJA 12V CON DIODO |
| 4 1730720004 | 1 NR | CENTRALINA 4 RELE' REGOLAZIONE RPM | RELAY BOX 4 'RPM ADJUSTMENT | BOÎTE RELAIS DE COMMANDE | RELAIS SCHACHTEL 4 RPM | CAJA RELÉ 4 RPM |
| 5 17473800 | 6 NR | PUNTALINO FEMMINA PER CONNETTORE 24 VIE SCHEDELLA DI CARICO D=2.8 | FERRULE FEMALE CONNECTOR 24 WAY BOARD LOAD CELL D = 2.8 | EMBOUT FEMELLE POUR CONNECTEUR 24 VOIES CARTE CELLULE DE CHARGE D=2.8 | VERSCHRAUBUNG G BUCHSE FÜR 24-WEGE-VERBINDUNG DER KORBLAST-PLATINE D=2,8 | PUNTAL HEMBRA PARA CONECTOR 24 VÍAS CELULA DE CARGA D=2.8 |
| 5 17473800 | 1 NR | PUNTALINO FEMMINA PER CONNETTORE 24 VIE SCHEDELLA DI CARICO D=2.8 | FERRULE FEMALE CONNECTOR 24 WAY BOARD LOAD CELL D = 2.8 | EMBOUT FEMELLE POUR CONNECTEUR 24 VOIES CARTE CELLULE DE CHARGE D=2.8 | VERSCHRAUBUNG G BUCHSE FÜR 24-WEGE-VERBINDUNG DER KORBLAST-PLATINE D=2,8 | PUNTAL HEMBRA PARA CONECTOR 24 VÍAS CELULA DE CARGA D=2.8 |
| 6 05760800 | 1 NR | FUSIBILE 7,5 A | FUSE 7,5 A | FUSIBLE 7,5 A | SICHERUNG 7,5 A | FUSIBLE 7,5 A |





 IMPIANTO ELETTRICO

 ELEKTRISCHE ANLAGE

 ELECTRICAL SYSTEM





 INSTALACIÓN ELÉCTRICA

 INSTALLATION ÉLECTRIQUE





| POS Codice | Q.tà |  Descrizione |  Description |  Designation |  Benennung |  Descripción |
|---------------|------|---|---|---|---|---|
| 7 1730720010 | 1 NR | COPERCHIO SCATOLA GENERALE IMPIANTO ELETTRICO | MAIN BOX ELECTRIC COVER | | | |
| 8 17306000 | 1 NR | PARTE DI CONNETTORE | CONNECTOR PART | CONNECTEUR | VERBINGER | CONECTADOR |
| 9 17306100 | 1 NR | COPERCHIO | COVER | COUVERCLE | DECKEL | TAPA |
| 10 17306200 | 1 NR | SLITTA | SLIDE | COULISSEAU | SCHLITTEN | CORREDERA |
| 11 07503600 | 1 NR | CONNETTORE PORTA FEMMINE 6 VIE PER MODEM | PORT CONNECTOR 6 WAY FEMALE FOR MODEM | CONNECTEUR PORTE-FEMELLE S 6 VOIES POUR MODEM | VERBINDER | CONNECTOR |
| 12 1730720077 | 1 NR | CONNETTORE 17 VIE M CENTRALINA RELE' RPM (X33) | CONNECTOR | CONNECTEUR | VERBINDER | CONECTADOR |

Go to Discount-Equipment.com to order your parts

 IMPIANTO ELETTRICO
ELEKTRISCHE ANLAGE 
 ELECTRICAL SYSTEM
INSTALACIÓN ELÉCTRICA 
 INSTALLATION ÉLECTRIQUE

| POS Codice | Q.tà |  Descrizione |  Description |  Designation |  Benennung |  Descripción |
|---------------|-------|---|---|---|---|---|
| 13 17306300 | 18 NR | PUNTALINO FEMMINA PER CONNETTORE 56 VIE SCHEDA MASTER D=1.5 | FERRULE FEMALE CONNECTOR 56 WAY MAIN BOARD D = 1.5 | BUTÉE FEMELLE CONNECTEUR 56 VOIES CARTE MASTER D = 1.5 | AUFLAGESTIFT BUCHSE 56-WEGE-VERBIN DER MASTERPLATINE D = 1.5 | CONECTOR PUNTA HEMBRA 56 VÍAS TARJETA MASTER D=1,5 |
| 13 17306300 | 1 NR | PUNTALINO FEMMINA PER CONNETTORE 56 VIE SCHEDA MASTER D=1.5 | FERRULE FEMALE CONNECTOR 56 WAY MAIN BOARD D = 1.5 | BUTÉE FEMELLE CONNECTEUR 56 VOIES CARTE MASTER D = 1.5 | AUFLAGESTIFT BUCHSE 56-WEGE-VERBIN DER MASTERPLATINE D = 1.5 | CONECTOR PUNTA HEMBRA 56 VÍAS TARJETA MASTER D=1,5 |
| 14 17473700 | 1 NR | SLITTA PER CONNETTORE 24 VIE | SLIDE FOR 24-WAY CONNECTOR | COULISSEAU | SCHLITTEN | CORREDERA |
| 15 17473600 | 1 NR | PARTE DI CONNETTORE 24VIE | CONNECTOR PART 24 WAY | CONNECTEUR | VERBINGER | CONECTADOR |
| 16 1730720078 | 20 NR | CONTATTO FEMMINA (X33) | CONTACT FEMALE (X33) | CONTACT FEMELLE (X33) | CONTACT FEMALE (X33) | CONTACTO HEMBRA (X33) |
| 16 1730720078 | 1 NR | CONTATTO FEMMINA (X33) | CONTACT FEMALE (X33) | CONTACT FEMELLE (X33) | CONTACT FEMALE (X33) | CONTACTO HEMBRA (X33) |
| 17 1585570006 | 1 NR | SELETTORE | SELECTOR | SÉLECTEUR | WÄHLSCHALTER | SELECTOR |

 IMPIANTO ELETTRICOELEKTRISCHE ANLAGE  ELECTRICAL SYSTEMINSTALACIÓN ELÉCTRICA  INSTALLATION ÉLECTRIQUE

| POS Codice | Q.tà |  Descrizione |  Description |  Designation |  Benennung |  Descripción |
|-------------|------|---|---|---|---|---|
| 18 07503700 | 1 NR | PUNTALINO FEMMINA PER CONNETTORE MODEM | CLAMP | BORNE | KLEMME | BORNE |

Go to Discount-Equipment.com to order your parts

 COMPONENTI IMPIANTO ELETTRICO LITIO

KOMPONENTEN ELEKTROANLAGE LITHIUM 

 ELECTRICAL SYSTEM COMPONENTS LITHIUM

COMPONENTES INSTALACIÓN ELÉCTRICA LITHIUM 



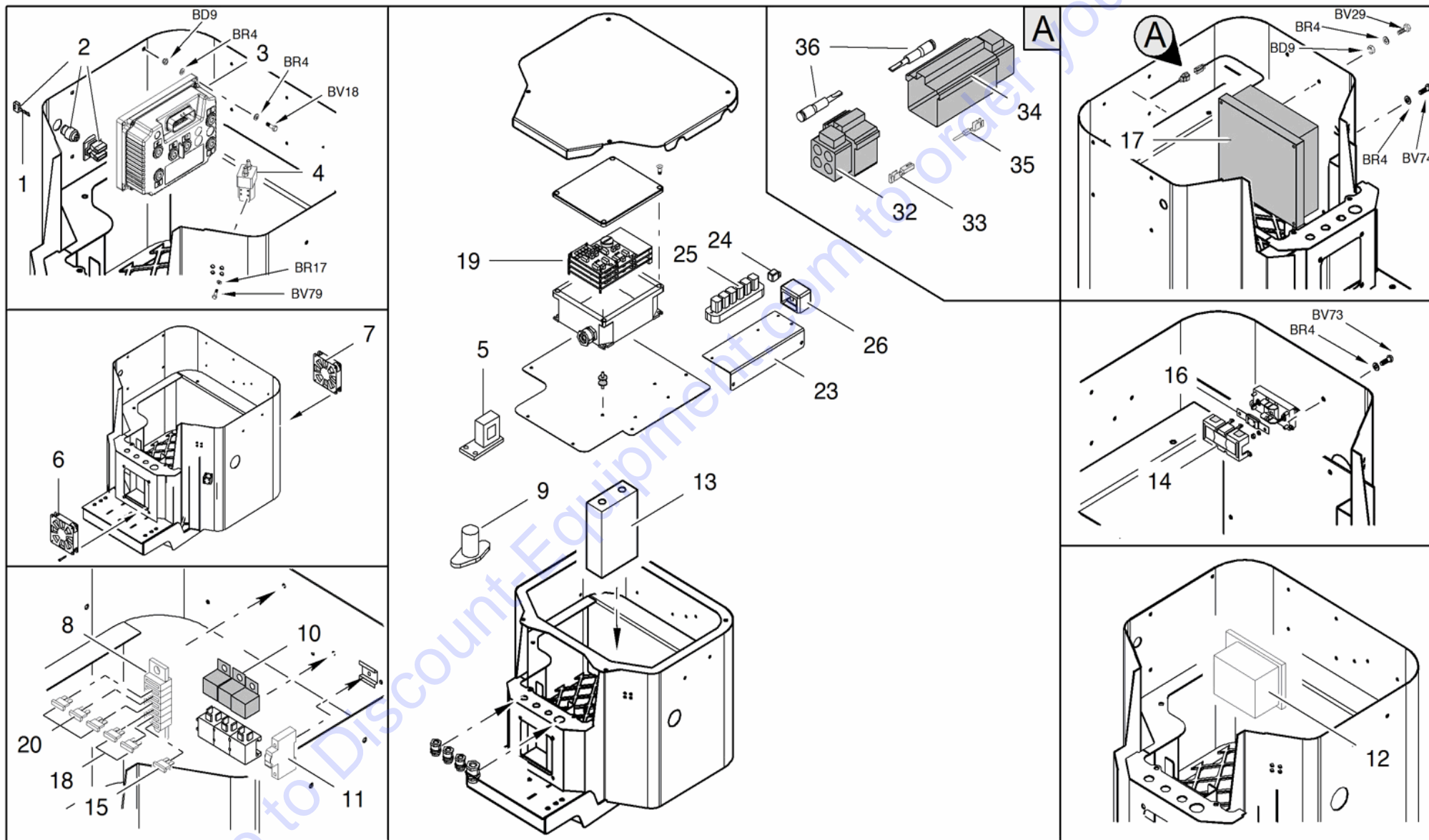

 COMPOSANTS INSTALLATION ÉLECTRIQUE LITHIUM



 COMPONENTI IMPIANTO ELETTRICO LITIO

 KOMponenten ELEKTROANLAGE LITHIUM 
 ELECTRICAL SYSTEM COMPONENTS LITHIUM

 COMPONENTES INSTALACIÓN ELÉCTRICA LITHIUM 
 COMPOSANTS INSTALLATION ÉLECTRIQUE LITHIUM

| POS Codice | Q.tà |  Descrizione |  Description |  Designation |  Benennung |  Descripción |
|---------------|------|---|---|---|---|---|
| 2 1730720091 | 1 NR | BLOCCHETTO CHIAVE COMPLETO DI CHIAVE PER PACCHI LITIO PERFORMANCE (PLUS) | KEY BLOCK COMPLETE WITH KEY FOR LITHIUM PERFORMANCE (PLUS) | BLOC CLÉ COMPLÈTE | KEY BLOCK COMPLETE | BLOQUE CLAVE COMPLETO |
| 3 26774600 | 1 NR | INVERTER | INVERTER | INVERTER | INVERTER | INVERTER |
| 4 26429300 | 1 NR | TELERUTTORE | REMOTE-CONTR OL SWITCH | TÉLÉRUPTeur | FERNsCHALTER | TELERUPTOR |
| 5 1735210002 | 1 NR | TRASDUTTORE DI CORRENTE (DA C170000330) | CURRENT TRANSDUCER (FROM C170000330) | TRANSFORMATE UR D'INTENSITÉ (DA C170000330) | STROMMESSUMF ORMER (DA C170000330) | TRANSDUCTOR DE CORRIENTE ELÉCTRICA (DA C170000330) |
| 6 1690690001 | 1 NR | VENTOLA ANTERIORE | FRONT FAN | VENTILATEUR | LÜFTERRAD | VENTILADOR |
| 7 1690690002 | 1 NR | VENTOLA POSTERIORE | REAR FAN | VENTILATEUR | LÜFTERRAD | VENTILADOR |
| 8 1690690003 | 1 NR | BLOCCHETTO | FUSE HOLDERS BLOCK | BLOC | BLOCK | BLOQUE |
| 9 1690690020 | 1 NR | TELERUTTORE | REMOTE-CONTR OL SWITCH | TÉLÉRUPTeur | FERNsCHALTER | TELERUPTOR |
| 10 1690690005 | 1 NR | RELÈ | RELAY | RELAIS | RELAIS | RELÉ |





 COMPONENTI IMPIANTO ELETTRICO LITIO

 KOMONENTEN ELEKTROANLAGE LITHIUM

 ELECTRICAL SYSTEM COMPONENTS LITHIUM

 COMPONENTES INSTALACIÓN ELÉCTRICA LITHIUM





 COMPOSANTS INSTALLATION ÉLECTRIQUE LITHIUM

| POS Codice | Q.tà |  Descrizione |  Description |  Designation |  Benennung |  Descripción |
|---------------|------|---|---|---|---|---|
| 12 27032500 | 1 NR | TRASFORMATORE | TRANSFORMER | TRANSFORMATEUR | TRANSFORMATOR | TRANSFORMADOR |
| 13 1690690022 | 1 NR | CELLA SINGOLA VERSIONE A | SINGLE CELL VERSION A | CELLULE UNIQUE A | EINZELZELLE A | UNICELULARES A |
| 13 1742410001 | 1 NR | CELLA LITIO VERSIONE B | LITHIUM CELL VERSION B | CELLULE LITHIUM UNIQUE B | LITHIUM EINZELZELLE B | CELDA BATERIA LITIO VERSION B |
| 14 1690690009 | 1 NR | COPERCHIO | COVER | COUVERCLE | DECKEL | TAPA |
| 15 05760800 | 1 NR | FUSIBILE 7,5 A | FUSE 7,5 A | FUSIBLE 7,5 A | SICHERUNG 7,5 A | FUSIBLE 7,5 A |
| 16 1690690011 | 1 NR | FUSIBILE 160A | FUSE 160A | FUSIBLE 160A | SICHERUNG 160A | FUSIBLE 160A |
| 17 27193200 | 1 NR | CARICA BATTERIA 230V | BATTERY CHARGER 230V | CHARGE BATTERIE 230V | BATTERIELADER 230V | CARGA BATERÍAS 230V |
| 18 05760600 | 1 NR | FUSIBILE 3A | FUSE 3A | FUSIBLE 3A | SICHERUNG 3A | FUSIBLE 3A |

 COMPONENTI IMPIANTO ELETTRICO LITIO

 KOMponenten ELEKTROANLAGE LITHIUM 
 ELECTRICAL SYSTEM COMPONENTS LITHIUM

 COMPONENTES INSTALACIÓN ELÉCTRICA LITHIUM 
 COMPOSANTS INSTALLATION ÉLECTRIQUE LITHIUM

| POS Codice | Q.tà |  Descrizione |  Description |  Designation |  Benennung |  Descripcìon |
|---------------|------|---|---|---|---|---|
| 19 1735210001 | 1 NR | BMS 48V NUOVA VERSIONE (DA C170000330) | BMS 48V NEW VERSION (FROM C170000330) | BMS 48V | BMS 48V | BMS 48V |
| 19 1737990002 | 1 NR | CONTATTI A CRIMPARE C PER BMS | FERRULE CRIMP C FOR BMS | | | |
| 19 1737990003 | 1 NR | CONTATTI A CRIMPARE F PER BMS | FERRULE CRIMP F FOR BMS | | | |
| 19 1737990004 | 1 NR | HOUSING F CAN 4VIE PER BMS | HOUSING F CAN 4 WAY FOR BMS | | | |
| 19 1737990005 | 1 NR | HOUSING F OPTO POWER 8VIE PER BMS | HOUSING F OPTO POWER 8 WAY FOR BMS | | | |
| 19 1737990006 | 1 NR | HOUSING F VOLTAGE 20VIE PER BMS | HOUSING F VOLTAGE 20 WAY FOR BMS | | | |
| 19 1737990007 | 1 NR | HOUSING C NO OPTO SIGNAL 18VIE PER BMS | HOUSING C NO OPTO SIGNAL 18 WAY FOR BMS | | | |
| 19 1737990008 | 1 NR | HOUSING C OPTO SIGNAL 14VIE FOR BMS | HOUSING C OPTO SIGNAL 14 WAY FOR BMS | | | |
| 19 1737990009 | 1 NR | HOUSING C TEMPERATURE 16VIE FOR BMS | HOUSING C TEMPERATURE 16 WAY FOR BMS | | | |





 COMPONENTI IMPIANTO ELETTRICO LITIO

 KOMONENTEN ELEKTROANLAGE LITHIUM

 ELECTRICAL SYSTEM COMPONENTS LITHIUM

 COMPONENTES INSTALACIÓN ELÉCTRICA LITHIUM

 COMPOSANTS INSTALLATION ÉLECTRIQUE LITHIUM

| POS Codice | Q.tà |  Descrizione |  Description |  Designation |  Benennung |  Descripción |
|---------------|------|---|---|---|---|---|
| 20 05760900 | 1 NR | FUSIBILE 10A | FUSE 10A | FUSIBLE 10A | SICHERUNG 10A | FUSIBLE 10A |
| 23 073964Y1 | 1 NR | PIASTRA | PLATE | PLATINE | PLATTE | PLACA |
| 24 1730720086 | 1 NR | TAPPO CONNETTORE 2 VIE | CONNECTOR PLUG 2 WAY | BOUCHON CONNECTEUR | VERSCHLUSS VERBINDER | TAPA CONECTOR |
| 25 1730720087 | 1 NR | CONNETTORE DERIVAZIONE CAN | JUNCTION CONNECTOR CAN | CONNECTEUR | VERBINDER | CONECTOR |
| 26 1730720088 | 1 NR | ISOLATORE CONNESSIONE MASSA | INSULATOR EARTH CONNECTION | ISOLATEUR | ISOLATOR | AISLADOR |
| 27 27193300 | 1 NR | CARICA BATTERIA 110-120V | BATTERY CHARGER 110-120V | CHARGE BATTERIE 110-120V | BATTERIELADER 110-120V | CARGA BATERÍAS 110-120V |
| 32 1757250009 | 1 NR | CONNETTORE PORTA FEMMINE 4 VIE MOLEX 220-110V 20-25A | CONNECTOR | CONNECTEUR | VERBINDER | CONECTOR |
| 33 1757250011 | 1 NR | PUNTALINO | FERRULE | EMBOUT | ZWINGE | PUNTERA |
| 34 1757250010 | 1 NR | CONNETTORE PORTA MASCHI 4 VIE MOLEX 220-110V 20-25A | CONNECTOR | CONNECTEUR | VERBINDER | CONECTOR |





 COMPONENTI IMPIANTO ELETTRICO LITIO

KOMPONENTEN ELEKTROANLAGE LITHIUM 

 ELECTRICAL SYSTEM COMPONENTS LITHIUM

COMPONENTES INSTALACIÓN ELÉCTRICA LITHIUM 

 COMPOSANTS INSTALLATION ÉLECTRIQUE LITHIUM

| POS Codice | Q.tà |  Descrizione |  Description |  Designation |  Benennung |  Descripcìon |
|---------------|------|---|---|---|---|---|
| 35 1757250013 | 1 NR | PUNTALINO MASCHIO PER CONNETTORE 4 VIE MOLEX 220-110V 20-25A | FERRULE | EMBOUT | ZWINGE | PUNTERA |
| 36 1757250012 | 1 NR | TAPPO PER CHIUSURA FORI SU CONNETTORE 4 VIE MOLEX 220-110V 20-25A | CAP | BOUCHON | DECKEL | TAPA |

Go to Discount-Equipment.com to order your parts

 TELECOMANDO

FERNSTEUERUNG 

 REMOTE CONTROL

TELECOMANDO 



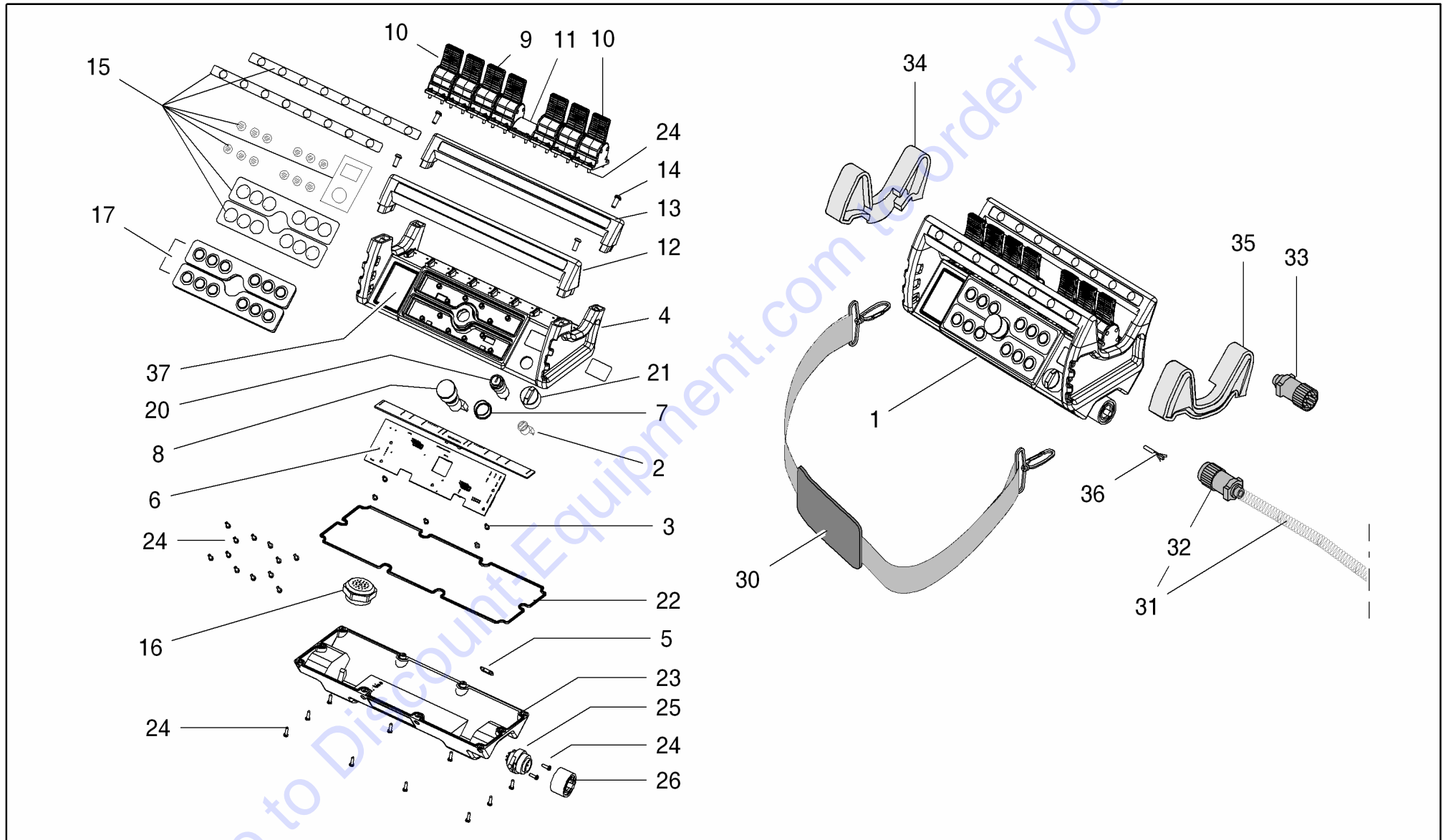

 TÉLÉCOMMANDE



 TELECOMANDO

 FERNSTEUERUNG 
 REMOTE CONTROL

 TELECOMANDO 
 TÉLÉCOMMANDE





| POS Codice | Q.tà |  Descrizione |  Description |  Designation |  Benennung |  Descripcìon |
|--------------|------|---|---|---|---|---|
| 1 27237400 | 1 NR | TELECOMANDO CASE GRIGIO | REMOTE CONTROL GREY CASE | TÉLÉCOMMANDE | FERNSTEUERUN G | TELECOMANDO |
| 2 07359400 | 1 NR | CONTATTO PER STOP EMERGENZA TELECOMANDO 3S | CONTACT FOR EMERGENCY STOP REMOTE CONTROL 3S | CONTACTE POUR ARRET D'URGENCE | KONTAKT FÜR NOTSTOP | CONTACTO PARA PARADA DE EMERGENCIA |
| 3 2646170003 | 5 NR | VITI SCHEDA ELETTRONICA | ELECTRONIC BOARD SCREWS | VIS | SCHRAUBEN | TORNILLOS |

Go to Discount-Equipment.com to order your parts

 TELECOMANDO

 FERNSTEUERUNG 
 REMOTE CONTROL





 TELECOMANDO 
 TÉLÉCOMMANDE

| POS Codice | Q.tà |  Descrizione |  Description |  Designation |  Benennung |  Descripción |
|--------------|------|--|--|---|---|---|
| 4 2723740001 | 1 NR | COPERCHIO SUPERIORE TELECOMANDO CASE GRIGIO + DISPLAY E PULSANTI (PER RICAMBIO È NECESSARIO IL SN DEL TELECOMANDO) | TOP COVER REMOTE CONTROL CASE GREY + DISPLAY AND BUTTONS (AS SPARE IS COMPULSORY THE SN OF REMOTE CONTROL) | COUVERCLE | DECKEL | TAPA |
| 4 2723740002 | 1 NR | COPERCHIO SUPERIORE TELECOMANDO CASE GRIGIO SOLO COPERCHIO, SENZA COMPONENTI E SENZA DISPLAY | TOP COVER REMOTE CONTROL CASE GREY ONLY CASE, WITHOUT COMPONENTS AND DISPLAY | COUVERCLE | DECKEL | TAPA |
| 5 07359500 | 1 NR | CONTATTO REED INTERNO TELECOMANDO 3S | REED CONTACT INTERNAL REMOTE 3S | REED CONTACT INTÉRIEUR 3S DISTANCE | REEDKONTAKT INDOOR REMOTE 3S | CONTACTO REED 3S REMOTO DE INTERIOR |
| 6 2646170002 | 1 NR | SCHEDA ELETTRONICA PER TELECOMANDO | ELECTRONIC BOARD FOR REMOTE CONTROL | FICHE ÉLECTRIQUE | ELEKTRONISCHE PLATINE | PLACA ELECTRÓNICA |
| 7 2646170007 | 1 NR | ANELLO | RING | BAGUE | RING | ANILLO |

 TELECOMANDO

 FERNSTEUERUNG 
 REMOTE CONTROL





 TELECOMANDO 
 TÉLÉCOMMANDE

| POS Codice | Q.tà |  Descrizione |  Description |  Designation |  Benennung |  Descripción |
|---------------|------|---|---|---|---|---|
| 8 2646170008 | 1 NR | PULSANTE EMERGENZA | EMERGENCY BUTTON | BOUTON D'URGENCE | NOTSTOP KNOPF | PULSADOR DE EMERGENCIA |
| 9 17550700 | 1 NR | KIT PROTEZIONE IN GOMMA PER JOYSTICK NERA | PROTECTION KIT | PROTECTION KIT | GUMMISCHUTZ KIT | PROTECCIÓN DE GOMA |
| 9 2646170009 | 6 NR | LEVA NERA | LEVER BLACK | LEVIER | HEBEL | PALANCA |
| 10 17550800 | 1 NR | KIT PROTEZIONE IN GOMMA PER JOYSTICK ROSSA | PROTECTION | PROTECTION | GUMMISCHUTZ | PROTECCION DE GOMA |
| 10 2646170010 | 2 NR | LEVA ROSSA | LEVER RED | LEVIER | HEBEL | PALANCA |
| 12 2646170013 | 1 NR | IMPUGNATURA INFERIORE | GRIP LOWER PART | POIGNÉE | GRIFF | EMPUÑADURA |
| 13 2646170012 | 1 NR | IMPUGNATURA SUPERIORE | GRIP UPPER PART | POIGNÉE | GRIFF | EMPUÑADURA |
| 14 2646170014 | 4 NR | VITE | SCREW | VIS | SCHRAUBE | TORNILLO |
| 15 27005200 | 1 NR | KIT ADESIVI | DECALS KIT | KIT AUTOCOLLANTS | KLEBERSATZ | KIT PEGATINAS |
| 16 2646170027 | 1 NR | CICALINO COMPLETO DI SCHEDA ELETTRONICA TELECOMANDO | BEEPER FOR REMOTE CONTROL | BUZZER | SUMMER | ZUMBADOR COMPLETO DE TARJETA ELECTRÓNICA TELEMANDO |
| 17 2646170017 | 1 NR | PULSANTI | BUTTONS | BOUTONS | DRUCKKNÖPFE | BOTONES |

 TELECOMANDO

 FERNSTEUERUNG 
 REMOTE CONTROL

 TELECOMANDO 
 TÉLÉCOMMANDE

| POS Codice | Q.tà |  Descrizione |  Description |  Designation |  Benennung |  Descripció |
|---------------|-------|---|---|---|---|--|
| 20 2683930001 | 1 NR | INTERRUTTORE | SWITCH | INTERRUPTEUR | SCHALTER | INTERRUPTOR |
| 21 2683930002 | 1 NR | CHIAVE ACCENSIONE | IGNITION KEY | CLÉ DE DÉMARRAGE | ZÜNDSCHLÜSSE L | LLAVE DE ENCENDIDO |
| 22 2646170022 | 1 NR | GUARNIZIONE | GASKET | JOINT | DICHTUNG | GUARNICIÓN |
| 23 2646170023 | 1 NR | COPERCHIO INFERIORE | COVER LOWER PART | COUVERCLE | DECKEL | TAPA |
| 24 2646170024 | 56 NR | VITE | SCREW | VIS | SCHRAUBE | TORNILLO |
| 25 2646170025 | 1 NR | CONNETTORE | CONNECTOR | CONNECTEUR | VERBINGER | CONECTOR |
| 26 2646170026 | 1 NR | COPERCHIO CONNETTORE | COVER CONNECTOR | COUVERCLE | DECKEL | TAPA |
| 30 2646170030 | 1 NR | CINGHIA | BELT | COURROIE | RIEMEN | CORREA |
| 31 17235800 | 1 NR | CAVO TELECOMANDO COMPLETO IIIS /200 | COMPLETE REMOTE CONTROL CABLE IIIS /200 | CÂBLE COMPLET TÉLÉCOMMANDE IIIS /200 | FERNBEDIENUNG SKABEL KOMPLETT IIIS /200 | CABLE TELECOMANDO COMPLETO IIIS /200 |
| 32 2646170032 | 1 NR | CONNETTORE COLLEGAMENTO TELECOMANDO | CONNECTOR FOR REMOTE CONTROL | CONNECTEUR | VERBINGER | CONECTOR |
| 33 1684540001 | 1 NR | DISPOSITIVO DI COMANDO PER ABILITAZIONE EMERGENZA A TERRA | CONTROL DEVICE FOR ACTIVATING THE EMERGENCY GROUND | DISPOSITIF DE COMMANDE EN CAS D'URGENCE | STEUERVORRICH TUNG IM NOTFALL | DISPOSITIVO DE CONTROL DE EMERGENCIA |





 TELECOMANDO

 FERNSTEUERUNG

 REMOTE CONTROL

 TELECOMANDO

 TÉLÉCOMMANDE

| POS Codice | Q.tà |  Descrizione |  Description |  Designation |  Benennung |  Descripcìon |
|---------------|------|---|---|---|---|---|
| 34 07027200 | 1 NR | PROTEZIONE SINISTRA | LEFT PROTECTION | PROTECTION GAUCHE | ABDECKUNG LINKS | PROTECCIÓN IZQUIERDA |
| 35 07027100 | 1 NR | PROTEZIONE DESTRA | RIGHT PROTECTION | PROTECTION DROITS | ABDECKUNG RECHTS | PROTECCIÓN DERECHA |
| 36 27283000 | 1 NR | PUNTALINO FEMMINA PER CONNETTORE TELECOMANDO | TERMINAL FEMALE CONNECTOR FOR REMOTE CONTROL | CONNECTEUR FEMELLE | VERBINDUNG | CONECTOR |
| 36 2728300001 | 1 NR | PUNTALINO MASCHIO PER CONNETTORE TELECOMANDO | TERMINAL MALE CONNECTOR FOR REMOTE CONTROL | CONNECTEUR | VERBINDER | CONECTOR |
| 37 07320200 | 1 NR | SCHERMO LCD (PER RICAMBIO È NECESSARIO IL SN DEL TELECOMANDO) | DISPLAY (AS SPARE IS COMPULSORY THE SN OF REMOTE CONTROL) | ÉCRAN | DISPLAY | PANTALLA |

 IMPIANTO ELETTRICO

ELEKTRISCHE ANLAGE 

 ELECTRICAL SYSTEM

INSTALACIÓN ELÉCTRICA 

 INSTALLATION ÉLECTRIQUE

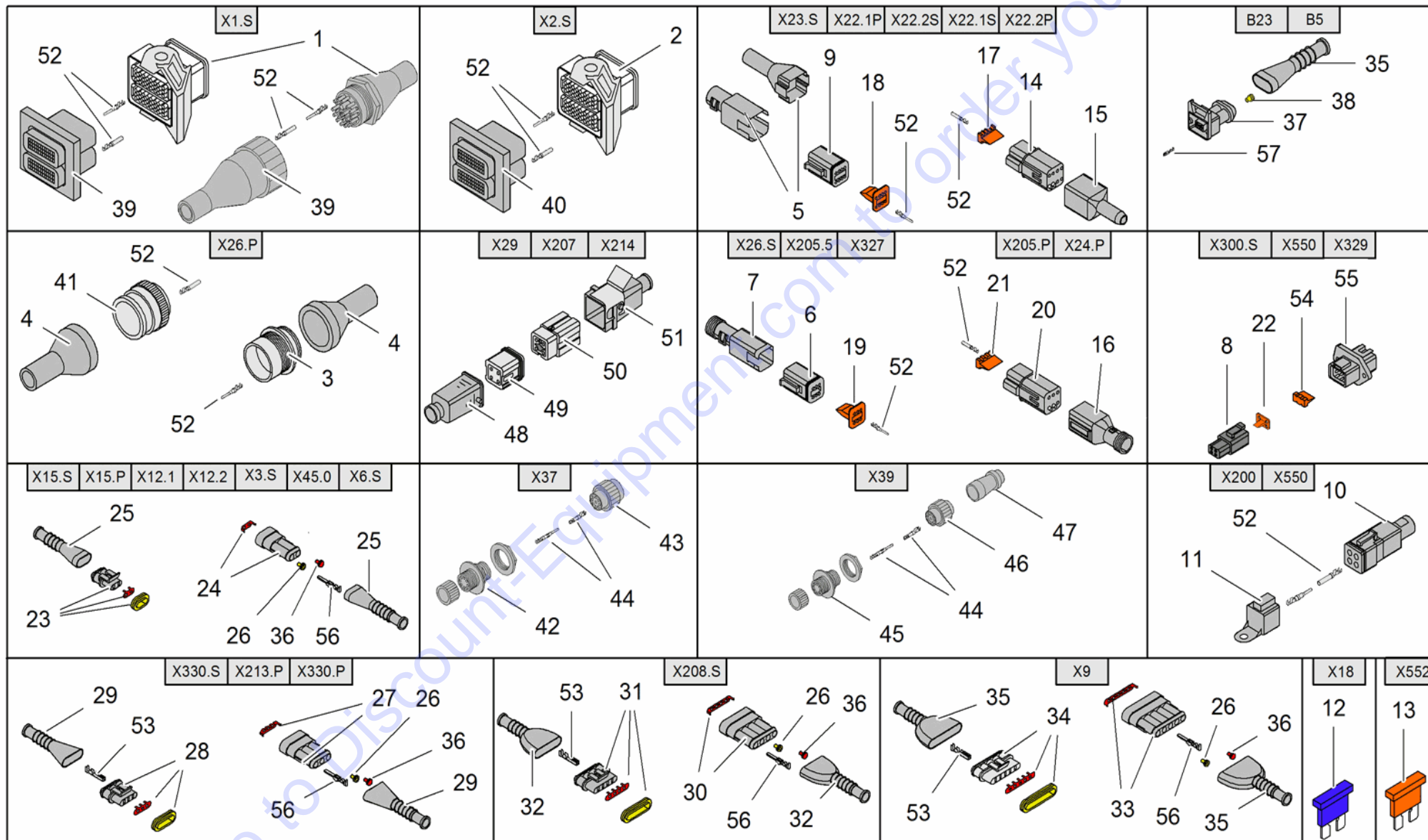





 IMPIANTO ELETTRICO

 ELEKTRISCHE ANLAGE





 ELECTRICAL SYSTEM

 INSTALACIÓN ELÉCTRICA





 INSTALLATION ÉLECTRIQUE

| POS Codice | Q.tà |  Descrizione |  Description |  Designation |  Benennung |  Descripción |
|--------------|------|---|---|---|---|---|
| 1 1730720066 | 1 | NR | | | | |
| 1 1764250004 | 1 | NR CONNETTORE ROTONDO 47VIE PM (X1) MK2 (DA C170000893) | CONNECTOR WAY ROUND PM (X1) MK2 (FROM C170000893) | CONNECTEUR MK2 (FROM C170000893) | VERBINDER MK2 (FROM C170000893) | CONECTADOR MK2 (FROM C170000893) |
| 2 1730720067 | 1 | NR CONNETTORE 64VIE PM (X2) POLAR "A" | CONNECTOR | CONNECTEUR | VERBINDER | CONECTADOR |
| 3 1730720051 | 1 | NR CONNETTORE 29 VIE M MOTORE (X26) | CONNECTOR | CONNECTEUR | VERBINDER | CONECTOR |
| 4 1730720054 | 2 | NR CAPPuccio POSTERIORE | CAP | CAPUCHON | KAPPE | CAPUCHO |
| 4 1730720054 | 1 | NR CAPPuccio POSTERIORE | CAP | CAPUCHON | KAPPE | CAPUCHO |
| 5 1730720035 | 1 | NR COVER POSTERIORE RIGIDA PER CONNETTORE 8 VIE MASCHIO | PROTECTION | PROTECTION | SCHUTZ | PROTECCION |
| 5 1757250025 | 1 | NR CAPPuccio POSTERIORE PER CONNETTORE MASCHIO | CAP | CAPUCHON | KAPPE | TAPA |





 IMPIANTO ELETTRICO
ELEKTRISCHE ANLAGE 
 ELECTRICAL SYSTEM
INSTALACIÓN ELÉCTRICA 
 INSTALLATION ÉLECTRIQUE

| POS Codice | Q.tà |  Descrizione |  Description |  Designation |  Benennung |  Descripción |
|---------------|------|---|---|---|---|---|
| 6 1730720037 | 1 NR | CONNETTORE 6 VIE MASCHIO | 6-WAY MALE CONNECTOR | CONNECTEUR 6 VOIES MÂLE | 6-WEGE-VERBIN DER | CONECTOR 6 VÍAS |
| 7 1730720039 | 1 NR | COVER POSTERIORE RIGIDA PER CONNETTORE 6 VIE MASCHIO | PROTECTION | PROTECTION | SCHUTZ | PROTECCION |
| 8 1757250028 | 1 NR | CONNETTORE 4 VIE MASCHIO DEUTSCH PF POTENZA 25A | 4-WAY MALE CONNECTOR 25A | CONNECTEUR 4 VOIES MÂLE 25A | 4-WEGE-VERBIN DER STIFT 25A | CONECTOR 4 VÍAS MACHO 25A |
| 9 1730720033 | 1 NR | CONNETTORE 8 VIE MASCHIO | 8-WAY MALE CONNECTOR | CONNECTEUR 8 VOIES MÂLE | 8-WEGE-VERBIN DER STIFT | CONECTOR 8 VÍAS MACHO |
| 10 1763330001 | 1 NR | CONNETTORE 4 VIE MASCHIO DEUTSCH | 4-WAY MALE CONNECTOR DEUTSCH | CONNECTEUR 4 VOIES MÂLE DEUTSCH | 4-WEGE-VERBIN DER STIFT DEUTSCH | CONECTOR 4 VÍAS MACHO DEUTSCH |
| 11 1763330002 | 1 NR | CAPPUCCIO FRONTALE CONNETTORE 4 VIE MASCHIO DEUTSCH | CAP FOR 4-WAY MALE CONNECTOR DEUTSCH | PAC CONNECTEUR 4 VOIES MÂLE DEUTSCH | CAP 4-WEGE-VERBIN DER STIFT DEUTSCH | CAP CONECTOR 4 VÍAS MACHO DEUTSCH |
| 12 07700700 | 1 NR | FUSIBILE A LAMA 25A | FUSE 25A | FUSIBLE 25A | SICHERUNG 25A | FUSIBLE 25A |
| 13 05760700 | 1 NR | FUSIBILE A LAMA 5A | FUSE 5A | FUSIBLE 5A | SICHERUNG 5A | FUSIBLE 5A |





 IMPIANTO ELETTRICO
ELEKTRISCHE ANLAGE 
 ELECTRICAL SYSTEM
INSTALACIÓN ELÉCTRICA 
 INSTALLATION ÉLECTRIQUE

| POS Codice | Q.tà |  Descrizione |  Description |  Designation |  Benennung |  Descripción |
|---------------|------|---|---|---|---|---|
| 14 1730720029 | 1 NR | CONNETTORE 8 VIE FEMMINA | 8-WAY FEMALE CONNECTOR | CONNECTEUR 8 VOIES FEMELLE | 8-WEGE-VERBIN DER BÜCHSE | CONECTOR 8 VÍAS HEMBRA |
| 15 1730720031 | 1 NR | COVER POSTERIORE RIGIDA PER CONNETTORE 8 VIE FEMMINA | PROTECTION | PROTECTION | SCHUTZ | PROTECCION |
| 15 1757250026 | 1 NR | CAPPUCCIO POSTERIORE PER CONNETTORE FEMMINA | CAP | CAPUCHON | KAPPE | TAPA |
| 16 1730720084 | 1 NR | COVER POSTERIORE RIGIDA PER CONNETTORE 6 VIE FEMMINA | PROTECTION | PROTECTION | SCHUTZ | PROTECCION |
| 16 1757250027 | 1 NR | CAPPUCCIO POSTERIORE PER CONNETTORE 6 VIE FEMMINA | CAP | CAPUCHON | KAPPE | TAPA |
| 17 1730720030 | 1 NR | PIASTRINA DI BLOCCAGGIO CONNETTORE 8 VIE FEMMINA | PLATE | PLAQUE | PLATTE | PLACA |





 IMPIANTO ELETTRICO
ELEKTRISCHE ANLAGE 
 ELECTRICAL SYSTEM
INSTALACIÓN ELÉCTRICA 
 INSTALLATION ÉLECTRIQUE

| POS Codice | Q.tà |  Descrizione |  Description |  Designation |  Benennung |  Descripción |
|---------------|------|---|---|---|---|---|
| 18 1730720034 | 1 NR | PIASTRINA DI BLOCCAGGIO CONNETTORE 8 VIE MASCHIO | PLATE | PLAQUE | PLATTE | PLACA |
| 19 1730720038 | 1 NR | PIASTRINA DI BLOCCAGGIO CONNETTORE 6 VIE MASCHIO | PLATE | PLAQUE | PLATTE | PLACA |
| 20 1730720041 | 1 NR | CONNETTORE 6 VIE FEMMINA | 6-WAY FEMALE CONNECTOR | CONNECTEUR 6 VOIES FEMELLE | 6-WEGE-VERBIN DER BUCHSE | CONNECTOR 6 VÍAS HEMBRA |
| 21 1730720042 | 1 NR | PIASTRA BLOCCAGGIO CONNETTORE 6 VIE FEMMINA | CONNECTOR | CONNECTEUR | VERBINDER | CONNECTADOR |
| 22 1757250029 | 1 NR | PIASTRINA DI BLOCCAGGIO CONNETTORE 4 VIE M POTENZA 25A | PLATE | PLAQUE | PLATTE | PLACA |
| 23 1757250031 | 1 NR | CONNETTORE SUPERSEAL PF 2 VIE | CONNECTOR | CONNECTEUR | VERBINDER | CONNECTADOR |
| 24 1757250032 | 1 NR | CONNETTORE SUPERSEAL PM 2 VIE | CONNECTOR | CONNECTEUR | VERBINDER | CONNECTADOR |

 IMPIANTO ELETTRICO
ELEKTRISCHE ANLAGE 
 ELECTRICAL SYSTEM
INSTALACIÓN ELÉCTRICA 
 INSTALLATION ÉLECTRIQUE

| POS Codice | Q.tà |  Descrizione |  Description |  Designation |  Benennung |  Descripción |
|---------------|------|---|---|---|---|---|
| 25 1757250033 | 1 NR | CAPPUCCIO POSTERIOERE CONNETTORE SUPERSEAL 2 VIE | CAP | CAPUCHON | KAPPE | CAPUCHO |
| 26 1757250043 | 1 NR | GOMMINO TENUTA PER CAVI CONNETTORI SUPERSEAL | RUBBER SEAL | JOINT EN CAOUTCHOUC | GUMMIDICHTUNG | JUNTA DE GOMA |
| 27 1757250035 | 1 NR | CONNETTORE SUPERSEAL PM 3 VIE | CONNECTOR | CONNECTEUR | VERBINDER | CONECTADOR |
| 28 1757250034 | 1 NR | CONNETTORE SUPERSEAL PF 3 VIE | CONNECTOR | CONNECTEUR | VERBINDER | CONECTADOR |
| 29 1757250036 | 1 NR | CAPPUCCIO POSTERIOERE CONNETTORE SUPERSEAL 3 VIE | CAP | CAPUCHON | KAPPE | CAPUCHO |
| 30 1757250038 | 1 NR | CONNETTORE SUPERSEAL PM 4 VIE | CONNECTOR | CONNECTEUR | VERBINDER | CONECTADOR |
| 31 1757250037 | 1 NR | CONNETTORE SUPERSEAL PF 4 VIE | CONNECTOR | CONNECTEUR | VERBINDER | CONECTADOR |

 IMPIANTO ELETTRICO
ELEKTRISCHE ANLAGE 
 ELECTRICAL SYSTEM
INSTALACIÓN ELÉCTRICA 
 INSTALLATION ÉLECTRIQUE

| POS Codice | Q.tà |  Descrizione |  Description |  Designation |  Benennung |  Descripción |
|---------------|------|---|---|---|---|---|
| 32 1757250039 | 1 NR | CAPPUCCIO POSTERIORE CONNETTORE SUPERSEAL 4 VIE | CAP | CAPUCHON | KAPPE | CAPUCHO |
| 33 1757250041 | 1 NR | CONNETTORE SUPERSEAL PM 5 VIE | CONNECTOR | CONNECTEUR | VERBINDER | CONECTADOR |
| 34 1757250040 | 1 NR | CONNETTORE SUPERSEAL PF 5 VIE | CONNECTOR | CONNECTEUR | VERBINDER | CONECTADOR |
| 35 1757250042 | 1 NR | CAPPUCCIO POSTERIOERE CONNETTORE SUPERSEAL 5-6 VIE | CAP | CAPUCHON | KAPPE | CAPUCHO |
| 36 1757250046 | 1 NR | GOMMINO TENUTA TAPPO PER CONNETTORI SUPERSEAL | RUBBER SEAL | JOINT EN CAOUTCHOUC | GUMMIDICHTUNG | JUNTA DE GOMA |
| 37 1757250044 | 1 NR | CONNETTORE JPT 2 VIE PER ELETTROVALVOL E | CONNECTOR | CONNECTEUR | VERBINDER | CONECTADOR |





 IMPIANTO ELETTRICO

 ELEKTRISCHE ANLAGE





 ELECTRICAL SYSTEM

 INSTALACIÓN ELÉCTRICA





 INSTALLATION ÉLECTRIQUE

| POS Codice | Q.tà |  Descrizione |  Description |  Designation |  Benennung |  Descripción |
|---------------|------|---|---|---|---|---|
| 38 1757250045 | 1 NR | GOMMINO TENUTA PER CAVI CONNETTORI JPT | RUBBER SEAL | JOINT EN CAOUTCHOUC | GUMMIDICHTUNG | JUNTA DE GOMA |
| 39 1730720064 | 1 NR | CONNETTORE 50VIE PF (X1) | CONNECTOR 50 WAY PF (X1) | | | |
| 39 1764250006 | 1 NR | CONNETTORE ROTONDO 47VIE PF (X1) MK2 (DA C170000893) | CONNECTOR 47 WAY ROUND PF (X1) MK2 (FROM C170000893) | CONNECTEUR MK2 (FROM C170000893) | VERBINDER MK2 (FROM C170000893) | CONECTADOR MK2 (FROM C170000893) |
| 40 1730720065 | 1 NR | CONNETTORE 64VIE PF (X2) POLAR A | CONNECTOR | CONNECTEUR | VERBINDER | CONECTADOR |
| 41 1730720059 | 1 NR | CONNETTORE 29 VIE F MOTORE (X26) | CONNECTOR | CONNECTEUR | VERBINDER | CONECTADOR |
| 42 1730720019 | 1 NR | CONNETTORE 19 VIE F SCATOLA CELLA (X37) | CONNECTOR 19 WAY FEMALE CELL BOX (X 37) | | | |
| 43 1730720020 | 1 NR | CONNETTORE 19 VIE M SCATOLA CELLA (X37) | CONNECTOR 19 WAY MALE CELL BOX (X 37) | | | |

 IMPIANTO ELETTRICO
ELEKTRISCHE ANLAGE 
 ELECTRICAL SYSTEM
INSTALACIÓN ELÉCTRICA 
 INSTALLATION ÉLECTRIQUE

| POS Codice | Q.tà |  Descrizione |  Description |  Designation |  Benennung |  Descripcìon |
|---------------|-------|---|---|---|---|---|
| 44 1730720022 | 1 NR | TERMINALE MASCHIO 16A (X37) | TERMINAL MALE 16A (X37) | MALE TERMINAL | TERMINAL MALE | MALE TERMINAL |
| 44 1730720022 | 19 NR | TERMINALE MASCHIO 16A (X37) | TERMINAL MALE 16A (X37) | MALE TERMINAL | TERMINAL MALE | MALE TERMINAL |
| 44 1730720023 | 1 NR | TERMINALE FEMMINA 16A (X37) | TERMINAL FEMALE 16A (X37) | BORNE FEMELLE | TERMINAL FEMALE | TERMINAL HEMBRA |
| 44 1730720023 | 19 NR | TERMINALE FEMMINA 16A (X37) | TERMINAL FEMALE 16A (X37) | BORNE FEMELLE | TERMINAL FEMALE | TERMINAL HEMBRA |
| 44 1730720025 | 7 NR | TERMINALE F 0,25-0,50 MMQ (X39) | TERMINAL F 0.25-0.50 MMQ (X39) | TERMINAL | TERMINAL | TERMINAL |
| 44 1730720025 | 15 NR | TERMINALE F 0,25-0,50 MMQ (X39) | TERMINAL F 0.25-0.50 MMQ (X39) | TERMINAL | TERMINAL | TERMINAL |
| 44 1730720025 | 1 NR | TERMINALE F 0,25-0,50 MMQ (X39) | TERMINAL F 0.25-0.50 MMQ (X39) | TERMINAL | TERMINAL | TERMINAL |
| 44 1730720027 | 10 NR | TERMINALE M 0,25-0,50 MMQ (X39) | TERMINAL M 0.25-0.50 MMQ (X39) | TERMINAL | TERMINAL | TERMINAL |

 IMPIANTO ELETTRICO
ELEKTRISCHE ANLAGE 
 ELECTRICAL SYSTEM
INSTALACIÓN ELÉCTRICA 
 INSTALLATION ÉLECTRIQUE

| POS Codice | Q.tà |  Descrizione |  Description |  Designation |  Benennung |  Descripción |
|---------------|-------|---|---|---|---|---|
| 44 1730720027 | 1 NR | TERMINALE M 0,25-0,50 MMQ (X39) | TERMINAL M 0.25-0.50 MMQ (X39) | TERMINAL | TERMINAL | TERMINAL |
| 44 1730720027 | 15 NR | TERMINALE M 0,25-0,50 MMQ (X39) | TERMINAL M 0.25-0.50 MMQ (X39) | TERMINAL | TERMINAL | TERMINAL |
| 44 1730720027 | 7 NR | TERMINALE M 0,25-0,50 MMQ (X39) | TERMINAL M 0.25-0.50 MMQ (X39) | TERMINAL | TERMINAL | TERMINAL |
| 45 1730720024 | 1 NR | CONNETTORE 12 VIE F SCATOLA CELLA | CONNECTOR 12 WAY FEMALE CELL BOX | | | |
| 46 1730720026 | 1 NR | CONNETTORE 12 VIE M SCATOLA CELLA (X39) | CONNECTOR 12 WAY MALE BOX CELL (X39) | | | |
| 47 1730720028 | 1 NR | FERMA CAVO CONNETTORE 12 VIE M SCATOLA CELLA (X39) | LOCK CABLE CONNECTOR 12 WAY MALE BOX CELL (X39) | | | |
| 48 1730720083 | 1 NR | CUSTODIA 3 POLI GRIGIA VOLANTE PER CONN.PM 4+1VIE 230/110V (X29) | HOUSING 3 POLE GREY FOR CONN. PM 4 + 1 WAY 230V / 110V (X29) | | | |
| 49 1730720082 | 1 NR | FRUTTO CONN.PM 4+1VIE 230/110V (X29) | CONNECTOR PM 4 + 1 WAY 230V / 110V (X 29) | | | |





 IMPIANTO ELETTRICO

 ELEKTRISCHE ANLAGE

 ELECTRICAL SYSTEM





 INSTALACIÓN ELÉCTRICA

 INSTALLATION ÉLECTRIQUE

| POS Codice | Q.tà |  Descrizione |  Description |  Designation |  Benennung |  Descripcìon |
|---------------|------|---|---|---|---|---|
| 50 1730720080 | 1 NR | FRUTTO CONN. PF 4+1 VIA 230/110V (X29) | CONNECTOR PF 4 + 1 WAY 230V / 110V (X 29) | | | |
| 51 1730720081 | 1 NR | CUSTODIA 3 POLI GRIGIA CON GANCIO PER CONN. PF 4+1 VIA 230/110V (X29) | HOUSING 3 POLE GREY WITH HOOK FOR CONN. PF 4 + 1 ROUTE 230 / 110V (X29) | | | |

Go to Discount-Equipment.com to order your parts

 IMPIANTO ELETTRICO
ELEKTRISCHE ANLAGE 
 ELECTRICAL SYSTEM
INSTALACIÓN ELÉCTRICA 
 INSTALLATION ÉLECTRIQUE

| POS Codice | Q.tà |  Descrizione |  Description |  Designation |  Benennung |  Descripción |
|---------------|-------|---|---|---|---|---|
| 52 1730720032 | 1 NR | TERMINALE MASCHIO CAVO 0.75-1.5 | TERMINAL MALE CABLE 0.75-1.5 | MALE TERMINAL | TERMINAL MALE | MALE TERMINAL |
| 52 1730720032 | 25 NR | TERMINALE MASCHIO CAVO 0.75-1.5 | TERMINAL MALE CABLE 0.75-1.5 | MALE TERMINAL | TERMINAL MALE | MALE TERMINAL |
| 52 1730720032 | 30 NR | TERMINALE MASCHIO CAVO 0.75-1.5 | TERMINAL MALE CABLE 0.75-1.5 | MALE TERMINAL | TERMINAL MALE | MALE TERMINAL |
| 52 1730720032 | 10 NR | TERMINALE MASCHIO CAVO 0.75-1.5 | TERMINAL MALE CABLE 0.75-1.5 | MALE TERMINAL | TERMINAL MALE | MALE TERMINAL |
| 52 1730720036 | 15 NR | TERMINALE FEMMINA CONNETTORE M CAVO 0.5-1 | TERMINAL FEMALE MALE CONNECTOR CABLE 0.5-1 | BORNE FEMELLE | TERMINAL FEMALE | TERMINAL HEMBRA |
| 52 1730720036 | 1 NR | TERMINALE FEMMINA CONNETTORE M CAVO 0.5-1 | TERMINAL FEMALE MALE CONNECTOR CABLE 0.5-1 | BORNE FEMELLE | TERMINAL FEMALE | TERMINAL HEMBRA |
| 52 1730720036 | 30 NR | TERMINALE FEMMINA CONNETTORE M CAVO 0.5-1 | TERMINAL FEMALE MALE CONNECTOR CABLE 0.5-1 | BORNE FEMELLE | TERMINAL FEMALE | TERMINAL HEMBRA |

 IMPIANTO ELETTRICO
ELEKTRISCHE ANLAGE 
 ELECTRICAL SYSTEM
INSTALACIÓN ELÉCTRICA 
 INSTALLATION ÉLECTRIQUE

| POS Codice | Q.tà |  Descrizione |  Description |  Designation |  Benennung |  Descripción |
|---------------|-------|---|---|---|---|---|
| 52 1730720036 | 10 NR | TERMINALE FEMMINA CONNETTORE M CAVO 0.5-1 | TERMINAL FEMALE MALE CONNECTOR CABLE 0.5-1 | BORNE FEMELLE | TERMINAL FEMALE | TERMINAL HEMBRA |
| 52 1730720036 | 4 NR | TERMINALE FEMMINA CONNETTORE M CAVO 0.5-1 | TERMINAL FEMALE MALE CONNECTOR CABLE 0.5-1 | BORNE FEMELLE | TERMINAL FEMALE | TERMINAL HEMBRA |
| 52 1730720040 | 2 NR | TERMINALE FEMMINA (X24) | TERMINAL FEMALE (X24) | BORNE FEMELLE (X24) | TERMINAL FEMALE (X24) | TERMINAL HEMBRA (X24) |
| 52 1730720040 | 10 NR | TERMINALE FEMMINA (X24) | TERMINAL FEMALE (X24) | BORNE FEMELLE (X24) | TERMINAL FEMALE (X24) | TERMINAL HEMBRA (X24) |
| 52 1730720040 | 1 NR | TERMINALE FEMMINA (X24) | TERMINAL FEMALE (X24) | BORNE FEMELLE (X24) | TERMINAL FEMALE (X24) | TERMINAL HEMBRA (X24) |
| 52 1730720040 | 15 NR | TERMINALE FEMMINA (X24) | TERMINAL FEMALE (X24) | BORNE FEMELLE (X24) | TERMINAL FEMALE (X24) | TERMINAL HEMBRA (X24) |
| 52 1730720043 | 15 NR | TERMINALE MASCHIO (X24) DA 0.5 A 0.75 | TERMINAL MALE (X24) DA 0.5 A 0.75 | BORNE MALE (X24) | TERMINAL MALE (X24) | TERMINAL MACHO (X24) |
| 52 1730720043 | 1 NR | TERMINALE MASCHIO (X24) DA 0.5 A 0.75 | TERMINAL MALE (X24) DA 0.5 A 0.75 | BORNE MALE (X24) | TERMINAL MALE (X24) | TERMINAL MACHO (X24) |
| 52 1730720043 | 10 NR | TERMINALE MASCHIO (X24) DA 0.5 A 0.75 | TERMINAL MALE (X24) DA 0.5 A 0.75 | BORNE MALE (X24) | TERMINAL MALE (X24) | TERMINAL MACHO (X24) |





 IMPIANTO ELETTRICO

 ELEKTRISCHE ANLAGE





 ELECTRICAL SYSTEM

 INSTALACIÓN ELÉCTRICA





 INSTALLATION ÉLECTRIQUE

| POS Codice | Q.tà |  Descrizione |  Description |  Designation |  Benennung |  Descripción |
|---------------|-------|---|---|---|---|---|
| 52 1730720055 | 10 NR | CONTATTO MASCHIO 25A CAVO 2.5-4 | CONTACT MALE 25A CABLE 2.5-4 | CONTACT MALE 25A | CONTACT MALE 25A | CONTACT MALE 25A |
| 52 1730720055 | 1 NR | CONTATTO MASCHIO 25A CAVO 2.5-4 | CONTACT MALE 25A CABLE 2.5-4 | CONTACT MALE 25A | CONTACT MALE 25A | CONTACT MALE 25A |
| 52 1730720055 | 5 NR | CONTATTO MASCHIO 25A CAVO 2.5-4 | CONTACT MALE 25A CABLE 2.5-4 | CONTACT MALE 25A | CONTACT MALE 25A | CONTACT MALE 25A |
| 52 1730720056 | 5 NR | TAPPO SIZE 12-16 (X26) | CAP SIZE 12-16 (X26) | CAP TAILLE 12-16 (X26) | CAP SIZE 12-16 (X26) | CAP TAMAÑO 12-16 (X26) |
| 52 1730720056 | 1 NR | TAPPO SIZE 12-16 (X26) | CAP SIZE 12-16 (X26) | CAP TAILLE 12-16 (X26) | CAP SIZE 12-16 (X26) | CAP TAMAÑO 12-16 (X26) |
| 52 1730720056 | 10 NR | TAPPO SIZE 12-16 (X26) | CAP SIZE 12-16 (X26) | CAP TAILLE 12-16 (X26) | CAP SIZE 12-16 (X26) | CAP TAMAÑO 12-16 (X26) |
| 52 1730720057 | 10 NR | TAPPO SIZE 16 (X26) | CAP SIZE 16 (X26) | PLUG SIZE 16 (X26) | PLUG SIZE 16 (X26) | MACHO TALLA 16 (X26) |
| 52 1730720057 | 20 NR | TAPPO SIZE 16 (X26) | CAP SIZE 16 (X26) | PLUG SIZE 16 (X26) | PLUG SIZE 16 (X26) | MACHO TALLA 16 (X26) |
| 52 1730720057 | 1 NR | TAPPO SIZE 16 (X26) | CAP SIZE 16 (X26) | PLUG SIZE 16 (X26) | PLUG SIZE 16 (X26) | MACHO TALLA 16 (X26) |
| 52 1730720058 | 1 NR | CONTATTO MASCHIO 7.5A (X26) | CONTACT PIN 7.5A (X26) | CONTACT PIN 7.5A (X26) | CONTACT PIN 7.5A (X26) | CONTACT 7.5A (X26) |

 IMPIANTO ELETTRICO
ELEKTRISCHE ANLAGE 
 ELECTRICAL SYSTEM
INSTALACIÓN ELÉCTRICA 
 INSTALLATION ÉLECTRIQUE

| POS Codice | Q.tà |  Descrizione |  Description |  Designation |  Benennung |  Descripción |
|---------------|--------|---|---|---|---|---|
| 52 1730720058 | 100 NR | CONTATTO MASCHIO 7.5A (X26) | CONTACT PIN 7.5A (X26) | CONTACT PIN 7.5A (X26) | CONTACT PIN 7.5A (X26) | CONTACT 7.5A (X26) |
| 52 1730720058 | 15 NR | CONTATTO MASCHIO 7.5A (X26) | CONTACT PIN 7.5A (X26) | CONTACT PIN 7.5A (X26) | CONTACT PIN 7.5A (X26) | CONTACT 7.5A (X26) |
| 52 1730720061 | 1 NR | CONTATTO FEMMINA 7.5A (X26) | CONTACT FEMALE 7.5A (X26) | CONTACTER 7,5 FEMELLE (X26) | CONTACT FEMALE 7.5A (X26) | CONTACT 7.5A FEMENINO (X26) |
| 52 1730720061 | 10 NR | CONTATTO FEMMINA 7.5A (X26) | CONTACT FEMALE 7.5A (X26) | CONTACTER 7,5 FEMELLE (X26) | CONTACT FEMALE 7.5A (X26) | CONTACT 7.5A FEMENINO (X26) |
| 52 1730720061 | 100 NR | CONTATTO FEMMINA 7.5A (X26) | CONTACT FEMALE 7.5A (X26) | CONTACTER 7,5 FEMELLE (X26) | CONTACT FEMALE 7.5A (X26) | CONTACT 7.5A FEMENINO (X26) |
| 52 1730720068 | 5 NR | TAPPO SIZE 20 (X1) | CAP SIZE 20 (X1) | PLUG SIZE 20 (X1) | PLUG SIZE 20 (X1) | TAMAÑO DE ENCHUFE 20 (X1) |
| 52 1730720068 | 1 NR | TAPPO SIZE 20 (X1) | CAP SIZE 20 (X1) | PLUG SIZE 20 (X1) | PLUG SIZE 20 (X1) | TAMAÑO DE ENCHUFE 20 (X1) |
| 52 1730720069 | 10 NR | CONTATTO FEMMINA 25A CONNETTORE M CAVO 2.5-4 | CONTACT FEMALE 25A MALE CONNECTOR CABLE 2.5-4 | CONTACT FEMELLE 25A | KONTAKT BUCHSE 25A | CONTACT HEMBRA 25A |

 IMPIANTO ELETTRICO
ELEKTRISCHE ANLAGE 
 ELECTRICAL SYSTEM
INSTALACIÓN ELÉCTRICA 
 INSTALLATION ÉLECTRIQUE

| POS Codice | Q.tà |  Descrizione |  Description |  Designation |  Benennung |  Descripción |
|---------------|------|---|---|---|---|---|
| 52 1730720069 | 1 NR | CONTATTO FEMMINA 25A CONNETTORE M CAVO 2.5-4 | CONTACT FEMALE 25A MALE CONNECTOR CABLE 2.5-4 | CONTACT FEMELLE 25A | KONTAKT BUCHSE 25A | CONTACT HEMBRA 25A |
| 53 1757250048 | 1 NR | PUNTALINO FEMMINA PER SUPERSEAL | FERRULE FEMALE FOR SUPERSEAL | | | |
| 54 1757250030 | 1 NR | PIASTRINA DI BLOCCAGGIO CONNETTORE 4 VIE FEMMINA POTENZA 25A | PLATE | PLAQUE | PLATTE | PLACA |
| 55 1757250018 | 1 NR | CONNETTORE 4 VIE DEUTSCH A PARETE PM POTENZA 25A (X300) | CONNECTOR | CONNECTEUR | VERBINDER | CONECTADOR |
| 56 1757250049 | 1 NR | PUNTALINO MASCHIO PER SUPERSEAL | FERRULE MALE FOR SUPERSEAL | | | |
| 57 1739150047 | 1 NR | CONTATTO FEMMINA PER CONNETTORE JPT | CONTACT FEMALE FOR CONNECTOR JPT | CONTACT FEMELLE POUR CONNECTEUR JPT | KONTAKT BUCHSE FÜR JPT VERBINDER | CONTACTO HEMBRA PARA CONECTOR JPT |

PARTS FINDER

**Search Website
by Part Number**



**Search Manual
Library For Parts
Manual & Lookup Part
Numbers – Purchase
or Request Quote**

Search Manuals

Enter your information to search for a manual or to purchase a manual or parts.

* Brand:

* Model:

* Serial:

* Part Number:

SEARCH

**Can't Find Part or
Manual? Request Help
by Manufacturer,
Model & Description**

Parts Order Form

Please fill in the following information:

Manufacturer:

Model:

Description:

Quantity:

Part Number:

Part Name:

Part Description:

Part Category:

Part Location:

Part Status:

Part Condition:

Part Material:

Part Color:

Part Weight:

Part Dimensions:

Part Price:

Part Notes:

Submit

Discount-Equipment.com is your online resource for quality parts & equipment.

Florida: **561-964-4949** Outside Florida TOLL FREE: **877-690-3101**

Need parts?

Click on this link: <http://www.discount-equipment.com/category/5443-parts/> and choose one of the options to help get the right parts and equipment you are looking for. Please have the machine model and serial number available in order to help us get you the correct parts. If you don't find the part on the website or on one of the online manuals, please fill out the request form and one of our experienced staff members will get back to you with a quote for the right part that your machine needs.

We sell worldwide for the brands: Genie, Terex, JLG, MultiQuip, Mikasa, Essick, Whiteman, Mayco, Toro Stone, Diamond Products, Generac Magnum, Airman, Haulotte, Barreto, Power Blanket, Nifty Lift, Atlas Copco, Chicago Pneumatic, Allmand, Miller Curber, Skyjack, Lull, Skytrak, Tsurumi, Husquvarna Target, Stow, Wacker, Sakai, Mi-T-M, Sullair, Basic, Dynapac, MBW, Weber, Bartell, Bennar Newman, Haulotte, Ditch Runner, Menegotti, Morrison, Contec, Buddy, Crown, Edco, Wyco, Bomag, Laymor, EZ Trench, Bil-Jax, F.S. Curtis, Gehl Pavers, Heli, Honda, ICS/PowerGrit, IHI, Partner, Imer, Clipper, MMD, Koshin, Rice, CH&E, General Equipment, Amida, Coleman, NAC, Gradall, Square Shooter, Kent, Stanley, Tamco, Toku, Hatz, Kohler, Robin, Wisconsin, Northrock, Oztec, Toker TK, Rol-Air, APT, Wylie, Ingersoll Rand / Doosan, Innovatech, Con X, Ammann, Mecalac, Makinex, Smith Surface Prep, Small Line, Wanco, Yanmar

 IMPIANTO ELETTRICO

 ELECTRICAL SYSTEM



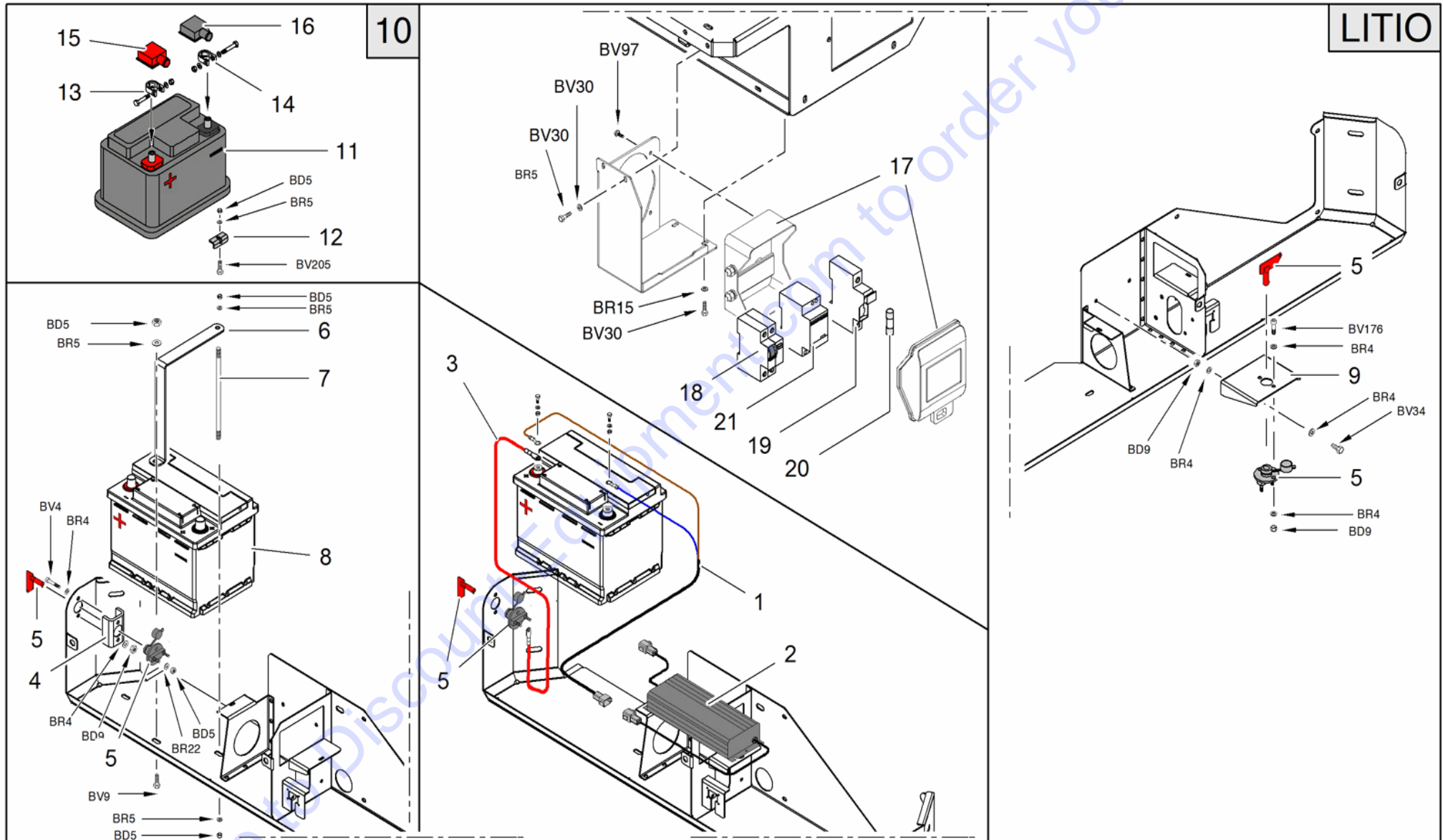

 INSTALLATION ÉLECTRIQUE

ELEKTRISCHE ANLAGE 





INSTALACIÓN ELÉCTRICA 







 IMPIANTO ELETTRICO
ELEKTRISCHE ANLAGE 
 ELECTRICAL SYSTEM
INSTALACIÓN ELÉCTRICA 
 INSTALLATION ÉLECTRIQUE

| POS Codice | Q.tà |  Descrizione |  Description |  Designation |  Benennung |  Descripción |
|--------------|------|---|---|---|---|---|
| 1 1764260002 | 1 NR | LINEA DA ALIMENTATORE A BATTERIA COMPLETA DI CONNETTORI E DIODO | LINE FROM CHARGER TO BATTERY WITH CONNECTORS AND DIODE | | | |
| 2 1757250007 | 1 NR | ALIMENTATORE ELETTRONICO 285W REGOLABILE IP65 PER BATTERIE 55-75 AH COMPLETO DI CONNETTORI | ELECTRONIC BALLAST | ALIMENTATEUR ÉLECTRONIQUE | ELEKTRONISCHE S NETZGERÄT | ALIMENTADOR ELETRÓNICO |
| 3 1764260001 | 1 NR | CAVO POSITIVO BATTERIA | 12V BATTERY CABLE | | | |
| 4 055687Y1 | 1 NR | SUPPORTO | SUPPORT | SUPPORT | HALTERUNG | SOPORTE |
| 5 04774900 | 1 NR | STACCA BATTERIA | BATTERY CUT-OFF DEVICE | COUPE BATTERIE | BATTERIETRENN SCHALTER | CORTA-BATERÍA |
| 9 069226Y1 | 1 NR | SUPPORTO | SUPPORT | SUPPORT | HALTERUNG | SOPORTE |
| 10 17688300 | 1 NR | KIT AGGIUNTA BATTERIA 27668600 SU LL1775-X17JP-X5 00AJ | BATTERY KIT | KIT BATTERIE | AKKUSATZ | KIT BATERIA |

 IMPIANTO ELETTRICO
ELEKTRISCHE ANLAGE 
 ELECTRICAL SYSTEM
INSTALACIÓN ELÉCTRICA 
 INSTALLATION ÉLECTRIQUE

| POS Codice | Q.tà |  Descrizione |  Description |  Designation |  Benennung |  Descripción |
|---------------|------|---|---|---|---|---|
| 11 27668600 | 1 NR | BATTERIA AGM S&S 12V 60AH 680A L02 | BATTERY AGM S&S 12V 60AH 680A L02 | BATTERIE AGM S&S 12V 60AH 680A L02 | BATTERIE AGM S&S 12V 60AH 680A L02 | BATERÍA AGM S&S 12V 60AH 680A L02 |
| 12 051705Y1 | 2 NR | PIATTO FERMO BATTERIA | BATTERY BLOCK PLATE | PLACQUE D'ATTERT BATTERIE | BLOCKPLATTE BATTERIE | PLATO DE SUJECIÓN BATERÍA |
| 13 06793100 | 1 NR | MORSETTO POSITIVO BATTERIA CON RIDUTTORE | POSITIVE BATTERY TERMINAL | BORNE POSITIVE BATTERIE HS1100 AVEC RÉDUCTEUR | KLEMME PLUSPOL DER BATTERIE MIT REDUKTOR | BORNE POSITIVO BATERÍA HS1100 CON REDUCTOR |
| 13 1739150023 | 1 NR | MORSETTO POSITIVO A C PER BATTERIA M10 | POSITIVE BATTERY CLAMP "C" M10 | BORNE POSITIVE A C POUR BATTERIE M10 | POSITIVE KLEMME FÜR BATTERIE M10 | BORNE POSITIVO A C PARA BATERÍA M10 |
| 14 06793200 | 1 NR | MORSETTO NEGATIVO BATTERIA CON RIDUTTORE | NEGATIVE BATTERY TERMINAL | BORNE NEGATIF BATTERIE AVEC RÉDUCTEUR | KLEMME MINUSPOL DER BATTERIE MIT REDUKTOR | BORNE NEGATIVO BATERÍA CON REDUCTOR |
| 14 1739150025 | 1 NR | MORSETTO NEGATIVO A C PER BATTERIA M10 | NEGATIVE BATTERY TERMINAL C M10 | BORNE NEGATIVE A C POUR BATTERIE M10 | NEGATIVE KLEMME FÜR BATTERIE M10 | BORNE NEGATIVO A C PARA BATERÍA M10 |
| 15 2632920007 | 1 NR | COPRI POLI BATTERIA QUADRATO ROSSO | POLE BATTERY COVER RED SQUARE | POLE CACHE BATTERIE RED SQUARE | POLE BATTERY COVER RED SQUARE | TAPAS DE LA BATERIA |

 IMPIANTO ELETTRICO
ELEKTRISCHE ANLAGE 
 ELECTRICAL SYSTEM
INSTALACIÓN ELÉCTRICA 
 INSTALLATION ÉLECTRIQUE

| POS Codice | Q.tà |  Descrizione |  Description |  Designation |  Benennung |  Descripción |
|---------------|------|--|--|---|---|---|
| 16 2632920008 | 1 NR | COPRI POLI BATTERIA QUADRATO NERO | POLE BATTERY COVER BLACK SQUARE | POLE BATTERIE COUVERTURE CARRÉ NOIR | POLE BATTERY COVER BLACK SQUARE | TAPAS BATERIA |
| 17 1730720006 | 1 NR | SCATOLA ELETTRICA MAGNETOTERMI CO FORATA CIAM | ELECTRICAL MAGNETOTHERM IC BOX DRILLED CIAM | BOÎTE ÉLECTRIQUE | ELEKTROGEHÄU SE | CAJA ELÉCTRICA |
| 17 1757250008 | 1 NR | SCATOLA ELETTRICO PLASTICA 6 MODULI BI COPERCHIO TRASPARENTE | ELECTRICAL BOX | BOÎTE ÉLECTRIQUE | SCHALTKASTEN | CAJA ELÉCTRICA |
| 18 1556350015 | 1 NR | INTERUTTORE AUTOMATICO MAGNETOTERMI CO 220V | AUTOMATIC THERMAL SWITCH 220V | INTERRUPTEUR | INTERRUPTORES | INTERRUPTOR |
| 18 1556350063 | 1 NR | INTERUTTORE AUTOMATICO MAGNETOTERMI CO 110-120V 25A (FINO A C170000355 MONTATO C16 SU MACCHINE 120V) | AUTOMATIC THERMAL SWITCH 110-120V 25A (UNTIL C170000355 MOUNTED C16 ON 120V MACHINES) | INTERRUPTEUR | SCHALTER | INTERRUPTOR |





 IMPIANTO ELETTRICO

ELEKTRISCHE ANLAGE 



 ELECTRICAL SYSTEM



INSTALACIÓN ELÉCTRICA 

 INSTALLATION ÉLECTRIQUE



| POS Codice | Q.tà |  Descrizione |  Description |  Designation |  Benennung |  Descripcìon |
|---------------|------|---|---|---|---|---|
| 19 1730720015 | 1 NR | PORTAFUSIBILE A TUBO 220/110V | FUSE HOLDER TUBE 220/110V | BOÎTE À FUSIBLES | SICHERUNGSKA STEN | PORTAFUSIBLES |
| 20 1730720017 | 1 NR | FUSIBILE A TUBO 10A | TUBE FUSE 10A | FUSIBLE | SICHERUNG | FUSIBLE |
| 21 1757250006 | 1 NR | TELERUTTORE 4POLI 63A CA/CC | RELAY | RELAIS | RELAIS | RELÉ |



Go to Discount-Equipment.com to Order your parts



-  ADESIVI
-  STICKER
-  AUTOCOLLANT

- AUFKLEBER 
- PEGATINA 



Go to Discount-Equipment.com to order your parts



 ADESIVI
 STICKER
 AUTOCOLLANT





AUFKLEBER 
PEGATINA 

| POS Codice | Q.tà |  Descrizione |  Description |  Designation |  Benennung |  Descripcìon |
|------------|------|---|---|---|---|---|
|------------|------|---|---|---|---|---|





Go to Discount-Equipment.com to order your parts



 ADESIVI
 STICKER
 AUTOCOLLANT



AUFKLEBER 
 PEGATINA 





| POS Codice | Q.tà |  Descrizione |  Description |  Designation |  Benennung |  Descripció |
|------------|-------|---|---|---|---|--|
| 0 06039700 | 9 NR | ADESIVO | STICKER | AUTOCOLLANT | AUFKLEBER | PEGATINA |
| 0 06040300 | 4 NR | ADESIVO | STICKER | AUTOCOLLANT | AUFKLEBER | PEGATINA |
| 0 06040500 | 2 NR | ADESIVO | STICKER | AUTOCOLLANT | AUFKLEBER | PEGATINA |
| 0 06040900 | 5 NR | ADESIVO | STICKER | AUTOCOLLANT | AUFKLEBER | PEGATINA |
| 0 06041200 | 4 NR | ADESIVO | STICKER | AUTOCOLLANT | AUFKLEBER | PEGATINA |
| 0 06041300 | 13 NR | ADESIVO | STICKER | AUTOCOLLANT | AUFKLEBER | PEGATINA |
| 0 06041600 | 1 NR | ADESIVO CARBURANTE BENZINA COLORE VERDE L=60 X 80 (**) | DECAL | AUTOCOLLANT | AUFKLEBER | PEGATINA |
| 0 06043900 | 1 NR | ADESIVO | STICKER | AUTOCOLLANT | AUFKLEBER | PEGATINA |
| 0 06044000 | 8 NR | ADESIVO | STICKER | AUTOCOLLANT | AUFKLEBER | PEGATINA |
| 0 06056300 | 1 NR | ADESIVO | STICKER | AUTOCOLLANT | AUFKLEBER | PEGATINA |
| 0 06060000 | 1 NR | ADESIVO | STICKER | AUTOCOLLANT | AUFKLEBER | PEGATINA |
| 0 06085900 | 1 NR | ADESIVO | STICKER | AUTOCOLLANT | AUFKLEBER | PEGATINA |
| 0 06086000 | 1 NR | ADESIVO | STICKER | AUTOCOLLANT | AUFKLEBER | PEGATINA |
| 0 06086700 | 6 NR | ADESIVO | STICKER | AUTOCOLLANT | AUFKLEBER | PEGATINA |



| | |
|---|---|
|  ADESIVI | AUFKLEBER  |
|  STICKER | PEGATINA  |
|  AUTOCOLLANT | |



| POS Codice | Q.tà |  Descrizione |  Description |  Designation |  Benennung |  Descripciòn |
|------------|------|---|---|---|---|---|
| 0 06136900 | 1 NR | ADESIVO PUNTI INGRASSAGGIO Ø 55 TESTO NERO - SFONDO BIANCO (**) | STICKER GREASE POINTS Ø 55 | AUTOCOLLANT POINTS GRAISSANGE Ø 55 TEXTE NOIR - FOND BLANC (**) | AUFKLEBER SCHMIERPUNKTE Ø 55, SCHWARZER TEXT - WEIßER UNTERGRUND | PEGATINS PUNTOS ENGRASE Ø 55 TEXTO NEGRO - FONDO BLANCO (**) |
| 0 06164600 | 1 NR | ADESIVO | STICKER | AUTOCOLLANT | AUFKLEBER | PEGATINA |
| 0 06164700 | 1 NR | ADESIVO | STICKER | AUTOCOLLANT | AUFKLEBER | PEGATINA |
| 0 06165000 | 1 NR | ADESIVO | STICKER | AUTOCOLLANT | AUFKLEBER | PEGATINA |
| 0 06227200 | 1 NR | ADESIVO "CONTROLLARE LIVELLO OLIO MOTORE " 7 LINGUE GIALLO L=82X108 (**) | DECAL | AUTOCOLLANT | AUFKLEBER | PEGATINA |
| 0 06232100 | 1 NR | ADESIVO | STICKER | AUTOCOLLANT | AUFKLEBER | PEGATINA |
| 0 06254800 | 1 NR | ADESIVO" STOP EMERGENZA" SFONDO GIALLO L=100X50 (**) | DECAL | AUTOCOLLANT | AUFKLEBER | PEGATINA |
| 0 06436900 | 8 NR | | | | | |
| 0 06448100 | 2 NR | ADESIVO | STICKER | AUTOCOLLANT | AUFKLEBER | PEGATINA |
| 0 06448200 | 2 NR | ADESIVO | STICKER | AUTOCOLLANT | AUFKLEBER | PEGATINA |





 ADESIVI
 STICKER
 AUTOCOLLANT



AUFKLEBER 
 PEGATINA 



| POS Codice | Q.tà |  Descrizione |  Description |  Designation |  Benennung |  Descripció |
|------------|------|---|---|---|---|--|
| 0 06506400 | 1 NR | ADESIVO | STICKER | AUTOCOLLANT | AUFKLEBER | PEGATINA |
| 0 06520600 | 2 NR | ADESIVO | STICKER | AUTOCOLLANT | AUFKLEBER | PEGATINA |
| 0 06555500 | 1 NR | ADESIVO | STICKER | AUTOCOLLANT | AUFKLEBER | PEGATINA |
| 0 06555600 | 1 NR | ADESIVO | STICKER | AUTOCOLLANT | AUFKLEBER | PEGATINA |
| 0 06555700 | 1 NR | ADESIVO | STICKER | AUTOCOLLANT | AUFKLEBER | PEGATINA |
| 0 06555800 | 1 NR | ADESIVO | STICKER | AUTOCOLLANT | AUFKLEBER | PEGATINA |
| 0 06561200 | 5 NR | ADESIVO | STICKER | AUTOCOLLANT | AUFKLEBER | PEGATINA |
| 0 06706500 | 1 NR | ADESIVO | STICKER | AUTOCOLLANT | AUFKLEBER | PEGATINA |
| 0 06840400 | 1 NR | | | | | |
| 0 06924300 | 1 NR | ADESIVO | STICKER | AUTOCOLLANT | AUFKLEBER | PEGATINA |
| 0 06998800 | 1 NR | ADESIVO | STICKER | AUTOCOLLANT | AUFKLEBER | PEGATINA |
| 0 07034200 | 2 NR | ADESIVO | STICKER | AUTOCOLLANT | AUFKLEBER | PEGATINA |
| 0 07056400 | 4 NR | ADESIVO | STICKER | AUTOCOLLANT | AUFKLEBER | PEGATINA |
| 0 07056700 | 2 NR | ADESIVO | STICKER | AUTOCOLLANT | AUFKLEBER | PEGATINA |
| 0 07056800 | 2 NR | ADESIVO | STICKER | AUTOCOLLANT | AUFKLEBER | PEGATINA |
| 0 07058800 | 2 NR | ADESIVO | STICKER | AUTOCOLLANT | AUFKLEBER | PEGATINA |
| 0 07060500 | 2 NR | ADESIVO | STICKER | AUTOCOLLANT | AUFKLEBER | PEGATINA |





 ADESIVI
 STICKER
 AUTOCOLLANT



AUFKLEBER 
 PEGATINA 



| POS Codice | Q.tà |  Descrizione |  Description |  Designation |  Benennung |  Descripcìon |
|------------|------|--|---|---|---|---|
| 0 07060600 | 2 NR | ADESIVO | STICKER | AUTOCOLLANT | AUFKLEBER | PEGATINA |
| 0 07060700 | 2 NR | ADESIVO | STICKER | AUTOCOLLANT | AUFKLEBER | PEGATINA |
| 0 07071000 | 1 NR | ADESIVO | STICKER | AUTOCOLLANT | AUFKLEBER | PEGATINA |
| 0 07071200 | 8 NR | ADESIVO | STICKER | AUTOCOLLANT | AUFKLEBER | PEGATINA |
| 0 07198800 | 4 NR | ADESIVO | STICKER | AUTOCOLLANT | AUFKLEBER | PEGATINA |
| 0 07199100 | 1 NR | ADESIVO | STICKER | AUTOCOLLANT | AUFKLEBER | PEGATINA |
| 0 07240300 | 1 NR | ADESIVO | STICKER | AUTOCOLLANT | AUFKLEBER | PEGATINA |
| 0 07242000 | 1 NR | ADESIVO | STICKER | AUTOCOLLANT | AUFKLEBER | PEGATINA |
| 0 07242100 | 4 NR | ADESIVO | STICKER | AUTOCOLLANT | AUFKLEBER | PEGATINA |
| 0 07243000 | 1 NR | ADESIVO | STICKER | AUTOCOLLANT | AUFKLEBER | PEGATINA |
| 0 07264700 | 1 NR | ADESIVO INDICATORE LED CARICABATTERIE 48V (Ø EST.31MM Ø INT.6 MM) VECCHIO BMS (FINO A C170000329) | DECAL | AUTOCOLLANT | AUFKLEBER | PEGATINA |
| 0 07264800 | 2 NR | ADESIVO | DECAL | AUTOCOLLANT | AUFKLEBER | PEGATINA |
| 0 07268300 | 8 NR | ADESIVO | DECAL | AUTOCOLLANT | AUFKLEBER | PEGATINA |





 ADESIVI
 STICKER
 AUTOCOLLANT



AUFKLEBER 
 PEGATINA 



| POS Codice | Q.tà |  Descrizione |  Description |  Designation |  Benennung |  Descripcìon |
|------------|------|---|---|---|---|---|
| 0 07268400 | 4 NR | ADESIVO | DECAL | AUTOCOLLANT | AUFKLEBER | PEGATINA |
| 0 07281100 | 4 NR | | | | | |
| 0 07349200 | 1 NR | | | | | |
| 0 07350300 | 4 NR | ADESIVO | DECAL | AUTOCOLLANT | AUFKLEBER | PEGATINA |
| 0 07350300 | 1 NR | ADESIVO | DECAL | AUTOCOLLANT | AUFKLEBER | PEGATINA |
| 0 07394800 | 1 NR | ADESIVO INDICATORE LED CARICABATTERIE 48V (Ø EST.31MM Ø INT.6 MM) NUOVO BMS/4 (DA C170000330) | DECAL | AUTOCOLLANT | AUFKLEBER | PEGATINA |
| 0 07397100 | 2 NR | | | | | |
| 0 07499300 | 1 NR | ADESIVO DON'T OPEN THE CASE SFONDO GIALLO L=60X17 MM | DECAL | AUTOCOLLANT | AUFKLEBER | PEGATINA |
| 0 07506500 | 1 NR | ADESIVO JLG - EMERGENCY STOP L= 170X100 MM | DECAL | AUTOCOLLANT | AUFKLEBER | PEGATINA |





 ADESIVI
 STICKER
 AUTOCOLLANT

AUFKLEBER 
 PEGATINA 

| POS Codice | Q.tà |  Descrizione |  Description |  Designation |  Benennung |  Descripcìon |
|--------------|------|---|---|---|---|---|
| 0 07512700 | 1 NR | ADESIVO ATTENZIONE! NON COLLEGARE IL COMPUTER L=75X75 MM | STICKER | AUTOCOLLANT | AUFKLEBER | PEGATINA |
| 0 07668100 | 1 NR | ADESIVO PULSANTI DISTRIBUTORE PARTE AEREA LL2614 L=318X52 MM | DECAL | AUTOCOLLANT | AUFKLEBER | PEGATINA |
| 0 07668200 | 1 NR | ADESIVO EMERGENCY STOP E BLOCCHETTO ACCENSIONE L=85X160 MM | DECAL | AUTOCOLLANT | AUFKLEBER | PEGATINA |
| 0 07668300 | 1 NR | ADESIVO | DECAL | AUTOCOLLANT | AUFKLEBER | PEGATINA |
| 0 07802200 | 2 NR | ADESIVO RUMORE 102 DB L=90X100 MM | STICKER NOISE 102 DB L = 90 X 100 MM | | | |
| 0 1001125483 | 7 NR | ADESIVO | STICKER | AUTOCOLLANT | AUFKLEBER | PEGATINA |
| 0 1001125483 | 3 NR | ADESIVO | STICKER | AUTOCOLLANT | AUFKLEBER | PEGATINA |
| 0 1001125483 | 6 NR | ADESIVO | STICKER | AUTOCOLLANT | AUFKLEBER | PEGATINA |
| 0 1608710001 | 1 NR | ADESIVO | STICKER | AUTOCOLLANT | AUFKLEBER | PEGATINA |

 ADESIVI
 STICKER
 AUTOCOLLANT

AUFKLEBER 
 PEGATINA 

| POS Codice | Q.tà |  Descrizione |  Description |  Designation |  Benennung |  Descripcìon |
|--------------|------|---|---|---|---|---|
| 0 1608710002 | 1 NR | ADESIVO | STICKER | AUTOCOLLANT | AUFKLEBER | PEGATINA |
| 0 1701499 | 4 NR | ADESIVO | STICKER | AUTOCOLLANT | AUFKLEBER | PEGATINA |
| 0 1701504 | 1 NR | ADESIVO | STICKER | AUTOCOLLANT | AUFKLEBER | PEGATINA |
| 0 1701505 | 1 NR | ADESIVO | STICKER | AUTOCOLLANT | AUFKLEBER | PEGATINA |
| 0 1701542 | 1 NR | ADESIVO | STICKER | AUTOCOLLANT | AUFKLEBER | PEGATINA |
| 0 1701640 | 1 NR | ADESIVO | STICKER | AUTOCOLLANT | AUFKLEBER | PEGATINA |
| 0 1702155 | 1 NR | ADESIVO | STICKER | AUTOCOLLANT | AUFKLEBER | PEGATINA |
| 0 1703814 | 4 NR | ADESIVO | STICKER | AUTOCOLLANT | AUFKLEBER | PEGATINA |
| 0 1704277 | 2 NR | ADESIVO | STICKER | AUTOCOLLANT | AUFKLEBER | PEGATINA |
| 0 1705828 | 1 NR | ADESIVO | STICKER | AUTOCOLLANT | AUFKLEBER | PEGATINA |
| 0 1706098 | 1 NR | ADESIVO | STICKER | AUTOCOLLANT | AUFKLEBER | PEGATINA |
| 0 1706493 | 1 NR | ADESIVO | STICKER | AUTOCOLLANT | AUFKLEBER | PEGATINA |
| 0 1706898 | 1 NR | ADESIVO | STICKER | AUTOCOLLANT | AUFKLEBER | PEGATINA |
| 0 1722420001 | 2 NR | ADESIVO | STICKER | | | |

Cod. 17107300

KIT INTEGRAZIONE ADESIVI PER PIATTAFORME AEREE LITHIUM-ANSI
INTEGRATION KIT STICKERS PLATFORMS LITHIUM-ANSI
X390AJ - X500AJ - X550AJ - X600AJ - X700AJ - X770AJ

Da usare in aggiunta ai seguenti kit / To be use in addition to the following kits

X390AJ - cod.17065200

X500AJ - cod.17224100

X550AJ - cod.17065300

X600AJ - cod. 17485000

X700AJ - cod.17065400

X770AJ - cod.17633600

+ kit in lingua non inclusi nel codice generale
language code not included in the standard kit

•
+171073GB

+ 171073FR

+ 171073ES

+ 171073PT



9



16



4



5



KIT ADESIVI - X390AJ

SET OF DECALS - X390AJ

KIT COLLANTS - X390AJ

AUFKLEBERSATZ -X390AJ

KIT ADHESIVOS -X390AJ

ADHESIEKIT -X390AJ

cod. 17107300

Tav 01

9



1



4

17

4



13



KIT ADESIVI - X390AJ

SET OF DECALS -X390AJ

KIT COLLANTS -X390AJ

AUFKLEBERSATZ -X390AJ

KIT ADHESIVOS -X390AJ

ADHESIEKIT -X390AJ

cod. 17107300

Tav 02



9



16



2



4

1

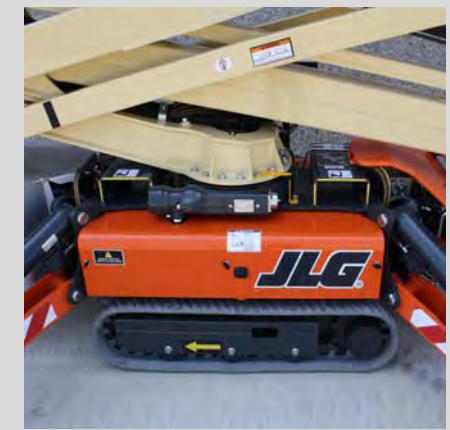

5

KIT ADESIVI - X500AJ
 SET OF DECALS - X500AJ
 KIT COLLANTS - X500AJ

AUFKLEBERSATZ - X500AJ
 KIT ADHESIVOS - X500AJ
 ADHESIEKIT - X500AJ

cod. 17107300

Tav 01

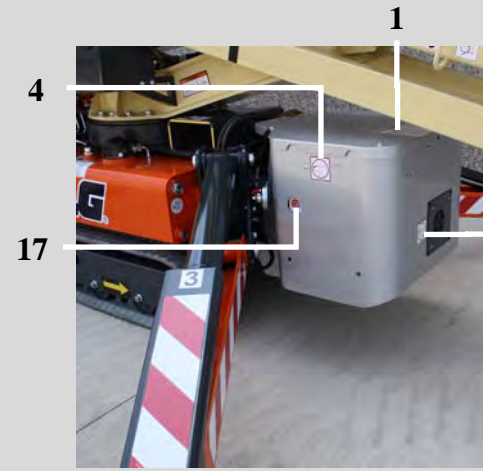

KIT ADESIVI - X500AJ

SET OF DECALS - X500AJ

KIT COLLANTS - X500AJ

AUFKLEBERSATZ - X500AJ

KIT ADHESIVOS - X500AJ

ADHESIEKIT - X500AJ

cod. 17107300

Tav 02

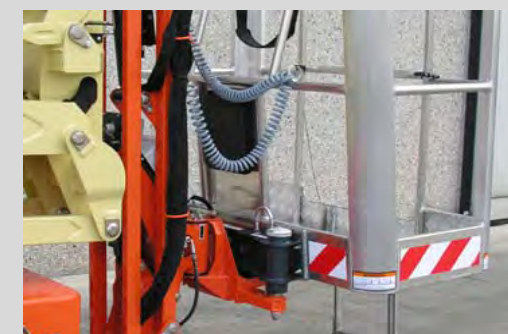

KIT ADESIVI - X550AJ

SET OF DECALS - X550AJ

KIT COLLANTS - X550AJ

AUFKLEBERSATZ - X550AJ

KIT ADHESIVOS - X550AJ

ADHESIEKIT - X550AJ

cod. 17107300

Tav 01



4
17

9



13



KIT ADESIVI - X550AJ
SET OF DECALS - X550AJ
KIT COLLANTS - X550AJ

AUFKLEBERSATZ - X550AJ
KIT ADHESIVOS - X550AJ
ADHESIEKIT - X550AJ

cod. 17107300

Tav 02



4

5

9

16



4



KIT ADESIVI - X600AJ

SET OF DECALS - XX600AJ

KIT COLLANTS - X600AJ

AUFKLEBERSATZ - X600AJ

KIT ADHESIVOS - X600AJ

ADHESIEKIT - X600AJ

cod. 17107300

Tav 01



9

4



13



1

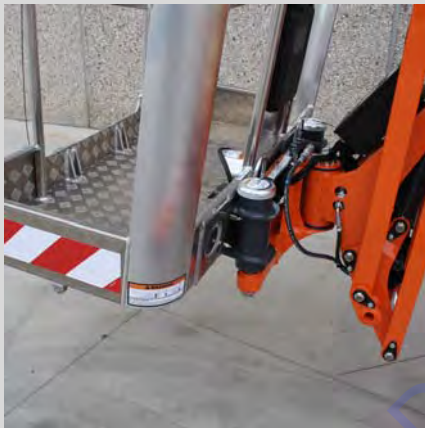

18

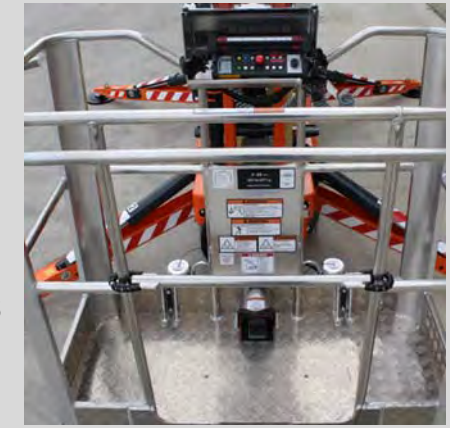

KIT ADESIVI - X600AJ

SET OF DECALS - XX600AJ

KIT COLLANTS - X600AJ

AUFKLEBERSATZ - X600AJ

KIT ADHESIVOS - X600AJ

ADHESIEKIT - X600AJ

cod. 17107300

Tav 02

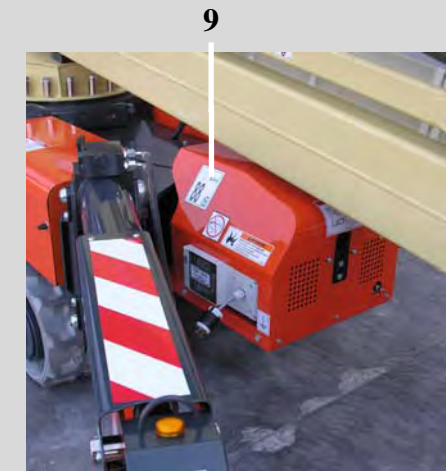

KIT ADESIVI - X700AJ

SET OF DECALS - X700AJ

KIT COLLANTS - X700AJ

AUFKLEBERSATZ - X700AJ

KIT ADHESIVOS -X700AJ

ADHESIEKIT -X700AJ

cod. 17107300

Tav 01

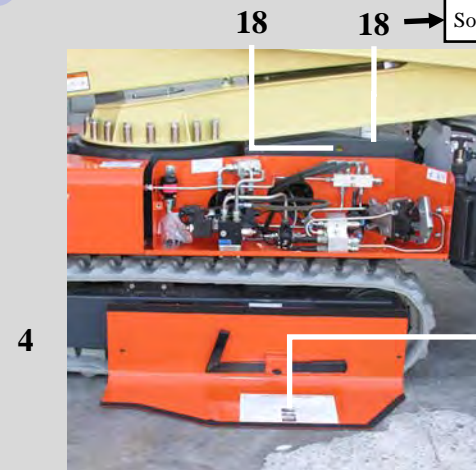

Sotto il coperchio / under the lid

KIT ADESIVI -X700AJ

SET OF DECALS -X700AJ

KIT COLLANTS -X700AJ

AUFKLEBERSATZ -X700AJ

KIT ADHESIVOS -X700AJ

ADHESIEKIT -X700AJ

cod. 17107300

Tav 02

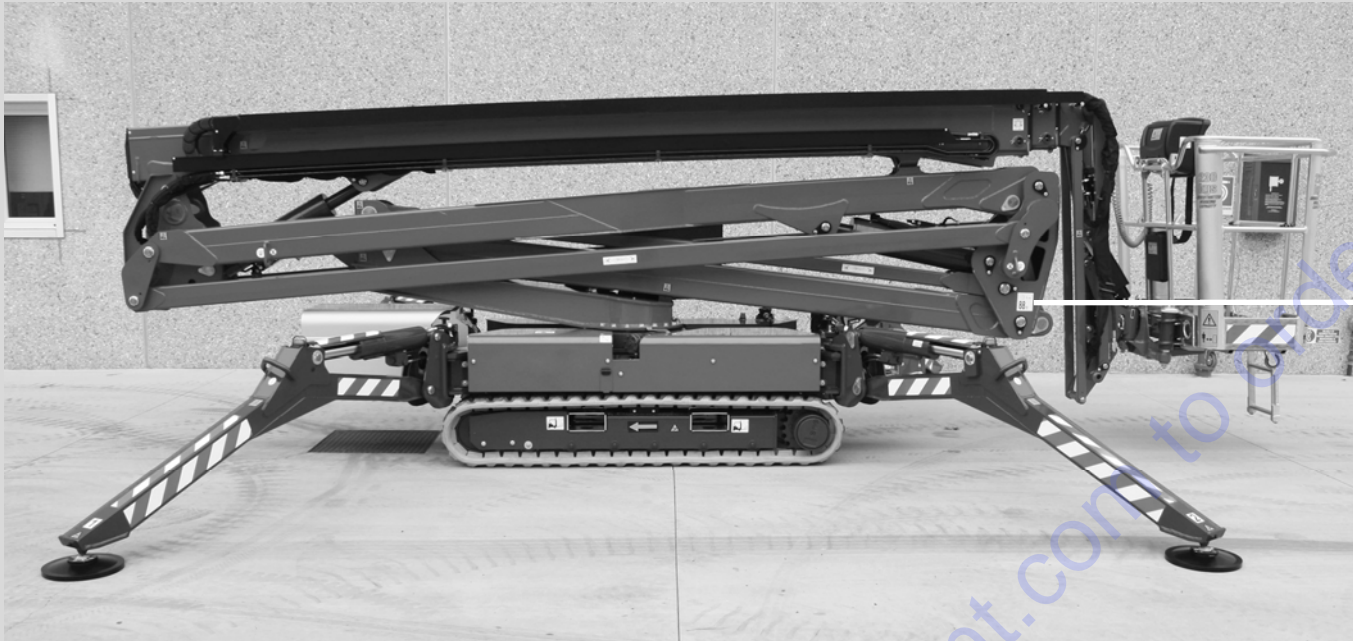

9



Fare foto della X770J lithium

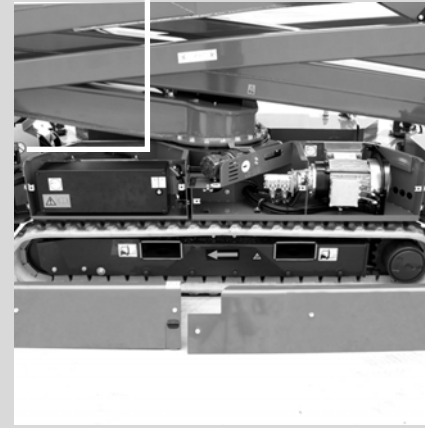
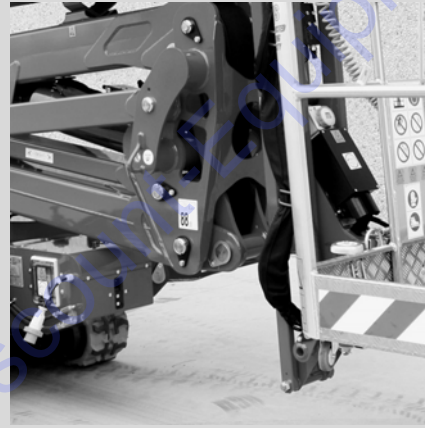

4



13

KIT ADESIVI - X770AJ

SET OF DECALS - X770AJ

KIT COLLANTS - X770AJ

AUFKLEBERSATZ - X770AJ

KIT ADHESIVOS -X770AJ

ADHESIEKIT - X770AJ

cod. 17107300

Tav 01

9



Fare foto della X770J lithium



4



16



1

18

4

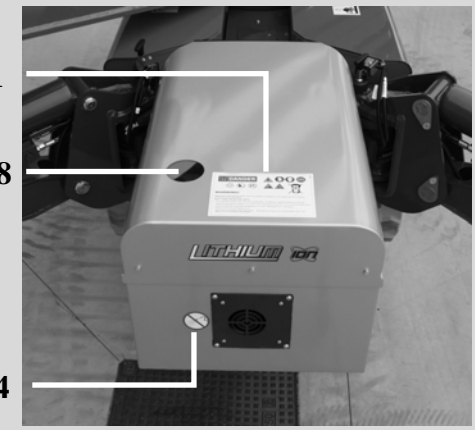

KIT ADESIVI - X770AJ

SET OF DECALS - X770AJ

KIT COLLANTS - X770AJ

AUFKLEBERSATZ - X770AJ

KIT ADHESIVOS -X770AJ

ADHESIEKIT - X770AJ

cod. 17107300

Tav 02

Cod. 17107300

KIT INTEGRAZIONE ADESIVI PER PIATTAFORME AEREE LITHIUM-ANSI
INTEGRATION KIT STICKERS PLATFORMS LITHIUM-ANSI
X390AJ - X500AJ - X550AJ - X600AJ - X700AJ - X770AJ

Go to Discount-Equipment.com to order your parts

| | | |
|---|-----------------------------|------------|
| 17107300 POSIZIONE ADESIVI / POSITION STICKERS | IN LINGUA / LANGUAGE | JLG |
| | VOLTAGGIO / VOLTAGE | |

| POS. | COD. | REV. | DESCRIZIONE / DESCRIPTION | Q.tà |
|------|------------|----------|---|------|
| 01 | | | | |
| 02 | | | | |
| 03 | | | | |
| 04 | 1001125483 | A | ADESIVO JLG VIETATO LAVARE L=63,5X63,5 MM | 03 |
| 05 | 06506400 | B | ADESIVO " CHIAVE DI ACCENSIONE" ESTERNO Ø 49 FORO Ø 22 SERIE LITHIUM ION | 01 |
| 06 | | | | |
| 07 | | | | |
| 08 | | | | |
| 09 | 06520600 | B | ADESIVO RUMORE 88 dB L=90x100 | 02 |
| 10 | | | | |
| 11 | | | | |
| 12 | | | | |
| 13 | | | | |
| 14 | | | | |
| 15 | | | | |
| 16 | | | | |
| 17 | 07264700 | A | ADESIVO INDICATORE LED CARICABATTERIE 48V (Ø EST.31MM Ø INT.6 MM) VECCHIO BMS (FINO A C170000329) | 01 |
| | 07394800 | A | ADESIVO INDICATORE LED CARICABATTERIE 48V (Ø EST.31MM Ø INT.6 MM) NUOVO BMS/4 (DA C170000330) | 01 |
| 18 | 07264800 | A | ADESIVO INDICATORE LED RICARICA BATTERIE Ø EST.21MM Ø INT.4 MM | 02 |
| 19 | | | | |

KIT ADESIVI IN LINGUA PER / LANGUAGE KIT STICKERS FOR

X390AJ - X500AJ - X550AJ - X600AJ - X700AJ - X770AJ

Cod.

+ 171073GB

+ 171073FR

+ 171073ES

+ 171073PT

Go to Discount-Equipment.com to order your parts

171073 POSIZIONE ADESIVI IN LINGUA /**
POSITION LANGUAGE STICKERS

IN LINGUA / LANGUAGE

JLG

VOLTAGGIO / VOLTAGE

| POS. | COD. | REV. | DESCRIZIONE / DESCRIPTION | Q.tà |
|------|----------|------|--|------|
| | 171073GB | | ADESIVI PIATTAF. AEREA X390AJ - X14J - X17J - X550AJ - X19J - X700AJ - X23J - LINGUA INGLESE | |
| 01 | 07107200 | A | ADESIVO JLG-ANSI ATTENZIONE PERICOLO BATTERIE - ING L=210X145 MM | 01 |
| 07 | | | | |
| 10 | | | | |
| 11 | | | | |
| 12 | | | | |
| 13 | 07107100 | A | ADESIVO JL-ANSI RICARICARE LE BATTERIE DOPO L'USO ALMENO OGNI 3 MESI - ING L=50x50 MM | 01 |
| 14 | | | | |
| 15 | | | | 01 |
| | | | | |
| | | | | |
| 16 | 07110300 | A | ADESIVO JLG ANSI ISTRUZIONI DISCESA DI EMERG. X390AJ LITHIUM - ING L=280 X195MM | 01 |
| 16 | ----- | A | ADESIVO JLG ANSI ISTRUZ. DISCESA DI EMERG. X500AJ / Utilizzare l' adesivo della motorizzazione con motore termico - vedere kit lingua inglese cod. 172241GB -Use the thermal sticker version - see the English language kit cod. 172241GB | 01 |
| 16 | 07110200 | A | ADESIVO JLG ANSI ISTRUZIONI DISCESA DI EMERG. X550AJ LITHIUM L=280 X195MM - GB | 01 |
| 16 | ----- | A | ADESIVO JLG ANSI ISTRUZ. DISCESA DI EMERG. X600AJ / Utilizzare l' adesivo della motorizzazione con motore termico - vedere kit lingua inglese cod. 174850GB - Use the thermal sticker version - see the English language kit cod. 174850GB | 01 |
| 16 | 07110100 | A | ADESIVO JLG ANSI ISTRUZIONI DISCESA DI EMERG. X700AJ LITHIUM - ING L=280 X195MM | 01 |
| 16 | ----- | A | ADESIVO JLG ANSI ISTRUZ. DISCESA DI EMERG. X770AJ / Utilizzare l' adesivo della motorizzazione con motore termico - vedere kit lingua inglese cod. 176264GB - Use the thermal sticker version - see the English language kit cod. 176264GB | 01 |

Cod. 17187700

**KIT INTEGRAZIONE ADESIVI PER PIATTAFORME AEREE LITHIUM-CE /
INTEGRATION KIT STICKERS PLATFORMS LITHIUM-CE**

**X14J - X14J-H - X17J - X17JPLUS - X19J -
X20JPLUS - X23J - X26JPLUS**

Da usare in aggiunta a / To use in added to

X14J - cod.17063500

X14J-H - cod.17065000

X17J cod.17063700

X17JPLUS cod. 17242800

X19J cod.17063200

X20JPLUS cod. 17351800

X23J cod.17062700

X26JPLUS cod.17633400

+ kit in lingua non inclusi nel codice generale + language code not included in the standard kit

171877IT / 171877GB / 171877FR / 171877DE / 171877ES / 171877NL

171877PT / 171877SW / 171877DA / 171877NO / 171877JA



9



16



4



5



KIT ADESIVI - X14J LITHIUM
 SET OF DECALS - X14J LITHIUM
 KIT COLLANTS - X14J LITHIUM

AUFKLEBERSATZ - X14J LITHIUM
 KIT ADHESIVOS - X14J LITHIUM
 ADHESIEKIT - X14J LITHIUM

cod. 17187700

Tav 01

9

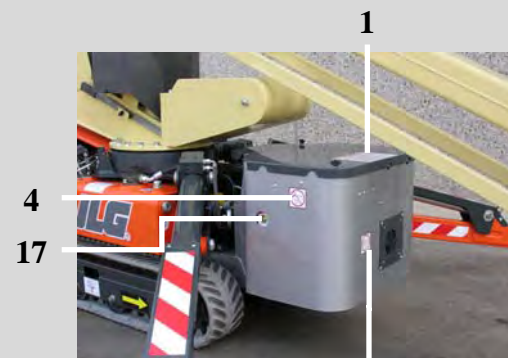

4
17

1

4



13



KIT ADESIVI - X14J LITHIUM

SET OF DECALS - X14J LITHIUM

KIT COLLANTS - X14J LITHIUM

AUFKLEBERSATZ - X14J LITHIUM

KIT ADHESIVOS - X14J LITHIUM

ADHESIEKIT - X14J LITHIUM

cod. 17187700

Tav 02

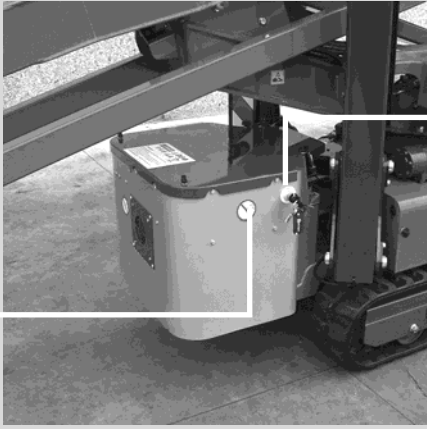

KIT ADESIVI - X17J LITHIUM

SET OF DECALS - X17J LITHIUM

KIT COLLANTS - X17J LITHIUM

AUFKLEBERSATZ - X17J LITHIUM

KIT ADHESIVOS - X17J LITHIUM

ADHESIEKIT - X17J LITHIUM

cod. 17187700

Tav 01

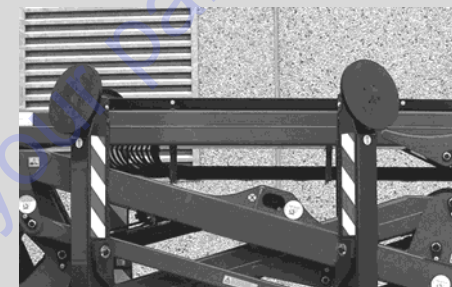

13

1

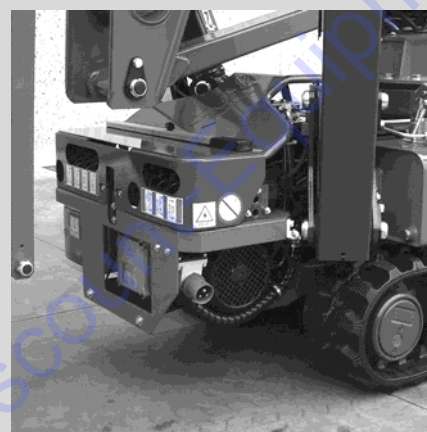

4

17

4



KIT ADESIVI - X17J LITHIUM

SET OF DECALS - X17J LITHIUM

KIT COLLANTS - X17J LITHIUM

AUFKLEBERSATZ - X17J LITHIUM

KIT ADHESIVOS - X17J LITHIUM

ADHESIEKIT - X17J LITHIUM

cod. 17187700

Tav 02



9



16



1

4

4

5



cod. 17187700

KIT ADESIVI - X17JPLUS LITHIUM

SET OF DECALS - X17JPLUS LITHIUM

KIT COLLANTS - X17JPLUS LITHIUM

AUFKLEBERSATZ - X17JPLUS LITHIUM

KIT ADHESIVOS - X17JPLUS LITHIUM

ADHESIEKIT - X17JPLUS LITHIUM

Tav 01



9



13

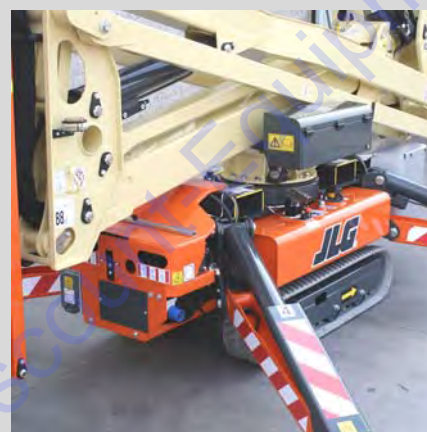

4

17

3



KIT ADESIVI - X17JPLUS LITHIUM

SET OF DECALS - X17JPLUS LITHIUM

KIT COLLANTS - X17JPLUS LITHIUM

AUFKLEBERSATZ - X17JPLUS LITHIUM

KIT ADHESIVOS - X17JPLUS LITHIUM

ADHESIEKIT - X17JPLUS LITHIUM

cod. 17187700

Tav 02

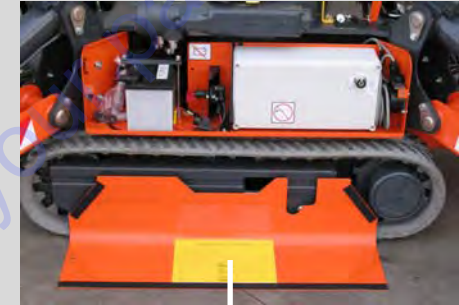

16



9



KIT ADESIVI - X19J LITHIUM
 SET OF DECALS - X19J LITHIUM
 KIT COLLANTS - X19J LITHIUM

AUFKLEBERSATZ - X19J LITHIUM
 KIT ADHESIVOS - X19J LITHIUM
 ADHESIEKIT - X19J LITHIUM

cod. 17187700

Tav 01



9

4

17



13



KIT ADESIVI - X19J LITHIUM
 SET OF DECALS - X19J LITHIUM
 KIT COLLANTS - X19J LITHIUM

AUFKLEBERSATZ - X19J LITHIUM
 KIT ADHESIVOS - X19J LITHIUM
 ADHESIEKIT - X19J LITHIUM

cod. 17187700

Tav 02



9



16



1

4

4



5



KIT ADESIVI - X20JPLUS LITHIUM

SET OF DECALS - X20JPLUS LITHIUM

KIT COLLANTS - X20JPLUS LITHIUM

AUFKLEBERSATZ - X20JPLUS LITHIUM

KIT ADHESIVOS - X20JPLUS LITHIUM

ADHESIEKIT - X20JPLUS LITHIUM

cod. 17187700

Tav 01



9



13



4

18



3



KIT ADESIVI - X20JPLUS LITHIUM

SET OF DECALS - X20JPLUS LITHIUM

KIT COLLANTS - X20JPLUS LITHIUM

AUFKLEBERSATZ - X20JPLUS LITHIUM

KIT ADHESIVOS - X20JPLUS LITHIUM

ADHESIEKIT - X20JPLUS LITHIUM

cod. 17187700

Tav 02



5

4

13

9

KIT ADESIVI - X23J LITHIUM
 SET OF DECALS - X23J LITHIUM
 KIT COLLANTS - X23J LITHIUM

AUFKLEBERSATZ - X23J LITHIUM
 KIT ADHESIVOS - X23J LITHIUM
 ADHESIEKIT - X23J LITHIUM

cod. 17187700

Tav 01

Sotto il carter / Under the hood

18

4



18



1

16



4



9



KIT ADESIVI - X23J LITHIUM

SET OF DECALS - X23J LITHIUM

KIT COLLANTS - X23J LITHIUM

AUFKLEBERSATZ - X23J LITHIUM

KIT ADHESIVOS - X23J LITHIUM

ADHESIEKIT - X23J LITHIUM

cod. 17187700

Tav 02

PARTS FINDER

**Search Website
by Part Number**



**Search Manual
Library For Parts
Manual & Lookup Part
Numbers – Purchase
or Request Quote**

Search Manuals

Enter your information to help us find the right parts manual for your machine.

* Brand:

* Model:

* Serial:

* Part Number:

SEARCH

**Can't Find Part or
Manual? Request Help
by Manufacturer,
Model & Description**

Parts Order Form

Please fill in the following information to help us find the right part for your machine.

| | |
|---------------|----------------------|
| Manufacturer: | <input type="text"/> |
| Model: | <input type="text"/> |
| Description: | <input type="text"/> |
| Part Number: | <input type="text"/> |
| Quantity: | <input type="text"/> |
| Notes: | <input type="text"/> |

Discount-Equipment.com is your online resource for quality parts & equipment.

Florida: **561-964-4949** Outside Florida TOLL FREE: **877-690-3101**

Need parts?

Click on this link: <http://www.discount-equipment.com/category/5443-parts/> and choose one of the options to help get the right parts and equipment you are looking for. Please have the machine model and serial number available in order to help us get you the correct parts. If you don't find the part on the website or on one of the online manuals, please fill out the request form and one of our experienced staff members will get back to you with a quote for the right part that your machine needs.

We sell worldwide for the brands: Genie, Terex, JLG, MultiQuip, Mikasa, Essick, Whiteman, Mayco, Toro Stone, Diamond Products, Generac Magnum, Airman, Haulotte, Barreto, Power Blanket, Nifty Lift, Atlas Copco, Chicago Pneumatic, Allmand, Miller Curber, Skyjack, Lull, Skytrak, Tsurumi, Husquvarna Target, Stow, Wacker, Sakai, Mi-T-M, Sullair, Basic, Dynapac, MBW, Weber, Bartell, Bennar Newman, Haulotte, Ditch Runner, Menegotti, Morrison, Contec, Buddy, Crown, Edco, Wyco, Bomag, Laymor, EZ Trench, Bil-Jax, F.S. Curtis, Gehl Pavers, Heli, Honda, ICS/PowerGrit, IHI, Partner, Imer, Clipper, MMD, Koshin, Rice, CH&E, General Equipment, Amida, Coleman, NAC, Gradall, Square Shooter, Kent, Stanley, Tamco, Toku, Hatz, Kohler, Robin, Wisconsin, Northrock, Oztec, Toker TK, Rol-Air, APT, Wylie, Ingersoll Rand / Doosan, Innovatech, Con X, Ammann, Mecalac, Makinex, Smith Surface Prep, Small Line, Wanco, Yanmar

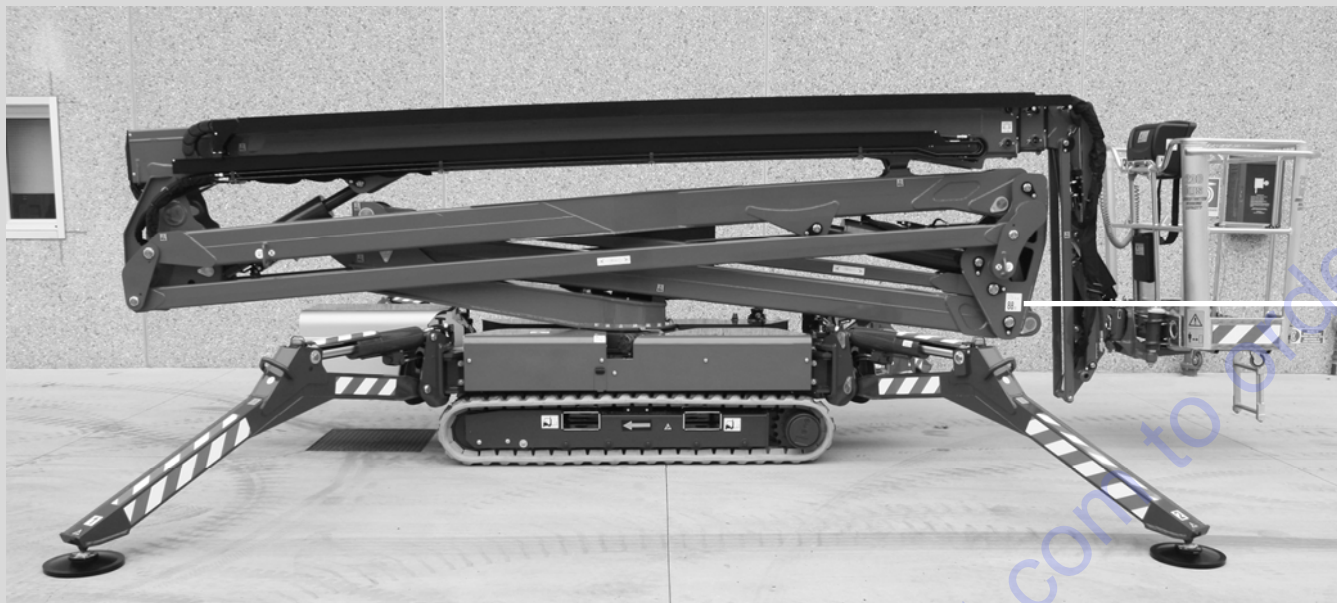

Fare foto della X26JPLUS lithium



9

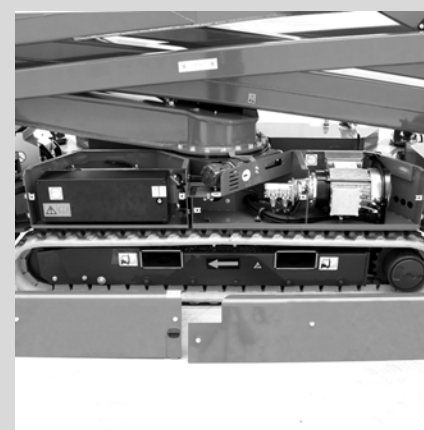

13



KIT ADESIVI - X26JPLUS LITHIUM

SET OF DECALS - X26JPLUS LITHIUM

KIT COLLANTS - X26JPLUS LITHIUM

AUFKLEBERSATZ - X26JPLUS LITHIUM

KIT ADHESIVOS - X26JPLUS LITHIUM

ADHESIEKIT - X26JPLUS LITHIUM

cod. 17187700

Tav 01

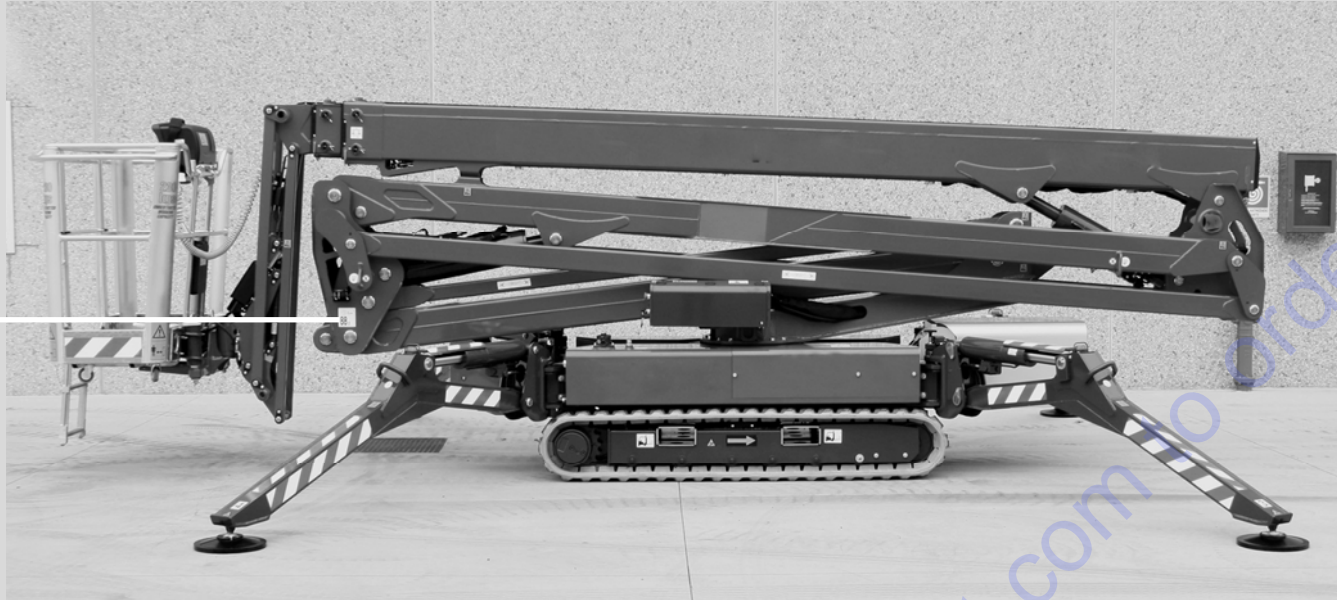

Fare foto della X26JPLUS lithium



KIT ADESIVI - X26JPLUS LITHIUM

SET OF DECALS - X26JPLUS LITHIUM

KIT COLLANTS - X26JPLUS LITHIUM

AUFKLEBERSATZ - X26JPLUS LITHIUM

KIT ADHESIVOS - X26JPLUS LITHIUM

ADHESIEKIT - X26JPLUS LITHIUM

cod. 17187700

Tav 02

Cod. 17187700

KIT INTEGRAZIONE ADESIVI PER PIATTAFORME AEREE LITHIUM-CE
INTEGRATION KIT STICKERS PLATFORMS LITHIUM-CE

X14J - X14J-H - X17J - X17JPLUS - X19J - X23J - X26JPLUS

Go to Discount-Equipment.com to order your parts

| | | |
|---|-----------------------------|------------|
| 17187700 POSIZIONE ADESIVI 7 LINGUE / POSITION LANGUAGE STICKERS | IN LINGUA / LANGUAGE | JLG |
| | VOLTAGGIO / VOLTAGE | |

| POS. | COD. | REV. | DESCRIZIONE / DESCRIPTION | Q.tà |
|------|------------|----------|---|------|
| 01 | | | | |
| 02 | | | | |
| 03 | | | | |
| 04 | 1001125483 | A | ADESIVO JLG VIETATO LAVARE L=63,5X63,5 MM | 03 |
| 05 | 06506400 | B | ADESIVO " CHIAVE DI ACCENSIONE" ESTERNO Ø 49 FORO Ø 22 SERIE LITHIUM ION | 01 |
| 06 | | | | |
| 07 | | | | |
| 08 | | | | 02 |
| 09 | 06520600 | B | ADESIVO RUMORE 88 dB L=90x100 | 02 |
| 10 | | | | |
| 11 | | | | |
| 12 | | | | |
| 13 | | | | |
| 14 | | | | |
| 15 | | | | |
| 16 | | | | |
| 17 | 07264700 | A | ADESIVO INDICATORE LED CARICABATTERIE 48V (Ø EST.31MM Ø INT.6 MM) VECCHIO BMS (FINO A C170000329) | 01 |
| | 07394800 | A | ADESIVO INDICATORE LED CARICABATTERIE 48V (Ø EST.31MM Ø INT.6 MM) NUOVO BMS/4 (DA C170000330) | 01 |
| 18 | 07264800 | A | ADESIVO INDICATORE LED RICARICA BATTERIE Ø EST.21MM Ø INT.4 MM | 02 |
| | | | | |

KIT ADESIVI IN LINGUA PER PER PIATTAFORME AEREE LITHIUM-CE
/ STICKERS KIT IN LANGUAGE FOR PLATFORMS FOR LITHIUM - CE

X14J - X14J-H - X17J - X17JPLUS - X19J - X20JPLUS - X23J - X26JPLUS

Cod.

171877IT
171877GB
171877FR
171877DE
171877ES
171877NL
171877PT
171877SW
171877DA
171877NO
171877JA

| | | |
|--|-----------------------------|------------|
| 171877** POSIZIONE ADESIVI IN LINGUA / POSITION LANGUAGE STICKERS | IN LINGUA / LANGUAGE | JLG |
| | VOLTAGGIO / VOLTAGE | |

| POS. | COD. | REV. | DESCRIZIONE / DESCRIPTION | Q.tà |
|----------------|------------|------|---|------|
| | 171877IT | | KIT ADESIVI INTEGR. PIATT. AEREA X14J-H- X14J - X17J - X19J X23J LITHIUM - LINGUA ITALIANO | |
| 01 | 07188700 | A | ADESIVO JLG ATTENZIONE PERICOLO BATTERIE - ITA L=210X145 MM | 01 |
| 07 | | | | |
| 10 | | | | |
| 11 | | | | |
| 12 | | | | |
| 13 | 07188100 | A | ADESIVO JLG RICARICARE LE BATTERIE DOPO L'USO O ALMENO OGNI 3 MESI L=50x50 MM – ITA | 01 |
| 14 | | | | |
| 16 solo X14J-H | 1693870003 | B | ADESIVO ISTRUZIONI DISCESA EMERGENZA GL1470LI ITALIANO GIALLO L=290x175 MM (**) | 01 |
| 16 solo X17J | 1705720001 | A | ADESIVO ISTRUZIONI DISCESA DI EMERGENZA GL14703S LITHIUM ITALIANO L=290X175 MM (**) | 01 |
| 16 | | | Per le / for X14J - X17JPLUS - X19J - X20JPLUS - X23J - X26JPLUS Vedere discesa di emergenza motore termico / See emergency lowering heat engine | |
| | 171877GB | | KIT ADESIVI INTEGR. PIATT. AEREA X14J-H- X14J - X17J - X19J X23J LITHIUM - LINGUA INGLESE | |
| 01 | 07201700 | A | ADESIVO JLG ATTENZIONE PERICOLO BATTERIE - ING L=210X145 MM | 01 |
| 07 | | | | |
| 10 | | | | |
| 11 | | | | |
| 12 | | | | |
| 13 | 07202100 | A | ADESIVO JLG-CE RICARICARE LE BATTERIE DOPO L'USO ALMENO OGNI 3 MESI - ING L=50x50 MM | 01 |
| 14 | | | | |
| 16 per X14J-H | 1693870004 | B | ADESIVO ISTRUZIONI DISCESA EMERGENZA GL1470LI INGLESE GIALLO L=290x175 MM | 01 |
| 16 per X17J | 1705720002 | A | ADESIVO ISTRUZIONI DISCESA DI EMERGENZA GL14703S LITHIUM INGLESE L=290X175 MM | 01 |
| 16 | | | Per le / for X14J - X17JPLUS - X19J - X20JPLUS - X23J - X26JPLUS Vedere discesa di emergenza motore termico / See emergency lowering heat engine | |

| | | |
|--|-----------------------------|------------|
| 171877** POSIZIONE ADESIVI IN LINGUA / POSITION LANGUAGE STICKERS | IN LINGUA / LANGUAGE | JLG |
| | VOLTAGGIO / VOLTAGE | |

| POS. | COD. | REV. | DESCRIZIONE / DESCRIPTION | Q.tà |
|---------------|------------|------|---|------|
| | 171877FR | | KIT ADESIVI INTEGR. PIATT. AEREA X14J-H- X14J - X17J - X19J X23J LITHIUM - LINGUA FRANCESE | |
| 01 | 07201800 | A | ADESIVO JLG ADESIVO ATTENZIONE PERICOLO BATTERIE - FRA L=210X145 MM | 01 |
| 07 | | | | |
| 10 | | | | |
| 11 | | | | |
| 12 | | | | |
| 13 | 07202200 | A | ADESIVO JLG RICARICARE LE BATTERIE DOPO L'USO ALMENO OGNI 3 MESI - FRA L=50x50 MM | 01 |
| 14 | | | | |
| 16 per X14J-H | 1693870005 | B | ADESIVO ISTRUZIONI DISCESA EMERGENZA GL1470LI FRANCESE GIALLO L=290x175 MM (**) | 01 |
| 16 per X17J | 1705720003 | A | ADESIVO ISTRUZIONI DISCESA DI EMERGENZA GL14703S LITHIUM FRANCESE L=290X175 MM (**) | 01 |
| 16 | / | / | Per le / for X14J - X17JPLUS - X19J - X20JPLUS - X23J - X26JPLUS Vedere discesa di emergenza motore termico / See emergency lowering heat engine | 01 |
| | | | | |
| | 171877DE | | KIT ADESIVI INTEGR. PIATT. AEREA X14J-H- X14J - X17J - X19J X23J LITHIUM - LINGUA TEDESCO | |
| 01 | 07188800 | A | ADESIVO JLG ATTENZIONE PERICOLO BATTERIE - TED L=210X145 MM | 01 |
| 07 | | | | |
| 10 | | | | |
| 11 | | | | |
| 12 | | | | |
| 13 | 07188200 | A | ADESIVO JLG RICARICARE LE BATTERIE DOPO L'USO O ALMENO OGNI 3 MESI L=50x50 MM –TED | 01 |
| 14 | | | | |
| 16 per X14J-H | 1693870006 | B | ADESIVO ISTRUZIONI DISCESA EMERGENZA GL1470LI TEDESCO GIALLO L=290x175 MM (**) | 01 |
| 16 per X17J | 1705720004 | A | ADESIVO ISTRUZIONI DISCESA DI EMERGENZA GL14703S LITHIUM TEDESCO L=290X175 MM (**) | 01 |
| 16 | / | / | Per le / for X14J - X17JPLUS - X19J - X20JPLUS - X23J - X26JPLUS Vedere discesa di emergenza motore termico / See emergency lowering heat engine | 01 |

| | | |
|--|-----------------------------|------------|
| 171877** POSIZIONE ADESIVI IN LINGUA / POSITION LANGUAGE STICKERS | IN LINGUA / LANGUAGE | JLG |
| | VOLTAGGIO / VOLTAGE | |

| POS. | COD. | REV. | DESCRIZIONE / DESCRIPTION | Q.tà |
|---------------|------------|------|---|------|
| | 171877ES | | KIT ADESIVI INTEGR. PIATT. AEREA X14J-H- X14J - X17J - X19J X23J LITHIUM - LINGUA SPAGNOLO | |
| 01 | 07201900 | A | ADESIVO JLG ATTENZIONE PERICOLO BATTERIE - SPA L=210X145 MM - | 01 |
| 07 | | | | |
| 10 | | | | |
| 11 | | | | |
| 12 | | | | |
| 13 | 07202300 | A | ADESIVO JLG RICARICARE LE BATTERIE DOPO L'USO ALMENO OGNI 3 MESI - SPA L=50x50 MM | 01 |
| 14 | | | | |
| 16 per X14J-H | 1693870007 | B | ADESIVO ISTRUZIONI DISCESA EMERGENZA GL1470LI SPAGNOLO GIALLO L=290x175 (**) | 01 |
| 16 per X17J | 1705720005 | A | ADESIVO ISTRUZIONI DISCESA DI EMERGENZA GL14703S LITHIUM SPAGNOLO L=290X175 MM (**) | 01 |
| 16 | | | Per le / for X14J - X17JPLUS - X19J - X20JPLUS - X23J - X26JPLUS Vedere discesa di emergenza motore termico / See emergency lowering heat engine | |
| | 171877NL | | KIT ADESIVI INTEGR. PIATT. AEREA X14J-H- X14J - X17J - X19J X23J LITHIUM - LINGUA OLANDESE | |
| 01 | 07188900 | A | ADESIVO JLG ATTENZIONE PERICOLO BATTERIE - OLA L=210X145 MM | 01 |
| 07 | | | | |
| 10 | | | | |
| 11 | | | | |
| 12 | | | | |
| 13 | 07188300 | A | ADESIVO JLG RICARICARE LE BATTERIE DOPO L'USO O ALMENO OGNI 3 MESI L=50x50 MM – OLA | 01 |
| 14 | | | | |
| 16 per X14J-H | 1693870008 | B | ADESIVO ISTRUZIONI DISCESA EMERGENZA GL1470LI OLANDESE GIALLO L=290x175 MM (**) | 01 |
| 16 per X17J | 1705720006 | A | ADESIVO ISTRUZIONI DISCESA DI EMERGENZA GL14703S LITHIUM OLANDESE L=290X175 MM (**) | 01 |
| 16 | | | Per le / for X14J - X17JPLUS - X19J - X20JPLUS - X23J - X26JPLUS Vedere discesa di emergenza motore termico / See emergency lowering heat engine | 01 |

| | | |
|--|-----------------------------|------------|
| 171877** POSIZIONE ADESIVI IN LINGUA / POSITION LANGUAGE STICKERS | IN LINGUA / LANGUAGE | JLG |
| | VOLTAGGIO / VOLTAGE | |

| POS. | COD. | REV. | DESCRIZIONE / DESCRIPTION | Q.tà |
|---------------|------------|------|---|------|
| | 171877PT | | KIT ADESIVI INTEGR. PIATT. AEREA X14J-H-X14J-X17J-X19J-X23J LITHIUM - LINGUA PORTOGHESE | |
| 01 | 07202000 | A | ADESIVO JLG ATTENZIONE PERICOLO BATTERIE - POR L=210X145 MM | 01 |
| 07 | | | | |
| 10 | | | | |
| 11 | | | | |
| 12 | | | | |
| 13 | 07202400 | A | ADESIVO JLG RICARICARE LE BATTERIE DOPO L'USO O ALMENO OGNI 3 MESI L=50x50 MM – POR | 01 |
| 14 | | | | |
| 16 per X14J-H | 1693870009 | B | ADESIVO ISTRUZIONI DISCESA EMERGENZA GL1470LI PORTOGHESE GIALLO L=290x175 MM (**) | 01 |
| 16 per X17J | 1705720007 | A | ADESIVO ISTRUZ. DISCESA DI EMERGENZA GL14703S LITHIUM PORTOGHESE L=290X175 MM (**) | 01 |
| 16 | | | Per le / for X14J - X17JPLUS - X19J - X20JPLUS - X23J - X26JPLUS Vedere discesa di emergenza motore termico / See emergency lowering heat engine | |
| | 171877SW | | KIT ADESIVI INTEGR. PIATT. AEREA X14J-H-X14J-X17J-X19J-X23J LITHIUM - SVEDESE | |
| 01 | 07189000 | A | ADESIVO JLG ATTENZIONE PERICOLO BATTERIE - SVE L=210X145 MM | 01 |
| 07 | | | | |
| 10 | | | | |
| 11 | | | | |
| 12 | | | | |
| 13 | 07188400 | A | ADESIVO JLG RICARICARE LE BATTERIE DOPO L'USO O ALMENO OGNI 3 MESI L=50x50 MM – SVE | 01 |
| 14 | | | | |
| 16 per X14J-H | 1693870010 | A | ADESIVO ISTRUZIONI DISCESA EMERGENZA GL1470LI SVEDESE GIALLO L=290x175 MM (**) | 01 |
| 16 per X17J | 1705720010 | A | ADESIVO ISTRUZ. DISCESA DI EMERGENZA GL14703S LITHIUM SVEDESE L=290X175 MM (**) | 01 |
| 16 | | | Per le / for X14J - X17JPLUS - X19J - X20JPLUS - X23J - X26JPLUS Vedere discesa di emergenza motore termico / See emergency lowering heat engine | |

| | | |
|--|-----------------------------|------------|
| 171877** POSIZIONE ADESIVI IN LINGUA / POSITION LANGUAGE STICKERS | IN LINGUA / LANGUAGE | JLG |
| | VOLTAGGIO / VOLTAGE | |

| POS. | COD. | REV. | DESCRIZIONE / DESCRIPTION | Q.tà |
|---------------|------------|------|---|------|
| | 171877DA | | KIT ADESIVI INTEGR. PIATT. AEREA X14J-H-X14J-X17J-X19J-X23J LITHIUM - LINGUA DANESE | |
| 01 | 07189100 | A | ADESIVO JLG ATTENZIONE PERICOLO BATTERIE - DAN L=210X145 MM | 01 |
| 07 | | | | |
| 10 | | | | |
| 11 | | | | |
| 12 | | | | |
| 13 | 07188500 | A | ADESIVO JLG RICARICARE LE BATTERIE DOPO L'USO O ALMENO OGNI 3 MESI L=50x50 MM – DAN | 01 |
| 14 | | | | |
| 16 per X14J-H | 1693870011 | A | ADESIVO ISTRUZIONI DISCESA EMERGENZA GL1470LI SVEDESE DANESE L=290x175 MM (**) | 01 |
| 16 per X17J | 1705720011 | A | ADESIVO ISTRUZ. DISCESA DI EMERGENZA GL14703S LITHIUM DANESE L=290X175 MM (**) | 01 |
| 16 | | | Per le / for X14J - X17JPLUS - X19J - X20JPLUS - X23J - X26JPLUS Vedere discesa di emergenza motore termico / See emergency lowering heat engine | |
| | 171877NO | | KIT ADESIVI INTEGR. PIATT. AEREA X14J-H-X14J-X17J-X19J-X23J LITHIUM - LINGUA NORVEGESE | |
| 01 | 07189200 | A | ADESIVO JLG ATTENZIONE PERICOLO BATTERIE - NOR L=210X145 MM | 01 |
| 07 | | | | |
| 10 | | | | |
| 11 | | | | |
| 12 | | | | |
| 13 | 07188600 | A | ADESIVO JLG RICARICARE LE BATTERIE DOPO L'USO O ALMENO OGNI 3 MESI L=50x50 MM – NOR | 01 |
| 14 | | | | |
| 16 per X14J-H | 1693870012 | A | ADESIVO ISTRUZIONI DISCESA EMERGENZA GL1470LI NORVEGESE GIALLO L=290x175 MM (**) | 01 |
| 16 per X17J | 1705720012 | A | ADESIVO ISTRUZ. DISCESA DI EMERGENZA GL14703S LITHIUM NORVEGESE L=290X175 MM (**) | 01 |
| 16 | / | / | Per le / for X14J - X17JPLUS - X19J - X20JPLUS - X23J - X26JPLUS Vedere discesa di emergenza motore termico / See emergency lowering heat engine | |

171877 POSIZIONE ADESIVI IN LINGUA /**
POSITION LANGUAGE STICKERS

IN LINGUA / LANGUAGE

JLG

VOLTAGGIO / VOLTAGE

| POS. | COD. | REV. | DESCRIZIONE / DESCRIPTION | Q.tà |
|---------------|----------|------|---|------|
| | 171877JA | | KIT ADESIVI INTEGR. PIATT. AEREA X14J-H- X14J - X17J - X19J X23J LITHIUM - LINGUA GIAPPONESE | |
| 01 | 07341100 | A | ADESIVO JLG-ANSI ATTENZIONE PERICOLO BATTERIE - JAPAN L=210X145 MM | 01 |
| 07 | | | | |
| 10 | | | | |
| 11 | | | | |
| 12 | | | | |
| 13 | 07341200 | A | ADESIVO JLG-CE RICARICARE LE BATTERIE DOPO L'USO - JAPAN L=50x50 MM | 01 |
| 14 | | | | |
| 16 per X14J-H | | | | 01 |
| 16 per X17J | | | | |
| 16 | / | / | Per le / for X14J - X17JPLUS - X19J - X20JPLUS - X23J - X26JPLUS Vedere discesa di emergenza motore termico / See emergency lowering heat engine | |
| | 171877PL | | KIT ADESIVI INTEGR. PIATT. AEREA X14J-H- X14J - X17J - X19J X23J LITHIUM - LINGUA GIAPPONESE | |
| 01 | 07508000 | A | ADESIVO JLG-ANSI ATTENZIONE PERICOLO BATTERIE - POLACCO L=210X145 MM | 01 |
| 07 | | | | |
| 10 | | | | |
| 11 | | | | |
| 12 | | | | |
| 13 | 07508100 | A | ADESIVO JLG-CE RICARICARE LE BATTERIE DOPO L'USO - POLACCO L=50x50 MM | 01 |
| 14 | | | | |
| 16 per X14J-H | | | | 01 |
| 16 per X17J | | | | |
| 16 | / | / | Per le / for X14J - X17JPLUS - X19J - X20JPLUS - X23J - X26JPLUS Vedere discesa di emergenza motore termico / See emergency lowering heat engine | |
| | | | | |

Cod. 17224100

**KIT ADESIVI SICUREZZA PIATTAFORMA AEREA /
AERIAL PLATFORM KIT STICKERS SAFETY**

JLG/ANSI - X500AJ

+ kit in lingua non inclusi nel codice generale

+ language code not included in the standard kit

172241GB

172241FR

172241ES

172241PT

DA USARE CON / FOR USE WITH

- **17224200 KIT ADESIVI COMMERCIALI PIATTAFORMA AEREA X500AJ ANSI /
STICKERS KIT COMMERCIAL AERIAL PLATFORM**
- **17107300 KIT ADESIVI INTEGRZIONE PER PIATTAFORME AEREE JLG-ANSI LITHIUM /
STICKER KITS FOR INTEGRATION PLATFORMS JLG-ANSI LITHIUM /
X390AJ - X500AJ - X550AJ - X600AJ - X700AJ - X770AJ**
- **171073** KIT IN LINGUA / KIT IN LANGUAGE**

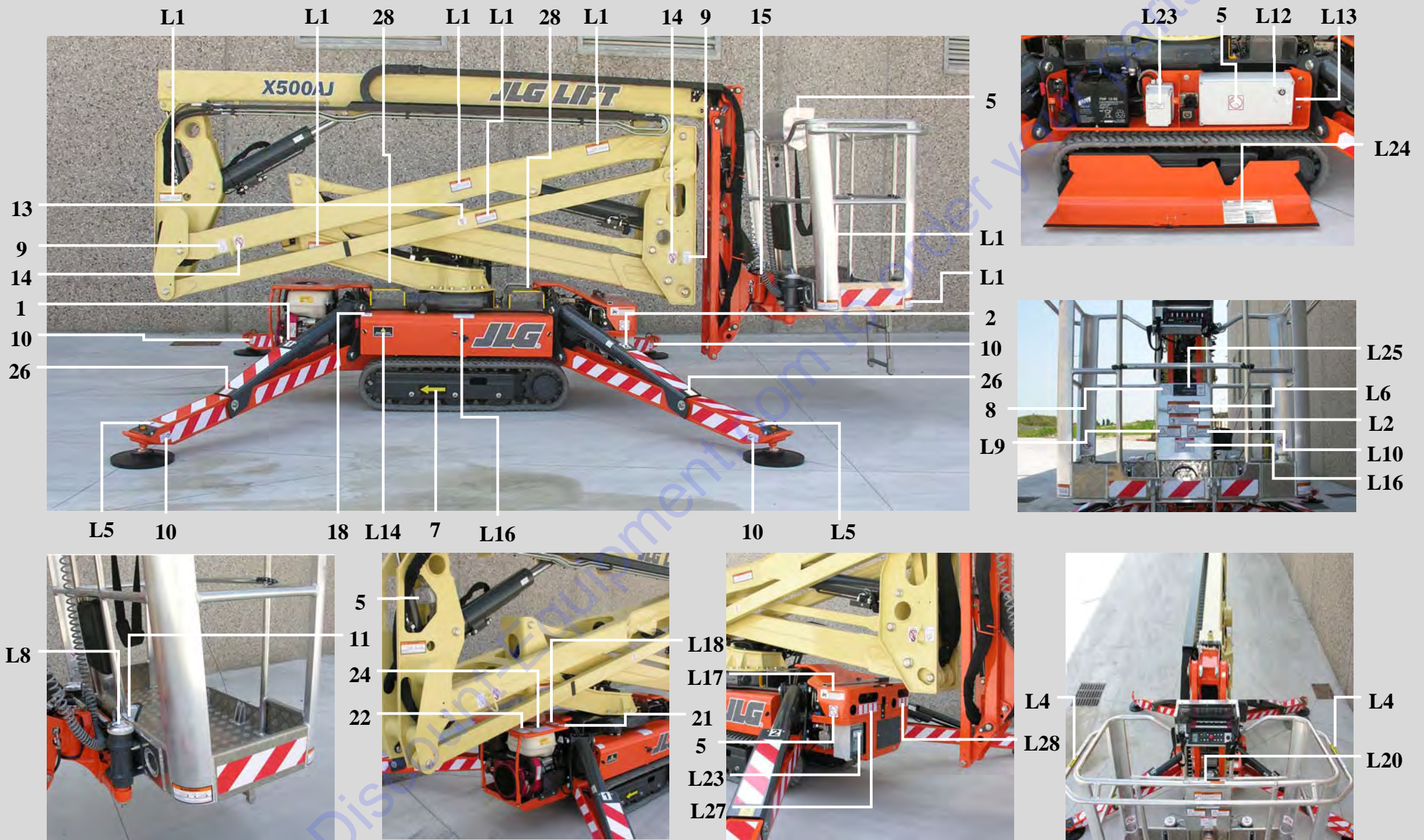

KIT ADESIVI - X500AJ

SET OF DECALS - X500AJ

KIT COLLANTS - X500AJ

AUFKLEBERSATZ - X500AJ

KIT ADHESIVOS - X500AJ

ADHESIEKIT - X500AJ

Cod. 17224100

Tav 01

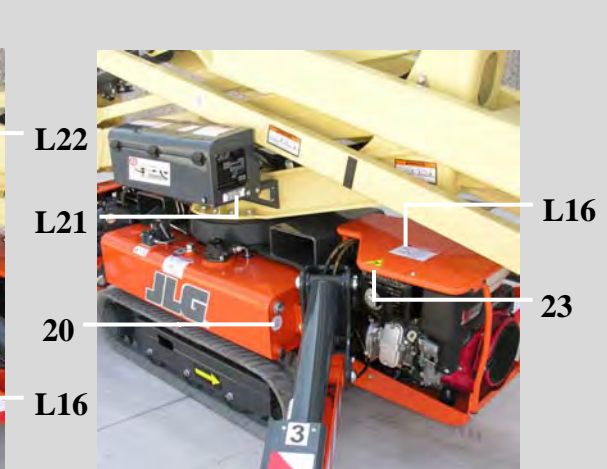
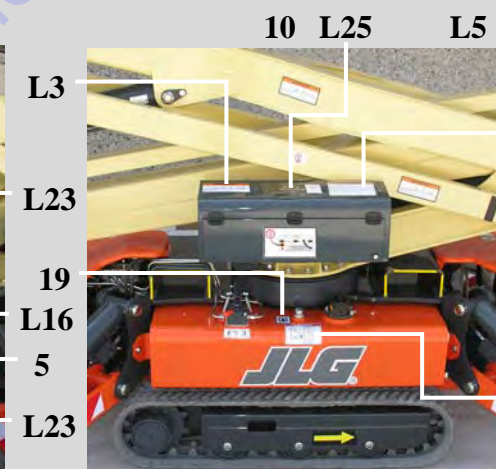
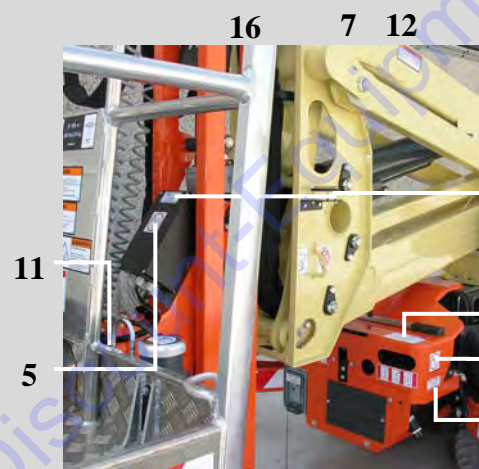
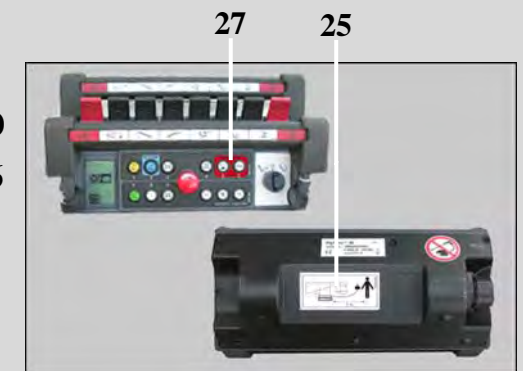
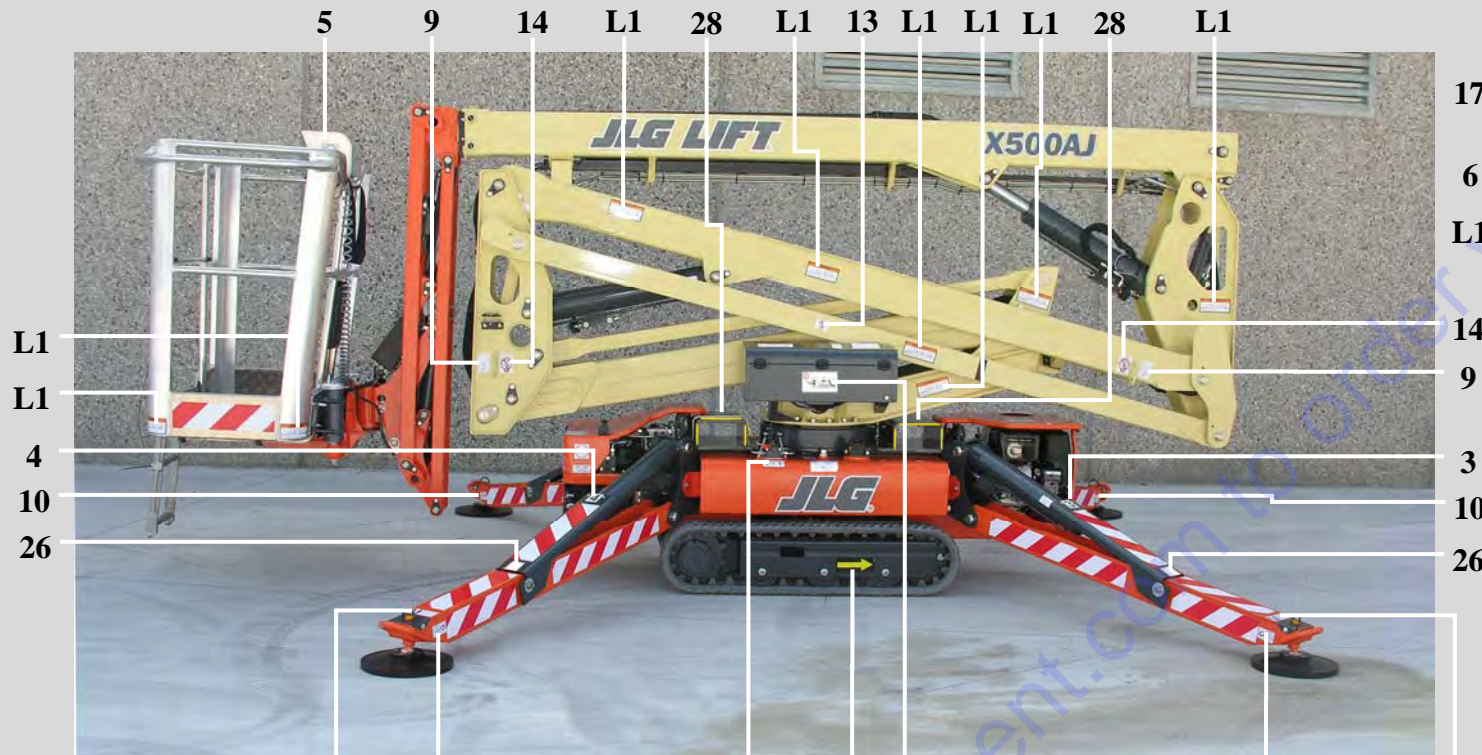

KIT ADESIVI - X500AJ

SET OF DECALS - X500AJ

KIT COLLANTS - X500AJ

AUFKLEBERSATZ - X500AJ

KIT ADHESIVOS - X500AJ

ADHESIEKIT - X500AJ

Cod. 17224100

Tav 02

Cod. 17224100

**KIT ADESIVI PIATTAFORMA AEREA /
AERIAL PLATFORM KIT STICKERS
JLG/ANSI - X500AJ**

Go to Discount-Equipment.com to order your parts

17224100 POSIZIONE ADESIVI / POSITION STICKERS**IN LINGUA / LANGUAGE****JLG****VOLTAGGIO / VOLTAGE**

| POSIZIONE | CODICE | REV. | DESCRIZIONE | QUANTITA' |
|-----------|------------|------|---|-----------|
| 01 | 06555500 | A | ADESIVO NR 1 L=50X60 BIANCO | 01 |
| 02 | 06555600 | A | ADESIVO NR 2 L=50X60 BIANCO | 01 |
| 03 | 06555700 | A | ADESIVO N° 3 L=50X60 BIANCO | 01 |
| 04 | 06555800 | A | ADESIVO N° 4 L=50X60 BIANCO | 01 |
| 05 | 1001125483 | A | ADESIVO JLG VIETATO LAVARE L=63,5X63,5 MM | 06 |
| 06 | 1706898 | A | ADESIVO JLG EMERGENCY STOP Ø EST.57,15 Ø INT. 30,58 | 01 |
| 07 | 06040500 | A | ADESIVO DIREZ. TRASLAZIONE FRECCIA GIALLA SFONDO NERO L=61 X 160 | 02 |
| 08 | 1701640 | A | ADESIVO JLG LEGGERE IL MANUALE L= 69,85x69,85 MM | 01 |
| 09 | 1703814 | A | ADESIVO JLG ATTACCO ANCORAGGIO L=55,56X76,2 MM | 04 |
| 10 | 07071200 | A | ADESIVO JLG PUNTO DI SOLLEVAMENTO L= 40X66 MM | 08 |
| 11 | 1704277 | A | ADESIVO JLG ATTACCO CINTURE DI SICUREZZA L= 76,2X19,05 MM | 02 |
| 12 | 07506500 | A | ADESIVO JLG - EMERGENCY STOP L= 170X100 MM | 01 |
| 13 | 07056700 | A | ADESIVO JLG DIVIETO DI SOLLEVAMENTO L=40X54,88 | 02 |
| 14 | 1701499 | A | ADESIVO JLG DIVIETO DI SOLLEVAMENTO DAL PUNTO DI ANCORAGGIO L= 55,56X76 MM (**) | 04 |
| 15 | 06706500 | A | ADESIVO ALLINEAMENTO CESTO (2 PEZZI) L=16X50+13 | 01 |
| 16 | 06998800 | A | ADESIVO DEVIATORE POMPA MANUALE PIATTAFORMA GL17.80XL L=86X34 | 01 |
| 17 | 07242000 | A | ADESIVO SELETTORE 3 POSIZIONI 2° TELECOMANDO | 01 |
| 18 | 1702155 | A | ADESIVO JLG STACCABATTERIA L= 63,5X50,80 MM | 01 |
| 19 | 1701504 | A | ADESIVO JLG OLIO IDRAULICO L=50,8x63,5 MM | 01 |
| 20 | 06165000 | A | ADESIVO LIVELLO OLIO IDRAULICO Ø50 SFONDO BIANCO | 01 |
| 21 | 06060000 | A | ADESIVO LIVELLO OLIO MOTORE Ø50mm | 01 |
| 22 | 1701542 | A | ADESIVO JLG CARBURANTE BENZINA L= 101X63,5 | 01 |
| | 1701505 | A | ADESIVO JLG CARBURANTE DIESEL L= 50,8X63,5 | 01 |
| 23 | 06056300 | A | ADESIVO PERICOLO SCOTTATURE L=60X51 TRIANGOLARE SFONDO GIALLO | 01 |

| | | |
|---|-----------------------------|------------|
| 17224100 POSIZIONE ADESIVI / POSITION STICKERS | IN LINGUA / LANGUAGE | JLG |
| | VOLTAGGIO / VOLTAGE | |

| POSIZIONE | CODICE | REV. | DESCRIZIONE | QUANTITA' |
|-----------|----------|----------|---|-----------|
| 24 | 06232100 | B | ADESIVO ATTENZIONE BENZINA INFIAMMABILE L=170X42 MM | 01 |
| 25 | 07240300 | B | ADESIVO DISTANZA 1m SU TELE/RADIO COMANDI | 01 |
| 26 | 07242100 | B | ADESIVO REAZIONE AL SUOLO STABILIZZATORI X500AJ L50X50 - BIANCO | 04 |
| 27 | 07071000 | B | ADESIVO JLG CLAXON SU PIATTAFORME L=38,3X28,55 | 01 |
| 28 | 07350300 | A | ADESIVO SOLLEVAMENTO PIATTAFORMA CON MULETTO L=90X70 MM | 04 |
| 29 | | | | |
| 30 | | | | |
| 31 | | | | |
| 32 | | | | |
| 33 | | | | |
| 34 | | | | |
| 35 | | | | |
| 36 | | | | |
| 37 | | | | |
| 38 | | | | |
| 39 | | | | |
| 40 | | | | |
| 41 | | | | |
| 42 | | | | |
| 43 | | | | |
| 44 | | | | |
| 45 | | | | |
| 46 | | | | |
| 47 | | | | |

**KIT ADESIVI IN LINGUA /
LANGUAGEKIT STICKERS
JLG/ANSI - X500AJ**

Cod.

172241GB

172241FR

172241ES

172241PT

Go to Discount-Equipment.com to order your parts

| | | |
|---|-----------------------------|------------|
| 172241** ADESIVI IN LINGUA / ADHESIVES IN LANGUAGE | IN LINGUA / LANGUAGE | JLG |
| | VOLTAGGIO / VOLTAGE | |

| POSIZIONE | CODICE | REV. | DESCRIZIONE | QUANTITA' |
|-----------|----------|------|---|-----------|
| | 172241GB | | KIT ADESIVI SICUREZZA PIATTAFORMA AEREA X500AJ ANSI LINGUA INGLESE | |
| L1 | 07056100 | A | ADESIVO JLG PERICOLO SCHIACCIAMENTO L= 140x60,71 MM | 14 |
| L2 | 1706387 | A | ADESIVO JLG PERICOLO SCHIACCIAMENTO L=177,80x69,85 MM (SUL CESTO) | 01 |
| L3 | 1706099 | A | ADESIVO JLG PERICOLO SCHIACCIAMENTO L= 161,92X69,85 MM (A TERRA) | 01 |
| L4 | 1702868 | B | ADESIVO JLG PERICOLO SCHIACCIAMENTO MANO L= 241,30X25.40 MM (SUL CESTO) | 02 |
| L5 | 07056200 | A | ADESIVO JLG ATTACCO SCHIACCIAMENTO ARTO INFERIORE L= 110x60 (PRES. STABILIZZATORI) | 04 |
| L6 | 1706386 | A | ADESIVO JLG PERICOLO CADUTE L=196,85x76,2 MM | 01 |
| L7 | 07051100 | A | ADESIVO JLG PERICOLO CADUTA - RIPRISTINARE I TAPPI L=196,5x35 MM | 01 |
| L8 | 07051000 | A | ADESIVO JLG PERICOLO DI CADUTA - SBLOCCARE SOLO NEI CASI PREVISTI L= 50X50 MM | 02 |
| L9 | 1706133 | C | ADESIVO JLG PERICOLO RIBALTAMENTO L=139,7X68,85 MM | 01 |
| L10 | 07058600 | A | ADESIVO JLG POSIZIONE STABILIZZATORI X390, X550 | 01 |
| L11 | 07349200 | A | ADESIVO AVVIAMENTO MOTORE DA TERRA LL2010 IIIS L=76,5X37 MM | 01 |
| L12 | 07042100 | A | ADESIVO JLG SISTEMA BYPASS PARTE AEREA L=30X50 | 01 |
| L13 | 07042200 | A | ADESIVO JLG SISTEMA BYPASS TRASLAZIONE L= 30X50 | 01 |
| L14 | 1702901 | A | ADESIVO JLG ISTRUZIONI DISCESA EMERGENZA / POMPA MAUALE L=114,3x58,73MM | 01 |
| L15 | 3252347 | B | ADESIVO JLG ATTENZIONE PEDALE L= 69,85x57,15 MM | 01 |
| L16 | 1706128 | E | ADESIVO JLG PERICOLO DI FOLGORAZIONE L=120,65x91,50 MM | 05 |
| L17 | 1703813 | A | ADESIVO JLG PERICOLO ESLOSIONE BATTERIE L=149,25X47,62 MM | 01 |
| L18 | 1704972 | C | ADESIVO JLG PERICOLO ESPLOSIONE L=63,5x92,07 MM | 01 |
| L19 | | | | |
| L20 | 1706385 | C | ADESIVO JLG SCORRIMENTO SBARRA CHIUSURA CESTO L=184,15X25,4 MM | 01 |
| L21 | 1705514 | A | ADESIVO JLG CONFORMITA' CSA L= 76,20x22,22 MM | 01 |
| L22 | 1706135 | B | ADESIVO JLG USO PIATTAFORMA (GB) L=139,70x88,90 MM | 01 |
| L23 | 07056400 | B | ADESIVO JLG PERICOLO 120V - 60HZ L= 75x32,68 MM | 04 |

AGGIORNATO IL / UPDATED 10/01/2014

Cod. 17224200

KIT ADESIVI COMMERCIALI PIATTAFORMA AEREA
AERIAL PLATFORM KIT STICKERS COMMERCIAL
JLG-X500AJ

DA USARE CON / FOR USE WITH

- **17224100 KIT ADESIVI SICUREZZA PIATTAFORMA AEREA / AERIAL PLATFORM SECURITY STICKERS KIT JLG - X500AJ**

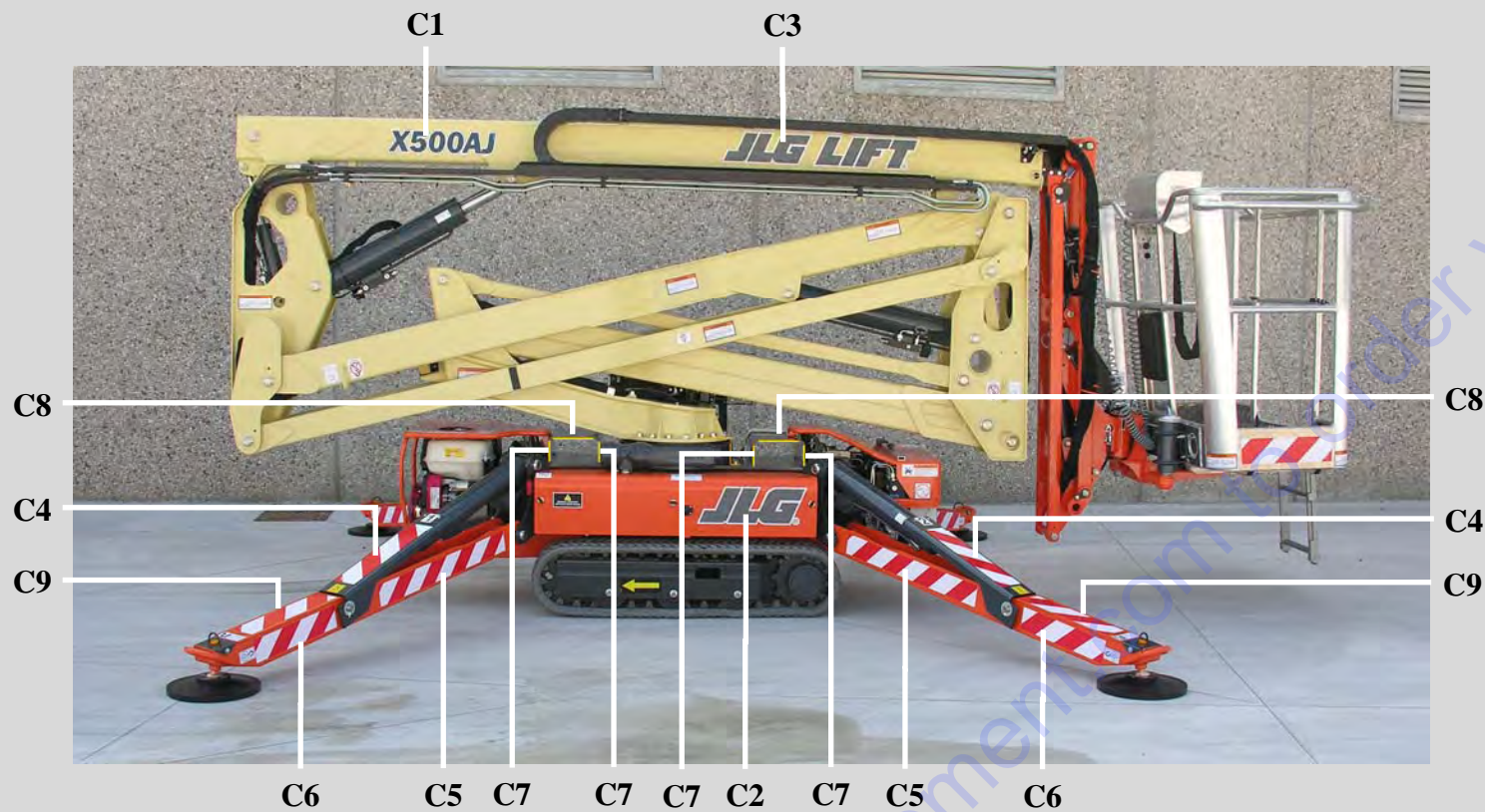

KIT ADESIVI - X500AJ

SET OF DECALS - X500AJ

KIT COLLANTS - X500AJ

AUFKLEBERSATZ - X500AJ

KIT ADHESIVOS - X500AJ

ADHESIEKIT - X500AJ

cod. 17224200

Ed. 10/01/2014

Tav 01

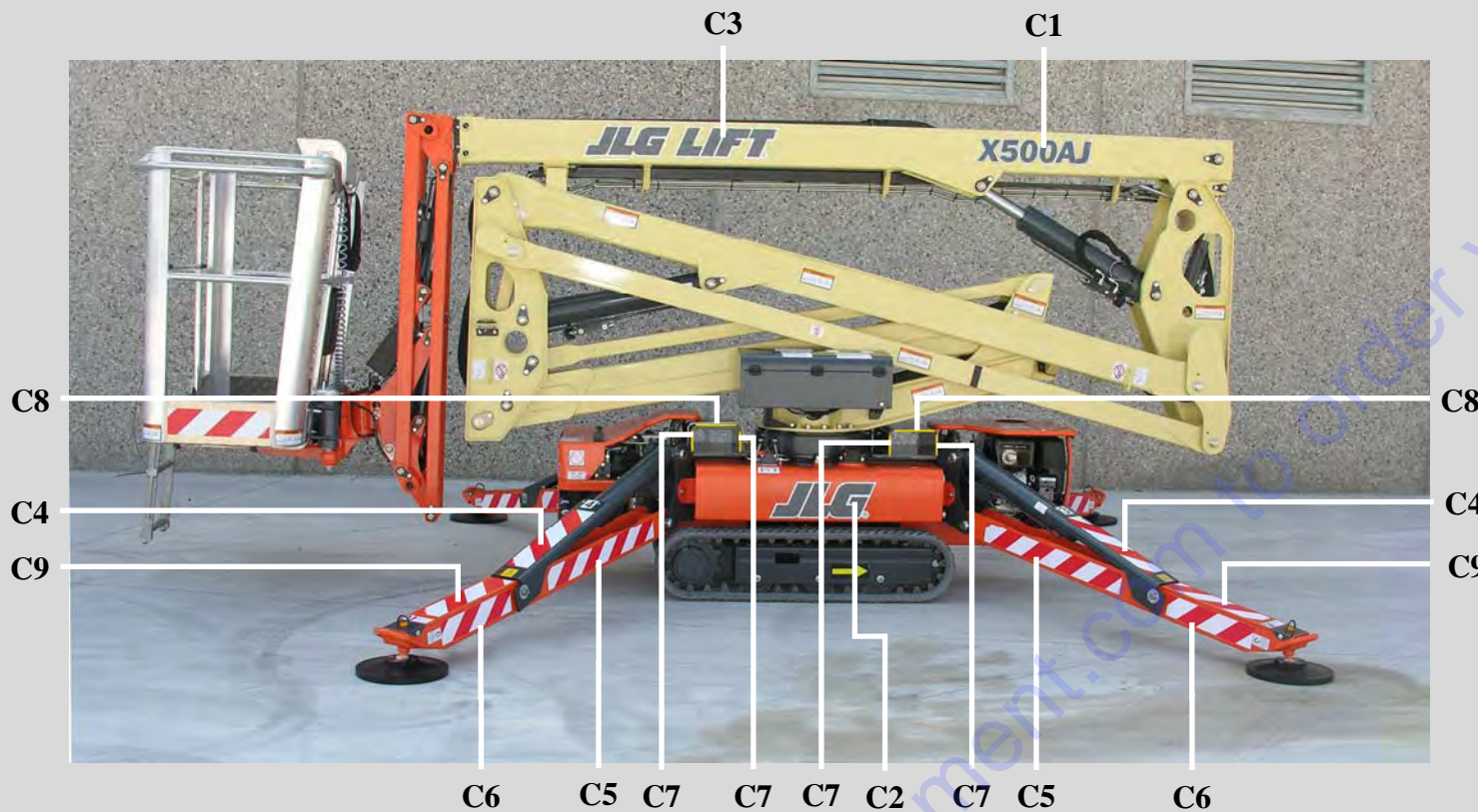

C8



C4

C9



C4



KIT ADESIVI - X500AJ

SET OF DECALS - X500AJ

KIT COLLANTS - X500AJ

AUFKLEBERSATZ - X500AJ

KIT ADHESIVOS - X500AJ

ADHESIEKIT - X500AJ

cod. 17224200

Ed. 10/01/2014

Tav 02

17224200 POSIZIONE ADESIVI / POSITION ADHESIVE Aggiornato il / Updated 10/01/2014

| POS. | COD. | REV. | DESCRIZIONE / DESCRIPTION | Q.tà |
|------|------------|------|--|------|
| C1 | 1722420001 | A | ADESIVO LOGO X500AJ COLORE GRIGIO PANTONE 432C L=200X43 MM | 02 |
| C2 | 07060500 | A | ADESIVO JLG LOGO JLG COLORE GRIGIO PANTONE 432C L=432x150MM (**) | 02 |
| C3 | 07060700 | A | ADESIVO JLG LOGO JLG LIFT COLORE GRIGIO PANTONE 432C L=809x130 MM (**) | 02 |
| C4 | 06086700 | A | ADESIVO CON RIGHE BIANCHE E ROSSE L=430X100 (**) | 06 |
| C5 | 06039700 | A | ADESIVO CON RIGHE BIANCHE ROSSE L= 700 X 80 (**) | 09 |
| C6 | 06436900 | A | ADESIVO CON RIGHE BIANCHE ROSSE L= 375 X 80 MM (**) | 08 |
| C7 | 07268300 | A | ADESIVO ATTENZIONE SOLLEVAMENTO FORCHE L= 80X7 MM | 08 |
| C8 | 07268400 | A | ADESIVO ATTENZIONE SOLLEVAMENTO FORCHE L= 180X7 MM | 04 |
| C9 | 07281100 | A | ADESIVO CON RIGHE BIANCHE E ROSSE L=380X100 MM | 04 |
| C10 | | | | |
| C11 | | | | |
| C12 | | | | |
| C13 | | | | |
| C14 | | | | |
| C15 | | | | |
| C16 | | | | |
| C17 | | | | |
| C18 | | | | |
| C19 | | | | |
| C20 | | | | |
| C21 | | | | |
| C22 | | | | |
| C23 | | | | |
| C24 | | | | |

AGGIORNATO IL / Updated 30/09/2015

Cod. 17242800

**KIT ADESIVI SICUREZZA PIATTAFORMA AEREA /
AERIAL PLATFORM KIT STICKERS SAFETY
X17JPLUS**

+ kit in lingua non inclusi nel codice generale

+ language code not included in the standard kit

**172428IT / 172428GB / 172428FR / 172428DE / 172428ES / 172428NL /
172428PT / 172428DA / 172428SW / 172428NO / 172428PL**

DA USARE CON / FOR USE WITH

**17242900 KIT ADESIVI COMMERCIALI PIATTAFORMA AEREA X17JPLUS /
STICKER KITS COMMERCIAL AERIAL PLATFORM X17JPLUS**

**17187700 KIT INTEGRAZIONE ADESIVI PER PIATTAFORME LITHIUM /
STICKER KIT INTEGRATION FOR PLATFORM LITHIUM
X14J_14J-H_X17J_17JPLUS _X19J_X20JPLUS_X23J**

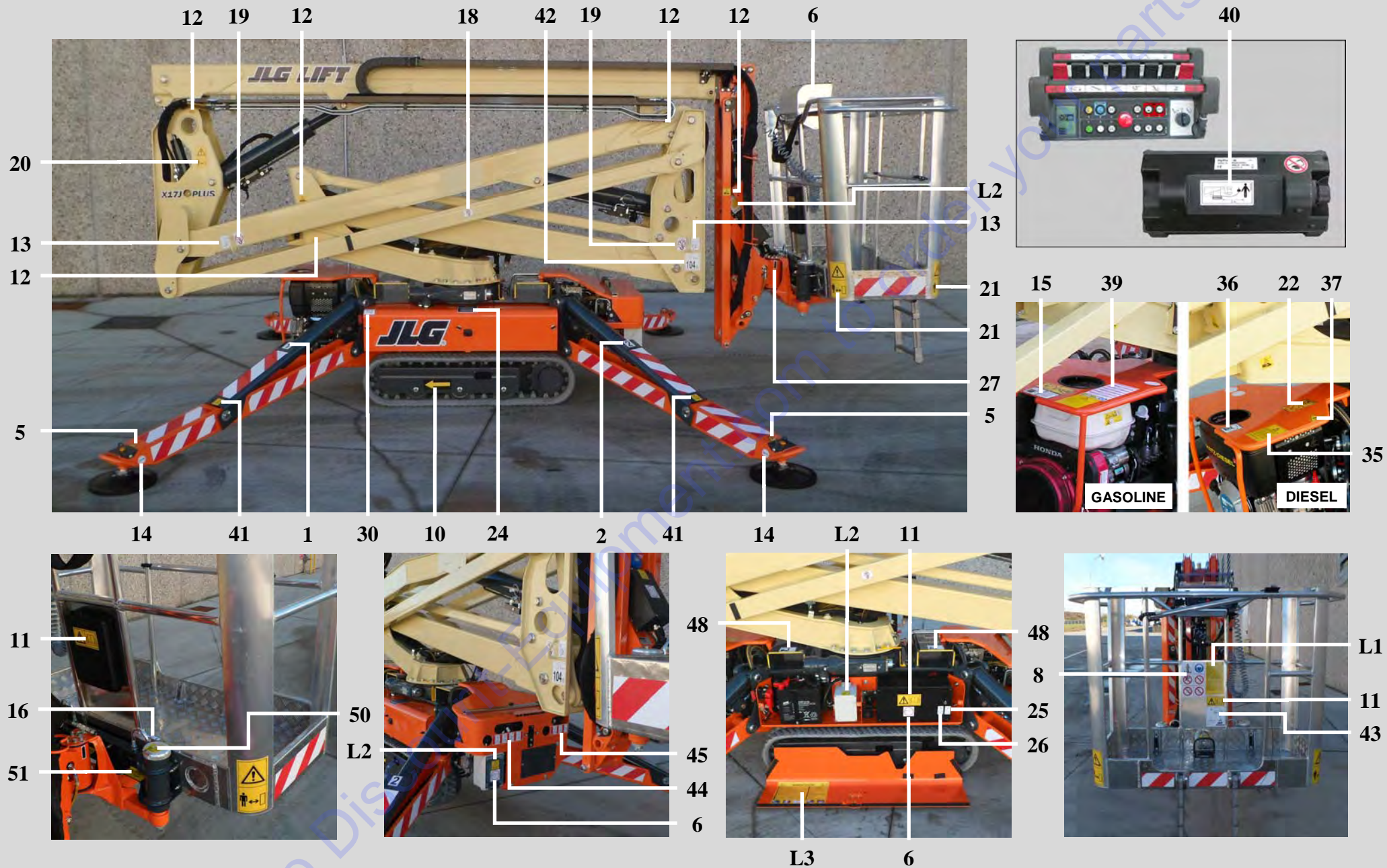

KIT ADESIVI - X17JPLUS

SET OF DECALS - X17JPLUS

KIT COLLANTS - X17JPLUS

AUFKLEBERSATZ - X17JPLUS

KIT ADHESIVOS - X17JPLUS

ADHESIEKIT - X17JPLUS

Cod. 17242800

Tav 01

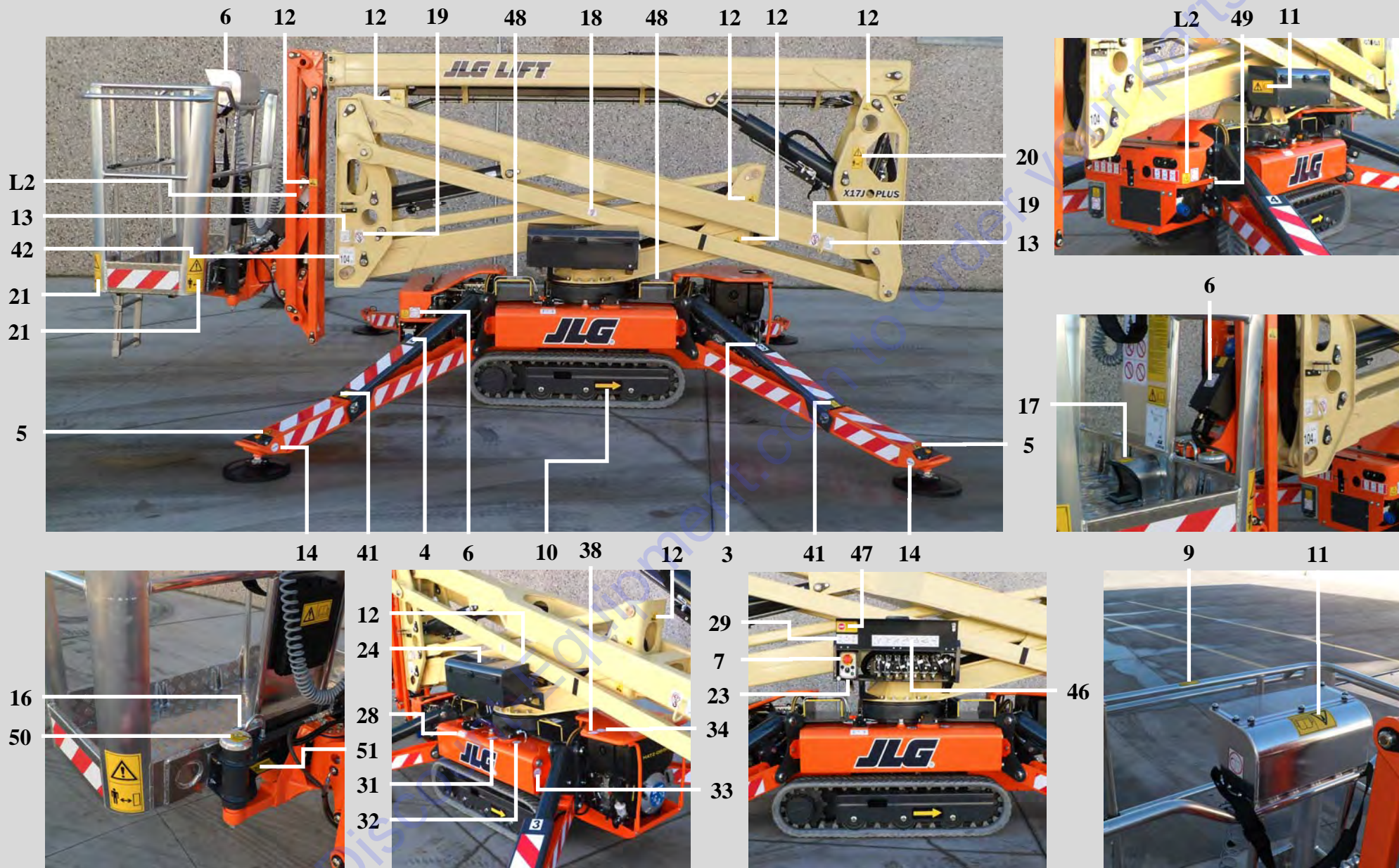

KIT ADESIVI - X17JPLUS

SET OF DECALS - X17JPLUS

KIT COLLANTS - X17JPLUS

AUFKLEBERSATZ - X17JPLUS

KIT ADHESIVOS - X17JPLUS

ADHESIEKIT - X17JPLUS

Cod. 17242800

Tav 02

Cod. 17242800

**KIT ADESIVI SICUREZZA PIATTAFORMA AEREA /
AERIAL PLATFORM KIT STICKERS SAFETY
X17JPLUS**

Go to Discount-Equipment.com to order your parts

17242800 POSIZIONE ADESIVI / POSITION ADHESIVE

JLG

| POS. | COD. | REV. | DESCRIZIONE / DESCRIPTION | Q.tà |
|------|------------|----------|---|------|
| 01 | 06555500 | A | ADESIVO NR 1 L=50X60 BIANCO | 01 |
| 02 | 06555600 | A | ADESIVO NR 2 L=50X60 BIANCO | 01 |
| 03 | 06555700 | A | ADESIVO N° 3 L=50X60 BIANCO | 01 |
| 04 | 06555800 | A | ADESIVO N° 4 L=50X60 BIANCO | 01 |
| 05 | 06041200 | A | ADESIVO SCHIACCIAMENTO PIEDI TRIANGOLARE L=53X46 GIALLO | 04 |
| 06 | 1001125483 | A | ADESIVO JLG VIETATO LAVARE L=63,5X63,5 MM (**) | 06 |
| 07 | 1706898 | A | ADESIVO JLG EMERGENCY STOP Ø EST.57,15 Ø INT. 30,58 (**) | 01 |
| 08 | 06924300 | A | ADESIVO CASCO - IMBRAGATURA - DIVIETI SERIE METAL-IIIS L= 170X250 MM | 01 |
| 09 | 1706493 | B | ADESIVO JLG SCORRIMENTO SBARRA CHIUSURA CESTO L= 76,2X25,4 MM (**) | 01 |
| 10 | 06040500 | A | ADESIVO DIREZ. TRASLAZIONE FRECCIA GIALLA SFONDO NERO L=61 X 160 | 02 |
| 11 | 06040900 | A | ADESIVO LEGGERE IL MANUALE L=125 X 65 GIALLO | 05 |
| 12 | 06041300 | B | ADESIVO ATTENZIONE PERICOLO TAGLI L=35 X 40 MM GIALLO (**) | 13 |
| 13 | 1703814 | A | ADESIVO JLG ATTACCO ANCORAGGIO L=55,56X76,2 MM (**) | 04 |
| 14 | 06044000 | A | ADESIVO ATTACCO SOLLEVAMENTO SFONDO BIANCO COLORE BLU Ø40 | 08 |
| 15 | 06041600 | B | ADESIVO CARBURANTE BENZINA COLORE VERDE L=60 X 80 MM | 01 |
| 16 | 1704277 | A | ADESIVO JLG ATTACCO CINTURE DI SICUREZZA L= 76,2X19,05 MM (**) | 02 |
| 17 | 1705828 | B | ADESIVO JLG INTERUTTORE PEDALE L= 69,85X54 (**) | 01 |
| 18 | 07056700 | A | ADESIVO JLG DIVIETO DI SOLLEVAMENTO L=54,88X40 (**) | 02 |
| 19 | 1701499 | A | ADESIVO JLG DIVIETO DI SOLLEVAMENTO DAL PUNTO DI ANCORAGGIO L= 55,56X76 MM (**) | 04 |
| 20 | 07058800 | A | ADESIVO PERICOLO MANTENERE LE DISTANZE L=65X130 MM | 02 |
| 21 | 06040300 | A | ADESIVO PERICOLO MANTENERE LE DISTANZE GIALLO L=100 X 200 MM (**) | 04 |
| 22 | 1706098 | B | ADESIVO JLG PERICOLO ESPLOSIONE L=63,5X117,475 MM (**) | 01 |
| 23 | 07349200 | A | ADESIVO AVVIAMENTO MOTORE DA TERRA LL2010 IIIS L=76,5X37 MM | 01 |
| 24 | 07056800 | B | ADESIVO JLG DISCESA DI EMERGENZA ALL'INTERNO L=114X130 MM (**) | 02 |

17242800 POSIZIONE ADESIVI / POSITION ADHESIVE

JLG

| POS. | COD. | REV. | DESCRIZIONE / DESCRIPTION | Q.tà |
|------|------------|------|--|------|
| 25 | 06086000 | A | ADESIVO SISTEMA BYPASS TRASLAZIONE L=30X50 | 01 |
| 26 | 06085900 | A | ADESIVO SISTEMA BYPASS PARTE AEREA L=30X50 | 01 |
| 27 | 06706500 | A | ADESIVO ALLINEAMENTO CESTO (2 PEZZI) L=16X50+13 | 01 |
| 28 | 06998800 | A | ADESIVO DEVIATORE POMPA MANUALE PIATTAFORMA GL17.80XL L=86X34 | 01 |
| 29 | 07242000 | A | ADESIVO SELETTORE 3 POSIZIONI 2° TELECOMANDO | 01 |
| 30 | 1702155 | A | ADESIVO JLG STACCABATTERIA L= 63,5X50,80 MM (**) | 01 |
| 31 | 1701504 | A | ADESIVO JLG OLIO IDRAULICO L=50,8x63,5 MM (**) | 01 |
| 32 | 06164700 | A | ADESIVO FILTRO OLIO Ø50 SFONDO BIANCO | 01 |
| 33 | 06165000 | A | ADESIVO LIVELLO OLIO IDRAULICO Ø50 SFONDO BIANCO | 01 |
| 34 | 06060000 | A | ADESIVO LIVELLO OLIO MOTORE Ø50mm | 01 |
| 35 | 06227200 | B | ADESIVO CONTROLLARE LIVELLO OLIO MOTORE L=80X80 MM | 01 |
| 36 | 1701505 | A | ADESIVO JLG CARBURANTE DIESEL L= 50,8X63,5 (**) | 01 |
| 37 | 06056300 | A | ADESIVO PERICOLO SCOTTATURE L=60X51 TRIANGOLARE SFONDO GIALLO | 01 |
| 38 | 06164600 | A | ADESIVO FILTRO ARIA Ø50 SFONDO BIANCO (**) | 01 |
| 39 | 06232100 | B | ADESIVO ATTENZIONE BENZINA INFIAMMABILE L=170X42 MM | 01 |
| 40 | 07240300 | B | ADESIVO DISTANZA 1m SU TELE/RADIO COMANDI | 01 |
| 41 | 07198800 | A | ADESIVO REAZIONE AL SUOLO STABILIZZATORI LL1775 L=45x48 MM | 04 |
| 42 | 07034200 | B | ADESIVO RUMORE 104 dB L=90X100 | 02 |
| 43 | 07243000 | A | ADESIVO JLG X17JPLUS PORTATA CESTO 2 PERSONE L=135X145 | 01 |
| 44 | 1608710001 | C | ADESIVO PULSANTI DISTR. A TERRA LATO SX GL17.80 L=194X50 MM | 01 |
| 45 | 1608710002 | C | ADESIVO PULSANTI DISTRIB A TERRA GL 17.80 LATO SX L= 150X50 mm | 01 |
| 46 | 07199100 | A | ADESIVO COMANDI AEREI DA TERRA LL1775 | 01 |

17242800 POSIZIONE ADESIVI / POSITION ADHESIVE

JLG

| POS. | COD. | REV. | DESCRIZIONE / DESCRIPTION | Q.tà |
|------|----------|------|---|------|
| 47 | 06254800 | B | ADESIVO STOP EMERGENZA SFONDO GIALLO L=70X50 MM (**) | 01 |
| 48 | 07350300 | A | ADESIVO SOLLEVAMENTO PIATTAFORMA CON MULETTO L=90X70 MM | 04 |
| 49 | 06136900 | A | ADESIVO PUNTI INGRASSAGGIO Ø 55 TESTO NERO - SFONDO BIANCO (**) | 01 |
| 50 | 06448200 | B | ADESIVO "SBLOCCARE SOLO NEI CASI PREVISTI" Ø 60 MM | 02 |
| 51 | 06448100 | B | ADESIVO RIPRISTINARE I TAPPI FERMO GUIDA L= 100X35 MM | 02 |
| 52 | | | | |
| 53 | | | | |
| 54 | | | | |
| 55 | | | | |
| 56 | | | | |
| 57 | | | | |
| 58 | | | | |
| 59 | | | | |
| 60 | | | | |
| 61 | | | | |
| 62 | | | | |
| 63 | | | | |
| 64 | | | | |
| 65 | | | | |
| 66 | | | | |
| 67 | | | | |
| 68 | | | | |
| 69 | | | | |
| 70 | 07669000 | B | ADESIVO JLG X17JPLUS PORTATA CESTO 1 PERSONA L=135X145 MM - NON IN DISTINTA | 01 |

**KIT ADESIVI IN LINGUA / LANGUAGE KIT STICKERS
X17JPLUS**

Cod.

172428IT

172428GB

172428FR

172428DE

172428ES

172428NL

172428PT

172428SW

172428DA

172428NO

172428PO

Go to Discount-[Discount-RobotParts.com](http://www.discount-robotparts.com) to order your parts

172428 POSIZIONE ADESIVI IN LINGUA /**
POSITION LANGUAGE STICKERS

IN LINGUA / LANGUAGE

VOLTAGGIO / VOLTAGE

JLG

| POS. | COD. | REV. | DESCRIZIONE / DESCRIPTION | Q.tà |
|------|----------|------|--|------|
| | 172428IT | | ADESIVI PIATTAFORMA AEREA X17JPLUS LINGUA ITALIANO | |
| L1 | 06555300 | B | ADESIVO USO PIATTAFORMA LINGUA ITALIANA LL 23.12 L=128X230 MM | 01 |
| L2 | 06561200 | B | ADESIVO PERICOLO 230 VOLT 16A GIALLO | 05 |
| L3 | 07319100 | A | ADESIVO DISCESA DI EMERGENZA LL 1775/200 MOTORE TERMICO E LITHIUM - ITA L=290X205 MM | 01 |
| | | | | |
| | 172428GB | | ADESIVI PIATTAFORMA AEREA X17JPLUSLINGUA INGLESE | |
| L1 | 06562600 | B | ADESIVO USO PIATTAFORMA INGLESE L=128X230 MM | 01 |
| L2 | 06561200 | B | ADESIVO PERICOLO 230 VOLT 16A GIALLO | 05 |
| L2 | 06042400 | B | ADESIVO PERICOLO 110 VOLT 16A GIALLO | 05 |
| L3 | 073191GB | A | ADESIVO DISCESA DI EMERGENZA LL 1775/200 MOTORE TERMICO E LITHIUM - ING L=290X205 MM | 01 |
| | | | | |
| | 172428FR | | ADESIVI PIATTAFORMA AEREA X17JPLUS LINGUA FRANCESE | |
| L1 | 06562700 | B | ADESIVO USO PIATTAFORMA FRANCESE L=128X230 MM | 01 |
| L2 | 06561200 | B | ADESIVO PERICOLO 230 VOLT 16A GIALLO | 05 |
| L3 | 073191FR | A | ADESIVO DISCESA DI EMERGENZA LL1775/200 MOTORE TERMICO E LITHIUM - FRA L=290X205 MM | 01 |
| | | | | |
| | 172428DE | | ADESIVI PIATTAFORMA AEREA X17JPLUS LINGUA TEDESCO | |
| L1 | 06562800 | B | ADESIVO USO PIATTAFORMA TEDESCO L=128X230 MM | 01 |
| L2 | 06561200 | B | ADESIVO PERICOLO 230 VOLT 16A GIALLO | 05 |
| L3 | 073191DE | A | ADESIVO DISCESA DI EMERGENZA LL 1775/200 MOTORE TERMICO E LITHIUM - TED L=290X205 MM | 01 |
| | | | | |
| | | | | |
| | | | | |

172428 POSIZIONE ADESIVI IN LINGUA /**
POSITION LANGUAGE STICKERS

IN LINGUA / LANGUAGE

VOLTAGGIO / VOLTAGE

JLG

| POS. | COD. | REV. | DESCRIZIONE / DESCRIPTION | Q.tà |
|------|----------|----------|--|------|
| | 172428ES | | ADESIVI PIATTAFORMA AEREA X17JPLUS LINGUA SPAGNOLO | |
| L1 | 06562900 | B | ADESIVO USO PIATTAFORMA SPAGNOLO L=128X230 MM | 01 |
| L2 | 06561200 | B | ADESIVO PERICOLO 230 VOLT 16A GIALLO | 05 |
| L3 | 073191ES | A | ADESIVO DISCESA DI EMERGENZA LL 1775/200 MOTORE TERMICO E LITHIUM - SPA L=290X205 MM | 01 |
| | | | | |
| | 172428NL | | ADESIVI PIATTAFORMA AEREA X17JPLUS LINGUA OLANDESE | |
| L1 | 06563000 | B | ADESIVO USO PIATTAFORMA OLANDESE L=128X230 MM | 01 |
| L2 | 06561200 | B | ADESIVO PERICOLO 230 VOLT 16A GIALLO | 05 |
| L3 | 073191NL | A | ADESIVO DISCESA DI EMERGENZA LL 1775/200 MOTORE TERMICO E LITHIUM - OLA L=290X205 MM | 01 |
| | | | | |
| | 172428PT | | ADESIVI PIATTAFORMA AEREA X17JPLUS LINGUA PORTOGHESE | |
| L1 | 06563100 | B | ADESIVO USO PIATTAFORMA PORTOGHESE L=128X230 MM | 01 |
| L2 | 06561200 | B | ADESIVO PERICOLO 230 VOLT 16A GIALLO | 05 |
| L3 | 073191PT | A | ADESIVO DISCESA DI EMERGENZA LL 1775/200 MOTORE TERMICO E LITHIUM - OLA L=290X205 MM | 01 |
| | | | | |
| | 172428SW | | ADESIVI PIATTAFORMA AEREA X17JPLUS LINGUA SVEDESE | |
| L1 | 07137300 | B | ADESIVO USO PIATTAFORMA AEREA CINGOLATA - SVEDESE L= 128X230 MM | 01 |
| L2 | 06561200 | B | ADESIVO PERICOLO 230 VOLT 16A GIALLO | 05 |
| L3 | 073191SW | A | ADESIVO DISCESA DI EMERGENZA LL 1775/200 MOTORE TERMICO E LITHIUM - SWE L=290X205 MM | 01 |
| | | | | |
| | 172428DA | | ADESIVI PIATTAFORMA AEREA X17JPLUS LINGUA DANESE | |
| L1 | 07138100 | B | ADESIVO USO PIATTAFORMA AEREA CINGOLATA - DANESE L= 128X230 MM ** | 01 |
| L2 | 06561200 | B | ADESIVO PERICOLO 230 VOLT 16A GIALLO | 05 |
| L3 | 073191DA | A | ADESIVO DISCESA DI EMERGENZA LL 1775/200 MOTORE TERMICO E LITHIUM - DAN L=290X205 MM | 01 |
| | | | | |
| | | | | |

AGGIORNATO IL / UPDATED 19/11/2014

Cod. 17242900 (no a ricambio/no spare kit)

**KIT ADESIVI COMMERCIALI PIATTAFORMA AEREA /
AERIAL PLATFORM KIT STICKERS COMMERCIAL
X17JPLUS**

DA USARE CON / FOR USE WITH

**17242800 KIT ADESIVI DI SICUREZZA PIATTAFORMA AEREA X17JPLUS/
STICKER KITS SAFETY AERIAL PLATFORM X17JPLUS**

**17187700 KIT INTEGRAZIONE ADESIVI PER PIATTAFORME LITHIUM /
STICKER KIT INTEGRATION FOR PLATFORM LITHIUM
X14J / 14J-H / X17J / 17JPLUS / X19J / X20JPLUS / X23**

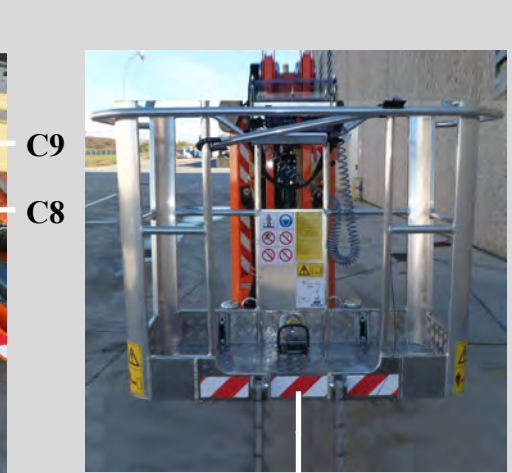
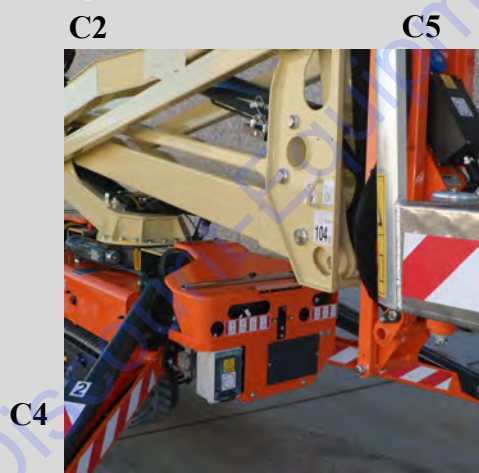
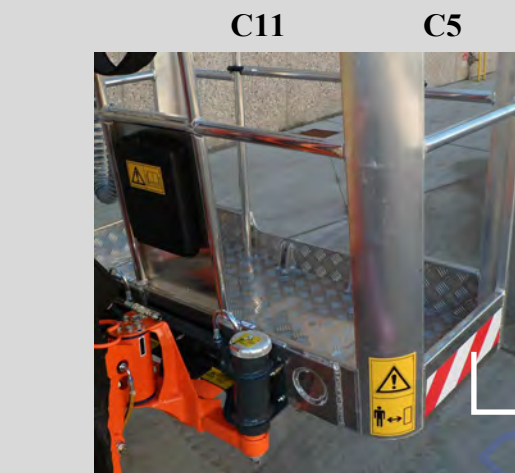

| | | | |
|--------------------------|--------------------------|----------------------|--------|
| KIT ADESIVI - X17JPLUS | AUFKLEBERSATZ - X17JPLUS | cod. 17242900 | |
| SET OF DECALS - X17JPLUS | KIT ADHESIVOS - X17JPLUS | | |
| KIT COLLANTS - X17JPLUS | ADHESIEKIT - X17JPLUS | Ed. 19/11/2014 | Tav 01 |

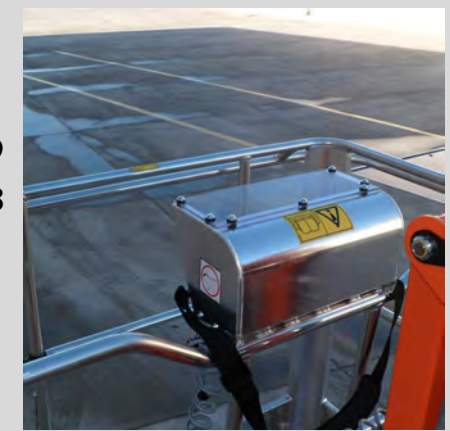

KIT ADESIVI - X17JPLUS

SET OF DECALS - X17JPLUS

KIT COLLANTS - X17JPLUS

AUFKLEBERSATZ - X17JPLUS

KIT ADHESIVOS - X17JPLUS

ADHESIEKIT - X17JPLUS

cod. 17242900

Ed. 19/11/2014

Tav 02

Cod. 17242900 (no a ricambio/no spare kit)

**KIT ADESIVI COMMERCIALI PIATTAFORMA AEREA /
AERIAL PLATFORM KIT STICKERS COMMERCIAL
X17JPLUS**

Go to Discount-Equipment.com to order your parts

17242900 POSIZIONE ADESIVI / POSITION ADHESIVE **Aggiornato il / Updated 19/11/2014**

JLG

| POS. | COD. | REV. | DESCRIZIONE / DESCRIPTION | Q.tà |
|------|----------|------|---|------|
| C1 | 07397100 | A | ADESIVO JLG LOGO PIATTAFORMA AEREA CINGOLATA X7JPLUS L= 334X46 MM | 02 |
| C2 | 07060500 | A | ADESIVO LOGO JLG L=432x150MM | 02 |
| C3 | | A | | |
| C4 | 06086700 | A | ADESIVO CON RIGHE BIANCHE E ROSSE L=430X100 (**) | 06 |
| C5 | 06039700 | A | ADESIVO CON RIGHE BIANCHE ROSSE L= 700 X 80 (**) | 09 |
| C6 | 07060600 | A | ADESIVO LOGO JLG LIFT L=624x100 MM | 02 |
| C7 | | | | |
| C8 | 07268300 | A | ADESIVO ATTENZIONE SOLLEVAMENTO FORCHE L=80X7 MM | 08 |
| C9 | 07268400 | A | ADESIVO ATTENZIONE SOLLEVAMENTO FORCHE L=180X7 MM | 04 |
| C10 | 07281100 | A | ADESIVO CON RIGHE BIANCHE E ROSSE L= 380X100 MM | 04 |
| C11 | 06436900 | A | ADESIVO CON RIGHE BIANCHE E ROSSE L= 375X80 MM | 08 |
| C12 | | | | |
| C13 | | | | |
| C14 | | | | |
| C15 | | | | |
| C16 | | | | |
| C17 | | | | |
| C18 | | | | |
| C19 | | | | |
| C20 | | | | |
| C21 | | | | |
| C22 | | | | |
| C23 | | | | |
| C24 | | | | |

KIT ADESIVI SICUREZZA PIATTAFORMA AEREA /
AERIAL PLATFORM KIT STICKERS SAFETY
JLG/CE - X17JPLUS - MK2

Cod. 17776400

kit in lingua non inclusi nel codice generale / language code not included in the standard kit

177764IT / 177764GB / 177764FR / 177764DE / 177764ES / 177764NL /
177764PT / 177764DA / 177764SW / 177764NO / 177764PL / 177764FI

DA USARE CON / FOR USE WITH

17242900 KIT ADESIVI COMMERCIALI PIATTAFORMA AEREA X17JPLUS /
STICKER KITS COMMERCIAL AERIAL PLATFORM X17JPLUS

17187700 KIT INTEGRAZIONE ADESIVI PER PIATTAFORME AEREE JLG/CE LITHIUM /
INTEGRATION KIT STICKERS PLATFORMS JLG / CE LITHIUM
X14J_14J-H_X17J_17JPLUS_X19J_X20JPLUS_X23J_X26JPLUS

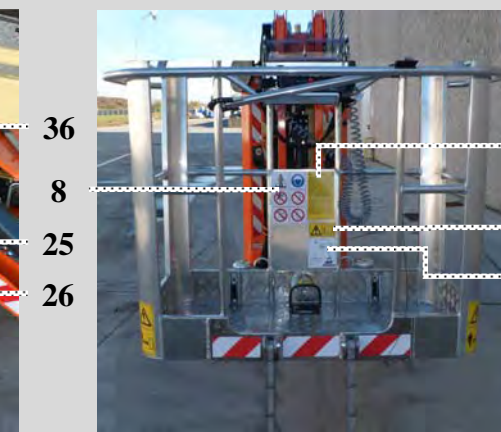
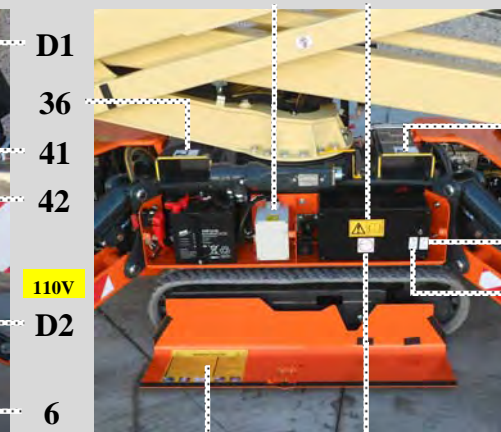
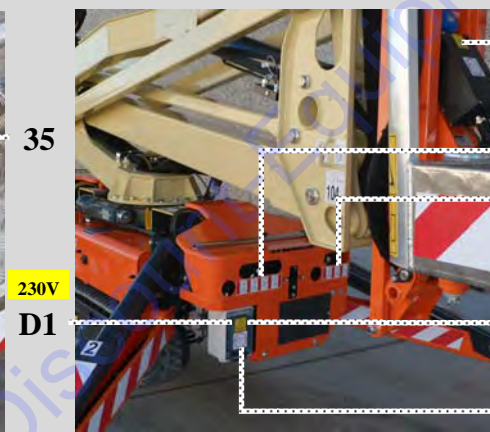
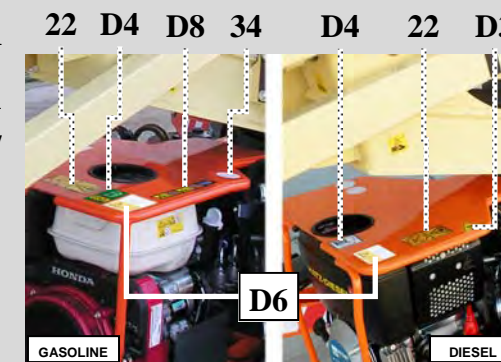
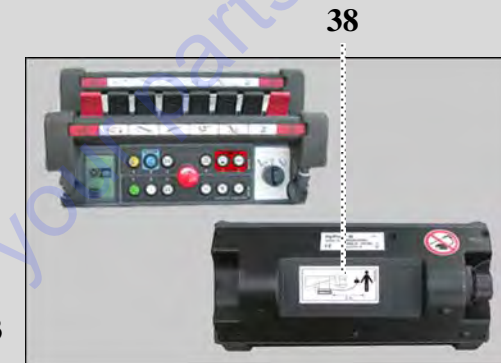

KIT ADESIVI - X17JPLUS - MK2

SET OF DECALS - X17JPLUS - MK2

KIT COLLANTS - X17JPLUS - MK2

AUFKLEBERSATZ - X17JPLUS - MK2

KIT ADHESIVOS - X17JPLUS - MK2

ADHESIEKIT - X17JPLUS - MK2

Cod. 17776400

Tav 01



KIT ADESIVI - X17JPLUS - MK2

AUFKLEBERSATZ - X17JPLUS - MK2

SET OF DECALS - X17JPLUS - MK2

KIT ADHESIVOS - X17JPLUS - MK2

KIT COLLANTS - X17JPLUS - MK2

ADHESIEKIT - X17JPLUS - MK2

Cod. 17776400

Tav 02

Cod. 17776400

KIT ADESIVI SICUREZZA PIATTAFORMA AEREA /
AERIAL PLATFORM KIT STICKERS SAFETY

JLG/CE - X17JPLUS - MK2

Go to Discount-Equipment.com to order your parts

PARTS FINDER

**Search Website
by Part Number**



**Search Manual
Library For Parts
Manual & Lookup Part
Numbers – Purchase
or Request Quote**

Search Manuals

Enter your information to help us find the right parts manual for your machine.

* Brand:

* Model:

* Serial:

* Part Number:

SEARCH

**Can't Find Part or
Manual? Request Help
by Manufacturer,
Model & Description**

Parts Order Form

Please fill in the following information to help us find the right part for your machine.

MANUFACTURER:

MODEL:

DESCRIPTION:

DATE:

NAME:

PHONE:

EMAIL:

ADDRESS:

CITY:

STATE:

ZIP:

REQUEST QUOTE

Discount-Equipment.com is your online resource for quality parts & equipment.

Florida: **561-964-4949** Outside Florida TOLL FREE: **877-690-3101**

Need parts?

Click on this link: <http://www.discount-equipment.com/category/5443-parts/> and choose one of the options to help get the right parts and equipment you are looking for. Please have the machine model and serial number available in order to help us get you the correct parts. If you don't find the part on the website or on one of the online manuals, please fill out the request form and one of our experienced staff members will get back to you with a quote for the right part that your machine needs.

We sell worldwide for the brands: Genie, Terex, JLG, MultiQuip, Mikasa, Essick, Whiteman, Mayco, Toro Stone, Diamond Products, Generac Magnum, Airman, Haulotte, Barreto, Power Blanket, Nifty Lift, Atlas Copco, Chicago Pneumatic, Allmand, Miller Curber, Skyjack, Lull, Skytrak, Tsurumi, Husquvarna Target, Stow, Wacker, Sakai, Mi-T-M, Sullair, Basic, Dynapac, MBW, Weber, Bartell, Bennar Newman, Haulotte, Ditch Runner, Menegotti, Morrison, Contec, Buddy, Crown, Edco, Wyco, Bomag, Laymor, EZ Trench, Bil-Jax, F.S. Curtis, Gehl Pavers, Heli, Honda, ICS/PowerGrit, IHI, Partner, Imer, Clipper, MMD, Koshin, Rice, CH&E, General Equipment, Amida, Coleman, NAC, Gradall, Square Shooter, Kent, Stanley, Tamco, Toku, Hatz, Kohler, Robin, Wisconsin, Northrock, Oztec, Toker TK, Rol-Air, APT, Wylie, Ingersoll Rand / Doosan, Innovatech, Con X, Ammann, Mecalac, Makinex, Smith Surface Prep, Small Line, Wanco, Yanmar

17776400 POSIZIONE ADESIVI / POSITION ADHESIVE

JLG

| POS. | COD. | REV. | DESCRIZIONE / DESCRIPTION | Q.tà |
|------|------------|------|---|------|
| 01 | 06555500 | A | ADESIVO NR 1 L=50X60 BIANCO | 01 |
| 02 | 06555600 | A | ADESIVO NR 2 L=50X60 BIANCO | 01 |
| 03 | 06555700 | A | ADESIVO N° 3 L=50X60 BIANCO | 01 |
| 04 | 06555800 | A | ADESIVO N° 4 L=50X60 BIANCO | 01 |
| 05 | 06041200 | A | ADESIVO SCHIACCIAMENTO PIEDI TRIANGOLARE L=53X46 GIALLO | 04 |
| 06 | 1001125483 | A | ADESIVO JLG VIETATO LAVARE L=63,5X63,5 MM (**) | 06 |
| 07 | 07668300 | A | ADESIVO SELETTORE SCATOLA COMANDI TERRA / CESTO L=105X155 MM | 01 |
| 08 | 06924300 | A | ADESIVO CASCO - IMBRAGATURA - DIVIETI SERIE METAL-IIIS L= 170X250 MM | 01 |
| 09 | 1706493 | B | ADESIVO JLG SCORRIMENTO SBARRA CHIUSURA CESTO L= 76,2X25,4 MM (**) | 01 |
| 10 | 06040500 | A | ADESIVO DIREZ. TRASLAZIONE FRECCIA GIALLA SFONDO NERO L=61 X 160 | 02 |
| 11 | 06040900 | A | ADESIVO LEGGERE IL MANUALE L=125 X 65 GIALLO | 05 |
| 12 | 06041300 | B | ADESIVO ATTENZIONE PERICOLO TAGLI L=35 X 40 MM GIALLO (**) | 13 |
| 13 | 1703814 | A | ADESIVO JLG ATTACCO ANCORAGGIO L=55,56X76,2 MM (**) | 04 |
| 14 | 06044000 | A | ADESIVO ATTACCO SOLLEVAMENTO SFONDO BIANCO COLORE BLU Ø40 | 08 |
| 15 | 06448200 | B | ADESIVO SBLOCCARE SOLO NEI CASI PREVISTI Ø 60 MM | 02 |
| 16 | 06448100 | B | ADESIVO RIPRISTINARE I TAPPI FERMO GUIDA L= 100X35 MM | 02 |
| 17 | 1705828 | B | ADESIVO JLG INTERUTTORE PEDALE L= 69,85X54 (**) | 01 |
| 18 | 07056700 | A | ADESIVO JLG DIVIETO DI SOLLEVAMENTO L=54,88X40 (**) | 02 |
| 19 | 1701499 | A | ADESIVO JLG DIVIETO DI SOLLEVAMENTO DAL PUNTO DI ANCORAGGIO L= 55,56X76 MM (**) | 04 |
| 20 | 07058800 | A | ADESIVO PERICOLO MANTENERE LE DISTANZE L=65X130 MM | 02 |
| 21 | 06040300 | A | ADESIVO PERICOLO MANTENERE LE DISTANZE GIALLO L=100 X 200 MM (**) | 04 |
| 22 | 1706098 | B | ADESIVO JLG PERICOLO ESPLOSIONE L=63,5X117,475 MM (**) | 01 |
| 23 | 07668200 | A | ADESIVO EMERGENCY STOP E BLOCCHETTO ACCENSIONE L=85x160 MM | 01 |
| 24 | 07056800 | B | ADESIVO JLG DISCESA DI EMERGENZA ALL'INTERNO L=114X130 MM (**) | 02 |

17776400 POSIZIONE ADESIVI / POSITION ADHESIVE

JLG

| POS. | COD. | REV. | DESCRIZIONE / DESCRIPTION | Q.tà |
|------|------------|------|---|------|
| 25 | 06086000 | A | ADESIVO SISTEMA BYPASS TRASLAZIONE L=30X50 | 01 |
| 26 | 06085900 | A | ADESIVO SISTEMA BYPASS PARTE AEREA L=30X50 | 01 |
| 27 | 06706500 | A | ADESIVO ALLINEAMENTO CESTO (2 PEZZI) L=16X50+13 | 01 |
| 28 | 06998800 | A | ADESIVO DEVIATORE POMPA MANUALE PIATTAFORMA GL17.80XL L=86X34 | 01 |
| 29 | 07668100 | A | ADESIVO PULSANTI DISTRIBUTORE PARTE AEREA LL2614 L=318X52 MM | 01 |
| 30 | 1702155 | A | ADESIVO JLG STACCABATTERIA L= 63,5X50,80 MM (**) | 01 |
| 31 | 1701504 | A | ADESIVO JLG OLIO IDRAULICO L=50,8x63,5 MM (**) | 01 |
| 32 | 06164700 | A | ADESIVO FILTRO OLIO Ø50 SFONDO BIANCO | 01 |
| 33 | 06165000 | A | ADESIVO LIVELLO OLIO IDRAULICO Ø50 SFONDO BIANCO | 01 |
| 34 | 06060000 | A | ADESIVO LIVELLO OLIO MOTORE Ø50mm | 01 |
| 35 | 1704277 | A | ADESIVO JLG ATTACCO CINTURE DI SICUREZZA L= 76,2X19,05 MM (**) | 02 |
| 36 | 07350300 | A | ADESIVO SOLLEVAMENTO PIATTAFORMA CON MULETTO L=90X70 MM | 04 |
| 37 | 06136900 | A | ADESIVO PUNTI INGRASSAGGIO Ø 55 TESTO NERO - SFONDO BIANCO (**) | 01 |
| 38 | 07240300 | B | ADESIVO DISTANZA 1m SU TELE/RADIO COMANDI | 01 |
| 39 | 07198800 | A | ADESIVO REAZIONE AL SUOLO STABILIZZATORI LL1775 L=45x48 MM | 04 |
| 40 | 07243000 | A | ADESIVO JLG X17JPLUS PORTATA CESTO 2 PERSONE L=135X145 | 01 |
| 41 | 1608710001 | C | ADESIVO PULSANTI DISTR. A TERRA LATO SX GL17.80 L=194X50 MM | 01 |
| 42 | 1608710002 | C | ADESIVO PULSANTI DISTRIB A TERRA GL 17.80 LATO SX L= 150X50 mm | 01 |
| 43 | | | | |
| 44 | | | | |
| 45 | | | | |
| 46 | | | | |

17776400 POSIZIONE ADESIVI / POSITION ADHESIVE

JLG

| POS. | COD. | REV. | ADESIVI IN DISTINTA MACCHINA / STICKERS IN LIST MACHINE | Q.tà |
|------|----------|------|---|------|
| D1 | 06561200 | B | ADESIVO PERICOLO 230 VOLT16 AMPERE GIALLO L=47X47 MM | 05 |
| | 06042400 | B | ADESIVO PERICOLO 110 VOLT16 AMPERE GIALLO L=47 X 47 MM | 05 |
| | 06257300 | A | ADESIVO PERICOLO 240 VOLT GIALLO L=47 X 47 MM | 05 |
| D2 | 07668000 | A | ADESIVO PERICOLO 110 VOLT 32A GIALLO L=47 X 47 MM | 02 |
| D3 | 06056300 | A | ADESIVO PERICOLO SCOTTATURE TRIANGOLARE SFONDO GIALLO L=60X51 MM | 01 |
| D4 | 06041600 | B | ADESIVO CARBURANTE BENZINA COLORE VERDE L=60 X 80 MM | 01 |
| | 06043900 | A | ADESIVO CARBURANTE DIESEL SFONDO BIANCO Ø 50 MM | 01 |
| D5 | 06164600 | A | ADESIVO FILTRO ARIA SFONDO BIANCO Ø50 MM | 01 |
| D6 | 06227200 | B | ADESIVO CONTROLLARE LIVELLO OLIO MOTORE L=80X80 MM | 01 |
| D7 | 07034200 | B | ADESIVO RUMORE 104 dB L=90X100 MM | 02 |
| D8 | 06232100 | B | ADESIVO ATTENZIONE BENZINA INFIAMMABILE | 01 |
| D19 | | | | |
| D12 | | | | |
| D13 | | | | |
| D14 | | | | |
| D15 | | | | |
| D16 | | | | |
| D17 | | | | |
| D19 | | | | |
| D20 | | | | |
| | | | | |
| | | | PER MACCHINE CON CESTO A 1 PERSONA / FOR MACHINE WITH BASKET 1 PERSONA | |
| | | | | |
| 40 | 07669000 | B | ADESIVO JLG X17JPLUS PORTATA CESTO 1 PERSONA L=110X145 MM " non in distinta " | 01 |

**POSIZIONE ADESIVI IN LINGUA /
*STICKERS IN POSITION LANGUAGE***

JLG/CE - X17JPLUS - MK2

Codici / codes

**177764IT / 177764GB / 177764FR / 177764DE / 177764ES / 177764NL /
177764SW / 177764PT / 177764DA / 177764NO / 177764PL / 177764FI**

Go to Discount-Equipment.com to order your parts

177764 POSIZIONE ADESIVI IN LINGUA /**
POSITION LANGUAGE STICKERS

IN LINGUA / LANGUAGE

JLG

| POS. | COD. | REV. | DESCRIZIONE / DESCRIPTION | Q.tà |
|------|----------|----------|--|------|
| | 177764IT | | ADESIVI PIATTAFORMA AEREA X17JPLUS MK2 - LINGUA ITALIANO | |
| L1 | 06555300 | B | ADESIVO USO PIATTAFORMA AEREA CINGOLATA - ITALIANO L=128X230 __ MOD_B | 01 |
| L2 | 07319100 | A | ADESIVO DISCESA DI EMERGENZA LL 1775/200 MOTORE TERMICO E LITHIUM - ITA L=290X205 MM | 01 |
| | 177764GB | | ADESIVI PIATTAFORMA AEREA X17JPLUS MK2 - LINGUA INGLESE | |
| L1 | 06562600 | B | ADESIVO USO PIATTAFORMA AEREA CINGOLATA - INGLESE L=128X230 __ MOD_B | 01 |
| L2 | 073191GB | A | ADESIVO DISCESA DI EMERGENZA LL 1775/200 MOTORE TERMICO E LITHIUM - ING L=290X205 MM | 01 |
| | 177764FR | | ADESIVI PIATTAFORMA AEREA X17JPLUS MK2 - LINGUA FRANCESE | |
| L1 | 06562700 | B | ADESIVO USO PIATTAFORMA AEREA CINGOLATA - FRANCESE L=128X230 __ MOD_B | 01 |
| L2 | 073191FR | A | ADESIVO DISCESA DI EMERGENZA LL1775/200 MOTORE TERMICO E LITHIUM - FRA L=290X205 MM | 01 |
| | 177764DE | | ADESIVI PIATTAFORMA AEREA X17JPLUS MK2 - LINGUA TEDESCO | |
| L1 | 06562800 | B | ADESIVO USO PIATTAFORMA AEREA CINGOLATA - TEDESCO L=128X230 __ MOD_B | 01 |
| L2 | 073191DE | A | ADESIVO DISCESA DI EMERGENZA LL 1775/200 MOTORE TERMICO E LITHIUM - TED L=290X205 MM | 01 |
| | 177764ES | | ADESIVI PIATTAFORMA AEREA X17JPLUS MK2 - LINGUA SPAGNOLO | |
| L1 | 06562900 | B | ADESIVO USO PIATTAFORMA AEREA CINGOLATA - SPAGNOLO L=128X230 __ MOD_B | 01 |
| L2 | 073191ES | A | ADESIVO DISCESA DI EMERGENZA LL 1775/200 MOTORE TERMICO E LITHIUM - SPA L=290X205 MM | 01 |
| | 177764NL | | ADESIVI PIATTAFORMA AEREA X17JPLUS MK2 - LINGUA OLANDESE | |
| L1 | 06563000 | B | ADESIVO USO PIATTAFORMA AEREA CINGOLATA - OLANDESE L=128X230 __ MOD_B | 01 |
| L2 | 073191NL | A | ADESIVO DISCESA DI EMERGENZA LL 1775/200 MOTORE TERMICO E LITHIUM - OLA L=290X205 MM | 01 |

177764 POSIZIONE ADESIVI IN LINGUA /**
POSITION LANGUAGE STICKERS

IN LINGUA / LANGUAGE

JLG

| POS. | COD. | REV. | DESCRIZIONE / DESCRIPTION | Q.tà |
|------|----------|----------|--|------|
| | 177764SW | | ADESIVI PIATTAFORMA AEREA X17JPLUS MK2 - LINGUA SVEDESE | |
| L1 | 07137300 | B | ADESIVO USO PIATTAFORMA AEREA CINGOLATA - SVEDESE L= 128X230 MM __ MOD_B | 01 |
| L2 | 073191SW | A | ADESIVO DISCESA DI EMERGENZA LL 1775/200 MOTORE TERMICO E LITHIUM - SWE L=290X205 MM | 01 |
| | 177764PT | | ADESIVI PIATTAFORMA AEREA X17JPLUS MK2 - LINGUA PORTOGHESE | |
| L1 | 06563100 | B | ADESIVO USO PIATTAFORMA AEREA CINGOLATA - PORTOGHESE L=128X230 __ MOD_B | 01 |
| L2 | 073191PT | A | ADESIVO DISCESA DI EMERGENZA LL 1775/200 MOTORE TERMICO E LITHIUM - OLA L=290X205 MM | 01 |
| | 177764DA | | ADESIVI PIATTAFORMA AEREA X17JPLUS MK2 - LINGUA DANESE | |
| L1 | 07138100 | B | ADESIVO USO PIATTAFORMA AEREA CINGOLATA - DANESE L= 128X230 MM __ MOD_B | 01 |
| L2 | 073191DA | A | ADESIVO DISCESA DI EMERGENZA LL 1775/200 MOTORE TERMICO E LITHIUM - DAN L=290X205 MM | 01 |
| | 177764NO | | ADESIVI PIATTAFORMA AEREA X17JPLUS MK2 - LINGUA NORVEGESE | |
| L1 | 07162000 | B | ADESIVO USO PIATTAFORMA AEREA CINGOLATA - NORVEGESE L=128X230 MM __ MOD_B | 01 |
| L2 | 073191NO | A | ADESIVO DISCESA DI EMERGENZA LL 1775/200 MOTORE TERMICO E LITHIUM - NOR L=290X205 MM | 01 |
| | 177764PL | | ADESIVI PIATTAFORMA AEREA X17JPLUS MK2 - LINGUA POLACCO | |
| L1 | 07506600 | A | ADESIVO USO PIATTAFORMA AEREA CINGOLATA - POLACCO L= 128X230 MM ** | 01 |
| L2 | 073191PL | A | ADESIVO DISCESA DI EMERGENZA LL 1775/200 MOTORE TERMICO E LITHIUM - POL L=290X205 MM | 01 |
| | 177764FI | | ADESIVI PIATTAFORMA AEREA X17JPLUS MK2 - LINGUA FINLANDESE | |
| L1 | 07547700 | A | ADESIVO USO PIATTAFORMA AEREA CINGOLATA - FINLANDESE L= 128X230 MM ** | 01 |
| L2 | 073191FI | A | ADESIVO DISCESA DI EMERGENZA LL 1775/200 MOTORE TERMICO E LITHIUM - FIN L=290X205 MM | 01 |

KIT ADESIVI SICUREZZA PIATTAFORMA AEREA /
AERIAL PLATFORM KIT STICKERS SAFETY
JLG/ANSI - X500AJ - MK2

Cod. 17776800

+ **kit in lingua non inclusi nel codice generale / language code not included in the standard kit**

177768GB - 177768FR - 177768ES - 177768PT

DA USARE CON / FOR USE WITH

17224200 KIT ADESIVI COMMERCIALI PIATTAFORMA AEREA X500AJ ANSI /
STICKERS KIT COMMERCIAL AERIAL PLATFORM

17107300 KIT ADESIVI INTEGRZIONE PER PIATTAFORME AEREE JLG-ANSI LITHIUM /
STICKER KITS FOR INTEGRATION PLATFORMS JLG-ANSI LITHIUM /
X390AJ - X500AJ - X550AJ - X600AJ - X700AJ - X770AJ

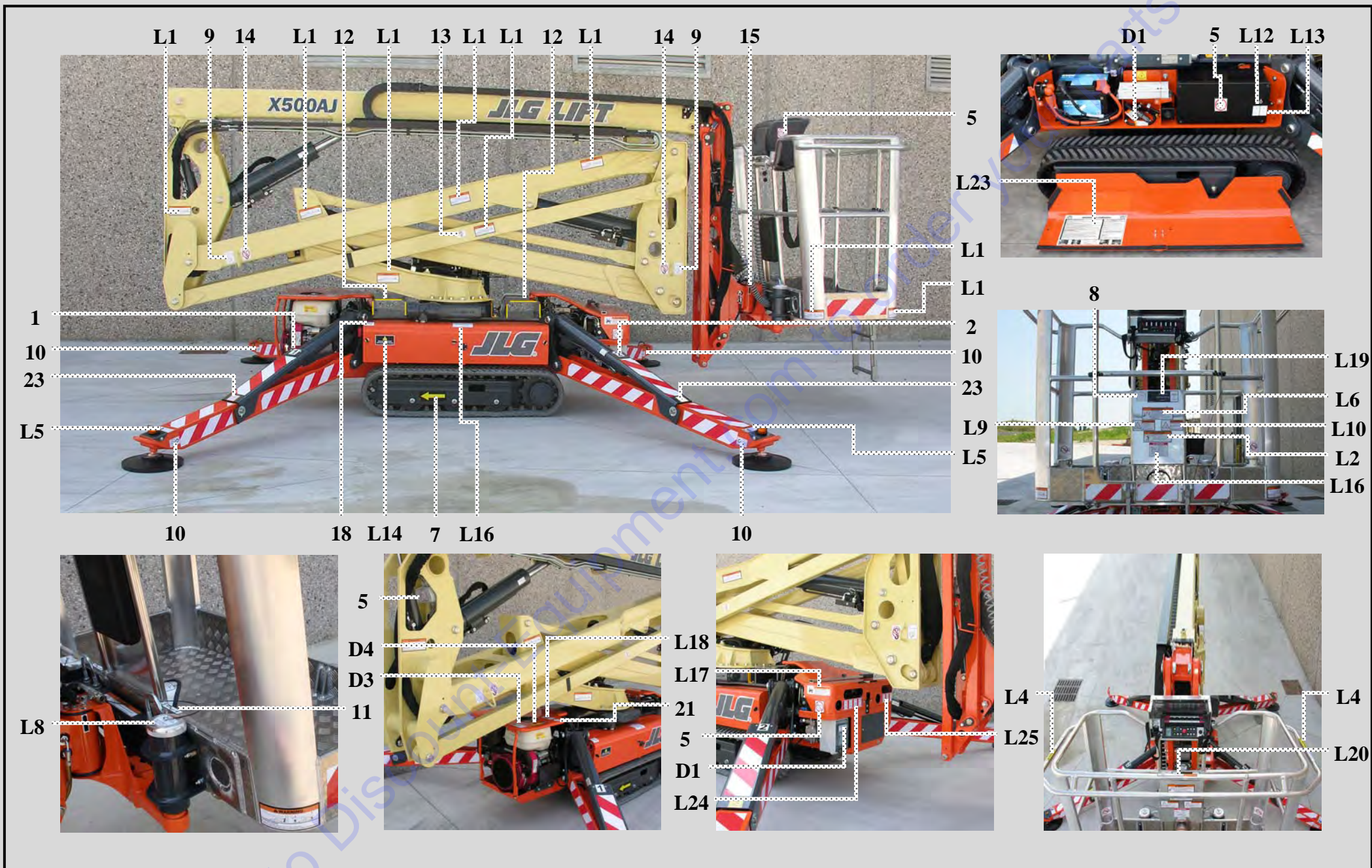

| | | |
|------------------------------|------------------------------|----------------------|
| KIT ADESIVI - X500AJ - MK2 | AUFKLEBERSATZ - X500AJ - MK2 | Cod. 17776800 |
| SET OF DECALS - X500AJ - MK2 | KIT ADHESIVOS - X500AJ - MK2 | |
| KIT COLLANTS - X500AJ - MK2 | ADHESIEKIT - X500AJ - MK2 | Tav 01 |

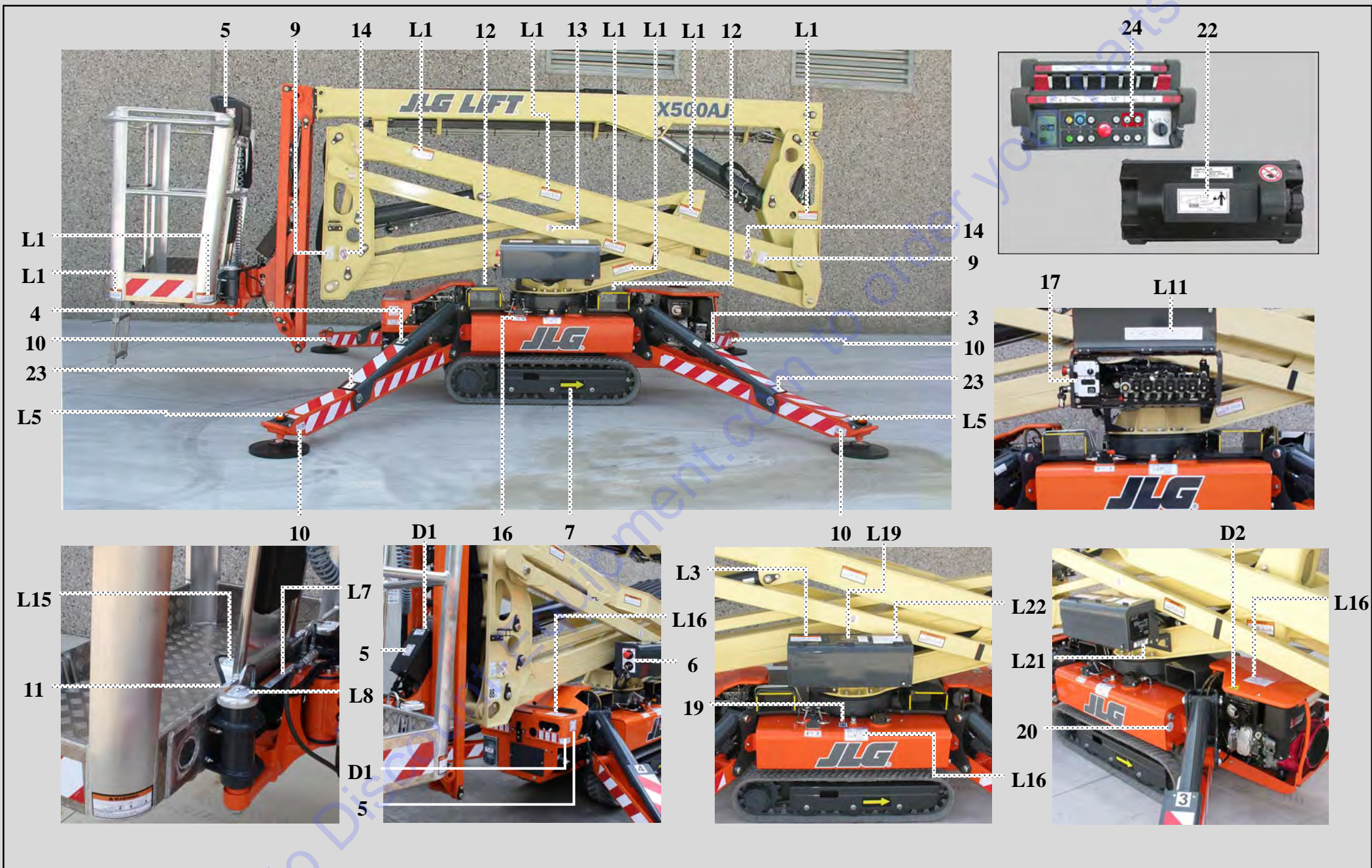

| | | |
|------------------------------|------------------------------|----------------------|
| KIT ADESIVI - X500AJ - MK2 | AUFKLEBERSATZ - X500AJ - MK2 | Cod. 17776800 |
| SET OF DECALS - X500AJ - MK2 | KIT ADHESIVOS - X500AJ - MK2 | |
| KIT COLLANTS - X500AJ - MK2 | ADHESIEKIT - X500AJ - MK2 | Tav 02 |

Cod. 17776800

**POSIZIONE ADESIVI SICUREZZA PER /
*POSITION OF STICKERS FOR SAFETY***

JLG/ANSI - X500AJ - MK2

Go to Discount-Equipment.com to order your parts

17776800 POSIZIONE ADESIVI / POSITION STICKERS

JLG

| POSIZIONE | CODICE | REV. | DESCRIZIONE | QUANTITA' |
|-----------|------------|------|---|-----------|
| 01 | 06555500 | A | ADESIVO NR 1 L=50X60 BIANCO | 01 |
| 02 | 06555600 | A | ADESIVO NR 2 L=50X60 BIANCO | 01 |
| 03 | 06555700 | A | ADESIVO N° 3 L=50X60 BIANCO | 01 |
| 04 | 06555800 | A | ADESIVO N° 4 L=50X60 BIANCO | 01 |
| 05 | 1001125483 | A | ADESIVO JLG VIETATO LAVARE L=63,5X63,5 MM | 06 |
| 06 | 07668200 | A | ADESIVO EMERGENCY STOP E BLOCCHETTO ACCENSIONE L=85x160 MM | 01 |
| 07 | 06040500 | A | ADESIVO DIREZ. TRASLAZIONE FRECCIA GIALLA SFONDO NERO L=61 X 160 | 02 |
| 08 | 1701640 | A | ADESIVO JLG LEGGERE IL MANUALE L= 69,85x69,85 MM | 01 |
| 09 | 1703814 | A | ADESIVO JLG ATTACCO ANCORAGGIO L=55,56X76,2 MM | 04 |
| 10 | 07071200 | A | ADESIVO JLG PUNTO DI SOLLEVAMENTO L= 40X66 MM | 08 |
| 11 | 1704277 | A | ADESIVO JLG ATTACCO CINTURE DI SICUREZZA L= 76,2X19,05 MM | 02 |
| 12 | 07350300 | A | ADESIVO SOLLEVAMENTO PIATTAFORMA CON MULETTO L=90X70 MM | 04 |
| 13 | 07056700 | A | ADESIVO JLG DIVIETO DI SOLLEVAMENTO L=40X54,88 | 02 |
| 14 | 1701499 | A | ADESIVO JLG DIVIETO DI SOLLEVAMENTO DAL PUNTO DI ANCORAGGIO L= 55,56X76 MM (**) | 04 |
| 15 | 06706500 | A | ADESIVO ALLINEAMENTO CESTO (2 PEZZI) L=16X50+13 | 01 |
| 16 | 06998800 | A | ADESIVO DEVIATORE POMPA MANUALE PIATTAFORMA GL17.80XL L=86X34 | 01 |
| 17 | 07668300 | A | ADESIVO SELETTORE SCATOLA COMANDI TERRA / CESTO L=105X155 MM | 01 |
| 18 | 1702155 | A | ADESIVO JLG STACCABATTERIA L= 63,5X50,80 MM | 01 |
| 19 | 1701504 | A | ADESIVO JLG OLIO IDRAULICO L=50,8x63,5 MM | 01 |
| 20 | 06165000 | A | ADESIVO LIVELLO OLIO IDRAULICO Ø50 SFONDO BIANCO | 01 |
| 21 | 06060000 | A | ADESIVO LIVELLO OLIO MOTORE Ø50mm | 01 |
| 22 | 07240300 | B | ADESIVO DISTANZA 1 METRO SU TELE/RADIO COMANDI L= 75x35 MM __ MOD_B | 01 |
| 23 | 07242100 | B | ADESIVO REAZIONE AL SUOLO STABILIZZATORI X500AJ L= 50X50 - BIANCO __ MOD_B | 04 |
| 24 | 07071000 | B | ADESIVO JLG CLAXON SU PIATTAFORME L=39,3X28,55 MM __ MOD_B | 01 |

17776800 POSIZIONE ADESIVI / POSITION STICKERS

JLG

| POS. | COD. | REV. | ADESIVI IN DISTINTA MACCHINA / STICKERS IN LIST MACHINE | Q.tà |
|------|----------|------|--|------|
| D1 | 07056400 | B | ADESIVO JLG PERICOLO 120V - 60HZ - ING L= 75x32,68 MM __ MOD_B | 04 |
| | 07056300 | A | ADESIVO JLG PERICOLO 220V - 50/60HZ L= 75X18,75 MM | 04 |
| D2 | 06056300 | A | ADESIVO PERICOLO SCOTTATURE TRIANGOLARE SFONDO GIALLO L=60X51 MM | 01 |
| D3 | 06041600 | A | ADESIVO CARBURANTE BENZINA COLORE VERDE L=60 X 80 MM __ MOD_B | 01 |
| | 1701505 | A | ADESIVO JLG CARBURANTE DIESEL L= 50,8X63,5 | 01 |
| D4 | 06232100 | B | ADESIVO ATTENZIONE BENZINA INFIAMMABILE L=170X42 MM __ MOD_B | 01 |
| D5 | | | | |
| D6 | | | | |
| D7 | | | | |
| D8 | | | | |
| D9 | | | | |
| D10 | | | | |
| D11 | | | | |
| D12 | | | | |
| D13 | | | | |
| D14 | | | | |
| D15 | | | | |
| D16 | | | | |
| D17 | | | | |
| D18 | | | | |
| D19 | | | | |
| D20 | | | | |
| D21 | | | | |
| D22 | | | | |

POSIZIONE ADESIVI IN LINGUA PER /
POSITION STICKERS IN LANGUAGE FOR

JLG/ANSI - X500AJ - MK2

Codici / codes

177768GB - 177768FR - 177768ES - 177768PT

Go to Discount-Equipment.com to order JLG parts

177768 ADESIVI IN LINGUA / ADHESIVES IN LANGUAGE**

JLG

| POSIZIONE | CODICE | REV. | DESCRIZIONE | QUANTITA' |
|-----------|----------|------|--|-----------|
| | 177768GB | | KIT ADESIVI SICUREZZA PIATTAFORMA AEREA X500AJ ANSI LINGUA INGLESE | |
| L1 | 07056100 | A | ADESIVO JLG PERICOLO SCHIACCIAMENTO L= 140x60,71 MM | 14 |
| L2 | 1706387 | A | ADESIVO JLG PERICOLO SCHIACCIAMENTO L=177,80x69,85 MM (SUL CESTO) | 01 |
| L3 | 1706099 | A | ADESIVO JLG PERICOLO SCHIACCIAMENTO L= 161,92X69,85 MM (A TERRA) | 01 |
| L4 | 1702868 | B | ADESIVO JLG PERICOLO SCHIACCIAMENTO MANO - ING L= 241,30X25.40 MM __ MOD_B (**)(CESTO) | 02 |
| L5 | 07056200 | A | ADESIVO JLG ATTACCO SCHIACCIAMENTO ARTO INFERIORE L= 110x60 (PRES. STABILIZZATORI) | 04 |
| L6 | 1706386 | A | ADESIVO JLG PERICOLO CADUTE L=196,85x76,2 MM | 01 |
| L7 | 07051100 | B | ADESIVO JLG PERICOLO CADUTA - RIPRISTINARE I TAPPI - ING L=196,5x35 MM __ MOD_B | 01 |
| L8 | 07051000 | A | ADESIVO JLG ATTENZIONE CADUTE SBLOCCARE SOLO NEI CASI PREVISTI D Ø 60 FORO 4 MM | 02 |
| L9 | 1706133 | C | ADESIVO JLG PERICOLO RIBALTAMENTO - ING L=139,7X68,85 MM __ MOD_C | 01 |
| L10 | 07058600 | A | ADESIVO JLG POSIZIONE STABILIZZATORI X390, X550 | 01 |
| L11 | 076787GB | A | ADESIVO JLG PULSANTI DISTRIBUTORE PARTE AEREA X770AJ L=318X52 MM | 01 |
| L12 | 07042100 | A | ADESIVO JLG SISTEMA BYPASS PARTE AEREA L=30X50 | 01 |
| L13 | 07042200 | A | ADESIVO JLG SISTEMA BYPASS TRASLAZIONE L= 30X50 | 01 |
| L14 | 1702901 | A | ADESIVO JLG ISTRUZIONI DISCESA EMERGENZA / POMPA MANUALE L=114,3x58,73MM | 01 |
| L15 | 3252347 | B | ADESIVO JLG ATTENZIONE PEDALE - ING L= 69,85x57,15 MM __ MOD_B | 01 |
| L16 | 1706128 | E | ADESIVO JLG PERICOLO FOLGORAZIONE - ING L=120,65x91,50 MM __ MOD_E | 05 |
| L17 | 1703813 | A | ADESIVO JLG PERICOLO ESLOSIONE BATTERIE L=149,25X47,62 MM | 01 |
| L18 | 1704972 | C | ADESIVO JLG PERICOLO ESPLOSIONE - ING L=63,5x92,07 MM __ MOD_C | 01 |
| L19 | 072423GB | A | ADESIVO JLG ANSI CARICO MAX IN CESTA X500AJ | 02 |
| L20 | 1706385 | C | ADESIVO JLG SCORRIMENTO SBARRA CHIUSURA CESTO - ING L=184,15X25,4 MM __ MOD_C | 01 |
| L21 | 1705514 | A | ADESIVO JLG CONFORMITA' CSA L= 76,20x22,22 MM | 01 |
| L22 | 1706135 | B | ADESIVO JLG USO PIATTAFORMA - ING L=139,70x88,90 MM __ MOD_B | 01 |
| L23 | 072422GB | A | ADESIVO JLG ANSI ISTRUZIONI DISCESA DI EMERG. X500AJ GB | 01 |

TABELLA PERNI/SPINE (PINS TABLE)

LOCKING SYSTEM
GHIERA
(LOCKNUTS CODE)
REF. TABLE BELOW

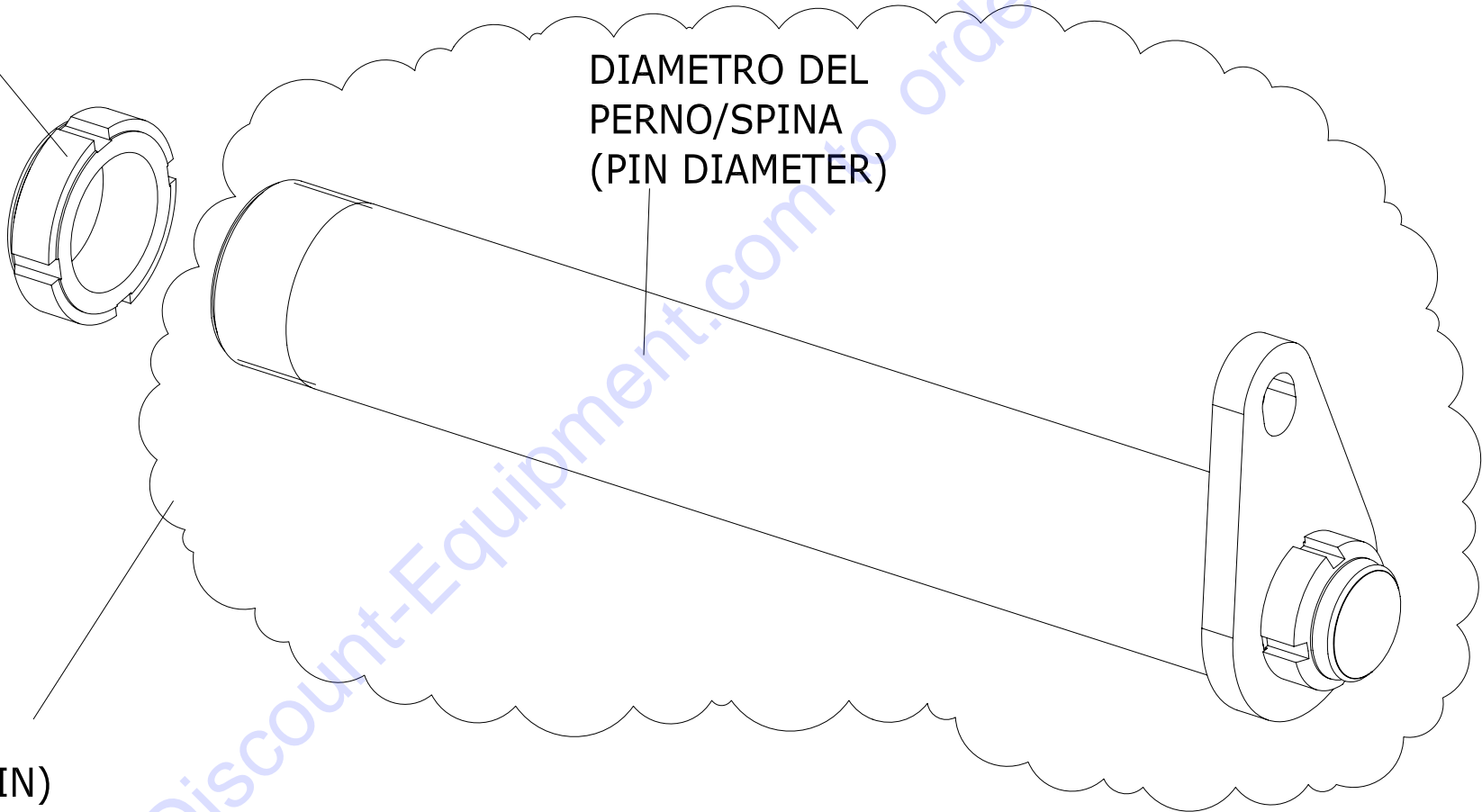



PERNO/SPINA (PIN)

IL CODICE DEL PERNO A RICAMBIO COMPRENDE LA GOCCIA MONTATA E LA GHIERA DI FISSAGGIO DELLA GOCCIA



THE CODE OF A PIN INCLUDES DROP PARTS MOUNTED AND THE LOCK NUT TO FIXING THE DROP, ALL THESE PARTS ARE SHIPPED ALREADY MOUNTED TOGETHER

| DIAMETRO DEL PERNO/SPINA mm SISTEMA METRICO (PIN DIAMETER mm METRIC) | GHIERA (LOCKNUTS CODE) | DADO (NUTS CODE) |
|---|-------------------------------|-------------------------|
| 25 | BG4 | |
| 30 | BG5 | |
| 35 | BG3 | |
| 40 | BG2 | |
| 45 | BG7 | |
| 50 | BG8 | |
| 20 (DIAMETER OF THREADED PART M17 PITCH=1) | BG1 | |
| 20 (DIAMETER OF THREADED PART M20 PITCH=1) | BG6 | |
| 20 (DIAMETER OF THREADED PART M20 PITCH=1,5) | BG12 | |

Go to Discount-Equipment.com to Order your parts

| POS | Codice | U.M. |  Descrizione |  Description |
|------|----------|------|---|---|
| BC1 | BC000100 | NR | COPPIGLIA 4X40 | COTTER PIN 4x40 |
| BC2 | BC000200 | NR | COPPIGLIA 5X40 | COTTER PIN 5x40 |
| BC3 | BC000300 | NR | SEEGER ESTERNO Ø20 | SEEGER EXTERNAL Ø20 |
| BC4 | BC000400 | NR | SEEGER ESTERNO Ø8 | SEEGER EXTERNAL Ø8 |
| BC5 | BC000500 | NR | SEEGER ESTERNO Ø25 | SEEGER EXTERNAL Ø25 |
| BC6 | BC000600 | NR | COPPIGLIA 1,8X8 | COTTER PIN 1,8X8 |
| BC7 | BC000700 | NR | COPPIGLIA 4X55 | COTTER PIN 4x55 |
| BD1 | BD000100 | NR | Dado Esagonale Flangiato Liscio PG DIN 6923 CI 8 M 14 Z.Bianca | Hex Flange Nut DIN 6923 CI Smooth PG 8 M 14 Z. white |
| BD2 | BD000200 | NR | Dado Esagonale Basso PG DIN 936 CI 04 M 8 Z.Bianca | Low Hex nut DIN 936 PG 04 M CI 8 Z. white |
| BD3 | BD000300 | NR | Dado Esagonale Alto PG UNI 5587 CI 8 M 8 Z.Bianca | Hex Nut High PG UNI 5587 CI 8 M 8 Z. white |
| BD4 | BD000400 | NR | Dado Alto Autobloccante PG DIN 982 CI 8 M 12 Z.Bianca | High Self Locking Nut DIN 982 PG 12 CI 8 M Z. white |
| BD5 | BD000500 | NR | Dado Alto Autobloccante PG DIN 982 CI 8 M 8 Z.Bianca | High Self Locking Nut DIN 982 PG CI 8 M 8 Z. white |
| BD6 | BD000600 | NR | Dado Esagonale Alto PG UNI 5587 CI 8 M 4 Z.Bianca | Hex Nut High PG UNI 5587 M 4 CI 8 Z. white |
| BD7 | BD000700 | NR | Dado Esagonale Basso PG DIN 936 CI 04 M 6 Z.Bianca | Low Hex nut DIN 936 PG 6 CI 04 M Z. white |
| BD8 | BD000800 | NR | Dado Basso Autobloccante PG DIN 985 CI 8 M 6 Z.Bianca | Low Self-locking nut DIN 985 PG 6 CI 8 M Z. white |
| BD9 | BD000900 | NR | Dado Alto Autobloccante PG DIN 982 CI 8 M 6 Z.Bianca | High Self Locking Nut DIN 982 PG CI 8 M6 Z. white |
| BD10 | BD001000 | NR | Dado Basso Autobloccante PG DIN 985 CI 8 M 5 Z.Bianca | Low Self-locking nut DIN 985 PG CI 8 M5 Z. white |
| BD11 | BD001100 | NR | Dado Alto Autobloccante PG DIN 982 CI 8 M 5 Z.Bianca | High Self Locking Nut DIN 982 PG CI 8 M5 Z. white |

| POS | Codice | U.M. |  Descrizione |  Description |
|------|----------|------|---|---|
| BD12 | BD001200 | NR | Dado Alto Autobloccante PG DIN 982 CI 8 M 4 Z.Bianca | High Self Locking Nut DIN 982 PG CI 8 M4 Z. white |
| BD13 | BD001300 | NR | Dado Alto Autobloccante PG DIN 982 CI 8 M 3 Z.Bianca | High Self Locking Nut DIN 982 PG CI 8 M3 Z. white |
| BD14 | BD001400 | NR | Dado Alto Autobloccante PF DIN 982 CI 8 M 20 x 1,5 Z.Bianca | High Self Locking Nut DIN 982 PF CI 8 M 20 x 1.5 Z white |
| BD15 | BD001500 | NR | Dado Alto Autobloccante PG DIN 982 CI 8 M 10 Z.Bianca | High Self Locking Nut DIN 982 PG CI 8 M10 Z. white |
| BD16 | BD001600 | NR | Dado Esagonale Alto PG UNI 5587 CI 8 M 3 Z.Bianca | Hex Nut High PG UNI 5587 CI 8 M3 Z. white |
| BD17 | BD001700 | NR | Dado Basso Autobloccante PG DIN 985 CI 8 M 8 Z.Bianca | Low Self-locking nut DIN 985 PG CI 8 M8 Z. white |
| BD18 | BD001800 | NR | Dado Alto Autobloccante PG DIN 982 CI 8 M 16 Z.Bianca | High Self Locking Nut DIN 982 PG CI 8 M16 Z. white |
| BD19 | BD001900 | NR | Dado Alto Autobloccante PF DIN 982 CI 8 M 20 x 1,5 Z.Bianca H=20 ribassato | High Self Locking Nut DIN 982 PF CI 8 M 20 x 1.5 Z White H = 20 low |
| BD22 | BD002200 | NR | Dado Alto Autobloccante PG DIN 982 CI 8 M 14 Z.Bianca | Hex Flange Nut DIN 982 CI 8 M 14 Z. white |
| BD23 | BD002300 | NR | Dado Basso Autobloccante PG DIN 985 CI 8 M 10 Z.Bianca | Low Self-locking nut DIN 985 PG CI 8 M 10 Z. white |
| BD24 | BD002400 | NR | Dado Alto Autobloccante PG DIN 982 CI 8 M 24 Z.Bianca | High Self Locking Nut DIN 982 PG CI 8 M24 Z. white |
| BD25 | BD002500 | NR | Dado Esagonale Alto PG UNI 5587 CI 8 M 6 Z.Bianca | Hex Nut High PG UNI 5587 M 6 CI 8 Z. white |
| BD26 | BD002600 | NR | Dado Esagonale Alto PG UNI 5587 CI 8 M 10 Z.Bianca | Hex Nut High PG UNI 5587 M 10 CI 8 Z. white |
| BD27 | BD002700 | NR | Dado Alto Autobloccante PG DIN 982 CI 8 M 18 Z.Bianca | High Self Locking Nut DIN 982 PG CI 8 M18 Z. white |
| BD28 | BD002800 | NR | Dado Basso Autobloccante PG DIN 985 CI 8 M 16 Z.Bianca | Low Self-locking nut DIN 985 PG CI 8 M 16 Z. white |
| BD29 | BD002900 | NR | Dado Esagonale Alto PG UNI 5587 CI 8 M 5 Z.Bianca | Hex Nut High PG UNI 5587 M 5 CI 8 Z. white |
| BD30 | BD003000 | NR | Dado Esagonale Alto PG UNI 5587 CI 12 M 5 Z.Bianca | Hex Nut High PG UNI 5587 M 5 CI 12 Z. white |

| POS | Codice | U.M. |  Descrizione |  Description |
|------|----------|------|---|---|
| BD31 | BD003100 | NR | Dado Esagonale Alto PG UNI 5587 CI 16 M 5 Z.Bianca | Hex Nut High PG UNI 5587 M 5 CI 16 Z. white |
| BD32 | BD003200 | NR | Dado Alto Autobloccante PG DIN 982 CI 8 M 20 Z.Bianca | High Self Locking Nut DIN 982 PG CI 8 M20 Z. white |
| BD33 | BD003300 | NR | Dado Basso Autobloccante PG DIN 985 CI 8 M 12 Z.Bianca | Low Self-locking nut DIN 985 PG CI 8 M 12 Z. white |
| BG1 | BG000100 | NR | Ghiera autobloccante GN CI 6 GN 3 D. 17 x 1 Z.Bianca | Self-locking nut GN GN 3 CI 6 D. 17 x 1 Z. white |
| BG2 | BG000200 | NR | Ghiera autobloccante pesante CI 6 GUP 40 x 1,5 Z.Bianca | Self-locking nut heavy CI 6 GUP 40 x 1.5 Z white |
| BG3 | BG000300 | NR | Ghiera autobloccante pesante CI 6 GUP 35 x 1,5 Z.Bianca | Self-locking nut heavy CI 6 GUP 35 x 1.5 Z white |
| BG4 | BG000400 | NR | Ghiera autobloccante pesante CI 6 GUP 25 x 1,5 Z.Bianca | Self-locking nut heavy CI 6 GUP 25 x 1.5 Z white |
| BG5 | BG000500 | NR | Ghiera autobloccante pesante CI 6 GUP 30 x 1,5 Z.Bianca | Self-locking nut heavy CI 6 GUP 30 x 1.5 Z white |
| BG6 | BG000600 | NR | Ghiera autobloccante pesante CI 6 GUP 20 x 1 Z.Bianca | Self-locking nut heavy CI 6 GUP 20 x 1 Z. white |
| BG7 | BG000700 | NR | Ghiera autobloccante GN CI 6 GN 3 D. 45 x 1,5 Z.Bianca | NUT |
| BG8 | BG000800 | NR | Ghiera autobloccante GN CI 6 GN 3 D. 50 x 1,5 Z.Bianca | NUT |
| BG9 | BG000900 | NR | Ghiera autobloccante GN CI 6 GN 3 D. 20 x 1,5 Z.Bianca | NUT |
| BG10 | BG001000 | NR | Ghiera autobloccante ribassata CI 6 GUK 25 x 1,5 Z.Bianca | Self-locking nut lowered CI 6 GUK 25 x 1.5 Z.Bianca |
| BG11 | BG001100 | NR | Ghiera autobloccante ribassata CI 6 GUK 20 x 1 Z.Bianca | Self-locking nut lowered CI 6 GUK 20 x 1 Z.Bianca |
| BG12 | BG001200 | NR | Ghiera autobloccante ribassata CI 6 GUA 20 x 1.5 Z.Bianca | Self-locking nut lowered CI 6 GUA 20 x 1.5 Z.Bianca |
| BG13 | BG001300 | NR | Ghiera autobloccante ribassata CI 6 GUK 30 x 1.5 Z.Bianca | Self-locking nut lowered CI 6 GUK 30 x 1.5 Z.Bianca |
| BG14 | BG001400 | NR | Ghiera autobloccante ribassata CI 6 GUK 45 x 1.5 Z.Bianca | Self-locking nut lowered CI 6 GUK 45 x 1.5 Z.Bianca |
| BG15 | BG001500 | NR | Ghiera autobloccante ribassata CI 6 GUK 50 x 1.5 Z.Bianca | Self-locking nut lowered CI 6 GUK 50 x 1.5 Z.Bianca |

| POS | Codice | U.M. |  Descrizione |  Description |
|------|----------|------|---|---|
| BG16 | BG001600 | NR | Ghiera autobloccante ribassata CI 6 GUK 55 x 1.5 Z.Bianca | Self-locking nut lowered CI 6 GUK 55 x 1.5 Z.Bianca |
| BI1 | BI000100 | NR | INSERTO ESAGONALE M6 | INSERT HEX M6 |
| BI2 | BI000200 | NR | INSERTO ESAGONALE M5 | INSERT HEX M5 |
| BI3 | BI000300 | NR | INSERTO CILINDRICO M4 | INSERT M4 |
| BI4 | BI000400 | NR | INSERTO CILINDRICO M6 | INSERT M6 |
| BR1 | BR000100 | NR | Grower sez.rett.spigoli vivi pesante UNI 9195 Acc.Molle D 6 Z.D.Bianca | Grower sez.rett. sharp heavy UNI 9195 Acc.Molle D 6 Z.D. white |
| BR2 | BR000200 | NR | Rondella Piana DIN 125-A HV100 D 4 Z.Bianca | Plain washer DIN 125-A HV100 D 4 Z. white |
| BR3 | BR000300 | NR | Rondella Piana DIN 125-A HV100 D 5 Z.Bianca | Plain washer DIN 125-A HV100 D 5 Z. white |
| BR4 | BR000400 | NR | Rondella Piana DIN 125-A HV100 D 6 Z.Bianca | Plain washer DIN 125-A HV100 D 6 Z. white |
| BR5 | BR000500 | NR | Rondella Piana DIN 125-A HV100 D 8 Z.Bianca | Plain washer DIN 125-A HV100 D 8 Z. white |
| BR6 | BR000600 | NR | Rondella Piana DIN 125-A HV100 D 10 Z.Bianca | Plain washer DIN 125-A HV100 D 10 Z. white |
| BR7 | BR000700 | NR | Rondella Piana DIN 125-A HV100 D 12 Z.Bianca | Plain washer DIN 125-A HV100 D 12 Z. white |
| BR8 | BR000800 | NR | Rosetta piana fascia larga e=3d DIN 9021 HV100 D 10 x 30 x 2,5 Z.Bianca | Wide band and flat washer DIN 9021 HV100 3d = D 10 x 30 x 2.5 Z white |
| BR9 | BR000900 | NR | Rosetta piana fascia larga e=3d DIN 9021 HV100 D 12 x 36 x 2,5 Z.Bianca | Wide band and flat washer DIN 9021 HV100 3d = D 12 x 36 x 2.5 Z white |
| BR10 | BR001000 | NR | Rondella x Carpenteria DIN 6916 HV 300 D 16 Z.Bianca | Carpentry washer DIN 6916 HV 300 D 16 Z white |
| BR11 | BR001100 | NR | Rosette speciali HV100 D 25 x 51 x 1 Z.Bianca | Special washers HV100 D 25 x 51 x 1 Z. white |
| BR13 | BR001300 | NR | Rondella dentellatura esterna DIN 6798-A Acc.Molle D 3 Z.D.Bianca | Washer external serration DIN 6798-A Acc.Molle D 3 ZD white |

| POS | Codice | U.M. |  Descrizione |  Description |
|------|----------|------|---|---|
| BR14 | BR001400 | NR | Rosetta piana fascia larga e=3d DIN 9021 HV100 D 5 x 15 x 1,2 Z.Bianca | Wide band and flat washer DIN 9021 HV100 3d = D 5 x 15 x 1.2 Z whit |
| BR15 | BR001500 | NR | Rosetta piana fascia larga e=3d DIN 9021 HV100 D 6 x 18 x 1,5 Z.Bianca | Wide band and flat washer DIN 9021 HV100 3d = D 6 x 18 x 1.5 Z white |
| BR16 | BR001600 | NR | Rosetta piana fascia larga e=3d DIN 9021 HV100 D 8 x 24 x 2 Z.Bianca | Wide band and flat washer DIN 9021 HV100 3d = D 8 x 24 x 2 Z. white |
| BR17 | BR001700 | NR | Rosetta piana fascia larga e=3d DIN 9021 HV100 D 4 x 12 x 1 Z.Bianca | Wide band and flat washer DIN 9021 HV100 D = 3d 4 x 12 x 1 Z. white |
| BR18 | BR001800 | NR | Rondella Piana DIN 125-A NYLON D 4 | Plain washer DIN 125-A NYLON D 4 |
| BR19 | BR001900 | NR | Rondella Piana DIN 125-A HV100 D 3 Z.Bianca | Plain washer DIN 125-A HV100 D 3 Z. white |
| BR20 | BR002000 | NR | Rondella Piana DIN 125-A HV100 D 16 Z.Bianca | Plain washer DIN 125-A HV100 D 16 Z. white |
| BR21 | BR002100 | NR | Rosetta piana fascia larga e=3d DIN 9021 HV100 D 16 x 48 x 4 Z.Bianca | Wide band and flat washer DIN 9021 HV100 3d = D 16 x 48 x 4 Z. white |
| BR22 | BR002200 | NR | Grower sez.rett.spigoli vivi pesante UNI 9195 Acc.Molle D 8 Z.D.Bianca | Grower section. rect. sharp heavy UNI 9195 Stainless Springs D 8 Z.D. white |
| BR23 | BR002300 | NR | Rosetta piana fascia larga e=3d DIN 9021 HV100 D 3 x 12 x 1 Z.Bianca | Wide band and flat washer DIN 9021 HV100 D = 3d 3 x 12 x 1 Z. white |
| BR24 | BR002400 | NR | Rosetta piana fascia larga e=3d DIN 9021 HV100 D 14 x 42 x 3 Z.Bianca | Wide band and flat washer DIN 9021 HV100 D = 3d 14 x 42 x 3 Z. white |
| BR25 | BR002500 | NR | Grower sez.rett.spigoli vivi pesante UNI 9195 Acc.Molle D 10 Z.D.Bianca | Grower sez.rett. sharp heavy UNI 9195 Acc.Molle D 10 Z.D. white |
| BR26 | BR002600 | NR | Rondella Piana DIN 125-A D 30 Z.Bianca | Plain washer DIN 125-A D 30 Z. white |
| BR27 | BR002700 | NR | Rondella Piana DIN 125-A HV100 D 14 Z.Bianca | Plain washer DIN 125-A HV100 D 14 Z. white |
| BR28 | BR002800 | NR | Rosetta piana fascia larga D 6 x 24 x 2 Z.Bianca | Wide band and flat washer D 6 x 24 x 2 Z white |
| BR29 | BR002900 | NR | Rondella Piana DIN 125-A HV100 D 18 Z.Bianca | Plain washer DIN 125-A HV100 D 18 Z. white |

| POS | Codice | U.M. |  Descrizione |  Description |
|------|----------|------|---|---|
| BR30 | BR003000 | NR | Rondella Piana DIN 125-A HV100 D 20 Z.Bianca | Plain washer DIN 125-A HV100 D 20 Z. white |
| BR31 | BR003100 | NR | Grower sez.rett.spigoli vivi pesante UNI 9195 Acc.Molle D 12 Z.D.Bianca | Grower sez.rett. sharp heavy UNI 9195 Acc.Molle D 12 Z.D. white |
| BR32 | BR003200 | NR | Rosette speciali HV100 D 30 x 42 x 0.5 Z.Bianca | Special washers HV100 D 30 x 42 x 0.5 Z. white |
| BR33 | BR003300 | NR | Rosette speciali HV100 D 30 x 61 x 1 Z.Bianca | Special washers HV100 D 30 x 61 x 1 Z. white |
| BR34 | BR003400 | NR | Rosette speciali HV100 D 42 x 52 x 0.2 Z.Bianca | Special washers HV100 D 42 x 52 x 0.2 Z. white |
| BR35 | BR003500 | NR | Rosette speciali HV100 D 42 x 52 x 0.3 Z.Bianca | Special washers HV100 D 42 x 52 x 0.3 Z. white |
| BR36 | BR003600 | NR | Rosette speciali HV100 D 42 x 52 x 1 Z.Bianca | Special washers HV100 D 42 x 52 x 1 Z. white |
| BR37 | BR003700 | NR | Rosette speciali HV100 D 42 x 52 x 1.5 Z.Bianca | Special washers HV100 D 42 x 52 x 1.5 Z. white |
| BR38 | BR003800 | NR | Rosette speciali HV100 D 42 x 52 x 2 Z.Bianca | Special washers HV100 D 42 x 52 x 2 Z. white |
| BR39 | BR003900 | NR | Rosetta piana fascia larga e=3d DIN 9021 HV100 D 18 x 48 x 4 Z.Bianca | Wide band and flat washer DIN 9021 HV100 3d = D 18 x 48 x 4 Z. white |
| BR40 | BR004000 | NR | Rosetta SCHNORR zincate D 6 | WASHER |
| BR41 | BR004100 | NR | Grower sez.rett.spigoli vivi pesante UNI 9195 Acc.Molle D 14 Z.D.Bianca | Grower sez.rett. sharp heavy UNI 9195 Acc.Molle D 14 Z.D. white |
| BR42 | BR004200 | NR | Rondella x Carpenteria DIN 6916 HV 300 D 14 Z.Bianca | Carpentry washer DIN 6916 HV 300 D 14 Z white |
| BR43 | BR004300 | NR | Rondella x Carpenteria DIN 125-A HV 300 D 10 Z.Bianca | Carpentry washer DIN 125-A HV 300 D 10 Z white |
| BS1 | BS000100 | NR | GRANO FILETTATO M6X12 | SCREW |
| BS2 | BS000200 | NR | SPINA CIL. 8x16 UNI 6364-A h6 CMT + TMP | PIN CYLINDER 8 x 16 UNI 6364-A CMT h6 + TMP |
| BS3 | BS000300 | NR | PRIGIONIERO M10X35 | PIN |

| POS | Codice | U.M. |  Descrizione |  Description |
|------|----------|------|---|---|
| BS4 | BS000400 | NR | SPINA ELASTICA 6X60 UNI 6873 | PIN |
| BS5 | BS000500 | NR | SPINA ELASTICA 6X14 UNI 6873 | PIN |
| BS6 | BS000600 | NR | Spina Spirol Normale DIN 7343 INOX A2 D 5x10 | PIN |
| BS7 | BS000700 | NR | Rivetto alluminio Ø3x12 | Aluminum rivet Ø3x12 |
| BV1 | BV000100 | NR | Vite TE Parziale Filetto PG DIN 931 CI 8.8 M 8 x 80 Z.Bianca | Screw Partial Thread DIN 931 PG CI 8.8 M 8 x 80 Z. white |
| BV2 | BV000200 | NR | Vite TE Tutto Filetto PG DIN 933 CI 8.8 M 8 x 60 Z.Bianca | Screw All Thread DIN 933 PG CI 8.8 M 8 x 60 Z. white |
| BV3 | BV000300 | NR | Vite TCEI PG DIN 912 CI 8.8 M 8 x 60 Z.Bianca | Screw DIN 912 PG CI 8.8 M8 x 60 Z. white |
| BV4 | BV000400 | NR | Vite TE Parziale Filetto PG DIN 931 CI 8.8 M 8 x 50 Z.Bianca | Screw Partial Thread DIN 931 PG CI 8.8 M 8 x 50 Z. white |
| BV5 | BV000500 | NR | Vite TCEI PG DIN 912 CI 8.8 M 8 x 45 Z.Bianca | Screw DIN 912 PG CI 8.8 M8 x 45 Z. white |
| BV6 | BV000600 | NR | Vite TCEI PG DIN 912 CI 8.8 M 8 x 40 Z.Bianca | Screw DIN 912 PG CI 8.8 M8 x 40 Z.Bianca |
| BV7 | BV000700 | NR | Vite TE Tutto Filetto PG DIN 933 CI 8.8 M 8 x 35 Z.Bianca | Screw All Thread DIN 933 PG CI 8.8 M 8 x 35 Z. white |
| BV8 | BV000800 | NR | Vite TE Tutto Filetto PG DIN 933 CI 8.8 M 8 x 30 Z.Bianca | Screw All Thread DIN 933 PG CI 8.8 M 8 x 30 Z. white |
| BV9 | BV000900 | NR | Vite TE Tutto Filetto PG DIN 933 CI 8.8 M 8 x 25 Z.Bianca | Screw All Thread DIN 933 PG CI 8.8 M 8 x 25 Z. white |
| BV10 | BV001000 | NR | Vite TCEI PG DIN 912 CI 8.8 M 8 x 25 Z.Bianca | Screw DIN 912 PG CI 8.8 M8 x 25 Z. white |
| BV11 | BV001100 | NR | Vite TE Tutto Filetto PG DIN 933 CI 8.8 M 8 x 20 Z.Bianca | Screw All Thread DIN 933 PG CI 8.8 M 8 x 20 Z. white |
| BV12 | BV001200 | NR | Vite TE Tutto Filetto PG DIN 933 CI 8.8 M 8 x 16 Z.Bianca | Screw All Thread DIN 933 PG CI 8.8 M 8 x 16 Z. white |
| BV13 | BV001300 | NR | Vite TCEI PG DIN 912 CI 8.8 M 8 x 16 Z.Bianca | Screw DIN 912 PG CI 8.8 M8 x 16 Z. white |
| BV14 | BV001400 | NR | Vite TE Tutto Filetto PG DIN 933 CI 8.8 M 8 x 14 Z.Bianca | Screw All Thread DIN 933 PG CI 8.8 M 8 x 14 Z. white |

| POS | Codice | U.M. |  Descrizione |  Description |
|------|----------|------|---|---|
| BV15 | BV001500 | NR | Vite TCEI PG DIN 912 CI 8.8 M 6 x 45 Z.Bianca | Screw DIN 912 M6 x 45 CI 8.8 Z. white |
| BV16 | BV001600 | NR | Vite TCEI PG DIN 912 CI 8.8 M 6 x 30 Z.Bianca | Screw DIN 912 M6 x 30 CI 8.8 Z. white |
| BV17 | BV001700 | NR | Vite TSPEI PG DIN 7991 CI 10.9 M 6 x 30 Z.Bianca | screw DIN 7991 CI 10.9 M 6 x 30 Z. white |
| BV18 | BV001800 | NR | Vite TE Tutto Filetto PG DIN 933 CI 8.8 M 6 x 30 Z.Bianca | Screw All Thread DIN 933 PG CI 8.8 M 6 x 30 Z. white |
| BV19 | BV001900 | NR | Vite TBEI PG ISO 7380 CI 10.9 M 6 x 30 Z.Bianca | screw ISO 7380 CI 10.9 M 6 x 30 Z. white |
| BV20 | BV002000 | NR | Vite TE Tutto Filetto PG DIN 933 CI 8.8 M 6 x 12 Z.Bianca | Screw All Thread DIN 933 PG CI 8.8 M 6 x 12 Z. white |
| BV21 | BV002100 | NR | Vite TCEI PG DIN 912 CI 8.8 M 6 x 12 Z.Bianca | Screw DIN 912 PG CI 8.8 M 6 x 12 Z. white |
| BV22 | BV002200 | NR | Vite TCEI PG DIN 912 CI 8.8 M 5 x 45 Z.Bianca | Screw DIN 912 PG CI 8.8 M 5 x 45 Z. white |
| BV23 | BV002300 | NR | Vite TE UNF ANSI B18.2.1 GR.5 5/16 x 1" Z.Bianca | Screw UNF ANSI B18.2.1 GR.5 5/16 x 1 "Z. White |
| BV24 | BV002400 | NR | Vite TC Croce PG DIN 7985 CI 4.8 M 4 x 8 Z.Bianca | Cross head screw DIN 7985 PG CI 4.8 M 4 x 8 Z. white |
| BV25 | BV002500 | NR | Vite TCEI PG DIN 912 CI 8.8 M 4 x 16 Z.Bianca | Screw DIN 912 PG CI 8.8 M 4 x 16 Z. white |
| BV26 | BV002600 | NR | Vite TCEI PG DIN 912 CI 8.8 M 6 x 50 Z.Bianca | Screw DIN 912 PG CI 8.8 M 6 x 50 Z. white |
| BV27 | BV002700 | NR | Vite TSPEI PG DIN 7991 CI 10.9 M 6 x 40 Z.Bianca | screw DIN 7991 CI 10.9 M 6 x 40 Z. white |
| BV28 | BV002800 | NR | Vite TSPEI PG DIN 7991 CI 10.9 M 6 x 25 Z.Bianca | screw DIN 7991 CI 10.9 M 6 x 25 Z. white |
| BV29 | BV002900 | NR | Vite TE Tutto Filetto PG DIN 933 CI 8.8 M 6 x 25 Z.Bianca | Screw All Thread DIN 933 PG CI 8.8 M 6 x 25 Z. white |
| BV30 | BV003000 | NR | Vite TE Tutto Filetto PG DIN 933 CI 8.8 M 6 x 22 Z.Bianca | Screw All Thread DIN 933 PG CI 8.8 M 6 x 22 Z. white |
| BV31 | BV003100 | NR | Vite TSPEI PG DIN 7991 CI 10.9 M 6 x 20 Z.Bianca | screw DIN 7991 CI 10.9 M 6 x 20 Z. white |
| BV32 | BV003200 | NR | Vite TE Tutto Filetto PG DIN 933 CI 8.8 M 6 x 20 Z.Bianca | Screw All Thread DIN 933 PG CI 8.8 M 6 x 20 Z. white |

| POS | Codice | U.M. |  Descrizione |  Description |
|------|----------|------|---|---|
| BV33 | BV003300 | NR | Vite TCEI PG DIN 912 CI 8.8 M 6 x 20 Z.Bianca | Screw DIN 912 PG CI 8.8 M 6 x 20 Z. white |
| BV34 | BV003400 | NR | Vite TE Tutto Filetto PG DIN 933 CI 8.8 M 6 x 16 Z.Bianca | Screw All Thread DIN 933 PG CI 8.8 M 6 x 16 Z. white |
| BV35 | BV003500 | NR | Vite TBEI PG ISO 7380 CI 10.9 M 6 x 16 Z.Bianca | screw ISO 7380 CI 10.9 M 6 x 16 Z. white |
| BV36 | BV003600 | NR | Vite TCEI PG DIN 912 CI 8.8 M 5 x 8 Z.Bianca | Screw DIN 912 PG CI 8.8 M 5 x 8 Z. white |
| BV37 | BV003700 | NR | Vite TSPEI PG DIN 7991 CI 10.9 M 5 x 60 Z.Bianca | screw DIN 7991 CI 10.9 M 5 x 60 Z. white |
| BV38 | BV003800 | NR | Vite TE Parziale Filetto PG DIN 931 CI 8.8 M 5 x 60 Z.Bianca | Screw Partial Thread DIN 931 PG CI 8.8 M 5 x 60 Z. white |
| BV39 | BV003900 | NR | Vite TCEI PG DIN 912 CI 8.8 M 5 x 60 Z.Bianca | Screw DIN 912 PG CI 8.8 M 5 x 60 Z. white |
| BV40 | BV004000 | NR | Vite TE Parziale Filetto PG DIN 931 CI 8.8 M 5 x 55 Z.Bianca | Screw Partial Thread DIN 931 PG CI 8.8 M 5 x 55 Z. white |
| BV41 | BV004100 | NR | Vite TE Tutto Filetto PG DIN 933 CI 8.8 M 5 x 16 Z.Bianca | Screw All Thread DIN 933 PG CI 8.8 M 5 x 16 Z. white |
| BV42 | BV004200 | NR | Vite TC Croce PG DIN 7985 CI 4.8 M 5 x 16 Z.Bianca | Cross head screw DIN 7985 PG CI 4.8 M 5 x 16 Z. white |
| BV43 | BV004300 | NR | Vite TE Tutto Filetto PG DIN 933 CI 8.8 M 5 x 12 Z.Bianca | Screw All Thread DIN 933 PG CI 8.8 M 5 x 12 Z. white |
| BV44 | BV004400 | NR | Vite TE UNF ANSI B18.2.1 GR.5 5/16 x 1"1/4 Z.Bianca | Screw UNF ANSI B18.2.1 GR.5 5/16 x 1 "1/4 Z. White |
| BV45 | BV004500 | NR | Vite TE UNF ANSI B18.2.1 GR.5 5/16 x 1"1/4 Z.Bianca | Screw UNF ANSI B18.2.1 GR.5 5/16 x 1 "1/4 Z. White |
| BV46 | BV004600 | NR | Vite TCEI PG DIN 912 CI 8.8 M 4 x 40 Z.Bianca | Screw DIN 912 PG CI 8.8 M 4 x 40 Z. white |
| BV47 | BV004700 | NR | Vite Trilob. Autoform. TC Croce PG DIN 7500-C C15 M 4 x 40 Z.Bianca | Trilob Screw. Autoform. TC Cross PH DIN 7500-C C 15 M 4 x 40 Z. white |
| BV48 | BV004800 | NR | Vite Trilob. Autoform. TC Croce PG DIN 7500-C C15 M 4 x 20 Z.Bianca | Trilob Screw. Autoform. TC Cross PG DIN 7500-C C15 M 4 x 20 Z. white |
| BV49 | BV004900 | NR | Vite TC Croce PG DIN 7985 CI 4.8 M 4 x 16 Z.Bianca | Cross head screw DIN 7985 PG CI 4.8 M 4 x 16 Z. white |

| POS | Codice | U.M. |  Descrizione |  Description |
|------|----------|------|---|---|
| BV50 | BV005000 | NR | VITE AUTOFIETTANTE TE C/BORDINO DIN 6928 C15 4,8X50 Z.Bianca | TAPPING SCREW TE C / BORDINO DIN 6928 C15 4.8 X50 Z. white |
| BV51 | BV005100 | NR | VITE AUTOFIETTANTE TE C/BORDINO DIN 6928 C15 4,8X25 Z.Bianca | TAPPING SCREW TE C / BORDINO DIN 6928 C15 4.8 X25 Z. white |
| BV52 | BV005200 | NR | Vite TCEI PG DIN 912 CI 12.9 M 3 x 25 Z.D.Bianca | Screw DIN 912 M 3 CI 12.9 x 25 Z.D. white |
| BV53 | BV005300 | NR | Vite TSPEI PG DIN 7991 CI 10.9 M 3 x 14 Z.Bianca | Screw DIN 7991 CI 10.9 M 3 x 14 Z. white |
| BV54 | BV005400 | NR | Vite Autofil.TC Croce DIN 7981 C15 3,5 x 6,5 Z.Bianca | Autofil.TC Cross Screw DIN 7981 C15 3.5 x 6.5 Z. white |
| BV55 | BV005500 | NR | Vite TE Parziale Filetto PG DIN 931 CI 10.9 M 16 x 55 Z.D.Bianca | Screw Partial Thread DIN 931 PG CI 10.9 M 16 x 55 ZD white |
| BV56 | BV005600 | NR | Vite TE Tutto Filetto PG DIN 933 CI 8.8 M 16 x 40 Z.Bianca | Screw All Thread DIN 933 PG CI 8.8 M 16 x 40 Z. white |
| BV57 | BV005700 | NR | Vite TE Parziale Filetto PG DIN 931 CI 10.9 M 16 x 220 Z.Deidro Bianche | Screw Partial Thread DIN 931 PG CI 10.9 M 16 x 220 Z. dehydro White |
| BV58 | BV005800 | NR | Vite TE 8.8 DIN933 M16x20 Testa Alta 8 Zn Bianca | Screw M16x20 DIN933 8.8 Head High 8 Zn White |
| BV59 | BV005900 | NR | Vite TE Tutto Filetto PG DIN 933 CI 8.8 M 12 x 16 Z.Bianca | Screw All Thread DIN 933 PG CI 8.8 M 12 x 16 Z. white |
| BV60 | BV006000 | NR | Vite TE Parziale Filetto PG DIN 931 CI 8.8 M 12 x 120 Z.Bianca | Screw Partial Thread DIN 931 PG CI 8.8 M 12 x 120 Z. white |
| BV61 | BV006100 | NR | Vite TE Parziale Filetto PG DIN 931 CI 8.8 M 10 x 50 Z.Bianca | Screw Partial Thread DIN 931 PG CI 8.8 M 10 x 50 Z. white |
| BV62 | BV006200 | NR | Vite TE Tutto Filetto PG DIN 933 CI 8.8 M 10 x 35 Z.Bianca | Screw All Thread DIN 933 PG CI 8.8 M 10 x 35 Z. white |
| BV63 | BV006300 | NR | Vite TSPEI PG DIN 7991 CI 10.9 M 10 x 30 Z.Bianca | Screw DIN 7991 CI 10.9 M 10 x 30 Z. white |
| BV64 | BV006400 | NR | Vite TE Tutto Filetto PG DIN 933 CI 8.8 M 10 x 30 Z.Bianca | Screw All Thread DIN 933 PG CI 8.8 M 10 x 30 Z. white |
| BV65 | BV006500 | NR | Vite TCEI PG DIN 912 CI 12.9 M 10 x 25 Geo 321 A | Screw DIN 912 PG CI 12.9 M 10 x 25 Geo 321 A |
| BV66 | BV006600 | NR | Vite TCEI PG DIN 912 CI 8.8 M 10 x 25 Z.Bianca | Screw DIN 912 PG CI 8.8 M 10 x 25 Z. white |

| POS | Codice | U.M. |  Descrizione |  Description |
|------|----------|------|---|---|
| BV67 | BV006700 | NR | Vite TE Tutto Filetto PG DIN 933 CI 8.8 M 10 x 20 Z.Bianca | Screw All Thread DIN 933 PG CI 8.8 M 10 x 20 Z. white |
| BV68 | BV006800 | NR | Vite TE Tutto Filetto PG DIN 933 CI 8.8 M 10 x 18 Z.Bianca | Screw All Thread DIN 933 PG CI 8.8 M 10 x 18 Z. white |
| BV69 | BV006900 | NR | Vite Trilob. Autoform. TSP Croce PG DIN 7500-M C15 M 5 x 16 Z.Bianca | Trilob Screw. Autoform. TSP Cross PG DIN 7500-M C15 M 5 x 16 Z. white |
| BV70 | BV007000 | NR | Vite TE Parziale Filetto PG DIN 931 CI 8.8 M 8 x 70 Z.Bianca | Screw Partial Thread DIN 931 PG CI 8.8 M 8 x 70 Z. white |
| BV71 | BV007100 | NR | Vite TE Parziale Filetto PG DIN 931 CI 8.8 M 8 x 65 Z.Bianca | Screw Partial Thread DIN 931 PG CI 8.8 M 8 x 65 Z. white |
| BV72 | BV007200 | NR | Vite TE Parziale Filetto PG DIN 931 CI 8.8 M 6 x 55 Z.Bianca | Screw Partial Thread DIN 931 PG CI 8.8 M 6 x 55 Z. white |
| BV73 | BV007300 | NR | Vite TCEI PG DIN 912 CI 8.8 M 6 x 55 Z.Bianca | Screw DIN 912 PG CI 8.8 M 6 x 55 Z. white |
| BV74 | BV007400 | NR | Vite TCEI PG DIN 912 CI 8.8 M 6 x 16 Z.Bianca | Screw DIN 912 PG CI 8.8 M 6 x 16 Z. white |
| BV75 | BV007500 | NR | Vite TSPEI PG DIN 7991 CI 10.9 M 6 x 10 Z.Bianca | Screw DIN 7991 CI 10.9 M 6 x 10 Z. white |
| BV76 | BV007600 | NR | Vite TCEI PG DIN 912 CI 8.8 M 5 x 55 Z.Bianca | Screw DIN 912 PG CI 8.8 M 5 x 55 Z. white |
| BV77 | BV007700 | NR | Vite TC Croce PG DIN 7985 CI 4.8 M 6 x 16 Z.Bianca | Cross head screw DIN 7985 PG CI 4.8 M 6 x 16 Z. white |
| BV78 | BV007800 | NR | Vite Trilob. Autoform. TC Croce PG DIN 7500-C C15 M 5 x 12 Z.Bianca | Trilob Screw. Autoform. TC Cross PG DIN 7500-C C15 M 5 x 12 Z. white |
| BV79 | BV007900 | NR | Vite TE Tutto Filetto PG DIN 933 CI 8.8 M 4 x 35 Z.Bianca | Screw All Thread DIN 933 PG CI 8.8 M 4 x 35 Z. white |
| BV80 | BV008000 | NR | VITE AUTOFIETTANTE TE C/BORDINO DIN 6928 C15 4,8X35 Z.Bianca | TAPPING SCREW TE C / BORDINO DIN 6928 C15 4.8 X35 Z. white |
| BV81 | BV008100 | NR | Vite TCEI PG DIN 912 CI 12.9 M 3 x 14 Z.D.Bianca | Screw DIN 912 M 3 CI 12.9 x 14 Z.D. white |
| BV82 | BV008200 | NR | Vite TE Parziale Filetto PG DIN 931 CI 8.8 M 16 x 70 Z.Bianca | Screw Partial Thread DIN 931 PG CI 8.8 M 16 x 70 Z. white |
| BV83 | BV008300 | NR | Vite TE Parziale Filetto PG DIN 931 CI 8.8 M 16 x 260 Z.Bianca | Screw Partial Thread DIN 931 PG CI 8.8 M 16 x 260 Z. white |

| POS | Codice | U.M. |  Descrizione |  Description |
|-------|----------|------|---|---|
| BV84 | BV008400 | NR | Vite TE Parziale Filetto PG DIN 931 CI 8.8 M 12 x 110 Z.Bianca | Screw Partial Thread DIN 931 PG CI 8.8 M 12 x 110 Z. white |
| BV85 | BV008500 | NR | Vite TE Tutto Filetto PG DIN 933 CI 8.8 M 10 x 40 Z.Bianca | Screw Thread DIN 933 PG CI 8.8 M 10 x 40 Z. white |
| BV86 | BV008600 | NR | Vite TCEI PG DIN 912 CI 8.8 M 8 x 65 Z.Bianca | Screw DIN 912 PG CI 8.8 M 8 x 65 Z. white |
| BV87 | BV008700 | NR | Vite TCEI PG DIN 912 CI 8.8 M 8 x 20 Z.Bianca | Screw DIN 931 PG CI 8.8 M 10 x 40 Z. white |
| BV88 | BV008800 | NR | Vite TCEI PG DIN 912 CI 10.9 M 10 x 18 Z.Bianca | Screw DIN 912 PG CI 10.9 M 10 x 18 Z. white |
| BV89 | BV008900 | NR | Vite TCEI PG DIN 912 CI 8.8 M 8 x 70 Z.Bianca | Screw DIN 912 PG CI 8.8 M 8 x 70 Z. white |
| BV91 | BV009100 | NR | Vite TE Tutto Filetto PG DIN 933 CI 8.8 M 6 x 40 Z.Bianca | Screw All Thread DIN 933 PG CI 8.8 M 6 x 40 Z. white |
| BV92 | BV009200 | NR | Vite TE Tutto Filetto PG DIN 933 CI 8.8 M 10 x 60 Z.Bianca | Screw All Thread DIN 933 PG CI 8.8 M 10 x 60 Z. white |
| BV93 | BV009300 | NR | Vite TSPEI PG DIN 7991 CI 10.9 M 5 x 20 Z.Bianca | screw DIN 7991 CI 10.9 M 5 x 20 Z. white |
| BV94 | BV009400 | NR | Vite TC Croce PG DIN 7985 CI 4.8 M 4 x 12 Z.Bianca | Cross head screw DIN 7985 PG CI 4.8 M 4 x 12 Z. white |
| BV95 | BV009500 | NR | Vite TE Tutto Filetto PG DIN 933 CI 8.8 M 4 x 12 Z.Bianca | Screw All Thread DIN 933 PG CI 8.8 M 4 x 12 Z. white |
| BV96 | BV009600 | NR | Vite TCEI PG DIN 912 CI 12.9 M 12 x 30 Dac 320A | Screw DIN 912 CI 12.9 M 12 x 30 Dac 320A |
| BV97 | BV009700 | NR | Vite Autofil.Testa Mezza Tonda C15 4,8 x 13 Z.Bianca | Half Round Head Self Tapping Screw C15 4,8 x 13 |
| BV98 | BV009800 | NR | Vite TC Croce PG DIN 7985 CI 4.8 M 4 x 14 Z.Bianca | Screw DIN 7985 CI 4.8 M 4 x 14 |
| BV99 | BV009900 | NR | Vite TE Parziale Filetto PG DIN 931 CI 8.8 M 5 x 65 Z.Bianca | Screw Partial Thread DIN 931 PG CI 8.8 M 5 x 65 Z. white |
| BV100 | BV010000 | NR | Vite Autofil.Testa Mezza Tonda C15 4,8 x 16 Z.Bianca | Half Round Head Self Tapping Screw C15 4,8 x 16 |
| BV101 | BV010100 | NR | Vite TSPEI PG DIN 7991 CI 10.9 M 8 x 25 Z.Bianca | screw DIN 7991 CI 10.9 M 8 x 25 Z. white |
| BV102 | BV010200 | NR | Vite TCEI PG DIN 912 CI 8.8 M 4 x 30 Z.Bianca | Screw DIN 912 PG CI 8.8 M 4 x 30 White Z |

| POS | Codice | U.M. |  Descrizione |  Description |
|-------|----------|------|---|---|
| BV103 | BV010300 | NR | Vite TSPEI PG DIN 7991 CI 10.9 M 5 x 16 Z.Bianca | Screw DIN 7991 CI 10.9 M 5 x 16 Z. white |
| BV104 | BV010400 | NR | Vite TCEI bassa PG DIN 7984 CI 10.9 M 12 x 18 Z.D.Bianca | Screw DIN 7984 low PG CI 10.9 M 12 x 18 Z. D. white |
| BV105 | BV010500 | NR | Vite TE Parziale Filetto PG DIN 931 CI 8.8 M 12 x 75 Z.Bianca | Screw Partial Thread DIN 931 PG CI 8.8 M 12 x 75 Z. white |
| BV106 | BV010600 | NR | Vite TE Tutto Filetto PG DIN 933 CI 8.8 M 8 x 22 Z.Bianca | Screw All Thread DIN 933 PG CI 8.8 M 8 x 22 Z. white |
| BV107 | BV010700 | NR | Vite TE Tutto Filetto PG DIN 933 CI 8.8 M 6 x 35 Z.Bianca | Screw All Thread DIN 933 PG CI 8.8 M 6 x 35 Z. white |
| BV108 | BV010800 | NR | Vite TE Parziale Filetto PG DIN 931 CI 8.8 M 4 x 45 Z.Bianca | Screw Partial Thread DIN 931 PG CI 8.8 M 4 x 45 Z. white |
| BV109 | BV010900 | NR | Vite TE Tutto Filetto PG DIN 933 CI 10.9 M 16 x 45 Z.D.Bianca | Screw All Thread DIN 933 PG CI 10.9 M 16 x 45 ZD white |
| BV110 | BV011000 | NR | Vite TE Parziale Filetto PG DIN 931 CI 10.9 M 16 x 100 Z.D.Bianca | Screw Partial Thread DIN 931 PG CI 10.9 M 16 x 100 ZD white |
| BV111 | BV011100 | NR | Vite TE Parziale Filetto PG DIN 931 CI 10.9 M 16 x 105 Z.D.Bianca | Screw Partial Thread DIN 931 PG CI 10.9 M 16 x 105 ZD white |
| BV112 | BV011200 | NR | Vite TE Tutto Filetto PG DIN 933 CI 8.8 M 10 x 25 Z.Bianca | Screw All Thread DIN 933 PG CI 8.8 M 10 x 25 Z. white |
| BV113 | BV011300 | NR | Vite TSPEI PG DIN 7991 CI 10.9 M 6 x 50 Z.Bianca | TSPEI PG screw DIN 7991 CI 10.9 M 6 x 50 Z. white |
| BV114 | BV011400 | NR | Vite TSPEI PG DIN 7991 CI 10.9 M 8 x 25 Z.Bianca | TSPEI PG screw DIN 7991 CI 10.9 M 8 x 25 Z. white |
| BV115 | BV011500 | NR | Vite TE Tutto Filetto PG DIN 933 CI 8.8 M 10 x 45 Z.Bianca | Screw All Thread DIN 933 PG CI 8.8 M 10 x 45 Z. white |
| BV116 | BV011600 | NR | Vite TE Tutto Filetto PG DIN 933 CI 8.8 M 5 x 8 Z.Bianca | Screw All Thread DIN 933 PG CI 8.8 M 5 x 8 Z. white |
| BV117 | BV011700 | NR | Vite TE Tutto Filetto PG DIN 933 CI 8.8 M 8 x 18 Z.Bianca | Screw All Thread DIN 933 PG CI 8.8 M 8 x 18 Z. white |
| BV118 | BV011800 | NR | Vite TE Tutto Filetto PG DIN 933 CI 8.8 M 8 x 40 Z.Bianca | Screw All Thread DIN 933 PG CI 8.8 M 8 x 40 Z. white |
| BV119 | BV011900 | NR | Vite TCEI PG DIN 912 CI 8.8 M 8 x 100 Z.Bianca | Screw DIN 912 PG CI 8.8 M 8 x 100 Z. white |

| POS | Codice | U.M. |  Descrizione |  Description |
|-------|----------|------|---|---|
| BV120 | BV012000 | NR | Vite TCEI PG DIN 912 CI 8.8 M 8 x 110 Z.Bianca | Screw DIN 912 PG CI 8.8 M 8 x 110 Z. white |
| BV121 | BV012100 | NR | Vite TE Parziale Filetto PG DIN 931 CI 8.8 M 5 x 75 Z.Bianca | Screw Partial Thread DIN 931 PG CI 8.8 M 5 x 75 Z. white |
| BV122 | BV012200 | NR | Vite TE Parziale Filetto PG DIN 931 CI 8.8 M 12 x 130 Z.Bianca | Screw Partial Thread DIN 931 PG CI 8.8 M 12 x 130 Z. white |
| BV123 | BV012300 | NR | Vite TC Croce PG DIN 7985 CI 4.8 M 4 x 8 Z.Bianca | Cross head screw DIN 7985 PG CI 4.8 M 4 x 8 Z. white |
| BV124 | BV012400 | NR | Vite TCEI PG DIN 912 CI 8.8 M 6 x 40 Z.Bianca | Screw DIN 912 PG CI 8.8 M 6 x 40 Z. white |
| BV125 | BV012500 | NR | Vite TE Tutto Filetto PG DIN 933 CI 8.8 M 4 x 20 Z.Bianca | Screw All Thread DIN 933 PG CI 8.8 M 4 x 20 Z. white |
| BV126 | BV012600 | NR | Vite TE UNC ANSI B18.2.1 GR.5 3/8 x 1" Z.Bianca | Screw UNC ANSI B18.2.1 GR.5 3/8 x 1 "Z. White |
| BV127 | BV012700 | NR | Vite TE UNC ANSI B18.2.1 GR.5 3/8 x 1" 1/4Z.Bianca | Screw UNC ANSI B18.2.1 GR.5 3/8 x 1 "1/4 Z. White |
| BV128 | BV012800 | NR | Vite TE Tutto Filetto PG DIN 933 CI 8.8 M 4 x 16 Z.Bianca | Screw All Thread DIN 933 PG CI 8.8 M 4 x 16 Z. white |
| BV129 | BV012900 | NR | Vite TCEI PG DIN 912 CI 8.8 M 5 x 16 Z.Bianca | Screw DIN 912 PG CI 8.8 M 5 x 16 Z. white |
| BV130 | BV013000 | NR | Vite TCEI PG DIN 912 CI 8.8 M 3 x 12 Z.Bianca | Screw DIN 912 PG CI 8.8 M 3 x 12 Z. white |
| BV131 | BV013100 | NR | Vite TSPEI PG DIN 7991 CI 10.9 M 5 x 30 Z.Bianca | TSPEI PG screw DIN 7991 CI 10.9 M 5 x 30 Z. white |
| BV132 | BV013200 | NR | Vite TSPEI PG DIN 7991 CI 10.9 M 5 x 55 Z.Bianca | TSPEI PG screw DIN 7991 CI 10.9 M 5 x 55 Z. white |
| BV133 | BV013300 | NR | Vite TE Tutto Filetto PG DIN 933 CI 8.8 M 3 x 25 Z.Bianca | Screw All Thread DIN 933 PG CI 8.8 M 3 x 25 Z. white |
| BV134 | BV013400 | NR | Vite TE Parziale Filetto PG DIN 931 CI 8.8 M 10 x 65 Z.Bianca | Screw Partial Thread DIN 931 PG CI 8.8 M 10 x 65 Z. white |
| BV135 | BV013500 | NR | Vite TCEI PG DIN 912 CI 8.8 M 12 x 50 | Screw DIN 912 CI 9.8 M 12 x 50 |
| BV136 | BV013600 | NR | Vite TSPEI PG DIN 7991 CI 10.9 M 5 x 25 Z.Bianca | TSPEI PG screw DIN 7991 CI 10.9 M 5 x 25 Z. white |

| POS | Codice | U.M. |  Descrizione |  Description |
|-------|----------|------|---|---|
| BV137 | BV013700 | NR | Vite TCEI PG DIN 912 CI 8.8 M 8 x 30 | Screw DIN 912 CI 8.8 M 8 x 30 |
| BV138 | BV013800 | NR | Vite TC Croce PG DIN 7985 CI 4.8 M 5 x 10 Z.Bianca | Screw DIN 7985 CI 4.8 M 5 x 10 |
| BV139 | BV013900 | NR | Vite TCEI PG DIN 912 CI 12.9 M 4 x 25 Z. Bianca | Screw DIN 912 CI 12.9 M 4 x 25 Z. Withe |
| BV140 | BV014000 | NR | Vite TE Parziale Filetto PG DIN 931 CI 8.8 M 5 x 70 Z.Bianca | Screw Partial Thread DIN 931 PG CI 8.8 M 5 x 70 Z. white |
| BV141 | BV014100 | NR | Vite TE Parziale Filetto PG DIN 931 CI 8.8 M 12 x 90 Z.Bianca | Screw Partial Thread DIN 931 PG CI 8.8 M 12 x 90 Z. white |
| BV142 | BV014200 | NR | Vite TE Parziale Filetto PG DIN 931 CI 8.8 M 8 x 55 Z.Bianca | Screw Partial Thread DIN 931 PG CI 8.8 M 8 x 55 Z. white |
| BV143 | BV014300 | NR | Vite TSPEI PG DIN 7991 CI 10.9 M 10 x 20 Z.Bianca | TSPEI PG screw DIN 7991 CI 10.9 M 10 x 20 Z. white |
| BV144 | BV014400 | NR | Vite TE Tutto Filetto PG DIN 933 CI 8.8 M 12 x 20 Z.Bianca | Screw All Thread DIN 933 PG CI 8.8 M 12 x 20 Z. white |
| BV145 | BV014500 | NR | Vite TE Tutto Filetto PG DIN 933 CI 8.8 M 12 x 35 Z.Bianca | Screw All Thread DIN 933 PG CI 8.8 M 12 x 35 Z. white |
| BV146 | BV014600 | NR | Vite TE Tutto Filetto PF DIN 961 CI 8.8 M 10 x 1,25 x 25 Z.Bianca | All PF thread hex head screw DIN 961 CI 8.8 M 10 x 1,25 x 25 Z.Bianca |
| BV147 | BV014700 | NR | Vite TSPEI PG DIN 7991 CI 10.9 M 12 x 90 Z.Bianca | TSPEI PG screw DIN 7991 CI 10.9 M12 x 90 Z. white |
| BV148 | BV014800 | NR | Vite TSPEI PG DIN 7991 CI 10.9 M 6 x 16 Z.Bianca | TSPEI PG screw DIN 7991 CI 10.9 M6 x 16 Z. white |
| BV149 | BV014900 | NR | Vite TBEI PG ISO 7380 CI 10.9 M 6 x 20 Z.Bianca | Hex socket screw ISO 7380 PG CI 10.9 M 6 x 20 Z. white |
| BV150 | BV015000 | NR | Vite TE Tutto Filetto PG DIN 933 CI 10.9 M 14 x 40 Z.Bianca | Screw All Thread DIN 933 PG CI 10.9 M 14 x 40 Z. white |
| BV151 | BV015100 | NR | Vite TE Parziale Filetto PG DIN 931 CI 8.8 M 10 x 85 Z.Bianca | Screw Partial Thread DIN 931 PG CI 8.8 M 10 x 85 Z. white |
| BV152 | BV015200 | NR | Vite TE Parziale Filetto PG DIN 931 CI 8.8 M 10 x 75 Z.Bianca | Screw Partial Thread DIN 931 PG CI 8.8 M 10 x 75 Z. white |
| BV153 | BV015300 | NR | Vite TE Tutto Filetto PG DIN 933 CI 8.8 M14 x 45 Z.Bianca | Screw All Thread DIN 933 PG CI 8.8 M14 x 45 Z. white |

| POS | Codice | U.M. |  Descrizione |  Description |
|-------|----------|------|---|---|
| BV154 | BV015400 | NR | Vite TCEI PG DIN 912 CI 12.9 M 8 x 35 GEOMET 321A | Screw DIN 912 CI 12.9 M 8 x 35 GEOMET 321A |
| BV155 | BV015500 | NR | Vite TCEI PG DIN 912 CI 12.9 M 5 x 20 GEOMET 321A | Screw DIN 912 CI 12.9 M 5 x 20 GEOMET 321A |
| BV156 | BV015600 | NR | Vite TBEI PG ISO 7380 CI 10.9 M 6 x 25 Z.Bianca | Hex socket screw ISO 7380 PG CI 10.9 M 6 x 25 Z. white |
| BV157 | BV015700 | NR | Vite TBEI PG ISO 7380 CI 10.9 M 8 x 20 Z.Bianca | Hex socket screw ISO 7380 PG CI 10.9 M 8 x 20 Z. white |
| BV158 | BV015800 | NR | Vite TBEI PG ISO 7380 CI 10.9 M 6 x 70 Z.Bianca | Hex socket screw ISO 7380 PG CI 10.9 M 6 x 70 Z. white |
| BV159 | BV015900 | NR | Vite TBEI PG ISO 7380 CI 10.9 M 10 x 20 Z.Bianca | Hex socket screw ISO 7380 PG CI 10.9 M 10 x 20 Z. white |
| BV160 | BV016000 | NR | Vite TSPEI PG DIN 7991 CI 10.9 M 4 x 16 Z.Bianca | TSPEI PG screw DIN 7991 CI 10.9 M4 x 16 Z. white |
| BV161 | BV016100 | NR | Vite TCEI UNC ASME/ANSI B18.3 ASTM A 574 1/2 x 1"1/4 | hex head screw TCEI UNC ASME/ANSI B18.3 ASTM A 574 1/2 x 1"1/4 |
| BV162 | BV016200 | NR | Vite TCEI PG DIN 912 CI 12.9 M14 x 45 GEOMET 321A | Screw DIN 912 CI 12.9 M14 x 45 GEOMET 321A |
| BV163 | BV016300 | NR | Vite TCEI PG DIN 912 CI 8.8 M6 x 35 GEOMET 321A | Screw DIN 912 CI 8.8 M6 x 35 GEOMET 321A |
| BV164 | BV016400 | NR | Vite TCEI PG DIN 912 CI 8.8 M10 x 35 GEOMET 321A | Screw DIN 912 CI 8.8 M10 x 35 GEOMET 321A |
| BV165 | BV016500 | NR | Vite TE Tutto Filetto PG DIN 933 CI 8.8 M8 x 12 Z.Bianca | Screw All Thread DIN 933 PG CI 8.8 M8 x 12 Z. white |
| BV166 | BV016600 | NR | Vite TCEI PG DIN 912 CI 8.8 M4 x 20 GEOMET 321A | Screw DIN 912 CI 8.8 M4 x 20 GEOMET 321A |
| BV167 | BV016700 | NR | Vite TCEI PG DIN 912 CI 8.8 M4 x 20 GEOMET 321A | All PF thread hex head screw DIN 961 CI 8.8 M 12 x 1,25 x 30 Z.Bianca |
| BV168 | BV016800 | NR | Vite TE Tutto Filetto PF DIN 961 CI 8.8 M 10 x 1,25 x 30 Z.Bianca | All PF thread hex head screw DIN 961 CI 8.8 M 10 x 1,25 x 30 Z.Bianca |
| BV169 | BV016900 | NR | Vite TCEI PG DIN 912 CI 8.8 M 10 x 1,25 x 30 | Screw DIN 912 CI 8.8 M10 x 1,25 x 30 |
| BV170 | BV017000 | NR | Vite TE Tutto Filetto PF DIN 961 CI 8.8 M 10 x 1,25 x 30 Z.Bianca | All PF thread hex head screw DIN 961 CI 8.8 M 10 x 1,25 x 60 Z.Bianca |



| POS | Codice | U.M. |  Descrizione |  Description |
|-------|----------|------|---|---|
| BV171 | BV017100 | NR | Vite TE Tutto Filetto PF DIN 961 CI 8.8 M 12 x 1,25 x 25 Z.Bianca | All PF thread hex head screw DIN 961 CI 8.8 M 12 x 1,25 x 25 Z.Bianca |
| BV172 | BV017200 | NR | Vite TE UNC ANSI B18.2.1 GR.5 5/8 passo 11 L= 1" 1/2 | UNC hex head screw ANSI B18.2.1 GR.5 5/8 11 L = 1 "1/2 |
| BV173 | BV017300 | NR | Vite TE Tutto Filetto PG DIN 933 CI 8.8 M12 x 30 Z.Bianca | Screw All Thread DIN 933 PG CI 8.8 M12 x 30 Z. white |
| BV174 | BV017400 | NR | Vite TE Tutto Filetto PG DIN 933 CI 8.8 M5 x 45 Z.Bianca | Screw All Thread DIN 933 PG CI 8.8 M5 x 45 Z. white |
| BV175 | BV017500 | NR | Vite TE Tutto Filetto PG DIN 933 CI 8.8 M12 x 80 Z.Bianca | Screw All Thread DIN 933 PG CI 8.8 M12 x 80 Z. white |
| BV176 | BV017600 | NR | Vite TCEI PG DIN 912 CI 8.8 M6 x 25 GEOMET 321A | Screw DIN 912 CI 8.8 M6 x 25 GEOMET 321A |
| BV177 | BV017700 | NR | Vite TE Tutto Filetto PG DIN 933 CI 8.8 M12 x 85 Z.Bianca | Screw All Thread DIN 933 PG CI 8.8 M12 x 85 Z. white |
| BV178 | BV017800 | NR | Vite TE Tutto Filetto PG DIN 933 CI 8.8 M8 x 90 Z.Bianca | Screw All Thread DIN 933 PG CI 8.8 M8 x 90 Z. white |
| BV179 | BV017900 | NR | Vite TE Tutto Filetto PG DIN 933 CI 8.8 M5 x 40 Z.Bianca | Screw All Thread DIN 933 PG CI 8.8 M5 x 40 Z. white |
| BV180 | BV018000 | NR | Vite TE Tutto Filetto PG DIN 933 CI 8.8 M6 x 75 Z.Bianca | Screw All Thread DIN 933 PG CI 8.8 M6 x 75 Z. white |
| BV181 | BV018100 | NR | Vite TE Tutto Filetto PG DIN 933 CI 8.8 M10 x 40 Z.Bianca | Screw All Thread DIN 933 PG CI 8.8 M10 x 40 Z. white |
| BV182 | BV018200 | NR | Vite TE Tutto Filetto PG DIN 933 CI 10.9 M 16 x 70 Z.Bianca | Screw All Thread DIN 933 PG CI 10.9 M 16 x 70 Z. white |
| BV183 | BV018300 | NR | Vite TE Tutto Filetto PG DIN 933 CI 8.8 M5 x 10 Z.Bianca | Screw All Thread DIN 933 PG CI 8.8 M5 x 10 Z. white |
| BV184 | BV018400 | NR | Vite TE Tutto Filetto PG DIN 933 CI 8.8 M10 x 16 Z.Bianca | Screw All Thread DIN 933 PG CI 8.8 M10 x 16 Z. white |
| BV185 | BV018500 | NR | Vite TCEI PG DIN 912 CI 8.8 M8 x 55 GEOMET 321A | Screw DIN 912 CI 8.8 M8 x 55 GEOMET 321A |
| BV186 | BV018600 | NR | Vite TCEI PG DIN 912 CI 12.9 M10 x 30 GEOMET 321A | Screw DIN 912 CI 12.9 M10 x 30 GEOMET 321A |
| BV187 | BV018700 | NR | Vite TCEI PG DIN 912 CI 12.9 M14 x 40 GEOMET 321A | Screw DIN 912 CI 12.9 M14 x 40 GEOMET 321A |
| BV188 | BV018800 | NR | Vite TE Tutto Filetto PG DIN 933 CI 8.8 M 12 x 60 Z.Bianca | Screw All Thread DIN 933 PG CI 8.8 M12 x 60 Z. white |

| POS | Codice | U.M. |  Descrizione |  Description |
|-------|----------|------|---|---|
| BV189 | BV018900 | NR | Vite TE Tutto Filetto PG DIN 933 CI 8.8 M 12 x 55 Z.Bianca | Screw All Thread DIN 933 PG CI 8.8 M12 x 55 Z. white |
| BV190 | BV019000 | NR | Vite TE Tutto Filetto PG DIN 933 CI 8.8 M 12 x 50 Z.Bianca | Screw All Thread DIN 933 PG CI 8.8 M12 x 50 Z. white |
| BV191 | BV019100 | NR | Vite TE Tutto Filetto PG DIN 933 CI 8.8 M 16 x 50 Z.Bianca | Screw All Thread DIN 933 PG CI 8.8 M16 x 50 Z. white |
| BV192 | BV019200 | NR | Vite TE Tutto Filetto PG DIN 933 CI 8.8 M 16 x 55 Z.Bianca | Screw All Thread DIN 933 PG CI 8.8 M16 x 55 Z. white |
| BV193 | BV019300 | NR | Vite TE Parziale Filetto PG DIN 931 CI 8.8 M 10 x 55 Z.Bianca | Screw Partial Thread DIN 931 PG CI 8.8 M 10 x 55 Z. white |
| BV194 | BV019400 | NR | Vite TE Parziale Filetto PG DIN 931 CI 8.8 M 16 x 230 Z.Bianca | Screw Partial Thread DIN 931 PG CI 8.8 M 16 x 230 Z. white |
| BV195 | BV019500 | NR | Vite TE Parziale Filetto PG DIN 931 CI 8.8 M 6 x 50 Z.Bianca | Screw Partial Thread DIN 931 PG CI 8.8 M 6 x 50 Z. white |
| BV196 | BV019600 | NR | Vite TE Parziale Filetto PG DIN 931 CI 8.8 M 6 x 65 Z.Bianca | Screw Partial Thread DIN 931 PG CI 8.8 M 6 x 65 Z. white |
| BV197 | BV019700 | NR | Vite TE Parziale Filetto PG DIN 931 CI 8.8 M 8 x 45 Z.Bianca | Screw Partial Thread DIN 931 PG CI 8.8 M 8 x 45 Z. white |
| BV198 | BV019800 | NR | Vite TE Parziale Filetto PG DIN 931 CI 8.8 M 8 x 55 Z.Bianca | Screw Partial Thread DIN 931 PG CI 8.8 M 8 x 55 Z. white |
| BV199 | BV019900 | NR | Vite TE Parziale Filetto PG DIN 931 CI 8.8 M 8 x 60 Z.Bianca | Screw Partial Thread DIN 931 PG CI 8.8 M 8 x 60 Z. white |
| BV200 | BV020000 | NR | Vite TE Tutto Filetto PG DIN 933 CI 10.9 M 16 x 40 Z.Bianca | Screw All Thread DIN 933 PG CI 10.9 M 16 x 40 Z. white |
| BV201 | BV020100 | NR | Vite TSPEI PG DIN 7991 CI 10.9 M16 x 45 Z.Bianca | TSPEI PG screw DIN 7991 CI 10.9 M16 x 45 Z. white |
| BV202 | BV020200 | NR | Vite TCEI PG DIN 912 CI 12.9 M3 x 12 ZINC. iridescente Fe/Zn5IVs | Screw DIN 912 CI 12.9 M3 x 12 ZINC. iridescente Fe/Zn5IVs |
| BV203 | BV020300 | NR | Vite TC Croce PG DIN 7985 CI 4.8 M M 3 x 5 Z.Bianca | Screw DIN 7985 CI 4.8 M M 3 x 5 |
| BV204 | BV020400 | NR | Vite TC Croce PG DIN 7985 CI 4.8 M M 3 x 8 Z.Bianca | Screw DIN 7985 CI 4.8 M M 3 x 8 |
| BV205 | BV020500 | NR | Vite TTQST DIN 603/555 CI 4.8 M 8 x 35 Z.Bianca | TTQST Screw DIN 603/555 CL 4.8 M 8 x 35 Z. White |



| POS | Codice | U.M. |  Descrizione |  Description |
|-------|----------|------|---|---|
| BV206 | BV020600 | NR | Vite TC Croce PG DIN 7985 CI 4.8 M M 5 x 80 Z.Bianca | Screw DIN 7985 CI 4.8 M M 5 x 80 |
| BV207 | BV020700 | NR | Vite TE Parziale Filetto PG DIN 931 CI 8.8 M 10 x 80 Z.Bianca | Screw Partial Thread DIN 931 PG CI 8.8 M 10 x 80 Z. white |
| BV208 | BV020800 | NR | Vite TE Tutto Filetto PG DIN 933 CI 8.8 M 16 x 35 Z.D.Bianca | Screw All Thread DIN 933 PG CI 8.8 M 16 x 35 ZD white |
| BV209 | BV020900 | NR | Vite TE Parziale Filetto PG DIN 931 CI 8.8 M 10 x 95 Z.Bianca | Screw Partial Thread DIN 931 PG CI 8.8 M 10 x 95 Z. white |
| BV210 | BV021000 | NR | Vite TE Tutto Filetto PG DIN 933 CI 8.8 M 6 x 14 Z.D.Bianca | Screw All Thread DIN 933 PG CI 8.8 M 6 x 14 ZD white |
| BV211 | BV021100 | NR | Vite TE Tutto Filetto PG DIN 933 CI 8.8 M 12 x 25 Z.D.Bianca | Screw All Thread DIN 933 PG CI 8.8 M 12 x 25 ZD white |
| BV212 | BV021200 | NR | Vite TE Tutto Filetto PG DIN 933 CI 8.8 M 4 x 14 Z.D.Bianca | Screw All Thread DIN 933 PG CI 8.8 M 4 x 14 ZD white |
| BV213 | BV021300 | NR | Vite TE Tutto Filetto PG DIN 933 CI 10.9 M 16 x 60 Z.D.Bianca | Screw All Thread DIN 933 PG CI 10.9 M 16 x 60 ZD white |
| BV214 | BV021400 | NR | Vite TE Parziale Filetto PG DIN 931 CI 8.8 M 6 x 100 Z.Bianca | Screw Partial Thread DIN 931 PG CI 8.8 M 6 x 100 Z. white |
| BV215 | BV021500 | NR | Vite TE Parziale Filetto PG DIN 931 CI 10.9 M 16 x 110 Z.D.Bianca | Screw Partial Thread DIN 931 PG CI 10.9 M 16 x 110 ZD white |
| BV216 | BV021600 | NR | Vite TE Parziale Filetto PG DIN 931 CI 10.9 M 16 x 240 Z.D.Bianca | Screw Partial Thread DIN 931 PG CI 10.9 M 16 x 240 ZD white |
| BV217 | BV021700 | NR | Vite TSPEI PG DIN 7991 CI 10.9 M 8 x 30 Z.Bianca | TSPEI PG screw DIN 7991 CI 10.9 M8 x 30 Z. white |
| BV218 | BV021800 | NR | Vite TSPEI PG DIN 7991 CI 10.9 M 5 x 6 Z.Bianca | TSPEI PG screw DIN 7991 CI 10.9 M5 x 6 Z. white |
| BV219 | BV021900 | NR | Vite TSPEI PG DIN 7991 CI 10.9 M 5 x 70 Z.Bianca | TSPEI PG screw DIN 7991 CI 10.9 M5 x 70 Z. white |
| BV220 | BV022000 | NR | Vite TSPEI PG DIN 7991 CI 10.9 M 12 x 35 Z.Bianca | TSPEI PG screw DIN 7991 CI 10.9 M12 x 35 Z. white |
| BV221 | BV022100 | NR | Vite TCEI PG DIN 912 CI 12.9 M10 x 20 GEOMET 321A | Screw DIN 912 CI 12.9 M10 x 20 GEOMET 321A |
| BV222 | BV022200 | NR | Vite TCEI PG DIN 912 CI 12.9 M8 x 90 GEOMET 321A | Screw DIN 912 CI 12.9 M8 x 90 GEOMET 321A |



| POS | Codice | U.M. |  Descrizione |  Description |
|-------|----------|------|---|---|
| BV223 | BV022300 | NR | Vite TCEI PG DIN 912 CI 12.9 M3 x 5 ZINC. | Screw DIN 912 CI 12.9 M3 x 5 ZINC. |
| BV224 | BV022400 | NR | Vite TBEI PG ISO 7380 CI 10.9 M 8 x 22 Z.Bianca | Hex socket screw ISO 7380 PG CI 10.9 M 8 x 22 Z. white |
| BV225 | BV022500 | NR | Vite TE Parziale Filetto PG DIN 931 CI 8.8 M 10 x 100 Z.Bianca | Screw Partial Thread DIN 931 PG CI 8.8 M 10 x 100 Z. white |
| BV226 | BV022600 | NR | Vite TE Parziale Filetto PG DIN 931 CI 8.8 M 10 x 110 Z.Bianca | Screw Partial Thread DIN 931 PG CI 8.8 M 10 x 110 Z. white |
| BV227 | BV022700 | NR | Vite TE Tutto Filetto PG DIN 933 CI 10.9 M 12 x 45 Z.D.Bianca | Screw All Thread DIN 933 PG CI 10.9 M 12 x 45 ZD white |
| BV228 | BV022800 | NR | Vite TE Tutto Filetto PG DIN 933 CI 10.9 M 14 x 35 Z.D.Bianca | Screw All Thread DIN 933 PG CI 10.9 M 14 x 35 ZD white |
| BV229 | BV022900 | NR | Vite TSPEI PG DIN 7991 CI 10.9 M 12 x 30 Z.Bianca | TSPEI PG screw DIN 7991 CI 10.9 M12 x 30 Z. white |
| BV230 | BV023000 | NR | Vite TE flangiata Tutto Filetto PG DIN 6921 CI 8.8 M 5 x 12 Zinconickel nero +sigillante | Flange Screw All Thread DIN 6921 PG CI 8.8 M 5 x 12 Zincnickel black +sealant |
| BV231 | BV023100 | NR | Vite TE flangiata Tutto Filetto PG DIN 6921 CI 8.8 M 6 x 16 Zinconickel nero +sigillante | Flange Screw All Thread DIN 6921 PG CI 8.8 M 6 x 16 Zincnickel black +sealant |
| BV232 | BV023200 | NR | Vite TE Tutto Filetto PG DIN 933 CI 8.8 M 5 x 25 Z.D.Bianca | Screw All Thread DIN 933 PG CI 8.8 M 5 x 25 ZD white |
| BV233 | BV023300 | NR | Vite TE Tutto Filetto PG DIN 933 CI 8.8 M 8 x 130 Z.D.Bianca | Screw All Thread DIN 933 PG CI 8.8 M 8 x 130 ZD white |
| BV234 | BV023400 | NR | Vite TBEI PG ISO 7380 CI 10.9 M 8 x 22 Z.Bianca | Hex socket screw ISO 7380 PG CI 10.9 M 8 x 22 Z. white |
| BV235 | BV023500 | NR | Vite TE Tutto Filetto PG DIN 933 CI 10.9 M 16 x 35 Z.D.Bianca | Screw All Thread DIN 933 PG CI 10.9 M 16 x 35 ZD white |
| BV236 | BV023600 | NR | Vite TE Parziale Filetto PG DIN 931 CI 8.8 M 6 x 45 Z.Bianca | Screw Partial Thread DIN 931 PG CI 8.8 M 6 x 45 Z. white |
| BV237 | BV023700 | NR | Vite TE Tutto Filetto PG DIN 933 CI 10.9 M 12 x 30 Z.D.Bianca | Screw All Thread DIN 933 PG CI 10.9 M 12 x 30 ZD white |
| BV238 | BV023800 | NR | Vite TE Parziale Filetto PG DIN 931 CI 8.8 M 16 x 90 Z.Bianca | Screw Partial Thread DIN 931 PG CI 8.8 M 16 x 90 Z. white |

| POS | Codice | U.M. |  Descrizione |  Description |
|-------|----------|------|---|---|
| BV239 | BV023900 | NR | Vite TE Parziale Filetto PG DIN 931 CI 8.8 M 12 x 65 Z.Bianca | Screw Partial Thread DIN 931 PG CI 8.8 M 12 x 65 Z. white |
| BV240 | BV024000 | NR | Vite TC Croce PG DIN 7985 CI 4.8 M 5 x 20 Z.Bianca | Screw DIN 7985 CI 4.8 M 5 x 20 |
| BV241 | BV024100 | NR | Vite TSPEI PG DIN 7991 CI 10.9 M 10 x 35 Z.Bianca | TSPEI PG screw DIN 7991 CI 10.9 M 10 x 35 Z. white |
| BV242 | BV024200 | NR | Vite TSPEI PG DIN 7991 CI 10.9 M 6 x 12 Z.Bianca | TSPEI PG screw DIN 7991 CI 10.9 M 6 x 12 Z. white |
| BV243 | BV024300 | NR | Vite TE Parziale Filetto PG DIN 931 CI 8.8 M 12 x 150 Z.Bianca | Screw Partial Thread DIN 931 PG CI 8.8 M 12 x 150 Z. white |
| BV244 | BV024400 | NR | Vite TCEI PG DIN 912 CI 8.8 M5 x 50 GEOMET 321A | Screw DIN 912 CI 8.8 M5 x 50 GEOMET 321A |
| BV245 | BV024500 | NR | Vite TE Parziale Filetto PG DIN 931 CI 8.8 M 8 x 110 Z.Bianca | Screw Partial Thread DIN 931 PG CI 8.8 M 8 x 110 Z. white |
| BV246 | BV024600 | NR | Vite TE Parziale Filetto PG DIN 931 CI 8.8 M 8 x 40 Z.Bianca | Screw Partial Thread DIN 931 PG CI 8.8 M 8 x 40 Z. white |
| BV247 | BV024700 | NR | Vite TE Tutto Filetto PG DIN 933 CI 8.8 M 5 x 50 Z.D.Bianca | Screw All Thread DIN 933 PG CI 8.8 M 5 x 50 ZD white |
| BV248 | BV024800 | NR | Vite TCEI PG DIN 912 CI 8.8 M5 x 18 GEOMET 321A | Screw DIN 912 CI 8.8 M5 x 18 GEOMET 321A |
| BV249 | BV024900 | NR | Vite TSPEI PG DIN 7991 CI 10.9 M 5 x 65 Z.Bianca | TSPEI PG screw DIN 7991 CI 10.9 M 5 x 65 Z. white |
| BV251 | BV025100 | NR | Vite TSPEI PG DIN 7991 CI 10.9 M 8 x 35 Z.Bianca | TSPEI PG screw DIN 7991 CI 10.9 M 8 x 35 Z. white |
| BV252 | BV025200 | NR | Vite TE Tutto Filetto PG DIN 933 CI 10.9 M 12 x 40 Z.D.Bianca | Screw All Thread DIN 933 PG CI 10.9 M 12 x 40 ZD white |
| BV253 | BV025300 | NR | Vite TBEI PG ISO 7380 M 6 x 55 Z.Bianca | Hex socket screw ISO 7380 PG M 6 x 55 Z. white |
| BV254 | BV025400 | NR | Vite TE Tutto Filetto PG DIN 933 CI 10.9 M 10 x 35 Z.D.Bianca | Screw All Thread DIN 933 PG CI 10.9 M 10 x 35 ZD white |
| BV255 | BV025500 | NR | Vite TE Tutto Filetto PG DIN 933 CI 12.9 M 14 x 55 Z.D.Bianca | Screw All Thread DIN 933 PG CI 12.9 M 14 x 55 ZD white |
| BV256 | BV025600 | NR | | |

| POS | Codice | U.M. |  Descrizione |  Description |
|-------|----------|------|---|---|
| BV257 | BV025700 | NR | Vite TE Tutto Filetto PG DIN 933 CI 8.8 M14 x 30 Z.Bianca | Screw All Thread DIN 933 PG CI 8.8 M14 x 30 Z. white |
| BV258 | BV025800 | NR | Vite TE Tutto Filetto PG DIN 933 CI 10.9 M 12 x 35 Z.D.Bianca | Screw All Thread DIN 933 PG CI 10.9 M 12 x 35 ZD white |
| BV259 | BV025900 | NR | Vite TE Tutto Filetto PG DIN 933 CI 8.8 M 16 x 45 Z.Bianca | Screw All Thread DIN 933 PG CI 8.8 M16 x 45 Z. white |
| BV260 | BV026000 | NR | Vite TCEI PG DIN 912 CI 10.9 M 12 x 30 Dac 320A | Screw DIN 912 CI 10.9 M 12 x 30 Dac 320A |
| BV261 | BV026100 | NR | Vite TCEI PG DIN 912 CI 10.9 M 12 x 20 Dac 320A | Screw DIN 912 CI 10.9 M 12 x 20 Dac 320A |
| BV262 | BV026200 | NR | Vite TCEI PG DIN 912 CI 12.9 M14 x 35 GEOMET 321A | Screw DIN 912 CI 12.9 M14 x 35 GEOMET 321A |
| BV263 | BV026300 | NR | Vite TCEI PG DIN 912 CI 12.9 M14 x 3 GEOMET 321A | Screw DIN 912 CI 12.9 M14 x 3 GEOMET 321A |
| BV264 | BV026400 | NR | Vite TSPEI PG DIN 7991 CI 10.9 M 12 x 25 Z.Bianca | TSPEI PG screw DIN 7991 CI 10.9 M12 x 25 Z. white |
| BV265 | BV026500 | NR | Vite TE Parziale Filetto PG DIN 931 CI 10.9 M 16 x 180 GEOMET 321A | Screw Partial Thread DIN 931 PG CI 10.9 M 16 x 180 GEOMET 321A |
| BV266 | BV026600 | NR | Vite TE Tutto Filetto PG DIN 933 CI 8.8 M8 x 10 Z.Bianca | Screw All Thread DIN 933 PG CI 8.8 M8 x 10 Z. white |
| BV267 | BV026700 | NR | Vite TCEI PG DIN 912 CI 8.8 M 12 x 40 | Screw DIN 912 CI 9.8 M 12 x 40 |
| BV268 | BV026800 | NR | Vite TE Parziale Filetto PG DIN 931 CI 8.8 M 12 x 140 Z.Bianca | Screw Partial Thread DIN 931 PG CI 8.8 M 12 x 140 Z. white |



| POS | Codice | U.M. |  Descrizione |  Description |
|------|----------|------|---|---|
| RB1 | RB000100 | NR | DADO PER OGIVA Ø=12 | NUT FOR OGIVA Ø = 12 |
| RD1 | RD000100 | NR | RACCORDO CORPO A "T" EO F(DKOL)-M-M 8L | FITTING BODY A "T" EO F (DKOL) M-M-8L |
| RD2 | RD000200 | NR | RACCORDO CORPO A "T" EO F(DKOL)-M-M 10L | FITTING BODY A "T" EO F (DKOL) M-M-10L |
| RD3 | RD000300 | NR | RACCORDO CORPO A "T" EO F(DKOL)-M-M 12L | FITTING BODY A "T" EO F (DKOL) M-M-12L |
| RD4 | RD000400 | NR | RACCORDO CORPO A "T" EO F(DKOL)-M-M 15L | FITTING BODY A "T" EO F (DKOL) M-M-15L |
| RD5 | RD000500 | NR | RACCORDO CORPO A "T" EO M-F(DKOL)-M 10L | FITTING BODY A "T" EO M-F (DKOL) M-10L |
| RD6 | RD000600 | NR | RACCORDO CORPO A "T" EO M-F(DKOL)-M 12L | FITTING BODY A "T" EO M-F (DKOL) M-12L |
| RD7 | RD000700 | NR | RACCORDO CORPO A "T" EO 8L M 14*1.5 | FITTING BODY A "T" EO 8L M 14 * 1.5 |
| RD8 | RD000800 | NR | RACCORDO CORPO A "T" EO 10L M 16*1.5 | FITTING BODY A "T" M 10L EO 16 * 1.5 |
| RD9 | RD000900 | NR | RACCORDO CORPO A "T" EO 28L M 36*2 | FITTING BODY A "T" M 28L EO 36 * 2 |
| RD10 | RD001000 | NR | RACCORDO CORPO A "T" EO 28L M 36*2 | FITTING BODY A "T" EO M-F (DKOL) M-10L |
| RD11 | RD001100 | NR | RACCORDO CORPO A "T" EO M-F(DKOL)-M 10L | FITTING BODY A "T" EO M-F (DKOL) M-10L |
| RD12 | RD001200 | NR | ADATTATORE "T" GAS M-FG-M 1/4 1/4 1/4 | ADAPTOR |
| RG1 | RG000100 | NR | RACCORDO CORPO A GOMITO 10L MASCH.-FEMM. DKOL | ELBOW FITTING BODY 10L Masch.-FEMM. DKOL |
| RG2 | RG000200 | NR | RACCORDO CORPO A GOMITO 12L MASCH.-FEMM. DKOL | ELBOW FITTING BODY 12L Masch.-FEMM. DKOL |
| RG3 | RG000300 | NR | RACCORDO CORPO A GOMITO 20S MASCHIO-FEMMINA DKOS | 20S BODY FITTING ELBOW MALE-FEMALE DKOS |
| RG4 | RG000400 | NR | RACCORDO CORPO A GOMITO 28L MASCHIO-FEMMINA DKOL | 28L BODY FITTING ELBOW MALE-FEMALE DKOL |

| POS | Codice | U.M. |  Descrizione |  Description |
|------|----------|------|---|---|
| RG5 | RG000500 | NR | RACCORDO A L MASCHIO-FEMMINA 1/8 | BODY 90 ° M / F 1/8 " |
| RG6 | RG000600 | NR | ADATTATORE 90° BSPP M-FG 1/4 | ADAPTOR |
| RN1 | RN000100 | NR | RACCORDO CORPO D'ESTREMITA' TENUTA ED 8L * 3/8 GAS *K* | END FITTING WITH SEAL ED 8L * 3/8 GAS * K * |
| RN2 | RN000200 | NR | RACCORDO CORPO D'ESTREMITA' TENUTA ED 12L * 3/8 GAS *K* | END FITTING WITH SEAL ED 12L * 3/8 GAS * K * |
| RN3 | RN000300 | NR | RACCORDO CORPO D'ESTREMITA' TENUTA ED 10L * 3/8 GAS *K* | FITTING END OF BODY 'AND SEAL 10L * 3/8 GAS * K * |
| RN4 | RN000400 | NR | RACCORDO CORPO D'ESTREMITA' TENUTA ED 8L * 1/4 GAS *K* | END FITTING WITH SEAL ED 8L * 1/4 GAS * K * |
| RN5 | RN000500 | NR | RACCORDO CORPO D'ESTREMITA' TENUTA ED 10L * 1/4 GAS *K* | FITTING END OF BODY 'AND SEAL 10L * 1/4 GAS * K * |
| RN6 | RN000600 | NR | RACCORDO CORPO D'ESTREMITA' TENUTA ED 12L * 1/4 GAS | FITTING END OF BODY 'AND SEAL 12L * 1/4 GAS |
| RN7 | RN000700 | NR | RACCORDO NIPLES GAS CON. - GAS CON. 1/4" * 1/4" | FITTING |
| RN8 | RN000800 | NR | RACCORDO CORPO D'ESTREMITA' TENUTA ED 15L * 1/2 GAS *K* | END FITTING WITH SEAL ED 15L * 1/2 * K * GAS |
| RN9 | RN000900 | NR | RACCORDO CORPO D'ESTREMITA' TENUTA ED 10L * 1/2 GAS *K* | FITTING END OF BODY 'AND SEAL 10L * 1/2 * K * GAS |
| RN10 | RN001000 | NR | RACCORDO CORPO D'ESTREMITA' TENUTA ED 15L * 3/4 GAS *K* | END FITTING WITH SEAL ED 15L * 3/4 GAS * K * |
| RN11 | RN001100 | NR | RACCORDO CORPO D'ESTREMITA' TENUTA ED 12L * 1/2 GAS *K* | END FITTING WITH SEAL ED 12L * 1/2 GAS * K * |
| RN12 | RN001200 | NR | RACCORDO CORPO D'ESTR. TENUTA ED 8L * 1/2 GAS | END FITTING WITH SEAL ED 8L * 1/2 GAS |
| RN13 | RN001300 | NR | RACCORDO CORPO D'ESTR. TENUTA ED 8L * 3/4 GAS | CONNECTOR BODY OF EXTR. SEAL AND 8L * 3/4 GAS |
| RN14 | RN001400 | NR | RACCORDO CORPO D'ESTR. TENUTA ED 12L * 3/4 GAS | CONNECTOR BODY OF EXTR. SEAL AND 12L * 3/4 GAS |

| POS | Codice | U.M. |  Descrizione |  Description |
|------|----------|------|---|---|
| RN15 | RN001500 | NR | RACCORDO CORPO D'ESTR. TENUTA ED 15L * 3/8 GAS | END FITTING WITH SEAL ED 15L * 3/8 GAS |
| RN16 | RN001600 | NR | RACCORDO CORPO D'ESTR. TENUTA ED 22L * 3/4 GAS | END FITTING WITH SEAL ED 22L * 3/4 GAS |
| RN17 | RN001700 | NR | RACCORDO CORPO D'ESTR. TENUTA ED 28L * 3/4" GAS | END FITTING WITH SEAL ED 28L * 3/4 BSP |
| RN18 | RN001800 | NR | RACCORDO CORPO D'ESTR. TENUTA ED 20S * 3/4 GAS | CONNECTOR BODY OF EXTR. SEAL AND 20S * 3/4 GAS |
| RN19 | RN001900 | NR | RACCORDO CORPO D'ESTREMITA' 8L * M 12X1.5 ED | END FITTING 8L * M 12x1.5 ED |
| RN20 | RN002000 | NR | RACCORDO CORPO D'ESTREMITA' 8L * M 14X1.5 ED | FITTING END OF BODY 'AND 8L * M 14x1.5 |
| RN21 | RN002100 | NR | RACCORDO CORPO D'ESTREMITA' 10L * M 18X1.5 ED | END FITTING 10L * M 18x1.5 |
| RN22 | RN002200 | NR | RACCORDO CORPO D'ESTR. TENUTA ED 15L * M 18X1.5 | CONNECTOR BODY OF EXTR. SEAL AND 15L * M 18x1.5 |
| RN23 | RN002300 | NR | RACCORDO CORPO D'ESTR. TENUTA ED 15L * M 22X1.5 | END FITTING WIHT SEAL ED 15L * M 22x1.5 |
| RN24 | RN002400 | NR | RACCORDO CORPO D'ESTR. TENUTA ED 22L * M26X1.5 | CONNECTOR BODY OF EXTR. SEAL AND 22L * M26x1.5 |
| RN25 | RN002500 | NR | RACCORDO CORPO D'ESTR. TENUTA ED 20S * M27X2 | CONNECTOR BODY OF EXTR. SEAL AND 20S * M27X2 |
| RN26 | RN002600 | NR | RACCORDO CORPO D'ESTR. 8L * 9/16-18 UNF-2A | END FITTING 8L * 9/16-18 UNF-2A |
| RN27 | RN002700 | NR | RACCORDO CORPO D'ESTR. 12L * 3/4 -16 UNF-2A | END FITTING 12L * 3/4 -16 UNF-2A |
| RN28 | RN002800 | NR | RACCORDO CORPO D'ESTR. 20S * 1.5/16 -12 UN-2A | END FITTING 20S * 1.5/16 -12 UN-2A |
| RN29 | RN002900 | NR | RACCORDO CORPO D'ESTR. TENUTA ED 22L * M26X1.5 | END FITTING WITH SEAL ED 22L * M26x1.5 |
| RN30 | RN003000 | NR | RACCORDO CORPO D'ESTR. TENUTA ED 22L * M26X1.5 | END FITTING WITH SEAL ED 22L * M26x1.5 |
| RN31 | RN003100 | NR | RACCORDO CORPO D'ESTREMITA' TENUTA ED 6L * 1/4 GAS *K* | END FITTING WITH SEAL 1/4 BSPP 6L |

| POS | Codice | U.M. |  Descrizione |  Description |
|------|----------|------|---|---|
| RN32 | RN003200 | NR | RACCORDO CORPO D'ESTREMITA' TENUTA ED 8L * 3/8 GAS *K* | END FITTING WITH SEAL ED 8L * 3/8 GAS * K * |
| RN33 | RN003300 | NR | NIPPLES 1/8" JIS 1/8"GAS | CAP |
| RN34 | RN003400 | NR | NIPPLES 1/4" JIS 1/4"GAS | CAP |
| RN35 | RN003500 | NR | NIPPLES 3/8" JIS 1/4"GAS | CAP |
| RN36 | RN003600 | NR | NIPPLES 3/8" JIS 1/4"GAS | CAP |
| RO1 | RO000100 | NR | OGIVA PER TUBO Ø=12 | OGIVE FOR TUBE Ø = 12 |
| RR1 | RR000100 | NR | RONDELLA RAME 1/4 | COPPER WASHER 1/4 |
| RR2 | RR000200 | NR | RONDELLA BONDED GAS 3/8" *K* | BONDED WASHER GAS 3/8 " K * |
| RR3 | RR000300 | NR | RONDELLA BONDED METRICA 12 *K* | METRIC BONDED WASHER 12 * K * |
| RR4 | RR000400 | NR | RONDELLA BONDED GAS 1/4" *K* | BONDED WASHER GAS 1/4 " K * |
| RR5 | RR000500 | NR | RONDELLA BONDED GAS 1/2" *K* | BONDED WASHER GAS 1/2 " K * |
| RR6 | RR000600 | NR | RONDELLA RAME 3/8 | COPPER WASHER 3/8 |
| RR7 | RR000700 | NR | RONDELLA BONDED GAS 1/8" *K* | BONDED WASHER GAS 1/8 " K * |
| RR8 | RR000800 | NR | RONDELLA BONDED GAS 1" *K* | BONDED WASHER GAS 1 " K * |
| RR9 | RR000900 | NR | RONDELLA BONDED GAS 3/4" *K* | BONDED WASHER GAS 3/4 " K * |
| RR10 | RR001000 | NR | RONDELLA BONDED GAS 1.1/4" | BONDED WASHER GAS 1.1 / 4 " |
| RR11 | RR001100 | NR | RONDELLA RAME M10 | COPPER WASHER M10 |
| RR12 | RR001200 | NR | RONDELLA RAME 1/2 | COPPER WASHER 1/2 |

| POS | Codice | U.M. |  Descrizione |  Description |
|------|----------|------|---|---|
| RR13 | RR001300 | NR | RONDELLA BONDED M12 | BONDED WASHER M12 |
| RS1 | RS000100 | NR | COPPIA SEMIFLANGE SAE 6000 3/4" | PAIR 6000 SAE flange halves 3/4 " |
| RS2 | RS000200 | NR | RACC.M 20S(M30x2) - ED M 1"5/16 UNF H=33 | FITTING M 20S (M30x2) - ED M 1 "5/16 UNF H = 33 |
| RS3 | RS000300 | NR | RIDUZIONE M-F GAS 1" * 1/2" | REDUCING GAS M-F 1 "*" 1/2" |
| RS4 | RS000400 | NR | RACCORDO COLONNETTA M15L - 3/8" GAS H=50 | COLUMN CONNECTION M15L - 3/8 "GAS H = 50 |
| RS5 | RS000500 | NR | RACCORDO COLONNETTA M15L - 3/8" GAS H=96 | COLUMN CONNECTION M15L - 3/8 "GAS H = 96 |
| RS6 | RS000600 | NR | CODOLO M1/4" ED X FG 8L (M14X1.5) | FITTING M1 / 4 "X AND FG 8L (M14X1.5) |
| RS7 | RS000700 | NR | RIDUZIONE M-F GAS 1" * 1/2" | REDUCING GAS M-F 1 "*" 1/2" |
| RS8 | RS000800 | NR | RACCORDO CODOLO D' ESTR. FEM. DKO 12I*3/8 GAS ED | END FITTING FEM. DKO 12I*3/8 GAS ED |
| RS9 | RS000900 | NR | MANICOTTO ARIA 1/8-1/8 | AIR MANIFOLD 1/8-1/8 |
| RS10 | RS001000 | NR | RIDUZIONE M-F GAS 3/8" JIS 1/8" BSPP | REDUCING GAS M-F 3/8" JIS 1/8" BSPP |
| RS11 | RS001100 | NR | RACCORDO M-M 15L | FITTING M-M 15L |
| RS12 | RS001200 | NR | RACCORDO NIPLES GAS CON.- GAS CON.1/2"1/2" | FITTING 1/2" - 1/2" |
| RT1 | RT000100 | NR | TAPPO MASCHIO TE GAS 3/8" SVASATO 60° *K* | SCREW EYE FOR GAS 1/2 "H = 50 |
| RT2 | RT000200 | NR | TAPPO MASCHIO ESAGONO INTERNO GAS 1/4" SVASATO 60° *K* | MALE PLUG GAS INTERNAL HEX 1/4 "FLARE 60 ° * K * |
| RT3 | RT000300 | NR | TAPPO MASCHIO TE GAS 1/2" SVASATO 60° *K* | MALE PLUG TE GAS 1/2 "FLARE 60 ° * K * |
| RT4 | RT000400 | NR | TAPPO MASCHIO TE GAS 1/4" SVASATO 60° *K* | MALE PLUG TE GAS 1/4 "FLARE 60 ° * K * |

| POS | Codice | U.M. |  Descrizione |  Description |
|-----|----------|------|---|---|
| RT5 | RT000500 | NR | TAPPO MASCHIO ESAGONO INTERNO GAS 3/8" SVASATO 60° *K* | MALE PLUG GAS INTERNAL HEX 3/8 "FLARE 60 ° * K * |
| RT6 | RT000600 | NR | TAPPO MASCHIO ESAGONO INTERNO GAS 1" SVASATO 60° *K* | MALE PLUG GAS INTERNAL HEX 1 "FLARE 60 ° * K * |
| RT7 | RT000700 | NR | TAPPO MASCHIO TE GAS 1/8" SVASATO 60° *K* | MALE PLUG TE GAS 1/8 "FLARE 60 ° * K * |
| RT8 | RT000800 | NR | TAPPO MASCHIO TE GAS 1/4" JIS | MALE PLUG TE GAS 1/4 " JIS |
| RV1 | RV000100 | NR | VITE PER OCCHIO GAS 1/4" H=29 *K* | SCREW EYE FOR GAS 1/4 "H = 29 * K * |
| RV2 | RV000200 | NR | VITE PER OCCHIO DOPPIA GAS 3/8" | SCREW EYE DOUBLE FOR GAS 3/8 " |
| RV3 | RV000300 | NR | VITE PER OCCHIO GAS 1/2" H= 50 | SCREW EYE FOR GAS 1/2 "H = 50 |
| RV4 | RV000400 | NR | VITE PER OCCHIO DOPPIA GAS 1/4" | DOUBLE EYE SCREW FOR GAS 1/4" |
| RV5 | RV000500 | NR | VITE PER OCCHIO GAS 3/8" | SCREW EYE FOR GAS 3/8" |
| RV6 | RV000600 | NR | VITE PER OCCHIO GAS 1/8" | SCREW EYE FOR GAS 1/8" |

**CALIFORNIAN PROPOSITION 65
BATTERY WARNING**

**Battery posts, terminals
and related accessories
contain lead and lead
compounds, chemicals
known to the State of
California to cause cancer
and reproductive harm.**

**Batteries also contain other
harmful chemicals known
to the State of California.**

**WASH HANDS
AFTER HANDLING!**

Go to Discount-Equipment.com to order your parts

PARTS FINDER

**Search Website
by Part Number**



**Search Manual
Library For Parts
Manual & Lookup Part
Numbers – Purchase
or Request Quote**

Search Manuals

Enter your information to search for a parts manual or lookup a part number.

* Brand:

* Model:

* Serial:

* Part Number:

SEARCH

**Can't Find Part or
Manual? Request Help
by Manufacturer,
Model & Description**

Parts Order Form

Please fill in the following information:

Manufacturer:

Model:

Description:

Quantity:

Part Number:

Part Name:

Part Description:

Part Location:

Part Condition:

Part Status:

Part Color:

Part Material:

Part Weight:

Part Dimensions:

Part Price:

Part Notes:

Submit

Discount-Equipment.com is your online resource for quality parts & equipment.

Florida: **561-964-4949** Outside Florida TOLL FREE: **877-690-3101**

Need parts?

Click on this link: <http://www.discount-equipment.com/category/5443-parts/> and choose one of the options to help get the right parts and equipment you are looking for. Please have the machine model and serial number available in order to help us get you the correct parts. If you don't find the part on the website or on one of the online manuals, please fill out the request form and one of our experienced staff members will get back to you with a quote for the right part that your machine needs.

We sell worldwide for the brands: Genie, Terex, JLG, MultiQuip, Mikasa, Essick, Whiteman, Mayco, Toro Stone, Diamond Products, Generac Magnum, Airman, Haulotte, Barreto, Power Blanket, Nifty Lift, Atlas Copco, Chicago Pneumatic, Allmand, Miller Curber, Skyjack, Lull, Skytrak, Tsurumi, Husquvarna Target, Stow, Wacker, Sakai, Mi-T-M, Sullair, Basic, Dynapac, MBW, Weber, Bartell, Bennar Newman, Haulotte, Ditch Runner, Menegotti, Morrison, Contec, Buddy, Crown, Edco, Wyco, Bomag, Laymor, EZ Trench, Bil-Jax, F.S. Curtis, Gehl Pavers, Heli, Honda, ICS/PowerGrit, IHI, Partner, Imer, Clipper, MMD, Koshin, Rice, CH&E, General Equipment, Amida, Coleman, NAC, Gradall, Square Shooter, Kent, Stanley, Tamco, Toku, Hatz, Kohler, Robin, Wisconsin, Northrock, Oztec, Toker TK, Rol-Air, APT, Wylie, Ingersoll Rand / Doosan, Innovatech, Con X, Ammann, Mecalac, Makinex, Smith Surface Prep, Small Line, Wanco, Yanmar