



An Oshkosh Corporation Company



Illustrated Parts Manual

Compact Crawler

X15JP

X430AJ

ANSI



AS/NZS

3121778
May 31, 2017

PARTS FINDER

**Search Website
by Part Number**



**Search Manual
Library For Parts
Manual & Lookup Part
Numbers – Purchase
or Request Quote**

Search Manuals

Enter your information to search for a manual or to purchase a manual or parts.

* Brand:

* Model:

* Serial:

* Part Number:

SEARCH

**Can't Find Part or
Manual? Request Help
by Manufacturer,
Model & Description**

Parts Order Form

Please fill in the following information:

Manufacturer:

Model:

Description:

Quantity:

Part Number:

Part Name:

Part Description:

Part Category:

Part Location:

Part Status:

Part Condition:

Part Material:

Part Color:

Part Weight:

Part Dimensions:

Part Price:

Part Notes:

Submit

Discount-Equipment.com is your online resource for quality parts & equipment.

Florida: **561-964-4949** Outside Florida TOLL FREE: **877-690-3101**

Need parts?

Click on this link: <http://www.discount-equipment.com/category/5443-parts/> and choose one of the options to help get the right parts and equipment you are looking for. Please have the machine model and serial number available in order to help us get you the correct parts. If you don't find the part on the website or on one of the online manuals, please fill out the request form and one of our experienced staff members will get back to you with a quote for the right part that your machine needs.

We sell worldwide for the brands: Genie, Terex, JLG, MultiQuip, Mikasa, Essick, Whiteman, Mayco, Toro Stone, Diamond Products, Generac Magnum, Airman, Haulotte, Barreto, Power Blanket, Nifty Lift, Atlas Copco, Chicago Pneumatic, Allmand, Miller Curber, Skyjack, Lull, Skytrak, Tsurumi, Husquvarna Target, Stow, Wacker, Sakai, Mi-T-M, Sullair, Basic, Dynapac, MBW, Weber, Bartell, Bennar Newman, Haulotte, Ditch Runner, Menegotti, Morrison, Contec, Buddy, Crown, Edco, Wyco, Bomag, Laymor, EZ Trench, Bil-Jax, F.S. Curtis, Gehl Pavers, Heli, Honda, ICS/PowerGrit, IHI, Partner, Imer, Clipper, MMD, Koshin, Rice, CH&E, General Equipment, Amida, Coleman, NAC, Gradall, Square Shooter, Kent, Stanley, Tamco, Toku, Hatz, Kohler, Robin, Wisconsin, Northrock, Oztec, Toker TK, Rol-Air, APT, Wylie, Ingersoll Rand / Doosan, Innovatech, Con X, Ammann, Mecalac, Makinex, Smith Surface Prep, Small Line, Wanco, Yanmar

 SOTTOCARRO CINGOLATO

RAUPENFAHRWERK 

 TRACKED UNDERCARRIAGE

CARRO DE ORUGAS 

 CHENILLARD

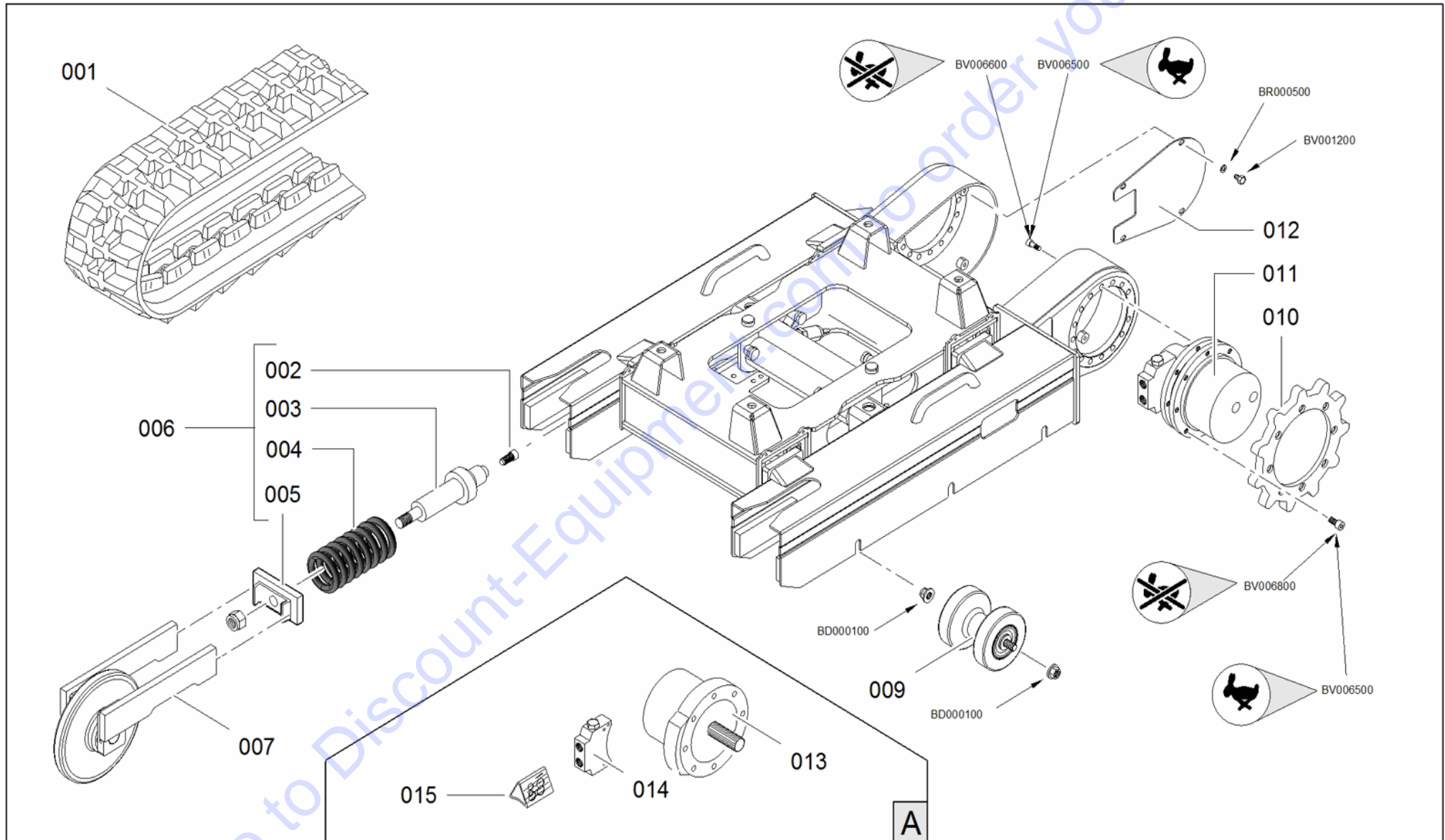

 SOTTOCARRO CINGOLATO

 RAUPENFAHRWERK

 TRACKED UNDERCARRIAGE

 CARRO DE ORUGAS

 CHENILLARD

| POS Codice | Q.tà |  Descrizione |  Description |  Designation |  Benennung |  Descripción |
|-------------|------|---|---|---|---|---|
| 1 053715L0 | 2 NR | CINGOLO IN GOMMA BASSO PROFILO NERO | RUBBER TRACK LOW PROFILE BLACK | CHENILLE EN CAOUTCHOUC | GUMMIRAUPE | ORUGA DE GOMA |
| 1 053715LB | 2 NR | CINGOLO IN GOMMA BASSO PROFILO ANTITRACCIA | RUBBER TRACK LOW PROFILE NO MARKING | CHENILLE EN CAOUTCHOUC | GUMMIRAUPE | ORUGA DE GOMA |
| 2 03149200 | 1 NR | VALVOLA IDRAULICA | HYDRAULIC VALVE | VALVE HYDRAULIQUE | HYDRAULIKVENTIL | VÁLVULA HIDRÁULICA |
| 3 10681670 | 1 NR | CILINDRO | CYLINDER | VÉRIN | ZYLINDER | CILINDRO |
| 4 03024800 | 1 NR | MOLLA | SPRING | RESSORT | FEDER | MUELLE |
| 5 34719500 | 1 NR | PIATTO | PLATE | PLATEAU | PLATTE | PLACA |
| 6 147534Y1 | 2 NR | SUPPORTO TENDICINGOLO | IDLER SUPPORT | SUPPORT TENDEUR CHENILLE | KETTEHSPANNE R-HALTER | SOPORTE TENSOR ORUGA |
| 7 153937H2 | 2 NR | RUOTA TENDICINGOLO | IDLER WHEEL | ROUE TENDEUR DE CHENILLE | RAUPENSPANNRAD | RUEDA TENSOR ORUGA |
| 9 153515H2 | 6 NR | RULLO INFERIORE | CARRIER ROLLER | ROULEAU INFÉRIEUR | UNTERE ROLLER | RODILLO INFERIOR |
| 10 041736H2 | 2 NR | RUOTA DI TRAZIONE | SPROCKET WHEEL | ROUE DE TRACTION | ANTRIEBSRAD | RUEDA DE ARRASTRE |
| 10 055707H2 | 2 NR | RUOTA DI TRAZIONE | SPROCKET WHEEL | ROUE DE TRACTION | ANTRIEBSRAD | RUEDA DE ARRASTRE |





 SOTTOCARRO CINGOLATO

 RAUPENFAHRWERK

 TRACKED UNDERCARRIAGE

 CARRO DE ORUGAS

 CHENILLARD

| POS Codice | Q.tà |  Descrizione |  Description |  Designation |  Benennung |  Descripción |
|---------------|------|---|---|---|---|---|
| 11 147411H2 | 2 NR | MOTORIDUTTORE | MOTORGearBOX | MOTORÉDUCTEU R | GETRIEBEMOTOR | MOTORREDUCTO R |
| 11 267525H2 | 2 NR | MOTORIDUTTORE 700C2K I:32 + MAG12 VP AUTO2SPEED CON FRENO | GEAR MOTOR 700C2K I: 32 + MAG12 VP AUTO2SPEED WITH BRAKE | MOTORÉDUCTEU R | GETRIEBEMOTOR | MOTORREDUCTO R |
| 12 053809H2 | 2 NR | COPERCHIO | COVER | COUVERCLE | DECKEL | TAPA |
| 12 054868H2 | 2 NR | COPERCHIO 2 VELOCITÀ | COVER HIGH SPEED | COUVERCLE | TAPA | DEKSEL |
| 13 1474110002 | 1 NR | MOTORE IDRAULICO | HYDRAULIC MOTOR | MOTEUR HYDRAULIQUE | HYDRAULIKMOTO R | MOTOR HIDRÁULICO |
| 14 1450590003 | 1 NR | VALVOLA IDRAULICA | HYDRAULIC VALVE | VALVE HYDRAULIQUE | VALVE HYDRAULIQUE | VÁLVULA HIDRÁULICA |
| 15 1450590004 | 1 NR | KIT GUARNIZIONI COMPLETO PER 145059NV-147411 NV-15041600 | SEALS COMPLETE KIT 145059 147411 NV-NV-15041600 | KIT JOINTS | DICHTUNGSSATZ | KIT JUNTAS |

 ALLARGAMENTO IDRAULICO

HYDR. SPURWEITENVER STELLEINRICHTUNG 

 HYDRAULIC EXTENSION

EXTENSION HIDRAULICA 



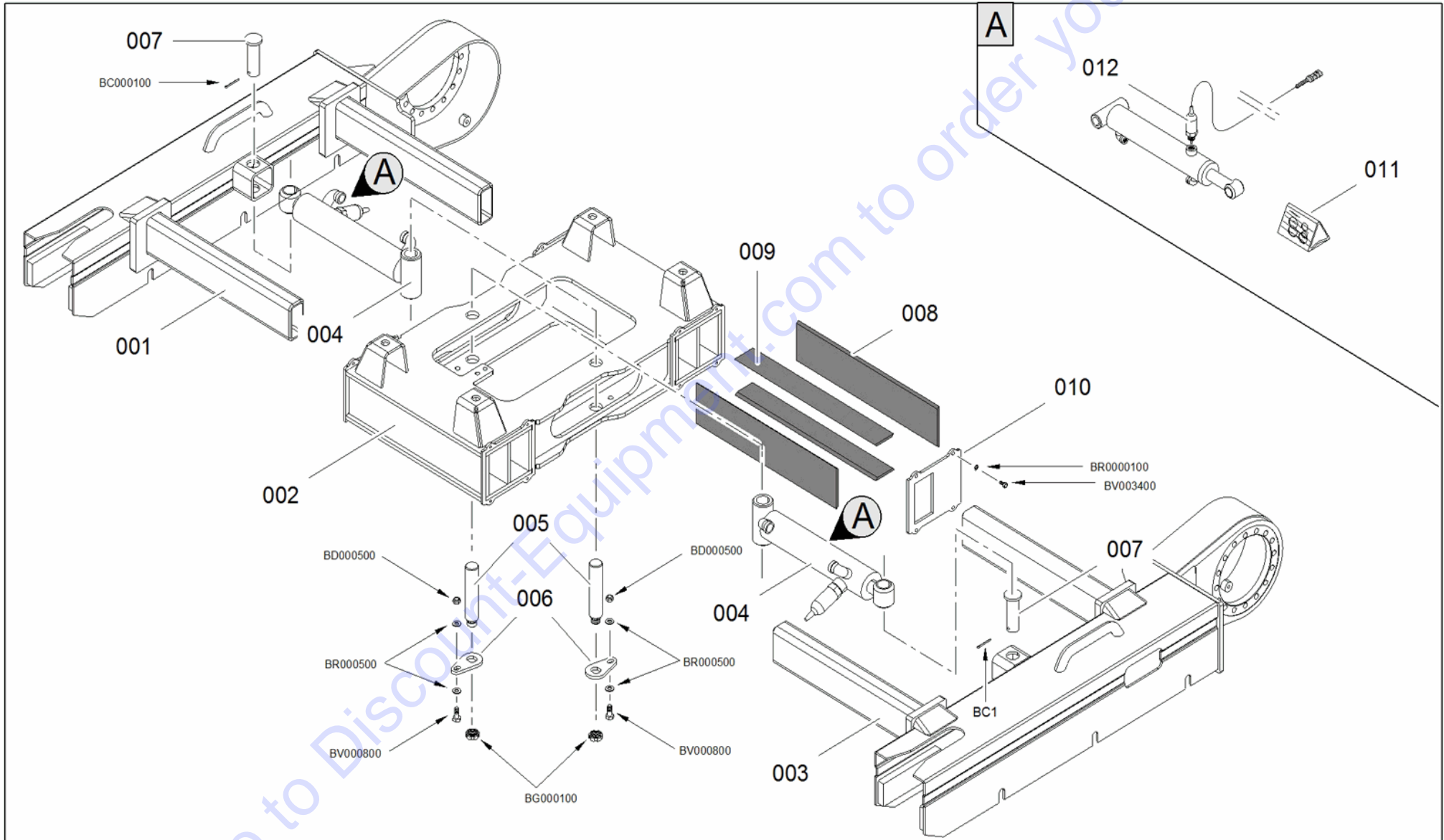

 ECARTEMENT HYDRAULIQUE



 ALLARGAMENTO IDRAULICO

 HYDR. SPURWEITENVER STELLEINRICHTUNG 
 HYDRAULIC EXTENSION





 EXTENSION HIDRAULICA 
 ECARTEMENT HYDRAULIQUE

| POS Codice | Q.tà |  Descrizione |  Description |  Designation |  Benennung |  Descripción |
|------------|------|---|---|---|---|---|
| 1 377583H2 | 1 NR | LONGHERONE DESTRO SOTTOCARRO ALLARGABILE LL1570 AUTO2SPEED | RIGHT EXTENDABLE UNDERCARRIAG E LL1570 AUTO2SPEED | PARTIE DROITE CHENILLARD | FAHRWERK RECHTE SEITE | PARTE DERECHA DEL CARRO |
| 1 378038H2 | 1 NR | LONGHERONE DESTRO SOTTOCARRO ALLARGABILE LL1570 SINGOLA VELOCITA' HINOWA GREY | LONGHERONE RIGHT EXTENDABLE UNDERCARRIAG E LL1570 SINGLE SPEED 'HINOWA GREY | TRAIN DE CHENILLE DROITE | RECHTER FAHRSCHIFF | PARTE CARRO DERECHO |
| 2 377559H2 | 1 NR | STRUTTURA CENTRALE SOTTOCARRO LL1570 SALDATA | CENTRAL STRUCTURE UNDERCARRIAG E LL1570 WELDED | ESTRUCTURE CENTRALE | MITTELBAU | ESTRUCTURA CENTRAL |

 ALLARGAMENTO IDRAULICO

 HYDR. SPURWEITENVER STELLEINRICHTUNG 
 HYDRAULIC EXTENSION





 EXTENSION HIDRAULICA 
 ECARTEMENT HYDRAULIQUE

| POS Codice | Q.tà |  Descrizione |  Description |  Designation |  Benennung |  Descripción |
|------------|------|---|---|---|---|---|
| 3 377584H2 | 1 NR | LONGHERONE SINISTRO SOTTOCARRO ALLARGABILE LL1570 AUTO2SPEED | LEFT EXTENDABLE UNDERCARRIAG E LL1570 AUTO2SPEED | PARTIE GAUCHE CHENILLARD | FAHRWERK LINKER SEITE | PARTE IZQUIERDA DEL CARRO |
| 3 378039H2 | 1 NR | LONGHERONE DESTRO SOTTOCARRO ALLARGABILE LL1570 SINGOLA VELOCITA' HINOWA GREY | LONGHERONE RIGHT EXTENDABLE UNDERCARRIAG E LL1570 SINGLE SPEED 'HINOWA GREY | TRAIN DE CHENILLE DROIT | RECHTER FAHRSCHIFF | PARTE CARRO DERECHO |
| 4 277103H2 | 2 NR | CILINDRO ALLARGAMENTO CARRO LL1570-X15JP-X4 30AJ | CYLINDER ENLARGEMENT CARRIAGE LL1570-X15JP-X4 30AJ | CYLINDRE ÉLARGISSEMENT | SPURVERBREITE RUNGSZYLINDER | CILINDRO ENSANCHAMIENT O |
| 5 06023800 | 2 NR | SPINA FONDELLO ALLARGAMENTO | BOTTOM PLUG ENLARGEMENT | BAS PLUG ELARGISSEMENT | UNTEN PLUG ERWEITERUNG | BASE ENCHUFE AMPLIACIÓN |
| 6 064965Y1 | 2 NR | GOCCIA SPINA | PIN DROP | BAISSE CHEVILLE | TROPFEN | CAÍDA CLAVIJA |
| 7 04256300 | 2 NR | SPINA | PIN | CHEVILLE | STIFT | CLAVIJA |

 ALLARGAMENTO IDRAULICO

 HYDR. SPURWEITENVER STELLEINRICHTUNG 
 HYDRAULIC EXTENSION

 EXTENSION HIDRAULICA 
 ECARTEMENT HYDRAULIQUE

| POS Codice | Q.tà |  Descrizione |  Description |  Designation |  Benennung |  Descripción |
|---------------|------|---|---|---|---|---|
| 8 07758900 | 8 NR | GUIDA ALLARGAMENTO LL1570-X15JP-X4 30AJ 88X4.2X374 | ENLARGEMENT GUIDE LL1570-X15JP-X4 30AJ 88X4.2X374 | GUIDE | FÜHRUNG | GUÍA |
| 9 07758800 | 8 NR | GUIDA ALLARGAMENTO LL1570 48X4.2X374 | GUIDE | GUIDE | FÜHRUNG | GUÍA |
| 10 377580H2 | 4 NR | COPERCHIO FERMO GUIDE ALLARGAMENTO LL1570 | COVER GUIDE ENLARGEMENT LL1570 | COUVERCLE | ABDECKUNG | TAPA |
| 11 2771030001 | 1 NR | KIT GUARNIZIONE CILINDRO ALLARGAMENTO CARRO LL1570 X15JP X430AJ | CYLINDER SEAL KIT CARRIAGE ENLARGEMENT LL1570 X15JP X430AJ | KIT JOINT | DICHTUNGSSATZ | KIT JUNTAS |
| 12 17329500 | 2 NR | MICROINTERRUTT ORE ALLARGAMENTO CARRO N/O COMPLETO DI CAVO E CONNETTORE | WIDENING SYSTEM MICRO SWITCH N/O CONTACT WITH CABLE AND CONNECTOR | MICRO INTERRUPTEUR ELARGISSEMENT AVEC CABLE ET CONNECTEUR | MIKROSCHALTER SPURVERBREITE RUNG MIT KABEL UND STECKER | MICROINTERRUP TOR ENSANCHAMIEN O CON CABLE Y CONECTOR |

 BASE TORRETTA

ARBEITSTURM 



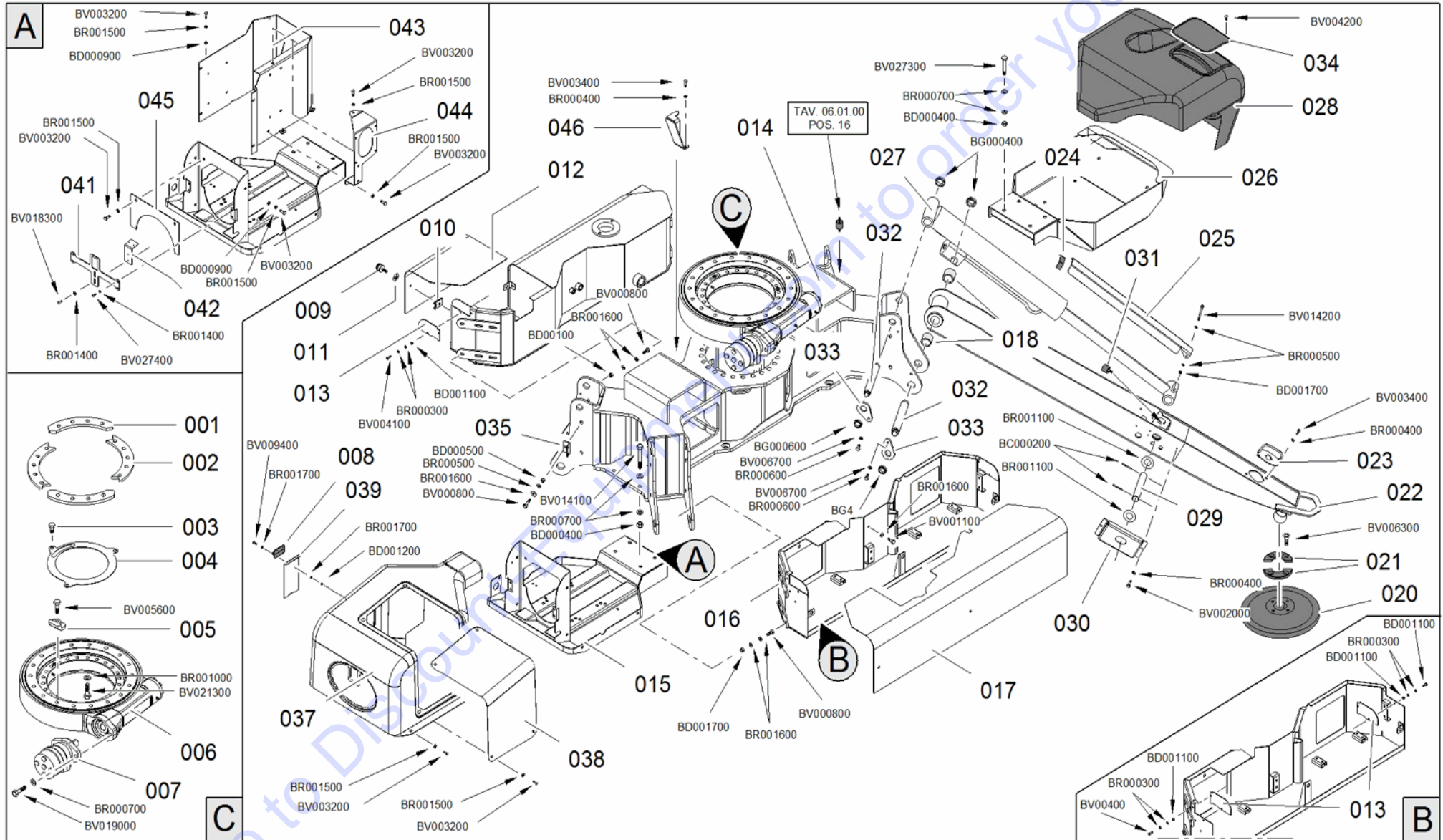

 TURRET BASE

BASE TORRETTA GIRATORIA 





 BASE TOURELLE







 BASE TORRETTA
ARBEITSTURM 
 TURRET BASE
BASE TORRETA GIRATORIA 
 BASE TOURELLE

| POS Codice | Q.tà |  Descrizione |  Description |  Designation |  Benennung |  Descripción |
|-------------|------|---|---|---|---|---|
| 1 069349Y1 | 2 NR | SPESSORE | THICKNESS | CALE | STÄRKE | ESPESOR |
| 2 069348Y1 | 2 NR | SPESSORE | THICKNESS | CALE | STÄRKE | ESPESOR |
| 4 077710Y1 | 1 NR | RISCONTRO | FASTENER LOCATOR | PLAQUE POUR AGRAFAGE | ANSCHLAG | GANCHO |
| 5 068911Y1 | 1 NR | FERMO | RETAINER | ARRÊT | HALTERUNG | BLOQUE |
| 6 269450H2 | 1 NR | RALLA | FIFTH WHEEL | COURONNE DENTÉE | DREHKRANZ | TEJUELO |
| 7 261308H2 | 1 NR | MOTORE DI ROTAZIONE | ROTARY MOTOR | MOTEUR DE ROTATION | ROTATIONSMOTOR | MOTOR DE ROTACIÓN |
| 8 07178700 | 4 NR | CERNIERA CON CONTROLLO DELLA POSIZIONE | HINGES WITH POSITION CONTROL | CHARNIÈRE | SCHARNIER | BISAGRA |
| 9 07343200 | 6 NR | VITE IMPERDIBILE ZIGRINATA CORTA | SHORT IMPERDIBLE KNURLED SCREW | VIS IMPERDABLE | SCHRAUBE | TORNILLO IMPERDIBLE |
| 10 07343300 | 6 NR | RICETTACOLO PER VITE IMPERDIBILE | RECEPTACLE FOR IMPERDIBLE SCREW | PRISE DE VIS POUR VIS IMPERDABLE | AUFNAHME FÜR SCHRAUBE | REFUGIO TORNILLO IMPERDIBLE |
| 11 07343400 | 6 NR | AGGANCIO PER VITE IMPERDIBILE | COUPLING FOR IMPERDIBLE SCREW | CROCHET VIS IMPERDABLE | HAKEN FÜR SCHRAUBE | GANCHO TORNILLO IMPERDIBLE |





 BASE TORRETTA
ARBEITSTURM 
 TURRET BASE
BASE TORRETA GIRATORIA 
 BASE TOURELLE

| POS Codice | Q.tà |  Descrizione |  Description |  Designation |  Benennung |  Descripcìon |
|-------------|------|---|---|---|---|---|
| 12 077481J2 | 1 NR | COPERCHIO VANO BATTERIA | COVER BATTERY COMPARTMENT | COUVERCLE | DECKEL | TAPA |
| 13 077446J2 | 3 NR | TAPPO LATERALE | CAP | BOUCHON | VERSCHLUSS | TAPA |
| 14 377414H2 | 1 NR | BASE LL1570 SALDATA | BASE LL1570 WELDED | BASE LL1570 SAUDÉE | LL1570 GESCHWEISSTE BASIS | BASE SOLDATA LL1570 |
| 15 377732H2 | 1 NR | ASSIEME SUPPORTO COMPONENTI ELETTRICI LL1570 SALDATO | ASSEMBLY SUPPORT ELECTRICAL COMPONENTS LL1570 WELDED | ENSEMBLE SUPPORT COMPOSANT ÉLECTRIQUES LL1570 | HALTERUNG FÜR ELEKTRISCHE KOMPONENTEN | SOPORTE COMPONENTES ELÉCTRICOS |
| 16 377439J2 | 1 NR | SCATOLA IMPIANTO IDRAULICO LL1570 SALDATA | BOX HYDRAULIC LL1570 WELDED | BOÎTIER INSTALLATION HYDRAULIQUE | GEHÄUSE FÜR HYDRAULISCHE ANLAGE | CAJA INSTALACIÓN HIDRÁULICA |
| 17 077447J2 | 1 NR | COPERCHIO VANO COMPONENTI IDRAULICI | COVER COMPARTMENT HYDRAULIC COMPONENTS | COUVERCLE | DECKEL | TAPA |
| 18 07765300 | 2 NR | BOCCOLA DEVA.TEX552 253030 | BUSH DEVA. TEX 552 253030 | DOUILLE | BUCHSE | CASQUILLO |
| 20 05446300 | 4 NR | DISCO | DISK | DISQUE | SCHEIBE | DISCO |
| 21 073147Y1 | 8 NR | SEMIFLANGIA | HALF FLANGE | DEMI-BRIDE | HALB FLANSCH | SEMI BRIDA |





 BASE TORRETTA
ARBEITSTURM 
 TURRET BASE
BASE TORRETA GIRATORIA 
 BASE TOURELLE

| POS Codice | Q.tà |  Descrizione |  Description |  Designation |  Benennung |  Descripcìon |
|-------------|------|---|---|---|---|---|
| 22 177406J2 | 4 NR | ASSIEME STABILIZZATORE COMPLETO | ASSEMBLY COMPLETE STABILIZE | STABILISATEUR | ABSTÜTZUNG | ESTABILIZADOR |
| 23 376018H2 | 4 NR | SUPPORTO SPIA STABILIZZATORE (FOR LL2010-X20JP-X6 00AJ MK2 FROM C170000893) | OUTRIGGER LIGHT SUPPORT (FOR LL2010-X20JP-X6 00AJ MK2 FROM C170000893) | SUPPORT LUMIÈRE STABILISATEUR (FOR LL2010-X20JP-X6 00AJ MK2 FROM C170000893) | LICHTHALTERUN G (FOR LL2010-X20JP-X6 00AJ MK2 FROM C170000893) | SOPORTE LUZ (FOR LL2010-X20JP-X6 00AJ MK2 FROM C170000893) |
| 24 07894900 | 4 NR | GOMMA ADESIVA DI PROTEZIONE L=70 | RUBBER ADHESIVE PROTECTION L=70 | GOMME ADHESIVE DE PROTECTION L=70 | SCHUTZ-KLEBEG UMMI L=70 | GOMA ADHESIVA DE PROTECCIÓN L=70 |
| 25 072700H2 | 4 NR | CARTER DI PROTEZIONE | PROTECTION COVER | CARTER DE PROTECTION | CARTER VON SCHUTZ | CARTER DE PROTECCIÓN |
| 26 377484H2 | 1 NR | SUPPORTO MOTORE TERMICO LL1570 SALDATO | SUPPORT ENGINE LL1570 WELDED | SUPPORT MOTEUR | HALTERUNG FÜR MOTOR | SOPORTE MOTOR |
| 27 277102H2 | 4 NR | CILINDRO STABILIZZATORE LL1570-X15JP-X4 30AJ | CYLINDER STABILIZER LL1570-X15JP-X4 30AJ | CYLINDER STABILISATEUR | ABSTÜTZUNGSZY LINDER | CILINDRO ESTABILIZADOR |





 BASE TORRETTA
ARBEITSTURM 
 TURRET BASE
BASE TORRETTA GIRATORIA 
 BASE TOURELLE

| POS Codice | Q.tà |  Descrizione |  Description |  Designation |  Benennung |  Descripción |
|-------------|-------|---|---|---|---|---|
| 28 377953H2 | 1 NR | COFANO MOTORE DIESEL | ENGINE COVER DIESEL | CAPOT | MOTORHAUBE | CAPÓ |
| 28 377954H2 | 1 NR | COFANO MOTORE BENZINA | ENGINE COVER PETROL | CAPOT MOTEUR ESSENCE | MOTORHAUBE FÜR BENZIN MOTOR | CAPÓ PARA MOTOR DE GASOLINA |
| 29 07754600 | 4 NR | SPINA OCCHIO CILINDRO STABILIZZATORE LL1570-X15JP-X4 30AJ | PIN EYE CYLINDER STABILIZER LL1570-X15JP-X4 30AJ | AXE | STIFT | CLAVIJA |
| 30 077413H2 | 4 NR | PIEGATO PROTEZIONE MICRO STABILIZZATORE | BENT PROTECTION MICRO STABILIZER | PROTECTION MICROINTERRUP TEUR | SCHUTZABDECK UNG MIKROSCHALTER | PROTECCIÓN MICROINTERRUP TOR |
| 31 05876400 | 4 NR | ANTIVIBRANTE | ANTI-VIBRATING | ANTI - VIBRANT | VIBRATIONS DÄM PFER | ANTIVIBRANTE |
| 32 07772000 | 8 NR | PERNO ATTACCO STABILIZZATORE A BASE LL1570-X15JP-X4 30AJ | PIN CONNECTION STABILIZER BASED LL1570-X15JP-X4 30AJ | AXE | STIFT | PERNIO |
| 33 064966Y1 | 13 NR | GOCCIA SPINA | PIN DROP | BAISSE CHEVILLE | TROPFEN STIFT | CAÍDA CLAVIJA |

 BASE TORRETTA
ARBEITSTURM 
 TURRET BASE
BASE TORRETA GIRATORIA 
 BASE TOURELLE

| POS Codice | Q.tà |  Descrizione |  Description |  Designation |  Benennung |  Descripcìon |
|-------------|------|---|---|---|---|---|
| 34 077955H2 | 1 NR | COPERCHIO PER ACCESSO A FILTRO ARIA SU MOTORE BENZINA | COVER FOR ACCESS TO AIR FILTER ON GASOLINE ENGINE | COUVERCLE | DECKEL | TAPA |
| 35 055629H3 | 1 NR | STAFFA | BRACKET | ÉTRIER | HALTEBÜGEL | ESTRIBO |
| 37 077742H2 | 1 NR | COFANO MOTORE ELETTRICO | ELECTRIC ENGINE COVER | CAPOT | MOTOR HAUBE | CAPÓ |
| 38 077743H2 | 1 NR | PORTELLO LATERALE MANUTENZIONE MOTORE ELETTRICO | DOOR LATERAL MAINTENANCE ELECTRIC MOTOR | GUICHET | ABDECKPLATTE | PORTILLA |
| 39 077744H2 | 1 NR | PORTELLO ACCESSO CHIAVE EMERGENZE | DOOR ACCESS KEY EMERGENCIES | GUICHET | ABDECKPLATTE | PORTILLA |
| 41 077745Y1 | 1 NR | PIATTO FISSAGGIO FOTOCELLULA CATAFORESI | PLATE FIXING PHOTOCELL | PLAQUE | PLATTE | PLACA |
| 42 061185Y1 | 1 NR | LAMIERA PIEGATA | FOLDED PLATE | TÔLE PLIÉE | BLECH GEBOGEN | CHAPA DOBLADA |

 BASE TORRETTA
ARBEITSTURM 
 TURRET BASE
BASE TORRETA GIRATORIA 
 BASE TOURELLE

| POS Codice | Q.tà |  Descrizione |  Description |  Designation |  Benennung |  Descripción |
|-------------|------|---|---|---|---|---|
| 43 077738Y1 | 1 NR | PIEGATO FISSAGGIO COMPONENTI ELETTRICI LL1570 | BENT FIXING ELECTRICAL COMPONENTS LL1570 | SUPPORT | HALTERUNG | SOPORTE |
| 44 077739Y1 | 1 NR | PIEGATO FISSAGGIO MODEM LL1570 | BENT SECURING MODEM LL1570 | SUPPORT | HALTERUNG | SOPORTE |
| 45 077740Y1 | 1 NR | PARATIA SUPERIORE MOTORE ELETTRICO LL1570 | UPPER PLATE ELECTRIC MOTOR LL1570 | PLAQUE | PLATTE | PLACA |
| 46 077721D2 | 1 NR | INDICE ALLINEAMENTO FISSO LL1570 | ALIGNMENT INDEX FIXED LL1570 | INDEX | INDEX | ÍNDICE |

Go to Discount-Equipment.com to order your parts

 SERBATOIO OLIO

ÖLTANK 

 OIL TANK

DEPÓSITO DE ACEITE 



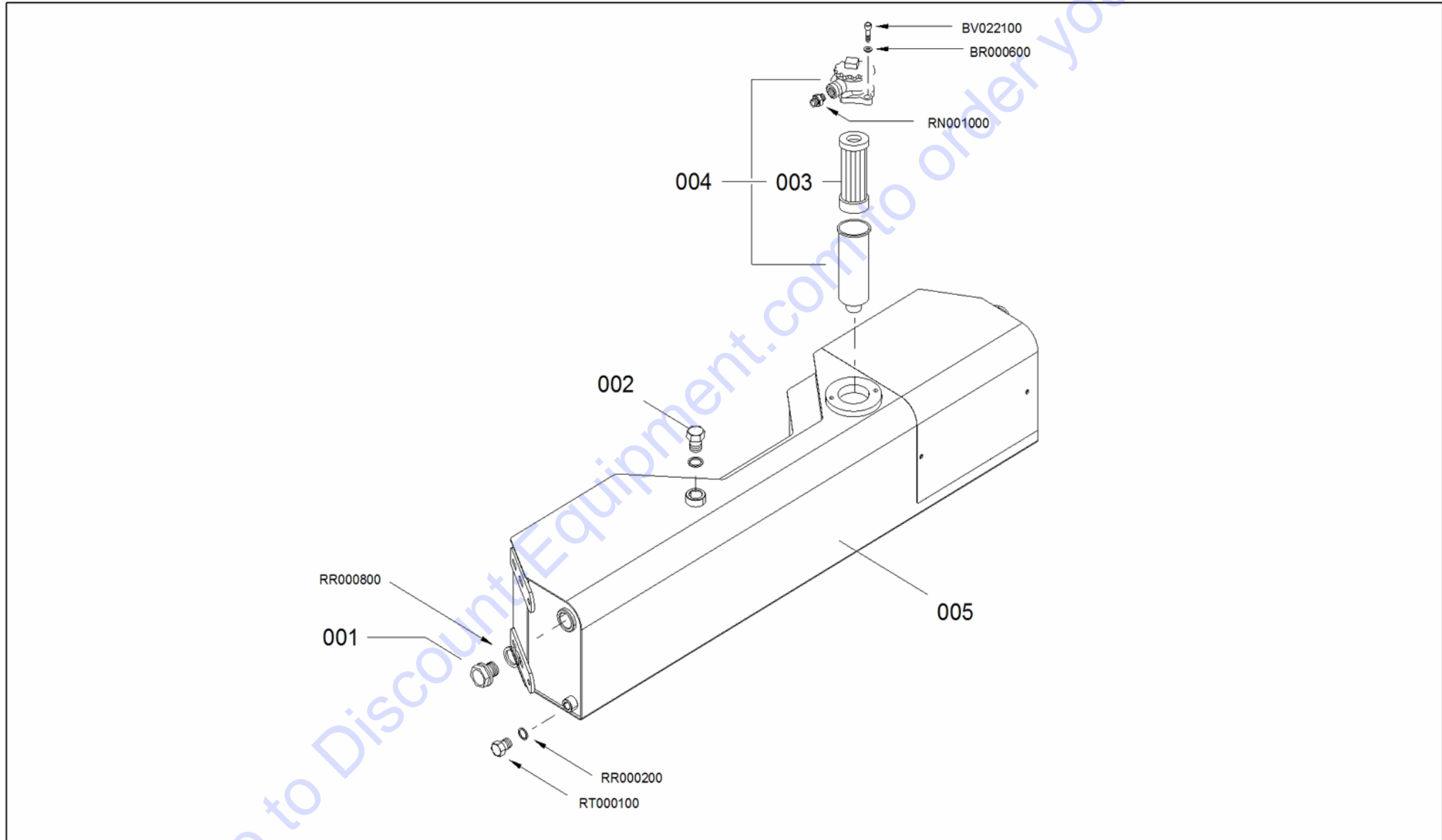

 RÉSERVOIR D'HUILE



 SERBATOIO OLIO

 ÖLTANK 
 OIL TANK

 DEPÓSITO DE ACEITE 
 RÉSERVOIR D'HUILE

| POS Codice | Q.tà |  Descrizione |  Description |  Designation |  Benennung |  Descripción |
|------------|------|---|---|---|---|---|
| 1 05061800 | 1 NR | LIVELLO OLIO | OIL LEVEL | NIVEAU HUILE | ÖLSTAND | NIVEL ACEITE |
| 2 05611800 | 1 NR | TAPPO OLIO | OIL PLUG | BOUCHON D'HUILE | ÖLDECKEL | TAPÓN ACEITE |
| 3 05120200 | 1 NR | CARTUCCIA FILTRO OLIO IDRAULICO | OIL FILTER INSERT | CARTOUCHE FILTRE À HUILE | ÖLFILTEREINSAT Z | CARTUCHO FILTRO ACEITE |
| 4 15120100 | 1 NR | FILTRO OLIO IDRAULICO COMPLETO | COMPLETE HYDRAULIC OIL FILTER | FILTRE À HUILE | HYDARULIKÖLFIL TER | FILTRO ACEITE HIDRÁULICO |
| 5 177477J2 | 1 NR | SERBATOIO OLIO COMPLETO LL1570 | OIL TANK LL1570 | RÉSERVOIR HUILE | ÖLTANK | DEPÓSITO DE ACEITE |

 PRIMO BRACCIO

ERSTER AUSLEGERARM 

 FIRST ARM

PRIMO BRAZO 

 PREMIER BRAS

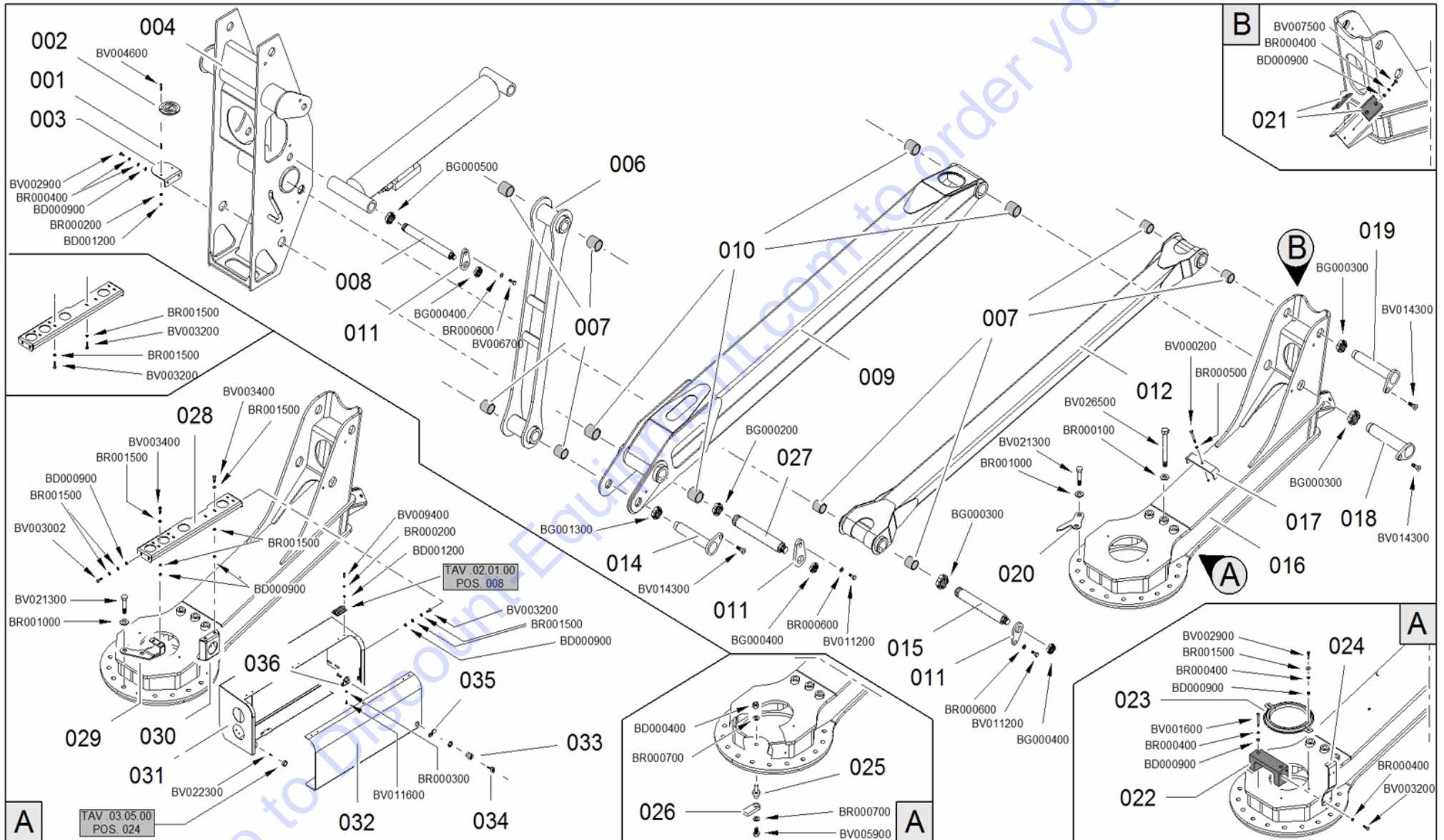





 PRIMO BRACCIO

 ERSTER AUSLEGERARM

 FIRST ARM

 PRIMO BRAZO

 PREMIER BRAS

| POS Codice | Q.tà |  Descrizione |  Description |  Designation |  Benennung |  Descripción |
|------------|------|---|---|---|---|---|
| 1 05444800 | 3 NR | MOLLA | SPRING | RESSORT | FEDER | MUELLE |
| 2 05427200 | 1 NR | LIVELLA | LEVEL | NIVEAU | WASSERWAAGE | NIVEL DE BURBUJA |
| 3 058832H3 | 1 NR | SUPPORTO | SUPPORT | SUPPORT | HALTERUNG | SOPORTE |
| 4 377599J1 | 1 NR | RINVIO PRIMO-SECONDO BRACCIO LL1570 SALDATO | REFERENCE FIRST-SECOND BOOM LL1570 WELDED | RENOI | VORGELEGE | REENVIO |
| 6 177114J1 | 1 NR | BIELLA PRIMO-SECONDO BRACCIO LL1570 COMPLETA | CONNECTING ROD COMPLETE FIRST-SECOND BOOM LL1570 | BIELLE | PLEUELSTANGE | BIELA |
| 7 07765100 | 4 NR | BOCCOLA DEVA.TEX552 354040 | BUSH DEVA. TEX 552 354040 | DOUILLE | BUCHSE | CASQUILLO |
| 8 07755000 | 1 NR | SPINA FONDELLO CILINDRO 1°2°BRACCIO LL1570-X15JP-X4 30AJ | PIN BOTTOM CYLINDER 1ST 2ND ARM LL1570-X15JP-X4 30AJ | AXE | STIFT | CLAVIJA |
| 9 177590J1 | 1 NR | PRIMO BRACCIO LL1570 COMPLETO | FIRST COMPLETE BOOM LL1570 | PREMIER BRAS | ERSTER ARM | PRIMERO BRAZO |





 PRIMO BRACCIO

 ERSTER AUSLEGERARM

 FIRST ARM

 PRIMO BRAZO

 PREMIER BRAS

| POS Codice | Q.tà |  Descrizione |  Description |  Designation |  Benennung |  Descripción |
|-------------|-------|---|---|---|---|---|
| 10 07765000 | 4 NR | BOCCOLA DEVA. TEX552 404540 | BUSH DEVA. TEX 552 404540 | DOUILLE | BUCHSE | CASQUILLO |
| 11 064967Y1 | 12 NR | GOCCIA SPINA | PIN DROP | BAISSE CHEVILLE | TROPFEN STIFT | CAÍDA CLAVIJA |
| 12 177117J1 | 1 NR | TIRANTE PRIMO BRACCIO LL1570 COMPLETO | TIE ROD BOOM COMPLETE FIRST LL1570 | TIRANT PREMIER BRAS | SPANNSTANGE ERSTER ARM | TIRANTE PRIMERO BRAZO |
| 14 07755200 | 1 NR | PERNO ATTACCO BIELLA A 1°BRACCIO LL1570-X15JP-X4 30AJ | PIN CONNECTION ROD A 1ST ARM LL1570-X15JP-X4 30AJ | AXE | STIFT | CLAVIJA |
| 15 07754900 | 1 NR | PERNO ATTACCO TIRANTE 1°BRACCIO A RINVIO 1°2°BRACCIO LL1570-X15JP-X4 30AJ | PIN CONNECTION TIE 1ST ARM REFERENCE 1ST 2ND ARM LL1570-X15JP-X4 30AJ | AXE | STIFT | CLAVIJA |
| 16 377429J1 | 1 NR | SUPPORTO BRACCI LL1570 SALDATO | SUPPORT BOOMS LL1570 WELDED | SUPPORT DES BRAS LL1570 SOUDÉ | LL1570 GESCHWEISSTE HALTERUNG DER ÄRME | SOPORTE BRAZOS LL1570 SOLDADO |
| 17 060372Y2 | 1 NR | FERMO | RETAINER | ARRÊT | HALTERUNG | SUJETADOR |





 PRIMO BRACCIO

 ERSTER AUSLEGERARM





 FIRST ARM

 PRIMO BRAZO

 PREMIER BRAS

| POS Codice | Q.tà |  Descrizione |  Description |  Designation |  Benennung |  Descripción |
|-------------|------|---|---|---|---|---|
| 18 07754700 | 1 NR | PERNO ATTACCO 1° BRACCIO A SUPPORTO BRACCI LL1570-X15JP-X4 30AJ | PIN CONNECTION 1ST ARM SUPPORT ARMS LL1570-X15JP-X4 30AJ | AXE | STIFT | CLAVIJA |
| 19 07754800 | 1 NR | PERNO ATTACCO TIRANTE 1°BRACCIO A SUPPORTO BRACCI LL1570-X15JP-X4 30AJ | PIN CONNECTION TIE 1ST ARM SUPPORT ARMS LL1570-X15JP-X4 30AJ | AXE | STIFT | CLAVIJA |
| 20 071531D2 | 1 NR | INDICE ALLINEAMENTO | ALIGNMENT INDICATOR | INDICATEUR D'ALIGNEMENT | AUSRICHTUNGSA NZEIGE | INDICADOR ALINEACIÓN |
| 21 05849000 | 4 NR | PATTINO | SLIDE BLOCK | PATIN | GLEITBLOCK | PATÍN |
| 22 07771600 | 1 NR | TAMPONE APPOGGIO PRIMO BRACCIO LL1570 | BUFFER FOR SUPPORT FIRST ARM LL1570 | TAMPON | PUFFER | TAMPÓN |
| 23 069590H3 | 1 NR | PROTEZIONE | PROTECTION | PROTECTION | SCHUTZ | PROTECCIÓN |
| 24 077717H3 | 1 NR | STAFFA FISSAGGIO MICRO PRIMO BRACCIO | BRACKET MICRO FIRST BOOM | BRIDE | BÜGEL | BRIDA |





 PRIMO BRACCIO
ERSTER AUSLEGERARM 
 FIRST ARM
PRIMO BRAZO 
 PREMIER BRAS

| POS Codice | Q.tà |  Descrizione |  Description |  Designation |  Benennung |  Descripción |
|-------------|------|---|---|---|---|---|
| 25 068912Y1 | 1 NR | PERNO | PIN | GOUJON | ZAPFEN | PERNIO |
| 26 064422Y1 | 1 NR | FERMO | RETAINER | ARRÊT | HALTEVORRICHTUNG | BLOQUE |
| 27 07539800 | 1 NR | SPINA | PIN | AXE | STIFT | CLAVIJA |
| 28 077556H3 | 1 NR | PIEGATO FISSAGGIO DISTRIBUTORE LL1570 | BENT FITTING DISTRIBUTOR LL1570 | SUPPORT | HALTERUNG | SOPORTE |
| 29 077558H2 | 1 NR | PIEGATO ANTERIORE SUPPORTO DISTRIBUTORE | BENT FRONT SUPPORT DISTRIBUTOR | SUPPORT | HALTERUNG | SOPORTE |
| 30 077557H2 | 1 NR | PIEGATO POSTERIORE SUPPORTO DISTRIBUTORE | BENT BACK SUPPORT DISTRIBUTOR | SUPPORT | HALTERUNG | SOPORTE |
| 31 373142H2 | 1 NR | CARTER DISTRIBUTORE BRACCI (FOR LL1775-X17JP-X5 00AJ MK2 FROM C170000893) | PROTECTION BOOM HYDRAULIC DISTRIBUTOR (FOR LL1775-X17JP-X5 00AJ MK2 FROM C170000893) | PROTECTION DISTRIBUTEUR (FOR LL1775-X17JP-X5 00AJ MK2 FROM C170000893) | SCHUTZ VENTILBLOCK (FOR LL1775-X17JP-X5 00AJ MK2 FROM C170000893) | PROTECCION DISTRIBUIDOR (FOR LL1775-X17JP-X5 00AJ MK2 FROM C170000893) |

 PRIMO BRACCIO

 ERSTER AUSLEGERARM 
 FIRST ARM

 PRIMO BRAZO 
 PREMIER BRAS

| POS Codice | Q.tà |  Descrizione |  Description |  Designation |  Benennung |  Descripción |
|-------------|------|---|---|---|---|---|
| 32 073144H2 | 1 NR | COPERCHIO (FOR LL1775-X17JP-X5 00AJ MK2 FROM C170000893) | COVER (FOR LL1775-X17JP-X5 00AJ MK2 FROM C170000893) | COUVERTURE (FOR LL1775-X17JP-X5 00AJ MK2 FROM C170000893) | DECKUNG (FOR LL1775-X17JP-X5 00AJ MK2 FROM C170000893) | COBERTURA (FOR LL1775-X17JP-X5 00AJ MK2 FROM C170000893) |
| 32 075059H2 | 1 NR | COPERCHIO SENZA CHIAVE VERSIONE ANSI (FOR LL1775-X17JP-X5 00AJ MK2 FROM C170000893) | COVER WITHOUT KEY ANSI VERSION (FOR LL1775-X17JP-X5 00AJ MK2 FROM C170000893) | COUVERTURE SANS CLÉ (FOR LL1775-X17JP-X5 00AJ MK2 FROM C170000893) | DECKUNG OHNE SCHLÜSSEL (FOR LL1775-X17JP-X5 00AJ MK2 FROM C170000893) | COBERTURA SIN LLAVE (FOR LL1775-X17JP-X5 00AJ MK2 FROM C170000893) |
| 33 07178800 | 1 NR | SERRATURA | LOCK | SERRURE | SCHLOSS | CERRADURA |
| 34 07298800 | 1 NR | CHIAVE PER SERRATURA POSTAZIONE COMANDO A TERRA | KEY TO THE LOCK ON THE GROUND CONTROL POSITION | CLÉ | SCHLÜSSEL | LLAVE |
| 35 07178900 | 1 NR | CAMMA PER SERRATURA DISASSAMENTO 3.2 | CAM LOCK FOR OFFSET 3.2 | CAME | NOCKEN | LEVA |
| 36 073138Y1 | 1 NR | SUPPORTO SERRATURA | LOCK SUPPORT | SUPPORT SERRURE | SCHLOSSHALTE RUNG | SOPORTE CERRADURA |

 SECONDO BRACCIO

ZWEITER AUSLEGERARM 



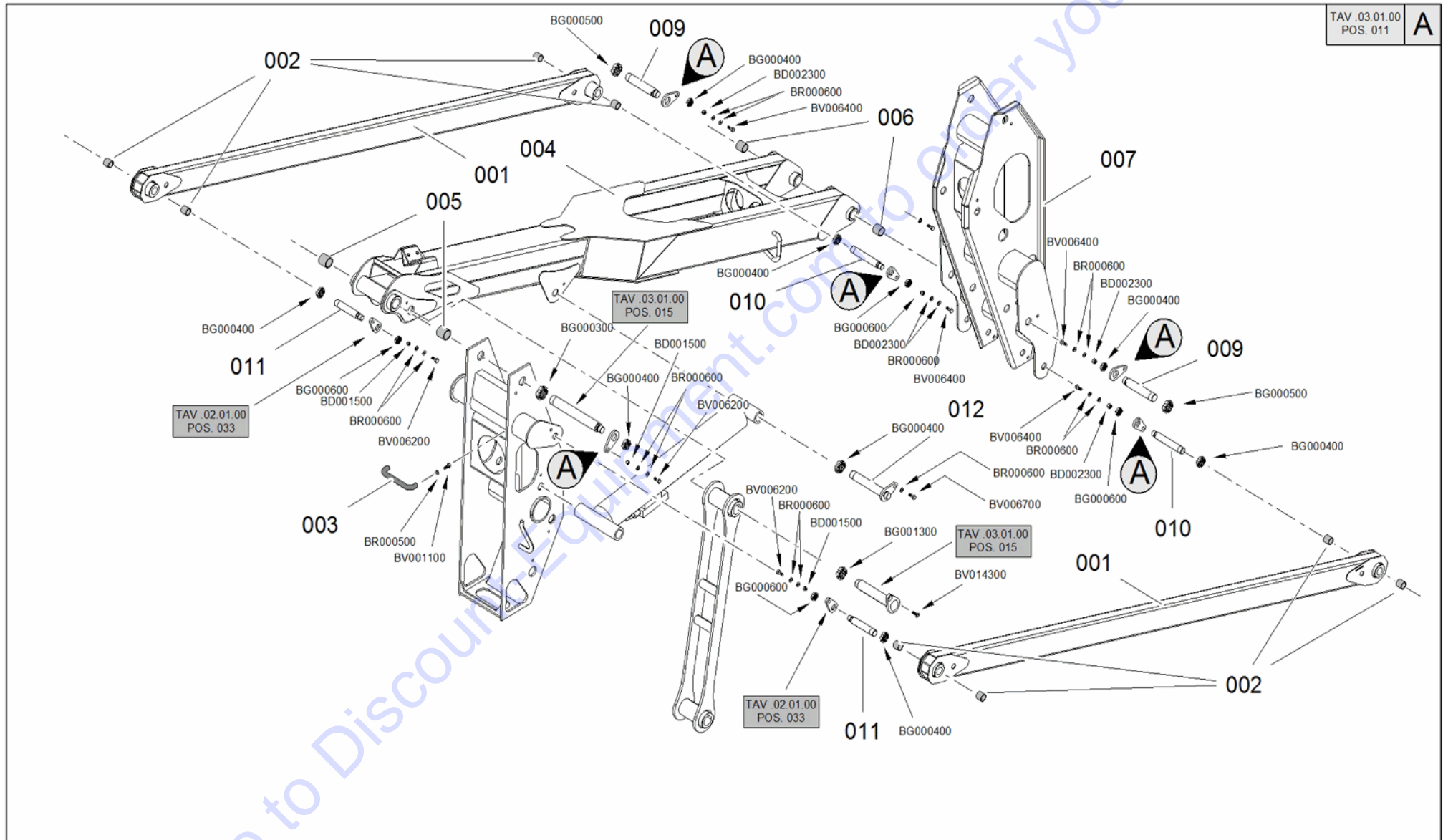

 SECOND ARM

SEGUNDO BRAZO 

 SECOND BRAS







 SECONDO BRACCIO
ZWEITER AUSLEGERARM 
 SECOND ARM
SEGUNDO BRAZO 
 SECOND BRAS

| POS Codice | Q.tà |  Descrizione |  Description |  Designation |  Benennung |  Descripción |
|------------|------|---|---|---|---|---|
| 1 177347J1 | 2 NR | TIRANTE SECONDO BRACCIO LL1570 COMPLETO | TIE ROD COMPLETE SECOND BOOM LL1570 | TIRANT DEUXIÈME BRAS | ZWEITER ARM TURMGESTÄNGE | TIRANTE SEGUNDO BRAZO |
| 2 07765300 | 4 NR | BOCCOLA DEVA.TEX552 253030 | BUSH DEVA. TEX 552 253030 | DOUILLE | BUCHSE | CASQUILLO |
| 3 07154000 | 1 NR | MANIGLIA | HANDLE | POIGNÉE | GRIFF | MANIJA |
| 4 177610J1 | 1 NR | SECONDO BRACCIO LL1570 COMPLETO | SECOND BOOM COMPLETE LL1570 | DEUMIÈME BRAS | ZWEITER ARM | SEGUNDO BRAZO |
| 5 07765100 | 2 NR | BOCCOLA DEVA.TEX552 354040 | BUSH DEVA. TEX 552 354040 | DOUILLE | BUCHSE | CASQUILLO |
| 6 07765200 | 4 NR | BOCCOLA DEVA.TEX552 303530 | BUSH DEVA. TEX 552 303530 | DOUILLE | BUCHSE | CASQUILLO |
| 7 377352J1 | 1 NR | RINVIO SECONDO-TERZ O BRACCIO LL1570 SALDATO | REFERENCE SECOND-THIRD BOOM LL1570 WELDED | RENVOI DEUXIÈME BRAS | ZWEITER ARM VORGELEGE | REENVIO SEGUNDO BRAZO |

 SECONDO BRACCIO

 ZWEITER AUSLEGERARM 
 SECOND ARM

 SEGUNDO BRAZO 
 SECOND BRAS

| POS Codice | Q.tà |  Descrizione |  Description |  Designation |  Benennung |  Descripcìon |
|-------------|------|---|---|---|---|---|
| 9 07755300 | 2 NR | PERNO ATTACCO TIRANTE 2°BRACCIO A RINVIO 2°3°BRACCIO LL1570-X15JP-X4 30AJ | PIN CONNECTION ROD 2ND ARM REFERENCE 2ND 3RD ARM LL1570-X15JP-X4 30AJ | AXE | STIFT | CLAVIJA |
| 10 07271600 | 2 NR | SPINA | PIN | CHEVILLE | STIF | CLAVIJA |
| 11 07755100 | 2 NR | PERNO ATTACCO TIRANTE 2°BRACCIOA RINVIO 1°2°BRACCIO LL1570-X15JP-X4 30AJ | PIN CONNECTION ROD 2ND ARM REFERENCE 1ST 2ND ARM LL1570-X15JP-X4 30AJ | AXE | STIFT | CLAVIJA |
| 12 07093900 | 1 NR | SPINA | PIN | CHEVILLE | STIF | CLAVIJA |

TERZO BRACCIO

THIRD AUSLEGERARM



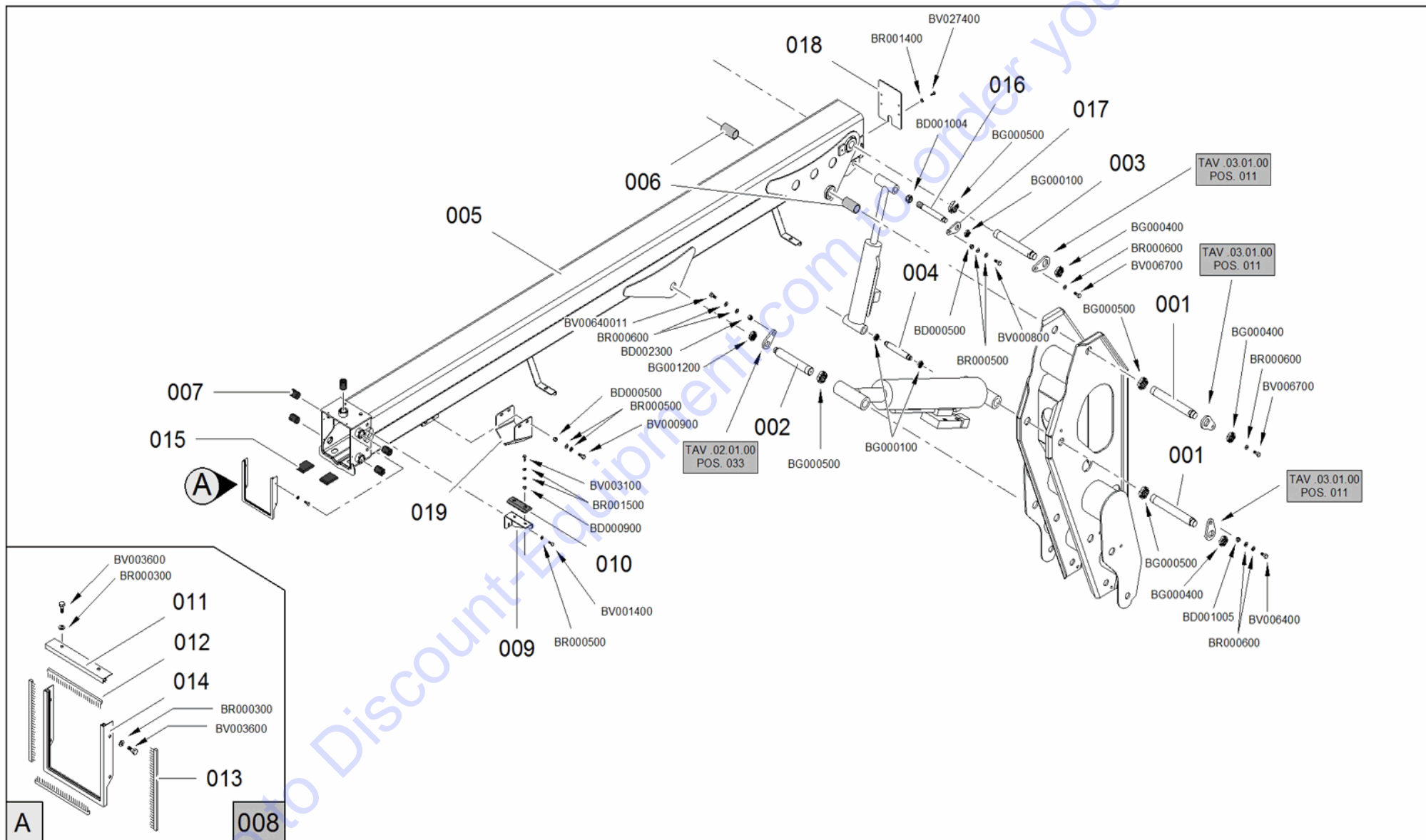

THIRD ARM

TERCERO BRAZO

TIERS BRAS







 TERZO BRACCIO
THIRD AUSLEGERARM 
 THIRD ARM
TERCERO BRAZO 
 TIERS BRAS

| POS Codice | Q.tà |  Descrizione |  Description |  Designation |  Benennung |  Descripcìon |
|-------------|------|---|---|---|---|---|
| 1 07094900 | 2 NR | SPINA | PIN | CHEVILLE | STIF | CLAVIJA |
| 2 06561000 | 1 NR | SPINA | PIN | CHEVILLE | STIF | CLAVIJA |
| 3 07102500 | 1 NR | SPINA | PIN | CHEVILLE | STIF | CLAVIJA |
| 4 06867600 | 1 NR | SPINA | PIN | CHEVILLE | STIFT | CLAVIJA |
| 5 177366J1 | 1 NR | TERZO BRACCIO LL1570 COMPLETO | THIRD BOOM COMPLETE LL1570 | TROISIÈME BRAS | DRITTER ARM | TERCERO BRAZO |
| 6 07765200 | 2 NR | BOCCOLA DEVA.TEX552 303530 | BUSH DEVA.TEX 552 303530 | DOUILLE | BUCHSE | CASQUILLO |
| 7 06958600 | 5 NR | PATTINO | SLIDE BLOCK | PATIN | GLEITBLOCK | PATÍN |
| 8 17767600 | 1 NR | KIT SPAZZOLE TERZO BRACCIO LL2010 | BRUSHES KIT | KIT BROSSES | BÜRSTENSATZ | KIT CEPILLOS |
| 9 068663H3 | 1 NR | SUPPORTO | SUPPORT | SUPPORT | HALTERUNG | SOPORTE |
| 10 06867100 | 1 NR | PATTINO | SLIDE BLOCK | PATIN | GLEITBLOCK | PATÍN |
| 11 07101600 | 1 NR | PROFILO SPAZZOLE SUPERIORE | PROFILE BRUSH TOP | CHÂSSIS | RAHMEN | BASTIDOR |
| 12 07102000 | 2 NR | SPAZZOLA ORRIZONTALE | HORIZONTAL BRUSH | BROSSE HORIZONTAL | WAAGRECHTE BÜRSTE | CEPILLO HORIZONTAL |

 TERZO BRACCIO

 THIRD AUSLEGERARM 
 THIRD ARM

 TERCERO BRAZO 
 TIERS BRAS

| POS Codice | Q.tà |  Descrizione |  Description |  Designation |  Benennung |  Descripción |
|-------------|------|---|---|---|---|---|
| 13 07102100 | 2 NR | SPAZZOLA VERTICALE | VERTICAL BRUSH | BROSSE VERTICALE | SENKRECHTE BÜRSTE | CEPILLO VERTICAL |
| 14 07754300 | 1 NR | PIEGATO FISSAGGIO SPAZZOLE | BENT FITTING BRUSHES | SUPPORT | HALTERUNG | SOPORTE |
| 15 07754200 | 2 NR | PATTINO APPOGGIO SFILO SU TERZO BRACCIO LL1570 | SKID SUPPORT EXTENSION ON THIRD BOOM LL1570 | PATIN | GLEITSCHUH | PATÍN |
| 16 06230600 | 1 NR | SPINA | PIN | CHEVILLE | STIFT | CLAVIJA |
| 17 064965Y1 | 9 NR | GOCCIA SPINA | PIN DROP | BASSE CHEVILLE | TROPFEN | CAÍDA CLAVIJA |
| 18 077536H3 | 1 NR | CARTER POSTERIORE TERZO BRACCIO | CARTER BACK THIRD BOOM | CARTER | KURBELGEHÄUS E | CÁRTER |
| 19 077380H3 | 1 NR | PIEGATO CENTRAGGIO TERZO BRACCIO LL1570 | BENDED CENTRING THIRD BOOM LL1570 | SUPPORT | HALTERUNG | SOPORTE |

 CATENA PORTACAVI FLESSIBILE

SCHLAUCH SCHLEPPKETTE 

 FLEXIBLE CABLE-HOLDER CHAIN

CADENA PORTACABLES FLEXIBLE 

 CHAINE PORTE-CABLES FLEXIBLE

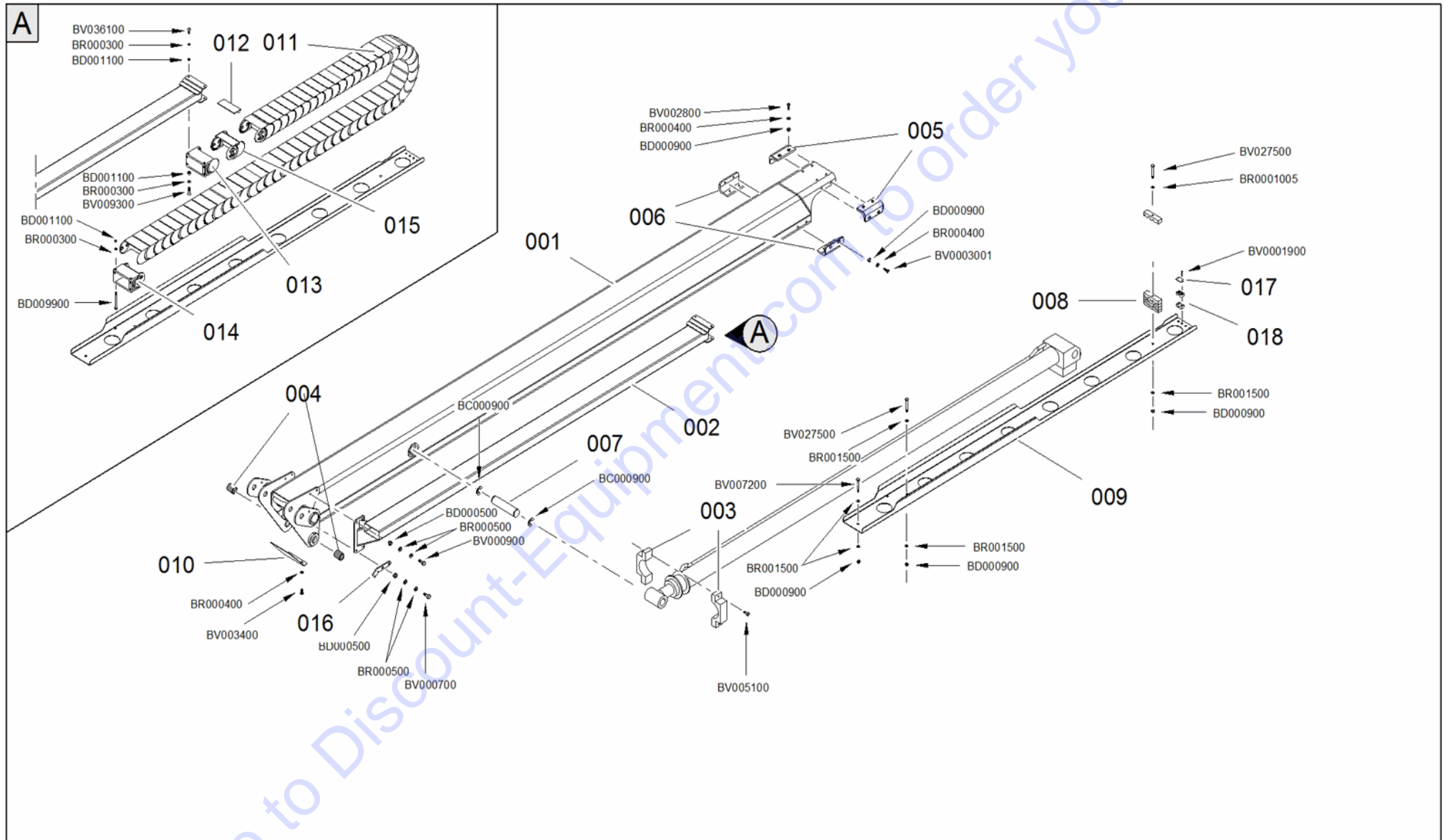





 CATENA PORTACAVI FLESSIBILE

 SCHLAUCH SCHLEPPKETTE

 FLEXIBLE CABLE-HOLDER CHAIN

 CADENA PORTACABLES FLEXIBLE

 CHAINE PORTE-CABLES FLEXIBLE

| POS Codice | Q.tà |  Descrizione |  Description |  Designation |  Benennung |  Descripción |
|------------|------|---|---|---|---|---|
| 1 177104J2 | 1 NR | BRACCIO SFILO LL1570 COMPLETO | COMPLETE BOOM EXTENSION | BRAS D'EXTENSION | ARMVERLÄNGER UNG | BRAZO DE EXTENCIÓN |
| 2 377362H3 | 1 NR | ASSIEME SUPPORTO CATENARIA SFILO LL1570 SALDATO | ASSEMBLY SUPPORT CONTACT LINE EXTENSION LL1570 WELDED | SUPPORT | HALTERUNG | SOPORTE |
| 3 07767500 | 1 NR | PATTINO GUIDA CILINDRO SFILO LL1570 | SKID GUIDE CYLINDER EXTENSION LL1570 | PATIN | GLEITSCHUH | PATÍN |
| 4 07765800 | 2 NR | BOCCOLA DEVA.TEX552 202815 | BUSH DEVA.TEX 552 202815 | DOUILLE | BUCHSE | CASQUILLO |
| 5 07178200 | 2 NR | PATTINO | SLIDE BLOCK | PATIN | GLEITBLOCK | PATÍN |
| 6 07711300 | 2 NR | PATTINO | SLIDE BLOCK | PATIN | GLEITBLOCK | PATÍN |
| 7 06853800 | 1 NR | SPINA | PIN | CHEVILLE | STIF | CLAVIJA |
| 8 07530500 | 3 NR | MORSETTO FERMA TUBI | CLAMP | ÉTAU | KLEMMME | ABRAZADERA |
| 9 077534H3 | 1 NR | PIEGATO SUPPORTO CATENARIA SFILO LL1570 | BENDED WIRE SUPPORT CATENARY LL1570 | SUPPORT | HALTERUNG | SOPORTE |





 CATENA PORTACAVI FLESSIBILE

SCHLAUCH SCHLEPPKETTE 

 FLEXIBLE CABLE-HOLDER CHAIN

CADENA PORTACABLES FLEXIBLE 

 CHAÎNE PORTE-CABLES FLEXIBLE

| POS Codice | Q.tà |  Descrizione |  Description |  Designation |  Benennung |  Descripcìon |
|---------------|------|---|---|---|---|---|
| 10 071314H3 | 1 NR | COPERCHIO ANTERIORE SFILO | FRONT COVER EXTENSION | COUVERCLE | DECKEL | TAPA |
| 11 27766400 | 1 NR | CATENA PORTACAVI | CABLE-HOLDER CHAIN | CHAÎNE PORTE-CÂBLES | KABELHALTERKETTE | CADENA PORTACABLES |
| 12 2595050004 | 1 NR | COPERCHIO | COVER | COUVERCLE | DECKEL | TAPA |
| 13 2595050001 | 1 NR | MAGLIA CATENA ATTACCO FEMMINA | CHAIN LINK FEMALE CONNECTION | MAILLOT CHAÎNE | KETTENGLIED | ESLABÓN CADENA |
| 14 2595050002 | 1 NR | MAGLIA CATENA ATTACCO MASCHIO | CHAIN LINK MALE CONNECTION | MAILLOT CHAÎNE | KETTENGLIED | ESLABÓN CADENA |
| 15 2595050003 | 1 NR | MAGLIA CATENA | CHAIN LINK | MAILLOT CHAÎNE | KETTENGLIED | ESLABÓN CADENA |
| 16 072263H3 | 1 NR | STAFFA | BRACKET | ÉTRIER | HALTEBÜGEL | ESTRIBO |
| 17 04096600 | 2 NR | PIASTRA | CLAMP | BRIDE | KLEMME | PLACA |
| 18 04096800 | 4 NR | MORSETTO | CLAMP | BRIDE | KLEMME | BORNE |

🇮🇹 SUPPORTO CESTO

HALTERUNG ARBEITSKORB 🇩🇪

🇬🇧 BASKET SUPPORT

SOPORTE CESTA 🇪🇸



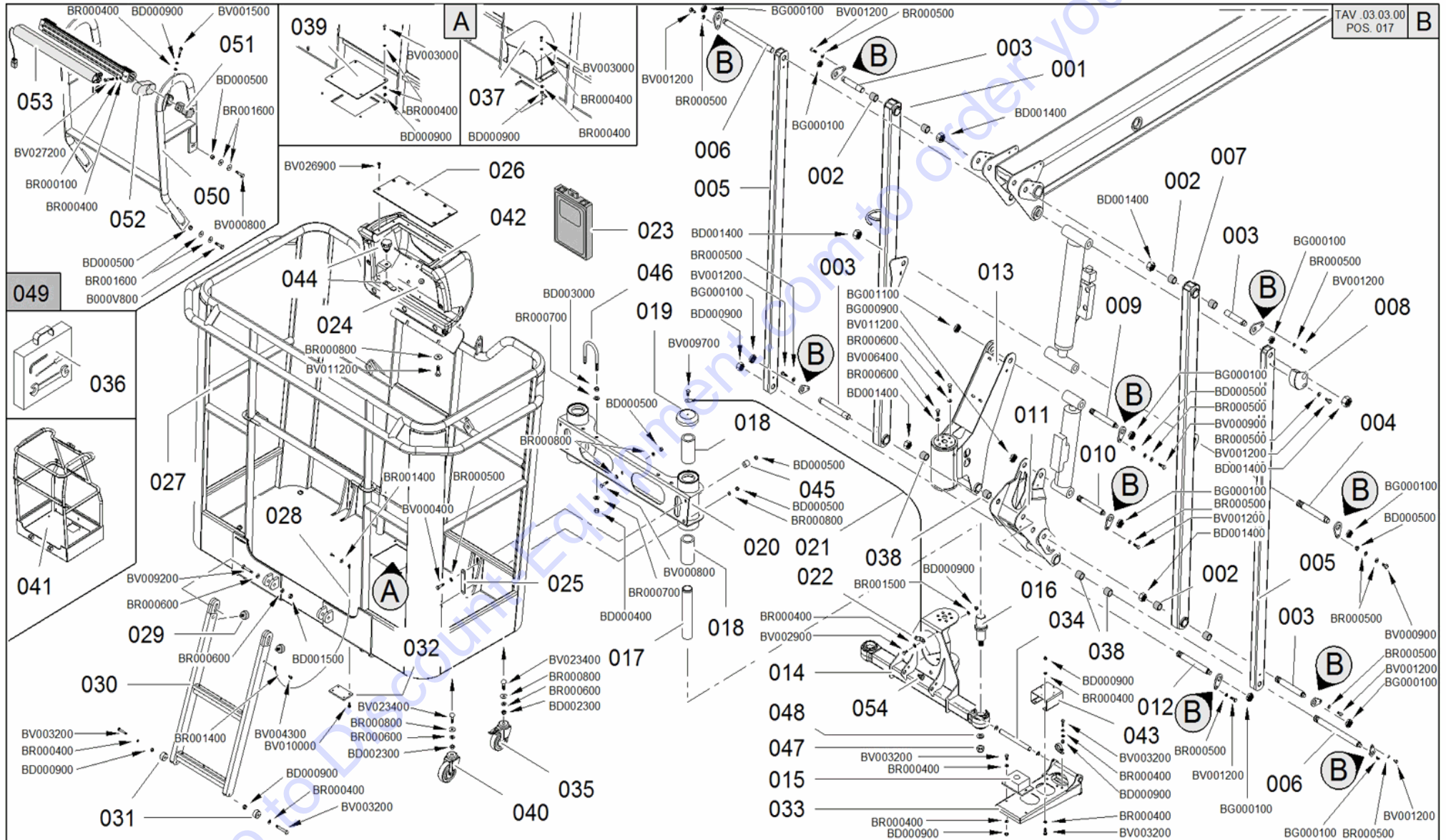

🇫🇷 PANIER CUPPORT



 SUPPORTO CESTO

 HALTERUNG ARBEITSKORB 
 BASKET SUPPORT





 SOPORTE CESTA 
 PANIER CUPPORT

| POS Codice | Q.tà |  Descrizione |  Description |  Designation |  Benennung |  Descripción |
|-------------|------|---|---|---|---|---|
| 1 177718J2 | 1 NR | ASSIEME BRACCIO JIB DESTRO COMPLETO | ASSEMBLY BOOM JIB RIGHT COMPLETE | BRAS JIB DROIT | RECHTER JIB ARM | BRAZO JIB DERECHO |
| 2 07765600 | 4 NR | BOCCOLA DEVA.TEX552 202820 | BUSH DEVA.TEX 552 202820 | DOUILLE | BUCHSE | CASQUILLO |
| 3 07093500 | 4 NR | SPINA | PIN | CHEVILLE | STIFT | CLAVIJA |
| 4 07093800 | 1 NR | SPINA | PIN | CHEVILLE | STIFT | CLAVIJA |
| 5 359447J2 | 2 NR | TIRANTE JIB | TIE ROD JIB | TIRANT | ZUGSTANGE | TIRANTE |
| 6 07093600 | 2 NR | SPINA | PIN | CHEVILLE | STIFT | CLAVIJA |
| 7 177719J2 | 1 NR | ASSIEME BRACCIO JIB SINISTRO COMPLETO | ASSEMBLY BOOM JIB LEFT COMPLETE | BRAS JIB GAUCHE | LINKER JIB ARM | BRAZO JIB IZQUIERDO |
| 8 377713H3 | 1 NR | CAMMA MICRO JIB | MICROSWITCH CAM JIB | CAME | NOCKEN | LEVA |
| 9 07093700 | 1 NR | SPINA | PIN | CHEVILLE | STIFT | CLAVIJA |
| 10 06235600 | 1 NR | SPINA | PIN | CHEVILLE | STIFT | CLAVIJA |
| 11 175401J2 | 1 NR | RINVIO JIB | JIB CONNECTION ROD | RENOI | VORGELEGE | REENVIO |
| 12 06235700 | 1 NR | SPINA | PIN | CHEVILLE | STIFT | CLAVIJA |

 SUPPORTO CESTO

 HALTERUNG ARBEITSKORB 
 BASKET SUPPORT





 SOPORTE CESTA 
 PANIER CUPPORT

| POS Codice | Q.tà |  Descrizione |  Description |  Designation |  Benennung |  Descripción |
|---------------|------|---|---|---|---|---|
| 13 2648910002 | 1 NR | KIT GUARNIZIONI | SEAL KIT | KIT DE JOINTS | DICHTUNGSSATZ | KIT DE JUNTAS |
| 13 271778H2 | 1 NR | MOTORE DI ROTAZIONE RAL7016 | ROTARY MOTOR RAL7016 | MOTEUR DE ROTATION RAL7016 | DREHANTRIEB RAL7016 | MOTOR ROTACIÓN RAL7016 |
| 14 377660H2 | 1 NR | SUPPORTO CESTO | BASKET SUPPORT | SUPPORT PANIER | KORBHALTERU NG | SOPORTE CESTA |
| 15 056187H3 | 1 NR | COPERCHIO | BOX | COUVERCLE | DECKEL | TAPA |
| 16 07190900 | 2 NR | VITE TE DIN960 CI 8.8 M16X1.5X115 FORATA GEOMET321 PLUS XL | TE SCREW DIN960 CI 8.8 M16X1.5X115 GEOMET321 PERFORATED PLUS XL | VIS TE DIN960 CI 8,8 M16X1.5X115 FORE PLUS GEOMET321 XL | TE SCHRAUBE DIN960 CI 8,8 M16X1.5X115 GEOMET321 PERFORATED PLUS XL | TE TORNILLO DIN960 CI 8,8 M16X1.5X115 GEOMET321 PERFORADA XL |
| 17 07146500 | 2 NR | PERNO SUPPORTO CESTO DIAM.50 | PIN SUPPORT BASKET Ø50 | AXE DIAM.50 PANIER DE SOUTIEN | BOLZEN KORBHALTERUN G | CLAVIJA CESTA |
| 18 27146200 | 4 NR | CUSCINETTO LINEARE A SFERE 50-100 | LINEAR BALL BEARING 50-100 | ROULEMENT LINEAIRE 50-100 | LINEAR-KUGELLA GER 50-100 | COJINETE DE BOLAS 50-100 |
| 19 07146400 | 2 NR | TAPPO CHIUSURA PERNI SUPPORTO CESTO DIAM.50 | CAP PINS BASKET SUPPORT Ø50 | BOUCHON | VERSCHLUSS | TAPÓN |

 SUPPORTO CESTO

 HALTERUNG ARBEITSKORB 
 BASKET SUPPORT





 SOPORTE CESTA 
 PANIER CUPPORT

| POS Codice | Q.tà |  Descrizione |  Description |  Designation |  Benennung |  Descripción |
|-------------|------|---|---|---|---|---|
| 20 371459H2 | 1 NR | SLITTA FISSAGGIO CESTO PERNI DIAM.50 | SLIDE BASKET MOUNTING BOLTS Ø50 | COULISSEAU | SCHLITTEN | CORREDERA |
| 21 06665000 | 2 NR | FUNE | CABLE | CÂBLE | SEIL | CABLE |
| 22 07052900 | 1 NR | STAFFA | BRACKET | ÉTRIER | HALTEBÜGEL | ESTRIBO |
| 23 05643600 | 1 NR | CASSETTA PORTAMANUALE | MANUAL BOX | BOÎTE PORTE-MANUEL | BEDIENUNGSANL EITUNGSFACH | CAJA PORTAMANUAL |
| 24 06477600 | 1 NR | MAGNETE Ø20 CON FORO M3 | MAGNETO Ø20 WITH M3 HOLE | AIMANT | MAGNET | IMÁN |
| 25 072398H3 | 2 NR | PIASTRA FISSAGGIO CESTO (SOLO MACCHINE MODELLO JP E JA E X17J) | FIXING PLATE BASKET (ONLY MACHINES MODEL JP AND JA AND X17J) | PLATE FIXATION DRUM | PLATE BEFESTIGUNG DRUM | PLACA FIJACIÓN TAMBOR |
| 26 07690700 | 1 NR | PROTEZIONE TRASPARENTE | PROTECTION | PROTECTION | SCHUTZ | PROTECCIÓN |
| 27 27589300 | 1 NR | CESTO BIPOSTO 230KG PER MK2 (DA C170000893) | BASKET 2 PERSON 230KG FOR MK2 (FROM C170000893) | PANIER 2 PERSONNES FOR MK2 (FROM C170000893) | 2 MANN-ARBEITSK ORB FOR MK2 (FROM C170000893) | CESTA 2 PERSONAS FOR MK2 (FROM C170000893) |
| 28 06598500 | 1 NR | FUNE | CABLE | CÂBLE | SEIL | CABLE |

 SUPPORTO CESTO

 HALTERUNG ARBEITSKORB 
 BASKET SUPPORT





 SOPORTE CESTA 
 PANIER CUPPORT

| POS Codice | Q.tà |  Descrizione |  Description |  Designation |  Benennung |  Descripcìon |
|-------------|------|---|---|---|---|---|
| 29 05475900 | 2 NR | ANTIVIBRANTE | ANTI-VIBRATING | ANTI - VIBRANT | VIBRATIONSDÄM PFER | ANTIVIBRANTE |
| 30 36585800 | 1 NR | SCALETTA | LADDER | ÉCHELLE REPLIABLE | LEITER | ESCALERA PLEGABLE |
| 31 06585900 | 2 NR | ROTELLINA | SMALL ROLLER | ROULETTE | RÄDCHEN | RUEDECILLA |
| 32 058600H3 | 1 NR | PIASTRA | PLATE | PLAQUE | PLATTE | PLACA |
| 33 377661H2 | 1 NR | MENSOLA SUPPORTO CELLA DI CARICO | BRACKET SUPPORT LOAD CELL | BRIDE SUPPORT CELLULE DE CHARGE | STEIGBÜGELHAL TERUNG FÜRLASTÜBERW ACHUNGSZELLE | BRIDA SOPORTE CELULA DE CARGA |
| 34 07766500 | 1 NR | PERNO INCERNIERAMEN TO MENSOLA SUPPORTO CESTO | PIN HINGE BRACKET SUPPORT BASKET | AXE | STIFT | PERNIO |
| 35 07751100 | 2 NR | RUOTE INFERIORI PER CESTO CON FRENO | LOWER WHEELS FOR BASKET WITH BRAKE | ROUES POUR PANIER | KORBRÄDER | RUEDAS |
| 37 06418600 | 1 NR | PROTEZIONE | PROTECTION | PROTECTION | SCHUTZ | PROTECCIÓN |
| 38 06272700 | 2 NR | BOCCOLA | BUSH | DOUILLE | BUCHSE | CASQUILLO |
| 40 07687300 | 2 NR | RUOTE INFERIORI PER CESTO | LOWER WHEEL | ROULEAU INFERIEUR | UNTERES RAD | RUEDA INFERIOR |

 SUPPORTO CESTO

 HALTERUNG ARBEITSKORB 
 BASKET SUPPORT





 SOPORTE CESTA 
 PANIER CUPPORT

| POS Codice | Q.tà |  Descrizione |  Description |  Designation |  Benennung |  Descripción |
|-------------|------|---|---|---|---|---|
| 42 17569900 | 1 NR | PROTEZIONE TELECOMANDO | PROTECTION REMOTE CONTROL | PROTECTION | SCHUTZ | PROTECCIÓN |
| 43 072404H3 | 1 NR | SUPPORTO PEDALE | PEDAL SUPPORT PLATE | TÔLE PLIÉE | HALTERUNG | SOPORTE |
| 44 07192700 | 1 NR | CHIUSURA A VOLANTINO CON LEVA PIEGATA (SOLO MACCHINE MODELLO JP E JA E X17J) | LOCKING WHEEL WITH BENT LEVER (ONLY MACHINES MODEL JP AND JA AND X17J) | POIGNEE DE BLOCAGE | KUGELVERSCHLUSS | POMO DE BLOQUEO |
| 45 07239700 | 2 NR | DISTANZIALE PER VITI M8 SUPPORTO CESTO (SOLO MACCHINE MODELLO JP E JA E X17J) | SPACER SCREW M8 SUPPORT BASKET (ONLY MACHINES MODEL JP AND JA AND X17J) | ENTRETOISE | DISTANZSTÜCK | DISTANCIADOR |
| 46 07031800 | 2 NR | TUBO | PIPE | TUYAU | ROHR | TUBO |
| 47 07193000 | 2 NR | DADO AD INTAGLI UNI5593 CI 8 M16X1.5 GEOMET321 PLUS XL | NUT M16X1.5 NOTCHES UNI5593 CI 8 GEOMET321 PLUS XL | ÉCROU UNI5593 CI 8 M16X1.5 GEOMET321 PLUS XL | MUTTER UNI5593 CI 8 M16X1.5 GEOMET321 PLUS XL | TUERCA UNI5593 CI 8 M16X1.5 GEOMET321 PLUS XL |

 SUPPORTO CESTO

 HALTERUNG ARBEITSKORB 
 BASKET SUPPORT

 SOPORTE CESTA 
 PANIER CUPPORT

| POS Codice | Q.tà |  Descrizione |  Description |  Designation |  Benennung |  Descripción |
|-------------|------|---|---|---|---|---|
| 48 07192600 | 2 NR | RONDELLA SPECIALE HV 300 - D 17X48X6 GEOMET321/A+P LUS XL | SPECIAL WASHER HV 300 - 17X48X6 GEOMET321 D / A + PLUS XL | RONDELLE SPECIALE HV 300 - 17X48X6 GEOMET321 D / A + PLUS XL | SCHEIBE HV 300 - 17X48X6 GEOMET321 D / A + PLUS XL | ARANDELA ESPECIAL HV 300 - 17X48X6 GEOMET321 D / A + PLUS XL |
| 49 17768100 | 1 NR | KIT SKY GUARD COMPLETO BIPOSTO PER CCBS | SKYGUARD COMPLETE KIT FOR 2 PERSON CCBS | KIT SKY GUARD | SKY GUARD SATZ | KIT SKY GUARD |
| 50 37609800 | 1 NR | TELAIO SUPPORTO SKY-GUARD CESTO BIPOSTO | SKY-FRAME SUPPORT GUARD BASKET 2PERSON | CHÂSSIS | RAHMEN | CHASIS |
| 51 07796900 | 2 NR | BLOCCHETTO PLASTICA PER FISSAGGIO SKYGUARD (1001188889) | BLOCK PLASTIC FOR SECURING SKYGUARD (1001188889) | BLOC | BLOCK | BLOQUE |
| 52 07797000 | 2 NR | COVER IN GOMMA PER PROTEZIONE FISSAGGIO SKY GUARD (1001186517) | COVER RUBBER PROTECTION FOR FIXING SKY GUARD (1001186517) | PROTECTION | SCHUTZ | PROTECCIÓN |
| 53 27796800 | 1 NR | SENSORE SKYGUARD | SENSOR SKYGUARD | CAPTEUR | SENSOR | SENSOR |

 SUPPORTO CESTOHALTERUNG ARBEITSKORB  BASKET SUPPORTSOPORTE CESTA  PANIER CUPPORT

| POS Codice | Q.tà |  Descrizione |  Description |  Designation |  Benennung |  Descripcìon |
|-------------|------|---|---|---|---|---|
| 54 07771500 | 1 | NR MANIGLIA | HANDLE | POIGNÉE | GRIFF | MANIJA |

Go to Discount-Equipment.com to order your parts

 ACCOPPIAMENTO MOTORE DIESEL- POMPA

 DIESEL ENGINE COUPLING - PUMP

 ACCOUPLEMENT MOTEUR DIESEL - POMPE

PUMPEN / DIESELMOTOR KUPPLUNG 

ACOPLAMIENTO MOTOR DIESEL- BOMBA 

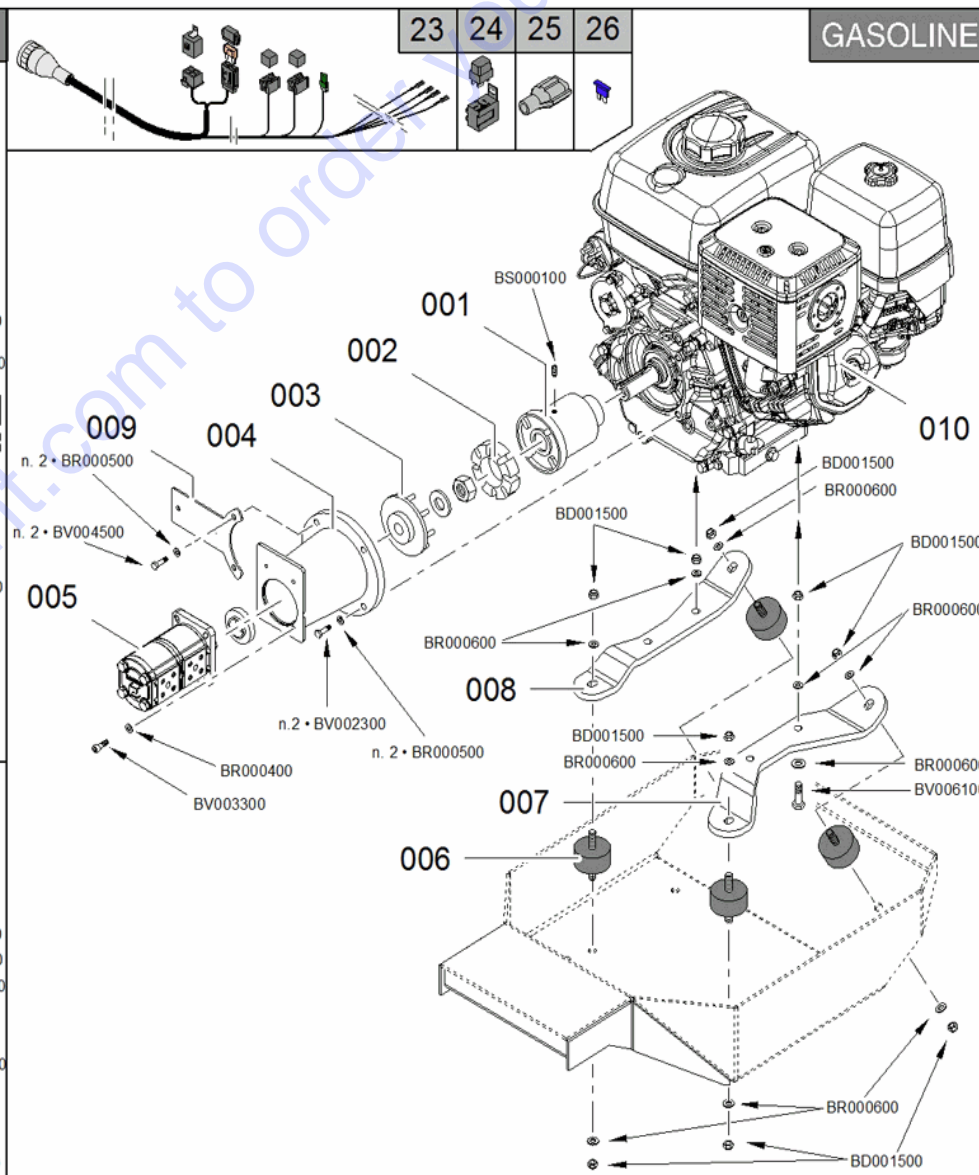
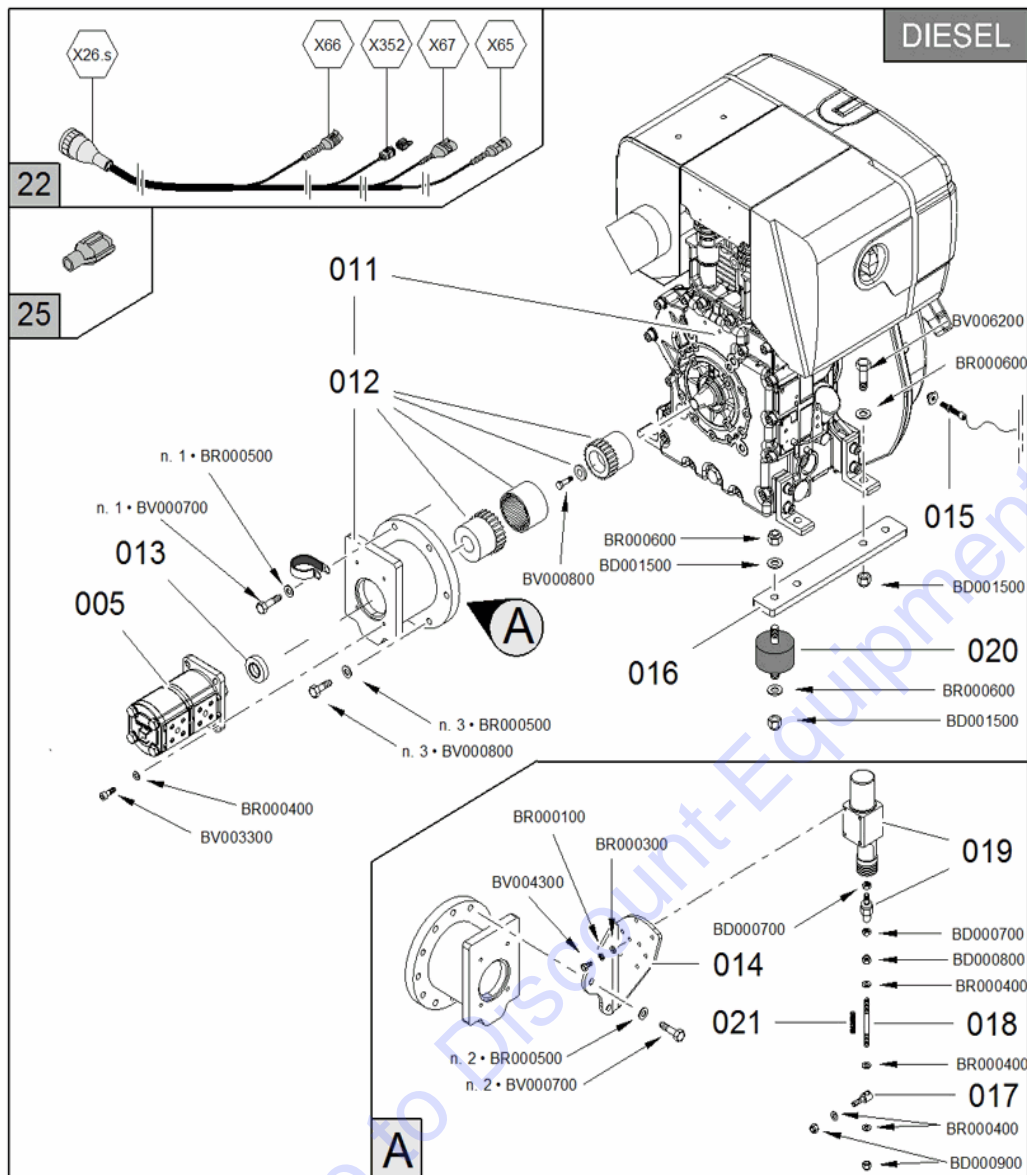





 ACCOPPIAMENTO MOTORE DIESEL- POMPA

PUMPEN / DIESELMOTOR KUPPLUNG 

 DIESEL ENGINE COUPLING - PUMP

ACOPLAMIENTO MOTOR DIESEL- BOMBA 

 ACCOUPLEMENT MOTEUR DIESEL - POMPE

| POS Codice | Q.tà |  Descrizione |  Description |  Designation |  Benennung |  Descripción |
|------------|------|---|---|---|---|---|
| 1 04310200 | 1 NR | SEMIGIUNTO | HALF COUPLING | DEMI-JOINT | HALBVERBINDUNG G | SEMI-ACOPLAMIE NTO |
| 2 04310100 | 1 NR | INSERTO IN GOMMA | RUBBER INSERT | INSERT EN CAOUTCHOUC | GUMMIEINSATZ | INSERTO DE GOMA |
| 3 04615300 | 1 NR | GIUNTO | COUPLING | JOINT | VERBINDUNG | ACOPLAMIENTO |
| 4 04310300 | 1 NR | LANTERNA | LANTERN | LANTERNE | BUCHSE | LINTERNA |
| 6 07804100 | 4 NR | ANTIVIBRANTE VERSIONE BENZINA | ANTI-VIBRATING GASOLINE VERSION | ANTI - VIBRANT | VIBRATIONSDÄM PFER | ANTIVIBRANTE |
| 7 077494Y1 | 1 NR | PIATTO SINISTRO SUPPORTO MOTORE HONDA LL1570 | LEFT PLATE SUPPORT HONDA MOTOR LL1570 | PLAQUE GAUCHE SUPPORT MOTEUR | LINKE PLATTE MOTORHALTERU NG | PLACA IZQUIERDA SOPORTE MOTOR |
| 8 077493Y1 | 1 NR | PIATTO DESTRO SUPPORTO MOTORE HONDA LL1570 | RIGHT PLATE SUPPORT HONDA MOTOR LL1570 | PLAQUE DROITE SUPPORT MOTEUR | RECHTE PLATTE MOTORHALTERU NG | PLACA DERECHA SOPORTE MOTOR |
| 9 061177H2 | 1 NR | STAFFA | BRACKET | ÉTRIER | HALTEBÜGEL | ESTRIBO |





 ACCOPPIAMENTO MOTORE DIESEL- POMPA

PUMPEN / DIESELMOTOR KUPPLUNG 

 DIESEL ENGINE COUPLING - PUMP

ACOPLAMIENTO MOTOR DIESEL- BOMBA 

 ACCOUPLEMENT MOTEUR DIESEL - POMPE

| POS Codice | Q.tà |  Descrizione |  Description |  Designation |  Benennung |  Descripción |
|-------------|------|---|---|---|---|---|
| 10 27775900 | 1 NR | MOTORE HONDA IGX390 MODIFICATO SENZA BLOCCHETTO CHIAVE DI ACCENSIONE MK2 (DA C170000893) | HONDA MOTOR IGX390 MODIFIED WITHOUT IGNITION SWITCH MK2 (FROM C170000893) | MOTEUR HONDA IGX390 | HONDA MOTOR IGX390 | MOTOR HONDA IGX390 |
| 11 27110400 | 1 NR | MOTORE DIESEL HATZ 10HP VERSIONE CON PREDISPOSIZION E REGOLAZIONI GIRI ELETTRONICA (NO CARB-EPA CERT) | HATZ DIESEL ENGINE 10HP VERSION WITH PREDISPOSITION TO ELECTRONIC SPEED REGULATION (NO CARB-EPA CERT) | MOTEUR DIESEL | DIESELMOTOR | MOTOR DIESEL |
| 11 27676900 | 1 NR | MOTORE DIESEL HATZ 1B40 RPM SENZA CHIAVE+ACCOP PIAMENTO (TIER3 SOLO VERS. EU, NO CARB-EPA CERT) MK2 (DA C170000893) | DIESEL ENGINE HATZ 1B40 RPM WITHOUT KEY + COUPLING (TIER3 ONLY VERS. EU, NON-EPA CARB CERT) MK2 (FROM C170000893) | MOTEUR DIESEL HATZ | HATZ DIESEL MOTOR | MOTOR DIESEL HATZ |





 ACCOPPIAMENTO MOTORE DIESEL- POMPA

PUMPEN / DIESELMOTOR KUPPLUNG 

 DIESEL ENGINE COUPLING - PUMP

ACOPLAMIENTO MOTOR DIESEL- BOMBA 

 ACCOUPLEMENT MOTEUR DIESEL - POMPE

| POS Codice | Q.tà |  Descrizione |  Description |  Designation |  Benennung |  Descripción |
|---------------|------|---|---|---|---|---|
| 12 2558630001 | 1 NR | ACCOPPIAMENT O MOTORE - POMPA | ENGINE COUPLING - PUMP | ACCOUPLEMENT MOTEUR - POMPE | PUMPEN-/MOTOR KUPPLUNG | ACOPLAMIENTO MOTOR - BOMBA |
| 13 05559100 | 1 NR | DISTANZIALE | SPACER | ENTRETOISE | DISTANZSTÜCK | DISTANCIADOR |
| 14 070989H2 | 1 NR | STAFFA | BRACKET | ÉTRIER | HALTEBÜGEL | HALTEBÜGEL |
| 15 26514900 | 1 NR | SENSORE | SENSOR | CAPTEUR | SENSOR | SENSOR |
| 16 057900Y1 | 2 NR | PIATTO | PLATE | PLATEAU | PLATTE | PLACA |
| 17 070986Y2 | 1 NR | PERNO | PIN | GOUJON | ZAPFEN | PERNIO |
| 18 07098700 | 1 NR | TIRANTE | TIE ROD | TIRANT | TURMGESTÄNGE | TIRANTE |
| 19 26551500 | 1 NR | PISTONE | PISTON | PISTON | KOLBEN | PISTÓN |
| 20 07804200 | 4 NR | ANTIVIBRANTE VERSIONE BENZINA | ANTI-VIBRATING GASOLINE VERSION | ANTI - VIBRANT | VIBRATIONSDÄM PFER | ANTIVIBRANTE |
| 21 07098800 | 1 NR | MOLLA | SPRING | RESSORT | FEDER | MUELLE |
| 22 17729700 | 1 NR | KIT ELE INTEGRAZIONE MOTORE DIESEL 10HP LL1570-X15JP-X4 30AJ | INTEGRATION KIT ELE DIESEL 10HP LL1570-X15JP-X4 30AJ | KIT ELECTRIQUE INTEGRATION | ELEKTRISCHE ERGÄNZUNGSAT Z | KIT INTEGRACIÓN ELÉCTRICA |





 ACCOPPIAMENTO MOTORE DIESEL- POMPA

PUMPEN / DIESELMOTOR KUPPLUNG 

 DIESEL ENGINE COUPLING - PUMP

ACOPLAMIENTO MOTOR DIESEL- BOMBA 

 ACCOUPLEMENT MOTEUR DIESEL - POMPE

| POS Codice | Q.tà |  Descrizione |  Description |  Designation |  Benennung |  Descripcìon |
|---------------|------|---|---|---|---|---|
| 23 17729600 | 1 NR | KIT ELE INTEGRAZIONE MOTORE BENZINA 13I LL1570 | INTEGRATION KIT ELE MOTOR GASOLINE 13 THE LL1570 | KIT ÉLECTRIQUE | ELEKTROSATZ | KIT ELÉCTRICO |
| 24 1776330003 | 1 NR | RELE' MINI TYCO 12V PER CONNETTORE A TENUTA (MK2 DA C170000893) | RELAY 'MINI 12V TYCO CONNECTOR SEAL (MK2 FROM C170000893) | RELAIS | RELAIS | RELÉ |
| 24 1776330004 | 1 NR | PORTA RELE' A TENUTA PER MINI TYCO 12V (MK2 DA C170000893) | HOLDER RELAY SEAL FOR MINI 12V TYCO (MK2 FROM C170000893) | PORTE RELAIS | RELAISHALTER | PORTARELÉ |
| 24 1776330005 | 1 NR | GOMMINO PER RELE' A TENUTA MINI TYCO 12V (MK2 DA C170000893) | RUBBER FOR RELAY SEAL MINI 12V TYCO (MK2 FROM C170000893) | JOINT RELÉ | GUMMIDICHTUNG | JUNTA DE GOMA |
| 24 1776330007 | 1 NR | PUNTALINI PER RELE' A TENUTA MINI TYCO 12V (MK2 DA C170000893) | FERRULE FOR RELAY SEAL MINI 12V TYCO (MK2 FROM C170000893) | BORNE | KLEMME | BORNE |





 ACCOPPIAMENTO MOTORE DIESEL- POMPA

PUMPEN / DIESELMOTOR KUPPLUNG 

 DIESEL ENGINE COUPLING - PUMP

ACOPLAMIENTO MOTOR DIESEL- BOMBA 

 ACCOUPLEMENT MOTEUR DIESEL - POMPE

| POS Codice | Q.tà |  Descrizione |  Description |  Designation |  Benennung |  Descripcìon |
|---------------|------|---|---|---|---|---|
| 25 1757250022 | 1 NR | TAPPO CONNETTORE YAZAKI 2 VIE CON DIODO 1.5A | PLUG | BOUCHON | DECKEL | TAPA |
| 26 1739150057 | 1 NR | FUSIBILE A LAMA DA 30A | FUSE BLADE 30A | FUSIBLE À LAME 30A | 30 A SICHERUNG | FUSIBILE A LAMA 30A |
| 27 07819000 | 1 NR | PARATIA PROTEZIONE CARBURATORE | PLATE PROTECTION CARB | PLAQUE PROTECTION | SCHUTZPLATTE | PLACE PROTECCIÓN |

Go to Discount-Equipment.com to order your parts

 RICAMBI MOTORE

 ENGINE SPARE PARTS

 PIÈCES DÉTACHÉES DU MOTEUR

MOTORERSATZTEILE 

REPUESTOS MOTOR 

GASOLINE HONDA iGX390

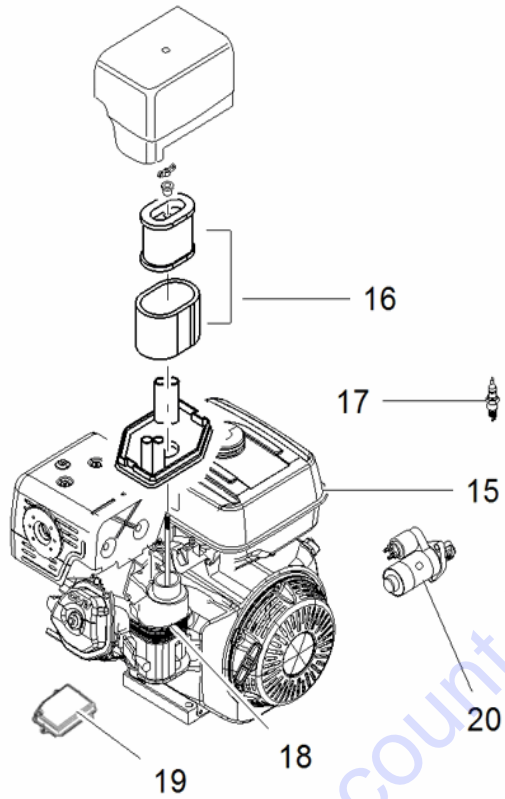

DIESEL HATZ 1B40

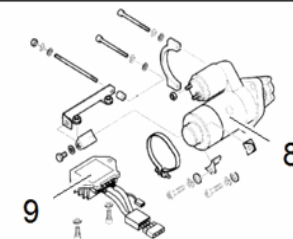
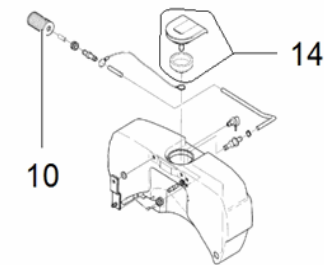
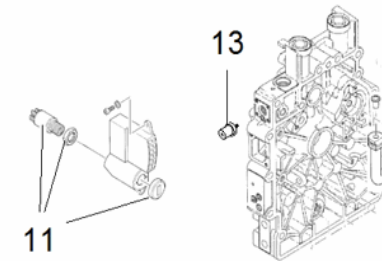
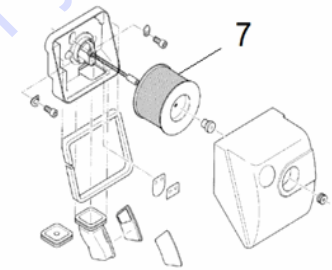

Go to Discount-Equipment.com to order your parts





 RICAMBI MOTORE

 MOTORERSATZTEILE

 ENGINE SPARE PARTS

 REPUESTOS MOTOR

 PIÈCES DÉTACHÉES DU MOTEUR

| POS Codice | Q.tà |  Descrizione |  Description |  Designation |  Benennung |  Descripción |
|---------------|------|---|---|---|---|---|
| 7 2625560002 | 1 NR | FILTRO ARIA | AIR FILTER | FILTER À AIR | LUFTFILTER | FILTRO AIRE |
| 8 2558630004 | 1 NR | MOTORINO AVVIAMENTO | STARTER MOTOR | DÉMARREUR | ANLASSER | MOTOR DE ARRANQUE |
| 9 2558630005 | 1 NR | REGOLATORE DI TENSIONE | VOLTAGE REGULATOR | RÉGULATEUR DE TENSION | SPANNUNGSREG LER | REGULADOR DE TENSIÓN |
| 9 2558630009 | 1 NR | REGOLATORE DI CORRENTE HATZ MODELLO DUCATI | CURRENT REGULATOR HATZ DUCATI MODEL | RÉGULATEUR DE TENSION MOTEUR HATZ | HYDRAULISCHER ANTRIEB | COMANDO HIDRÁULICO |
| 10 2558630003 | 1 NR | FILTRO GASOLIO | GAS OIL FILTER | FILTRE À GASOIL | KRAFTSTOFFFIL TER | FILTRO GASÓLEO |
| 11 2631430001 | 1 NR | BLOCCHETTO CHIAVE | BLOCK | BLOC | BLOCK | BLOQUE |
| 13 2558630008 | 1 NR | SOLENOIDE | SOLENOID | SOLENOÏDE | SOLENOID | SOLENOIDE |
| 14 2631430004 | 1 NR | TAPPO SERBATOIO GASOLIO | FUEL TANK CAP | BOUCHON RÉSERVOIR GASOIL HATZ 1B30-1B40 | TANKDECKEL | TAPA DEPÓSITO GASOIL |
| 15 2775200002 | 1 NR | SERBATOIO BENZINA COMPLETO HONDA IGX390 | FUEL TANK COMPLETE HONDA IGX390 | RÉSERVOIR ESSENCE | BENZINTANK | DEPÓSITO DE GASOLINA |

PARTS FINDER

**Search Website
by Part Number**



**Search Manual
Library For Parts
Manual & Lookup Part
Numbers – Purchase
or Request Quote**

Search Manuals

Enter your information to help us find the right parts manual for your machine.

* Brand:

* Model:

* Serial:

* Part Number:

SEARCH

**Can't Find Part or
Manual? Request Help
by Manufacturer,
Model & Description**

Parts Order Form

Please fill in the following information to help us find the right part for your machine.

| | |
|---------------|----------------------|
| Manufacturer: | <input type="text"/> |
| Model: | <input type="text"/> |
| Description: | <input type="text"/> |
| Part Number: | <input type="text"/> |
| Quantity: | <input type="text"/> |
| Notes: | <input type="text"/> |

Submit

Discount-Equipment.com is your online resource for quality parts & equipment.

Florida: **561-964-4949** Outside Florida TOLL FREE: **877-690-3101**

Need parts?

Click on this link: <http://www.discount-equipment.com/category/5443-parts/> and choose one of the options to help get the right parts and equipment you are looking for. Please have the machine model and serial number available in order to help us get you the correct parts. If you don't find the part on the website or on one of the online manuals, please fill out the request form and one of our experienced staff members will get back to you with a quote for the right part that your machine needs.

We sell worldwide for the brands: Genie, Terex, JLG, MultiQuip, Mikasa, Essick, Whiteman, Mayco, Toro Stone, Diamond Products, Generac Magnum, Airman, Haulotte, Barreto, Power Blanket, Nifty Lift, Atlas Copco, Chicago Pneumatic, Allmand, Miller Curber, Skyjack, Lull, Skytrak, Tsurumi, Husquvarna Target, Stow, Wacker, Sakai, Mi-T-M, Sullair, Basic, Dynapac, MBW, Weber, Bartell, Bennar Newman, Haulotte, Ditch Runner, Menegotti, Morrison, Contec, Buddy, Crown, Edco, Wyco, Bomag, Laymor, EZ Trench, Bil-Jax, F.S. Curtis, Gehl Pavers, Heli, Honda, ICS/PowerGrit, IHI, Partner, Imer, Clipper, MMD, Koshin, Rice, CH&E, General Equipment, Amida, Coleman, NAC, Gradall, Square Shooter, Kent, Stanley, Tamco, Toku, Hatz, Kohler, Robin, Wisconsin, Northrock, Oztec, Toker TK, Rol-Air, APT, Wylie, Ingersoll Rand / Doosan, Innovatech, Con X, Ammann, Mecalac, Makinex, Smith Surface Prep, Small Line, Wanco, Yanmar





 RICAMBI MOTORE

 MOTORERSATZTEILE

 ENGINE SPARE PARTS

 REPUESTOS MOTOR

 PIÈCES DÉTACHÉES DU MOTEUR

| POS Codice | Q.tà |  Descrizione |  Description |  Designation |  Benennung |  Descripción |
|---------------|------|---|---|---|---|---|
| 16 2775200001 | 1 NR | CARTUCCIA FILTRO ARIA COMPLETA HONDA IGX390 | AIR FILTER CARTRIDGE COMPLETE HONDA IGX390 | FILTRE À AIR | LUFTFILTER | FILTRO DE AIRE |
| 17 2558640032 | 1 NR | CANDELA IGX390 HONDA | SPARK PLUG IGX390 HONDA | BOUGIE | KERZE | BUJÍA |
| 18 2775200003 | 1 NR | CARBURATORE COMPLETO HONDA IGX390 | CARBURETOR COMPLETE HONDA IGX390 | CARBURATEUR | VERGASER | CARBURADOR |
| 19 2775200004 | 1 NR | CENTRALINA ELETTRONICA HONDA IGX390 | ELECTRONIC CONTROL UNIT HONDA IGX390 | UNITÉ ÉLECTRONIQUE | ELEKTRONISCHE EINHEIT | UNIDAD ELECTRÓNICA |
| 20 2775200005 | 1 NR | MOTORINO DI AVVIAMENTO COMPLETO HONDA IGX390 | ELECTRIC STARTER COMPLETE HONDA IGX390 | MOTEUR DE DÉMARRAGE | MOTORSTART | MOTOR DE ARRANQUE |

 MOTORE ELETTRICO

E-MOTOR 



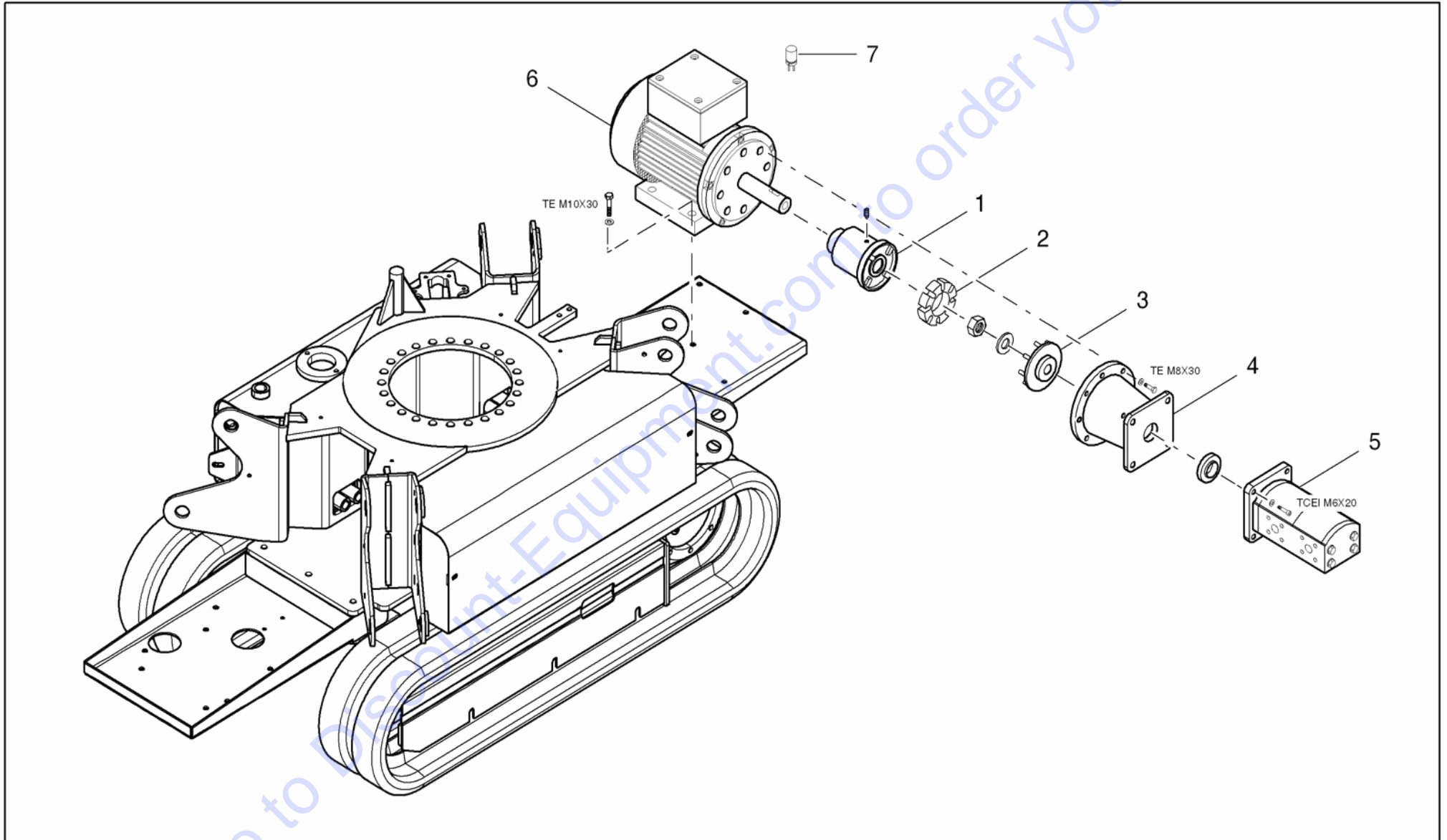

 ELECTRIC MOTOR

MOTOR ELÉCTRICO 





 MOTEUR ÉLECTRIQUE



 MOTORE ELETTRICO
E-MOTOR 
 ELECTRIC MOTOR
MOTOR ELÉCTRICO 
 MOTEUR ÉLECTRIQUE

| POS Codice | Q.tà |  Descrizione |  Description |  Designation |  Benennung |  Descripción |
|------------|------|---|---|---|---|---|
| 1 05563400 | 1 NR | SEMIGIUNTO VERSIONE MOTORE ELETTRICO STANDARD | HALF COUPLING ELECTRIC MOTOR STANDARD VERSION | DEMI-JOINT | HALBKUPPLUNG | SEMI-ACOPLAMIE NTO |
| 1 06997800 | 1 NR | SEMIGIUNTO VERSIONE LITIO | HALF COUPLING LITHIUM VERSION | DEMI-JOINT | HALBKUPPLUNG | SEMI-ACOPLAMIE NTO |
| 2 04310100 | 1 NR | INSERTO IN GOMMA | RUBBER INSERT | INSERT EN CAOUTCHOUC | GUMMIEINSATZ | INSERTO DE GOMA |
| 3 04615300 | 1 NR | GIUNTO | COUPLING | JOINT | VERBINDUNG | ACOPLAMIENTO |
| 4 05510200 | 1 NR | LANTERNA | LANTERN | LANTERNE | LATERNE | LINTERNA |
| 5 255263H3 | 1 NR | POMPA IDRAULICA | HYDRAULIC PUMP | POMPE HYDRAULIQUE | HYDRAULIKPUMP E | BOMBA HYDRÁULICA |
| 5 263281H3 | 1 NR | POMPA IDRAULICA PER MOTORE 120V | HYDRAULIC PUMP FOR ELECTRIC MOTOR 120V | POMPE HYDRAULIQUE | HYDRAULIKPUMP E | BOMBA HYDRÁULICA |

 MOTORE ELETTRICO
E-MOTOR 
 ELECTRIC MOTOR
MOTOR ELÉCTRICO 
 MOTEUR ÉLECTRIQUE

| POS Codice | Q.tà |  Descrizione |  Description |  Designation |  Benennung |  Descripción |
|--------------|------|---|---|---|---|---|
| 6 26328300 | 1 NR | MOTORE ELETTRICO 120V 60HZ 1.2KW 16A | ELECTRIC MOTOR 120V 60HZ 1.2KW 16A | MOTEUR ÉLECTRIQUE | E-MOTOR | MOTOR ELÉCTRICO |
| 6 26774500 | 1 NR | MOTORE ELETTRICO LITHIUM 2KW | ELECTRIC MOTOR LITHIUM 2KW | MOTEUR ÉLECTRIQUE | E-MOTOR | MOTOR ELÉCTRICO |
| 6 27691100 | 1 NR | MOTORE ELETTRICO 230V 50HZ MK2 (DA C170000893) | ELECTRIC MOTOR 230V 50HZ MK2 (FROM C170000893) | MOTEUR ÉLECTRIQUE 230V 50HZ MK2 (FROM C170000893) | E-MOTOR 230V 50HZ MK2 (FROM C170000893) | MOTOR ELÉCTRICO 230V 50HZ MK2 (FROM C170000893) |
| 7 2551010001 | 1 NR | CONDENSATORE 230V MF80 D=55 | CONDENSER 230V MF80 D=55 | CONDENSATEUR | KONDENSATOR | CONDENSADOR |
| 7 2632830001 | 1 NR | CONDENSATORE PER MOTORE 120V MF120 D=55 | CAPACITOR MOTOR 120V MF120 D = 55 | CONDENSATEUR | KONDENSATOR | CONDENSADOR |
| 7 2632830002 | 1 NR | CONDENSATORE PER MOTORE 120V MF160 D=60 | CAPACITOR MOTOR 120V MF160 D = 60 | CONDENSATEUR | KONDENSATOR | CONDENSADOR |

 IMPIANTO IDRAULICO MANDATE E SCARICO

HYDRAULIKANLAGE VORLÄUFE UND RÜCKLAUF 



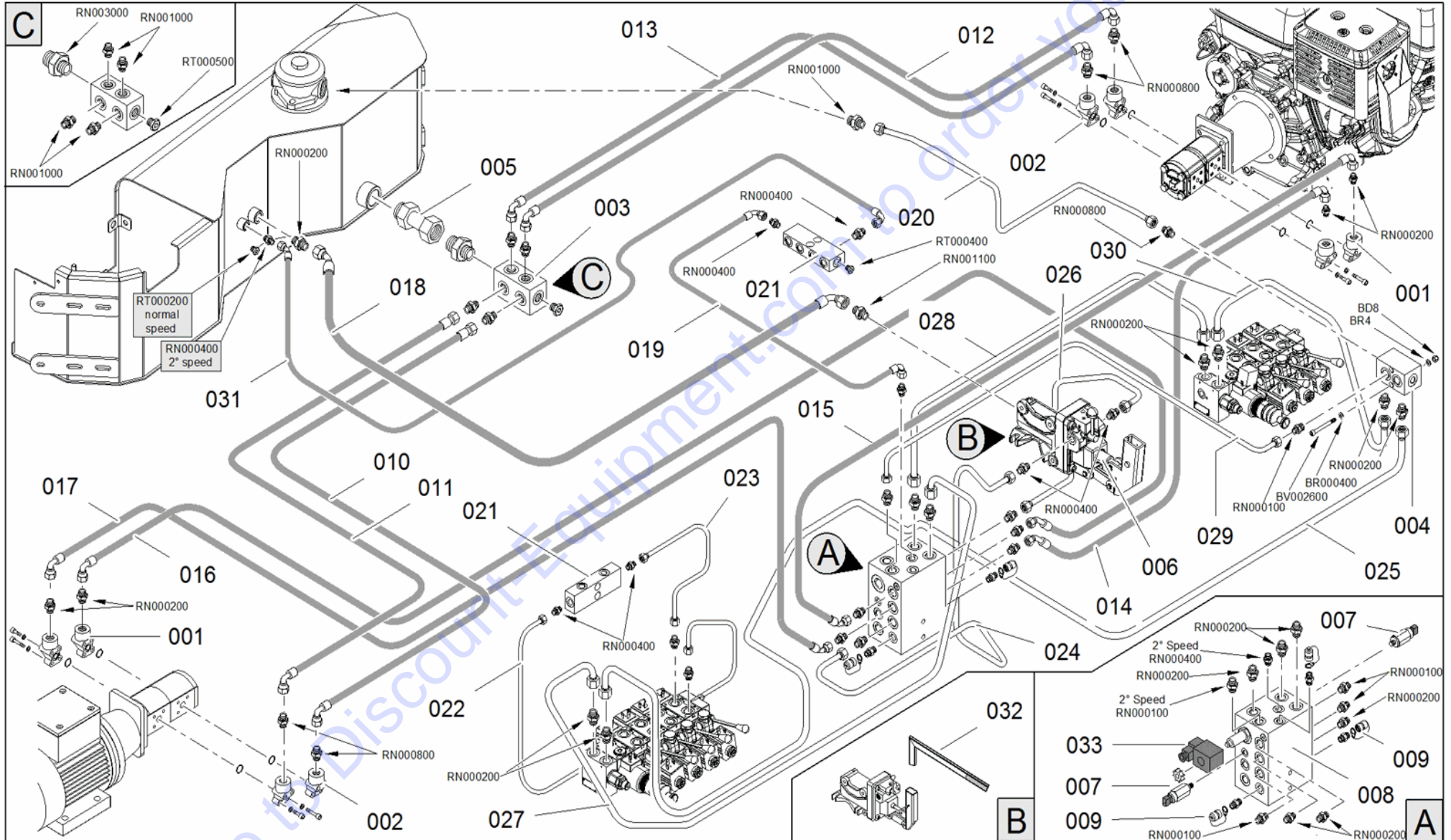

 SUPPLY AND DISCHARGE HYDRAULIC SYSTEM

INSTALCIÓN HIDRÁULICA IMPULSIONES Y DESCARGA 

 SYSTÈME HYDRAULIQUE REFOULEMENT ET DÉCHARGEME



 IMPIANTO IDRAULICO MANDATE E SCARICO
HYDRAULIKANLAGE VORLÄUFE UND RÜCKLAUF 
 SUPPLY AND DISCHARGE HYDRAULIC SYSTEM
INSTALACIÓN HIDRÁULICA IMPULSIONES Y DESCARGA 
 SYSTÈME HYDRAULIQUE REFOULEMENT ET DÉCHARGEME

| POS Codice | Q.tà |  Descrizione |  Description |  Designation |  Benennung |  Descripción |
|-------------|------|---|---|---|---|---|
| 1 04048100 | 2 NR | FLANGIA 3/8" G | FLANGE 3/8" G | BRIDE 3/8" G | FLANSCH 3/8" G | BRIDA 3/8" G |
| 2 04845400 | 2 NR | FLANGIA 1/2"G | FLANGE 1/2"G | BRIDE 1/2"G | FLANSCH 1/2"G | BRIDA 1/2"G |
| 3 07764900 | 1 NR | COLLETTORE ASPIRAZIONI POMPE LL1570 | INTAKE MANIFOLD PUMPS LL1570 | COLLECTEUR | KOLLEKTOR | COLECTOR |
| 4 05497500 | 1 NR | BLOCCHETTO TUBI | HOSES BLOCK | BLOC TUYAUX | ROHRBLOCK | BLOQUE TUBOS |
| 6 26459400 | 1 NR | POMPA A MANO | HAND PUMP | POMPE MANUELLE | HANDPUMPE | BOMBA DE MANO |
| 7 26964400 | 2 NR | PRESSOSTATO | PRESSURE SWITCH | PRESSOSTAT | DRUCKSCHALTE R | PRESÓSTATO |
| 8 17772200 | 1 NR | VALVOLA IDRAULICA | HYDRAULIC VALVE | VALVE HYDRAULIQUE | HYDRAULIKVENTI L | VÁLVULA HIDRÁULICA |
| 8 17805400 | 1 NR | VALVOLA IDRAULICA | HYDRAULIC VALVE | VALVE HYDRAULIQUE | HYDRAULIKVENTI L | VÁLVULA HIDRÁULICA |
| 9 03014400 | 3 NR | PROVA PRESSIONE 1/4" G | PRESSURE TEST 1/4" G | PREUVE PRESSION 1/4" G | DRUCKKONTROL LE 1/4" G | PRUEBA PRESIÓN 1/4" G |
| 9 03014400 | 2 NR | PROVA PRESSIONE 1/4" G | PRESSURE TEST 1/4" G | PREUVE PRESSION 1/4" G | DRUCKKONTROL LE 1/4" G | PRUEBA PRESIÓN 1/4" G |
| 10 07781100 | 1 NR | TUBO FLESSIBILE | FLEXIBLE PIPE | TUYAU FLEXIBLE | SCHLAUCH | TUBO FLEXIBLE |
| 11 07781200 | 1 NR | TUBO FLESSIBILE | FLEXIBLE PIPE | TUYAU FLEXIBLE | SCHLAUCH | TUBO FLEXIBLE |





 IMPIANTO IDRAULICO MANDATE E SCARICO

HYDRAULIKANLAGE VORLÄUFE UND RÜCKLAUF 

 SUPPLY AND DISCHARGE HYDRAULIC SYSTEM

INSTALACIÓN HIDRÁULICA IMPULSIONES Y DESCARGA 

 SYSTÈME HYDRAULIQUE REFOULEMENT ET DÉCHARGEME

| POS Codice | Q.tà |  Descrizione |  Description |  Designation |  Benennung |  Descripción |
|-------------|------|---|---|---|---|---|
| 12 07780900 | 1 NR | TUBO FLESSIBILE | FLEXIBLE PIPE | TUYAU FLEXIBLE | SCHLAUCH | TUBO FLEXIBLE |
| 13 07781000 | 1 NR | TUBO FLESSIBILE | FLEXIBLE PIPE | TUYAU FLEXIBLE | SCHLAUCH | TUBO FLEXIBLE |
| 14 07813300 | 1 NR | TUBO FLESSIBILE | FLEXIBLE PIPE | TUYAU FLEXIBLE | SCHLAUCH | TUBO FLEXIBLE |
| 15 07813600 | 1 NR | TUBO FLESSIBILE | FLEXIBLE PIPE | TUYAU FLEXIBLE | SCHLAUCH | TUBO FLEXIBLE |
| 16 07813400 | 1 NR | TUBO FLESSIBILE | FLEXIBLE PIPE | TUYAU FLEXIBLE | SCHLAUCH | TUBO FLEXIBLE |
| 17 07813500 | 1 NR | TUBO FLESSIBILE | FLEXIBLE PIPE | TUYAU FLEXIBLE | SCHLAUCH | TUBO FLEXIBLE |
| 18 07784000 | 1 NR | TUBO FLESSIBILE | FLEXIBLE PIPE | TUYAU FLEXIBLE | SCHLAUCH | TUBO FLEXIBLE |
| 19 07813700 | 1 NR | TUBO FLESSIBILE | FLEXIBLE PIPE | TUYAU FLEXIBLE | SCHLAUCH | TUBO FLEXIBLE |
| 20 07773000 | 1 NR | TUBO RIGIDO | RIGID PIPE | TUYAU | SCHLAUCH | TUBO |
| 21 04707700 | 2 NR | COLLETTORE | MANIFOLD | COLLECTEUR | KOLLEKTOR | COLECTOR |
| 22 07747400 | 1 NR | TUBO RIGIDO | RIGID PIPE | TUYAU | ROHR | TUBO |
| 23 07747300 | 1 NR | TUBO RIGIDO | RIGID PIPE | TUYAU | ROHR | TUBO |
| 24 07772700 | 1 NR | TUBO RIGIDO | RIGID PIPE | TUYAU | SCHLAUCH | TUBO |
| 25 07772300 | 1 NR | TUBO RIGIDO | RIGID PIPE | TUYAU | SCHLAUCH | TUBO |
| 26 07772800 | 1 NR | TUBO RIGIDO | RIGID PIPE | TUYAU | SCHLAUCH | TUBO |
| 27 07772500 | 1 NR | TUBO RIGIDO | RIGID PIPE | TUYAU | SCHLAUCH | TUBO |





 IMPIANTO IDRAULICO MANDATE E SCARICO

HYDRAULIKANLAGE VORLÄUFE UND RÜCKLAUF 

 SUPPLY AND DISCHARGE HYDRAULIC SYSTEM

INSTALACIÓN HIDRÁULICA IMPULSIONES Y DESCARGA 

 SYSTÈME HYDRAULIQUE REFOULEMENT ET DÉCHARGEME

| POS Codice | Q.tà |  Descrizione |  Description |  Designation |  Benennung |  Descripción |
|-------------|------|---|---|---|---|---|
| 28 07772600 | 1 NR | TUBO RIGIDO | RIGID PIPE | TUYAU | SCHLAUCH | TUBO |
| 29 07772900 | 1 NR | TUBO RIGIDO | RIGID PIPE | TUYAU | SCHLAUCH | TUBO |
| 30 07772400 | 1 NR | TUBO RIGIDO | RIGID PIPE | TUYAU | SCHLAUCH | TUBO |
| 31 07783000 | 1 NR | TUBO FLESSIBILE | FLEXIBLE PIPE | TUYAU FLEXIBLE | SCHLAUCH | TUBO FLEXIBILE |
| 32 16517700 | 1 NR | LEVA | LEVER | LEVIER | HEBEL | PALANCA |
| 33 07845200 | 1 NR | BOBINA PER DISTRIBUTORE IDRAULICO SENZA DIODO CONNETTORE DEUTSCH | COIL FOR HYDRAULIC DISTRIBUTOR WITHOUT DIODE, CONNECTOR DEUTSCH | BOBINE | SPULE | BOBINA |
| 34 07845200 | 1 NR | BOBINA PER DISTRIBUTORE IDRAULICO SENZA DIODO CONNETTORE DEUTSCH | COIL FOR HYDRAULIC DISTRIBUTOR WITHOUT DIODE, CONNECTOR DEUTSCH | BOBINE | SPULE | BOBINA |

 IMPIANTO IDRAULICO MANDATE E SCARICO

HYDRAULIKANLAGE VORLÄUFE UND RÜCKLAUF 

 SUPPLY AND DISCHARGE HYDRAULIC SYSTEM

INSTALACIÓN HIDRÁULICA IMPULSIONES Y DESCARGA 



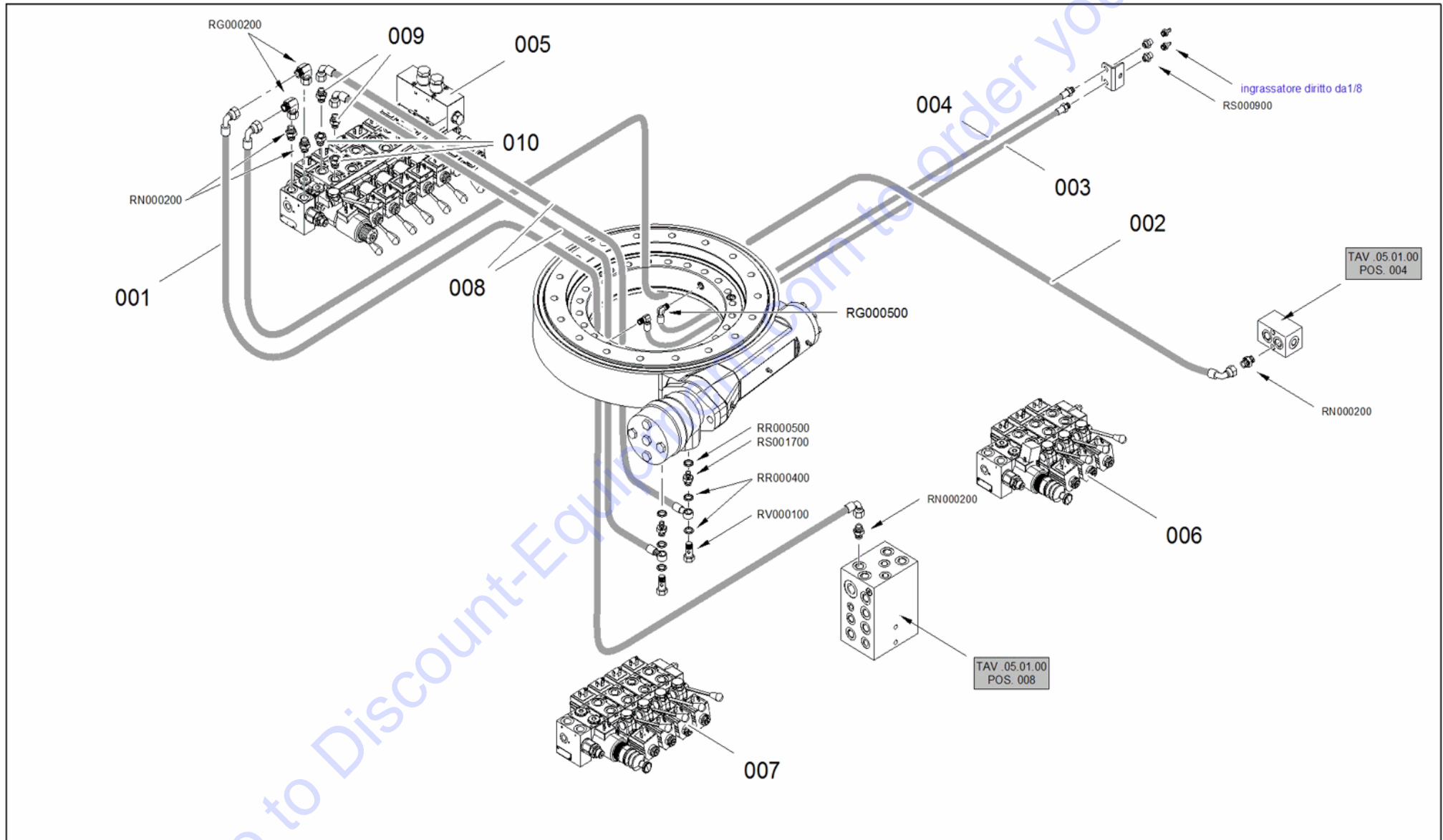

 SYSTÈME HYDRAULIQUE REFOULEMENT ET DÉCHARGEMENT



 IMPIANTO IDRAULICO MANDATE E SCARICO

 HYDRAULIKANLAGE VORLÄUFE UND RÜCKLAUF 
 SUPPLY AND DISCHARGE HYDRAULIC SYSTEM

 INSTALACIÓN HIDRÁULICA IMPULSIONES Y DESCARGA 
 SYSTÈME HYDRAULIQUE REFOULEMENT ET DÉCHARGEMENT

| POS Codice | Q.tà |  Descrizione |  Description |  Designation |  Benennung |  Descripción |
|------------|------|---|---|---|---|--|
| 1 07813900 | 1 NR | TUBO FLESSIBILE | FLEXIBLE PIPE | TUYAU FLEXIBLE | SCHLAUCH | TUBO FLEXIBLE |
| 2 07813800 | 1 NR | TUBO FLESSIBILE | FLEXIBLE PIPE | TUYAU FLEXIBLE | SCHLAUCH | TUBO FLEXIBLE |
| 3 07784100 | 1 NR | TUBO FLESSIBILE | FLEXIBLE PIPE | TUYAU FLEXIBLE | SCHLAUCH | TUBO FLEXIBLE |
| 4 07784200 | 1 NR | TUBO FLESSIBILE | FLEXIBLE PIPE | TUYAU FLEXIBLE | SCHLAUCH | TUBO FLEXIBLE |
| 5 27533400 | 1 NR | DISTRIBUTORE IDRAULICO 7 ELEMENTI PARTE AEREA CON PULSANTE (FOR LL1775-X17JP-X5 00AJ-LL2010-X20 JP-X600AJ MK2 FROM C170000893) | HYDRAULIC DISTRIBUTOR 7 ELEMENTS AERIAL PART WITH BUTTON (FOR LL1775-X17JP-X5 00AJ-LL2010-X20 JP-X600AJ MK2 FROM JP-X600AJ MK2 FROM C170000893) | DISTRIBUTEUR HYDRAULIQUE (FOR LL1775-X17JP-X5 00AJ-LL2010-X20 JP-X600AJ MK2 FROM C170000893) | HYDRAULISCHER VERTEILER (FOR LL1775-X17JP-X5 00AJ-LL2010-X20 JP-X600AJ MK2 FROM C170000893) | DISTRIBUIDOR HIDRÁULICO (FOR LL1775-X17JP-X5 00AJ-LL2010-X20 JP-X600AJ MK2 FROM C170000893) |
| 6 27299000 | 1 NR | DISTRIBUTORE LC STABILIZZATORI-T RAINO 3 ELEMENTI CON LEVE EMERGENZA A PULSANTE | HYDRAULIC DISTRIBUTOR STABILIZERS-TRA CKS 3 PARTS WITH LEVERS EMERGENCY BUTTON | DISTRIBUTEUR HYDRAULIQUE | HYDR. REGELSTEUERG ERÄT | DISTRIBUIDOR HIDRÁULICO |





 IMPIANTO IDRAULICO MANDATE E SCARICO

HYDRAULIKANLAGE VORLÄUFE UND RÜCKLAUF 

 SUPPLY AND DISCHARGE HYDRAULIC SYSTEM

INSTALACIÓN HIDRÁULICA IMPULSIONES Y DESCARGA 

 SYSTÈME HYDRAULIQUE REFOULEMENT ET DÉCHARGEMENT

| POS Codice | Q.tà |  Descrizione |  Description |  Designation |  Benennung |  Descripción |
|-------------|------|--|--|---|---|---|
| 7 27299100 | 1 NR | DISTRIBUTORE LC STABILIZZATORI-T RAINO 4 ELEMENTI CON LEVE EMERGENZA A PULSANTE | HYDRAULIC DISTRIBUTOR STABILIZERS-TRA CKS 4 PARTS WITH LEVERS EMERGENCY BUTTON | DISTRIBUTEUR HYDRAULIQUE | HYDRAULIKVENTI LBLOCK | DISTRIBUIDOR HIDRÁULICO |
| 8 07784500 | 2 NR | TUBO FLESSIBILE | FLEXIBLE PIPE | TUYAU FLEXIBLE | SCHLAUCH | TUBO FLEXIBLE |
| 9 06786700 | 2 NR | RACCORDO | FITTING | RACCORD | ANSCHLUSS | CONEXIÓN |
| 10 RS000700 | 2 NR | RIDUZIONE M-F GAS 1" * 1/2" | REDUCING GAS M-F 1" * 1/2" | RÉDUCTION M-F GAS 1" * 1/2" | REDUZIERUNG GAS M-F 1"* 1/2" | REDUCCIÓN M-F GAS 1" * 1/2" |

 **DISTRIBUTORI IDRAULICI**

HYDRAULISCHE REGELSTEUERGERÄTE 

 **HYDRAULIC DISTRIBUTORS**

DISTRIBUIDORES HIDRÁULICOS 



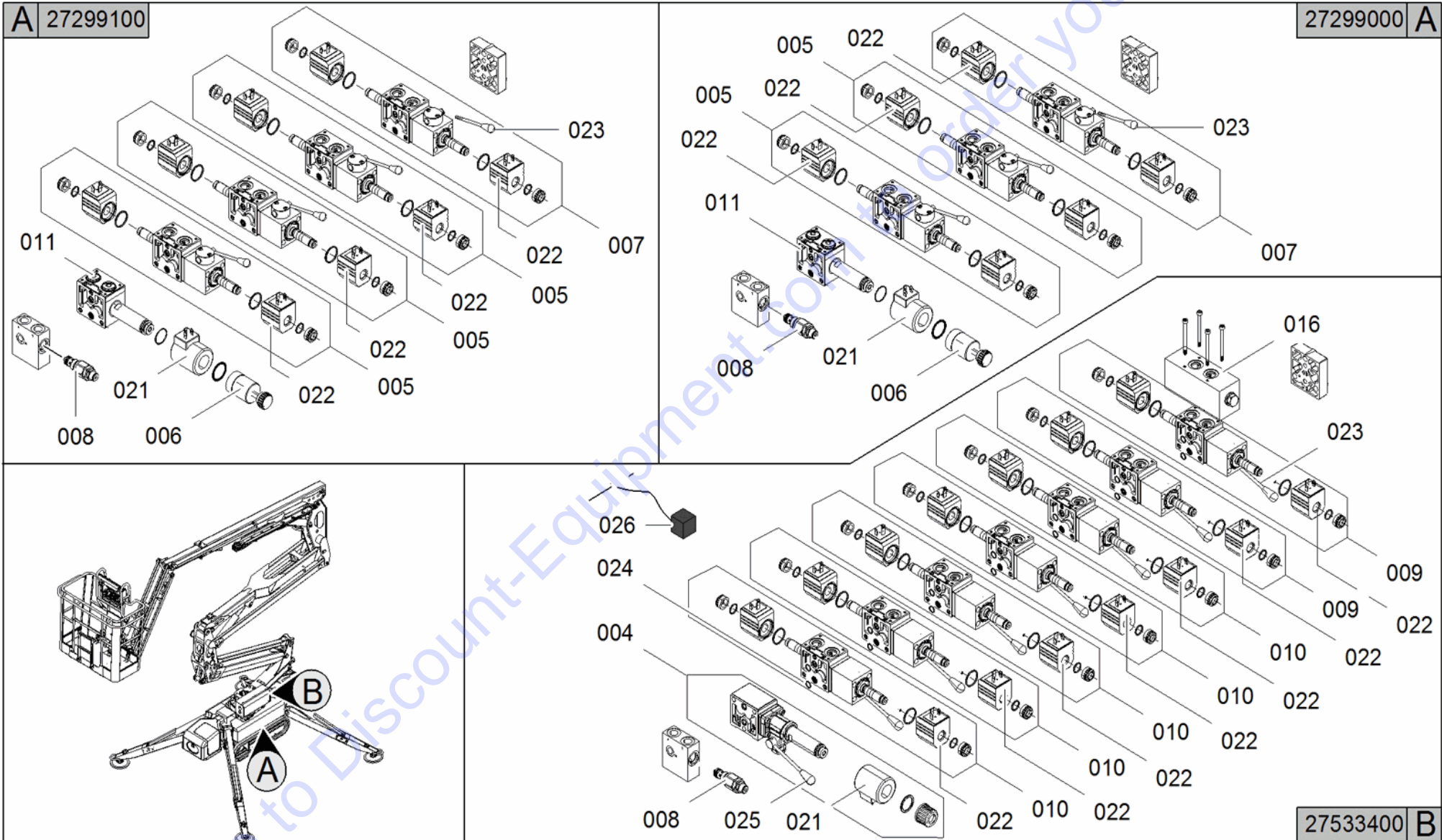

 **DISTRIBUTEURS HYDRAULIQUES**







 DISTRIBUTORI IDRAULICI

 HYDRAULISCHE REGELSTEUERGERÄTE 
 HYDRAULIC DISTRIBUTORS

 DISTRIBUIDORES HIDRÁULICOS 
 DISTRIBUTEURS HYDRAULIQUES

| POS Codice | Q.tà |  Descrizione |  Description |  Designation |  Benennung |  Descripción |
|--------------|------|---|---|---|---|---|
| 4 2753340004 | 1 NR | ELEMENTO DISTRIBUTORE COMPLETO DI PROPORZIONALE PARTE AEREA CON LEVA ROSSA (LATO 1) | VALVE BLOCK ELEMENT | ELEMENT DISTRIBUTEUR | VENTILBLOCKSA TZ | ELEMENTO DISTRIBUIDOR |
| 5 2645900005 | 1 NR | SEZIONE DISTRIBUTORE AB CHIUSO CON LEVA (LATO A) E BOBINA | VALVE BLOCK SECTION AB CLOSED WITH LEVER (SIDE A) AND COIL | SECTION DISTRIBUTEUR | VENTILBLOCKSE KTION | SECCIÓN DISTRIBUIDOR |
| 6 07324900 | 1 NR | COMANDO MANUALE EMERGENZA CON RITORNO A MOLLA | EMERGENCY MAUAL CONTROL WITH SPRING RETURN | COMMANDE MANUEL D'URGENCE | MANUELLES ANTRIEB FÜR NOTSTAND | MANDO MANUAL DE EMERGENCIA |
| 7 2645900006 | 1 NR | SEZIONE DISTRIBUTORE ABT CON LEVA (LATO A) E BOBINA | VALVE BLOCK SECTION ABT WITH LEVER (SIDE A) AND COIL | SECTION DISTRIBUTEUR | VENTILBLOCKSE KTION | SECCIÓN DISTRIBUIDOR |
| 8 2645900002 | 1 NR | CARTUCCIA VALVOLA DI MASSIMA PRESSIONE | CARTRIDGE PRESSURE RELIEF VALVE | CARTOUCHE SOUPAPE DE SÉCURITÉ | PARTONE ÜBERDRUCKVEN TIL | CATUCHO VÁLVULA LIMITADORA DE PRESIÓN |





 DISTRIBUTORI IDRAULICI
HYDRAULISCHE REGELSTEUERGERÄTE 
 HYDRAULIC DISTRIBUTORS
DISTRIBUIDORES HIDRÁULICOS 
 DISTRIBUTEURS HYDRAULIQUES

| POS Codice | Q.tà |  Descrizione |  Description |  Designation |  Benennung |  Descripción |
|---------------|------|---|---|---|---|---|
| 9 2753340002 | 1 NR | SEZIONE DISTRIBUTORE ABT CON LEVA (LATO 1) E BOBINA | SECTION DISTRIBUTOR ABT WITH LEVER (SIDE 1) AND COIL | SECTION DISTRIBUTEUR | VENTILBLOCKSE KTION | SECCIÓN DISTRIBUIDOR |
| 10 2753340001 | 1 NR | SEZIONE DISTRIBUTORE AB CHIUSO CON LEVA (LATO 1) E BOBINA | SECTION DISTRIBUTOR AB CLOSED WITH LEVER (SIDE 1) AND COIL | SECTION DISTRIBUTEUR | VENTILBLOCKSE KTION | SECCIÓN DISTRIBUIDOR |
| 11 2729900001 | 1 NR | VALVOLA PROPORZIONALE TRAINI CON BOBINA E SENZA COMANDO MANUALE A MOLLA | PROPORTIONAL VALVE FOR TRACK WITH COIL AND WITHOUT MANUAL SPRING | SOUPAPE PROPORTIONELL E | PROPORTIONALV ENTIL | VÁLVULA PROPORCIONAL |
| 16 2585560004 | 1 NR | BLOCCO VALVOLA BILANCIAMENTO BRACCI SU DISTRIBUTORI PARTE AEREA | BALANCING VALVE BLOCK BOOMS OF DISTRIBUTORS AERIAL PART | BLOC SOUPAPE | VENTILSPERRE | BLOQUE VÁLVULA |
| 21 06037100 | 1 NR | BOBINA PER VALVOLA PROPORZIONALE PARTE CARRO | COIL PROPORTIONAL VALVE FOR UNDERCARRIAG E | BOBINE | SPULE | BOBINA |

 DISTRIBUTORI IDRAULICI

 HYDRAULISCHE REGELSTEUERGERÄTE 
 HYDRAULIC DISTRIBUTORS

 DISTRIBUIDORES HIDRÁULICOS 
 DISTRIBUTEURS HYDRAULIQUES

| POS Codice | Q.tà |  Descrizione |  Description |  Designation |  Benennung |  Descripción |
|---------------|------|---|---|---|---|---|
| 22 05913800 | 1 NR | BOBINA PER ON-OFF | COIL FOR ON-OFF | BOBINE | SPULE | BOBINA |
| 23 07300200 | 1 NR | LEVA DISTRIBUTORE | LEVER HYDRAULIC DISTRIBUTOR | LEVIER | HEBEL | PALANCA |
| 24 2585560005 | 1 NR | O-RING | O-RING | O-RING | O-RING | O-RING |
| 25 2753340003 | 1 NR | LEVA ROSSA DISTRIBUTORE | RED LEVER HYDRAULIC DISTRIBUTOR | LEVIER | HEBEL | PALANCA |
| 26 1730720001 | 1 NR | ELETTROVALVOL A ON-OFF CON LED | SOLENOID ON-OFF WITH LED | ELECTROVANNE ON-OFF AVEC LED | SOLENOID ON-OFF WITH LED | SOLENOIDE ON-OFF CON LED |

Go to Discount-Equipment.com to Order your parts

 IMPIANTO IDRAULICO TRAZIONE

HYDRAULIKANLAGE ANTRIEB 

 HYDRAULIC SYSTEM FOR TRACTION

INSTALACIÓN HIDRÁULICA TRACCIÓN 

 SYSTÈME HYDRAULIQUE DE TRACTION

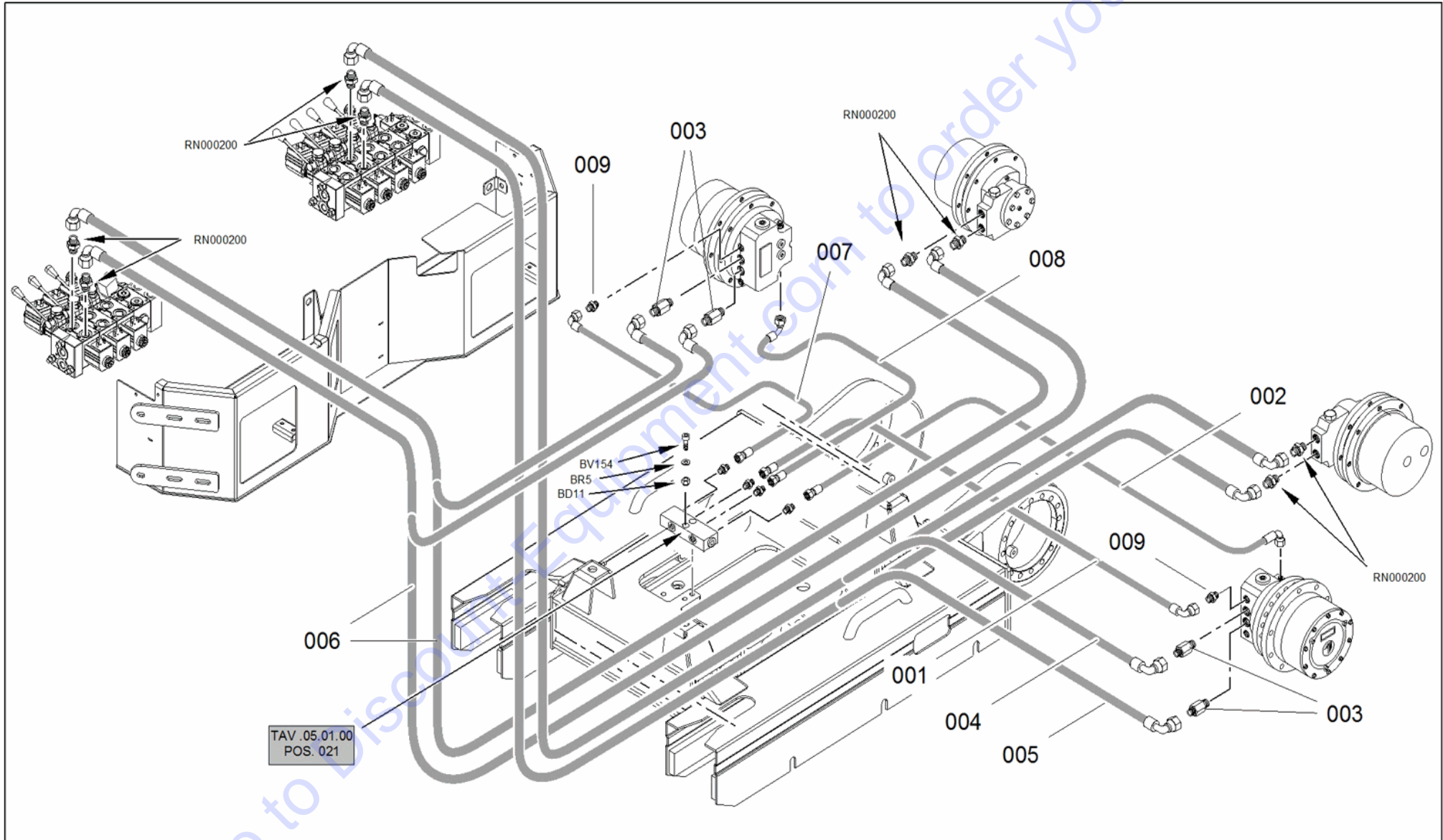





 IMPIANTO IDRAULICO TRAZIONE

HYDRAULIKANLAGE ANTRIEB 

 HYDRAULIC SYSTEM FOR TRACTION

INSTALACIÓN HIDRÁULICA TRACCIÓN 

 SYSTÈME HYDRAULIQUE DE TRACTION

| POS Codice | Q.tà |  Descrizione |  Description |  Designation |  Benennung |  Descripcìon |
|------------|------|---|---|---|---|---|
| 1 07782600 | 1 NR | TUBO FLESSIBILE | FLEXIBLE PIPE | TUYAU FLEXIBLE | SCHLAUCH | TUBO FLEXIBLE |
| 2 07782500 | 1 NR | TUBO FLESSIBILE | FLEXIBLE PIPE | TUYAU FLEXIBLE | SCHLAUCH | TUBO FLEXIBLE |
| 3 05093900 | 4 NR | RACCORDO 12L-3/8 JIS ESAGONO 22 H40 | 12L-FITTING 3/8 JIS HEX22 H40 | RACCORD | ANSCHLUSS | CONEXIÓN |
| 4 07783700 | 1 NR | TUBO FLESSIBILE | FLEXIBLE PIPE | TUYAU FLEXIBLE | SCHLAUCH | TUBO FLEXIBLE |
| 5 07783800 | 1 NR | TUBO FLESSIBILE | FLEXIBLE PIPE | TUYAU FLEXIBLE | SCHLAUCH | TUBO FLEXIBLE |
| 6 07783900 | 2 NR | TUBO FLESSIBILE | FLEXIBLE PIPE | TUYAU FLEXIBLE | SCHLAUCH | TUBO FLEXIBLE |
| 7 07782800 | 1 NR | TUBO FLESSIBILE | FLEXIBLE PIPE | TUYAU FLEXIBLE | SCHLAUCH | TUBO FLEXIBLE |
| 8 07782700 | 1 NR | TUBO FLESSIBILE | FLEXIBLE PIPE | TUYAU FLEXIBLE | SCHLAUCH | TUBO FLEXIBLE |
| 9 05582000 | 2 NR | RACCORDO | FITTING | RACCORD | ANSCHLUSS | CONEXIÓN |

Go to Discount-Equipment.com to order your parts

 IMPIANTO IDRAULICO ALLARGAMENTO CARRO

HYDRAULIKANLAGE VERBREITERUNG WAGEN 

 HYDRAULIC SYSTEM UNDERCARRIAGE EXPANSION

INSTALACIÓN HIDRAULICA ENSANCHAMIENTO CARRO 

 SYSTÈME HYDRAULIQUE EXTENSION DU CHARIOT

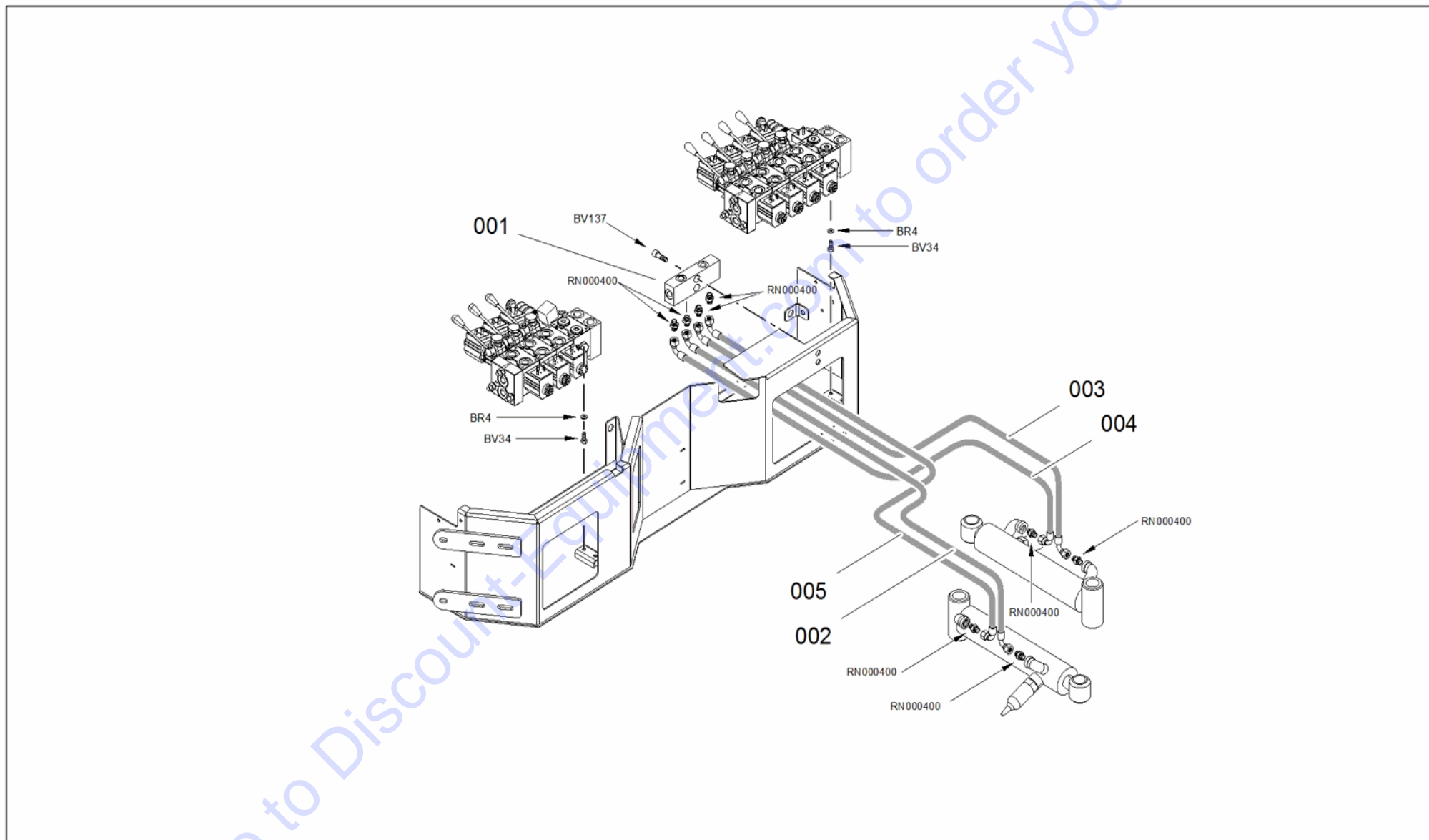





 IMPIANTO IDRAULICO ALLARGAMENTO CARRO

HYDRAULIKANLAGE VERBREITERUNG WAGEN 

 HYDRAULIC SYSTEM UNDERCARRIAGE EXPANSION

INSTALACIÓN HIDRAULICA ENSANCHAMIENTO CARRO 

 SYSTÈME HYDRAULIQUE EXTENSION DU CHARIOT

| POS Codice | Q.tà |  Descrizione |  Description |  Designation |  Benennung |  Descripcìon |
|------------|------|---|---|---|---|---|
| 1 04707700 | 1 NR | COLLETTORE | MANIFOLD | COLLECTEUR | KOLLEKTOR | COLECTOR |
| 2 07783500 | 1 NR | TUBO FLESSIBILE | FLEXIBLE PIPE | TUYAU FLEXIBLE | SCHLAUCH | TUBO FLEXIBLE |
| 3 07783600 | 1 NR | TUBO FLESSIBILE | FLEXIBLE PIPE | TUYAU FLEXIBLE | SCHLAUCH | TUBO FLEXIBLE |
| 4 07783300 | 1 NR | TUBO FLESSIBILE | FLEXIBLE PIPE | TUYAU FLEXIBLE | SCHLAUCH | TUBO FLEXIBLE |
| 5 07783400 | 1 NR | TUBO FLESSIBILE | FLEXIBLE PIPE | TUYAU FLEXIBLE | SCHLAUCH | TUBO FLEXIBLE |

 IMPIANTO IDRAULICO STABILIZZATORI

ABSTÜTZUNG ABSTÜTZUNGSHYDRAULIKZYLIND 

 STABILIZERS HYDRAULIC SYSTEM

INSTALACIÓN HIDRAULICA ESTABILIZADORS 

 INSTALLATION HYDRAULIQUE STABILISATERS

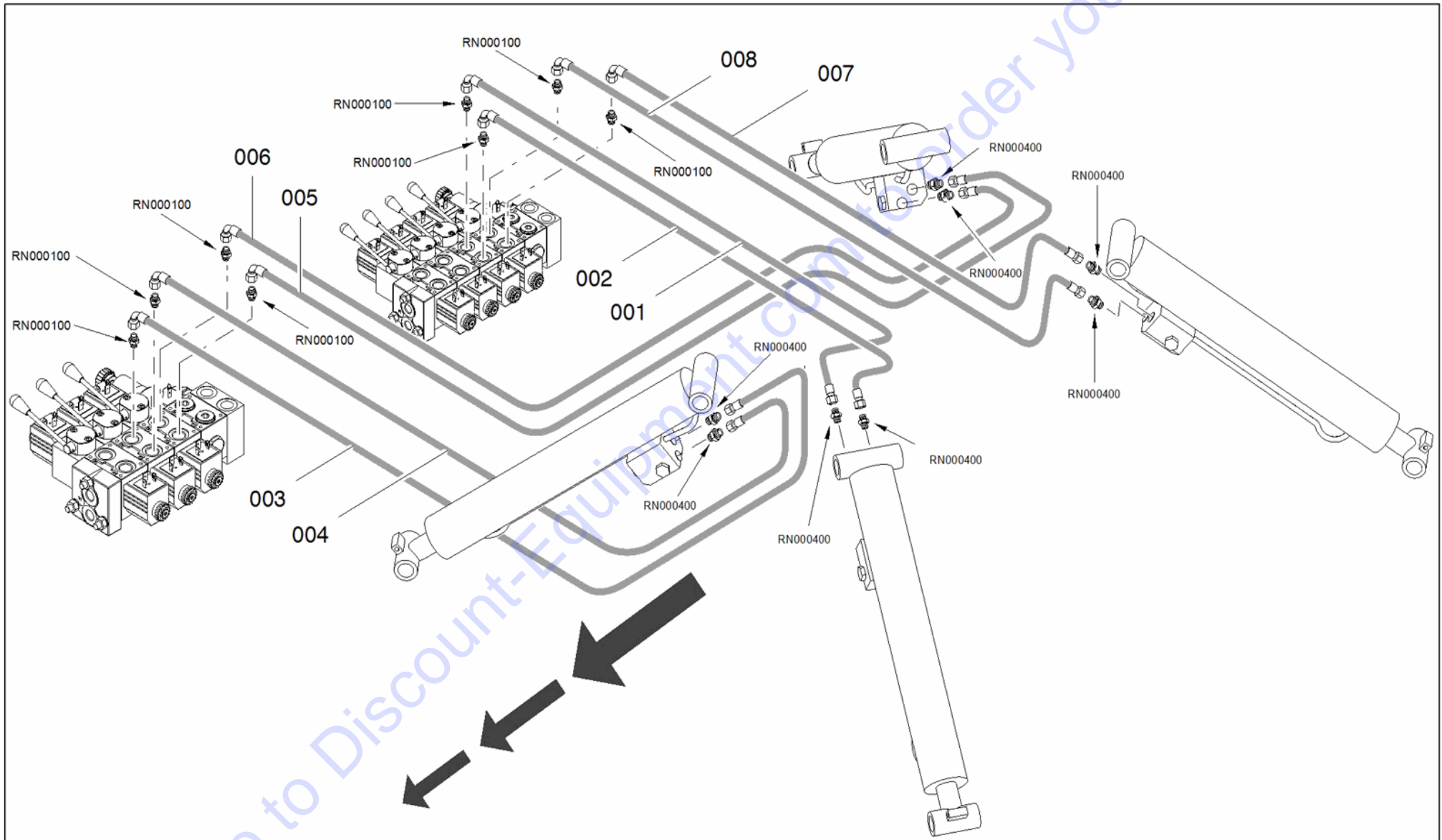





 IMPIANTO IDRAULICO STABILIZZATORI

ABSTÜTZUNG ABSTÜTZUNGSHYDRAULIKZYLIND 

 STABILIZERS HYDRAULIC SYSTEM

INSTALACIÓN HIDRAULICA ESTABILIZADORS 

 INSTALLATION HYDRAULIQUE STABILISATERS

| POS Codice | Q.tà |  Descrizione |  Description |  Designation |  Benennung |  Descripcìon |
|------------|------|---|---|---|---|---|
| 1 07782200 | 1 NR | TUBO FLESSIBILE | FLEXIBLE PIPE | TUYAU FLEXIBLE | SCHLAUCH | TUBO FLEXIBLE |
| 2 07782100 | 1 NR | TUBO FLESSIBILE | FLEXIBLE PIPE | TUYAU FLEXIBLE | SCHLAUCH | TUBO FLEXIBLE |
| 3 07781700 | 1 NR | TUBO FLESSIBILE | FLEXIBLE PIPE | TUYAU FLEXIBLE | SCHLAUCH | TUBO FLEXIBLE |
| 4 07781800 | 1 NR | TUBO FLESSIBILE | FLEXIBLE PIPE | TUYAU FLEXIBLE | SCHLAUCH | TUBO FLEXIBLE |
| 5 07781900 | 1 NR | TUBO FLESSIBILE | FLEXIBLE PIPE | TUYAU FLEXIBLE | SCHLAUCH | TUBO FLEXIBLE |
| 6 07782000 | 1 NR | TUBO FLESSIBILE | FLEXIBLE PIPE | TUYAU FLEXIBLE | SCHLAUCH | TUBO FLEXIBLE |
| 7 07782400 | 1 NR | TUBO FLESSIBILE | FLEXIBLE PIPE | TUYAU FLEXIBLE | SCHLAUCH | TUBO FLEXIBLE |
| 8 07782300 | 1 NR | TUBO FLESSIBILE | FLEXIBLE PIPE | TUYAU FLEXIBLE | SCHLAUCH | TUBO FLEXIBLE |

Go to Discount-Equipment.com to order your parts

 IMPIANTO IDRAULICO 1-2 BRACCI

HYDRAULIKANLAGE 1-2 ARM 

 1-2 ARMS HYDRAULIC SYSTEM

INSTALACIÓN HIDRÁULICA 1-2 BRAZOS 

 SYSTÈME HYDRAULIQUE 1-2 BRAS

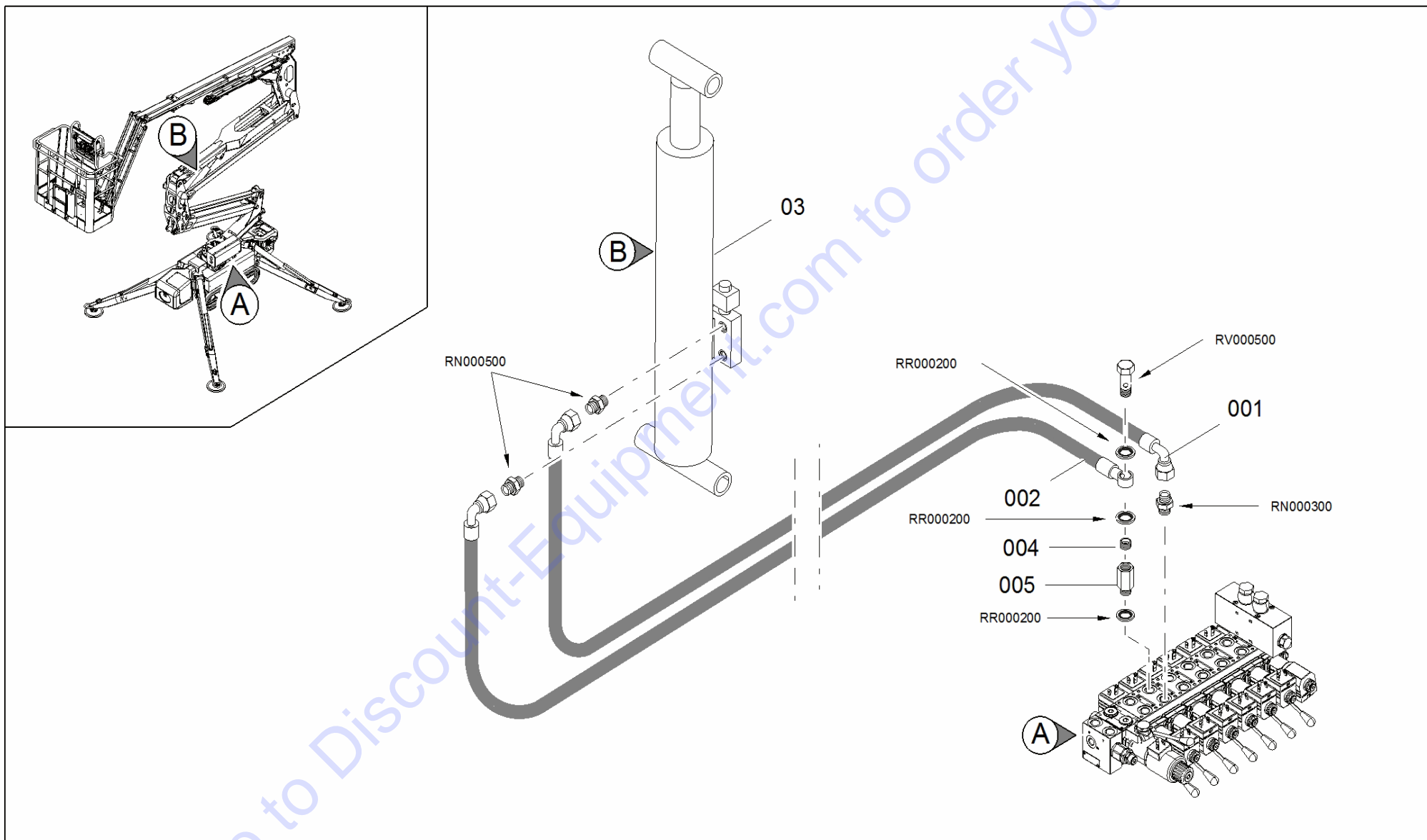





 IMPIANTO IDRAULICO 1-2 BRACCI

HYDRAULIKANLAGE 1-2 ARM 

 1-2 ARMS HYDRAULIC SYSTEM

INSTALACIÓN HIDRÁULICA 1-2 BRAZOS 

 SYSTÈME HYDRAULIQUE 1-2 BRAS

| POS Codice | Q.tà |  Descrizione |  Description |  Designation |  Benennung |  Descripción |
|------------|------|---|---|---|---|---|
| 1 07784600 | 1 NR | TUBO FLESSIBILE | FLEXIBLE PIPE | TUYAU FLEXIBLE | SCHLAUCH | TUBO FLEXIBLE |
| 2 07784700 | 1 NR | TUBO FLESSIBILE | FLEXIBLE PIPE | TUYAU FLEXIBLE | SCHLAUCH | TUBO FLEXIBLE |
| 3 277099H2 | 1 NR | CILINDRO PRIMO-SECONDO BRACCIO LL1570-X15JP-X4 30AJ | CYLINDER FIRST-SECOND BOOM LL1570-X15JP-X4 30AJ | CYLINDER | ZYLINDER | CILINDRO |
| 4 07688500 | 1 NR | PASTIGLIA VNR STROZZATA 3/8 FORO DA Ø=2MM | VALVE | SOUPAPE | VENTIL | VALVULA |
| 5 07688400 | 1 NR | RACCORDO PROLUNGA M-F 3/8 H=30 FILETTO UTILE 25 | FITTING | RACCORD | ANSCHLUSS | CONEXIÓN |

 IMPIANTO IDRAULICO 3 BRACCIO

HYDRAULIKANLAGE 3 ARM 

 3 ARM HYDRAULIC SYSTEM

INSTALACIÓN HIDRÁULICA 3 BRAZO 

 SYSTÈME HYDRAULIQUE 3 BRAS

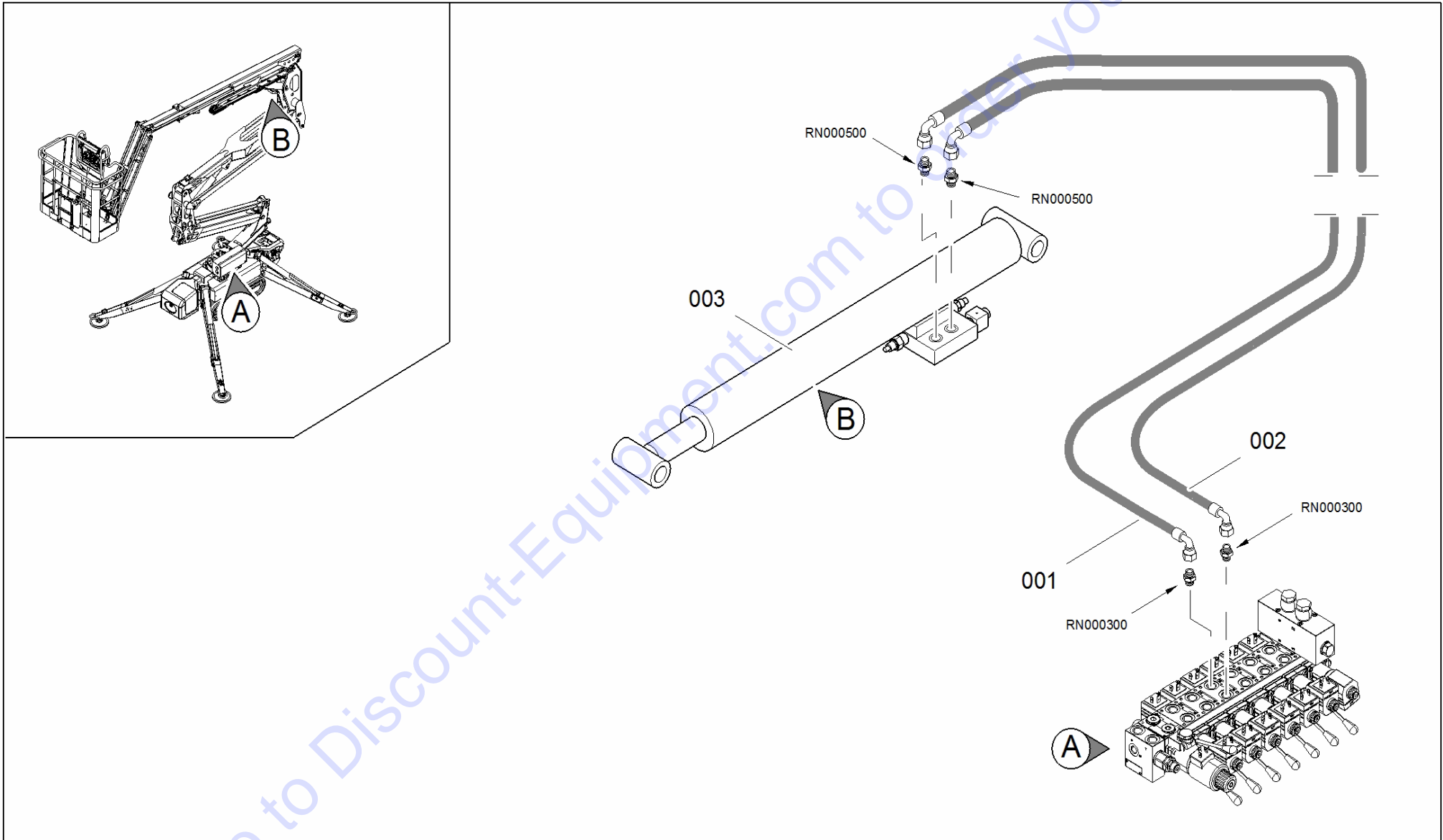





 IMPIANTO IDRAULICO 3 BRACCIO

HYDRAULIKANLAGE 3 ARM 

 3 ARM HYDRAULIC SYSTEM

INSTALACIÓN HIDRÁULICA 3 BRAZO 

 SYSTÈME HYDRAULIQUE 3 BRAS

| POS Codice | Q.tà |  Descrizione |  Description |  Designation |  Benennung |  Descripción |
|------------|------|---|---|---|---|---|
| 1 07785000 | 1 NR | TUBO FLESSIBILE | FLEXIBLE PIPE | TUYAU FLEXIBLE | SCHLAUCH | TUBO FLEXIBLE |
| 2 07785100 | 1 NR | TUBO FLESSIBILE | FLEXIBLE PIPE | TUYAU FLEXIBLE | SCHLAUCH | TUBO FLEXIBLE |
| 3 277100H2 | 1 NR | CILINDRO TERZO BRACCIO LL1570-X15JP-X4 30AJ | THIRD CYLINDER BOOM LL1570-X15JP-X4 30AJ | CYLINDRE TROISIÈME BRAS | ZYLINDER DRITTER ARM | CILINDRO TERCERO BRAZO |

Go to Discount-Equipment.com to order your parts

 IMPIANTO IDRAULICO SFILATO

 TELESCOPIC HYDRAULIC SYSTEM

 TELESCOPIQUE HIDRAULIQUE

TELESKOPHYDRAULIK 

INSTALACIÓN EXTENSIÓN HIDRÁULICA 

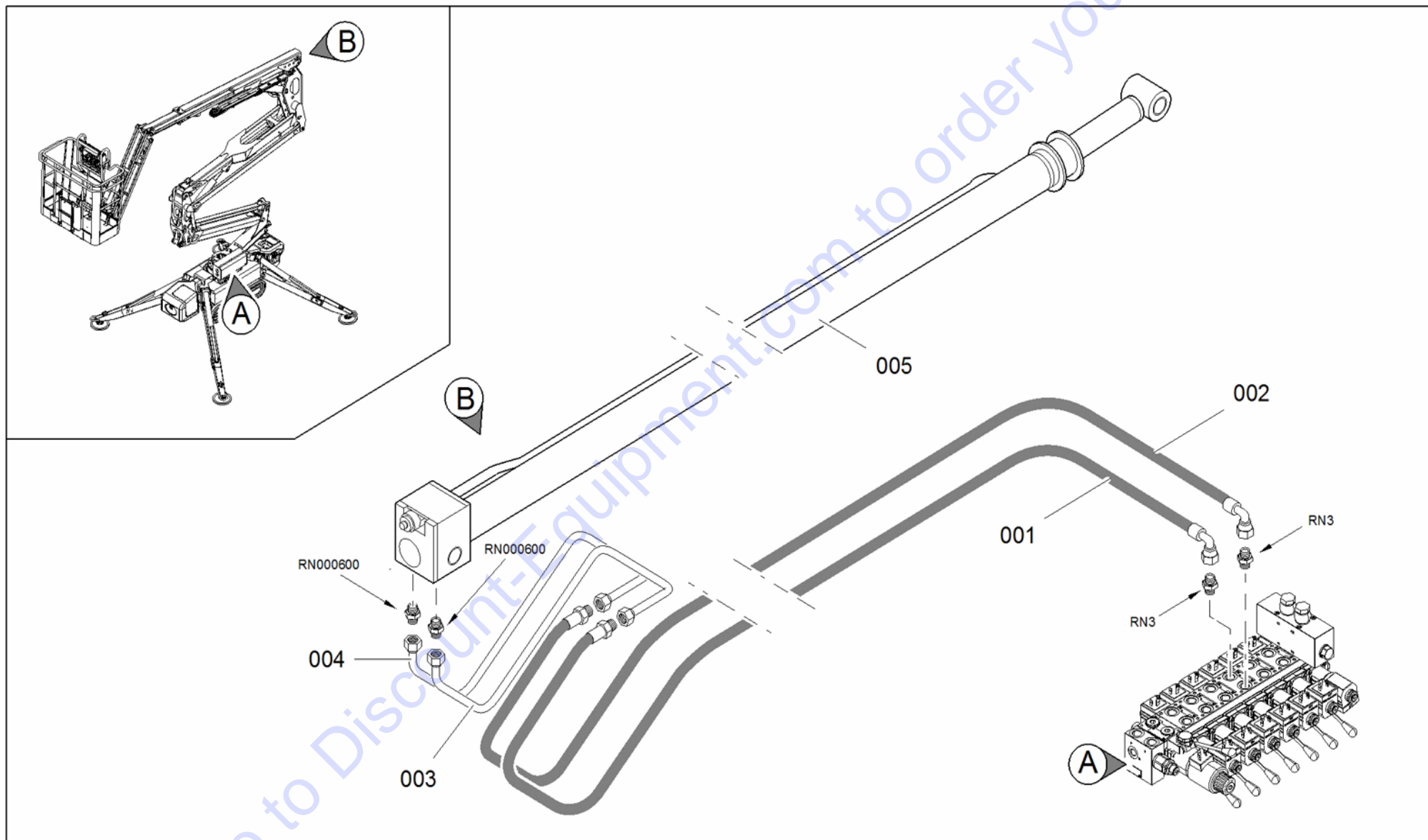





 IMPIANTO IDRAULICO SFILO

TELESKOPHYDRAULIK 

 TELESCOPIC HYDRAULIC SYSTEM

INSTALACIÓN EXTENSIÓN HIDRÁULICA 

 TELESCOPIQUE HIDRAULIQUE

| POS Codice | Q.tà |  Descrizione |  Description |  Designation |  Benennung |  Descripcìon |
|------------|------|---|---|---|---|---|
| 1 07785200 | 1 NR | TUBO FLESSIBILE | FLEXIBLE PIPE | TUYAU FLEXIBLE | SCHLAUCH | TUBO FLEXIBLE |
| 2 07785300 | 1 NR | TUBO FLESSIBILE | FLEXIBLE PIPE | TUYAU FLEXIBLE | SCHLAUCH | TUBO FLEXIBLE |
| 3 07753700 | 1 NR | TUBO RIGIDO | RIGID PIPE | TUYAU | SCHLAUCH | TUBO |
| 4 07753800 | 1 NR | TUBO RIGIDO | RIGID PIPE | TUYAU | SCHLAUCH | TUBO |
| 5 277101H2 | 1 NR | CILINDRO SFILO LL1570 | CYLINDER EXTENSION LL1570 | CYLINDRE | ZYLINDER | CILINDRO |

 IMPIANTO JIB

ZYLINDER JIB ARM 

 JIB HYDRAULIC SYSTEM

INSTALACIÓN HIDRÁULICA JIB 

 SYSTÈME HYDRAULIQUE JIB

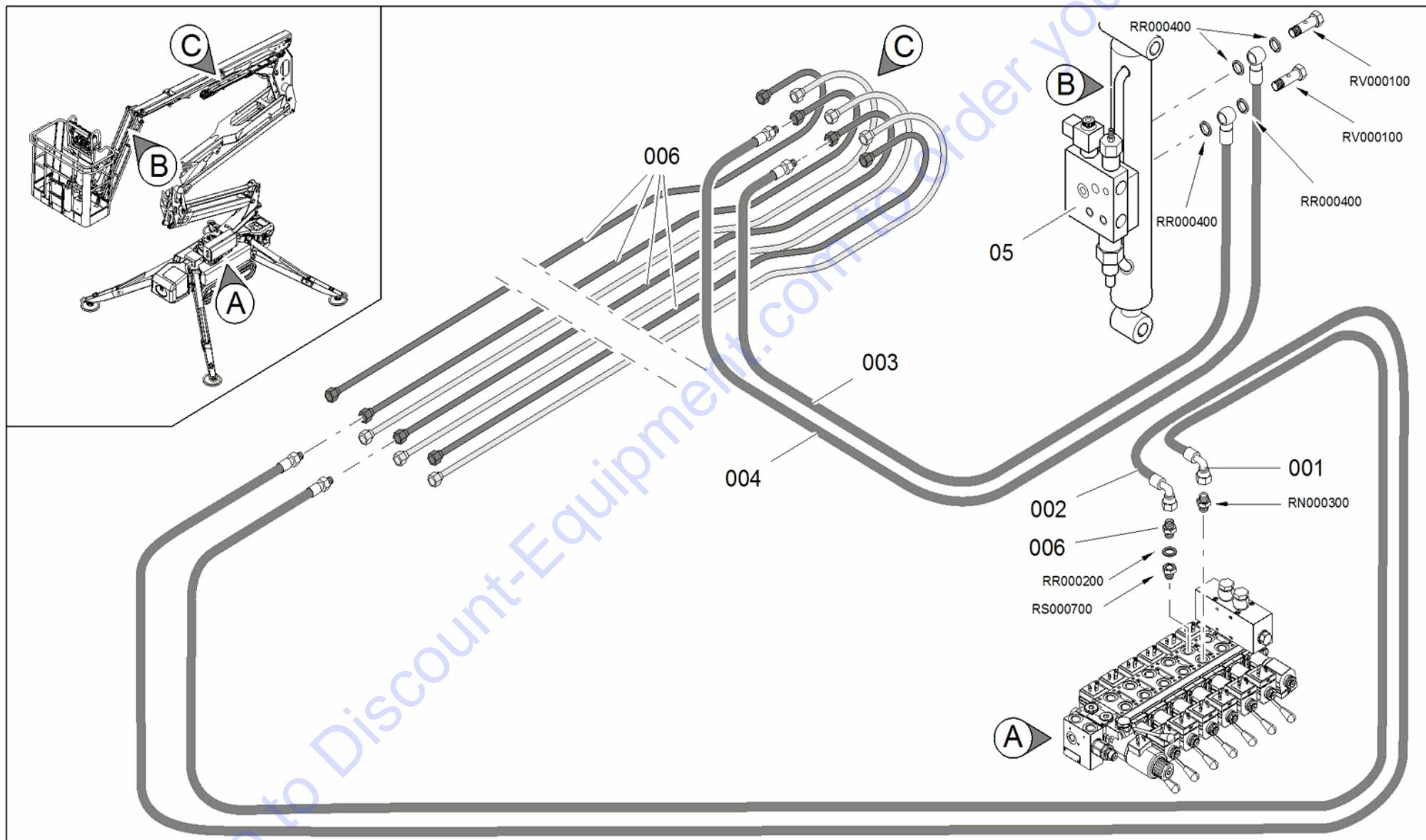





 IMPIANTO JIB

ZYLINDER JIB ARM 

 JIB HYDRAULIC SYSTEM

INSTALACIÓN HIDRÁULICA JIB 

 SYSTÈME HYDRAULIQUE JIB

| POS Codice | Q.tà |  Descrizione |  Description |  Designation |  Benennung |  Descripcìon |
|------------|------|---|---|---|---|---|
| 1 07785700 | 1 NR | TUBO FLESSIBILE | FLEXIBLE PIPE | TUYAU FLEXIBLE | SCHLAUCH | TUBO FLEXIBLE |
| 2 07785600 | 1 NR | TUBO FLESSIBILE | FLEXIBLE PIPE | TUYAU FLEXIBLE | SCHLAUCH | TUBO FLEXIBLE |
| 3 07786400 | 1 NR | TUBO FLESSIBILE | FLEXIBLE PIPE | TUYAU FLEXIBLE | SCHLAUCH | TUBO FLEXIBLE |
| 4 07786300 | 1 NR | TUBO FLESSIBILE | FLEXIBLE PIPE | TUYAU FLEXIBLE | SCHLAUCH | TUBO FLEXIBLE |
| 5 270695H2 | 1 NR | CILINDRO JIB | JIB CYLINDER | CYLINDRE JIB | KORBARMZYLINDER | CILINDRO JIB |
| 6 07753900 | 4 NR | TUBO RIGIDO | RIGID PIPE | TUYAU | SCHLAUCH | TUBO |

 IMPIANTO IDRAULICO LIVELLAMENTO

HYDRAULIKANLAGE ZYLINDER ARM 

 LEVELING CYLINDERS HYDRAULIC SYSTEM

INSTALACIÓN HIDRÁULICA CILINDROS BRAZOS 

 SYSTÈME HYDRAULIQUE CYLINDRES BRAS

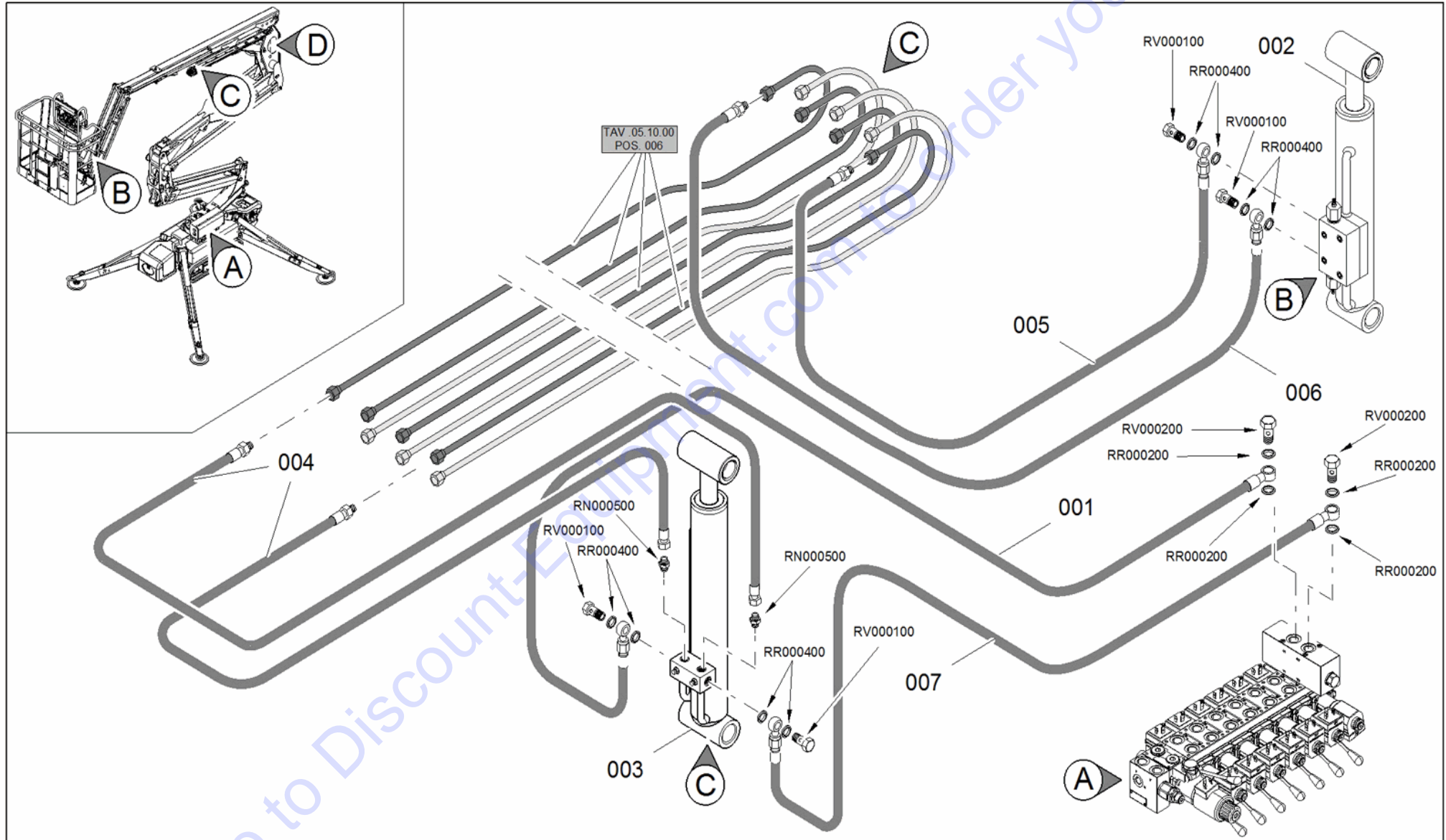





 IMPIANTO IDRAULICO LIVELLAMENTO

HYDRAULIKANLAGE ZYLINDER ARM 

 LEVELING CYLINDERS HYDRAULIC SYSTEM

INSTALACIÓN HIDRÁULICA CILINDROS BRAZOS 

 SYSTÈME HYDRAULIQUE CYLINDRES BRAS

| POS Codice | Q.tà |  Descrizione |  Description |  Designation |  Benennung |  Descripcìon |
|------------|------|---|---|---|---|---|
| 1 07784900 | 1 NR | TUBO FLESSIBILE | FLEXIBLE PIPE | TUYAU FLEXIBLE | SCHLAUCH | TUBO FLEXIBLE |
| 2 273151H2 | 1 NR | CILINDRO LIVELLAMENTO CESTO SU CESTO | LEVELING CYLINDER BASKET ON BASKET | CYLINDRE NIVELLEMENT PANIER SUR PANIER | ZYLINDER KORBNIVELLIERU NG | CILINDRO NIVELACIÓN CESTA |
| 3 270693H2 | 1 NR | CILINDRO LIVELLAMENTO CESTO | BASKET LEVELLING CYLINDER | CYLINDRE NIVELLEMENT PANIER | ZYLINDER KORBNIVELLIERU NG | CILINDRO NIVELACIÓN CESTA |
| 4 07786000 | 2 NR | TUBO FLESSIBILE | FLEXIBLE PIPE | TUYAU FLEXIBLE | SCHLAUCH | TUBO FLEXIBLE |
| 5 07786200 | 1 NR | TUBO FLESSIBILE | FLEXIBLE PIPE | TUYAU FLEXIBLE | SCHLAUCH | TUBO FLEXIBLE |
| 6 07786100 | 1 NR | TUBO FLESSIBILE | FLEXIBLE PIPE | TUYAU FLEXIBLE | SCHLAUCH | TUBO FLEXIBLE |
| 7 07784800 | 1 NR | TUBO FLESSIBILE | FLEXIBLE PIPE | TUYAU FLEXIBLE | SCHLAUCH | TUBO FLEXIBLE |

 IMPIANTO IDRAULICO ROTAZIONE CESTO

HYDRAULIKANLAGE KORBSCHWENKUNG 

 CAGE ROTATION HYDRAULIC SYSTEM

INSTALACIÓN HIDRÁULICA ROTACIÓN CESTA 

 SYSTÈME HYDRAULIQUE ROTATION PANIER

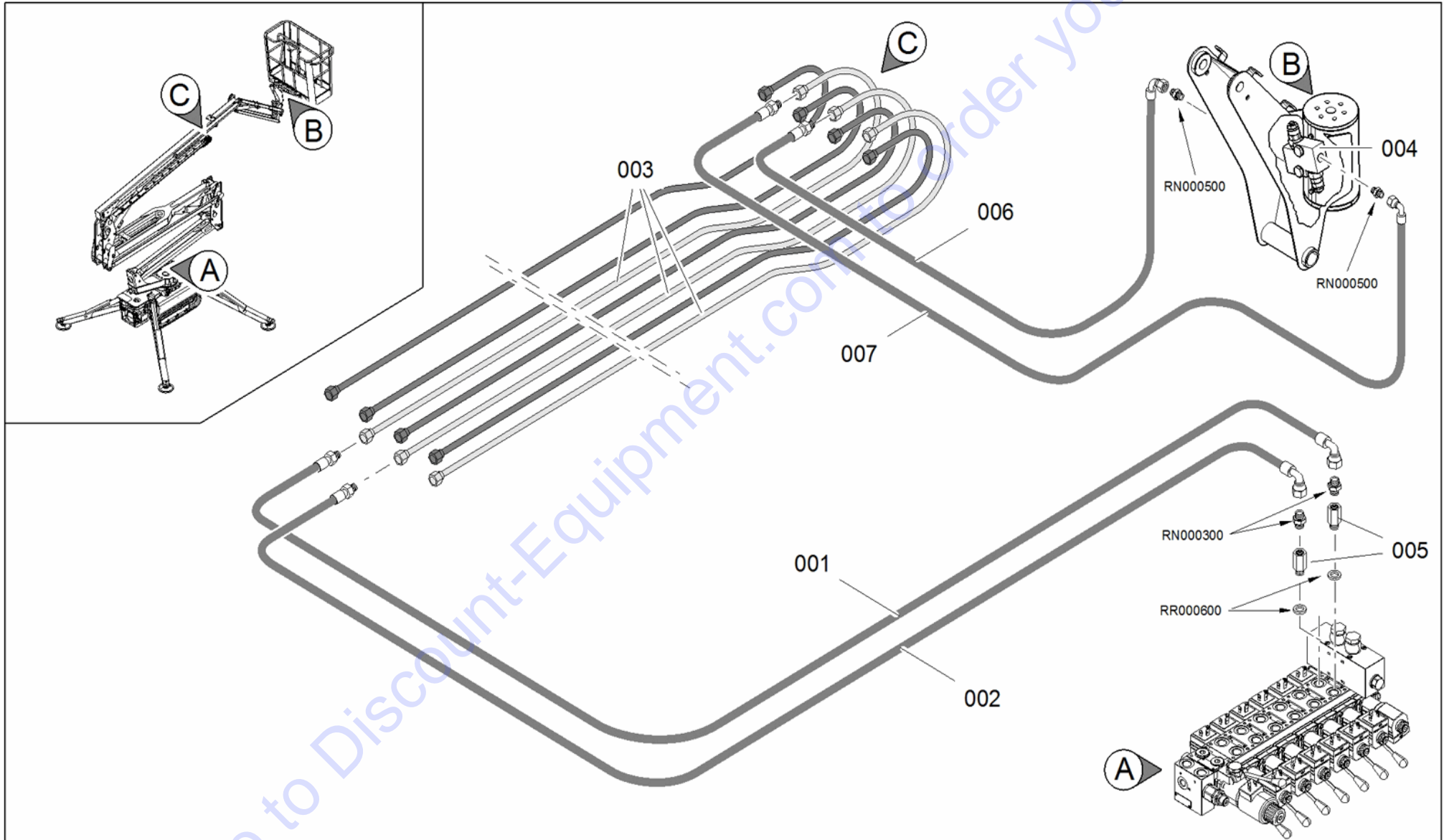





 IMPIANTO IDRAULICO ROTAZIONE CESTO

HYDRAULIKANLAGE KORBSCHWENKUNG 

 CAGE ROTATION HYDRAULIC SYSTEM

INSTALACIÓN HIDRÁULICA ROTACIÓN CESTA 

 SYSTÈME HYDRAULIQUE ROTATION PANIER

| POS Codice | Q.tà |  Descrizione |  Description |  Designation |  Benennung |  Descripción |
|--------------|------|---|---|---|---|---|
| 1 07785800 | 1 NR | TUBO FLESSIBILE | FLEXIBLE PIPE | TUYAU FLEXIBLE | SCHLAUCH | TUBO FLEXIBLE |
| 2 07785900 | 1 NR | TUBO FLESSIBILE | FLEXIBLE PIPE | TUYAU FLEXIBLE | SCHLAUCH | TUBO FLEXIBLE |
| 3 07754000 | 3 NR | TUBO RIGIDO | RIGID PIPE | TUYAU | SCHLAUCH | TUBO |
| 4 2648910001 | 1 NR | VALVOLA IDRAULICA | HYDRAULIC VALVE | VALVE HYDRAULIQUE | HYDRAULIKVENTIL | VÁLVULA HIDRÁULICA |
| 5 03149500 | 2 NR | RACCORDO A COLONNA 3/8" H=20 | EXTENSION 3/8" H=20 | RACCORD | ANSCHLUSS | CONEXIÓN |
| 6 07786500 | 1 NR | TUBO FLESSIBILE | FLEXIBLE PIPE | TUYAU FLEXIBLE | SCHLAUCH | TUBO FLEXIBLE |
| 7 07786600 | 1 NR | TUBO FLESSIBILE | FLEXIBLE PIPE | TUYAU FLEXIBLE | SCHLAUCH | TUBO FLEXIBLE |

Go to Discount-Equipment.com to order your parts

 IMPIANTO IDRAULICO ARIA COMPRESSA

 COMPRESSED AIR HYDRAULIC SYSTEM

 SYSTÈME HYDRAULIQUE AIR COMPRIMÉ

HYDRAULIKANLAGE DRUCKLUFT 

INSTALACIÓN HIDRÁULICA AIRE COMPRIMIDO 

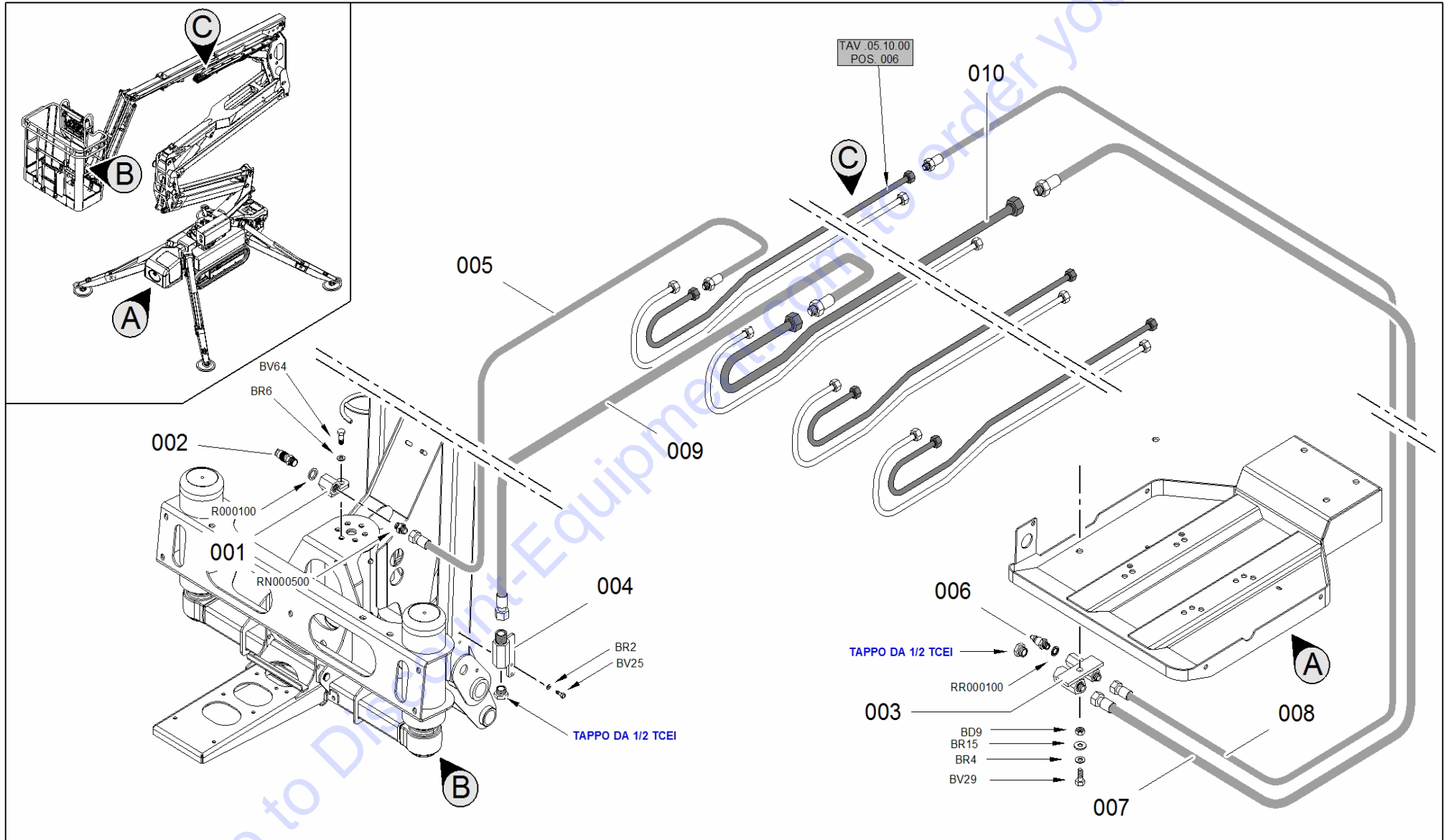





 IMPIANTO IDRAULICO ARIA COMPRESSA

HYDRAULIKANLAGE DRUCKLUFT 

 COMPRESSED AIR HYDRAULIC SYSTEM

INSTALACIÓN HIDRÁULICA AIRE COMPRIMIDO 

 SYSTÈME HYDRAULIQUE AIR COMPRIMÉ

| POS Codice | Q.tà |  Descrizione |  Description |  Designation |  Benennung |  Descripción |
|-------------|------|---|---|---|---|---|
| 1 04845100 | 1 NR | SUPPORTO | SUPPORT | SUPPORT | HALTERUNG | SOPORTE |
| 2 05509900 | 1 NR | INNESTO RAPIDO | QUICK COUPLING | RACCORD RAPIDE | SCHNELLKUPPLUNG | CONEXIÓN RÁPIDA |
| 3 07611000 | 1 NR | RACCORDO | PIPE FITTING | TUYAU | ANSCHLUSS | MANGUITO |
| 4 07611100 | 1 NR | RACCORDO | HOSE FITTING | TUYAU | ANSCHLUSS | CONEXIÓN |
| 5 07786700 | 1 NR | TUBO FLESSIBILE | FLEXIBLE PIPE | TUYAU FLEXIBLE | SCHLAUCH | TUBO FLEXIBLE |
| 6 05580200 | 1 NR | RUBINETTO | FAUCET | ROBINET | WASSERHAHN | GRIFO |
| 7 07785400 | 1 NR | TUBO FLESSIBILE | FLEXIBLE PIPE | TUYAU FLEXIBLE | SCHLAUCH | TUBO FLEXIBLE |
| 8 07785500 | 1 NR | TUBO FLESSIBILE | FLEXIBLE PIPE | TUYAU FLEXIBLE | SCHLAUCH | TUBO FLEXIBLE |
| 9 07786800 | 1 NR | TUBO FLESSIBILE | FLEXIBLE PIPE | TUYAU FLEXIBLE | SCHLAUCH | TUBO FLEXIBLE |
| 10 07754100 | 1 NR | TUBO RIGIDO | RIGID PIPE | TUYAU | SCHLAUCH | TUBO |

 CILINDRI

ZYLINDER 

 CYLINDERS

CILINDROS 



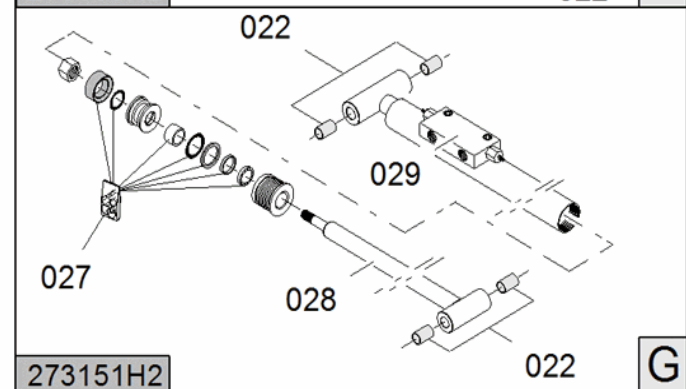
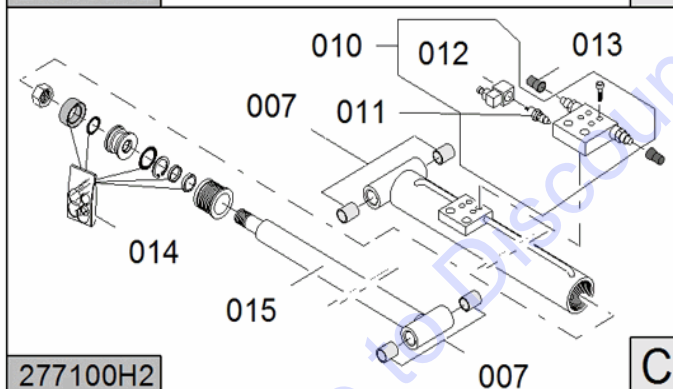
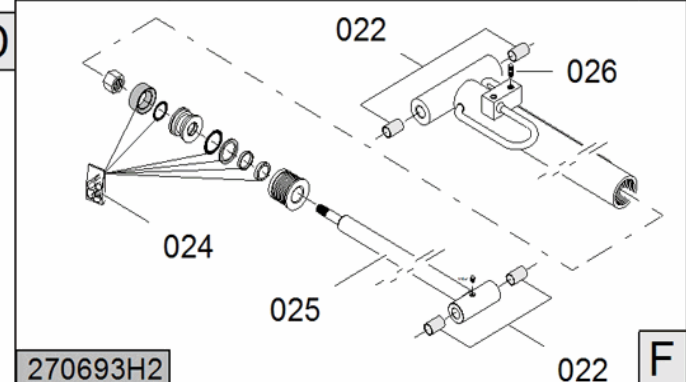
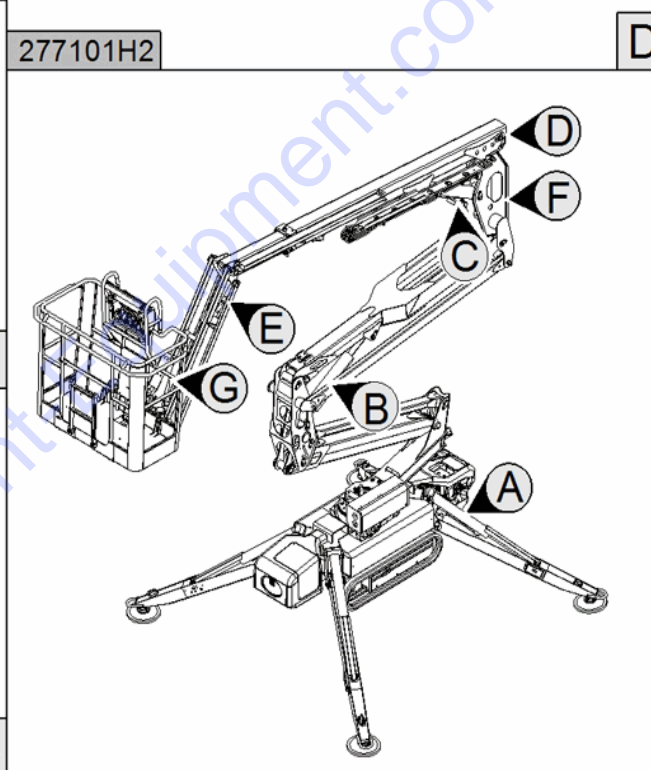
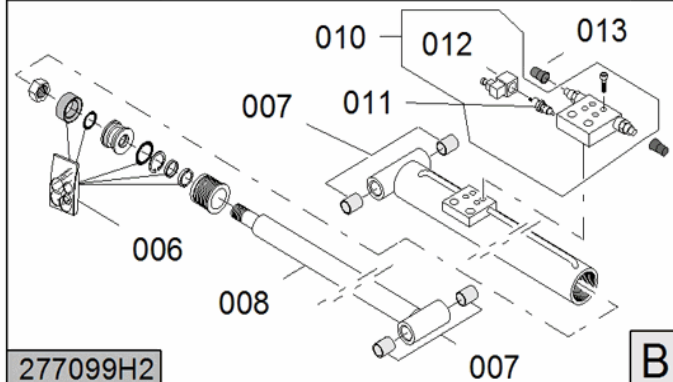
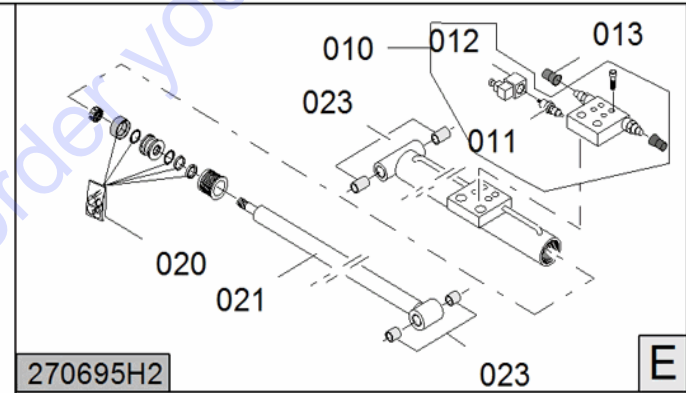
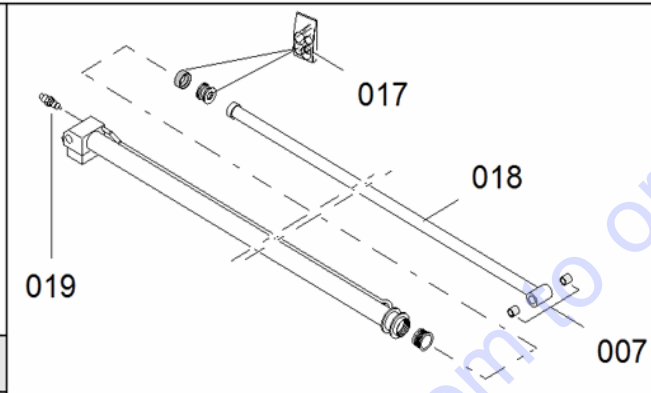
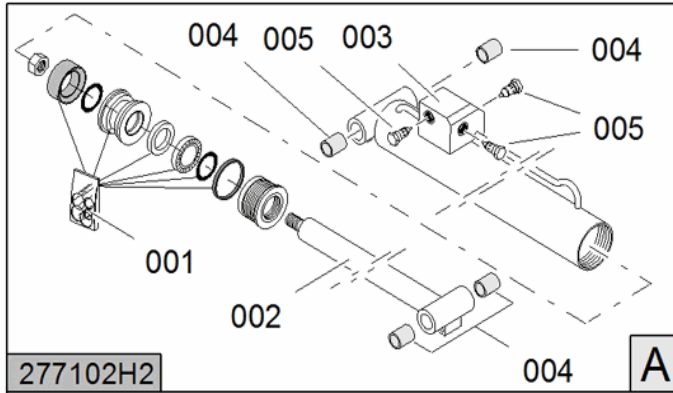

 CYLINDRES



 CILINDRI

 ZYLINDER 
 CYLINDERS





 CILINDROS 
 CYLINDRES

| POS Codice | Q.tà |  Descrizione |  Description |  Designation |  Benennung |  Descripción |
|--------------|------|---|---|---|---|---|
| 1 2771020003 | 1 NR | KIT GUARNIZIONI CILINDRO STABILIZZATORE LL1570-X15JP-X4 30AJ | SEAL KIT CYLINDER STABILIZER LL1570-X15JP-X4 30AJ | KIT JOINTS | DICHTUNGSSATZ | KIT JUNTAS |
| 2 2771020001 | 1 NR | STELO CILINDRO STABILIZZATORE LL1570-X15JP-X4 30AJ | ROD CYLINDER STABILIZER LL1570-X15JP-X4 30AJ | TIGE CYLINDRE | ZYLINDERSCHAF T | VÁSTAGO CILINDRO |
| 3 2705540002 | 1 NR | BLOCCHETTO | BLOCK | BLOC | BLOCK | BLOQUE |
| 4 07765500 | 4 NR | BOCCOLA | BUSH | DOUILLE | BUCHSE | CASQUILLO |
| 5 1541150011 | 3 NR | VALVOLA IDRAULICA | HYDRAULIC VALVE | VALVE HYDRAULIQUE | HYDRAULIKVENTI L | VÁLVULA HIDRÁULICA |
| 6 2770990002 | 1 NR | KIT GUARNIZIONI CILINDRO BRACCIO 1 LL1570-X15JP-X4 30AJ | SEAL KIT CYLINDER FIRST BOOM LL1570-X15JP-X4 30AJ | KIT JOINTS | DICHTUNGSSATZ | KIT JUNTAS |
| 7 07765200 | 4 NR | BOCCOLA DEVA.TEX552 303530 | BUSH DEVA.TEX 552 303530 | DOUILLE | BUCHSE | CASQUILLO |
| 8 2770990001 | 1 NR | STELO CILINDRO BRACCIO 1 LL1570-X15JP-X4 30AJ | ROD CYLINDER FIRST BOOM LL1570-X15JP-X4 30AJ | TIGE CYLINDER | ZYLINDERSCHAF T | VÁSTAGO CILINDRO |

 CILINDRI

 ZYLINDER 
 CYLINDERS





 CILINDROS 
 CYLINDRES

| POS Codice | Q.tà |  Descrizione |  Description |  Designation |  Benennung |  Descripcìon |
|---------------|------|---|---|---|---|---|
| 10 26119300 | 1 NR | VALVOLA IDRAULICA | HYDRAULIC VALVE | VALVE HYDRAULIQUE | HYDRAULIKVENTI L | VÁLVULA HIDRÁULICA |
| 11 0552550001 | 1 NR | ELETTROVALVOL A | SOLENOID VALVE | ÉLECTROVANNE | MAGNETVENTIL | ELECTROVÁLVU LA |
| 12 0552550003 | 1 NR | BOBINA | COIL | BOBINE | SPULE | BOBINA |
| 13 05576200 | 6 NR | PROTEZIONE | PROTECTION | PROTECTION | SCHUTZ | PROTECCIÓN |
| 14 2771000002 | 1 NR | KIT GUARNIZIONI CILINDRO BRACCIO 3 LL1570-X15JP-X4 30AJ | SEAL KIT CYLINDER THIRD BOOM LL1570-X15JP-X4 30AJ | KIT JOINTS | DICHTUNGSSATZ | KIT JUNTAS |
| 15 2771000001 | 1 NR | STELO CILINDRO BRACCIO 3 LL1570-X15JP-X4 30AJ | ROD CYLINDER THIRD BOOM LL1570-X15JP-X4 30AJ | TIGE CYLINDRE | ZYLINDERSCHAF T | VÁSTAGO CILINDRO |
| 17 2771010002 | 1 NR | KIT GUARNIZIONI CILINDRO SFILO LL1570-X15JP-X4 30AJ | SEAL KIT CYLINDER SFILO LL1570-X15JP-X4 30AJ | KIT JOINTS | DICHTUNGSSATZ | KIT JUNTAS |
| 18 2771010001 | 1 NR | STELO CILINDRO SFILO LL1570-X15JP-X4 30AJ | ROD CYLINDER SFILO LL1570-X15JP-X4 30AJ | TIGE CYLINDRE | ZYLINDERSCHAF T | VÁSTAGO CILINDRO |
| 19 2630690003 | 1 NR | VALVOLA IDRAULICA | HYDRAULIC VALVE | VALVE HYDRAULIQUE | HYDRAULIKVENTI L | VÁLVULA HIDRÁULICA |





 CILINDRI

 ZYLINDER 
 CYLINDERS

 CILINDROS 
 CYLINDRES

| POS Codice | Q.tà |  Descrizione |  Description |  Designation |  Benennung |  Descripción |
|---------------|------|---|---|---|---|---|
| 20 2706950001 | 1 NR | KIT GUARNIZIONI CILINDRO JIB | SEAL KIT CYLINDER JIB | KIT DE JOINTS | DICHTUNGSSATZ | KIT JUNTAS CILINDRO JIB |
| 21 2706950002 | 1 NR | STELO CILINDRO JIB | ROD CYLINDER JIB | TIGE DE CYLINDRE JIB | KORBARM ZYLINDERSCHAF T | VASTAGO CILINDRO JIB |
| 22 2627890006 | 4 NR | BOCCOLA | BUSH | DOUILLE | BUCHSE | CASQUILLO |
| 23 2627910006 | 4 NR | BOCCOLA | BUSH | DOUILLE | BUCHSE | CASQUILLO |
| 24 2706930001 | 1 NR | KIT GUARNIZIONI CILINDRO LIVELLAMENTO SU RINVIO | CYLINDER GASKET KIT | KIT DE JOINTS CYLINDRE NIVELLEMENT | DICHTSATZ ZYLINDER AUSNIVELLIERUN G | KIT DE JUNTAS CILINDRO NIVELACIÓN |
| 25 2706930002 | 1 NR | STELO CILINDRO LIVELLAMENTO SU RINVIO | ROD CYLINDER | TIGE CYLINDRE | ZYLINDERSCHAF T | VASTAGO CILINDRO |
| 26 2588290008 | 2 NR | VITE | SCREW | VIS | SCHRAUBE | TORNILLO |
| 27 2706940001 | 1 NR | KIT GUARNIZIONI CILINDRO LIVELLAMENTO SU CESTO | CYLINDER GASKET KIT | KIT DE JOINTS CYLINDRE NIVELLEMENT | DICHTSATZ | KIT JUNTAS |
| 28 2706940002 | 1 NR | STELO CILINDRO LIVELLAMENTO SU CESTO | BASKET LEVELING CYLINDER ROD ON BASKET | CYLINDRE TIGE | ZYLINDERSCHAF T | VASTAGO CILINDRO |

 CILINDRIZYLINDER  CYLINDERSCILINDROS  CYLINDRES

| POS Codice | Q.tà |  Descrizione |  Description |  Designation |  Benennung |  Descripcìon |
|---------------|------|---|---|---|---|---|
| 29 2731510003 | 1 NR | VALVOLA IDRAULICA | HYDRAULIC VALVE | VALVE HYDRAULIQUE | HYDRAULIKVENTI L | VÁLVULA HIDRÁULICA |

Go to Discount-Equipment.com to order your parts

 COMPONENTI IMPIANTO ELETTRICO

KOMPONENTEN ELEKTROANLAGE 

 ELECTRICAL SYSTEM COMPONENTS

COMPONENTES INSTALACIÓN ELÉCTRICA 



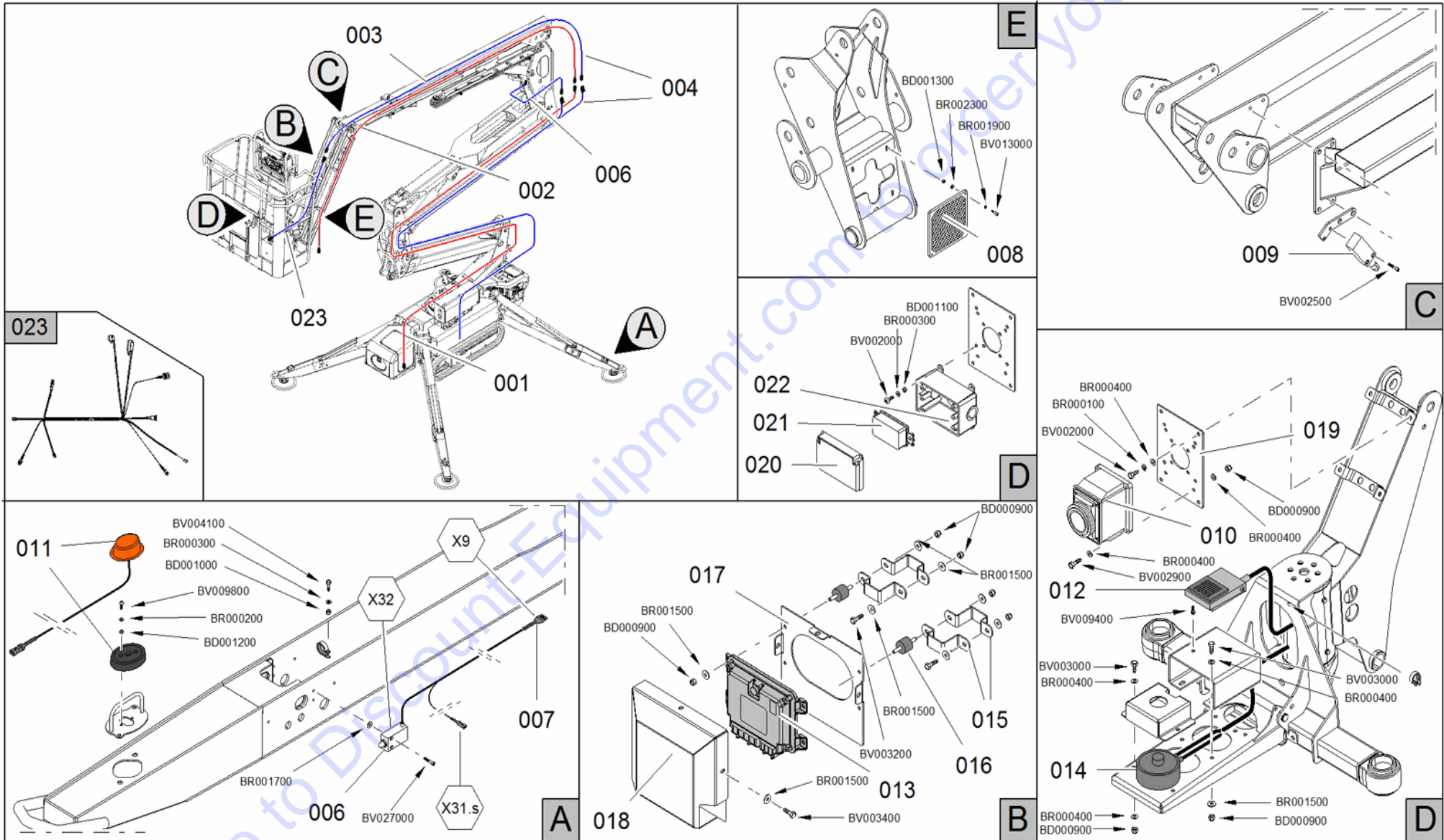

 COMPOSANTS INSTALLATION ÉLECTRIQUE



 COMPONENTI IMPIANTO ELETTRICO

 KOMponenten ELEKTROANLAGE 
 ELECTRICAL SYSTEM COMPONENTS

 COMPONENTES INSTALACIÓN ELÉCTRICA 
 COMPOSANTS INSTALLATION ÉLECTRIQUE

| POS Codice | Q.tà |  Descrizione |  Description |  Designation |  Benennung |  Descripcìon |
|--------------|------|---|---|---|---|---|
| 1 1764290002 | 1 NR | CAVO PROLUNGA 220-110V DA BASE A PRIMO BRACCIO MK2 (DA C170000893) | EXTENSION CABLE 220V-110V FROM BASE TO 1 BOOM MK2 (FROM C170000893) | CÂBLE | KABEL | CABLE |
| 2 1772950013 | 1 NR | CAVO PROLUNGA 220-110V SFILO LL1570-X15JP-X4 30AJ | EXTENSION CABLE 220V-110V EXTENSION BOOM LL1570-X15JP-X4 30AJ | CÂBLE | KABEL | CABLE |
| 3 1772950014 | 1 NR | CAVO PROLUNGA 7 POLI SFILO LL1570-X15JP-X4 30AJ | EXTENSION CABLE 7 WIRES EXTENSION BOOM LL1570-X15JP-X4 30AJ | CÂBLE | KABEL | CABLE |
| 4 1730720008 | 1 NR | CAVO 7 POLI LL1775/200 DA BASE A CESTO | 7-POLE CABLE LL1775/200 FROM BASE TO BASKET | CABLE AVEC 7 FILS DE LA BASE JUSQU'A LE PANIER | | |





 COMPONENTI IMPIANTO ELETTRICO

 KOMponenten ELEKTROANLAGE

 ELECTRICAL SYSTEM COMPONENTS

 COMPONENTES INSTALACIÓN ELÉCTRICA

 COMPOSANTS INSTALLATION ÉLECTRIQUE

| POS Codice | Q.tà |  Descrizione |  Description |  Designation |  Benennung |  Descripción |
|---------------|------|---|---|---|---|---|
| 5 1730720094 | 1 NR | CAVO COMPLETO PER SENSORE DI POSIZIONE 3 CILINDRO BRACCIO | CABLE ASSEMBLY FOR POSITION SENSOR 3 BOOM CYLINDER | CÂBLE COMPLET POUR CAPTEUR DE POSITION 3° CYLINDRE BRAS | KABEL KOMPLETT FÜR POSITIONSENS OR 3. AUSLEGERARM-Z YLINDER | CABLE COMPLETO PARA SENSOR DE POSICIÓN 3ERO CILINDRO BRAZO |
| 6 1772950011 | 1 NR | MICROINTERRUTT ORE 2 CONTATTI NC/NO TESTINA PULSANTE CAVO LUNGO 2 METRI | MICRO SWITCH CONTACT 2 NC / NO BUTTON HEAD CABLE 2 METER | MICROINTERRUP TEUR | MIKROSCHALTER | MICROINTERRUP TOR |
| 7 1772950012 | 1 NR | CAVO PROLUNGA STABILIZZATORE LL1570-X15JP-X4 30AJ | EXTENSION CABLE STABILIZER LL1570-X15JP-X4 30AJ | CÂBLE | KABEL | CABLE |
| 8 1679890001 | 1 NR | CATARIFRANGEN TE 100X100 MM | REFLECTOR 100X100 MM | CATADIOPTRE | REFLEKTOR | CATADIÓPTRICO |
| 9 1679900012 | 1 NR | MICROINTERRUTT ORE 2 CONTATTI NC/NO TESTINA ROTELLA ACCIAIO CAVO LUNGO 5 METRI | MICRO SWITCH CONTACT 2 NC / NO HEAD STEEL WHEEL LONG CABLE 5 METER | MICROINTERRUP TEUR | MIKROSCHALTER | MICROINTERRUP TOR |
| 10 1585570005 | 1 NR | PRESA ELETTRICA 230V | ELECTRICAL SOCKET 230V | PRISE ÉLECTRIQUE | STECKDOSE | ENCHUFE ELÉCTRICO |





 COMPONENTI IMPIANTO ELETTRICO

 KOMponenten ELEKTROANLAGE

 ELECTRICAL SYSTEM COMPONENTS

 COMPONENTES INSTALACIÓN ELÉCTRICA

 COMPOSANTS INSTALLATION ÉLECTRIQUE

| POS Codice | Q.tà |  Descrizione |  Description |  Designation |  Benennung |  Descripción |
|---------------|------|---|---|---|---|---|
| 11 1757250023 | 1 NR | SPIA STABILIZZATORE LED COMPLETA DI CONNETTORE | LED LIGHT | TEMOIN LED | KONTROLLAMP E | INDICADOR LED |
| 12 1772950015 | 1 NR | INTERRUTTORE A PEDALE COMPLETO DI CAVO E CONNETTORE TRE VIE CONTATTO NC/NO | FOOT SWITCH COMPLETE WITH CABLE AND CONNECTOR THREE-WAY CONTACT NC/NO | INTERRUPTEUR | SCHALTER | INTERRUPTOR |
| 13 1772950016 | 1 NR | SCHEDA ELETTRONICA DI CONTROLLO 48XS PROGRAMMATA PER GESTIONE A RICAMBIO | ELECTRONIC BOARD OF CONTROL 48XS PROGRAMMED FOR SPARE PARTS | CARTE ÉLECTRONIQUE | ELEKTRONISCHE PLATINE | TARJETA ELECTRÓNICA |
| 14 17669800 | 1 NR | SENSORE CELLA DI CARICO 4-20MA COMPLETO DI CAVO E CONNETTORI M12 (MK2) | SENSOR LOAD CELL 4-20MA WITH CABLE AND CONNECTORS M12 (MK2 VERSION) | CELLULE DE CHARGE (MK2) | MESSDOSE (MK2) | CÉLULA DE CARGA (MK2) |





 COMPONENTI IMPIANTO ELETTRICO

 KOMponenten ELEKTROANLAGE

 ELECTRICAL SYSTEM COMPONENTS

 COMPONENTES INSTALACIÓN ELÉCTRICA

 COMPOSANTS INSTALLATION ÉLECTRIQUE

| POS Codice | Q.tà |  Descrizione |  Description |  Designation |  Benennung |  Descripción |
|-------------|------|---|---|---|---|---|
| 15 077090H2 | 8 NR | COLLARE FISSAGGIO SCHEDA CELLA DI CARICO TTC | COLLAR FIXING SHEET LOAD CELL TTC | BRIDE | BUNDRING | ABRAZADERA |
| 16 04152300 | 4 NR | SUPPORTO ELASTICO SUPERIORE RADIATORE - | SPRING SUPPORT | SUPPORT ELASTIQUE | FEDERAUFLAGE | SOPORTE ELASTICO |
| 16 04152300 | 7 NR | SUPPORTO ELASTICO SUPERIORE RADIATORE - | SPRING SUPPORT | SUPPORT ELASTIQUE | FEDERAUFLAGE | SOPORTE ELASTICO |
| 17 077091H2 | 1 NR | PIASTRA FISSAGGIO SCHEDA CELLA DI CARICO TTC | FIXING PLATE LOAD CELL CARD TTC | PLAQUE | PLATTE | PLACA |
| 18 077712H2 | 1 NR | CARTER PROTEZIONE SCHEDA CELLA DI CARICO TTC | CARTER PROTECTION CELL CARD LOAD TTC | CARTER | KURBELGEHÄUS E | CÁRTER |
| 19 077089H2 | 1 NR | PIASTRA FISSAGGIO PRESE SU CESTO TTC | FIXING PLATE PLUGS ON BASKET TTC | PLAQUE | PLATTE | PLACA |





 COMPONENTI IMPIANTO ELETTRICO

 KOMponenten ELEKTROANLAGE

 ELECTRICAL SYSTEM COMPONENTS

 COMPONENTES INSTALACIÓN ELÉCTRICA

 COMPOSANTS INSTALLATION ÉLECTRIQUE

| POS Codice | Q.tà |  Descrizione |  Description |  Designation |  Benennung |  Descripción |
|-------------|------|---|---|---|---|---|
| 20 27073800 | 1 NR | COVER PRESE USA AL CESTO, RECEPTACLE BOX PART N°:1671207 | COVER US SOCKETS TO BASKET, RECEPTACLE BOX PART N°:1671207 | PRETECTION | SCHUTZ | PROTECCIÓN |
| 21 27073900 | 1 NR | PLUG PRESE USA AL CESTO, RECEPTACLE PART N°:4460346 | US SOCKETS TO BASKET, RECEPTACLE PART N°:4460346 | PRISE | STECKDOSE | ENCHUFE |
| 22 27073700 | 1 NR | BOX PRESE USA AL CESTO, RECEPTACLE PART N°:0861731 | US SOCKET BOX TO BASKET, RECEPTACLE PART N°:0861731 | BOX PRISES | SCHACHTEL STECKDOSEN | CAJA ENCHUFES |
| 23 17729800 | 1 NR | KIT IMPIANTO ELETTRICO AL CESTO LL1570-X15JP-X4 30AJ | KIT ELECTRIC PLANT IN BASKET LL1570-X15JP-X4 30AJ | KIT ÉLECTRIQUE | ELEKTROSATZ | KIT ELÉCTRICO |

 COMPONENTI IMPIANTO ELETTRICO

 ELECTRICAL SYSTEM COMPONENTS

 COMPOSANTS INSTALLATION ÉLECTRIQUE

KOMPONENTEN ELEKTROANLAGE 



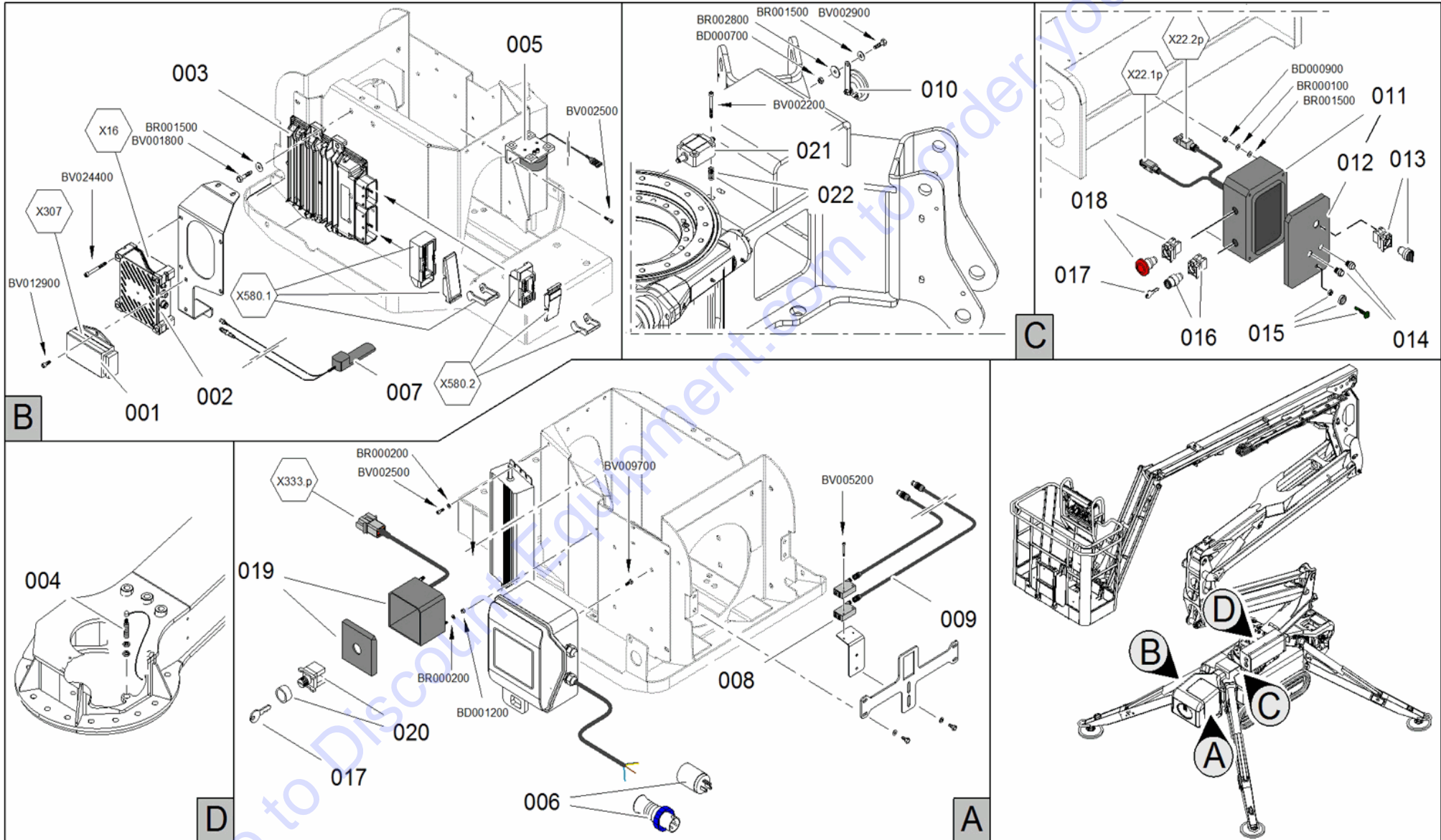

COMPONENTES INSTALACIÓN ELÉCTRICA 



 COMPONENTI IMPIANTO ELETTRICO

 KOMponenten ELEKTROANLAGE 
 ELECTRICAL SYSTEM COMPONENTS





 COMPONENTES INSTALACIÓN ELÉCTRICA 
 COMPOSANTS INSTALLATION ÉLECTRIQUE

| POS Codice | Q.tà |  Descrizione |  Description |  Designation |  Benennung |  Descripción |
|--------------|------|---|---|---|---|---|
| 1 1772950021 | 1 NR | CENTRALINA 4 RELE' INDIPENDENTI 12V A TENUTA | CONTROL UNIT 4 RELAY 'INDEPENDENT 12V SEALED | UNITÉ DE CONTRÔLE | STEUERGERÄT | UNIDAD DE CONTROL |
| 2 1772950017 | 1 NR | MODEM ESTERNO GPS-4G CAN PROGRAMMATO PER GESTIONE A RICAMBIO | MODEM GPS-4G CAN TO SPARE | MODEM | MODEM | MODEM |
| 3 1772950018 | 1 NR | SCHEDA ELETTRONICA DI CONTROLLO 580 PROGRAMMATA PER GESTIONE A RICAMBIO | ELECTRONIC BOARD OF CONTROL 580 PROGRAMMED FOR SPARE PARTS | CARTE ÉLECTRONIQUE | ELEKTRONISCHE PLATINE | TARJETA ELECTRÓNICA |
| 4 1651290010 | 1 NR | SENSORE DI PROSSIMITÀ | PROXIMITY SENSOR | CAPTEUR DE PROXIMITÉ | NÄHERUNGSSEN SOR | SENSOR DE PROXIMIDAD |
| 5 06639100 | 1 NR | AVVISATORE ACUSTICO | ACOUSTIC ALARM | BUZZER | SUMMER | ZUMBADOR |

 COMPONENTI IMPIANTO ELETTRICO

 KOMponenten ELEKTROANLAGE 
 ELECTRICAL SYSTEM COMPONENTS

 COMPONENTES INSTALACIÓN ELÉCTRICA 
 COMPOSANTS INSTALLATION ÉLECTRIQUE

| POS Codice | Q.tà |  Descrizione |  Description |  Designation |  Benennung |  Descripción |
|----------------|------|---|---|---|---|---|
| 6 1757250001 | 1 NR | SPINA VOLANTE 230V 16A | FREE PLUG 230V 16A | FICHE | STECKER | ENCHUFE |
| 6 1757250001 | 2 NR | SPINA VOLANTE 230V 16A | FREE PLUG 230V 16A | FICHE | STECKER | ENCHUFE |
| 6 1757250003 | 1 NR | SPINA VOLANTE 110V 16A | FREE PLUG 110V 16A | CHEVILLE | STIF | CLAVIJA |
| 6 27074000 | 1 NR | TERMINAL PRESA USA A TERRA, CONN PLUG PART N°:4460138 | TERMINAL GROUND SOCKET USA, CONN PLUG PART N °: 4460138 | CONNECTEUR | VERBINDER | CONECTOR |
| 7 27396100 | 1 NR | ANTENNA | AERIAL | ANTENNE | ANTENNE | ANTENA |
| 8 1591270001 | 1 NR | FOTOCPELLULA | PHOTOCELL | CELLULE PHOTO-ÉLECTRI QUE | PHOTOZELLE | FOTOCÉLULA |
| 9 159127000101 | 1 NR | CAVO ELETTRICO | ELECTRIC CABLE | CÂBLE ÉLECTRIQUE | ELEKTROKABEL | CABLE ELÉCTRICO |
| 10 04834500 | 1 NR | CLAXON | HORN | KLAXON | HORN | BOCINA |

PARTS FINDER

**Search Website
by Part Number**



**Search Manual
Library For Parts
Manual & Lookup Part
Numbers – Purchase
or Request Quote**

Search Manuals

Enter your information to help us find the right parts manual for your machine.

* Brand:

* Model:

* Serial:

* Part Number:

SEARCH

**Can't Find Part or
Manual? Request Help
by Manufacturer,
Model & Description**

Parts Order Form

Please fill in the following information to help us find the right part for your machine.

| | |
|---------------|----------------------|
| Manufacturer: | <input type="text"/> |
| Model: | <input type="text"/> |
| Description: | <input type="text"/> |
| Part Number: | <input type="text"/> |
| Quantity: | <input type="text"/> |
| Notes: | <input type="text"/> |

Submit

Discount-Equipment.com is your online resource for quality parts & equipment.

Florida: **561-964-4949** Outside Florida TOLL FREE: **877-690-3101**

Need parts?





Click on this link: <http://www.discount-equipment.com/category/5443-parts/> and choose one of the options to help get the right parts and equipment you are looking for. Please have the machine model and serial number available in order to help us get you the correct parts. If you don't find the part on the website or on one of the online manuals, please fill out the request form and one of our experienced staff members will get back to you with a quote for the right part that your machine needs.

We sell worldwide for the brands: Genie, Terex, JLG, MultiQuip, Mikasa, Essick, Whiteman, Mayco, Toro Stone, Diamond Products, Generac Magnum, Airman, Haulotte, Barreto, Power Blanket, Nifty Lift, Atlas Copco, Chicago Pneumatic, Allmand, Miller Curber, Skyjack, Lull, Skytrak, Tsurumi, Husquvarna Target, Stow, Wacker, Sakai, Mi-T-M, Sullair, Basic, Dynapac, MBW, Weber, Bartell, Bennar Newman, Haulotte, Ditch Runner, Menegotti, Morrison, Contec, Buddy, Crown, Edco, Wyco, Bomag, Laymor, EZ Trench, Bil-Jax, F.S. Curtis, Gehl Pavers, Heli, Honda, ICS/PowerGrit, IHI, Partner, Imer, Clipper, MMD, Koshin, Rice, CH&E, General Equipment, Amida, Coleman, NAC, Gradall, Square Shooter, Kent, Stanley, Tamco, Toku, Hatz, Kohler, Robin, Wisconsin, Northrock, Oztec, Toker TK, Rol-Air, APT, Wylie, Ingersoll Rand / Doosan, Innovatech, Con X, Ammann, Mecalac, Makinex, Smith Surface Prep, Small Line, Wanco, Yanmar

 COMPONENTI IMPIANTO ELETTRICO

 KOMponenten ELEKTROANLAGE 
 ELECTRICAL SYSTEM COMPONENTS

 COMPONENTES INSTALACIÓN ELÉCTRICA 
 COMPOSANTS INSTALLATION ÉLECTRIQUE

| POS Codice | Q.tà |  Descrizione |  Description |  Designation |  Benennung |  Descripción |
|-----------------|------|--|---|---|---|---|
| 11 1757260024 | 1 NR | SCATOLA STOP A TERRA DIESEL LL2614-X26JP-X7 70AJ COMPLETA DI CABLAGGIO E CONNETTORE | BOX WITH WIRING | BOÎTE AVEC CÂBLAGE | KASTEN MIT VERKABELUNG | CAJA CON CABLEADO |
| 11 175726002402 | 1 NR | COPERCHIO SCATOLA STOP A TERRA DIESEL LL2614-X26JP-X7 70AJ | BOX COVER | COUVERCLE BOÎTE | KASTENABDECK UNG | TAPA DE CAJA |
| 11 1757270002 | 1 NR | SCATOLA STOP A TERRA LITHIUM 83V COMPLETA DI CABLAGGIO E CONNETTORE | BOX WITH WIRING | BOÎTE AVEC CÂBLAGE | KASTEN MIT VERKABELUNG | CAJA CON CABLEADO |
| 12 175726002401 | 1 NR | COPERCHIO SCATOLA STOP A TERRA DIESEL LL2614-X26JP-X7 70AJ | BOX COVER | COUVERCLE BOÎTE | KASTENABDECK UNG | TAPA DE CAJA |
| 12 175727000201 | 1 NR | COPERCHIO SCATOLA STOP A TERRA LITHIUM 83V | BOX COVER | COUVERCLE BOÎTE | KASTENABDECK UNG | TAPA DE CAJA |
| 13 1556350068 | 1 NR | SELETTORE A LEVA 3 POSIZIONI | 3 POSITION LEVER SWITCH | SÉLECTEUR | WÄHLSCHALTER | SELECTOR |





 COMPONENTI IMPIANTO ELETTRICO

 KOMponenten ELEKTROANLAGE

 ELECTRICAL SYSTEM COMPONENTS

 COMPONENTES INSTALACIÓN ELÉCTRICA

 COMPOSANTS INSTALLATION ÉLECTRIQUE

| POS Codice | Q.tà |  Descrizione |  Description |  Designation |  Benennung |  Descripción |
|---------------|------|---|---|---|---|---|
| 14 1628400001 | 1 NR | PULSANTE | BUTTON | BOUTON | DRUCKKNOPF | BOTÓN |
| 15 1730720005 | 1 NR | SPIA VERDE PARTE AEREA GRANDE | BIG GREEN LIGHT AERIAL PART | VOYANT | KONTROLLLEUC HTE | INDICADOR |
| 16 1692150001 | 1 NR | BLOCCHETTO | BLOCK | BLOC | BLOCK | BLOQUE |
| 17 1651290015 | 1 NR | CHIAVE | KEY | CLÉ | SCHLÜSSEL | LLAVE |
| 18 1591270004 | 1 NR | PULSANTE | BUTTON | BOUTON | DRUCKKNOPF | BOTÓN |
| 19 1772950019 | 1 NR | SCATOLA ESCLUSIONE SICUREZZE COMPLETA TTC | BOX EXCLUSION SAFETY TTC | BOÎTE | GEHÄUSE | CAJA |
| 20 1585570006 | 1 NR | SELETTORE | SELECTOR | SÉLECTEUR | WÄHLSCHALTER | SELECTOR |
| 21 17708000 | 1 NR | INCLINOMETRO | INCLINOMETER | INCLINOMÈTRE | NEIGUNGSSENS OR | INCLINÓMETRO |
| 22 05444800 | 4 NR | MOLLA | SPRING | RESSORT | FEDER | MUELLE |
| 23 27074000 | 2 NR | TERMINAL PRESA USA A TERRA, CONN PLUG PART N°:4460138 | TERMINAL GROUND SOCKET USA, CONN PLUG PART N °: 4460138 | CONNECTEUR | VERBINDER | CONECTOR |

 COMPONENTI IMPIANTO ELETTRICO LITIO

KOMPONENTEN ELEKTROANLAGE LITHIUM 

 ELECTRICAL SYSTEM COMPONENTS LITHIUM

COMPONENTES INSTALACIÓN ELÉCTRICA LITHIUM 

 COMPOSANTS INSTALLATION ÉLECTRIQUE LITHIUM

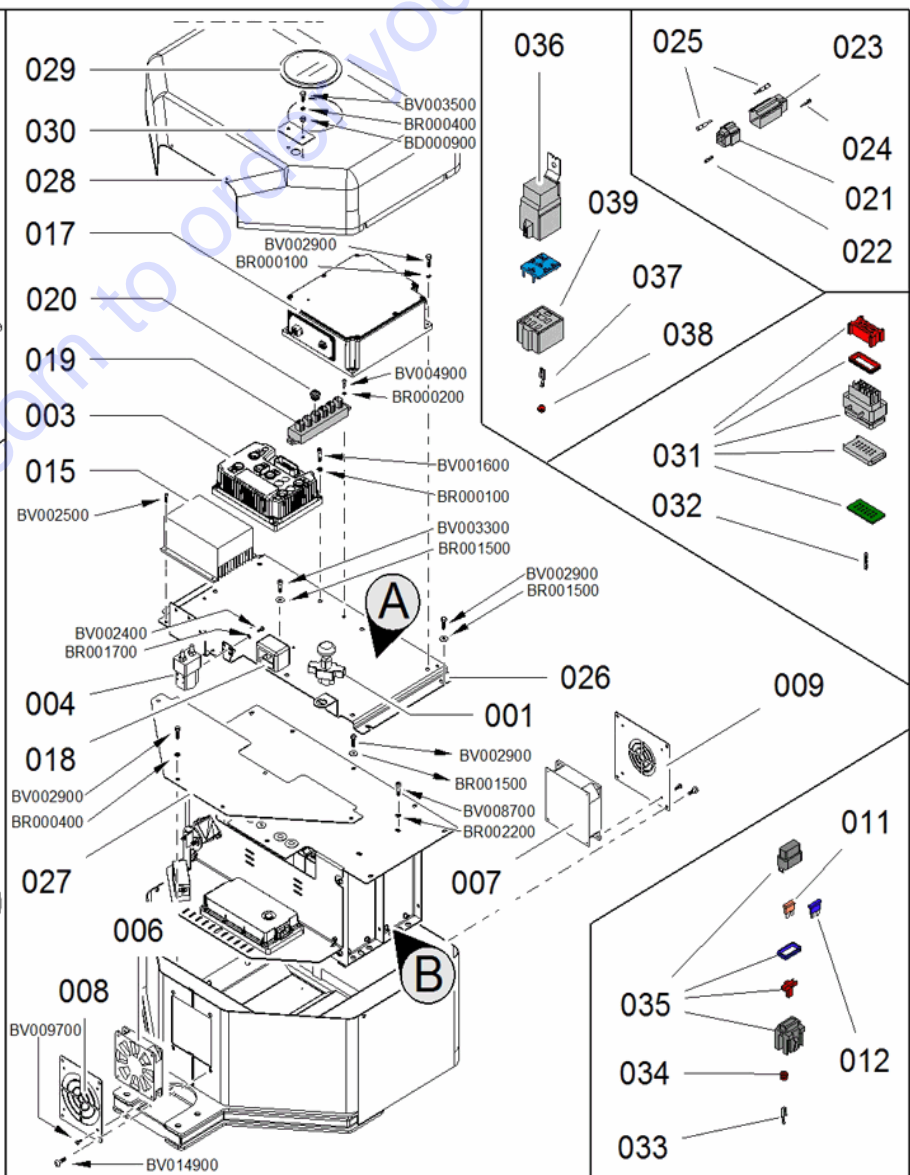
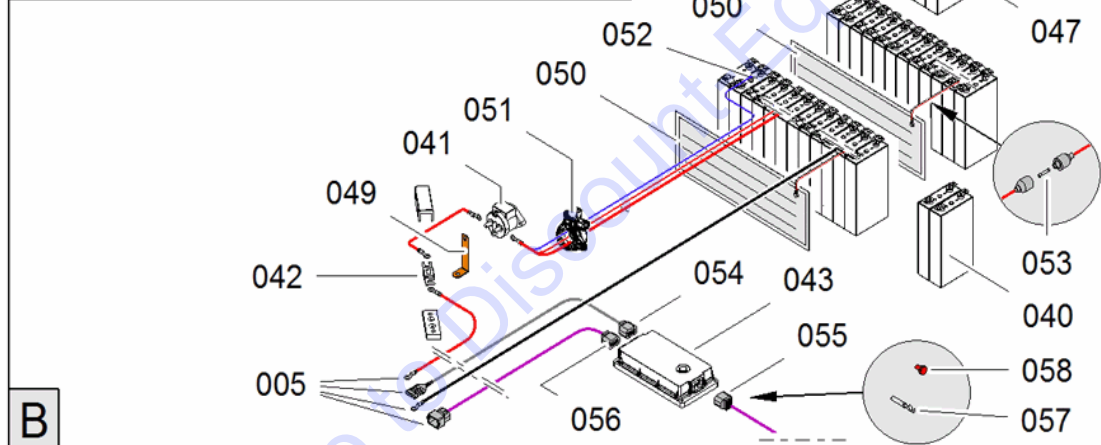
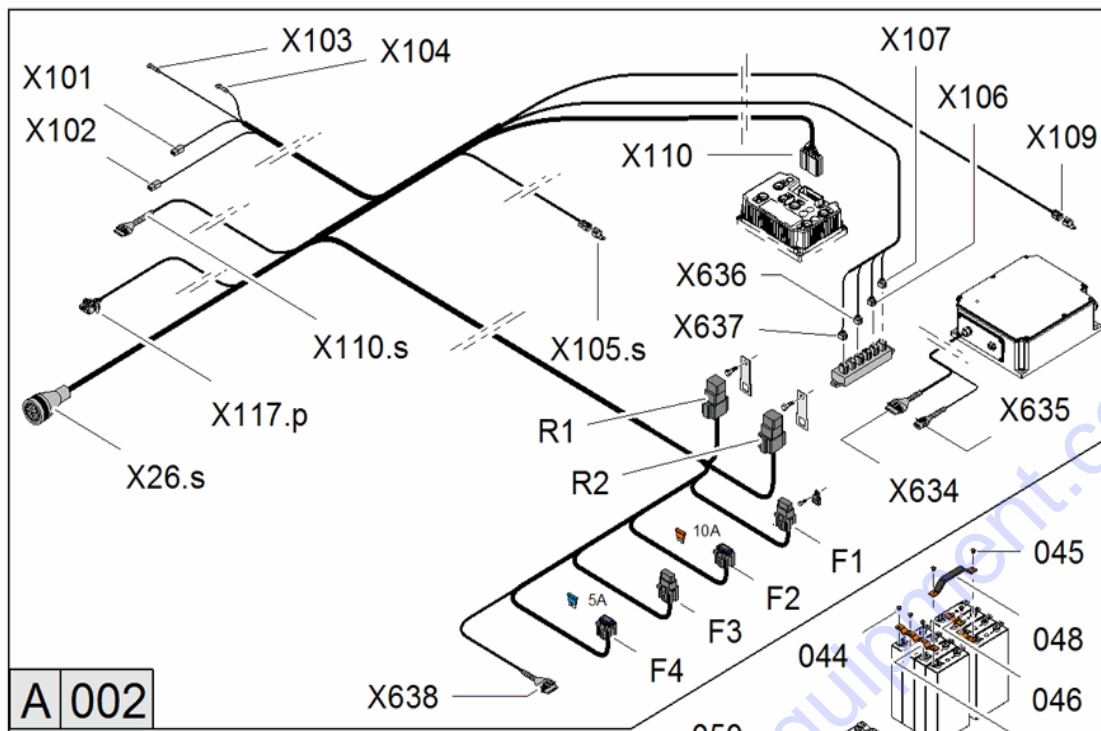





 COMPONENTI IMPIANTO ELETTRICO LITIO

 KOMponenten ELEKTROANLAGE LITHIUM

 ELECTRICAL SYSTEM COMPONENTS LITHIUM

 COMPONENTES INSTALACIÓN ELÉCTRICA LITHIUM

 COMPOSANTS INSTALLATION ÉLECTRIQUE LITHIUM

| POS Codice | Q.tà |  Descrizione |  Description |  Designation |  Benennung |  Descripción |
|--------------|------|---|---|---|---|---|
| 1 07827000 | 1 NR | STACCABATTERI A A FUNGO 150A NOMINALI | BATTERY DISCONNECTER S 150A NOMINAL | COUPE-BATTERI E | BATTERIE-TRENN SCHALTER | DESCONECTADO R DE BATERÍA |
| 2 17757200 | 1 NR | KIT ELE INTEGRAZIONE LITHIUM LL1570-X15JP-X4 30AJ | INTEGRATION KIT ELECTRIC LITHIUM LL1570-X15JP-X4 30AJ | KIT ÉLECTRIQUE | ELEKTROSATZ | KIT ELÉCTRICO |
| 3 26774600 | 1 NR | INVERTER | INVERTER | INVERTER | INVERTER | INVERTER |
| 4 26429300 | 1 NR | TELERUTTORE | REMOTE-CONTR OL SWITCH | TÉLÉRUPTEUR | FERNSCHALTER | TELERUPTOR |
| 5 27810200 | 1 NR | IMPIANTO ELETTRICO E PACCO BATTERIE LITIO 36V 100AH COMPLETO MID | ELECTRICAL SYSTEM AND BATTERY PACK LITHIUM 36V 100AH COMPLETE MID | INSTALLATION ÉLECTRIQUE | ELEKTRISCHE ANLAGE | INSTALACIÓN ELÉCTRICA |
| 6 1690690001 | 1 NR | VENTOLA ANTERIORE | FRONT FAN | VENTILATEUR | LÜFTERRAD | VENTILADOR |
| 7 1690690002 | 1 NR | VENTOLA POSTERIORE | REAR FAN | VENTILATEUR | LÜFTERRAD | VENTILADOR |
| 8 075692H2 | 1 NR | PIASTRA FISSAGGIO VENTOLA | PLATE | PLAQUE | PLATTE | PLACA |





 COMPONENTI IMPIANTO ELETTRICO LITIO

 KOMponenten ELEKTROANLAGE LITHIUM

 ELECTRICAL SYSTEM COMPONENTS LITHIUM

 COMPONENTES INSTALACIÓN ELÉCTRICA LITHIUM





 COMPOSANTS INSTALLATION ÉLECTRIQUE LITHIUM

| POS Codice | Q.tà |  Descrizione |  Description |  Designation |  Benennung |  Descripción |
|---------------|------|---|---|---|---|---|
| 9 067808H2 | 1 NR | TAPPO VENTOLA POSTERIORE | CAP REAR FAN | BOUCHON | VERSCHLUSS | TAPÓN |
| 11 05760700 | 2 NR | FUSIBILE A LAMA 5A | FUSE 5A | FUSIBLE 5A | SICHERUNG 5A | FUSIBLE 5A |
| 12 05760900 | 1 NR | FUSIBILE 10A | FUSE 10A | FUSIBLE 10A | SICHERUNG 10A | FUSIBLE 10A |
| 15 27032500 | 1 NR | TRASFORMATORE | TRANSFORMER | TRANSFORMATEUR | TRANSFORMATOR | TRANSFORMADOR |
| 17 17193200 | 1 NR | CARICABATTERIE LITIO 48V-230V COMPLETO DI CABLAGGIO E SPINE PER GESTIONE A RICAMBIO | LITHIUM BATTERY CHARGER 48V-230V COMPLETE WITH WIRING AND PLUGS FOR MANAGEMENT TO SPARE | CHARGEUR DE BATTERIE | LADEGERÄT | CARGADOR DE BATERÍA |
| 17 17193300 | 1 NR | CARICABATTERIE LITIO 48V-110/120V COMPLETO DI CABLAGGIO E SPINE PER GESTIONE A RICAMBIO | LITHIUM BATTERY CHARGER 48V-110/120V COMPLETE WITH WIRING AND PLUGS FOR MANAGEMENT TO SPARE | CHARGEUR DE BATTERIE | LADEGERÄT | CARGADOR DE BATERÍA |
| 18 1730720088 | 1 NR | ISOLATORE CONNESSIONE MASSA | INSULATOR EARTH CONNECTION | ISOLATEUR | ISOLATOR | AISLADOR |

 COMPONENTI IMPIANTO ELETTRICO LITIO

 KOMponenten ELEKTROANLAGE LITHIUM 
 ELECTRICAL SYSTEM COMPONENTS LITHIUM

 COMPONENTES INSTALACIÓN ELÉCTRICA LITHIUM 
 COMPOSANTS INSTALLATION ÉLECTRIQUE LITHIUM

| POS Codice | Q.tà |  Descrizione |  Description |  Designation |  Benennung |  Descripción |
|---------------|------|---|---|---|---|---|
| 19 1730720087 | 1 NR | CONNETTORE DERIVAZIONE CAN | JUNCTION CONNECTOR CAN | CONNECTEUR | VERBINDER | CONECTOR |
| 20 1730720086 | 1 NR | TAPPO CONNETTORE 2 VIE | CONNECTOR PLUG 2 WAY | BOUCHON CONNECTEUR | VERSCHLUSS VERBINDER | TAPA CONECTOR |
| 21 1757250009 | 1 NR | CONNETTORE PORTA FEMMINE 4 VIE MOLEX 220-110V 20-25A | CONNECTOR | CONNECTEUR | VERBINDER | CONECTOR |
| 22 1757250011 | 1 NR | PUNTALINO | FERRULE | EMBOUT | ZWINGE | PUNTERA |
| 23 1757250010 | 1 NR | CONNETTORE PORTA MASCHI 4 VIE MOLEX 220-110V 20-25A | CONNECTOR | CONNECTEUR | VERBINDER | CONECTOR |
| 24 1757250013 | 3 NR | PUNTALINO MASCHIO PER CONNETTORE 4 VIE MOLEX 220-110V 20-25A | FERRULE | EMBOUT | ZWINGE | PUNTERA |
| 24 1757250013 | 1 NR | PUNTALINO MASCHIO PER CONNETTORE 4 VIE MOLEX 220-110V 20-25A | FERRULE | EMBOUT | ZWINGE | PUNTERA |





 COMPONENTI IMPIANTO ELETTRICO LITIO

 KOMPONENTEN ELEKTROANLAGE LITHIUM

 ELECTRICAL SYSTEM COMPONENTS LITHIUM

 COMPONENTES INSTALACIÓN ELÉCTRICA LITHIUM

 COMPOSANTS INSTALLATION ÉLECTRIQUE LITHIUM

| POS Codice | Q.tà |  Descrizione |  Description |  Designation |  Benennung |  Descripción |
|---------------|------|---|---|---|---|---|
| 25 1757250012 | 4 NR | TAPPO PER CHIUSURA FORI SU CONNETTORE 4 VIE MOLEX 220-110V 20-25A | CAP | BOUCHON | DECKEL | TAPA |
| 25 1757250012 | 1 NR | TAPPO PER CHIUSURA FORI SU CONNETTORE 4 VIE MOLEX 220-110V 20-25A | CAP | BOUCHON | DECKEL | TAPA |
| 26 078034D1 | 1 NR | PIEGATO FISSAGGIO COMPONENTI PACCO LITIO LL1570-X15JP-X4 30AJ | COMPONENTS FIXING PACK LITHIUM LL1570-X15JP-X4 30AJ | SUPPORT | HALTERUNG | SOPORTE |
| 27 078027D1 | 1 NR | CARTER SUPERIORE CASSONE PACCO LITIO LL1570-X15JP-X4 30AJ | CARTER TOP LITHIUM LL1570-X15JP-X4 30AJ | CARTER | KUBELGEHÄUSE | CÁRTER |
| 28 078035D1 | 1 NR | COFANO SUPERIORE | COVER UPPER | COFFRE | MOTORHAUBE | CAPÓ |





 COMPONENTI IMPIANTO ELETTRICO LITIO

 KOMponenten Elektroanlage Lithium

 ELECTRICAL SYSTEM COMPONENTS LITHIUM

 COMPONENTES INSTALACIÓN ELÉCTRICA LITHIUM

 COMPOSANTS INSTALLATION ÉLECTRIQUE LITHIUM

| POS Codice | Q.tà |  Descrizione |  Description |  Designation |  Benennung |  Descripción |
|---------------|-------|---|---|---|---|---|
| 29 07377300 | 1 NR | PROTEZIONE TRASPARENTE LED CARICABATTERIE PACCO LITIO 72V | TRANSPARENT PROTECTION CHARGER LED | PROTECTION TRANSPARENT | TRANSPARENT SCHUTZART | PROTECCIÓN TRANSPARENTE |
| 30 078574D1 | 1 NR | CHIUSURA FORI FISSAGGIO PER LAMPEGGIANTE SU PACCO LITIO | CLOSING FIXING HOLES FOR FLASHING ON PACK LITHIUM | FERMETURE | SCHLUSS | CIERRE |
| 31 16774700 | 1 NR | CONNETTORE AMP. AMPSEAL FE.35 VIE INVERTER 36-48 V | CONNECTOR AMP. AMPSEAL FE.35 VIE INVERTER 36-48 V | CONNECTEUR | VERBINDER | CONECTADOR |
| 32 16774800 | 35 NR | PUNTALINO FE05-1 MMQ AMPSEAL STAGNATO GL14.70 BATTERY | TERMINAL | BORNE | KLEMME | BORNE |
| 33 1757260006 | 6 NR | PUNTALINO PER PORTAFUSIBILE | FERRULE FOR FUSE HOLDER | BORNE | KLEMME | BORNE |
| 34 1757260007 | 6 NR | GOMMINO PER PORTAFUSIBILE | RUBBER FERRULE FOR FUSE HOLDER | INSERT CAOUTCHOUC | GUMMISATZ | INSERCIÓN DE GOMA |
| 35 1757260001 | 3 NR | PORTAFUSIBILE | FUSE HOLDER | PORTE-FUSIBLE | SICHERUNGSHAL TER | PORTAFUSIBLE |





 COMPONENTI IMPIANTO ELETTRICO LITIO

 KOMPONENTEN ELEKTROANLAGE LITHIUM

 ELECTRICAL SYSTEM COMPONENTS LITHIUM

 COMPONENTES INSTALACIÓN ELÉCTRICA LITHIUM

 COMPOSANTS INSTALLATION ÉLECTRIQUE LITHIUM

| POS Codice | Q.tà |  Descrizione |  Description |  Designation |  Benennung |  Descripción |
|---------------|------|---|---|---|---|---|
| 36 1776330003 | 2 NR | RELE' MINI TYCO 12V PER CONNETTORE A TENUTA (MK2 DA C170000893) | RELAY 'MINI 12V TYCO CONNECTOR SEAL (MK2 FROM C170000893) | RELAIS | RELAIS | RELÉ |
| 37 1776330007 | 8 NR | PUNTALINI PER RELE' A TENUTA MINI TYCO 12V (MK2 DA C170000893) | FERRULE FOR RELAY SEAL MINI 12V TYCO (MK2 FROM C170000893) | BORNE | KLEMME | BORNE |
| 38 1776330005 | 8 NR | GOMMINO PER RELE' A TENUTA MINI TYCO 12V (MK2 DA C170000893) | RUBBER FOR RELAY SEAL MINI 12V TYCO (MK2 FROM C170000893) | JOINT RELÉ | GUMMIDICHTUNG | JUNTA DE GOMA |
| 39 1776330004 | 2 NR | PORTA RELE' A TENUTA PER MINI TYCO 12V (MK2 DA C170000893) | HOLDER RELAY SEAL FOR MINI 12V TYCO (MK2 FROM C170000893) | PORTE RELAIS | RELAISHALTER | PORTARELÉ |
| 40 2781020001 | 1 NR | COPPIA DI CELLE LITIO MID COMPLETA A RICAMBIO | COUPLE OF LITHIUM CELLS MID FULL REPLACEMENT | COUPLE DE CELLULES LITHIUM | PAAR VON LITHIUMZELLE | PAR DE CELULAS DE LITIO |





 COMPONENTI IMPIANTO ELETTRICO LITIO

 KOMponenten ELEKTROANLAGE LITHIUM

 ELECTRICAL SYSTEM COMPONENTS LITHIUM

 COMPONENTES INSTALACIÓN ELÉCTRICA LITHIUM

 COMPOSANTS INSTALLATION ÉLECTRIQUE LITHIUM

| POS Codice | Q.tà |  Descrizione |  Description |  Designation |  Benennung |  Descripción |
|---------------|------|---|---|---|---|---|
| 41 2781020012 | 1 NR | TELERUTTORE DI POTENZA INTERNO PACCO MID | RELAY OF INTERNAL POWER PACK MID | TELERUPTEUR | FERNSCHALTER | TELEINTERRUPTOR |
| 42 2781020014 | 1 NR | FUSIBILE 400A | FUSE 400A | FUSIBLE | SICHERUNG | FUSIBLE |
| 43 2781020017 | 1 NR | BMS MASTER MID | BMS MASTER MID | BMS MASTER MID | BMS MASTER MID | BMS MASTER MID |
| 44 2781020003 | 1 NR | RIVETTO RAME H=10 | COPPER RIVET H=10 | RIVET | NIETE | REMACHE |
| 44 2781020003 | 4 NR | RIVETTO RAME H=10 | COPPER RIVET H=10 | RIVET | NIETE | REMACHE |
| 45 2781020004 | 4 NR | RIVETTO RAME H=12 | COPPER RIVET H=12 | RIVET | NIETE | REMACHE |
| 45 2781020004 | 1 NR | RIVETTO RAME H=12 | COPPER RIVET H=12 | RIVET | NIETE | REMACHE |
| 46 2781020005 | 1 NR | LAMA FISSAGGIO CELLE 2 FORI | PLATE FIXING CELLS 2 HOLES | PLAQUE DE FIXATION | MONTAGEPLATTE | PLACA DE FIJACION |
| 47 2781020006 | 1 NR | LAMA FISSAGGIO CELLE 4 FORI | PLATE FIXING CELLS 4 HOLES | PLAQUE DE FIXATION | MONTAGEPLATTE | PLACA DE FIJACION |
| 48 2781020007 | 1 NR | LAMA DI COLLEGAMENTO TRA MODULI | PLATE CONNECTION BETWEEN MODULES | PLAQUE DE CONEXION | VERBINDUNGSPLETTE | PLACA DE CONEXIÓN |





 COMPONENTI IMPIANTO ELETTRICO LITIO

 KOMponenten ELEKTROANLAGE LITHIUM

 ELECTRICAL SYSTEM COMPONENTS LITHIUM

 COMPONENTES INSTALACIÓN ELÉCTRICA LITHIUM

 COMPOSANTS INSTALLATION ÉLECTRIQUE LITHIUM

| POS Codice | Q.tà |  Descrizione |  Description |  Designation |  Benennung |  Descripción |
|---------------|------|---|---|---|---|---|
| 49 2781020008 | 1 NR | LAMA COLLEGAMENTO TELERUTTORE | PLATE CONNECTION RELAY | PLACA DE CONEXIÓN | VERBINDUNGSPLATTE | PLACA DE CONEXIÓN |
| 50 2781020009 | 1 NR | HEATER 36V 60W | HEATER 36V 60W | CHAUFFE | HEIZUNG | CALENTADOR |
| 51 2781020011 | 1 NR | SENSORE LEM PER LITIO MID | LEM SENSOR FOR LITHIUM MID | CAPTEUR | SENSOR | SENSOR |
| 52 2781020013 | 1 NR | SENSORE TEMPERATURA PACCO LITIO MID | TEMPERATURE SENSOR PACK LITHIUM MID | CAPTEUR | SENSOR | SENSOR |
| 53 2781020015 | 1 NR | FUSIBILE IN VETRO 5X20.4 1A | FUSE GLASS 5X20.4 1A | FUSIBLE | SICHERUNG | FUSIBLE |
| 54 2781020019 | 1 NR | CONNETTORE BMS 34 VIE FASATURA 1 | CONNECTOR BMS 34 WAYS STEP 1 | CONNECTEUR | VERBINDER | CONNECTOR |
| 55 2781020020 | 1 NR | CONNETTORE BMS 34 VIE FASATURA 2 | CONNECTOR BMS 34 WAYS STEP 2 | CONNECTEUR | VERBINDER | CONNECTOR |
| 56 2781020021 | 1 NR | CONNETTORE BMS 26 VIE | CONNECTOR BMS 26 WAYS | CONNECTEUR | VERBINDER | CONNECTOR |
| 57 2781020022 | 1 NR | PIN PER CONNETTORI BMS 0,75-1,25 | PIN CONNECTORS FOR BMS 0.75-1.25 | BROCHE POUR CONNECTEURS | PIN-ANSCHLÜSSE | PIN PARA CONECTORES |





 COMPONENTI IMPIANTO ELETTRICO LITIO

KOMPONENTEN ELEKTROANLAGE LITHIUM 

 ELECTRICAL SYSTEM COMPONENTS LITHIUM

COMPONENTES INSTALACIÓN ELÉCTRICA LITHIUM 

 COMPOSANTS INSTALLATION ÉLECTRIQUE LITHIUM

| POS Codice | Q.tà |  Descrizione |  Description |  Designation |  Benennung |  Descripcìon |
|---------------|------|---|---|---|---|---|
| 58 2781020023 | 1 NR | TAPPO PER CONNETTORI BMS | CAP FOR CONNECTORS BMS | COUVERCLE | DECKEL | TAPA |

Go to Discount-Equipment.com to order your parts

 TELECOMANDO

FERNSTEUERUNG 

 REMOTE CONTROL

TELECOMANDO 



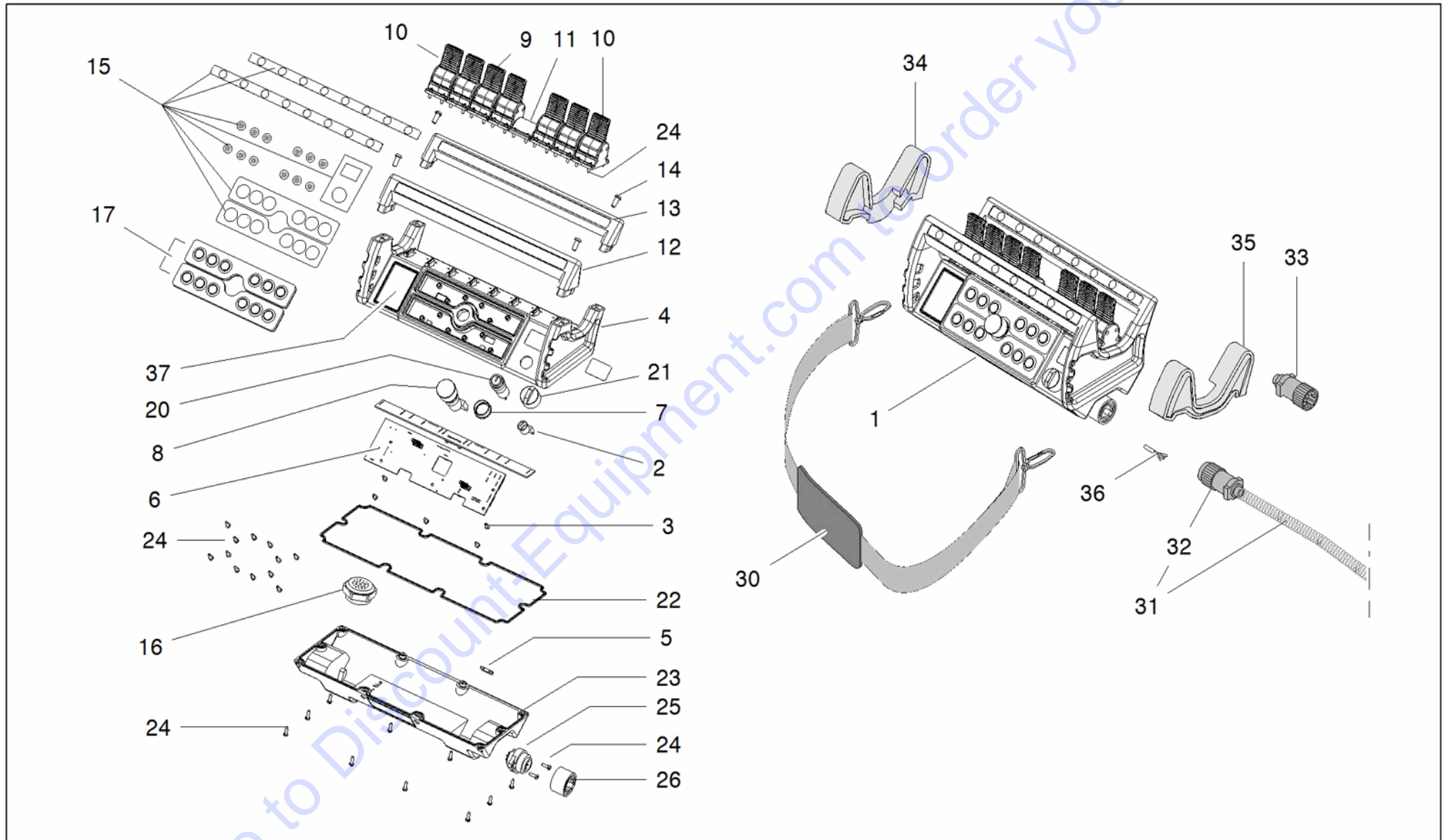

 TÉLÉCOMMANDE



 TELECOMANDO

 FERNSTEUERUNG 
 REMOTE CONTROL

 TELECOMANDO 
 TÉLÉCOMMANDE





| POS Codice | Q.tà |  Descrizione |  Description |  Designation |  Benennung |  Descripcìon |
|--------------|------|---|---|---|---|---|
| 1 27237400 | 1 NR | TELECOMANDO CASE GRIGIO | REMOTE CONTROL GREY CASE | TÉLÉCOMMANDE | FERNSTEUERUN G | TELECOMANDO |
| 2 07359400 | 1 NR | CONTATTO PER STOP EMERGENZA TELECOMANDO 3S | CONTACT FOR EMERGENCY STOP REMOTE CONTROL 3S | CONTACTE POUR ARRET D'URGENCE | KONTAKT FÜR NOTSTOP | CONTACTO PARA PARADA DE EMERGENCIA |
| 3 2646170003 | 5 NR | VITI SCHEDA ELETTRONICA | ELECTRONIC BOARD SCREWS | VIS | SCHRAUBEN | TORNILLOS |

Go to Discount-Equipment.com to order your parts

 TELECOMANDO

 FERNSTEUERUNG 
 REMOTE CONTROL

 TELECOMANDO 
 TÉLÉCOMMANDE

| POS Codice | Q.tà |  Descrizione |  Description |  Designation |  Benennung |  Descripción |
|--------------|------|--|--|---|---|---|
| 4 2723740001 | 1 NR | COPERCHIO SUPERIORE TELECOMANDO CASE GRIGIO + DISPLAY E PULSANTI (PER RICAMBIO È NECESSARIO IL SN DEL TELECOMANDO) | TOP COVER REMOTE CONTROL CASE GREY + DISPLAY AND BUTTONS (AS SPARE IS COMPULSORY THE SN OF REMOTE CONTROL) | COUVERCLE | DECKEL | TAPA |
| 4 2723740002 | 1 NR | COPERCHIO SUPERIORE TELECOMANDO CASE GRIGIO SOLO COPERCHIO, SENZA COMPONENTI E SENZA DISPLAY | TOP COVER REMOTE CONTROL CASE GREY ONLY CASE, WITHOUT COMPONENTS AND DISPLAY | COUVERCLE | DECKEL | TAPA |
| 5 07359500 | 1 NR | CONTATTO REED INTERNO TELECOMANDO 3S | REED CONTACT INTERNAL REMOTE 3S | REED CONTACT INTÉRIEUR 3S DISTANCE | REEDKONTAKT INDOOR REMOTE 3S | CONTACTO REED 3S REMOTO DE INTERIOR |
| 6 2646170002 | 1 NR | SCHEDA ELETTRONICA PER TELECOMANDO | ELECTRONIC BOARD FOR REMOTE CONTROL | FICHE ÉLECTRIQUE | ELEKTRONISCHE PLATINE | PLACA ELECTRÓNICA |
| 7 2646170007 | 1 NR | ANELLO | RING | BAGUE | RING | ANILLO |





 TELECOMANDO

 FERNSTEUERUNG

 REMOTE CONTROL

 TELECOMANDO





 TÉLÉCOMMANDE

| POS Codice | Q.tà |  Descrizione |  Description |  Designation |  Benennung |  Descripción |
|---------------|------|---|---|---|---|---|
| 8 2646170008 | 1 NR | PULSANTE EMERGENZA | EMERGENCY BUTTON | BOUTON D'URGENCE | NOTSTOP KNOPF | PULSADOR DE EMERGENCIA |
| 9 17550700 | 1 NR | KIT PROTEZIONE IN GOMMA PER JOYSTICK NERA | PROTECTION KIT | PROTECTION KIT | GUMMISCHUTZ KIT | PROTECCIÓN DE GOMA |
| 9 2646170009 | 6 NR | LEVA NERA | LEVER BLACK | LEVIER | HEBEL | PALANCA |
| 10 17550800 | 1 NR | KIT PROTEZIONE IN GOMMA PER JOYSTICK ROSSA | PROTECTION | PROTECTION | GUMMISCHUTZ | PROTECCION DE GOMA |
| 10 2646170010 | 2 NR | LEVA ROSSA | LEVER RED | LEVIER | HEBEL | PALANCA |
| 12 2646170013 | 1 NR | IMPUGNATURA INFERIORE | GRIP LOWER PART | POIGNÉE | GRIFF | EMPUÑADURA |
| 13 2646170012 | 1 NR | IMPUGNATURA SUPERIORE | GRIP UPPER PART | POIGNÉE | GRIFF | EMPUÑADURA |
| 14 2646170014 | 4 NR | VITE | SCREW | VIS | SCHRAUBE | TORNILLO |
| 15 27005200 | 1 NR | KIT ADESIVI | DECALS KIT | KIT AUTOCOLLANTS | KLEBERSATZ | KIT PEGATINAS |
| 16 2646170027 | 1 NR | CICALINO COMPLETO DI SCHEDA ELETTRONICA TELECOMANDO | BEEPER FOR REMOTE CONTROL | BUZZER | SUMMER | ZUMBADOR COMPLETO DE TARJETA ELECTRÓNICA TELEMANDO |
| 17 2646170017 | 1 NR | PULSANTI | BUTTONS | BOUTONS | DRUCKKNÖPFE | BOTONES |

 TELECOMANDO

 FERNSTEUERUNG 
 REMOTE CONTROL

 TELECOMANDO 
 TÉLÉCOMMANDE

| POS Codice | Q.tà |  Descrizione |  Description |  Designation |  Benennung |  Descripcìon |
|---------------|-------|---|---|---|---|---|
| 20 2683930001 | 1 NR | INTERRUTTORE | SWITCH | INTERRUPTEUR | SCHALTER | INTERRUPTOR |
| 21 2683930002 | 1 NR | CHIAVE ACCENSIONE | IGNITION KEY | CLÉ DE DÉMARRAGE | ZÜNDSCHLÜSSE L | LLAVE DE ENCENDIDO |
| 22 2646170022 | 1 NR | GUARNIZIONE | GASKET | JOINT | DICHTUNG | GUARNICIÓN |
| 23 2646170023 | 1 NR | COPERCHIO INFERIORE | COVER LOWER PART | COUVERCLE | DECKEL | TAPA |
| 24 2646170024 | 56 NR | VITE | SCREW | VIS | SCHRAUBE | TORNILLO |
| 25 2646170025 | 1 NR | CONNETTORE | CONNECTOR | CONNECTEUR | VERBINGER | CONECTOR |
| 26 2646170026 | 1 NR | COPERCHIO CONNETTORE | COVER CONNECTOR | COUVERCLE | DECKEL | TAPA |
| 30 2646170030 | 1 NR | CINGHIA | BELT | COURROIE | RIEMEN | CORREA |
| 31 17235800 | 1 NR | CAVO TELECOMANDO COMPLETO IIIS /200 | COMPLETE REMOTE CONTROL CABLE IIIS /200 | CÂBLE COMPLET TÉLÉCOMMANDE IIIS /200 | FERNBEDIENUNG SKABEL KOMPLETT IIIS /200 | CABLE TELECOMANDO COMPLETO IIIS /200 |
| 32 2646170032 | 1 NR | CONNETTORE COLLEGAMENTO TELECOMANDO | CONNECTOR FOR REMOTE CONTROL | CONNECTEUR | VERBINGER | CONECTOR |
| 33 1684540001 | 1 NR | DISPOSITIVO DI COMANDO PER ABILITAZIONE EMERGENZA A TERRA | CONTROL DEVICE FOR ACTIVATING THE EMERGENCY GROUND | DISPOSITIF DE COMMANDE EN CAS D'URGENCE | STEUERVORRICHTUNG IM NOTFALL | DISPOSITIVO DE CONTROL DE EMERGENCIA |





 TELECOMANDO

 FERNSTEUERUNG

 REMOTE CONTROL

 TELECOMANDO

 TÉLÉCOMMANDE

| POS Codice | Q.tà |  Descrizione |  Description |  Designation |  Benennung |  Descripción |
|---------------|------|---|---|---|---|---|
| 34 07027200 | 1 NR | PROTEZIONE SINISTRA | LEFT PROTECTION | PROTECTION GAUCHE | ABDECKUNG LINKS | PROTECCIÓN IZQUIERDA |
| 35 07027100 | 1 NR | PROTEZIONE DESTRA | RIGHT PROTECTION | PROTECTION DROITS | ABDECKUNG RECHTS | PROTECCIÓN DERECHA |
| 36 27283000 | 1 NR | PUNTALINO FEMMINA PER CONNETTORE TELECOMANDO | TERMINAL FEMALE CONNECTOR FOR REMOTE CONTROL | CONNECTEUR FEMELLE | VERBINDUNG | CONECTOR |
| 36 2728300001 | 1 NR | PUNTALINO MASCHIO PER CONNETTORE TELECOMANDO | TERMINAL MALE CONNECTOR FOR REMOTE CONTROL | CONNECTEUR | VERBINDER | CONECTOR |
| 37 07320200 | 1 NR | SCHERMO LCD (PER RICAMBIO È NECESSARIO IL SN DEL TELECOMANDO) | DISPLAY (AS SPARE IS COMPULSORY THE SN OF REMOTE CONTROL) | ÉCRAN | DISPLAY | PANTALLA |

 IMPIANTO ELETTRICO

ELEKTRISCHE ANLAGE 



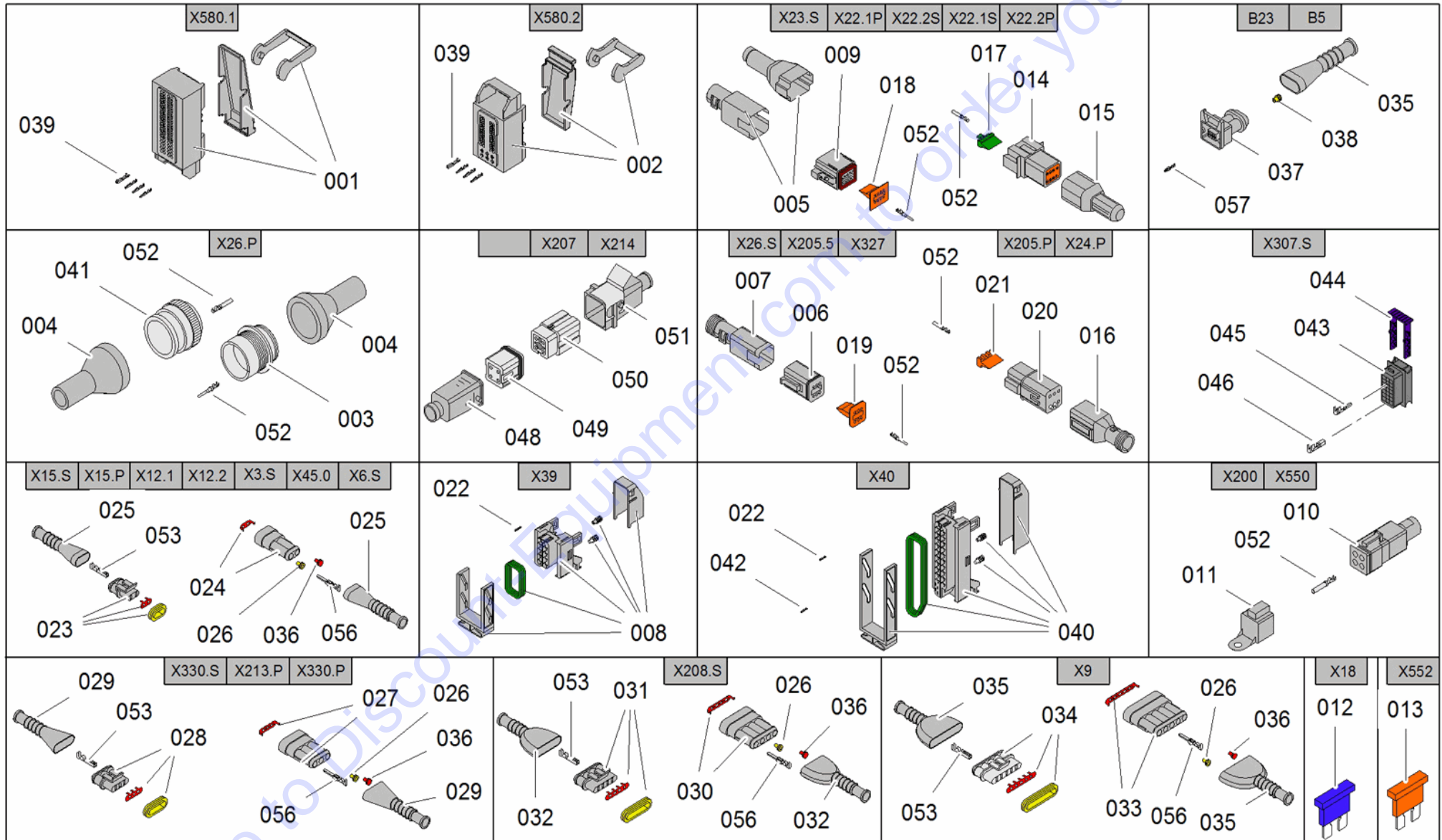

 ELECTRICAL SYSTEM

INSTALACIÓN ELÉCTRICA 





 INSTALLATION ÉLECTRIQUE



 IMPIANTO ELETTRICO
ELEKTRISCHE ANLAGE 
 ELECTRICAL SYSTEM
INSTALACIÓN ELÉCTRICA 
 INSTALLATION ÉLECTRIQUE

| POS Codice | Q.tà |  Descrizione |  Description |  Designation |  Benennung |  Descripción |
|--------------|------|---|---|---|---|---|
| 1 1772950005 | 1 NR | CONNETTORE X580.1 | CONNECTOR X580.1 | CONNECTEUR | VERBINDER | CONECTADOR |
| 2 1772950006 | 1 NR | CONNETTORE X580.2 | CONNECTOR X580.2 | CONNECTEUR | VERBINDER | CONECTADOR |
| 3 1730720051 | 1 NR | CONNETTORE 29 VIE M MOTORE (X26) | CONNECTOR | CONNECTEUR | VERBINDER | CONECTOR |
| 4 1730720054 | 1 NR | CAPPUCCIO POSTERIORE | CAP | CAPUCHON | KAPPE | CAPUCHO |
| 5 1730720035 | 1 NR | COVER POSTERIORE RIGIDA PER CONNETTORE 8 VIE MASCHIO | PROTECTION | PROTECTION | SCHUTZ | PROTECCION |
| 5 1757250025 | 1 NR | CAPPUCCIO POSTERIORE PER CONNETTORE MASCHIO | CAP | CAPUCHON | KAPPE | TAPA |
| 6 1730720037 | 1 NR | CONNETTORE 6 VIE MASCHIO | 6-WAY MALE CONNECTOR | CONNECTEUR 6 VOIES MÂLE | 6-WEGE-VERBIN DER | CONECTOR 6 VÍAS |
| 7 1730720039 | 1 NR | COVER POSTERIORE RIGIDA PER CONNETTORE 6 VIE MASCHIO | PROTECTION | PROTECTION | SCHUTZ | PROTECCION |

 IMPIANTO ELETTRICO
ELEKTRISCHE ANLAGE 
 ELECTRICAL SYSTEM
INSTALACIÓN ELÉCTRICA 
 INSTALLATION ÉLECTRIQUE

| POS Codice | Q.tà |  Descrizione |  Description |  Designation |  Benennung |  Descripción |
|---------------|------|---|---|---|---|---|
| 8 1772950009 | 1 NR | CONNETTORE PER 48XS 28 POLI | CONNECTOR FOR 48XS 28P | CONNECTEUR | KLEMMEN | BORNE |
| 9 1730720033 | 1 NR | CONNETTORE 8 VIE MASCHIO | 8-WAY MALE CONNECTOR | CONNECTEUR 8 VOIES MÂLE | 8-WEGE-VERBIN DER STIFT | CONECTOR 8 VÍAS MACHO |
| 10 1763330001 | 1 NR | CONNETTORE 4 VIE MASCHIO DEUTSCH | 4-WAY MALE CONNECTOR DEUTSCH | CONNECTEUR 4 VOIES MÂLE DEUTSCH | 4-WEGE-VERBIN DER STIFT DEUTSCH | CONECTOR 4 VÍAS MACHO DEUTSCH |
| 11 1763330002 | 1 NR | CAPPUCCIO FRONTALE CONNETTORE 4 VIE MASCHIO DEUTSCH | CAP FOR 4-WAY MALE CONNECTOR DEUTSCH | PAC CONNECTEUR 4 VOIES MÂLE DEUTSCH | CAP 4-WEGE-VERBIN DER STIFT DEUTSCH | CAP CONECTOR 4 VÍAS MACHO DEUTSCH |
| 12 07700700 | 1 NR | FUSIBILE A LAMA 25A | FUSE 25A | FUSIBLE 25A | SICHERUNG 25A | FUSIBLE 25A |
| 13 05760700 | 1 NR | FUSIBILE A LAMA 5A | FUSE 5A | FUSIBLE 5A | SICHERUNG 5A | FUSIBLE 5A |
| 14 1730720029 | 1 NR | CONNETTORE 8 VIE FEMMINA | 8-WAY FEMALE CONNECTOR | CONNECTEUR 8 VOIES FEMELLE | 8-WEGE-VERBIN DER BUCHSE | CONECTOR 8 VÍAS HEMBRA |





 IMPIANTO ELETTRICO

 ELEKTRISCHE ANLAGE

 ELECTRICAL SYSTEM

 INSTALACIÓN ELÉCTRICA

 INSTALLATION ÉLECTRIQUE

| POS Codice | Q.tà |  Descrizione |  Description |  Designation |  Benennung |  Descripción |
|---------------|------|---|---|---|---|---|
| 15 1730720031 | 1 NR | COVER POSTERIORE RIGIDA PER CONNETTORE 8 VIE FEMMINA | PROTECTION | PROTECTION | SCHUTZ | PROTECCION |
| 15 1757250026 | 1 NR | CAPPUCCIO POSTERIORE PER CONNETTORE FEMMINA | CAP | CAPUCHON | KAPPE | TAPA |
| 16 1730720084 | 1 NR | COVER POSTERIORE RIGIDA PER CONNETTORE 6 VIE FEMMINA | PROTECTION | PROTECTION | SCHUTZ | PROTECCION |
| 16 1757250027 | 1 NR | CAPPUCCIO POSTERIORE PER CONNETTORE 6 VIE FEMMINA | CAP | CAPUCHON | KAPPE | TAPA |
| 17 1730720030 | 1 NR | PIASTRINA DI BLOCCAGGIO CONNETTORE 8 VIE FEMMINA | PLATE | PLAQUE | PLATTE | PLACA |





 IMPIANTO ELETTRICO

 ELEKTRISCHE ANLAGE





 ELECTRICAL SYSTEM

 INSTALACIÓN ELÉCTRICA

 INSTALLATION ÉLECTRIQUE

| POS Codice | Q.tà |  Descrizione |  Description |  Designation |  Benennung |  Descripción |
|---------------|------|---|---|---|---|---|
| 18 1730720034 | 1 NR | PIASTRINA DI BLOCCAGGIO CONNETTORE 8 VIE MASCHIO | PLATE | PLAQUE | PLATTE | PLACA |
| 19 1730720038 | 1 NR | PIASTRINA DI BLOCCAGGIO CONNETTORE 6 VIE MASCHIO | PLATE | PLAQUE | PLATTE | PLACA |
| 20 1730720041 | 1 NR | CONNETTORE 6 VIE FEMMINA | 6-WAY FEMALE CONNECTOR | CONNECTEUR 6 VOIES FEMELLE | 6-WEGE-VERBIN DER BUCHSE | CONNECTOR 6 VÍAS HEMBRA |
| 21 1730720042 | 1 NR | PIASTRA BLOCCAGGIO CONNETTORE 6 VIE FEMMINA | CONNECTOR | CONNECTEUR | VERBINDER | CONNECTADOR |
| 22 1772950007 | 1 NR | PUNTALINO FEMMINA PER 48XS CAVO 0,5-1 | FERRULE FEMALE 48XS 0,5-1 | BORNE | KLEMME | BORNE |
| 23 1757250031 | 1 NR | CONNETTORE SUPERSEAL PF 2 VIE | CONNECTOR | CONNECTEUR | VERBINDER | CONNECTADOR |
| 24 1757250032 | 1 NR | CONNETTORE SUPERSEAL PM 2 VIE | CONNECTOR | CONNECTEUR | VERBINDER | CONNECTADOR |
| 24 1757250032 | 2 NR | CONNETTORE SUPERSEAL PM 2 VIE | CONNECTOR | CONNECTEUR | VERBINDER | CONNECTADOR |

 IMPIANTO ELETTRICO
ELEKTRISCHE ANLAGE 
 ELECTRICAL SYSTEM
INSTALACIÓN ELÉCTRICA 
 INSTALLATION ÉLECTRIQUE

| POS Codice | Q.tà |  Descrizione |  Description |  Designation |  Benennung |  Descripción |
|---------------|-------|---|---|---|---|---|
| 25 1757250033 | 2 NR | CAPPUCCIO POSTERIOERE CONNETTORE SUPERSEAL 2 VIE | CAP | CAPUCHON | KAPPE | CAPUCHO |
| 25 1757250033 | 1 NR | CAPPUCCIO POSTERIOERE CONNETTORE SUPERSEAL 2 VIE | CAP | CAPUCHON | KAPPE | CAPUCHO |
| 26 1757250043 | 3 NR | GOMMINO TENUTA PER CAVI CONNETTORI SUPERSEAL | RUBBER SEAL | JOINT EN CAOUTCHOUC | GUMMIDICHTUNG | JUNTA DE GOMA |
| 26 1757250043 | 1 NR | GOMMINO TENUTA PER CAVI CONNETTORI SUPERSEAL | RUBBER SEAL | JOINT EN CAOUTCHOUC | GUMMIDICHTUNG | JUNTA DE GOMA |
| 26 1757250043 | 10 NR | GOMMINO TENUTA PER CAVI CONNETTORI SUPERSEAL | RUBBER SEAL | JOINT EN CAOUTCHOUC | GUMMIDICHTUNG | JUNTA DE GOMA |





 IMPIANTO ELETTRICO

 ELEKTRISCHE ANLAGE





 ELECTRICAL SYSTEM

 INSTALACIÓN ELÉCTRICA





 INSTALLATION ÉLECTRIQUE

| POS Codice | Q.tà |  Descrizione |  Description |  Designation |  Benennung |  Descripción |
|---------------|------|---|---|---|---|---|
| 27 1757250035 | 1 NR | CONNETTORE SUPERSEAL PM 3 VIE | CONNECTOR | CONNECTEUR | VERBINDER | CONECTADOR |
| 28 1757250034 | 1 NR | CONNETTORE SUPERSEAL PF 3 VIE | CONNECTOR | CONNECTEUR | VERBINDER | CONECTADOR |
| 29 1757250036 | 1 NR | CAPPUCCIO POSTERIOERE CONNETTORE SUPERSEAL 3 VIE | CAP | CAPUCHON | KAPPE | CAPUCHO |
| 30 1757250038 | 1 NR | CONNETTORE SUPERSEAL PM 4 VIE | CONNECTOR | CONNECTEUR | VERBINDER | CONECTADOR |
| 31 1757250037 | 1 NR | CONNETTORE SUPERSEAL PF 4 VIE | CONNECTOR | CONNECTEUR | VERBINDER | CONECTADOR |
| 32 1757250039 | 1 NR | CAPPUCCIO POSTERIORE CONNETTORE SUPERSEAL 4 VIE | CAP | CAPUCHON | KAPPE | CAPUCHO |





 IMPIANTO ELETTRICO
ELEKTRISCHE ANLAGE 
 ELECTRICAL SYSTEM
INSTALACIÓN ELÉCTRICA 
 INSTALLATION ÉLECTRIQUE

| POS Codice | Q.tà |  Descrizione |  Description |  Designation |  Benennung |  Descripción |
|---------------|------|---|---|---|---|---|
| 33 1757250041 | 1 NR | CONNETTORE SUPERSEAL PM 5 VIE | CONNECTOR | CONNECTEUR | VERBINDER | CONECTADOR |
| 33 1757250050 | 1 NR | CONNETTORE SUPERSEAL PM 6 VIE | CONNECTOR | CONNECTEUR | VERBINDER | CONECTADOR |
| 34 1757250040 | 1 NR | CONNETTORE SUPERSEAL PF 5 VIE | CONNECTOR | CONNECTEUR | VERBINDER | CONECTADOR |
| 34 1757250056 | 1 NR | CONNETTORE SUPERSEAL PF 6 VIE | CONNECTOR | CONNECTEUR | VERBINDER | CONECTADOR |
| 35 1757250042 | 1 NR | CAPPUCCIO POSTERIOERE CONNETTORE SUPERSEAL 5-6 VIE | CAP | CAPUCHON | KAPPE | CAPUCHO |
| 36 1757250046 | 1 NR | GOMMINO TENUTA TAPPO PER CONNETTORI SUPERSEAL | RUBBER SEAL | JOINT EN CAOUTCHOUC | GUMMIDICHTUNG | JUNTA DE GOMA |
| 37 1757250044 | 1 NR | CONNETTORE JPT 2 VIE PER ELETTROVALVOL E | CONNECTOR | CONNECTEUR | VERBINDER | CONECTADOR |

 IMPIANTO ELETTRICO
ELEKTRISCHE ANLAGE 
 ELECTRICAL SYSTEM
INSTALACIÓN ELÉCTRICA 
 INSTALLATION ÉLECTRIQUE

| POS Codice | Q.tà |  Descrizione |  Description |  Designation |  Benennung |  Descripción |
|---------------|------|---|---|---|---|---|
| 38 1757250045 | 1 NR | GOMMINO TENUTA PER CAVI CONNETTORI JPT | RUBBER SEAL | JOINT EN CAOUTCHOUC | GUMMIDICHTUNG | JUNTA DE GOMA |
| 39 1772950001 | 1 NR | PUNTALINO FEMMINA PER X580 CAVO SEZ 0,75-1 | FERRULE FEMALE X580 0,75-1 | BORNE | KLEMMME | BORNE |
| 39 1772950002 | 1 NR | PUNTALINO FEMMINA PER X580 CAVO SEZ 0,5 | FERRULE FEMALE X580 0,5 | BORNE | KLEMMME | BORNE |
| 39 1772950003 | 1 NR | PUNTALINO FEMMINA PER X580 CAVO SEZ 1,5 | FERRULE FEMALE X580 1,5 | BORNE | KLEMMME | BORNE |
| 39 1772950004 | 1 NR | PUNTALINO FEMMINA PER X580 CAVO SEZ 2,5 | FERRULE FEMALE X580 2,5 | BORNE | KLEMMME | BORNE |
| 40 1772950010 | 1 NR | CONNETTORE PER 48XS 52 POLI | CONNECTOR FOR 48XS 52P | CONNECTEUR | VERBINDER | CONECTADOR |
| 41 1730720059 | 1 NR | CONNETTORE 29 VIE F MOTORE (X26) | CONNECTOR | CONNECTEUR | VERBINDER | CONECTADOR |

 IMPIANTO ELETTRICO
ELEKTRISCHE ANLAGE 
 ELECTRICAL SYSTEM
INSTALACIÓN ELÉCTRICA 
 INSTALLATION ÉLECTRIQUE

| POS Codice | Q.tà |  Descrizione |  Description |  Designation |  Benennung |  Descripción |
|---------------|------|---|---|---|---|---|
| 42 1772950008 | 1 NR | PUNTALINO FEMMINA PER 48XS CAVO 1,5 | FERRULE FEMALE 48XS 1,5 | BORNE | KLEMMME | BORNE |
| 43 17473600 | 1 NR | PARTE DI CONNETTORE 24VIE | CONNECTOR PART 24 WAY | CONNECTEUR | VERBINGER | CONECTADOR |
| 44 17473700 | 1 NR | SLITTA PER CONNETTORE 24 VIE | SLIDE FOR 24-WAY CONNECTOR | COULISSEAU | SCHLITTEN | CORREDERA |
| 45 17306300 | 1 NR | PUNTALINO FEMMINA PER CONNETTORE 56 VIE SCHEDA MASTER D=1.5 | FERRULE FEMALE CONNECTOR 56 WAY MAIN BOARD D = 1.5 | BUTÉE FEMELLE CONNECTEUR 56 VOIES CARTE MASTER D = 1.5 | AUFLAGESTIFT BUCHSE 56-WEGE-VERBIN DER MASTERPLATINE D = 1.5 | CONECTOR PUNTA HEMBRA 56 VÍAS TARJETA MASTER D=1,5 |
| 46 17473800 | 1 NR | PUNTALINO FEMMINA PER CONNETTORE 24 VIE SCHEDA CELLA DI CARICO D=2.8 | FERRULE FEMALE CONNECTOR 24 WAY BOARD LOAD CELL D = 2.8 | EMBOUT FEMELLE POUR CONNECTEUR 24 VOIES CARTE CELLULE DE CHARGE D=2.8 | VERSCHRAUBUN G BUCHSE FÜR 24-WEGE-VERBIN DER KORBLAST-PLATI NE D=2,8 | PUNTAL HEMBRA PARA CONECTOR 24 VÍAS CELULA DE CARGA D=2.8 |
| 47 1730720083 | 1 NR | CUSTODIA 3 POLI GRIGIA VOLANTE PER CONN.PM 4+1VIE 230/110V (X29) | HOUSING 3 POLE GREY FOR CONN. PM 4 + 1 WAY 230V / 110V (X29) | LOGEMENT | GEHÄUSE | ALOJAMIENTO |





 IMPIANTO ELETTRICO

 ELEKTRISCHE ANLAGE





 ELECTRICAL SYSTEM

 INSTALACIÓN ELÉCTRICA

 INSTALLATION ÉLECTRIQUE

| POS Codice | Q.tà |  Descrizione |  Description |  Designation |  Benennung |  Descripcìon |
|---------------|------|---|---|---|---|---|
| 48 1730720082 | 1 NR | FRUTTO CONN.PM 4+1VIE 230/110V (X29) | CONNECTOR PM 4 + 1 WAY 230V / 110V (X 29) | CONNECTEUR | VERBINDER | CONECTADOR |
| 50 1730720080 | 1 NR | FRUTTO CONN. PF 4+1 VIA 230/110V (X29) | CONNECTOR PF 4 + 1 WAY 230V / 110V (X 29) | CONNECTEUR | VERBINDER | CONECTADOR |
| 51 1730720081 | 1 NR | CUSTODIA 3 POLI GRIGIA CON GANCIO PER CONN. PF 4+1 VIA 230/110V (X29) | HOUSING 3 POLE GREY WITH HOOK FOR CONN. PF 4 + 1 ROUTE 230 / 110V (X29) | LOGEMENT | GEHÄUSE | ALOJAMIENTO |

 IMPIANTO ELETTRICO
ELEKTRISCHE ANLAGE 
 ELECTRICAL SYSTEM
INSTALACIÓN ELÉCTRICA 
 INSTALLATION ÉLECTRIQUE

| POS Codice | Q.tà |  Descrizione |  Description |  Designation |  Benennung |  Descripción |
|---------------|------|---|---|---|---|---|
| 52 1730720032 | 1 NR | TERMINALE MASCHIO CAVO 0.75-1.5 | TERMINAL MALE CABLE 0.75-1.5 | MALE TERMINAL | TERMINAL MALE | MALE TERMINAL |
| 52 1730720036 | 1 NR | TERMINALE FEMMINA CONNETTORE M CAVO 0.5-1 | TERMINAL FEMALE MALE CONNECTOR CABLE 0.5-1 | BORNE FEMELLE | TERMINAL FEMALE | TERMINAL HEMBRA |
| 52 1730720040 | 1 NR | TERMINALE FEMMINA (X24) | TERMINAL FEMALE (X24) | BORNE FEMELLE (X24) | TERMINAL FEMALE (X24) | TERMINAL HEMBRA (X24) |
| 52 1730720043 | 1 NR | TERMINALE MASCHIO (X24) DA 0.5 A 0.75 | TERMINAL MALE (X24) DA 0.5 A 0.75 | BORNE MALE (X24) | TERMINAL MALE (X24) | TERMINAL MACHO (X24) |
| 52 1730720055 | 1 NR | CONTATTO MASCHIO 25A CAVO 2.5-4 | CONTACT MALE 25A CABLE 2.5-4 | CONTACT MALE 25A | CONTACT MALE 25A | CONTACT MALE 25A |
| 52 1730720056 | 1 NR | TAPPO SIZE 12-16 (X26) | CAP SIZE 12-16 (X26) | CAP TAILLE 12-16 (X26) | CAP SIZE 12-16 (X26) | CAP TAMAÑO 12-16 (X26) |
| 52 1730720057 | 1 NR | TAPPO SIZE 16 (X26) | CAP SIZE 16 (X26) | PLUG SIZE 16 (X26) | PLUG SIZE 16 (X26) | MACHO TALLA 16 (X26) |
| 52 1730720058 | 1 NR | CONTATTO MASCHIO 7.5A (X26) | CONTACT PIN 7.5A (X26) | CONTACT PIN 7.5A (X26) | CONTACT PIN 7.5A (X26) | CONTACT 7.5A (X26) |
| 52 1730720061 | 1 NR | CONTATTO FEMMINA 7.5A (X26) | CONTACT FEMALE 7.5A (X26) | CONTACTER 7,5 FEMELLE (X26) | CONTACT FEMALE 7.5A (X26) | CONTACT 7.5A FEMENINO (X26) |





 IMPIANTO ELETTRICO

 ELEKTRISCHE ANLAGE

 ELECTRICAL SYSTEM

 INSTALACIÓN ELÉCTRICA

 INSTALLATION ÉLECTRIQUE

| POS Codice | Q.tà |  Descrizione |  Description |  Designation |  Benennung |  Descripción |
|---------------|-------|---|---|---|---|---|
| 52 1730720068 | 1 NR | TAPPO SIZE 20 (X1) | CAP SIZE 20 (X1) | PLUG SIZE 20 (X1) | PLUG SIZE 20 (X1) | TAMAÑO DE ENCHUFE 20 (X1) |
| 52 1730720069 | 1 NR | CONTATTO FEMMINA 25A CONNETTORE M CAVO 2.5-4 | CONTACT FEMALE 25A MALE CONNECTOR CABLE 2.5-4 | CONTACT FEMELLE 25A | KONTAKT BUCHSE 25A | CONTACT HEMBRA 25A |
| 53 1757250048 | 1 NR | PUNTALINO FEMMINA PER SUPERSEAL | FERRULE FEMALE FOR SUPERSEAL | FERRULE | NUTMUTTER | ANILLO |
| 56 1757250049 | 1 NR | PUNTALINO MASCHIO PER SUPERSEAL | FERRULE MALE FOR SUPERSEAL | FERRULE | NUTMUTTER | ANILLO |
| 56 1757250049 | 10 NR | PUNTALINO MASCHIO PER SUPERSEAL | FERRULE MALE FOR SUPERSEAL | FERRULE | NUTMUTTER | ANILLO |
| 56 1757250049 | 3 NR | PUNTALINO MASCHIO PER SUPERSEAL | FERRULE MALE FOR SUPERSEAL | FERRULE | NUTMUTTER | ANILLO |
| 57 1739150047 | 1 NR | CONTATTO FEMMINA PER CONNETTORE JPT | CONTACT FEMALE FOR CONNECTOR JPT | CONTACT FEMELLE POUR CONNECTEUR JPT | KONTAKT BUCHSE FÜR JPT VERBINDER | CONTACTO HEMBRA PARA CONECTOR JPT |

 IMPIANTO ELETTRICO

ELEKTRISCHE ANLAGE 

 ELECTRICAL SYSTEM

INSTALACIÓN ELÉCTRICA 

 INSTALLATION ÉLECTRIQUE

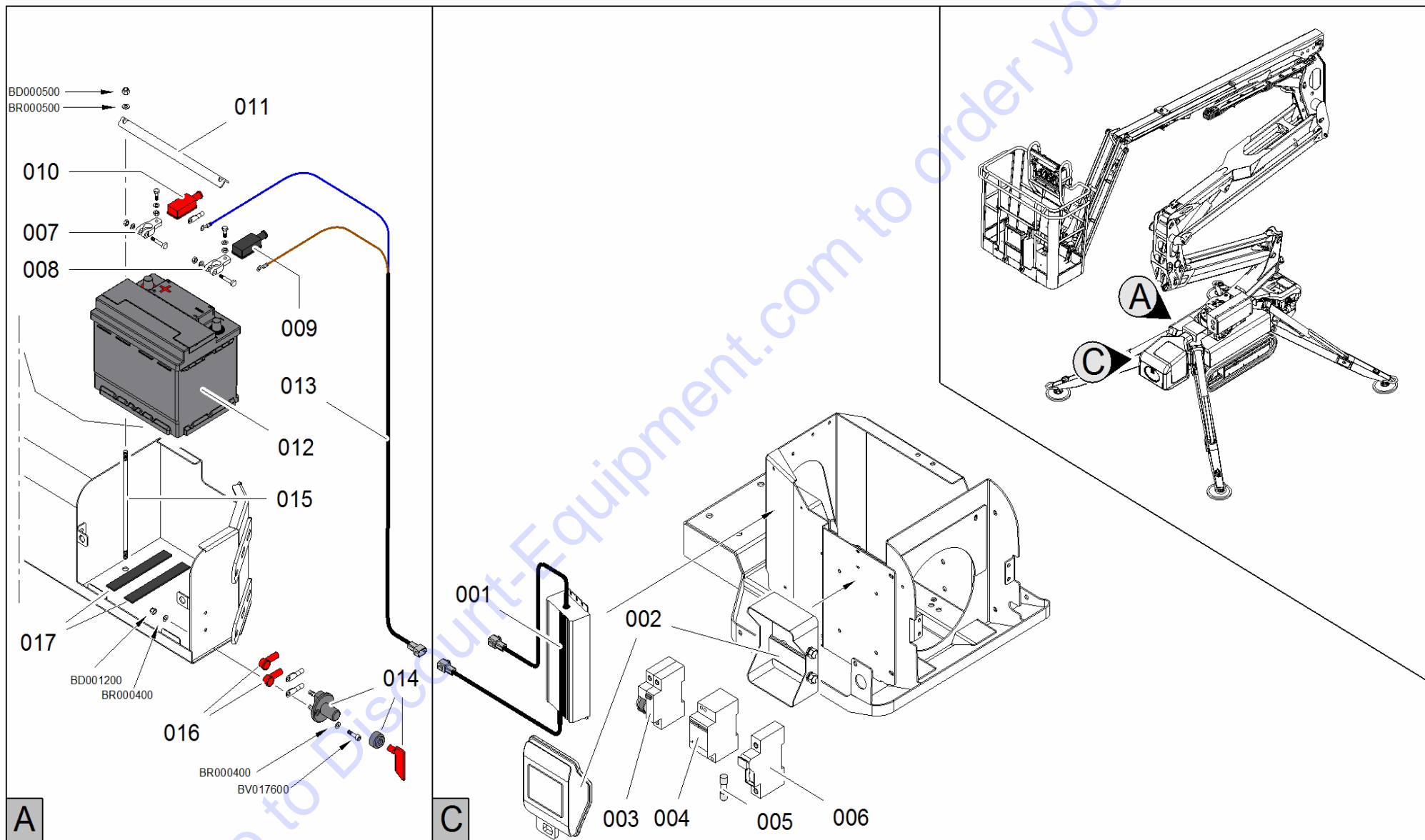





 IMPIANTO ELETTRICO

 ELEKTRISCHE ANLAGE





 ELECTRICAL SYSTEM

 INSTALACIÓN ELÉCTRICA





 INSTALLATION ÉLECTRIQUE



| POS Codice | Q.tà |  Descrizione |  Description |  Designation |  Benennung |  Descripcìon |
|--------------|------|--|--|---|---|---|
| 1 1757250007 | 1 NR | ALIMENTATORE ELETTRONICO 285W REGOLABILE IP65 PER BATTERIE 55-75 AH COMPLETO DI CONNETTORI | ELECTRONIC BALLAST | ALIMENTATEUR ÉLECTRONIQUE | ELEKTRONISCHE S NETZGERÄT | ALIMENTADOR ELETRÓNICO |
| 2 1757250008 | 1 NR | SCATOLA ELETTRICO PLASTICA 6 MODULI BI COPERCHIO TRASPARENTE | ELECTRICAL BOX | BOÎTE ÉLECTRIQUE | SCHALTKASTEN | CAJA ELÉCTRICA |
| 3 1556350063 | 1 NR | INTERUTTORE AUTOMATICO MAGNETOTERMI CO 110-120V 25A (FINO A C170000355 MONTATO C16 SU MACCHINE 120V) | AUTOMATIC THERMAL SWITCH 110-120V 25A (UNTIL C170000355 MOUNTED C16 ON 120V MACHINES) | INTERRUPTEUR | SCHALTER | INTERRUPTOR |
| 4 1757250006 | 1 NR | TELERUTTORE 4POLI 63A CA/CC | RELAY | RELAIS | RELAIS | RELÉ |
| 5 1730720017 | 1 NR | FUSIBILE A TUBO 10A | TUBE FUSE 10A | FUSIBLE | SICHERUNG | FUSIBLE |



 IMPIANTO ELETTRICO
ELEKTRISCHE ANLAGE 
 ELECTRICAL SYSTEM
INSTALACIÓN ELÉCTRICA 
 INSTALLATION ÉLECTRIQUE

| POS Codice | Q.tà |  Descrizione |  Description |  Designation |  Benennung |  Descripción |
|---------------|------|---|---|---|---|---|
| 6 1730720015 | 1 NR | PORTAFUSIBILE A TUBO 220/110V | FUSE HOLDER TUBE 220/110V | BOÎTE À FUSIBLES | SICHERUNGSKA STEN | PORTAFUSIBLES |
| 7 1739150023 | 1 NR | MORSETTO POSITIVO A C PER BATTERIA M10 | POSITIVE BATTERY CLAMP "C" M10 | BORNE POSITIVE A C POUR BATTERIE M10 | POSITIVE KLEMME FÜR BATTERIE M10 | BORNE POSITIVO A C PARA BATERÍA M10 |
| 8 1739150025 | 1 NR | MORSETTO NEGATIVO A C PER BATTERIA M10 | NEGATIVE BATTERY TERMINAL C M10 | BORNE NEGATIVE A C POUR BATTERIE M10 | NEGATIVE KLEMME FÜR BATTERIE M10 | BORNE NEGATIVO A C PARA BATERÍA M10 |
| 9 2632920008 | 1 NR | COPRI POLI BATTERIA QUADRATO NERO | POLE BATTERY COVER BLACK SQUARE | POLE BATTERIE COUVERTURE CARRÉ NOIR | POLE BATTERY COVER BLACK SQUARE | TAPAS BATERIA |
| 10 2632920007 | 1 NR | COPRI POLI BATTERIA QUADRATO ROSSO | POLE BATTERY COVER RED SQUARE | POLE CACHE BATTERIE RED SQUARE | POLE BATTERY COVER RED SQUARE | TAPAS DE LA BATERIA |
| 11 077483Y1 | 1 NR | PIEGATO FISSAGGIO BATTERIA LL1570 | BENT FIXING BATTERY LL1570 | SUPPORT | HALTERUNG | SOPORTE |
| 12 27668600 | 1 NR | BATTERIA AGM S&S 12V 60AH 680A L02 | BATTERY AGM S&S 12V 60AH 680A L02 | BATTERIE AGM S&S 12V 60AH 680A L02 | BATTERIE AGM S&S 12V 60AH 680A L02 | BATERÍA AGM S&S 12V 60AH 680A L02 |



 IMPIANTO ELETTRICO
ELEKTRISCHE ANLAGE 
 ELECTRICAL SYSTEM
INSTALACIÓN ELÉCTRICA 
 INSTALLATION ÉLECTRIQUE



| POS Codice | Q.tà |  Descrizione |  Description |  Designation |  Benennung |  Descripción |
|-----------------|------|---|---|---|---|---|
| 13 175726000801 | 1 NR | CONNETTORE DEUTSCH 2 VIE COMPLETO DI DIODO CON PROTEZIONE | DEUTSCH CONNECTOR 2 WAYS OF COMPLETE WITH PROTECTION DIODE | CONNECTEUR | VERBINDER | CONECTOR |
| 13 1772950020 | 1 NR | LINEA DA ALIMENTATORE A BATTERIA COMPLETA DI CONNETTORI E DIODO LL1570-X15JP-X4 30AJ | LINE FROM CHARGER TO BATTERY WITH CONNECTORS AND DIODE LL1570-X15JP-X4 30AJ | LIGNE | LEITUNG | LÍNEA |
| 14 04774900 | 1 NR | STACCA BATTERIA | BATTERY CUT-OFF DEVICE | COUPE BATTERIE | BATTERIETRENN SCHALTER | CORTA-BATERÍA |
| 15 06551000 | 2 NR | TIRANTE | TIE ROD | TIRANT | TURMGESTÄNGE | TIRANTE |
| 16 1733730029 | 1 NR | COPRIPOLO BATTERIA ROSSO GRANDE | BIG RED COVER FOR BATTERY POLE | PROTECTION PÔLE ROUGE GRAND | ROTE POLKAPPE BATTERIE | CUBREPOLO BATERÍA ROJO GRANDE |
| 17 07894800 | 2 NR | GOMMA ADESIVA DI PROTEZIONE L=190 | RUBBER ADHESIVE PROTECTION L=190 | GOMME ADHESIVE DE PROTECTION L=190 | SCHUTZ-KLEBEG UMMI L=190 | GOMA ADHESIVA DE PROTECCIÓN L=190 |



-  ADESIVI
-  STICKER
-  AUTOCOLLANT

- AUFKLEBER 
- PEGATINA 



Go to Discount-Equipment.com to order your parts



 ADESIVI
 STICKER
 AUTOCOLLANT

AUFKLEBER 
PEGATINA 



| POS Codice | Q.tà |  Descrizione |  Description |  Designation |  Benennung |  Descripcìon |
|------------|------|---|---|---|---|---|
|------------|------|---|---|---|---|---|



Go to Discount-Equipment.com to order your parts





 ADESIVI
 STICKER
 AUTOCOLLANT



AUFKLEBER 
 PEGATINA 



| POS Codice | Q.tà |  Descrizione |  Description |  Designation |  Benennung |  Descripció |
|------------|------|---|---|---|---|--|
| 0 06840400 | 1 NR | ADESIVO | STICKER | AUTOCOLLANT | AUFKLEBER | PEGATINA |
| 0 06922700 | 2 NR | ADESIVO | STICKER | AUTOCOLLANT | AUFKLEBER | PEGATINA |
| 0 06924300 | 1 NR | ADESIVO | STICKER | AUTOCOLLANT | AUFKLEBER | PEGATINA |
| 0 06998800 | 1 NR | ADESIVO | STICKER | AUTOCOLLANT | AUFKLEBER | PEGATINA |
| 0 07034200 | 2 NR | ADESIVO | STICKER | AUTOCOLLANT | AUFKLEBER | PEGATINA |
| 0 07056300 | 2 NR | ADESIVO | STICKER | AUTOCOLLANT | AUFKLEBER | PEGATINA |
| 0 07056400 | 4 NR | ADESIVO | STICKER | AUTOCOLLANT | AUFKLEBER | PEGATINA |
| 0 07056700 | 8 NR | ADESIVO | STICKER | AUTOCOLLANT | AUFKLEBER | PEGATINA |
| 0 07056700 | 6 NR | ADESIVO | STICKER | AUTOCOLLANT | AUFKLEBER | PEGATINA |
| 0 07056800 | 3 NR | ADESIVO | STICKER | AUTOCOLLANT | AUFKLEBER | PEGATINA |
| 0 07058800 | 2 NR | ADESIVO | STICKER | AUTOCOLLANT | AUFKLEBER | PEGATINA |
| 0 07060500 | 2 NR | ADESIVO | STICKER | AUTOCOLLANT | AUFKLEBER | PEGATINA |
| 0 07060600 | 2 NR | ADESIVO | STICKER | AUTOCOLLANT | AUFKLEBER | PEGATINA |
| 0 07071000 | 1 NR | ADESIVO | STICKER | AUTOCOLLANT | AUFKLEBER | PEGATINA |
| 0 07071200 | 8 NR | ADESIVO | STICKER | AUTOCOLLANT | AUFKLEBER | PEGATINA |
| 0 07240300 | 1 NR | ADESIVO | STICKER | AUTOCOLLANT | AUFKLEBER | PEGATINA |
| 0 07268300 | 8 NR | ADESIVO | DECAL | AUTOCOLLANT | AUFKLEBER | PEGATINA |





 ADESIVI
 STICKER
 AUTOCOLLANT



AUFKLEBER 
 PEGATINA 



| POS Codice | Q.tà |  Descrizione |  Description |  Designation |  Benennung |  Descripcìon |
|------------|------|---|---|---|---|---|
| 0 07268400 | 4 NR | ADESIVO | DECAL | AUTOCOLLANT | AUFKLEBER | PEGATINA |
| 0 07394800 | 1 NR | ADESIVO INDICATORE LED CARICABATTERIE 48V (Ø EST.31MM Ø INT.6 MM) NUOVO BMS/4 (DA C170000330) | DECAL | AUTOCOLLANT | AUFKLEBER | PEGATINA |
| 0 07499300 | 1 NR | ADESIVO DON'T OPEN THE CASE SFONDO GIALLO L=60X17 MM | DECAL | AUTOCOLLANT | AUFKLEBER | PEGATINA |
| 0 07668100 | 1 NR | ADESIVO PULSANTI DISTRIBUTORE PARTE AEREA LL2614 L=318X52 MM | DECAL | AUTOCOLLANT | AUFKLEBER | PEGATINA |
| 0 07668200 | 1 NR | ADESIVO EMERGENCY STOP E BLOCCHETTO ACCENSIONE L=85X160 MM | DECAL | AUTOCOLLANT | AUFKLEBER | PEGATINA |
| 0 07668300 | 1 NR | ADESIVO | DECAL | AUTOCOLLANT | AUFKLEBER | PEGATINA |
| 0 07690100 | 2 NR | ADESIVO | DECAL | AUTOCOLLANT | AUFKLEBER | PEGATINA |





 ADESIVI
 STICKER
 AUTOCOLLANT



AUFKLEBER 
 PEGATINA 



| POS Codice | Q.tà |  Descrizione |  Description |  Designation |  Benennung |  Descripció |
|--------------|------|---|---|---|---|--|
| 0 07691500 | 1 NR | ADESIVO | DECAL | AUTOCOLLANT | AUFKLEBER | PEGATINA |
| 0 07787800 | 2 NR | ADESIVO | STICKER | AUTOCOLLANT | AUFKLEBER | PEGATINA |
| 0 07788500 | 2 NR | ADESIVO | DECAL | AUTOCOLLANT | AUFKLEBER | PEGATINA |
| 0 07799200 | 4 NR | ADESIVO | DECAL | AUTOCOLLANT | AUFKLEBER | PEGATINA |
| 0 07802200 | 2 NR | ADESIVO RUMORE 102 DB L=90X100 MM | STICKER NOISE 102 DB L = 90 X 100 MM | AUTOCOLLANT | AUFKLEBER | PEGATINA |
| 0 07808100 | 4 NR | ADESIVO | DECAL | AUTOCOLLANT | AUFKLEBER | PEGATINA |
| 0 07839500 | 4 NR | ADESIVO | DECAL | AUTOCOLLANT | AUFKLEBER | PEGATINA |
| 0 1001125483 | 7 NR | ADESIVO | STICKER | AUTOCOLLANT | AUFKLEBER | PEGATINA |
| 0 1001125483 | 6 NR | ADESIVO | STICKER | AUTOCOLLANT | AUFKLEBER | PEGATINA |
| 0 1608710001 | 1 NR | ADESIVO | STICKER | AUTOCOLLANT | AUFKLEBER | PEGATINA |
| 0 1608710002 | 1 NR | ADESIVO | STICKER | AUTOCOLLANT | AUFKLEBER | PEGATINA |
| 0 1701504 | 1 NR | ADESIVO | STICKER | AUTOCOLLANT | AUFKLEBER | PEGATINA |
| 0 1701505 | 1 NR | ADESIVO | STICKER | AUTOCOLLANT | AUFKLEBER | PEGATINA |
| 0 1701640 | 1 NR | ADESIVO | STICKER | AUTOCOLLANT | AUFKLEBER | PEGATINA |
| 0 1702155 | 1 NR | ADESIVO | STICKER | AUTOCOLLANT | AUFKLEBER | PEGATINA |
| 0 1703814 | 4 NR | ADESIVO | STICKER | AUTOCOLLANT | AUFKLEBER | PEGATINA |





 ADESIVI
 STICKER
 AUTOCOLLANT



AUFKLEBER 
 PEGATINA 



| POS Codice | Q.tà |  Descrizione |  Description |  Designation |  Benennung |  Descripcìon |
|--------------|-------|---|---|---|---|---|
| 0 1704125 | 1 NR | ADESIVO | DECAL | AUTOCOLLANT | AUFKLEBER | PEGATINA |
| 0 1704277 | 2 NR | ADESIVO | STICKER | AUTOCOLLANT | AUFKLEBER | PEGATINA |
| 0 1705828 | 1 NR | ADESIVO | STICKER | AUTOCOLLANT | AUFKLEBER | PEGATINA |
| 0 1706098 | 1 NR | ADESIVO | STICKER | AUTOCOLLANT | AUFKLEBER | PEGATINA |
| 0 1706493 | 1 NR | ADESIVO | STICKER | AUTOCOLLANT | AUFKLEBER | PEGATINA |
| 0 1752770001 | 1 NR | ADESIVO PER MACCHINE CON OLIO BIODEGRADABIL E | STICKER FOR MACHINES WITH OIL BIODEGRADABL E | AUTOCOLLANT | AUFKLEBER | PEGATINA |
| 0 06039600 | 8 NR | ADESIVO | STICKER | AUTOCOLLANT | AUFKLEBER | PEGATINA |
| 0 06039700 | 1 NR | ADESIVO | STICKER | AUTOCOLLANT | AUFKLEBER | PEGATINA |
| 0 06040100 | 8 NR | ADESIVO | STICKER | AUTOCOLLANT | AUFKLEBER | PEGATINA |
| 0 06040300 | 4 NR | ADESIVO | STICKER | AUTOCOLLANT | AUFKLEBER | PEGATINA |
| 0 06040500 | 2 NR | ADESIVO | STICKER | AUTOCOLLANT | AUFKLEBER | PEGATINA |
| 0 06040900 | 5 NR | ADESIVO | STICKER | AUTOCOLLANT | AUFKLEBER | PEGATINA |
| 0 06041200 | 4 NR | ADESIVO | STICKER | AUTOCOLLANT | AUFKLEBER | PEGATINA |
| 0 06041300 | 13 NR | ADESIVO | STICKER | AUTOCOLLANT | AUFKLEBER | PEGATINA |





 ADESIVI
 STICKER
 AUTOCOLLANT



AUFKLEBER 
 PEGATINA 



| POS Codice | Q.tà |  Descrizione |  Description |  Designation |  Benennung |  Descripción |
|------------|------|---|---|---|---|---|
| 0 06041600 | 1 NR | ADESIVO CARBURANTE BENZINA COLORE VERDE L=60 X 80 (**) | DECAL | AUTOCOLLANT | AUFKLEBER | PEGATINA |
| 0 06043900 | 1 NR | ADESIVO | STICKER | AUTOCOLLANT | AUFKLEBER | PEGATINA |
| 0 06056300 | 1 NR | ADESIVO | STICKER | AUTOCOLLANT | AUFKLEBER | PEGATINA |
| 0 06060000 | 1 NR | ADESIVO | STICKER | AUTOCOLLANT | AUFKLEBER | PEGATINA |
| 0 06085900 | 1 NR | ADESIVO | STICKER | AUTOCOLLANT | AUFKLEBER | PEGATINA |
| 0 06086000 | 1 NR | ADESIVO | STICKER | AUTOCOLLANT | AUFKLEBER | PEGATINA |
| 0 06086700 | 6 NR | ADESIVO | STICKER | AUTOCOLLANT | AUFKLEBER | PEGATINA |
| 0 06086700 | 4 NR | ADESIVO | STICKER | AUTOCOLLANT | AUFKLEBER | PEGATINA |
| 0 06136900 | 1 NR | ADESIVO PUNTI INGRASSAGGIO Ø 55 TESTO NERO - SFONDO BIANCO (**) | STICKER GREASE POINTS Ø 55 | AUTOCOLLANT POINTS GRAISSANGE Ø 55 TEXTE NOIR - FOND BLANC (**) | AUFKLEBER SCHMIERPUNKTE Ø 55, SCHWARZER TEXT - WEIßER UNTERGRUND | PEGATINS PUNTOS ENGRASE Ø 55 TEXTO NEGRO - FONDO BLANCO (**) |
| 0 06164600 | 1 NR | ADESIVO | STICKER | AUTOCOLLANT | AUFKLEBER | PEGATINA |
| 0 06164700 | 1 NR | ADESIVO | STICKER | AUTOCOLLANT | AUFKLEBER | PEGATINA |
| 0 06165000 | 1 NR | ADESIVO | STICKER | AUTOCOLLANT | AUFKLEBER | PEGATINA |





 ADESIVI
 STICKER
 AUTOCOLLANT

AUFKLEBER 
 PEGATINA 

| POS Codice | Q.tà |  Descrizione |  Description |  Designation |  Benennung |  Descripcìon |
|------------|------|---|---|---|---|---|
| 0 06207700 | 1 NR | ADESIVO | STICKER | AUTOCOLLANT | AUFKLEBER | PEGATINA |
| 0 06227200 | 1 NR | ADESIVO "CONTROLLARE LIVELLO OLIO MOTORE " 7 LINGUE GIALLO L=82X108 (**) | DECAL | AUTOCOLLANT | AUFKLEBER | PEGATINA |
| 0 06232100 | 1 NR | ADESIVO | STICKER | AUTOCOLLANT | AUFKLEBER | PEGATINA |
| 0 06254800 | 1 NR | ADESIVO" STOP EMERGENZA" SFONDO GIALLO L=100X50 (**) | DECAL | AUTOCOLLANT | AUFKLEBER | PEGATINA |
| 0 06448100 | 2 NR | ADESIVO | STICKER | AUTOCOLLANT | AUFKLEBER | PEGATINA |
| 0 06448200 | 2 NR | ADESIVO | STICKER | AUTOCOLLANT | AUFKLEBER | PEGATINA |
| 0 06520600 | 2 NR | ADESIVO | STICKER | AUTOCOLLANT | AUFKLEBER | PEGATINA |
| 0 06555500 | 1 NR | ADESIVO | STICKER | AUTOCOLLANT | AUFKLEBER | PEGATINA |
| 0 06555600 | 1 NR | ADESIVO | STICKER | AUTOCOLLANT | AUFKLEBER | PEGATINA |
| 0 06555700 | 1 NR | ADESIVO | STICKER | AUTOCOLLANT | AUFKLEBER | PEGATINA |
| 0 06555800 | 1 NR | ADESIVO | STICKER | AUTOCOLLANT | AUFKLEBER | PEGATINA |
| 0 06561200 | 4 NR | ADESIVO | STICKER | AUTOCOLLANT | AUFKLEBER | PEGATINA |

 ADESIVI
 STICKER
 AUTOCOLLANT

AUFKLEBER 
PEGATINA 

| POS Codice | Q.tà |  Descrizione |  Description |  Designation |  Benennung |  Descripcìon |
|------------|------|---|---|---|---|---|
| 0 06706500 | 1 | NR ADESIVO | STICKER | AUTOCOLLANT | AUFKLEBER | PEGATINA |

Go to Discount-Equipment.com to order your parts

**KIT ADESIVI SICUREZZA PER PIATTAFORMA AEREA /
STICKERS KIT SECURITY FOR AERIAL PLATFORM**

JLG/CE - X15JPLUS / X13JPLUS

Cod. 17788100

+ kit in lingua non incluso nel codice generale / kit in the language not included in the general code

**177881IT / 177881GB / 177881FR / 177881DE / 177881ES / 177881NL /
177881SW - 177881PT / 177881DA / 177881NO / 177881PL / 177881FI**

DA USARE CON / FOR USE WITH

**COD. 17788200 KIT ADESIVI COMMERCIALI PER PIATTAFORMA AEREA / STICKER KITS COMMERCIAL AERIAL PLATFORM
JLG/CE X15JPLUS**

DA USARE CON / FOR USE WITH

**COD. 17788400 KIT ADESIVI COMMERCIALI PER PIATTAFORMA AEREA / STICKER KITS COMMERCIAL AERIAL PLATFORM
JLG/CE X13JPLUS**

**COD. 17187700 KIT INTEGRAZIONE ADESIVI PER PIATTAFORME AEREE JLG/CE LITHIUM /
INTEGRATION KIT STICKERS PLATFORMS JLG / CE LITHIUM
X14J-X14JH-X17J-X19J • X13JP-X15JP-X17JP-X20JP-X23J-X26JP**

COD. 17788100 ADESIVI IN DISTINTA MACCHINA / STICKERS IN THE MACHINE LIST

VOLT

| Num. | COD. | DESCRIZIONE / DESCRIPTION | Q.tà |
|------|------------|---|------|
| D1 | 06042400 | ADESIVO PERICOLO 110 VOLT 16A GIALLO _MOD_B | 3 |
| D1 | 06257300 | ADESIVO PERICOLO 240 VOLT GIALLO L=47 X 47 MM | 3 |
| D1 | 06561200 | ADESIVO PERICOLO 230 VOLT 16 AMPERE GIALLO L=47X47 MM _MOD_B | 3 |
| D2 | 06232100 | ADESIVO ATTENZIONE BENZINA INFIAMMABILE L=170X42 MM _MOD_B | 1 |
| D3 | 06056300 | ADESIVO PERICOLO SCOTTATURE TRIANGOLARE SFONDO GIALLO | 1 |
| D4 | 06041600 | ADESIVO CARBURANTE BENZINA COLORE VERDE L=60 X 80 MM _MOD_B | 1 |
| D4 | 06043900 | ADESIVO CARBURANTE DIESEL SFONDO BIANCO Ø 50 MM | 1 |
| D5 | 06164600 | ADESIVO FILTRO ARIA SFONDO BIANCO Ø50 MM | 1 |
| D6 | 06227200 | ADESIVO CONTROLLARE LIVELLO OLIO MOTORE L=80X80 MM _MOD_B | 1 |
| D7 | 07802200 | ADESIVO RUMORE 102 dB L=90X100 MM (MOTORE BENZINA) | 2 |
| | 07034200 | ADESIVO RUMORE 104 dB L=90X100 MM (MOTORE DIESEL _MOD_B | |
| D8 | 07668000 | ADESIVO PERICOLO 110 VOLT 32A GIALLO L=47 X 47 MM | 1 |
| D9 | 07668100 | ADESIVO PULSANTI DISTRIBUTORE PARTE AEREA LL2614 L=318X52 MM - (PER 1570) | 1 |
| | 07864500 | ADESIVO PULSANTI DISTRIBUTORE PARTE AEREA LL13.70 L=274X52 MM - (PER 1370) | 1 |
| D10 | 1608710001 | ADESIVO PULSANTI DISTRIBUTORE A TERRA LATO SX GL17.80 L= 194X50 MM _MOD_C - (PER 1570) | 1 |
| | 07864600 | ADESIVO PULSANTI DISTRIBUTORE A TERRA LATO SX LL13.70 L= 150X50 MM - (PER 1370) | 1 |
| D11 | 07799400 | ADESIVO PORTATA CESTO 2 PERSONE X15JPLUS L=135X145 MM | 1 |
| | 07868200 | ADESIVO PORTATA CESTO 2 PERSONE X13JPLUS L=135X145 MM | 1 |
| D12 | 07878400 | ADESIVO CASCO IMBRAGATURA E DIVIETI LL1370 L=175X118 MM | 1 |
| | | | |
| | | | |
| | | | |
| | | | |

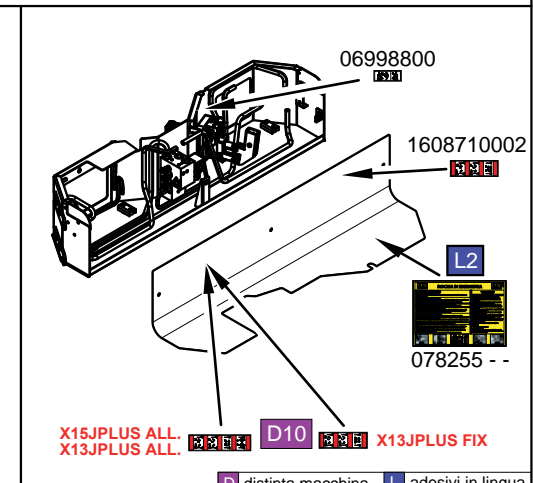
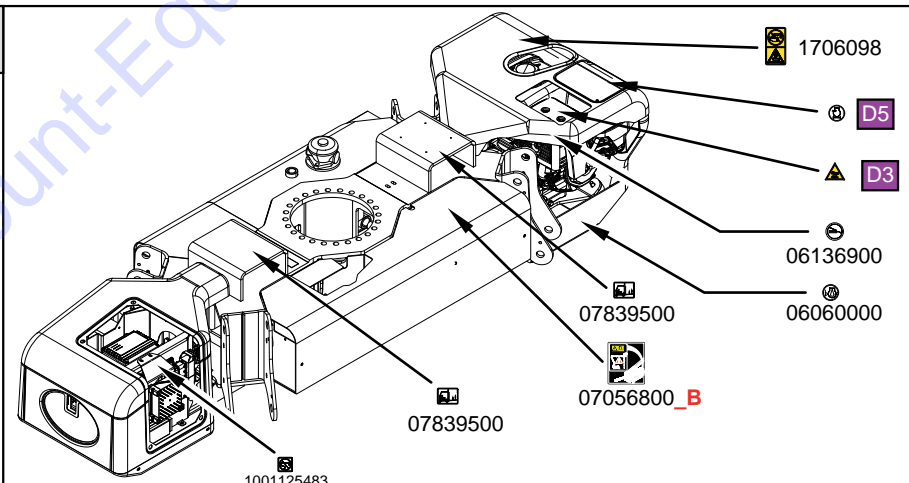
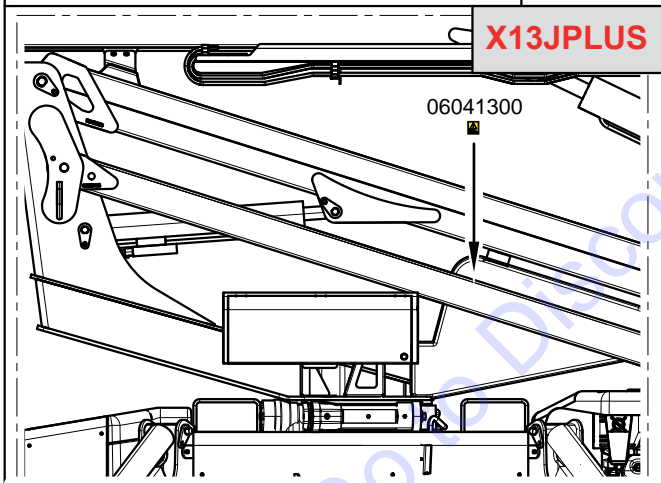
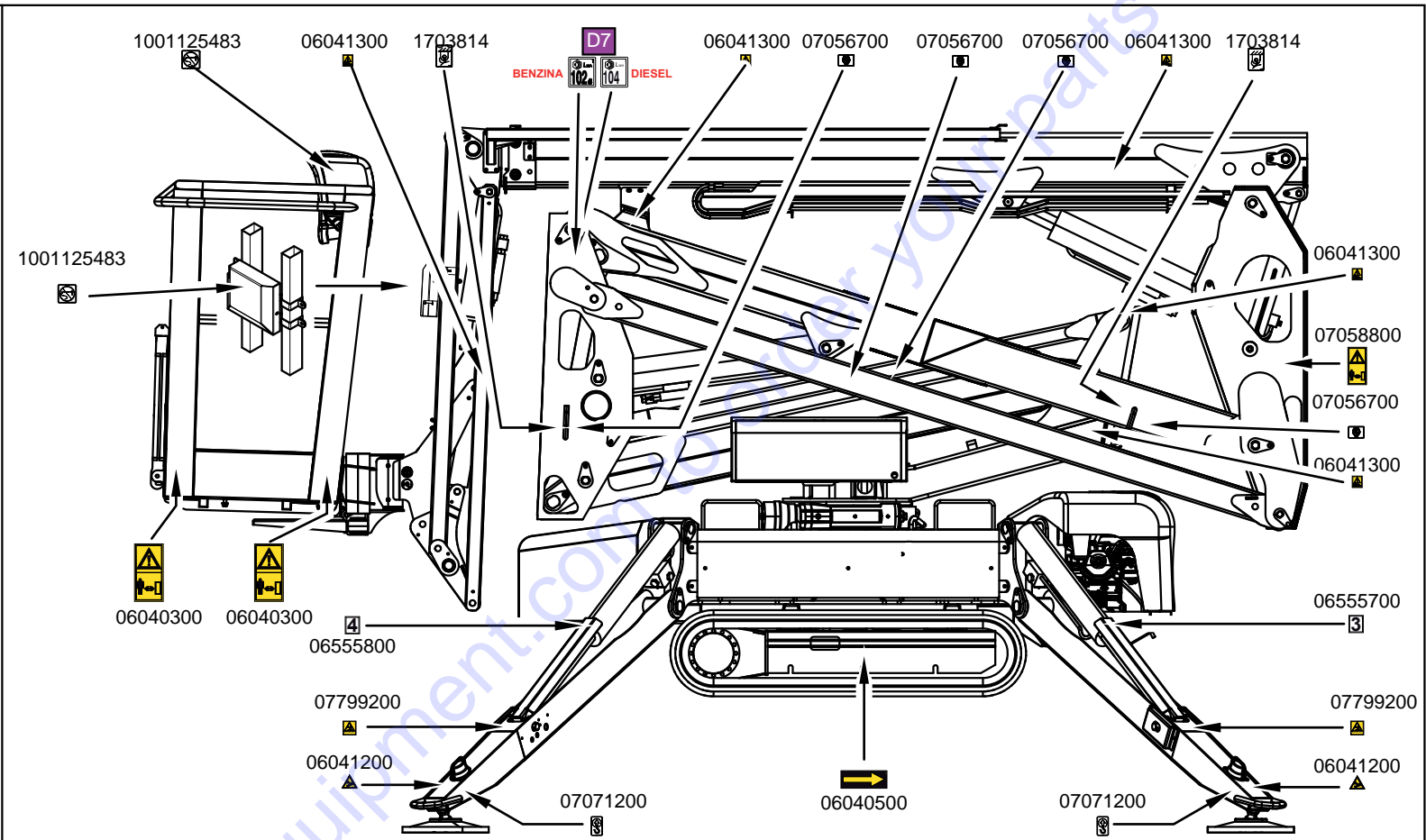
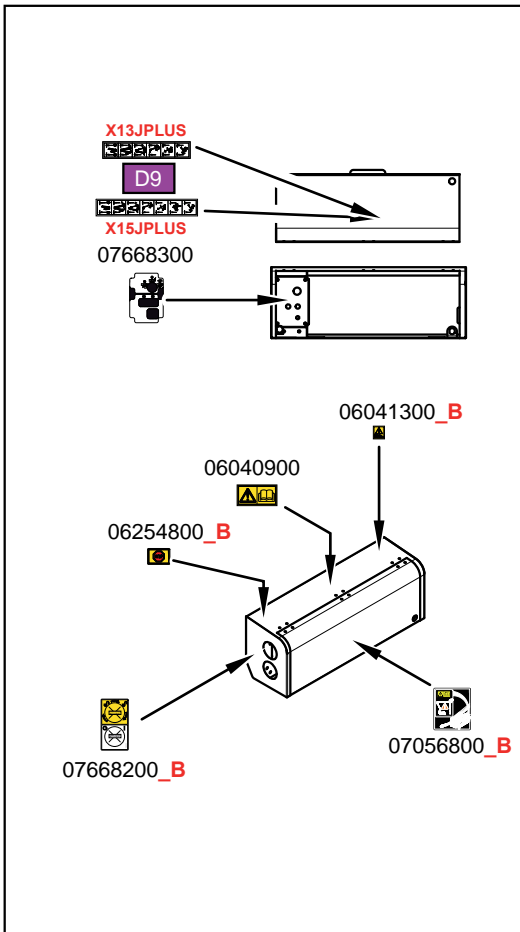

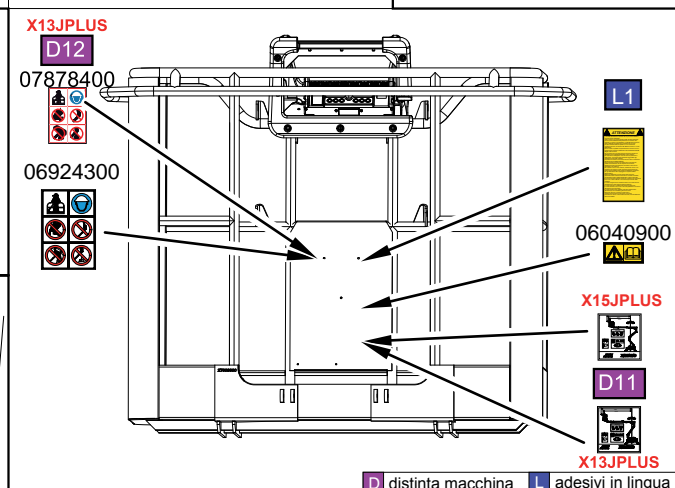
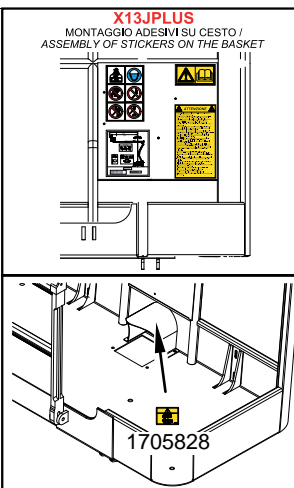
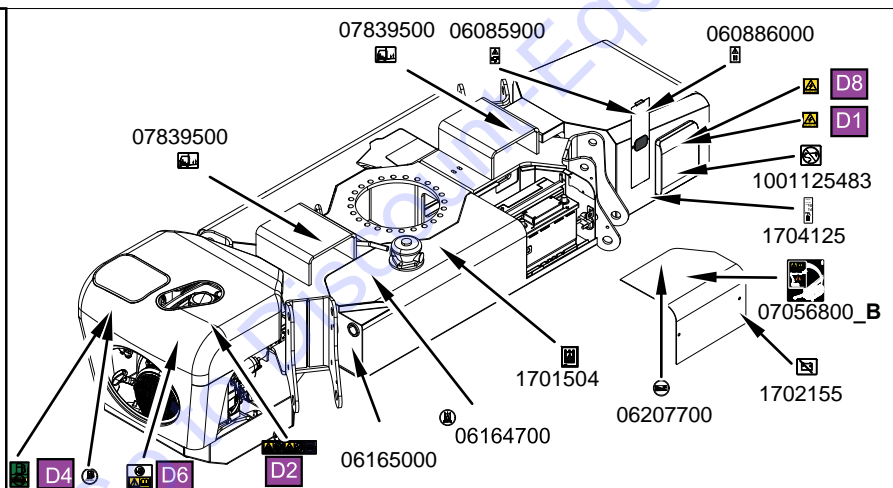
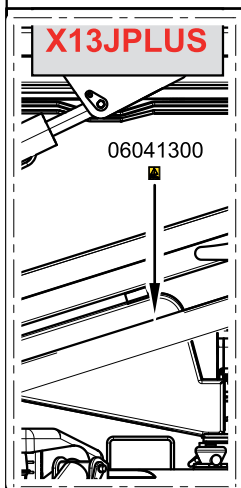
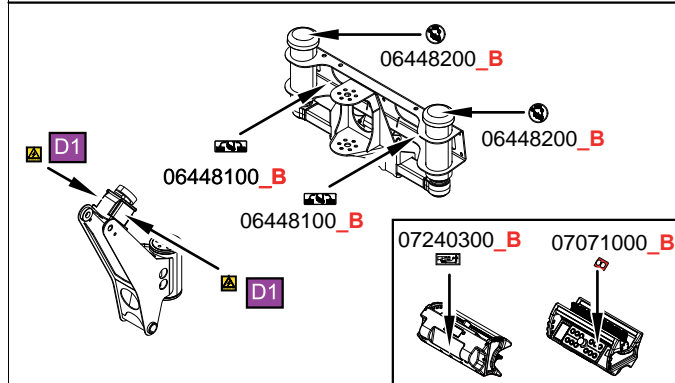
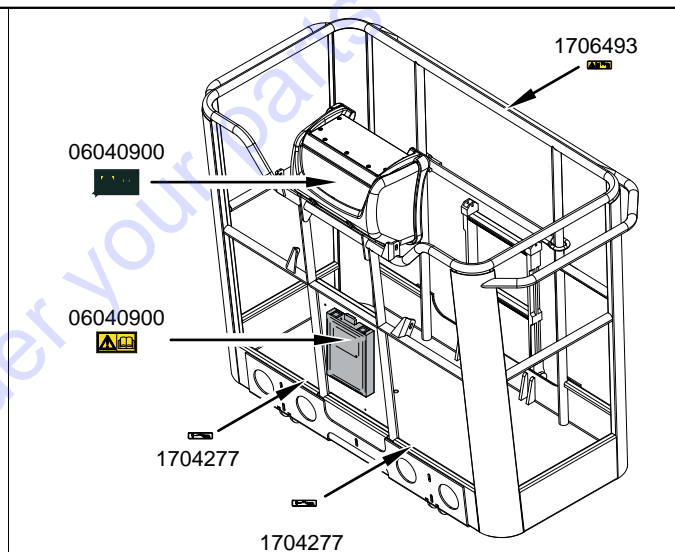
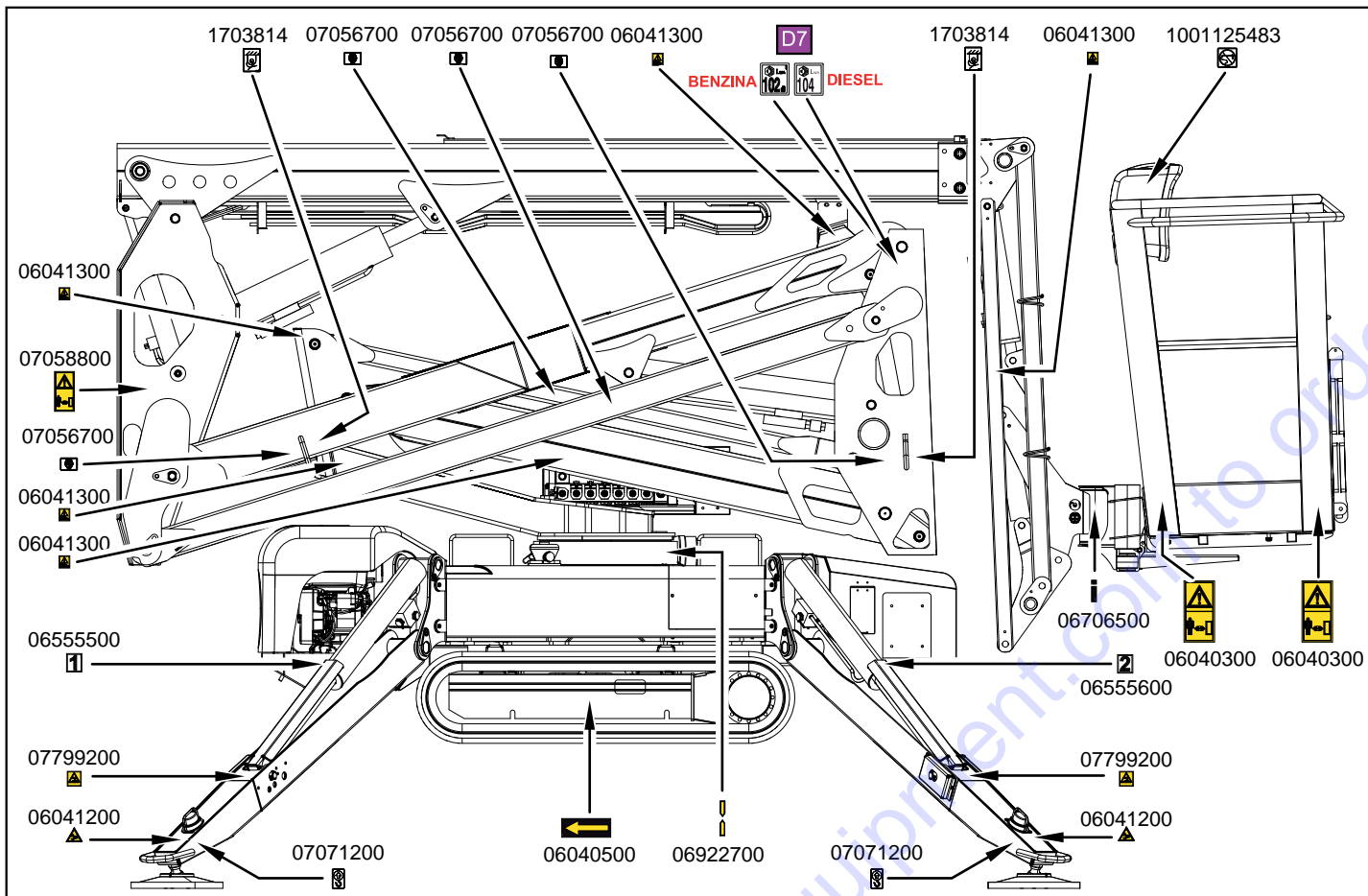

KIT ADESIVI X15JPLUS

SET OF DECALS X15JPLUS

KIT COLLANTS X15JPLUS

BFKLEBERSATZ X15JPLUS

KIT ADHESIVOS X15JPLUS

ADHESIEKIT X15JPLUS

SCALA 1:8

COD. 17788100

TAV. 01

A1

D distinta macchina L adesivi in lingua SEZIONE FORNITORE

PARTS FINDER

**Search Website
by Part Number**



**Search Manual
Library For Parts
Manual & Lookup Part
Numbers – Purchase
or Request Quote**

Search Manuals

Enter your information to help us find the right parts manual for your machine.

* Brand:

* Model:

* Serial:

* Part Number:

SEARCH

**Can't Find Part or
Manual? Request Help
by Manufacturer,
Model & Description**

Parts Order Form

Please fill in the following information to help us find the right part for your machine.

| | |
|---------------|----------------------|
| Manufacturer: | <input type="text"/> |
| Model: | <input type="text"/> |
| Description: | <input type="text"/> |
| Part Number: | <input type="text"/> |
| Quantity: | <input type="text"/> |
| Notes: | <input type="text"/> |

Submit

Discount-Equipment.com is your online resource for quality parts & equipment.

Florida: **561-964-4949** Outside Florida TOLL FREE: **877-690-3101**

Need parts?

Click on this link: <http://www.discount-equipment.com/category/5443-parts/> and choose one of the options to help get the right parts and equipment you are looking for. Please have the machine model and serial number available in order to help us get you the correct parts. If you don't find the part on the website or on one of the online manuals, please fill out the request form and one of our experienced staff members will get back to you with a quote for the right part that your machine needs.

We sell worldwide for the brands: Genie, Terex, JLG, MultiQuip, Mikasa, Essick, Whiteman, Mayco, Toro Stone, Diamond Products, Generac Magnum, Airman, Haulotte, Barreto, Power Blanket, Nifty Lift, Atlas Copco, Chicago Pneumatic, Allmand, Miller Curber, Skyjack, Lull, Skytrak, Tsurumi, Husquvarna Target, Stow, Wacker, Sakai, Mi-T-M, Sullair, Basic, Dynapac, MBW, Weber, Bartell, Bennar Newman, Haulotte, Ditch Runner, Menegotti, Morrison, Contec, Buddy, Crown, Edco, Wyco, Bomag, Laymor, EZ Trench, Bil-Jax, F.S. Curtis, Gehl Pavers, Heli, Honda, ICS/PowerGrit, IHI, Partner, Imer, Clipper, MMD, Koshin, Rice, CH&E, General Equipment, Amida, Coleman, NAC, Gradall, Square Shooter, Kent, Stanley, Tamco, Toku, Hatz, Kohler, Robin, Wisconsin, Northrock, Oztec, Toker TK, Rol-Air, APT, Wylie, Ingersoll Rand / Doosan, Innovatech, Con X, Ammann, Mecalac, Makinex, Smith Surface Prep, Small Line, Wanco, Yanmar

COD. 17788100 ELENCO ADESIVI / LIST STICKERS

| --- | COD. | DESCRIZIONE / DESCRIPTION | Q.tà |
|-----|----------|---|------|
| | 06040300 | ADESIVO PERICOLO MANTENERE LE DISTANZE GIALLO L=100 X 200 MM | 4 |
| | 06040500 | ADESIVO DIREZ. TRASLAZIONE FRECCIA GIALLA SFONDO NERO L=61 X 160 MM | 2 |
| | 06040900 | ADESIVO LEGGERE IL MANUALE GIALLO L=125 X 65 MM | 5 |
| | 06041200 | ADESIVO SCHIACCIAMENTO PIEDI TRIANGOLARE L=53X46 MM | 4 |
| | 06041300 | ADESIVO ATTENZIONE PERICOLO TAGLI L=35 X 40 MM GIALLO_ MOD_B | 13 |
| | 06060000 | ADESIVO LIVELLO OLIO MOTORE Ø50 MM | 1 |
| | 06085900 | ADESIVO SISTEMA BYPASS PARTE AEREA L=30X50 MM | 1 |
| | 06086000 | ADESIVO SISTEMA BYPASS TRASLAZIONE L=30X50 MM (**) | 1 |
| | 06136900 | ADESIVO PUNTI INGRASSAGGIO Ø 55 TESTO NERO - SFONDO BIANCO | 1 |
| | 06164700 | ADESIVO FILTRO OLIO IDRAULICO BIANCO Ø50 MM | 1 |
| | 06165000 | ADESIVO LIVELLO OLIO IDRAULICO SFONDO BIANCO Ø50 MM | 1 |
| | 06207700 | ADESIVO BATTERIA POLO POSITIVO POLO NEGATIVO BIANCO Ø50 (**) | 1 |
| | 06254800 | ADESIVO STOP EMERGENZA SFONDO GIALLO L=70X50 MM_ MOD_B | 1 |
| | 06448100 | ADESIVO RIPRISTINARE I TAPPI FERMO GUIDA L= 100X35 MM_ MOD_B | 2 |
| | 06448200 | ADESIVO "SBLOCCARE SOLO NEI CASI PREVISTI" Ø 60 MM_ MOD_B | 2 |
| | 06555500 | ADESIVO NR 1 BIANCO L=50X60 MM | 1 |
| | 06555600 | ADESIVO NR 2 BIANCO L=50X60 MM | 1 |
| | 06555700 | ADESIVO NR 3 BIANCO L=50X60 MM | 1 |
| | 06555800 | ADESIVO NR 4 BIANCO L=50X60 MM | 1 |
| | 06706500 | ADESIVO ALLINEAMENTO CESTO (2 PEZZI) L=16X50+13(**) | 1 |
| | 06922700 | ADESIVO FRECCIA ALLINEAMENTO L=50x15 (**) | 2 |
| | 06924300 | ADESIVO CASCO - IMBRAGATURA - DIVIETI SERIE METAL-IIIS L= 170X250 MM (**) | 1 |
| | 06998800 | ADESIVO DEVIATORE POMPA MANUALE PIATTAFORMA GL17. 80XL L=86X34 MM | 1 |
| | 07056700 | ADESIVO JLG DIVIETO DI SOLLEVAMENTO L=54,88X40 | 8 |

COD. 17788100 ELENCO ADESIVI / LIST STICKERS

| --- | COD. | DESCRIZIONE / DESCRIPTION | Q.tà |
|-----|------------|--|------|
| | 07056800 | ADESIVO JLG DISCESA DI EMERGENZA ALL'INTERNO L=114X130 MM _MOD_B | 3 |
| | 07058800 | ADESIVO PERICOLO MANTENERE LE DISTANZE L=65X130 MM - GIALLO | 2 |
| | 07071000 | ADESIVO JLG CLAXON SU PIATTAFORME L=39,3X28,55 MM _MOD_B | 1 |
| | 07071200 | ADESIVO JLG PUNTO DI SOLLEVAMENTO L= 40X66 MM | 8 |
| | 07240300 | ADESIVO DISTANZA 1 METRO SU TELE/RADIO COMANDI L= 75x35 MM _MOD_B | 1 |
| | 07668200 | ADESIVO EMERGENCY STOP E BLOCCHETTO ACCENSIONE L= 85x160 MM _MOD_B | 1 |
| | 07668300 | ADESIVO SELETTORE SCATOLA COMANDI TERRA / CESTO L= 105X155 MM | 1 |
| | 07799200 | ADESIVO REAZIONE AL SUOLO STABILIZZATORI LL1570 1670 daN L=45x48 MM | 4 |
| | 07839500 | ADESIVO SOLLEVAMENTO PIATTAFORMA CON MULETTO - PICCOLO L=65X50 MM | 4 |
| | 1001125483 | ADESIVO JLG VIETATO LAVARE L=63,5X63,5 MM | 7 |
| | 1608710002 | ADESIVO PULSANTI DISTRIBUTORE A TERRA LATO DX GL17.80 L L=150X50 MM _MOD_C | 1 |
| | 1701504 | ADESIVO JLG OLIO IDRAULICO L=50,8x63,5 MM (**) | 1 |
| | 1702155 | ADESIVO JLG STACCABATTERIA L= 63,5X50,80 MM | 1 |
| | 1703814 | ADESIVO JLG ATTACCO ANCORAGGIO L=55,56X76,2 MM | 4 |
| | 1704125 | ADESIVO JLG ATTACCO ARIA E OLIO L=25,4X76,2 MM | 1 |
| | 1704277 | ADESIVO JLG ATTACCO CINTURE DI SICUREZZA L= 76,2X19,05 MM | 2 |
| | 1705828 | ADESIVO JLG INTERUTTORE PEDALE L= 69,85X54 _MOD_B | 1 |
| | 1706098 | ADESIVO JLG PERICOLO ESPLOSIONE L=63,5X117,475 MM _MOD_B | 1 |
| | 1706493 | ADESIVO JLG SCORRIMENTO SBARRA CHIUSURA CESTO L= 76, 2X25,4 MM _MOD_B | 1 |
| | | | |
| | | | |
| | | | |
| | 07799500 | ADESIVO JLG PORTATA CESTO 1 PERSONA X15JPLUS L=135X145 MM “ non in distinta “ | 1 |
| | 07868400 | ADESIVO JLG PORTATA CESTO 1 PERSONA X13JPLUS L=135X145 MM “ non in distinta “ | 1 |

ELENCO ADESIVI IN LINGUA / LIST LANGUAGE STICKERS

COD. / CODE 177881IT_177881GB_177881FR_177881DE_177881ES_177881NL_177881PT_177881SW_177881DA_177881NO_177881FI

| Num. | COD. | DESCRIZIONE / DESCRIPTION | Q.tà |
|------|----------|--|------|
| | 177881IT | ADESIVI IN LINGUA PER JLG/CE X15JPLUS - LINGUA ITALIANO | |
| L1 | 06555300 | ADESIVO USO PIATTAFORMA AEREA CINGOLATA - ITALIANO L=128X230 _MOD_C | 01 |
| L2 | 078255IT | ADESIVO DISCESA DI EMERG. LL15.70 MOTORE TERMICO E LITHIUM - ITALIANO L=290X205 MM | 01 |
| | | | |
| | 177881GB | ADESIVI IN LINGUA PER JLG/CE X15JPLUS - LINGUA INGLESE | |
| L1 | 06562600 | ADESIVO USO PIATTAFORMA AEREA CINGOLATA - INGLESE L=128X230 _MOD_C | 01 |
| L2 | 078255GB | ADESIVO DISCESA DI EMERG. LL15.70 MOTORE TERMICO E LITHIUM - INGLESE L=290X205 MM | 01 |
| | | | |
| | 177881FR | ADESIVI IN LINGUA PER JLG/CE X15JPLUS - LINGUA FRANCESE | |
| L1 | 06562700 | ADESIVO USO PIATTAFORMA AEREA CINGOLATA - FRANCESE L=128X230 _MOD_C | 01 |
| L2 | 078255FR | ADESIVO DISCESA DI EMERG. LL15.70 MOTORE TERMICO E LITHIUM - FRANCESE L=290X205 MM | 01 |
| | | | |
| | 177881DE | ADESIVI IN LINGUA PER JLG/CE X15JPLUS - LINGUA TEDESCO | |
| L1 | 06562800 | ADESIVO USO PIATTAFORMA AEREA CINGOLATA - TEDESCO L=128X230 _MOD_C | 01 |
| L2 | 078255DE | ADESIVO DISCESA DI EMERG. LL15.70 MOTORE TERMICO E LITHIUM - TEDESCO L=290X205 MM | 01 |
| | | | |
| | 177881ES | ADESIVI IN LINGUA PER JLG/CE X15JPLUS - LINGUA SPAGNOLO | |
| L1 | 06562900 | ADESIVO USO PIATTAFORMA AEREA CINGOLATA - SPAGNOLO L=128X230 _MOD_C | 01 |
| L2 | 078255ES | ADESIVO DISCESA DI EMERG. LL15.70 MOTORE TERMICO E LITHIUM - SPAGNOLO L=290X205 MM | 01 |
| | | | |
| | 177881NL | ADESIVI IN LINGUA PER JLG/CE X15JPLUS - LINGUA OLANDESE | |
| L1 | 06563000 | ADESIVO USO PIATTAFORMA AEREA CINGOLATA - OLANDESE L=128X230 _MOD_C | 01 |
| L2 | 078255NL | ADESIVO DISCESA DI EMERG. LL15.70 MOTORE TERMICO E LITHIUM - OLANDESE L=290X205 MM | 01 |

ELENCO ADESIVI IN LINGUA / LIST LANGUAGE STICKERS

COD. / CODE 177881IT_177881GB_177881FR_177881DE_177881ES_177881NL_177881PT_177881SW_177881DA_177881NO_177881FI

| Num. | COD. | DESCRIZIONE / DESCRIPTION | Q.tà |
|------|----------|--|------|
| | 177881PT | ADESIVI IN LINGUA PER JLG/CE X15JPLUS - LINGUA PORTOGHESE | |
| L1 | 06563100 | ADESIVO USO PIATTAFORMA AEREA CINGOLATA - PORTOGHESE L=128X230 _MOD_C | 01 |
| L2 | 078255PT | ADESIVO DISCESA DI EMERG. LL15.70 MOTORE TERMICO E LITHIUM - PORTOGHESE L=290X205 MM | 01 |
| | | | |
| | 177881SW | ADESIVI IN LINGUA PER JLG/CE X15JPLUS - LINGUA SVEDESE | |
| L1 | 07137300 | ADESIVO USO PIATTAFORMA AEREA CINGOLATA - SVEDESE L= 128X230 MM _MOD_C | 01 |
| L2 | 078255SW | ADESIVO DISCESA DI EMERG. LL15.70 MOTORE TERMICO E LITHIUM - SVEDESE L=290X205 MM | 01 |
| | | | |
| | 177881DA | ADESIVI IN LINGUA PER JLG/CE X15JPLUS - LINGUA DANESE | |
| L1 | 07138100 | ADESIVO USO PIATTAFORMA AEREA CINGOLATA - DANESE L= 128X230 MM _MOD_C | 01 |
| L2 | 078255DA | ADESIVO DISCESA DI EMERG. LL15.70 MOTORE TERMICO E LITHIUM - DANESE L=290X205 MM | 01 |
| | | | |
| | 177881NO | ADESIVI IN LINGUA PER JLG/CE X15JPLUS - LINGUA NORVEGESE | |
| L1 | 07162000 | ADESIVO USO PIATTAFORMA AEREA CINGOLATA - NORVEGESE L=128X230 MM _MOD_C | 01 |
| L2 | 078255NO | ADESIVO DISCESA DI EMERG. LL15.70 MOTORE TERMICO E LITHIUM - NORVEGESE L=290X205 MM | 01 |
| | | | |
| | 177881PL | ADESIVI IN LINGUA PER JLG/CE X15JPLUS - LINGUA NORVEGESE | |
| L1 | 07506600 | ADESIVO USO PIATTAFORMA AEREA CINGOLATA - POLACCO L= 128X230 MM _MOD_B** | 01 |
| L2 | 078255PL | ADESIVO DISCESA DI EMERG. LL15.70 MOTORE TERMICO E LITHIUM - POLACCO L=290X205 MM | 01 |
| | | | |
| | 177881FI | ADESIVI IN LINGUA PER JLG/CE X15JPLUS - LINGUA FINLANDESE | |
| L1 | 07547700 | ADESIVO USO PIATTAFORMA AEREA CINGOLATA - FINLANDESE L= 128X230 MM _MOD_B | 01 |
| L2 | 078255FI | ADESIVO DISCESA DI EMERG. LL15.70 MOTORE TERMICO E LITHIUM - FINLANDESE L=290X205 MM | 01 |

AGGIORNATO IL / UPDATED 02/11/2016

**KIT ADESIVI COMMERCIALI PER PIATTAFORMA AEREA /
*STICKERS KIT COMMERCIAL FOR AERIAL PLATFORM***

JLG/CE X15JPLUS

Cod. 17788200

DA USARE CON / FOR USE WITH
COD. 17788100 *KIT ADESIVI DI SICUREZZA PER PIATTAFORMA AEREA / STICKER KITS SECURETY AERIAL
PLATFORM*

A STABILIZZATORI CHIUSI CENTRARE SUL BRACCIO SIA IN ALTEZZA CHE IN LARGHEZZA IL LOGO JLG LIFT
A CLOSED CENTRALISE REGULATORS ON ARM IS IN HEIGHT TO WIDTH IN THE LOGO JLG LIFT

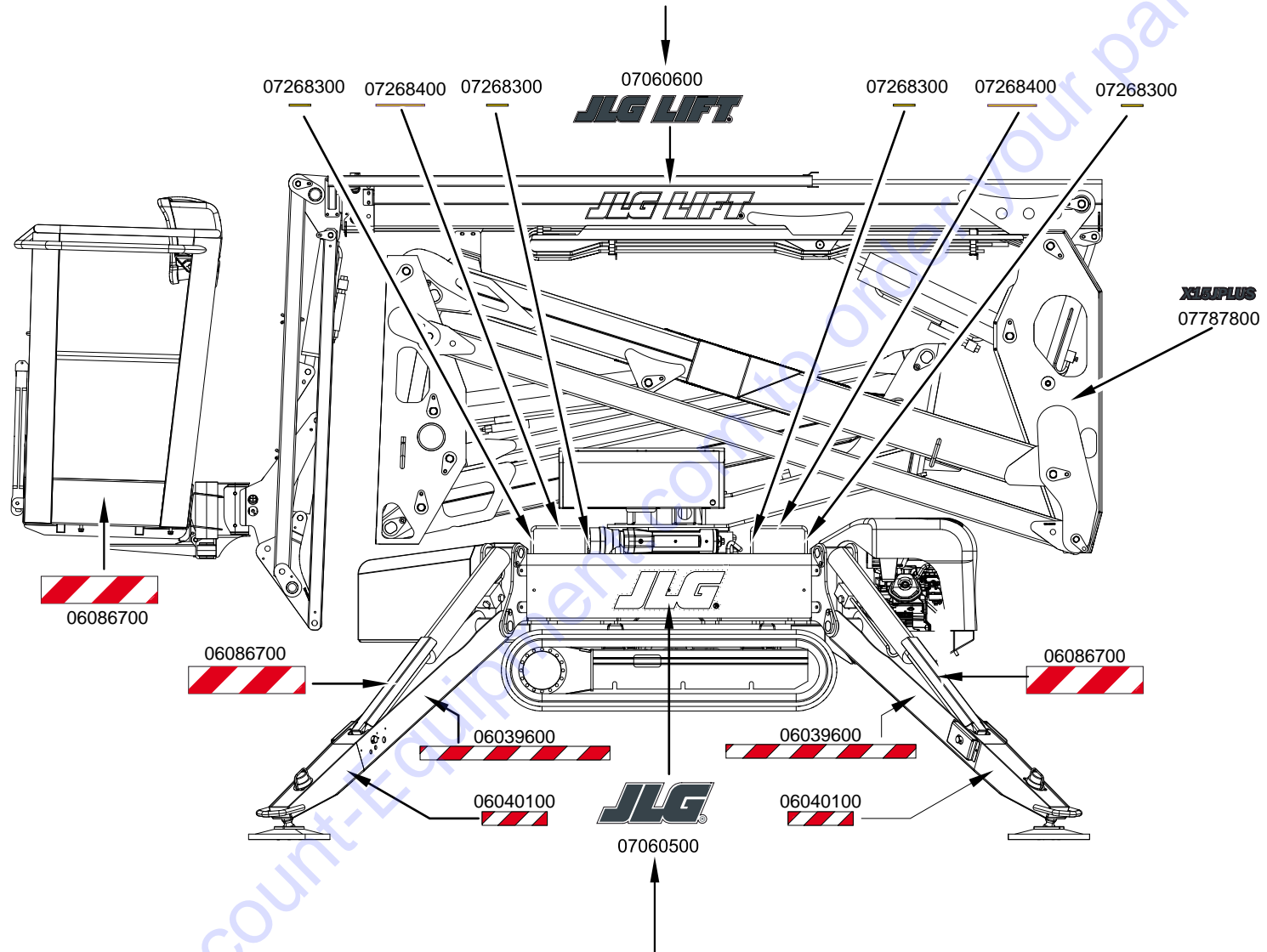

A STABILIZZATORI CHIUSI CENTRARE SUL COPERCHIO SIA IN ALTEZZA CHE IN LARGHEZZA IL LOGO JLG
A CLOSED CENTRALISE REGULATORS ON THE COVER IS IN HEIGHT TO WIDTH IN THE LOGO JLG

A STABILIZZATORI CHIUSI CENTRARE SUL BRACCIO SIA IN ALTEZZA CHE IN LARGHEZZA IL LOGO JLG LIFT
A CLOSED CENTRALISE REGULATORS ON ARM IS IN HEIGHT TO WIDTH IN THE LOGO JLG LIFT

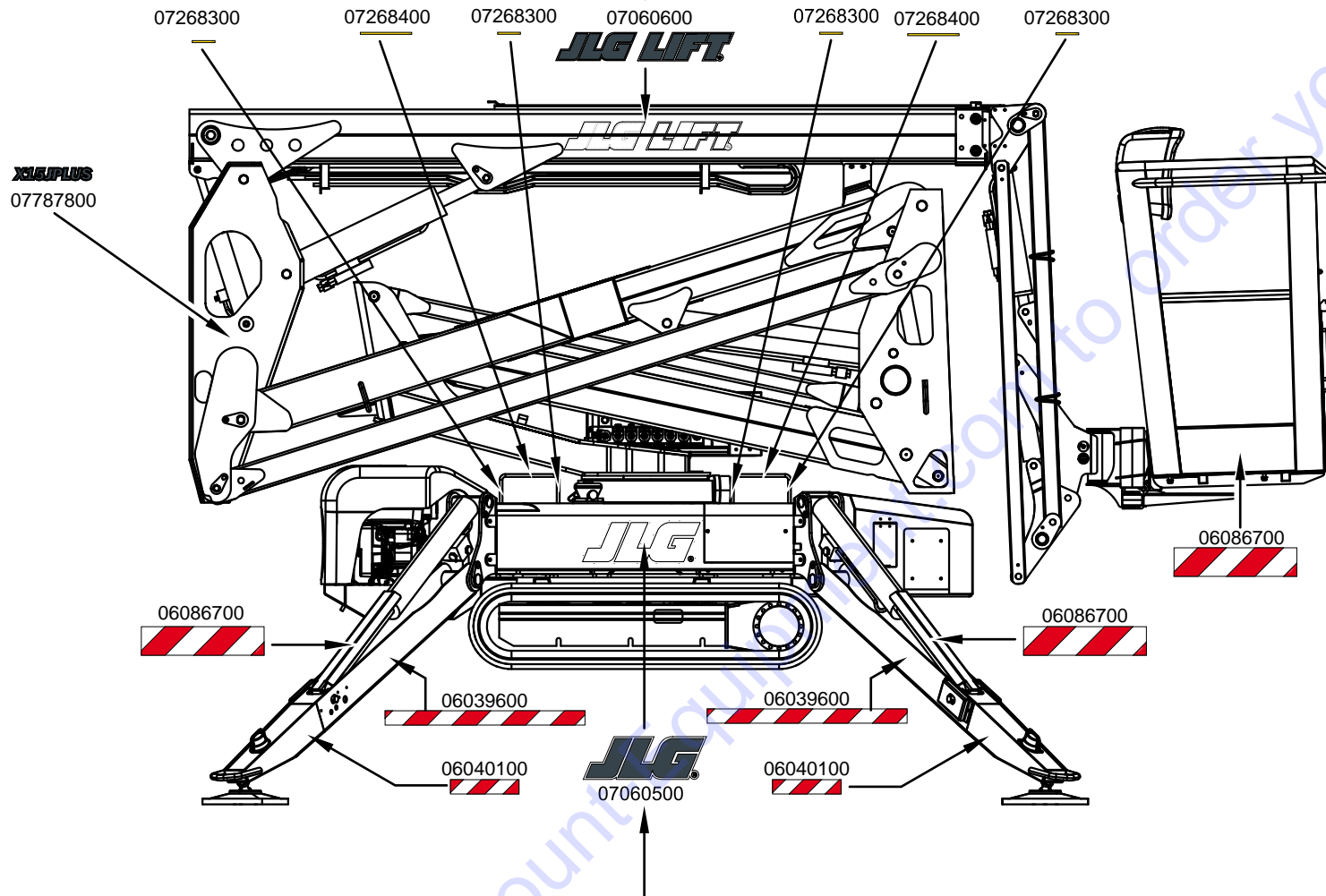

A STABILIZZATORI CHIUSI CENTRARE SUL COPERCHIO SIA IN ALTEZZA CHE IN LARGHEZZA IL LOGO JLG
A CLOSED CENTRALISE REGULATORS ON THE COVER IS IN HEIGHT TO WIDTH IN THE LOGO JLG

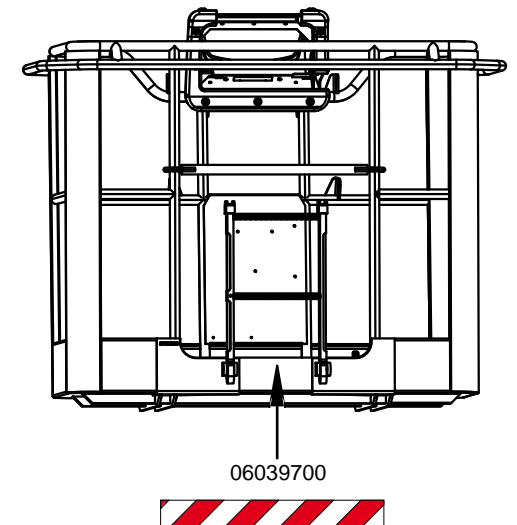



AGGIORNATO IL / UPDATED 15/05/2017

**KIT ADESIVI SICUREZZA PER PIATTAFORMA AEREA /
*STICKERS KIT SECURITY FOR AERIAL PLATFORM***

JLG/ANSI - X370AJ - JLG/ANSI X430AJ

Cod. 17788300

+ kit in lingua non incluso nel codice generale / *kit in the language not included in the general code*

177883GB / 177883FR / 177883ES / 177883PT

DA USARE CON / FOR USE WITH

**COD. 17859200 KIT ADESIVI COMMERCIALI PER PIATTAFORMA AEREA / *STICKER KITS COMMERCIAL AERIAL PLATFORM*
JLG/CE X370AJ**

DA USARE CON / FOR USE WITH

**COD. 17788400 KIT ADESIVI COMMERCIALI PER PIATTAFORMA AEREA / *STICKER KITS COMMERCIAL AERIAL PLATFORM*
JLG/CE X430AJ**

**16924900 KIT INTEGRAZIONE ADESIVI PIATTAFORME 3S LITHIUM /
*STICKER KIT INTEGRATION PLATFORM LITHIUM***

JLG/ANSI - X370AJ / X430AJ ELENCO ADESIVI / LIST STICKERS COD. 17788300

| ---- | COD. | DESCRIZIONE / DESCRIPTION | Q.tà |
|------|------------|--|------|
| | 06040500 | ADESIVO DIREZ. TRASLAZIONE FRECCIA GIALLA SFONDO NERO L=61 X 160 | 02 |
| | 06041600 | ADESIVO CARBURANTE BENZINA COLORE VERDE L=60 X 80 MM _MOD_B | 01 |
| | 06056300 | ADESIVO PERICOLO SCOTTATURE TRIANGOLARE SFONDO GIALLO L=60X51 MM | 01 |
| | 06060000 | ADESIVO LIVELLO OLIO MOTORE Ø50 MM | 01 |
| | 06136900 | ADESIVO PUNTI INGRASSAGGIO Ø 55 TESTO NERO - SFONDO BIANCO | 01 |
| | 06165000 | ADESIVO LIVELLO OLIO IDRAULICO Ø50 MM | 01 |
| | 06207700 | ADESIVO BATTERIA POLO POSITIVO POLO NEGATIVO BIANCO Ø50 | 01 |
| | 06232100 | ADESIVO JLG CARBURANTE BENZINA L= 101X63,5 (**)_ _MOD_B | 01 |
| | 06555500 | ADESIVO NR 1 L=50X60 BIANCO | 01 |
| | 06555600 | ADESIVO NR 2 L=50X60 BIANCO | 01 |
| | 06555700 | ADESIVO N° 3 L=50X60 BIANCO | 01 |
| | 06555800 | ADESIVO N° 4 L=50X60 BIANCO | 01 |
| | 06706500 | ADESIVO ALLINEAMENTO CESTO (2 PEZZI) L=16X50+13 MM | 01 |
| | 06998800 | ADESIVO DEVIATORE POMPA MANUALE PIATTAFORMA GL17.80XL L=86X34 MM | 01 |
| | 07056300 | ADESIVO JLG PERICOLO 220V - 50/60HZ L= 75X18,75 MM | 02 |
| | 07056700 | ADESIVO JLG DIVIETO DI SOLLEVAMENTO L=40X54,88 MM | 06 |
| | 07071000 | ADESIVO JLG CLAXON SU PIATTAFORME L=39,3X28,55 MM _MOD_B | 01 |
| | 07071200 | ADESIVO JLG PUNTO DI SOLLEVAMENTO L= 40X66 MM | 08 |
| | 07240300 | ADESIVO DISTANZA 1 METRO SU TELE/RADIO COMANDI L= 75x35 MM _MOD_B | 01 |
| | 07808100 | ADESIVO REAZIONE AL SUOLO STABILIZZATORI X430AJ L= 50X50 MM | 04 |
| | 07668200 | ADESIVO EMERGENCY STOP E BLOCCHETTO ACCENSIONE L=85x160 MM _MOD_B | 01 |
| | 07668300 | ADESIVO SELETTORE SCATOLA COMANDI TERRA / CESTO L=105X155 MM | 01 |
| | 07839500 | ADESIVO SOLLEVAMENTO PIATTAFORMA CON MULETTO - PICCOLO L=65X50 MM | 04 |
| | 1001125483 | ADESIVO JLG VIETATO LAVARE L=63,5X63,5 MM | 06 |

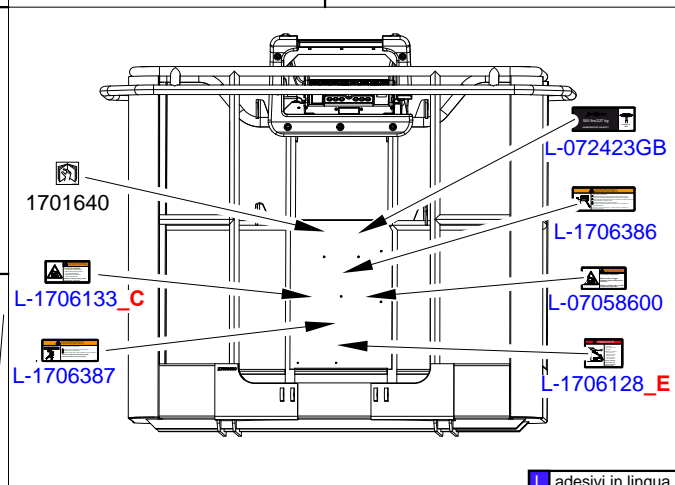
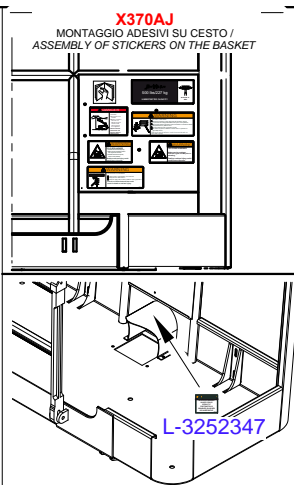
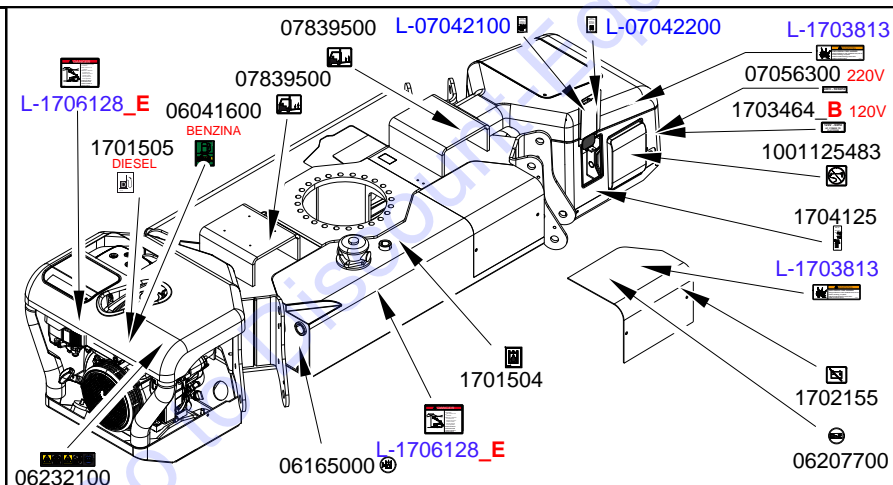
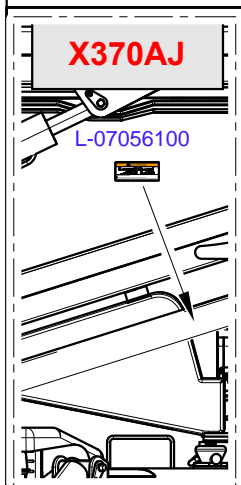
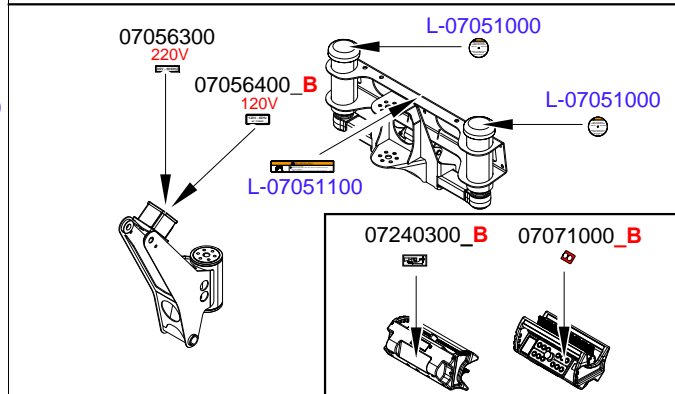
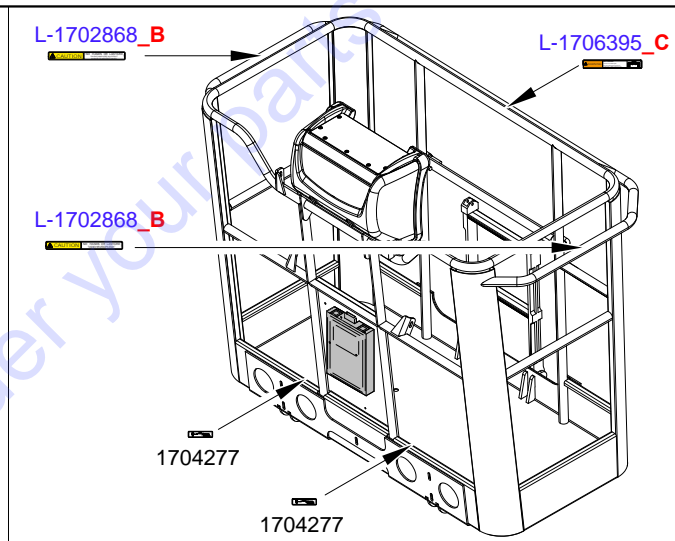
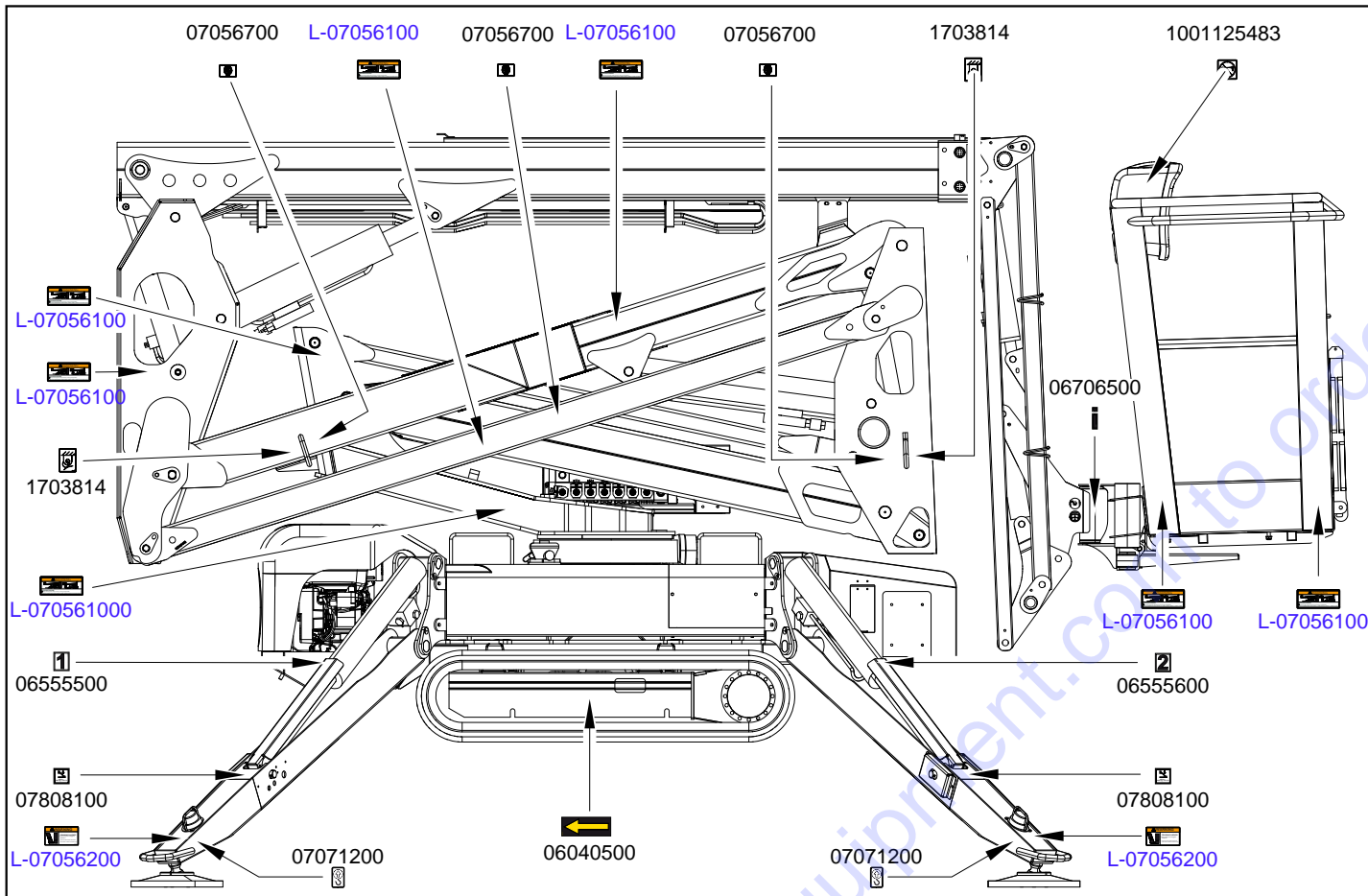

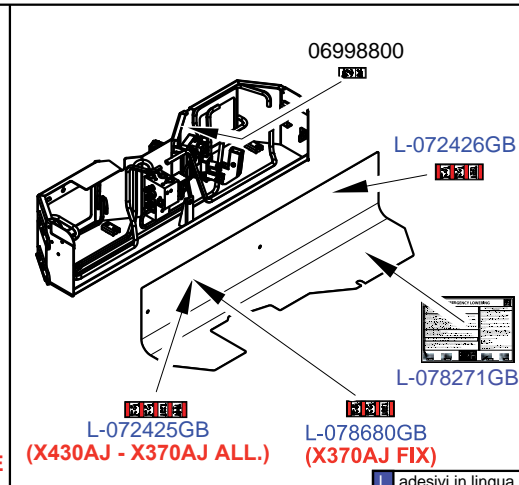
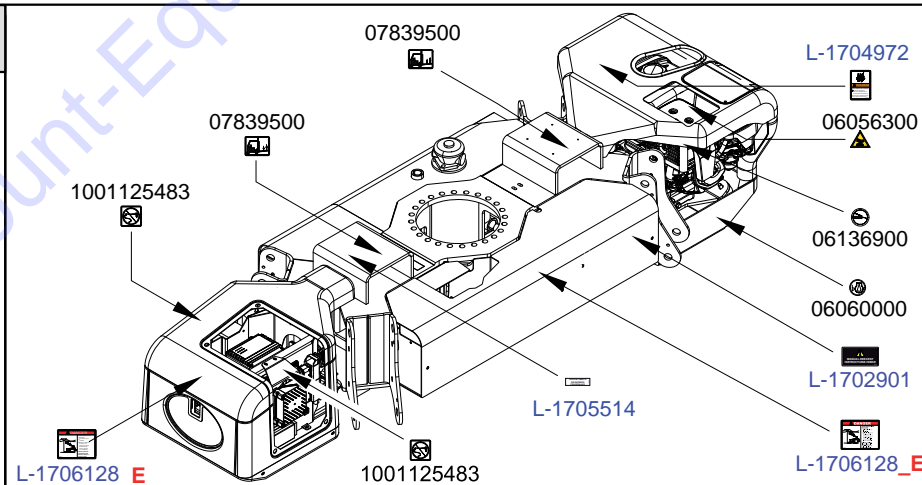
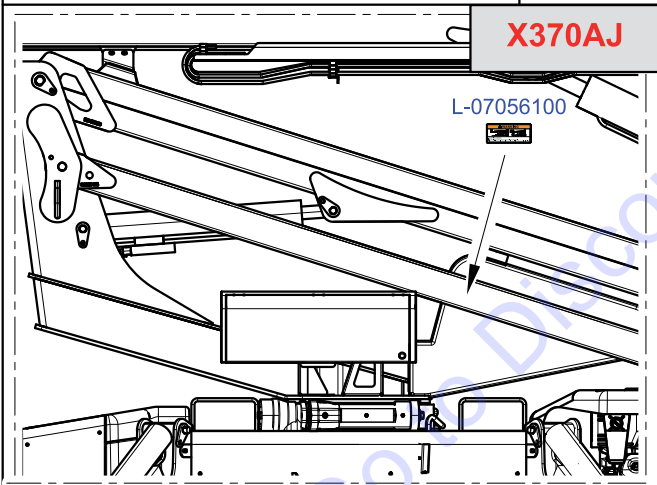
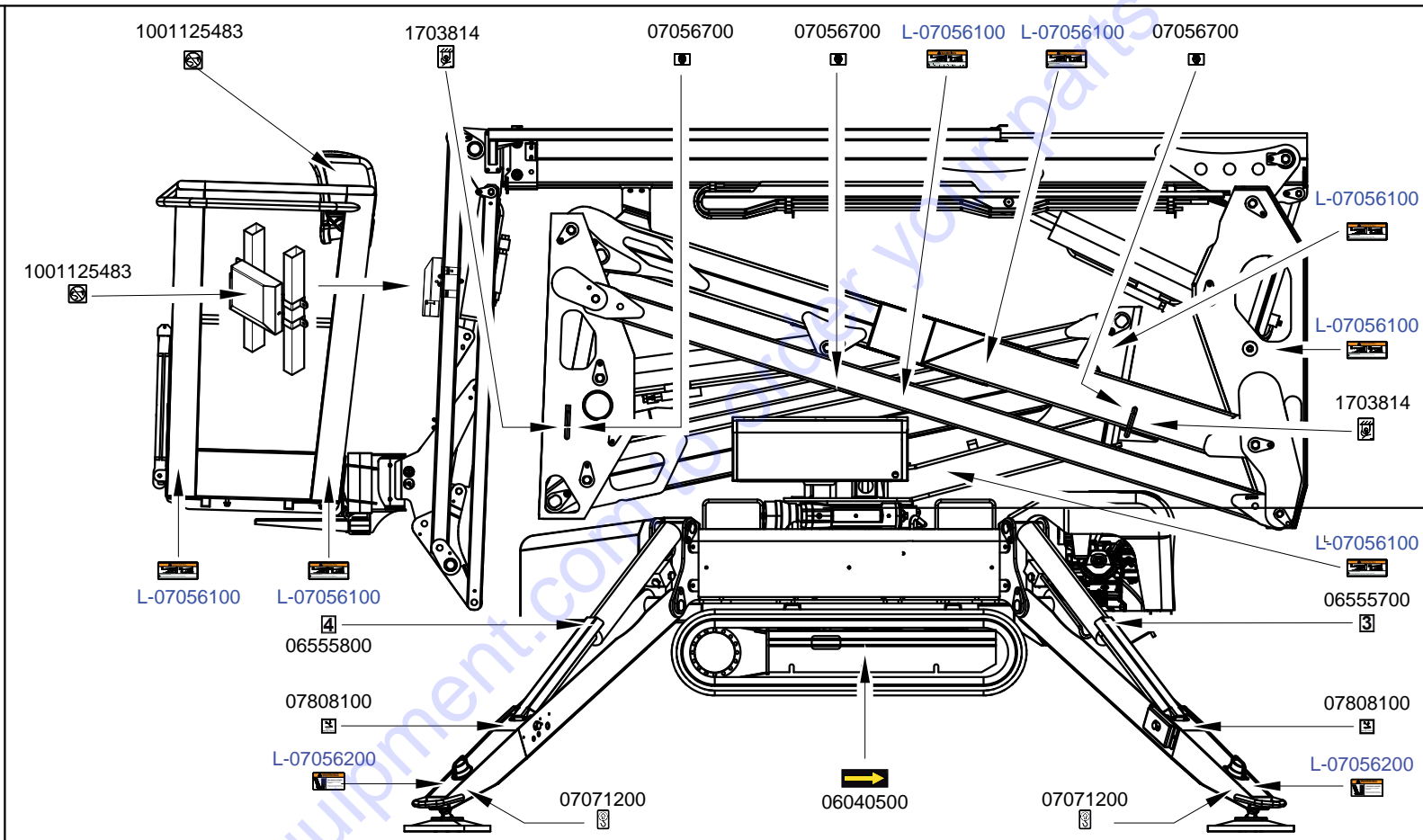
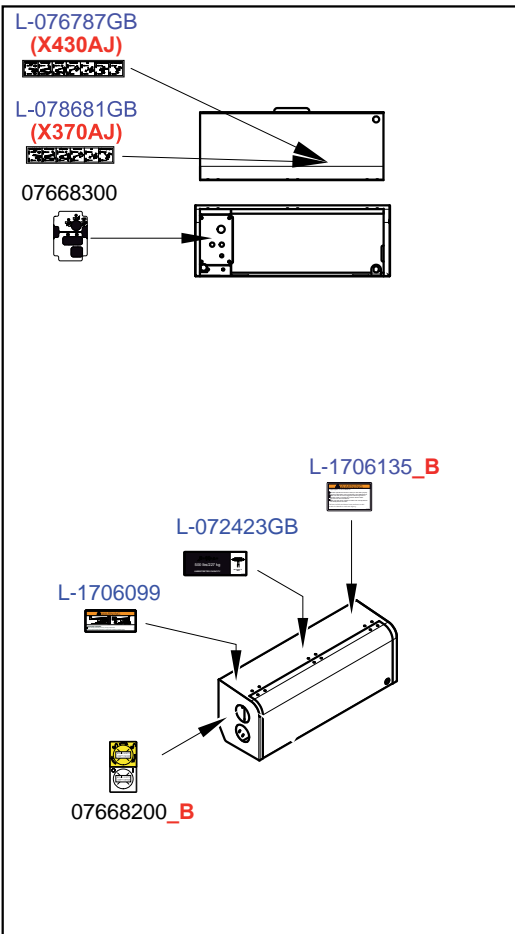

ELENCO ADESIVI IN LINGUA / LIST LANGUAGE STICKERS COD. / CODE 177883GB_177883FR_177883ES_177883PT

JLG

| COD. | | | | DESCRIZIONE / DESCRIPTION | Q.tà |
|----------|----------|----------|------------|--|------|
| 177883FR | 177883PT | 177883ES | 177883GB | ADESIVI IN LINGUA PER JLG/ANSI X430AJ - LINGUA INGLESE / FRANCESE / PORTOGHESE / SPAGNOLO | |
| 07115200 | 07119800 | | 07042100 | ADESIVO JLG SISTEMA BYPASS PARTE AEREA - ING L=30X50 (**) | 01 |
| 07115300 | 07119900 | | 07042200 | ADESIVO JLG SISTEMA BYPASS TRASLAZIONE - ING L= 30X50 (**) | 01 |
| 07116600 | 07121200 | | 07051000 | ADESIVO JLG ATTENZ.CADUTE - SBLOCCARE SOLO NEI CASI PREVISTI - ING D Ø 60 FORO 4 MM (**) | 02 |
| 07116700 | 07121300 | | 07051100_B | ADESIVO JLG PERICOLO CADUTA - RIPRISTINARE I TAPPI - ING L=196,5x35 MM _MOD_B | 01 |
| 07116800 | 07121400 | | 07056100 | ADESIVO JLG PERICOLO SCHIACCIAMENTO - ING L= 140x60,71 MM | 14 |
| 07116900 | 07121500 | | 07056200 | ADESIVO JLG ATTACCO SCHIACCIAMENTO ARTO INFERIORE - ING L= 110x60 MM (PRES. STABILIZZAZTORI | 04 |
| 07117200 | 07121800 | | 07058600 | ADESIVO JLG POSIZIONE STABILIZZATORI X390 - X550 - ING L= 139,7X69,85 MM | 01 |
| 072423FR | 072423PT | | 072423GB | ADESIVO JLG / ANSI CARICO MAX IN CESTA X500AJ - ING L=196, 85x76,2 MM | 02 |
| 072425FR | 072425PT | | 072425GB | ADESIVO JLG ANSI PULSANTI DISTRIBUTORI A TERRA LATO SX X500AJ - ING L=194X50 MM | 01 |
| 072426FR | 072426PT | | 072426GB | ADESIVO JLG ANSI PULSANTI DISTRIBUTORI A TERRA LATO DX X500AJ - ING L=150X50 MM | 01 |
| 078271FR | 078271PT | | 078271GB | ADESIVO JLG DISCESA DI EMERGENZA X430AJ MOTORE TERMICO E LITHIUM - ING L=290X205 MM | 01 |
| 076787FR | 076787PT | | 076787GB | ADESIVO JLG ANSI PULSANTI DISTRIBUTORE PARTE AEREA X770AJ - ING L=318X52 MM | 01 |
| 078680FR | 078680PT | | 078680GB | ADESIVO JLG/ANSI PULSANTI DISTRIBUTORE A TERRA X430AJ LATO SX - ING L=150X50 MM | 01 |
| 078681FR | 078681PT | | 078681GB | ADESIVO JLG/ANSI PULSANTI DISTRIBUTORE PARTE AEREA X430AJ - ING L=274X52 MM | 01 |
| 07117800 | 07122400 | | 1702868_B | ADESIVO JLG PERICOLO SCHIACCIAMENTO MANO - ING L= 241,30X25.40 MM _MOD_B (**) | 02 |
| 07117900 | 07122500 | | 1702901 | ADESIVO JLG ISTRUZIONI DISCESA EMERGENZA / POMPA MANUALE - ING L=114,3x58,73MM | 01 |
| 07118200 | 07122800 | | 1703813 | ADESIVO JLG PERICOLO ESPLOSIONE BATTERIE - ING L=149, 25X47,62 MM | 02 |
| 07892700 | 07892800 | | 1703464 | ADESIVO JLG PERICOLO 120 VOLT 60HZ - ING L= 75x32.68 MM _MOD_B | 02 |
| 07118300 | 07122900 | | 1704972_C | ADESIVO JLG PERICOLO ESPLOSIONE - ING L=63,5x92,07 MM _MOD_C | 01 |
| 07118400 | 07123000 | | 1705514 | ADESIVO JLG CONFORMITA' CSA - ING L= 76,20x22,22 MM | 01 |
| 07118500 | 07123100 | | 1706099 | ADESIVO JLG PERICOLO SCHIACCIAMENTO - ING L= 161,925X69, 85 MM (A TERRA) | 01 |
| 07118600 | 07123200 | | 1706128_E | ADESIVO JLG PERICOLO FOLGORAZIONE - ING L=120,65x91,50 MM _MOD_E | 05 |
| 07118700 | 07123300 | | 1706133_C | ADESIVO JLG PERICOLO RIBALTAMENTO - ING L=139,7X68,85 MM _MOD_C | 01 |



MACCHINA MODIFICATA CON PHOTOSHOP SOLO PER VISULIZZARE LA CENTRATURA DEI LOGHI JLG
MACHINE MODIFIED WITH PHOTOSHOP ONLY TO VIEW THE CENTER OF LOGOS JLG



MACCHINA MODIFICATA CON PHOTOSHOP SOLO PER VISULIZZARE LA CENTRATURA DEI LOGHI JLG
MACHINE MODIFIED WITH PHOTOSHOP ONLY TO VIEW THE CENTER OF LOGOS JLG

Go to Discount-Equipment.com to order your parts

AGGIORNATO IL / UPDATED 02/12/2016

**KIT ADESIVI COMMERCIALI PER PIATTAFORMA AEREA /
*STICKERS KIT COMMERCIAL FOR AERIAL PLATFORM***

JLG/ANSI X430AJ

Cod. 17788400

COD. 17788300 *DA USARE CON / FOR USE WITH*
KIT ADESIVI DI SICUREZZA PER PIATTAFORMA AEREA / STICKER KITS SECURITY AERIAL
PLATFORM

A STABILIZZATORI CHIUSI CENTRARE SUL BRACCIO SIA IN ALTEZZA CHE IN LARGHEZZA IL LOGO JLG LIFT
A CLOSED CENTRALISE REGULATORS ON ARM IS IN HEIGHT TO WIDTH IN THE LOGO JLG LIFT

centrare il logo in altezza e larghezza fra lo spazio rimanente
 center the logo in height and width among the remaining space

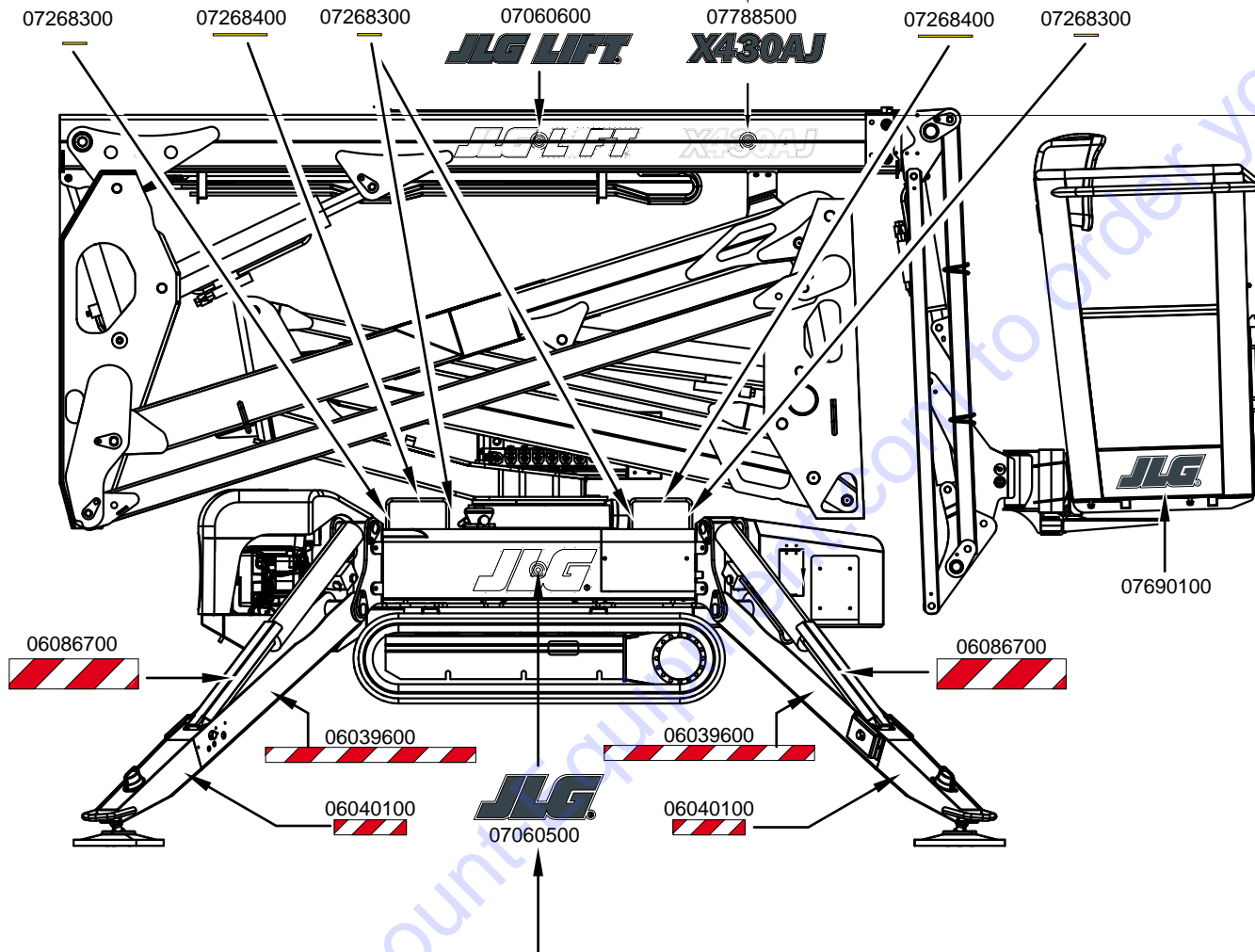

A STABILIZZATORI CHIUSI CENTRARE SUL COPERCHIO SIA IN ALTEZZA CHE IN LARGHEZZA IL LOGO JLG
A CLOSED CENTRALISE REGULATORS ON THE COVER IS IN HEIGHT TO WIDTH IN THE LOGO JLG

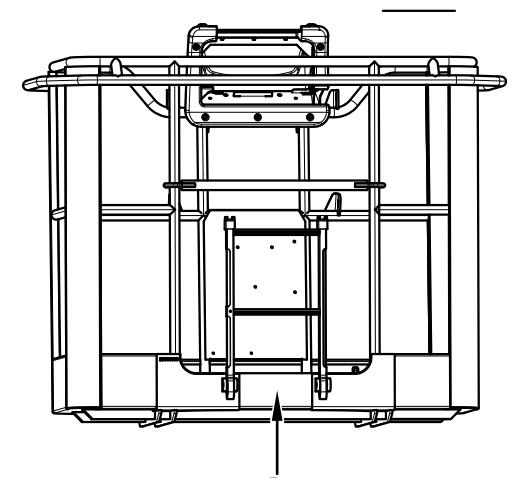

A STABILIZZATORI CHIUSI CENTRARE SUL BRACCIO SIA IN ALTEZZA CHE IN LARGHEZZA IL LOGO JLG LIFT
A CLOSED CENTRALISE REGULATORS ON ARM IS IN HEIGHT TO WIDTH IN THE LOGO JLG LIFT

centrare il logo in altezza e larghezza fra lo spazio rimanente
 center the logo in height and width among the remaining space

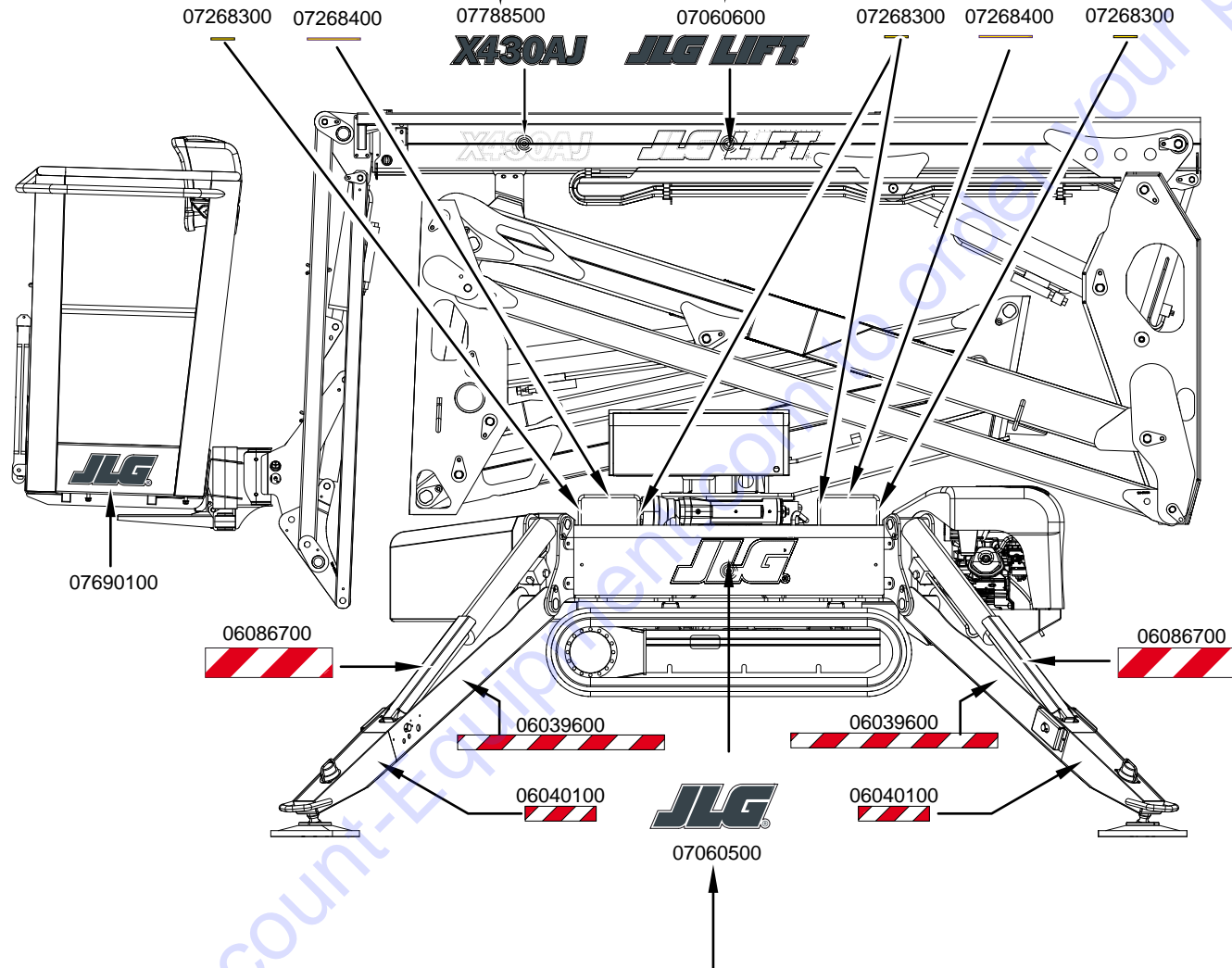

A STABILIZZATORI CHIUSI CENTRARE SUL COPERCHIO SIA IN ALTEZZA CHE IN LARGHEZZA IL LOGO JLG
A CLOSED CENTRALISE REGULATORS ON THE COVER IS IN HEIGHT TO WIDTH IN THE LOGO JLG



Go to Discount-Equipment.com to order your parts

TABELLA PERNI/SPINE (PINS TABLE)

LOCKING SYSTEM
GHIERA
(LOCKNUTS CODE)
REF. TABLE BELOW

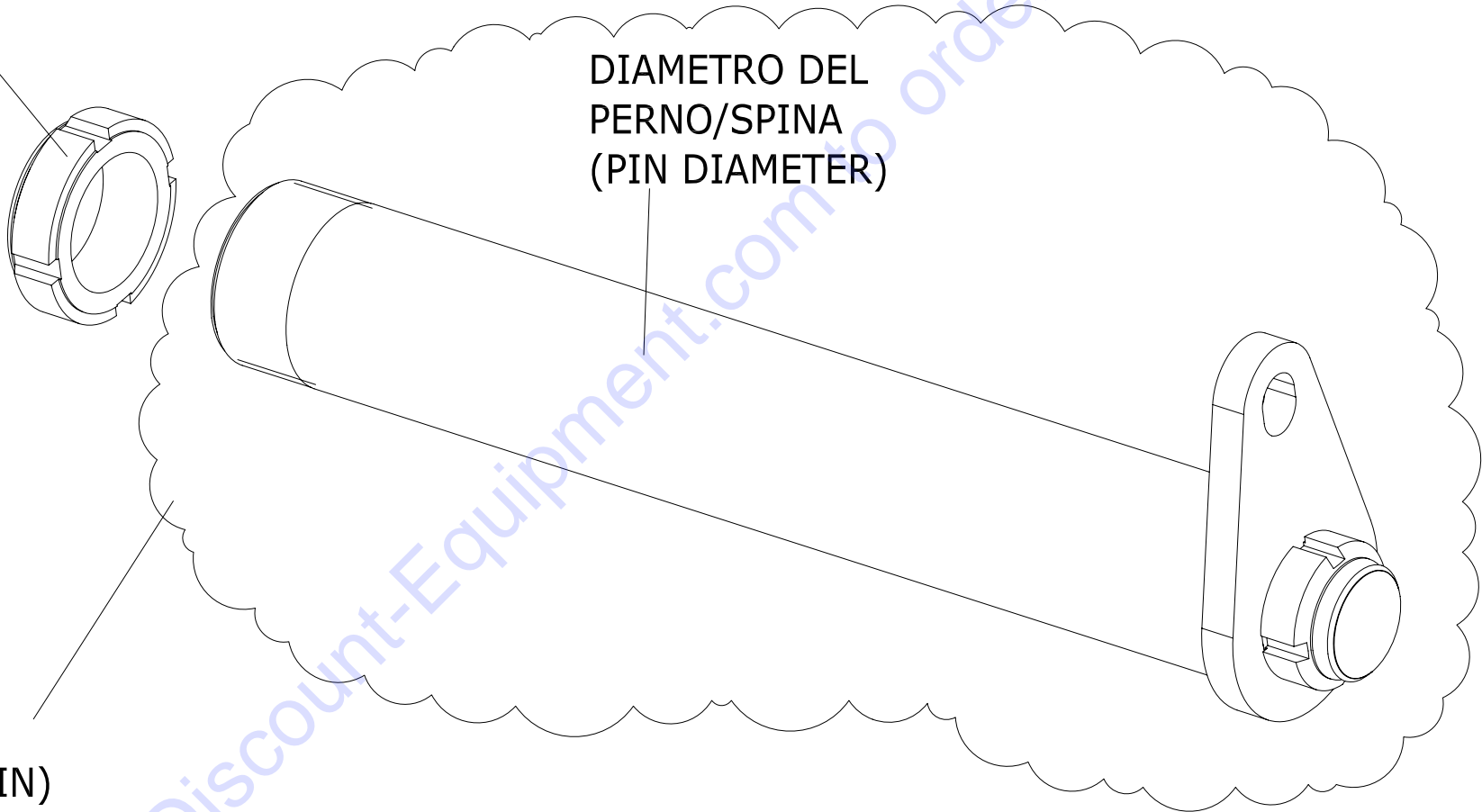

PERNO/SPINA (PIN)

IL CODICE DEL PERNO A RICAMBIO COMPRENDE LA GOCCIA MONTATA E LA GHIERA DI FISSAGGIO DELLA GOCCIA



THE CODE OF A PIN INCLUDES DROP PARTS MOUNTED AND THE LOCK NUT TO FIXING THE DROP, ALL THESE PARTS ARE SHIPPED ALREADY MOUNTED TOGETHER

| DIAMETRO DEL PERNO/SPINA mm SISTEMA METRICO (PIN DIAMETER mm METRIC) | GHIERA (LOCKNUTS CODE) | DADO (NUTS CODE) |
|---|-------------------------------|-------------------------|
| 25 | BG4 | |
| 30 | BG5 | |
| 35 | BG3 | |
| 40 | BG2 | |
| 45 | BG7 | |
| 50 | BG8 | |
| 20 (DIAMETER OF THREADED PART M17 PITCH=1) | BG1 | |
| 20 (DIAMETER OF THREADED PART M20 PITCH=1) | BG6 | |
| 20 (DIAMETER OF THREADED PART M20 PITCH=1,5) | BG12 | |

Go to Discount-Equipment.com to Order your parts

| POS | Codice | U.M. |  Descrizione |  Description |
|-----|----------|------|---|---|
| BC1 | BC000100 | NR | COPPIGLIA 4X40 | COTTER PIN 4x40 |
| BC2 | BC000200 | NR | COPPIGLIA 5X40 | COTTER PIN 5x40 |
| BC3 | BC000300 | NR | SEEGER ESTERNO Ø20 GEOMET | SEEGER EXTERNAL Ø20 GEOMET |
| BC4 | BC000400 | NR | SEEGER ESTERNO Ø8 | SEEGER EXTERNAL Ø8 |
| BC5 | BC000500 | NR | SEEGER ESTERNO Ø25 GEOMET | SEEGER EXTERNAL Ø25 GEOMET |
| BC6 | BC000600 | NR | COPPIGLIA 1,8X8 | COTTER PIN 1,8X8 |
| BC7 | BC000700 | NR | COPPIGLIA 4X55 | COTTER PIN 4x55 |
| BC8 | BC000800 | NR | SEEGER ESTERNO Ø15 | SEEGER EXTERNAL Ø15 |
| BC9 | BC000900 | NR | SEEGER ESTERNO Ø30 | SEEGER EXTERNAL Ø30 |
| BD1 | BD000100 | NR | Dado Esagonale Flangiato Liscio PG DIN 6923 CI 8 M 14 Z.Bianca | Hex Flange Nut DIN 6923 CI Smooth PG 8 M 14 Z. white |
| BD2 | BD000200 | NR | Dado Esagonale Basso PG DIN 936 CI 04 M 8 Z.Bianca | Low Hex nut DIN 936 PG 04 M CI 8 Z. white |
| BD3 | BD000300 | NR | Dado Esagonale Alto PG UNI 5587 CI 8 M 8 Z.Bianca | Hex Nut High PG UNI 5587 CI 8 M 8 Z. white |
| BD4 | BD000400 | NR | Dado Alto Autobloccante PG DIN 982 CI 8 M 12 Z.Bianca | High Self Locking Nut DIN 982 PG 12 CI 8 M Z. white |
| BD5 | BD000500 | NR | Dado Alto Autobloccante PG DIN 982 CI 8 M 8 Z.Bianca | High Self Locking Nut DIN 982 PG CI 8 M 8 Z. white |
| BD6 | BD000600 | NR | Dado Esagonale Alto PG UNI 5587 CI 8 M 4 Z.Bianca | Hex Nut High PG UNI 5587 M 4 CI 8 Z. white |
| BD7 | BD000700 | NR | Dado Esagonale Basso PG DIN 936 CI 04 M 6 Z.Bianca | Low Hex nut DIN 936 PG 6 CI 04 M Z. white |
| BD8 | BD000800 | NR | Dado Basso Autobloccante PG DIN 985 CI 8 M 6 Z.Bianca | Low Self-locking nut DIN 985 PG 6 CI 8 M Z. white |
| BD9 | BD000900 | NR | Dado Alto Autobloccante PG DIN 982 CI 8 M 6 Z.Bianca | High Self Locking Nut DIN 982 PG CI 8 M6 Z. white |

| POS | Codice | U.M. |  Descrizione |  Description |
|------|----------|------|---|---|
| BD10 | BD001000 | NR | Dado Basso Autobloccante PG DIN 985 CI 8 M 5 Z.Bianca | Low Self-locking nut DIN 985 PG CI 8 M5 Z. white |
| BD11 | BD001100 | NR | Dado Alto Autobloccante PG DIN 982 CI 8 M 5 Z.Bianca | High Self Locking Nut DIN 982 PG CI 8 M5 Z. white |
| BD12 | BD001200 | NR | Dado Alto Autobloccante PG DIN 982 CI 8 M 4 Z.Bianca | High Self Locking Nut DIN 982 PG CI 8 M4 Z. white |
| BD13 | BD001300 | NR | Dado Alto Autobloccante PG DIN 982 CI 8 M 3 Z.Bianca | High Self Locking Nut DIN 982 PG CI 8 M3 Z. white |
| BD14 | BD001400 | NR | Dado Alto Autobloccante PF DIN 982 CI 8 M 20 x 1,5 Z.Bianca | High Self Locking Nut DIN 982 PF CI 8 M 20 x 1.5 Z white |
| BD15 | BD001500 | NR | Dado Alto Autobloccante PG DIN 982 CI 8 M 10 Z.Bianca | High Self Locking Nut DIN 982 PG CI 8 M10 Z. white |
| BD16 | BD001600 | NR | Dado Esagonale Alto PG UNI 5587 CI 8 M 3 Z.Bianca | Hex Nut High PG UNI 5587 CI 8 M3 Z. white |
| BD17 | BD001700 | NR | Dado Basso Autobloccante PG DIN 985 CI 8 M 8 Z.Bianca | Low Self-locking nut DIN 985 PG CI 8 M8 Z. white |
| BD18 | BD001800 | NR | Dado Alto Autobloccante PG DIN 982 CI 8 M 16 Z.Bianca | High Self Locking Nut DIN 982 PG CI 8 M16 Z. white |
| BD22 | BD002200 | NR | Dado Alto Autobloccante PG DIN 982 CI 8 M 14 Z.Bianca | Hex Flange Nut DIN 982 CI 8 M 14 Z. white |
| BD23 | BD002300 | NR | Dado Basso Autobloccante PG DIN 985 CI 8 M 10 Z.Bianca | Low Self-locking nut DIN 985 PG CI 8 M 10 Z. white |
| BD24 | BD002400 | NR | Dado Alto Autobloccante PG DIN 982 CI 8 M 24 Z.Bianca | High Self Locking Nut DIN 982 PG CI 8 M24 Z. white |
| BD25 | BD002500 | NR | Dado Esagonale Alto PG UNI 5587 CI 8 M 6 Z.Bianca | Hex Nut High PG UNI 5587 M 6 CI 8 Z. white |
| BD26 | BD002600 | NR | Dado Esagonale Alto PG UNI 5587 CI 10 M 10 Z.Bianca | Hex Nut High PG UNI 5587 M 10 CI 10 Z. white |
| BD27 | BD002700 | NR | Dado Alto Autobloccante PG DIN 982 CI 8 M 18 Z.Bianca | High Self Locking Nut DIN 982 PG CI 8 M18 Z. white |
| BD28 | BD002800 | NR | Dado Basso Autobloccante PG DIN 985 CI 8 M 16 Z.Bianca | Low Self-locking nut DIN 985 PG CI 8 M 16 Z. white |
| BD29 | BD002900 | NR | Dado Esagonale Alto PG UNI 5587 CI 8 M 5 Z.Bianca | Hex Nut High PG UNI 5587 M 5 CI 8 Z. white |
| BD30 | BD003000 | NR | Dado Esagonale Alto PG UNI 5587 CI 12 M 5 Z.Bianca | Hex Nut High PG UNI 5587 M 5 CI 12 Z. white |

| POS | Codice | U.M. |  Descrizione |  Description |
|------|----------|------|---|---|
| BD31 | BD003100 | NR | Dado Esagonale Alto PG UNI 5587 CI 16 M 5 Z.Bianca | Hex Nut High PG UNI 5587 M 5 CI 16 Z. white |
| BD32 | BD003200 | NR | Dado Alto Autobloccante PG DIN 982 CI 8 M 20 Z.Bianca | High Self Locking Nut DIN 982 PG CI 8 M20 Z. white |
| BD33 | BD003300 | NR | Dado Basso Autobloccante PG DIN 985 CI 8 M 12 Z.Bianca | Low Self-locking nut DIN 985 PG CI 8 M 12 Z. white |
| BG1 | BG000100 | NR | Ghiera autobloccante GN CI 6 GN 3 D. 17 x 1 Z.Bianca | Self-locking nut GN GN 3 CI 6 D. 17 x 1 Z. white |
| BG2 | BG000200 | NR | Ghiera autobloccante pesante CI 6 GUP 40 x 1,5 Z.Bianca | Self-locking nut heavy CI 6 GUP 40 x 1.5 Z white |
| BG3 | BG000300 | NR | Ghiera autobloccante pesante CI 6 GUP 35 x 1,5 Z.Bianca | Self-locking nut heavy CI 6 GUP 35 x 1.5 Z white |
| BG4 | BG000400 | NR | Ghiera autobloccante pesante CI 6 GUP 25 x 1,5 Z.Bianca | Self-locking nut heavy CI 6 GUP 25 x 1.5 Z white |
| BG5 | BG000500 | NR | Ghiera autobloccante pesante CI 6 GUP 30 x 1,5 Z.Bianca | Self-locking nut heavy CI 6 GUP 30 x 1.5 Z white |
| BG6 | BG000600 | NR | Ghiera autobloccante pesante CI 6 GUP 20 x 1 Z.Bianca | Self-locking nut heavy CI 6 GUP 20 x 1 Z. white |
| BG7 | BG000700 | NR | Ghiera autobloccante GN CI 6 GN 3 D. 45 x 1,5 Z.Bianca | NUT |
| BG8 | BG000800 | NR | Ghiera autobloccante GN CI 6 GN 3 D. 50 x 1,5 Z.Bianca | NUT |
| BG9 | BG000900 | NR | Ghiera autobloccante GN CI 6 GN 3 D. 20 x 1,5 Z.Bianca | NUT |
| BG10 | BG001000 | NR | Ghiera autobloccante ribassata CI 6 GUK 25 x 1,5 Z.Bianca | Self-locking nut lowered CI 6 GUK 25 x 1.5 Z.Bianca |
| BG11 | BG001100 | NR | Ghiera autobloccante ribassata CI 6 GUK 20 x 1 Z.Bianca | Self-locking nut lowered CI 6 GUK 20 x 1 Z.Bianca |
| BG12 | BG001200 | NR | Ghiera autobloccante ribassata CI 6 GUA 20 x 1.5 Z.Bianca | Self-locking nut lowered CI 6 GUA 20 x 1.5 Z.Bianca |
| BG13 | BG001300 | NR | Ghiera autobloccante ribassata CI 6 GUK 30 x 1.5 Z.Bianca | Self-locking nut lowered CI 6 GUK 30 x 1.5 Z.Bianca |
| BG14 | BG001400 | NR | Ghiera autobloccante ribassata CI 6 GUK 45 x 1.5 Z.Bianca | Self-locking nut lowered CI 6 GUK 45 x 1.5 Z.Bianca |
| BG15 | BG001500 | NR | Ghiera autobloccante ribassata CI 6 GUK 50 x 1.5 Z.Bianca | Self-locking nut lowered CI 6 GUK 50 x 1.5 Z.Bianca |

| POS | Codice | U.M. |  Descrizione |  Description |
|------|----------|------|---|---|
| BG16 | BG001600 | NR | Ghiera autobloccante ribassata CI 6 GUK 55 x 1.5 Z.Bianca | Self-locking nut lowered CI 6 GUK 55 x 1.5 Z.Bianca |
| BI1 | BI000100 | NR | INSERTO ESAGONALE M6 | INSERT HEX M6 |
| BI2 | BI000200 | NR | INSERTO ESAGONALE M5 | INSERT HEX M5 |
| BI3 | BI000300 | NR | INSERTO CILINDRICO M4 | INSERT M4 |
| BI4 | BI000400 | NR | INSERTO CILINDRICO M6 | INSERT M6 |
| BI5 | BI000500 | NR | INSERTO ESAGONALE M8 | INSERT HEX M8 |
| BI6 | BI000600 | NR | INSERTO ESAGONALE M4 | INSERT HEX M4 |
| BR1 | BR000100 | NR | Grower sez.rett.spigoli vivi pesante UNI 9195 Acc.Molle D 6 Z.D.Bianca | Grower sez.rett. sharp heavy UNI 9195 Acc.Molle D 6 Z.D. white |
| BR2 | BR000200 | NR | Rondella Piana DIN 125-A HV100 D 4 Z.Bianca | Plain washer DIN 125-A HV100 D 4 Z. white |
| BR3 | BR000300 | NR | Rondella Piana DIN 125-A HV100 D 5 Z.Bianca | Plain washer DIN 125-A HV100 D 5 Z. white |
| BR4 | BR000400 | NR | Rondella Piana DIN 125-A HV100 D 6 Z.Bianca | Plain washer DIN 125-A HV100 D 6 Z. white |
| BR5 | BR000500 | NR | Rondella Piana DIN 125-A HV100 D 8 Z.Bianca | Plain washer DIN 125-A HV100 D 8 Z. white |
| BR6 | BR000600 | NR | Rondella Piana DIN 125-A HV100 D 10 Z.Bianca | Plain washer DIN 125-A HV100 D 10 Z. white |
| BR7 | BR000700 | NR | Rondella Piana DIN 125-A HV100 D 12 Z.Bianca | Plain washer DIN 125-A HV100 D 12 Z. white |
| BR8 | BR000800 | NR | Rosetta piana fascia larga e=3d DIN 9021 HV100 D 10 x 30 x 2,5 Z.Bianca | Wide band and flat washer DIN 9021 HV100 3d = D 10 x 30 x 2.5 Z white |
| BR9 | BR000900 | NR | Rosetta piana fascia larga e=3d DIN 9021 HV100 D 12 x 36 x 2,5 Z.Bianca | Wide band and flat washer DIN 9021 HV100 3d = D 12 x 36 x 2.5 Z white |
| BR10 | BR001000 | NR | Rondella x Carpenteria DIN 6916 HV 300 D 16 Z.Bianca | Carpentry washer DIN 6916 HV 300 D 16 Z white |

| POS | Codice | U.M. |  Descrizione |  Description |
|------|----------|------|---|---|
| BR11 | BR001100 | NR | Rosette speciali HV100 D 25 x 51 x 1 Z.Bianca | Special washers HV100 D 25 x 51 x 1 Z. white |
| BR13 | BR001300 | NR | Rondella dentellatura esterna DIN 6798-A Acc.Molle D 3 Z.D.Bianca | Washer external serration DIN 6798-A Acc.Molle D 3 ZD white |
| BR14 | BR001400 | NR | Rosetta piana fascia larga e=3d DIN 9021 HV100 D 5 x 15 x 1,2 Z.Bianca | Wide band and flat washer DIN 9021 HV100 3d = D 5 x 15 x 1.2 Z whit |
| BR15 | BR001500 | NR | Rosetta piana fascia larga e=3d DIN 9021 HV100 D 6 x 18 x 1,5 Z.Bianca | Wide band and flat washer DIN 9021 HV100 3d = D 6 x 18 x 1.5 Z white |
| BR16 | BR001600 | NR | Rosetta piana fascia larga e=3d DIN 9021 HV100 D 8 x 24 x 2 Z.Bianca | Wide band and flat washer DIN 9021 HV100 3d = D 8 x 24 x 2 Z. white |
| BR17 | BR001700 | NR | Rosetta piana fascia larga e=3d DIN 9021 HV100 D 4 x 12 x 1 Z.Bianca | Wide band and flat washer DIN 9021 HV100 D = 3d 4 x 12 x 1 Z. white |
| BR18 | BR001800 | NR | Rondella Piana DIN 125-A NYLON D 4 | Plain washer DIN 125-A NYLON D 4 |
| BR19 | BR001900 | NR | Rondella Piana DIN 125-A HV100 D 3 Z.Bianca | Plain washer DIN 125-A HV100 D 3 Z. white |
| BR20 | BR002000 | NR | Rondella Piana DIN 125-A HV100 D 16 Z.Bianca | Plain washer DIN 125-A HV100 D 16 Z. white |
| BR21 | BR002100 | NR | Rosetta piana fascia larga e=3d DIN 9021 HV100 D 16 x 48 x 4 Z.Bianca | Wide band and flat washer DIN 9021 HV100 3d = D 16 x 48 x 4 Z. white |
| BR22 | BR002200 | NR | Grower sez.rett.spigoli vivi pesante UNI 9195 Acc.Molle D 8 Z.D.Bianca | Grower section. rect. sharp heavy UNI 9195 Stainless Springs D 8 Z.D. white |
| BR23 | BR002300 | NR | Rosetta piana fascia larga e=3d DIN 9021 HV100 D 3 x 12 x 1 Z.Bianca | Wide band and flat washer DIN 9021 HV100 D = 3d 3 x 12 x 1 Z. white |
| BR24 | BR002400 | NR | Rosetta piana fascia larga e=3d DIN 9021 HV100 D 14 x 42 x 3 Z.Bianca | Wide band and flat washer DIN 9021 HV100 D = 3d 14 x 42 x 3 Z. white |
| BR25 | BR002500 | NR | Grower sez.rett.spigoli vivi pesante UNI 9195 Acc.Molle D 10 Z.D.Bianca | Grower sez.rett. sharp heavy UNI 9195 Acc.Molle D 10 Z.D. white |
| BR26 | BR002600 | NR | Rondella Piana DIN 125-A D 30 Z.Bianca | Plain washer DIN 125-A D 30 Z. white |
| BR27 | BR002700 | NR | Rondella Piana DIN 125-A HV100 D 14 Z.Bianca | Plain washer DIN 125-A HV100 D 14 Z. white |

| POS | Codice | U.M. |  Descrizione |  Description |
|------|----------|------|---|---|
| BR28 | BR002800 | NR | Rosetta piana fascia larga D 6 x 24 x 2 Z.Bianca | Wide band and flat washer D 6 x 24 x 2 Z white |
| BR29 | BR002900 | NR | Rondella Piana DIN 125-A HV100 D 18 Z.Bianca | Plain washer DIN 125-A HV100 D 18 Z. white |
| BR30 | BR003000 | NR | Rondella Piana DIN 125-A HV100 D 20 Z.Bianca | Plain washer DIN 125-A HV100 D 20 Z. white |
| BR31 | BR003100 | NR | Grower sez.rett.spigoli vivi pesante UNI 9195 Acc.Molle D 12 Z.D.Bianca | Grower sez.rett. sharp heavy UNI 9195 Acc.Molle D 12 Z.D. white |
| BR32 | BR003200 | NR | Rosette speciali HV100 D 30 x 42 x 0.5 Z.Bianca | Special washers HV100 D 30 x 42 x 0.5 Z. white |
| BR33 | BR003300 | NR | Rosette speciali HV100 D 30 x 61 x 1 Z.Bianca | Special washers HV100 D 30 x 61 x 1 Z. white |
| BR34 | BR003400 | NR | Rosette speciali HV100 D 42 x 52 x 0.2 Z.Bianca | Special washers HV100 D 42 x 52 x 0.2 Z. white |
| BR35 | BR003500 | NR | Rosette speciali HV100 D 42 x 52 x 0.3 Z.Bianca | Special washers HV100 D 42 x 52 x 0.3 Z. white |
| BR36 | BR003600 | NR | Rosette speciali HV100 D 42 x 52 x 1 Z.Bianca | Special washers HV100 D 42 x 52 x 1 Z. white |
| BR37 | BR003700 | NR | Rosette speciali HV100 D 42 x 52 x 1.5 Z.Bianca | Special washers HV100 D 42 x 52 x 1.5 Z. white |
| BR38 | BR003800 | NR | Rosette speciali HV100 D 42 x 52 x 2 Z.Bianca | Special washers HV100 D 42 x 52 x 2 Z. white |
| BR39 | BR003900 | NR | Rosetta piana fascia larga e=3d DIN 9021 HV100 D 18 x 48 x 4 Z.Bianca | Wide band and flat washer DIN 9021 HV100 3d = D 18 x 48 x 4 Z. white |
| BR40 | BR004000 | NR | Rosetta SCHNORR zincate D 6 | WASHER |
| BR41 | BR004100 | NR | Grower sez.rett.spigoli vivi pesante UNI 9195 Acc.Molle D 14 Z.D.Bianca | Grower sez.rett. sharp heavy UNI 9195 Acc.Molle D 14 Z.D. white |
| BR42 | BR004200 | NR | Rondella x Carpenteria DIN 6916 HV 300 D 14 Z.Bianca | Carpentry washer DIN 6916 HV 300 D 14 Z white |
| BR43 | BR004300 | NR | Rondella x Carpenteria DIN 125-A HV 300 D 10 Z.Bianca | Carpentry washer DIN 125-A HV 300 D 10 Z white |
| BR44 | BR004400 | NR | Rondella x Carpenteria DIN 125-A HV 300 D 20 Z.Bianca | Carpentry washer DIN 125-A HV 300 D 20 Z white |

| POS | Codice | U.M. |  Descrizione |  Description |
|------|----------|------|---|---|
| BS1 | BS000100 | NR | GRANO FILETTATO M6X12 | SCREW |
| BS2 | BS000200 | NR | SPINA CIL. 8x16 UNI 6364-A h6 CMT + TMP | PIN CYLINDER 8 x 16 UNI 6364-A CMT h6 + TMP |
| BS3 | BS000300 | NR | PRIGIONIERO M10X35 | PIN |
| BS4 | BS000400 | NR | SPINA ELASTICA 6X60 UNI 6873 | PIN |
| BS5 | BS000500 | NR | SPINA ELASTICA 6X14 UNI 6873 | PIN |
| BS6 | BS000600 | NR | Spina Spirol Normale DIN 7343 INOX A2 D 5x10 | PIN |
| BS7 | BS000700 | NR | Rivetto alluminio Ø3x12 | Aluminum rivet Ø3x12 |
| BV1 | BV000100 | NR | Vite TE Parziale Filetto PG DIN 931 CI 8.8 M 8 x 80 Z.Bianca | Screw Partial Thread DIN 931 PG CI 8.8 M 8 x 80 Z. white |
| BV2 | BV000200 | NR | Vite TE Tutto Filetto PG DIN 933 CI 8.8 M 8 x 60 Z.Bianca | Screw All Thread DIN 933 PG CI 8.8 M 8 x 60 Z. white |
| BV3 | BV000300 | NR | Vite TCEI PG DIN 912 CI 8.8 M 8 x 60 Z.Bianca | Screw DIN 912 PG CI 8.8 M8 x 60 Z. white |
| BV4 | BV000400 | NR | Vite TE Parziale Filetto PG DIN 931 CI 8.8 M 8 x 50 Z.Bianca | Screw Partial Thread DIN 931 PG CI 8.8 M 8 x 50 Z. white |
| BV5 | BV000500 | NR | Vite TCEI PG DIN 912 CI 8.8 M 8 x 45 Z.Bianca | Screw DIN 912 PG CI 8.8 M8 x 45 Z. white |
| BV6 | BV000600 | NR | Vite TCEI PG DIN 912 CI 8.8 M 8 x 40 Z.Bianca | Screw DIN 912 PG CI 8.8 M8 x 40 Z.Bianca |
| BV7 | BV000700 | NR | Vite TE Tutto Filetto PG DIN 933 CI 8.8 M 8 x 35 Z.Bianca | Screw All Thread DIN 933 PG CI 8.8 M 8 x 35 Z. white |
| BV8 | BV000800 | NR | Vite TE Tutto Filetto PG DIN 933 CI 8.8 M 8 x 30 Z.Bianca | Screw All Thread DIN 933 PG CI 8.8 M 8 x 30 Z. white |
| BV9 | BV000900 | NR | Vite TE Tutto Filetto PG DIN 933 CI 8.8 M 8 x 25 Z.Bianca | Screw All Thread DIN 933 PG CI 8.8 M 8 x 25 Z. white |
| BV10 | BV001000 | NR | Vite TCEI PG DIN 912 CI 8.8 M 8 x 25 Z.Bianca | Screw DIN 912 PG CI 8.8 M8 x 25 Z. white |
| BV11 | BV001100 | NR | Vite TE Tutto Filetto PG DIN 933 CI 8.8 M 8 x 20 Z.Bianca | Screw All Thread DIN 933 PG CI 8.8 M 8 x 20 Z. white |

| POS | Codice | U.M. |  Descrizione |  Description |
|------|----------|------|---|---|
| BV12 | BV001200 | NR | Vite TE Tutto Filetto PG DIN 933 CI 8.8 M 8 x 16 Z.Bianca | Screw All Thread DIN 933 PG CI 8.8 M 8 x 16 Z. white |
| BV13 | BV001300 | NR | Vite TCEI PG DIN 912 CI 8.8 M 8 x 16 Z.Bianca | Screw DIN 912 PG CI 8.8 M8 x 16 Z. white |
| BV14 | BV001400 | NR | Vite TE Tutto Filetto PG DIN 933 CI 8.8 M 8 x 14 Z.Bianca | Screw All Thread DIN 933 PG CI 8.8 M 8 x 14 Z. white |
| BV15 | BV001500 | NR | Vite TCEI PG DIN 912 CI 8.8 M 6 x 45 Z.Bianca | Screw DIN 912 M6 x 45 CI 8.8 Z. white |
| BV16 | BV001600 | NR | Vite TCEI PG DIN 912 CI 8.8 M 6 x 30 Z.Bianca | Screw DIN 912 M6 x 30 CI 8.8 Z. white |
| BV17 | BV001700 | NR | Vite TSPEI PG DIN 7991 CI 10.9 M 6 x 30 Z.Bianca | screw DIN 7991 CI 10.9 M 6 x 30 Z. white |
| BV18 | BV001800 | NR | Vite TE Tutto Filetto PG DIN 933 CI 8.8 M 6 x 30 Z.Bianca | Screw All Thread DIN 933 PG CI 8.8 M 6 x 30 Z. white |
| BV19 | BV001900 | NR | Vite TBEI PG ISO 7380 CI 10.9 M 6 x 30 Z.Bianca | screw ISO 7380 CI 10.9 M 6 x 30 Z. white |
| BV20 | BV002000 | NR | Vite TE Tutto Filetto PG DIN 933 CI 8.8 M 6 x 12 Z.Bianca | Screw All Thread DIN 933 PG CI 8.8 M 6 x 12 Z. white |
| BV21 | BV002100 | NR | Vite TCEI PG DIN 912 CI 8.8 M 6 x 12 Z.Bianca | Screw DIN 912 PG CI 8.8 M 6 x 12 Z. white |
| BV22 | BV002200 | NR | Vite TCEI PG DIN 912 CI 8.8 M 5 x 45 Z.Bianca | Screw DIN 912 PG CI 8.8 M 5 x 45 Z. white |
| BV23 | BV002300 | NR | Vite TE UNF ANSI B18.2.1 GR.5 5/16 x 1" Z.Bianca | Screw UNF ANSI B18.2.1 GR.5 5/16 x 1 "Z. White |
| BV24 | BV002400 | NR | Vite TC Croce PG DIN 7985 CI 4.8 M 4 x 8 Z.Bianca | Cross head screw DIN 7985 PG CI 4.8 M 4 x 8 Z. white |
| BV25 | BV002500 | NR | Vite TCEI PG DIN 912 CI 8.8 M 4 x 16 Z.Bianca | Screw DIN 912 PG CI 8.8 M 4 x 16 Z. white |
| BV26 | BV002600 | NR | Vite TCEI PG DIN 912 CI 8.8 M 6 x 50 Z.Bianca | Screw DIN 912 PG CI 8.8 M 6 x 50 Z. white |
| BV27 | BV002700 | NR | Vite TSPEI PG DIN 7991 CI 10.9 M 6 x 40 Z.Bianca | screw DIN 7991 CI 10.9 M 6 x 40 Z. white |
| BV28 | BV002800 | NR | Vite TSPEI PG DIN 7991 CI 10.9 M 6 x 25 Z.Bianca | screw DIN 7991 CI 10.9 M 6 x 25 Z. white |
| BV29 | BV002900 | NR | Vite TE Tutto Filetto PG DIN 933 CI 8.8 M 6 x 25 Z.Bianca | Screw All Thread DIN 933 PG CI 8.8 M 6 x 25 Z. white |

| POS | Codice | U.M. |  Descrizione |  Description |
|------|----------|------|---|---|
| BV30 | BV003000 | NR | Vite TE Tutto Filetto PG DIN 933 CI 8.8 M 6 x 22 Z.Bianca | Screw All Thread DIN 933 PG CI 8.8 M 6 x 22 Z. white |
| BV31 | BV003100 | NR | Vite TSPEI PG DIN 7991 CI 10.9 M 6 x 20 Z.Bianca | screw DIN 7991 CI 10.9 M 6 x 20 Z. white |
| BV32 | BV003200 | NR | Vite TE Tutto Filetto PG DIN 933 CI 8.8 M 6 x 20 Z.Bianca | Screw All Thread DIN 933 PG CI 8.8 M 6 x 20 Z. white |
| BV33 | BV003300 | NR | Vite TCEI PG DIN 912 CI 8.8 M 6 x 20 Z.Bianca | Screw DIN 912 PG CI 8.8 M 6 x 20 Z. white |
| BV34 | BV003400 | NR | Vite TE Tutto Filetto PG DIN 933 CI 8.8 M 6 x 16 Z.Bianca | Screw All Thread DIN 933 PG CI 8.8 M 6 x 16 Z. white |
| BV35 | BV003500 | NR | Vite TBEI PG ISO 7380 CI 10.9 M 6 x 16 Z.Bianca | screw ISO 7380 CI 10.9 M 6 x 16 Z. white |
| BV36 | BV003600 | NR | Vite TCEI PG DIN 912 CI 8.8 M 5 x 8 Z.Bianca | Screw DIN 912 PG CI 8.8 M 5 x 8 Z. white |
| BV37 | BV003700 | NR | Vite TSPEI PG DIN 7991 CI 10.9 M 5 x 60 Z.Bianca | screw DIN 7991 CI 10.9 M 5 x 60 Z. white |
| BV38 | BV003800 | NR | Vite TE Parziale Filetto PG DIN 931 CI 8.8 M 5 x 60 Z.Bianca | Screw Partial Thread DIN 931 PG CI 8.8 M 5 x 60 Z. white |
| BV39 | BV003900 | NR | Vite TCEI PG DIN 912 CI 8.8 M 5 x 60 Z.Bianca | Screw DIN 912 PG CI 8.8 M 5 x 60 Z. white |
| BV40 | BV004000 | NR | Vite TE Parziale Filetto PG DIN 931 CI 8.8 M 5 x 55 Z.Bianca | Screw Partial Thread DIN 931 PG CI 8.8 M 5 x 55 Z. white |
| BV41 | BV004100 | NR | Vite TE Tutto Filetto PG DIN 933 CI 8.8 M 5 x 16 Z.Bianca | Screw All Thread DIN 933 PG CI 8.8 M 5 x 16 Z. white |
| BV42 | BV004200 | NR | Vite TC Croce PG DIN 7985 CI 4.8 M 5 x 16 Z.Bianca | Cross head screw DIN 7985 PG CI 4.8 M 5 x 16 Z. white |
| BV43 | BV004300 | NR | Vite TE Tutto Filetto PG DIN 933 CI 8.8 M 5 x 12 Z.Bianca | Screw All Thread DIN 933 PG CI 8.8 M 5 x 12 Z. white |
| BV44 | BV004400 | NR | Vite TE UNF ANSI B18.2.1 GR.5 5/16 x 1"1/4 Z.Bianca | Screw UNF ANSI B18.2.1 GR.5 5/16 x 1 "1/4 Z. White |
| BV45 | BV004500 | NR | Vite TE UNF ANSI B18.2.1 GR.5 5/16 x 1"1/4 Z.Bianca | Screw UNF ANSI B18.2.1 GR.5 5/16 x 1 "1/4 Z. White |
| BV46 | BV004600 | NR | Vite TCEI PG DIN 912 CI 8.8 M 4 x 40 Z.Bianca | Screw DIN 912 PG CI 8.8 M 4 x 40 Z. white |
| BV47 | BV004700 | NR | Vite Trilob. Autoform. TC Croce PG DIN 7500-C C15 M 4 x 40 Z.Bianca | Trilob Screw. Autoform. TC Cross PH DIN 7500-C C 15 M 4 x 40 Z. white |

| POS | Codice | U.M. |  Descrizione |  Description |
|------|----------|------|---|---|
| BV48 | BV004800 | NR | Vite Trilob. Autoform. TC Croce PG DIN 7500-C C15 M 4 x 20 Z.Bianca | Trilob Screw. Autoform. TC Cross PG DIN 7500-C C15 M 4 x 20 Z. white |
| BV49 | BV004900 | NR | Vite TC Croce PG DIN 7985 CI 4.8 M 4 x 16 Z.Bianca | Cross head screw DIN 7985 PG CI 4.8 M 4 x 16 Z. white |
| BV50 | BV005000 | NR | VITE AUTOFIETTANTE TE C/BORDINO DIN 6928 C15 4,8X50 Z.Bianca | TAPPING SCREW TE C / BORDINO DIN 6928 C15 4.8 X50 Z. white |
| BV51 | BV005100 | NR | VITE AUTOFIETTANTE TE C/BORDINO DIN 6928 C15 4,8X25 Z.Bianca | TAPPING SCREW TE C / BORDINO DIN 6928 C15 4.8 X25 Z. white |
| BV52 | BV005200 | NR | Vite TCEI PG DIN 912 CI 12.9 M 3 x 25 Z.D.Bianca | Screw DIN 912 M 3 CI 12.9 x 25 Z.D. white |
| BV53 | BV005300 | NR | Vite TSPEI PG DIN 7991 CI 10.9 M 3 x 14 Z.Bianca | Screw DIN 7991 CI 10.9 M 3 x 14 Z. white |
| BV54 | BV005400 | NR | Vite Autofil.TC Croce DIN 7981 C15 3,5 x 6,5 Z.Bianca | Autofil.TC Cross Screw DIN 7981 C15 3.5 x 6.5 Z. white |
| BV55 | BV005500 | NR | Vite TE Parziale Filetto PG DIN 931 CI 10.9 M 16 x 55 Z.D.Bianca | Screw Partial Thread DIN 931 PG CI 10.9 M 16 x 55 ZD white |
| BV56 | BV005600 | NR | Vite TE Tutto Filetto PG DIN 933 CI 8.8 M 16 x 40 Z.Bianca | Screw All Thread DIN 933 PG CI 8.8 M 16 x 40 Z. white |
| BV57 | BV005700 | NR | Vite TE Parziale Filetto PG DIN 931 CI 10.9 M 16 x 220 Z.Deidro Bianche | Screw Partial Thread DIN 931 PG CI 10.9 M 16 x 220 Z. dehydro White |
| BV58 | BV005800 | NR | Vite TE 8.8 DIN933 M16x20 Testa Alta 8 Zn Bianca | Screw M16x20 DIN933 8.8 Head High 8 Zn White |
| BV59 | BV005900 | NR | Vite TE Tutto Filetto PG DIN 933 CI 8.8 M 12 x 16 Z.Bianca | Screw All Thread DIN 933 PG CI 8.8 M 12 x 16 Z. white |
| BV60 | BV006000 | NR | Vite TE Parziale Filetto PG DIN 931 CI 8.8 M 12 x 120 Z.Bianca | Screw Partial Thread DIN 931 PG CI 8.8 M 12 x 120 Z. white |
| BV61 | BV006100 | NR | Vite TE Parziale Filetto PG DIN 931 CI 8.8 M 10 x 50 Z.Bianca | Screw Partial Thread DIN 931 PG CI 8.8 M 10 x 50 Z. white |
| BV62 | BV006200 | NR | Vite TE Tutto Filetto PG DIN 933 CI 8.8 M 10 x 35 Z.Bianca | Screw All Thread DIN 933 PG CI 8.8 M 10 x 35 Z. white |
| BV63 | BV006300 | NR | Vite TSPEI PG DIN 7991 CI 10.9 M 10 x 30 Z.Bianca | Screw DIN 7991 CI 10.9 M 10 x 30 Z. white |

| POS | Codice | U.M. |  Descrizione |  Description |
|------|----------|------|---|---|
| BV64 | BV006400 | NR | Vite TE Tutto Filetto PG DIN 933 CI 8.8 M 10 x 30 Z.Bianca | Screw All Thread DIN 933 PG CI 8.8 M 10 x 30 Z. white |
| BV65 | BV006500 | NR | Vite TCEI PG DIN 912 CI 12.9 M 10 x 25 Geo 321 A | Screw DIN 912 PG CI 12.9 M 10 x 25 Geo 321 A |
| BV66 | BV006600 | NR | Vite TCEI PG DIN 912 CI 8.8 M 10 x 25 Z.Bianca | Screw DIN 912 PG CI 8.8 M 10 x 25 Z. white |
| BV67 | BV006700 | NR | Vite TE Tutto Filetto PG DIN 933 CI 8.8 M 10 x 20 Z.Bianca | Screw All Thread DIN 933 PG CI 8.8 M 10 x 20 Z. white |
| BV68 | BV006800 | NR | Vite TE Tutto Filetto PG DIN 933 CI 8.8 M 10 x 18 Z.Bianca | Screw All Thread DIN 933 PG CI 8.8 M 10 x 18 Z. white |
| BV69 | BV006900 | NR | Vite Trilob. Autoform. TSP Croce PG DIN 7500-M C15 M 5 x 16 Z.Bianca | Trilob Screw. Autoform. TSP Cross PG DIN 7500-M C15 M 5 x 16 Z. white |
| BV70 | BV007000 | NR | Vite TE Parziale Filetto PG DIN 931 CI 8.8 M 8 x 70 Z.Bianca | Screw Partial Thread DIN 931 PG CI 8.8 M 8 x 70 Z. white |
| BV71 | BV007100 | NR | Vite TE Parziale Filetto PG DIN 931 CI 8.8 M 8 x 65 Z.Bianca | Screw Partial Thread DIN 931 PG CI 8.8 M 8 x 65 Z. white |
| BV72 | BV007200 | NR | Vite TE Parziale Filetto PG DIN 931 CI 8.8 M 6 x 55 Z.Bianca | Screw Partial Thread DIN 931 PG CI 8.8 M 6 x 55 Z. white |
| BV73 | BV007300 | NR | Vite TCEI PG DIN 912 CI 8.8 M 6 x 55 Z.Bianca | Screw DIN 912 PG CI 8.8 M 6 x 55 Z. white |
| BV74 | BV007400 | NR | Vite TCEI PG DIN 912 CI 8.8 M 6 x 16 Z.Bianca | Screw DIN 912 PG CI 8.8 M 6 x 16 Z. white |
| BV75 | BV007500 | NR | Vite TSPEI PG DIN 7991 CI 10.9 M 6 x 10 Z.Bianca | Screw DIN 7991 CI 10.9 M 6 x 10 Z. white |
| BV76 | BV007600 | NR | Vite TCEI PG DIN 912 CI 8.8 M 5 x 55 Z.Bianca | Screw DIN 912 PG CI 8.8 M 5 x 55 Z. white |
| BV77 | BV007700 | NR | Vite TC Croce PG DIN 7985 CI 4.8 M 6 x 16 Z.Bianca | Cross head screw DIN 7985 PG CI 4.8 M 6 x 16 Z. white |
| BV78 | BV007800 | NR | Vite Trilob. Autoform. TC Croce PG DIN 7500-C C15 M 5 x 12 Z.Bianca | Trilob Screw. Autoform. TC Cross PG DIN 7500-C C15 M 5 x 12 Z. white |
| BV79 | BV007900 | NR | Vite TE Tutto Filetto PG DIN 933 CI 8.8 M 4 x 35 Z.Bianca | Screw All Thread DIN 933 PG CI 8.8 M 4 x 35 Z. white |
| BV80 | BV008000 | NR | VITE AUTOFIETTANTE TE C/BORDINO DIN 6928 C15 4,8X35 Z.Bianca | TAPPING SCREW TE C / BORDINO DIN 6928 C15 4.8 X35 Z. white |

| POS | Codice | U.M. |  Descrizione |  Description |
|------|----------|------|---|---|
| BV81 | BV008100 | NR | Vite TCEI PG DIN 912 CI 12.9 M 3 x 14 Z.D.Bianca | Screw DIN 912 M 3 CI 12.9 x 14 Z.D. white |
| BV82 | BV008200 | NR | Vite TE Parziale Filetto PG DIN 931 CI 8.8 M 16 x 70 Z.Bianca | Screw Partial Thread DIN 931 PG CI 8.8 M 16 x 70 Z. white |
| BV83 | BV008300 | NR | Vite TE Parziale Filetto PG DIN 931 CI 8.8 M 16 x 260 Z.Bianca | Screw Partial Thread DIN 931 PG CI 8.8 M 16 x 260 Z. white |
| BV84 | BV008400 | NR | Vite TE Parziale Filetto PG DIN 931 CI 8.8 M 12 x 110 Z.Bianca | Screw Partial Thread DIN 931 PG CI 8.8 M 12 x 110 Z. white |
| BV85 | BV008500 | NR | Vite TE Tutto Filetto PG DIN 933 CI 8.8 M 10 x 40 Z.Bianca | Screw Thread DIN 933 PG CI 8.8 M 10 x 40 Z. white |
| BV86 | BV008600 | NR | Vite TCEI PG DIN 912 CI 8.8 M 8 x 65 Z.Bianca | Screw DIN 912 PG CI 8.8 M 8 x 65 Z. white |
| BV87 | BV008700 | NR | Vite TCEI PG DIN 912 CI 8.8 M 8 x 20 Z.Bianca | Screw DIN 931 PG CI 8.8 M 10 x 40 Z. white |
| BV88 | BV008800 | NR | Vite TCEI PG DIN 912 CI 10.9 M 10 x 18 Z.Bianca | Screw DIN 912 PG CI 10.9 M 10 x 18 Z. white |
| BV89 | BV008900 | NR | Vite TCEI PG DIN 912 CI 8.8 M 8 x 70 Z.Bianca | Screw DIN 912 PG CI 8.8 M 8 x 70 Z. white |
| BV91 | BV009100 | NR | Vite TE Parziale Filetto PG DIN 931 CI 8.8 M 6 x 40 Z.Bianca | Screw Partial Thread DIN 931 PG CI 8.8 M 6 x 40 Z. white |
| BV92 | BV009200 | NR | Vite TE Tutto Filetto PG DIN 933 CI 8.8 M 10 x 60 Z.Bianca | Screw All Thread DIN 933 PG CI 8.8 M 10 x 60 Z. white |
| BV93 | BV009300 | NR | Vite TSPEI PG DIN 7991 CI 10.9 M 5 x 20 Z.Bianca | screw DIN 7991 CI 10.9 M 5 x 20 Z. white |
| BV94 | BV009400 | NR | Vite TC Croce PG DIN 7985 CI 4.8 M 4 x 12 Z.Bianca | Cross head screw DIN 7985 PG CI 4.8 M 4 x 12 Z. white |
| BV95 | BV009500 | NR | Vite TE Tutto Filetto PG DIN 933 CI 8.8 M 4 x 12 Z.Bianca | Screw All Thread DIN 933 PG CI 8.8 M 4 x 12 Z. white |
| BV96 | BV009600 | NR | Vite TCEI PG DIN 912 CI 12.9 M 12 x 30 Dac 320A | Screw DIN 912 CI 12.9 M 12 x 30 Dac 320A |
| BV97 | BV009700 | NR | Vite Autofil.Testa Mezza Tonda C15 4,8 x 13 Z.Bianca | Half Round Head Self Tapping Screw C15 4,8 x 13 |
| BV98 | BV009800 | NR | Vite TC Croce PG DIN 7985 CI 4.8 M 4 x 14 Z.Bianca | Screw DIN 7985 CI 4.8 M 4 x 14 |

| POS | Codice | U.M. |  Descrizione |  Description |
|-------|----------|------|---|---|
| BV99 | BV009900 | NR | Vite TE Parziale Filetto PG DIN 931 CI 8.8 M 5 x 65 Z.Bianca | Screw Partial Thread DIN 931 PG CI 8.8 M 5 x 65 Z. white |
| BV100 | BV010000 | NR | Vite Autofil. Testa Mezza Tonda C15 4,8 x 16 Z.Bianca | Half Round Head Self Tapping Screw C15 4,8 x 16 |
| BV101 | BV010100 | NR | Vite TSPEI PG DIN 7991 CI 10.9 M 8 x 25 Z.Bianca | screw DIN 7991 CI 10.9 M 8 x 25 Z. white |
| BV102 | BV010200 | NR | Vite TCEI PG DIN 912 CI 8.8 M 4 x 30 Z.Bianca | Screw DIN 912 PG CI 8.8 M 4 x 30 White Z |
| BV103 | BV010300 | NR | Vite TSPEI PG DIN 7991 CI 10.9 M 5 x 16 Z.Bianca | Screw DIN 7991 CI 10.9 M 5 x 16 Z. white |
| BV104 | BV010400 | NR | Vite TCEI bassa PG DIN 7984 CI 10.9 M 12 x 18 Z.D.Bianca | Screw DIN 7984 low PG CI 10.9 M 12 x 18 Z. D. white |
| BV105 | BV010500 | NR | Vite TE Parziale Filetto PG DIN 931 CI 8.8 M 12 x 75 Z.Bianca | Screw Partial Thread DIN 931 PG CI 8.8 M 12 x 75 Z. white |
| BV106 | BV010600 | NR | Vite TE Tutto Filetto PG DIN 933 CI 8.8 M 8 x 22 Z.Bianca | Screw All Thread DIN 933 PG CI 8.8 M 8 x 22 Z. white |
| BV107 | BV010700 | NR | Vite TE Tutto Filetto PG DIN 933 CI 8.8 M 6 x 35 Z.Bianca | Screw All Thread DIN 933 PG CI 8.8 M 6 x 35 Z. white |
| BV108 | BV010800 | NR | Vite TE Parziale Filetto PG DIN 931 CI 8.8 M 4 x 45 Z.Bianca | Screw Partial Thread DIN 931 PG CI 8.8 M 4 x 45 Z. white |
| BV109 | BV010900 | NR | Vite TE Tutto Filetto PG DIN 933 CI 10.9 M 16 x 45 Z.D.Bianca | Screw All Thread DIN 933 PG CI 10.9 M 16 x 45 ZD white |
| BV110 | BV011000 | NR | Vite TE Parziale Filetto PG DIN 931 CI 10.9 M 16 x 100 Z.D.Bianca | Screw Partial Thread DIN 931 PG CI 10.9 M 16 x 100 ZD white |
| BV111 | BV011100 | NR | Vite TE Parziale Filetto PG DIN 931 CI 10.9 M 16 x 105 Z.D.Bianca | Screw Partial Thread DIN 931 PG CI 10.9 M 16 x 105 ZD white |
| BV112 | BV011200 | NR | Vite TE Tutto Filetto PG DIN 933 CI 8.8 M 10 x 25 Z.Bianca | Screw All Thread DIN 933 PG CI 8.8 M 10 x 25 Z. white |
| BV113 | BV011300 | NR | Vite TSPEI PG DIN 7991 CI 10.9 M 6 x 50 Z.Bianca | TSPEI PG screw DIN 7991 CI 10.9 M 6 x 50 Z. white |
| BV114 | BV011400 | NR | Vite TSPEI PG DIN 7991 CI 10.9 M 8 x 25 Z.Bianca | TSPEI PG screw DIN 7991 CI 10.9 M 8 x 25 Z. white |
| BV115 | BV011500 | NR | Vite TE Tutto Filetto PG DIN 933 CI 8.8 M 10 x 45 Z.Bianca | Screw All Thread DIN 933 PG CI 8.8 M 10 x 45 Z. white |

| POS | Codice | U.M. |  Descrizione |  Description |
|-------|----------|------|---|---|
| BV116 | BV011600 | NR | Vite TE Tutto Filetto PG DIN 933 CI 8.8 M 5 x 8 Z.Bianca | Screw All Thread DIN 933 PG CI 8.8 M 5 x 8 Z. white |
| BV117 | BV011700 | NR | Vite TE Tutto Filetto PG DIN 933 CI 8.8 M 8 x 18 Z.Bianca | Screw All Thread DIN 933 PG CI 8.8 M 8 x 18 Z. white |
| BV118 | BV011800 | NR | Vite TE Tutto Filetto PG DIN 933 CI 8.8 M 8 x 40 Z.Bianca | Screw All Thread DIN 933 PG CI 8.8 M 8 x 40 Z. white |
| BV119 | BV011900 | NR | Vite TCEI PG DIN 912 CI 8.8 M 8 x 100 Z.Bianca | Screw DIN 912 PG CI 8.8 M 8 x 100 Z. white |
| BV120 | BV012000 | NR | Vite TCEI PG DIN 912 CI 8.8 M 8 x 110 Z.Bianca | Screw DIN 912 PG CI 8.8 M 8 x 110 Z. white |
| BV121 | BV012100 | NR | Vite TE Parziale Filetto PG DIN 931 CI 8.8 M 5 x 75 Z.Bianca | Screw Partial Thread DIN 931 PG CI 8.8 M 5 x 75 Z. white |
| BV122 | BV012200 | NR | Vite TE Parziale Filetto PG DIN 931 CI 8.8 M 12 x 130 Z.Bianca | Screw Partial Thread DIN 931 PG CI 8.8 M 12 x 130 Z. white |
| BV123 | BV012300 | NR | Vite TC Croce PG DIN 7985 CI 4.8 M 4 x 8 Z.Bianca | Cross head screw DIN 7985 PG CI 4.8 M 4 x 8 Z. white |
| BV124 | BV012400 | NR | Vite TCEI PG DIN 912 CI 8.8 M 6 x 40 Z.Bianca | Screw DIN 912 PG CI 8.8 M 6 x 40 Z. white |
| BV125 | BV012500 | NR | Vite TE Tutto Filetto PG DIN 933 CI 8.8 M 4 x 20 Z.Bianca | Screw All Thread DIN 933 PG CI 8.8 M 4 x 20 Z. white |
| BV126 | BV012600 | NR | Vite TE UNC ANSI B18.2.1 GR.5 3/8 x 1" Z.Bianca | Screw UNC ANSI B18.2.1 GR.5 3/8 x 1" Z. White |
| BV127 | BV012700 | NR | Vite TE UNC ANSI B18.2.1 GR.5 3/8 x 1" 1/4Z.Bianca | Screw UNC ANSI B18.2.1 GR.5 3/8 x 1" 1/4 Z. White |
| BV128 | BV012800 | NR | Vite TE Tutto Filetto PG DIN 933 CI 8.8 M 4 x 16 Z.Bianca | Screw All Thread DIN 933 PG CI 8.8 M 4 x 16 Z. white |
| BV129 | BV012900 | NR | Vite TCEI PG DIN 912 CI 8.8 M 5 x 16 Z.Bianca | Screw DIN 912 PG CI 8.8 M 5 x 16 Z. white |
| BV130 | BV013000 | NR | Vite TCEI PG DIN 912 CI 8.8 M 3 x 12 Z.Bianca | Screw DIN 912 PG CI 8.8 M 3 x 12 Z. white |
| BV131 | BV013100 | NR | Vite TSPEI PG DIN 7991 CI 10.9 M 5 x 30 Z.Bianca | TSPEI PG screw DIN 7991 CI 10.9 M 5 x 30 Z. white |
| BV132 | BV013200 | NR | Vite TSPEI PG DIN 7991 CI 10.9 M 5 x 55 Z.Bianca | TSPEI PG screw DIN 7991 CI 10.9 M 5 x 55 Z. white |
| BV133 | BV013300 | NR | Vite TE Tutto Filetto PG DIN 933 CI 8.8 M 3 x 25 Z.Bianca | Screw All Thread DIN 933 PG CI 8.8 M 3 x 25 Z. white |

| POS | Codice | U.M. |  Descrizione |  Description |
|-------|----------|------|---|---|
| BV134 | BV013400 | NR | Vite TE Parziale Filetto PG DIN 931 CI 8.8 M 10 x 65 Z.Bianca | Screw Partial Thread DIN 931 PG CI 8.8 M 10 x 65 Z. white |
| BV135 | BV013500 | NR | Vite TCEI PG DIN 912 CI 8.8 M 12 x 50 | Screw DIN 912 CI 9.8 M 12 x 50 |
| BV136 | BV013600 | NR | Vite TSPEI PG DIN 7991 CI 10.9 M 5 x 25 Z.Bianca | TSPEI PG screw DIN 7991 CI 10.9 M 5 x 25 Z. white |
| BV137 | BV013700 | NR | Vite TCEI PG DIN 912 CI 8.8 M 8 x 30 | Screw DIN 912 CI 8.8 M 8 x 30 |
| BV138 | BV013800 | NR | Vite TC Croce PG DIN 7985 CI 4.8 M 5 x 10 Z.Bianca | Screw DIN 7985 CI 4.8 M 5 x 10 |
| BV139 | BV013900 | NR | Vite TCEI PG DIN 912 CI 8.8 M 4 x 25 Z. Bianca | Screw DIN 912 CI 8.8 M 4 x 25 Z. Withe |
| BV140 | BV014000 | NR | Vite TE Parziale Filetto PG DIN 931 CI 8.8 M 5 x 70 Z.Bianca | Screw Partial Thread DIN 931 PG CI 8.8 M 5 x 70 Z. white |
| BV141 | BV014100 | NR | Vite TE Parziale Filetto PG DIN 931 CI 8.8 M 12 x 90 Z.Bianca | Screw Partial Thread DIN 931 PG CI 8.8 M 12 x 90 Z. white |
| BV142 | BV014200 | NR | Vite TE Parziale Filetto PG DIN 931 CI 8.8 M 8 x 55 Z.Bianca | Screw Partial Thread DIN 931 PG CI 8.8 M 8 x 55 Z. white |
| BV143 | BV014300 | NR | Vite TSPEI PG DIN 7991 CI 10.9 M 10 x 20 Z.Bianca | TSPEI PG screw DIN 7991 CI 10.9 M 10 x 20 Z. white |
| BV144 | BV014400 | NR | Vite TE Tutto Filetto PG DIN 933 CI 8.8 M 12 x 20 Z.Bianca | Screw All Thread DIN 933 PG CI 8.8 M 12 x 20 Z. white |
| BV145 | BV014500 | NR | Vite TE Tutto Filetto PG DIN 933 CI 8.8 M 12 x 35 Z.Bianca | Screw All Thread DIN 933 PG CI 8.8 M 12 x 35 Z. white |
| BV146 | BV014600 | NR | Vite TE Tutto Filetto PF DIN 961 CI 10.9 M 10 x 1,25 x 25 Z.D.Bianco | All PF thread hex head screw DIN 961 CI 10.9 M 10 x 1,25 x 25 Z.Bianca |
| BV147 | BV014700 | NR | Vite TSPEI PARZIALE FILETTO PG DIN 7991 CI 10.9 M 12 x 90 Z.Bianca | TSPEI partial THREAD PG screw DIN 7991 CI 10.9 M12 x 90 Z. white |
| BV148 | BV014800 | NR | Vite TSPEI PG DIN 7991 CI 10.9 M 6 x 16 Z.Bianca | TSPEI PG screw DIN 7991 CI 10.9 M6 x 16 Z. white |
| BV149 | BV014900 | NR | Vite TBEI PG ISO 7380 CI 10.9 M 6 x 20 Z.Bianca | Hex socket screw ISO 7380 PG CI 10.9 M 6 x 20 Z. white |
| BV150 | BV015000 | NR | Vite TE Tutto Filetto PG DIN 933 CI 10.9 M 14 x 40 Z.Bianca | Screw All Thread DIN 933 PG CI 10.9 M 14 x 40 Z. white |

| POS | Codice | U.M. |  Descrizione |  Description |
|-------|----------|------|---|---|
| BV151 | BV015100 | NR | Vite TE Parziale Filetto PG DIN 931 CI 8.8 M 10 x 85 Z.Bianca | Screw Partial Thread DIN 931 PG CI 8.8 M 10 x 85 Z. white |
| BV152 | BV015200 | NR | Vite TE Parziale Filetto PG DIN 931 CI 8.8 M 10 x 75 Z.Bianca | Screw Partial Thread DIN 931 PG CI 8.8 M 10 x 75 Z. white |
| BV154 | BV015400 | NR | Vite TCEI PG DIN 912 CI 8.8 M 8 x 35 | Screw DIN 912 CI 8.8 M 8 x 35 |
| BV155 | BV015500 | NR | Vite TCEI PG DIN 912 CI 8.8 M 5 x 20 GEOMET 321A | Screw DIN 912 CI 8.8 M 5 x 20 GEOMET 321A |
| BV156 | BV015600 | NR | Vite TBEI PG ISO 7380 CI 10.9 M 6 x 25 Z.Bianca | Hex socket screw ISO 7380 PG CI 10.9 M 6 x 25 Z. white |
| BV157 | BV015700 | NR | Vite TBEI PG ISO 7380 CI 10.9 M 8 x 20 Z.Bianca | Hex socket screw ISO 7380 PG CI 10.9 M 8 x 20 Z. white |
| BV158 | BV015800 | NR | Vite TBEI PG ISO 7380 CI 10.9 M 6 x 70 Z.Bianca | Hex socket screw ISO 7380 PG CI 10.9 M 6 x 70 Z. white |
| BV159 | BV015900 | NR | Vite TBEI PG ISO 7380 CI 10.9 M 10 x 20 Z.Bianca | Hex socket screw ISO 7380 PG CI 10.9 M 10 x 20 Z. white |
| BV160 | BV016000 | NR | Vite TSPEI PG DIN 7991 CI 10.9 M 4 x 16 Z.Bianca | TSPEI PG screw DIN 7991 CI 10.9 M4 x 16 Z. white |
| BV162 | BV016200 | NR | Vite TCEI PG DIN 912 CI 12.9 M14 x 45 GEOMET 321A | Screw DIN 912 CI 12.9 M14 x 45 GEOMET 321A |
| BV163 | BV016300 | NR | Vite TCEI PG DIN 912 CI 8.8 M6 x 35 | Screw DIN 912 CI 8.8 M6 x 35 |
| BV164 | BV016400 | NR | Vite TCEI PG DIN 912 CI 8.8 M10 x 35 | Screw DIN 912 CI 8.8 M10 x 35 |
| BV165 | BV016500 | NR | Vite TE Tutto Filetto PG DIN 933 CI 8.8 M8 x 12 Z.Bianca | Screw All Thread DIN 933 PG CI 8.8 M8 x 12 Z. white |
| BV166 | BV016600 | NR | Vite TCEI PG DIN 912 CI 8.8 M4 x 20 Z. BIANCA | Screw DIN 912 CI 8.8 M4 x 20 Z. WITHE |
| BV167 | BV016700 | NR | Vite TCEI PG DIN 912 CI 8.8 M4 x 20 GEOMET 321A | All PF thread hex head screw DIN 961 CI 8.8 M 12 x 1,25 x 30 Z.Bianca |
| BV168 | BV016800 | NR | Vite TE Tutto Filetto PF DIN 961 CI 8.8 M 10 x 1,25 x 30 Z.Bianca | All PF thread hex head screw DIN 961 CI 8.8 M 10 x 1,25 x 30 Z.Bianca |
| BV169 | BV016900 | NR | Vite TCEI PG DIN 912 CI 8.8 M 10 x 1,25 x 30 ZINCATA BIANCA | Screw DIN 912 CI 8.8 M10 x 1,25 x 30 |

| POS | Codice | U.M. |  Descrizione |  Description |
|-------|----------|------|---|---|
| BV170 | BV017000 | NR | Vite TE Parziale Filetto PF DIN 960 CI 8.8 M 10 x 1,25 x 60 Z.Bianca | Partial PF thread hex head screw DIN 960 CI 8.8 M 10 x 1,25 x 60 Z.Bianca |
| BV171 | BV017100 | NR | Vite TE Tutto Filetto PF DIN 961 CI 10.9 M 12 x 1,25 x 25 Z.Bianca | All PF thread hex head screw DIN 961 CI 10.9 M 12 x 1,25 x 25 Z.Bianca |
| BV172 | BV017200 | NR | Vite TE UNC ANSI B18.2.1 GR.5 5/8 passo 11 L= 1" 1/2 GEOMET 500 | UNC hex head screw ANSI B18.2.1 GR.5 5/8 11 L = 1 "1/2 GEOMET 500 |
| BV173 | BV017300 | NR | Vite TE Tutto Filetto PG DIN 933 CI 8.8 M12 x 30 Z.Bianca | Screw All Thread DIN 933 PG CI 8.8 M12 x 30 Z. white |
| BV174 | BV017400 | NR | Vite TE Tutto Filetto PG DIN 933 CI 8.8 M5 x 45 Z.Bianca | Screw All Thread DIN 933 PG CI 8.8 M5 x 45 Z. white |
| BV175 | BV017500 | NR | Vite TE Parziale Filetto PG DIN 931 CI 8.8 M 12 x 80 Z.Bianca | Screw Partial Thread DIN 931 PG CI 8.8 M12 x 80 Z. white |
| BV176 | BV017600 | NR | Vite TCEI PG DIN 912 CI 8.8 M 6 x 25 Z.Bianca | Screw DIN 912 CI 8.8 M6 x 25 |
| BV177 | BV017700 | NR | Vite TE Parziale Filetto PG DIN 931 CI 8.8 M 12 x 85 Z.Bianca | Screw Partial Thread DIN 931 PG CI 8.8 M12 x 85 Z. white |
| BV178 | BV017800 | NR | Vite TE Tutto Filetto PG DIN 933 CI 8.8 M8 x 90 Z.Bianca | Screw All Thread DIN 933 PG CI 8.8 M8 x 90 Z. white |
| BV179 | BV017900 | NR | Vite TE Tutto Filetto PG DIN 933 CI 8.8 M5 x 40 Z.Bianca | Screw All Thread DIN 933 PG CI 8.8 M5 x 40 Z. white |
| BV180 | BV018000 | NR | Vite TE Tutto Filetto PG DIN 933 CI 8.8 M6 x 75 Z.Bianca | Screw All Thread DIN 933 PG CI 8.8 M6 x 75 Z. white |
| BV182 | BV018200 | NR | Vite TE Tutto Filetto PG DIN 933 CI 10.9 M 16 x 70 Z.Bianca | Screw All Thread DIN 933 PG CI 10.9 M 16 x 70 Z. white |
| BV183 | BV018300 | NR | Vite TE Tutto Filetto PG DIN 933 CI 8.8 M5 x 10 Z.Bianca | Screw All Thread DIN 933 PG CI 8.8 M5 x 10 Z. white |
| BV184 | BV018400 | NR | Vite TE Tutto Filetto PG DIN 933 CI 8.8 M10 x 16 Z.Bianca | Screw All Thread DIN 933 PG CI 8.8 M10 x 16 Z. white |
| BV185 | BV018500 | NR | Vite TCEI PG DIN 912 CI 8.8 M 8 x 55 Z.Bianca | Screw DIN 912 CI 8.8 M8 x 55 |
| BV186 | BV018600 | NR | Vite TCEI PG DIN 912 CI 12.9 M10 x 30 GEOMET 321A | Screw DIN 912 CI 12.9 M10 x 30 GEOMET 321A |
| BV187 | BV018700 | NR | Vite TCEI PG DIN 912 CI 12.9 M14 x 40 GEOMET 321A | Screw DIN 912 CI 12.9 M14 x 40 GEOMET 321A |



| POS | Codice | U.M. |  Descrizione |  Description |
|-------|----------|------|---|---|
| BV188 | BV018800 | NR | Vite TE Tutto Filetto PG DIN 933 CI 8.8 M 12 x 60 Z.Bianca | Screw All Thread DIN 933 PG CI 8.8 M12 x 60 Z. white |
| BV189 | BV018900 | NR | Vite TE Tutto Filetto PG DIN 933 CI 8.8 M 12 x 55 Z.Bianca | Screw All Thread DIN 933 PG CI 8.8 M12 x 55 Z. white |
| BV190 | BV019000 | NR | Vite TE Tutto Filetto PG DIN 933 CI 8.8 M 12 x 50 Z.Bianca | Screw All Thread DIN 933 PG CI 8.8 M12 x 50 Z. white |
| BV191 | BV019100 | NR | Vite TE Tutto Filetto PG DIN 933 CI 8.8 M 16 x 50 Z.Bianca | Screw All Thread DIN 933 PG CI 8.8 M16 x 50 Z. white |
| BV192 | BV019200 | NR | Vite TE Tutto Filetto PG DIN 933 CI 8.8 M 16 x 55 Z.Bianca | Screw All Thread DIN 933 PG CI 8.8 M16 x 55 Z. white |
| BV193 | BV019300 | NR | Vite TE Parziale Filetto PG DIN 931 CI 8.8 M 10 x 55 Z.Bianca | Screw Partial Thread DIN 931 PG CI 8.8 M 10 x 55 Z. white |
| BV194 | BV019400 | NR | Vite TE Parziale Filetto PG DIN 931 CI 8.8 M 16 x 230 Z.Bianca | Screw Partial Thread DIN 931 PG CI 8.8 M 16 x 230 Z. white |
| BV195 | BV019500 | NR | Vite TE Parziale Filetto PG DIN 931 CI 8.8 M 6 x 50 Z.Bianca | Screw Partial Thread DIN 931 PG CI 8.8 M 6 x 50 Z. white |
| BV196 | BV019600 | NR | Vite TE Parziale Filetto PG DIN 931 CI 8.8 M 6 x 65 Z.Bianca | Screw Partial Thread DIN 931 PG CI 8.8 M 6 x 65 Z. white |
| BV197 | BV019700 | NR | Vite TE Parziale Filetto PG DIN 931 CI 8.8 M 8 x 45 Z.Bianca | Screw Partial Thread DIN 931 PG CI 8.8 M 8 x 45 Z. white |
| BV198 | BV019800 | NR | Vite TE Parziale Filetto PG DIN 931 CI 8.8 M 8 x 55 Z.Bianca | Screw Partial Thread DIN 931 PG CI 8.8 M 8 x 55 Z. white |
| BV199 | BV019900 | NR | Vite TE Parziale Filetto PG DIN 931 CI 8.8 M 8 x 60 Z.Bianca | Screw Partial Thread DIN 931 PG CI 8.8 M 8 x 60 Z. white |
| BV200 | BV020000 | NR | Vite TE Tutto Filetto PG DIN 933 CI 10.9 M 16 x 40 Z.Bianca | Screw All Thread DIN 933 PG CI 10.9 M 16 x 40 Z. white |
| BV201 | BV020100 | NR | Vite TSPEI PG DIN 7991 CI 10.9 M16 x 45 Z.Bianca | TSPEI PG screw DIN 7991 CI 10.9 M16 x 45 Z. white |
| BV202 | BV020200 | NR | Vite TCEI PG DIN 912 CI 12.9 M3 x 12 ZINC. iridescente Fe/Zn5IVs | Screw DIN 912 CI 12.9 M3 x 12 ZINC. iridescente Fe/Zn5IVs |
| BV203 | BV020300 | NR | Vite TC Croce PG DIN 7985 CI 4.8 M M 3 x 5 Z.Bianca | Screw DIN 7985 CI 4.8 M M 3 x 5 |
| BV204 | BV020400 | NR | Vite TC Croce PG DIN 7985 CI 4.8 M M 3 x 8 Z.Bianca | Screw DIN 7985 CI 4.8 M M 3 x 8 |

| POS | Codice | U.M. |  Descrizione |  Description |
|-------|----------|------|---|---|
| BV205 | BV020500 | NR | Vite TTQST DIN 603/555 CI 4.8 M 8 x 35 Z.Bianca | TTQST Screw DIN 603/555 CL 4.8 M 8 x 35 Z. White |
| BV206 | BV020600 | NR | Vite TC Croce PG DIN 7985 CI 4.8 M M 5 x 80 Z.Bianca | Screw DIN 7985 CI 4.8 M M 5 x 80 |
| BV207 | BV020700 | NR | Vite TE Parziale Filetto PG DIN 931 CI 8.8 M 10 x 80 Z.Bianca | Screw Partial Thread DIN 931 PG CI 8.8 M 10 x 80 Z. white |
| BV208 | BV020800 | NR | Vite TE Tutto Filetto PG DIN 933 CI 8.8 M 16 x 35 Z.D.Bianca | Screw All Thread DIN 933 PG CI 8.8 M 16 x 35 ZD white |
| BV209 | BV020900 | NR | Vite TE Parziale Filetto PG DIN 931 CI 8.8 M 10 x 95 Z.Bianca | Screw Partial Thread DIN 931 PG CI 8.8 M 10 x 95 Z. white |
| BV210 | BV021000 | NR | Vite TE Tutto Filetto PG DIN 933 CI 8.8 M 6 x 14 Z.D.Bianca | Screw All Thread DIN 933 PG CI 8.8 M 6 x 14 ZD white |
| BV211 | BV021100 | NR | Vite TE Tutto Filetto PG DIN 933 CI 8.8 M 12 x 25 Z.D.Bianca | Screw All Thread DIN 933 PG CI 8.8 M 12 x 25 ZD white |
| BV212 | BV021200 | NR | Vite TE Tutto Filetto PG DIN 933 CI 8.8 M 4 x 14 Z.D.Bianca | Screw All Thread DIN 933 PG CI 8.8 M 4 x 14 ZD white |
| BV213 | BV021300 | NR | Vite TE Tutto Filetto PG DIN 933 CI 10.9 M 16 x 60 Z.D.Bianca | Screw All Thread DIN 933 PG CI 10.9 M 16 x 60 ZD white |
| BV214 | BV021400 | NR | Vite TE Parziale Filetto PG DIN 931 CI 8.8 M 6 x 100 Z.Bianca | Screw Partial Thread DIN 931 PG CI 8.8 M 6 x 100 Z. white |
| BV215 | BV021500 | NR | Vite TE Parziale Filetto PG DIN 931 CI 10.9 M 16 x 110 Z.D.Bianca | Screw Partial Thread DIN 931 PG CI 10.9 M 16 x 110 ZD white |
| BV216 | BV021600 | NR | Vite TE Parziale Filetto PG DIN 931 CI 10.9 M 16 x 240 Z.D.Bianca | Screw Partial Thread DIN 931 PG CI 10.9 M 16 x 240 ZD white |
| BV217 | BV021700 | NR | Vite TSPEI PG DIN 7991 CI 10.9 M 8 x 30 Z.Bianca | TSPEI PG screw DIN 7991 CI 10.9 M8 x 30 Z. white |
| BV218 | BV021800 | NR | Vite TSPEI PG DIN 7991 CI 10.9 M 5 x 6 Z.Bianca | TSPEI PG screw DIN 7991 CI 10.9 M5 x 6 Z. white |
| BV219 | BV021900 | NR | Vite TSPEI PG DIN 7991 CI 10.9 M 5 x 70 Z.Bianca | TSPEI PG screw DIN 7991 CI 10.9 M5 x 70 Z. white |
| BV220 | BV022000 | NR | Vite TSPEI PG DIN 7991 CI 10.9 M 12 x 35 Z.Bianca | TSPEI PG screw DIN 7991 CI 10.9 M12 x 35 Z. white |
| BV221 | BV022100 | NR | Vite TCEI PG DIN 912 CI 12.9 M10 x 20 GEOMET 321A | Screw DIN 912 CI 12.9 M10 x 20 GEOMET 321A |



| POS | Codice | U.M. |  Descrizione |  Description |
|-------|----------|------|---|---|
| BV222 | BV022200 | NR | Vite TCEI PG DIN 912 CI 12.9 M8 x 90 GEOMET 321A | Screw DIN 912 CI 12.9 M8 x 90 GEOMET 321A |
| BV223 | BV022300 | NR | Vite TCEI PG DIN 912 CI 12.9 M3 x 5 ZINC. | Screw DIN 912 CI 12.9 M3 x 5 ZINC. |
| BV224 | BV022400 | NR | Vite TBEI PG ISO 7380 CI 10.9 M 8 x 22 Z.Bianca | Hex socket screw ISO 7380 PG CI 10.9 M 8 x 22 Z. white |
| BV225 | BV022500 | NR | Vite TE Parziale Filetto PG DIN 931 CI 8.8 M 10 x 100 Z.Bianca | Screw Partial Thread DIN 931 PG CI 8.8 M 10 x 100 Z. white |
| BV226 | BV022600 | NR | Vite TE Parziale Filetto PG DIN 931 CI 8.8 M 10 x 110 Z.Bianca | Screw Partial Thread DIN 931 PG CI 8.8 M 10 x 110 Z. white |
| BV227 | BV022700 | NR | Vite TE parziale Filetto PG DIN 931 CI 10.9 M 12 x 45 Z.D.Bianca | Screw partial Thread DIN 931 PG CI 10.9 M 12 x 45 ZD white |
| BV228 | BV022800 | NR | Vite TE Tutto Filetto PG DIN 933 CI 10.9 M 14 x 35 Z.D.Bianca | Screw All Thread DIN 933 PG CI 10.9 M 14 x 35 ZD white |
| BV229 | BV022900 | NR | Vite TSPEI PG DIN 7991 CI 10.9 M 12 x 30 Z.Bianca | TSPEI PG screw DIN 7991 CI 10.9 M12 x 30 Z. white |
| BV230 | BV023000 | NR | Vite TE flangiata Tutto Filetto PG DIN 6921 CI 8.8 M 5 x 12 Zinconickel nero +sigillante | Flange Screw All Thread DIN 6921 PG CI 8.8 M 5 x 12 Zinconickel black +sealant |
| BV231 | BV023100 | NR | Vite TE flangiata Tutto Filetto PG DIN 6921 CI 8.8 M 6 x 16 Zinconickel nero +sigillante | Flange Screw All Thread DIN 6921 PG CI 8.8 M 6 x 16 Zinconickel black +sealant |
| BV232 | BV023200 | NR | Vite TE Tutto Filetto PG DIN 933 CI 8.8 M 5 x 25 Z.D.Bianca | Screw All Thread DIN 933 PG CI 8.8 M 5 x 25 ZD white |
| BV233 | BV023300 | NR | Vite TE Tutto Filetto PG DIN 933 CI 8.8 M 8 x 130 Z.D.Bianca | Screw All Thread DIN 933 PG CI 8.8 M 8 x 130 ZD white |
| BV234 | BV023400 | NR | Vite TBEI PG ISO 7380 CI 10.9 M 10 X 30 Z.Bianca | Hex socket screw ISO 7380 PG CI 10.9 M 10 X 30 Z. white |
| BV235 | BV023500 | NR | Vite TE Tutto Filetto PG DIN 933 CI 10.9 M 16 x 35 Z.D.Bianca | Screw All Thread DIN 933 PG CI 10.9 M 16 x 35 ZD white |
| BV236 | BV023600 | NR | Vite TE Parziale Filetto PG DIN 931 CI 8.8 M 6 x 45 Z.Bianca | Screw Partial Thread DIN 931 PG CI 8.8 M 6 x 45 Z. white |
| BV237 | BV023700 | NR | Vite TE Tutto Filetto PG DIN 933 CI 10.9 M 12 x 30 Z.D.Bianca | Screw All Thread DIN 933 PG CI 10.9 M 12 x 30 ZD white |



| POS | Codice | U.M. |  Descrizione |  Description |
|-------|----------|------|---|---|
| BV238 | BV023800 | NR | Vite TE Parziale Filetto PG DIN 931 CI 8.8 M 16 x 90 Z.Bianca | Screw Partial Thread DIN 931 PG CI 8.8 M 16 x 90 Z. white |
| BV239 | BV023900 | NR | Vite TE Parziale Filetto PG DIN 931 CI 8.8 M 12 x 65 Z.Bianca | Screw Partial Thread DIN 931 PG CI 8.8 M 12 x 65 Z. white |
| BV240 | BV024000 | NR | Vite TC Croce PG DIN 7985 CI 4.8 M 5 x 20 Z.Bianca | Screw DIN 7985 CI 4.8 M 5 x 20 |
| BV241 | BV024100 | NR | Vite TSPEI PG DIN 7991 CI 10.9 M 10 x 35 Z.Bianca | TSPEI PG screw DIN 7991 CI 10.9 M 10 x 35 Z. white |
| BV242 | BV024200 | NR | Vite TSPEI PG DIN 7991 CI 10.9 M 6 x 12 Z.Bianca | TSPEI PG screw DIN 7991 CI 10.9 M 6 x 12 Z. white |
| BV243 | BV024300 | NR | Vite TE Parziale Filetto PG DIN 931 CI 8.8 M 12 x 150 Z.Bianca | Screw Partial Thread DIN 931 PG CI 8.8 M 12 x 150 Z. white |
| BV244 | BV024400 | NR | Vite TCEI PG DIN 912 CI 8.8 M5 x 50 ZINGATA BIANCA | Screw DIN 912 CI 8.8 M5 x 50 |
| BV245 | BV024500 | NR | Vite TE Parziale Filetto PG DIN 931 CI 8.8 M 8 x 110 Z.Bianca | Screw Partial Thread DIN 931 PG CI 8.8 M 8 x 110 Z. white |
| BV246 | BV024600 | NR | Vite TE Parziale Filetto PG DIN 931 CI 8.8 M 8 x 40 Z.Bianca | Screw Partial Thread DIN 931 PG CI 8.8 M 8 x 40 Z. white |
| BV247 | BV024700 | NR | Vite TE Tutto Filetto PG DIN 933 CI 8.8 M 5 x 50 Z.D.Bianca | Screw All Thread DIN 933 PG CI 8.8 M 5 x 50 ZD white |
| BV248 | BV024800 | NR | Vite TCEI PG DIN 912 CI 8.8 M5 x 18 Z. BIANCA | Screw DIN 912 CI 8.8 M5 x 18 Z. WITHE |
| BV249 | BV024900 | NR | Vite TSPEI PG DIN 7991 CI 10.9 M 5 x 65 Z.Bianca | TSPEI PG screw DIN 7991 CI 10.9 M 5 x 65 Z. white |
| BV251 | BV025100 | NR | Vite TSPEI PG DIN 7991 CI 10.9 M 8 x 35 Z.Bianca | TSPEI PG screw DIN 7991 CI 10.9 M 8 x 35 Z. white |
| BV252 | BV025200 | NR | Vite TE Tutto Filetto PG DIN 933 CI 10.9 M 12 x 40 Z.D.Bianca | Screw All Thread DIN 933 PG CI 10.9 M 12 x 40 ZD white |
| BV253 | BV025300 | NR | Vite TBEI PG ISO 7380 M 6 x 55 Z.Bianca | Hex socket screw ISO 7380 PG M 6 x 55 Z. white |
| BV254 | BV025400 | NR | Vite TE Tutto Filetto PG DIN 933 CI 10.9 M 10 x 35 Z.D.Bianca | Screw All Thread DIN 933 PG CI 10.9 M 10 x 35 ZD white |

| POS | Codice | U.M. |  Descrizione |  Description |
|-------|----------|------|---|---|
| BV255 | BV025500 | NR | Vite TE Tutto Filetto PG DIN 933 CI 12.9 M 14 x 55 Z.D.Bianca | Screw All Thread DIN 933 PG CI 12.9 M 14 x 55 ZD white |
| BV256 | BV025600 | NR | Vite Testa Svasata Croce Autofilettante 6 x25 | Screw Head Cross Countersunk Self Tapping 6 x 25 |
| BV257 | BV025700 | NR | Vite TE Tutto Filetto PG DIN 933 CI 8.8 M14 x 30 Z.Bianca | Screw All Thread DIN 933 PG CI 8.8 M14 x 30 Z. white |
| BV258 | BV025800 | NR | Vite TE Tutto Filetto PG DIN 933 CI 10.9 M 12 x 35 Z.D.Bianca | Screw All Thread DIN 933 PG CI 10.9 M 12 x 35 ZD white |
| BV259 | BV025900 | NR | Vite TE Tutto Filetto PG DIN 933 CI 8.8 M 16 x 45 Z.Bianca | Screw All Thread DIN 933 PG CI 8.8 M16 x 45 Z. white |
| BV260 | BV026000 | NR | Vite TCEI PG DIN 912 CI 10.9 M 12 x 30 ZINCATA BIANCA | Screw DIN 912 CI 10.9 M 12 x 30 |
| BV261 | BV026100 | NR | Vite TCEI PG DIN 912 CI 10.9 M 12 x 20 ZINCATA BIANCA | Screw DIN 912 CI 10.9 M 12 x 20 |
| BV262 | BV026200 | NR | Vite TCEI PG DIN 912 CI 12.9 M14 x 35 GEOMET 321A | Screw DIN 912 CI 12.9 M14 x 35 GEOMET 321A |
| BV263 | BV026300 | NR | Vite TCEI PG DIN 912 CI 12.9 M14 x 3 GEOMET 321A | Screw DIN 912 CI 12.9 M14 x 3 GEOMET 321A |
| BV264 | BV026400 | NR | Vite TSPEI PG DIN 7991 CI 10.9 M 12 x 25 Z.Bianca | TSPEI PG screw DIN 7991 CI 10.9 M12 x 25 Z. white |
| BV265 | BV026500 | NR | Vite TE Parziale Filetto PG DIN 931 CI 10.9 M 16 x 180 GEOMET 321A | Screw Partial Thread DIN 931 PG CI 10.9 M 16 x 180 GEOMET 321A |
| BV266 | BV026600 | NR | Vite TE Tutto Filetto PG DIN 933 CI 8.8 M8 x 10 Z.Bianca | Screw All Thread DIN 933 PG CI 8.8 M8 x 10 Z. white |
| BV267 | BV026700 | NR | Vite TCEI PG DIN 912 CI 8.8 M 12 x 40 | Screw DIN 912 CI 9.8 M 12 x 40 |
| BV268 | BV026800 | NR | Vite TE Parziale Filetto PG DIN 931 CI 8.8 M 12 x 140 Z.Bianca | Screw Partial Thread DIN 931 PG CI 8.8 M 12 x 140 Z. white |
| BV269 | BV026900 | NR | Vite TC Croce PG DIN 7985 CI 4.8 M 6 x 25 Z.Bianca | Screw DIN 7985 CI 4.8 M 6 x 25 |
| BV270 | BV027000 | NR | Vite TCEI PG DIN 912 CI 8.8 M 12 x 40 | Screw DIN 912 CI 9.8 M 12 x 40 |
| BV271 | BV027100 | NR | TCEI UNC ASME/ANSI B18.3 ASTM A 574 1/2 x 1"1/4 GEOMET | TCEI UNC ASME/ANSI B18.3 ASTM A 574 1/2 x 1"1/4 GEOMET |

| POS | Codice | U.M. |  Descrizione |  Description |
|-------|----------|------|---|---|
| BV272 | BV027200 | NR | TCEI UNC ASME/ANSI B18.3 ASTM A 574 1/4-20 x 1"1/2 GEOMET | TCEI UNC ASME/ANSI B18.3 ASTM A 574 1/4-20 x 1"1/2 GEOMET |
| BV273 | BV027300 | NR | Vite TE Parziale Filetto PG DIN 931 CI 8.8 M 12 x 70 Z.Bianca | Screw Partial Thread DIN 931 PG CI 8.8 M 12 x 70 Z. white |
| BV274 | BV027400 | NR | Vite TE Tutto Filetto PG DIN 933 CI 8.8 M 5 x 20 Z.D.Bianca | Screw All Thread DIN 933 PG CI 8.8 M 5 x 20 ZD white |
| BV275 | BV027500 | NR | Vite TSPEI PG DIN 7991 CI 10.9 M 6 x 70 Z.Bianca | TSPEI PG screw DIN 7991 CI 10.9 M 6 x 70 Z. white |
| BV276 | BV027600 | NR | Vite TCEI PG DIN 912 CI 8.8 M 5 x 14 Z.Bianca | Screw DIN 912 PG CI 8.8 M 5 x 14 Z. white |
| BV277 | BV027700 | NR | Vite TBEI PG ISO 7380 CI 10.9 M 10 x 35 Z.Bianca | Hex socket screw ISO 7380 PG CI 10.9 M 10 x 35 Z. white |
| BV281 | BV028100 | NR | Vite TE Parziale Filetto PG DIN 931 CI 8.8 M 14 x 45 Z.Bianca | Screw Partial Thread DIN 931 PG CI 8.8 M 14 x 45 Z. white |



| POS | Codice | U.M. |  Descrizione |  Description |
|------|----------|------|---|---|
| RB1 | RB000100 | NR | DADO PER OGIVA Ø=12 | NUT FOR OGIVA Ø = 12 |
| RD1 | RD000100 | NR | RACCORDO CORPO A "T" EO F(DKOL)-M-M 8L | FITTING BODY A "T" EO F (DKOL) M-M-8L |
| RD2 | RD000200 | NR | RACCORDO CORPO A "T" EO F(DKOL)-M-M 10L | FITTING BODY A "T" EO F (DKOL) M-M-10L |
| RD3 | RD000300 | NR | RACCORDO CORPO A "T" EO F(DKOL)-M-M 12L | FITTING BODY A "T" EO F (DKOL) M-M-12L |
| RD4 | RD000400 | NR | RACCORDO CORPO A "T" EO F(DKOL)-M-M 15L | FITTING BODY A "T" EO F (DKOL) M-M-15L |
| RD5 | RD000500 | NR | RACCORDO CORPO A "T" EO M-F(DKOL)-M 10L | FITTING BODY A "T" EO M-F (DKOL) M-10L |
| RD6 | RD000600 | NR | RACCORDO CORPO A "T" EO M-F(DKOL)-M 12L | FITTING BODY A "T" EO M-F (DKOL) M-12L |
| RD7 | RD000700 | NR | RACCORDO CORPO A "T" EO 8L M 14*1.5 | FITTING BODY A "T" EO 8L M 14 * 1.5 |
| RD8 | RD000800 | NR | RACCORDO CORPO A "T" EO 10L M 16*1.5 | FITTING BODY A "T" M 10L EO 16 * 1.5 |
| RD9 | RD000900 | NR | RACCORDO CORPO A "T" EO 28L M 36*2 | FITTING BODY A "T" M 28L EO 36 * 2 |
| RD10 | RD001000 | NR | RACCORDO CORPO A "T" EO 28L M 36*2 | FITTING BODY A "T" EO M-F (DKOL) M-10L |
| RD11 | RD001100 | NR | RACCORDO CORPO A "T" EO M-F(DKOL)-M 10L | FITTING BODY A "T" EO M-F (DKOL) M-10L |
| RD12 | RD001200 | NR | ADATTATORE "T" GAS M-FG-M 1/4 1/4 1/4 | ADAPTOR |
| RG1 | RG000100 | NR | RACCORDO CORPO A GOMITO 10L MASCH.-FEMM. DKOL | ELBOW FITTING BODY 10L Masch.-FEMM. DKOL |
| RG2 | RG000200 | NR | RACCORDO CORPO A GOMITO 12L MASCH.-FEMM. DKOL | ELBOW FITTING BODY 12L Masch.-FEMM. DKOL |
| RG3 | RG000300 | NR | RACCORDO CORPO A GOMITO 20S MASCHIO-FEMMINA DKOS | 20S BODY FITTING ELBOW MALE-FEMALE DKOS |
| RG4 | RG000400 | NR | RACCORDO CORPO A GOMITO 28L MASCHIO-FEMMINA DKOL | 28L BODY FITTING ELBOW MALE-FEMALE DKOL |

| POS | Codice | U.M. |  Descrizione |  Description |
|------|----------|------|---|---|
| RG5 | RG000500 | NR | RACCORDO A L MASCHIO-FEMMINA 1/8 | BODY 90 ° M / F 1/8 " |
| RG6 | RG000600 | NR | ADATTATORE 90° BSPP M-FG 1/4 | ADAPTOR |
| RN1 | RN000100 | NR | RACCORDO CORPO D'ESTREMITA' TENUTA ED 8L * 3/8 GAS *K* | END FITTING WITH SEAL ED 8L * 3/8 GAS * K * |
| RN2 | RN000200 | NR | RACCORDO CORPO D'ESTREMITA' TENUTA ED 12L * 3/8 GAS *K* | END FITTING WITH SEAL ED 12L * 3/8 GAS * K * |
| RN3 | RN000300 | NR | RACCORDO CORPO D'ESTREMITA' TENUTA ED 10L * 3/8 GAS *K* | FITTING END OF BODY 'AND SEAL 10L * 3/8 GAS * K * |
| RN4 | RN000400 | NR | RACCORDO CORPO D'ESTREMITA' TENUTA ED 8L * 1/4 GAS *K* | END FITTING WITH SEAL ED 8L * 1/4 GAS * K * |
| RN5 | RN000500 | NR | RACCORDO CORPO D'ESTREMITA'TENUTA ED 10L * 1/4 GAS *K* | FITTING END OF BODY 'AND SEAL 10L * 1/4 GAS * K * |
| RN6 | RN000600 | NR | RACCORDO CORPO D'ESTREMITA' TENUTA ED 12L * 1/4 GAS | FITTING END OF BODY 'AND SEAL 12L * 1/4 GAS |
| RN7 | RN000700 | NR | RACCORDO NIPLES GAS CON.- GAS CON. 1/4" * 1/4" | FITTING |
| RN8 | RN000800 | NR | RACCORDO CORPO D'ESTREMITA' TENUTA ED 15L * 1/2 GAS *K* | END FITTING WITH SEAL ED 15L * 1/2 * K * GAS |
| RN9 | RN000900 | NR | RACCORDO CORPO D'ESTREMITA' TENUTA ED 10L * 1/2 GAS *K* | FITTING END OF BODY 'AND SEAL 10L * 1/2 * K * GAS |
| RN10 | RN001000 | NR | RACCORDO CORPO D'ESTREMITA' TENUTA ED 15L * 3/4 GAS *K* | END FITTING WITH SEAL ED 15L * 3/4 GAS * K * |
| RN11 | RN001100 | NR | RACCORDO CORPO D'ESTREMITA' TENUTA ED 12L * 1/2 GAS *K* | END FITTING WITH SEAL ED 12L * 1/2 GAS * K * |
| RN12 | RN001200 | NR | RACCORDO CORPO D'ESTR. TENUTA ED 8L * 1/2 GAS | END FITTING WITH SEAL ED 8L * 1/2 GAS |
| RN13 | RN001300 | NR | RACCORDO CORPO D'ESTR. TENUTA ED 8L * 3/4 GAS | CONNECTOR BODY OF EXTR. SEAL AND 8L * 3/4 GAS |
| RN14 | RN001400 | NR | RACCORDO CORPO D'ESTR. TENUTA ED 12L * 3/4 GAS | CONNECTOR BODY OF EXTR. SEAL AND 12L * 3/4 GAS |

| POS | Codice | U.M. |  Descrizione |  Description |
|------|----------|------|---|---|
| RN15 | RN001500 | NR | RACCORDO CORPO D'ESTR. TENUTA ED 15L * 3/8 GAS | END FITTING WITH SEAL ED 15L * 3/8 GAS |
| RN16 | RN001600 | NR | RACCORDO CORPO D'ESTR. TENUTA ED 22L * 3/4 GAS | END FITTING WITH SEAL ED 22L * 3/4 GAS |
| RN17 | RN001700 | NR | RACCORDO CORPO D'ESTR. TENUTA ED 28L * 3/4" GAS | END FITTING WITH SEAL ED 28L * 3/4 BSP |
| RN18 | RN001800 | NR | RACCORDO CORPO D'ESTR. TENUTA ED 20S * 3/4 GAS | CONNECTOR BODY OF EXTR. SEAL AND 20S * 3/4 GAS |
| RN19 | RN001900 | NR | RACCORDO CORPO D'ESTREMITA' 8L * M 12X1.5 ED | END FITTING 8L * M 12x1.5 ED |
| RN20 | RN002000 | NR | RACCORDO CORPO D'ESTREMITA' 8L * M 14X1.5 ED | FITTING END OF BODY 'AND 8L * M 14x1.5 |
| RN21 | RN002100 | NR | RACCORDO CORPO D'ESTREMITA' 10L * M 18X1.5 ED | END FITTING 10L * M 18x1.5 |
| RN22 | RN002200 | NR | RACCORDO CORPO D'ESTR. TENUTA ED 15L * M 18X1.5 | CONNECTOR BODY OF EXTR. SEAL AND 15L * M 18x1.5 |
| RN23 | RN002300 | NR | RACCORDO CORPO D'ESTR. TENUTA ED 15L * M 22X1.5 | END FITTING WIHT SEAL ED 15L * M 22x1.5 |
| RN24 | RN002400 | NR | RACCORDO CORPO D'ESTR. TENUTA ED 22L * M26X1.5 | CONNECTOR BODY OF EXTR. SEAL AND 22L * M26x1.5 |
| RN25 | RN002500 | NR | RACCORDO CORPO D'ESTR. TENUTA ED 20S * M27X2 | CONNECTOR BODY OF EXTR. SEAL AND 20S * M27X2 |
| RN26 | RN002600 | NR | RACCORDO CORPO D'ESTR. 8L * 9/16-18 UNF-2A | END FITTING 8L * 9/16-18 UNF-2A |
| RN27 | RN002700 | NR | RACCORDO CORPO D'ESTR. 12L * 3/4 -16 UNF-2A | END FITTING 12L * 3/4 -16 UNF-2A |
| RN28 | RN002800 | NR | RACCORDO CORPO D'ESTR. 20S * 1.5/16 -12 UN-2A | END FITTING 20S * 1.5/16 -12 UN-2A |
| RN29 | RN002900 | NR | RACCORDO CORPO D'ESTR. TENUTA ED 22L * M26X1.5 | END FITTING WITH SEAL ED 22L * M26x1.5 |
| RN30 | RN003000 | NR | RACCORDO CORPO D'ESTR. TENUTA ED 22L * M26X1.5 | END FITTING WITH SEAL ED 22L * M26x1.5 |
| RN31 | RN003100 | NR | RACCORDO CORPO D'ESTREMITA' TENUTA ED 6L * 1/4 GAS *K* | END FITTING WITH SEAL 1/4 BSPP 6L |

| POS | Codice | U.M. |  Descrizione |  Description |
|------|----------|------|---|---|
| RN32 | RN003200 | NR | RACCORDO CORPO D'ESTREMITA' TENUTA ED 8L * 3/8 GAS *K* | END FITTING WITH SEAL ED 8L * 3/8 GAS * K * |
| RN33 | RN003300 | NR | NIPPLES 1/8" JIS 1/8"GAS | CAP |
| RN34 | RN003400 | NR | NIPPLES 1/4" JIS 1/4"GAS | CAP |
| RN35 | RN003500 | NR | NIPPLES 3/8" JIS 1/4"GAS | CAP |
| RN36 | RN003600 | NR | NIPPLES 3/8" JIS 1/4"GAS | CAP |
| RO1 | RO000100 | NR | OGIVA PER TUBO Ø=12 | OGIVE FOR TUBE Ø = 12 |
| RR1 | RR000100 | NR | RONDELLA RAME 1/4 | COPPER WASHER 1/4 |
| RR2 | RR000200 | NR | RONDELLA BONDED GAS 3/8" *K* | BONDED WASHER GAS 3/8 " K * |
| RR3 | RR000300 | NR | RONDELLA BONDED METRICA 12 *K* | METRIC BONDED WASHER 12 * K * |
| RR4 | RR000400 | NR | RONDELLA BONDED GAS 1/4" *K* | BONDED WASHER GAS 1/4 " K * |
| RR5 | RR000500 | NR | RONDELLA BONDED GAS 1/2" *K* | BONDED WASHER GAS 1/2 " K * |
| RR6 | RR000600 | NR | RONDELLA RAME 3/8 | COPPER WASHER 3/8 |
| RR7 | RR000700 | NR | RONDELLA BONDED GAS 1/8" *K* | BONDED WASHER GAS 1/8 " K * |
| RR8 | RR000800 | NR | RONDELLA BONDED GAS 1" *K* | BONDED WASHER GAS 1 " K * |
| RR9 | RR000900 | NR | RONDELLA BONDED GAS 3/4" *K* | BONDED WASHER GAS 3/4 " K * |
| RR10 | RR001000 | NR | RONDELLA BONDED GAS 1.1/4" | BONDED WASHER GAS 1.1 / 4 " |
| RR11 | RR001100 | NR | RONDELLA RAME M10 | COPPER WASHER M10 |
| RR12 | RR001200 | NR | RONDELLA RAME 1/2 | COPPER WASHER 1/2 |

| POS | Codice | U.M. |  Descrizione |  Description |
|------|----------|------|---|---|
| RR13 | RR001300 | NR | RONDELLA BONDED M12 | BONDED WASHER M12 |
| RS1 | RS000100 | NR | COPPIA SEMIFLANGE SAE 6000 3/4" | PAIR 6000 SAE flange halves 3/4 " |
| RS2 | RS000200 | NR | RACC.M 20S(M30x2) - ED M 1"5/16 UNF H=33 | FITTING M 20S (M30x2) - ED M 1 "5/16 UNF H = 33 |
| RS3 | RS000300 | NR | RIDUZIONE M-F GAS 1" * 1/2" | REDUCING GAS M-F 1 "*" 1/2" |
| RS4 | RS000400 | NR | RACCORDO COLONNETTA M15L - 3/8" GAS H=50 | COLUMN CONNECTION M15L - 3/8 "GAS H = 50 |
| RS5 | RS000500 | NR | RACCORDO COLONNETTA M15L - 3/8" GAS H=96 | COLUMN CONNECTION M15L - 3/8 "GAS H = 96 |
| RS6 | RS000600 | NR | CODOLO M1/4" ED X FG 8L (M14X1.5) | FITTING M1 / 4 "X AND FG 8L (M14X1.5) |
| RS7 | RS000700 | NR | RIDUZIONE M-F GAS 1" * 1/2" | REDUCING GAS M-F 1 "*" 1/2" |
| RS8 | RS000800 | NR | RACCORDO CODOLO D' ESTR. FEM. DKO 12I*3/8 GAS ED | END FITTING FEM. DKO 12I*3/8 GAS ED |
| RS9 | RS000900 | NR | MANICOTTO ARIA 1/8-1/8 | AIR MANIFOLD 1/8-1/8 |
| RS10 | RS001000 | NR | RIDUZIONE M-F GAS 3/8" JIS 1/8" BSPP | REDUCING GAS M-F 3/8" JIS 1/8" BSPP |
| RS11 | RS001100 | NR | RACCORDO M-M 15L | FITTING M-M 15L |
| RS12 | RS001200 | NR | RACCORDO NIPLES GAS CON.- GAS CON.1/2"1/2" | FITTING 1/2" - 1/2" |
| RT1 | RT000100 | NR | TAPPO MASCHIO TE GAS 3/8" SVASATO 60° *K* | SCREW EYE FOR GAS 1/2 "H = 50 |
| RT2 | RT000200 | NR | TAPPO MASCHIO ESAGONO INTERNO GAS 1/4" SVASATO 60° *K* | MALE PLUG GAS INTERNAL HEX 1/4 "FLARE 60 ° * K * |
| RT3 | RT000300 | NR | TAPPO MASCHIO TE GAS 1/2" SVASATO 60° *K* | MALE PLUG TE GAS 1/2 "FLARE 60 ° * K * |
| RT4 | RT000400 | NR | TAPPO MASCHIO TE GAS 1/4" SVASATO 60° *K* | MALE PLUG TE GAS 1/4 "FLARE 60 ° * K * |

| POS | Codice | U.M. |  Descrizione |  Description |
|------|----------|------|---|---|
| RT5 | RT000500 | NR | TAPPO MASCHIO ESAGONO INTERNO GAS 3/8" SVASATO 60° *K* | MALE PLUG GAS INTERNAL HEX 3/8 "FLARE 60 ° * K * |
| RT6 | RT000600 | NR | TAPPO MASCHIO ESAGONO INTERNO GAS 1" SVASATO 60° *K* | MALE PLUG GAS INTERNAL HEX 1 "FLARE 60 ° * K * |
| RT7 | RT000700 | NR | TAPPO MASCHIO TE GAS 1/8" SVASATO 60° *K* | MALE PLUG TE GAS 1/8 "FLARE 60 ° * K * |
| RT8 | RT000800 | NR | TAPPO MASCHIO TE GAS 1/4" JIS | MALE PLUG TE GAS 1/4 " JIS |
| RT9 | RT000900 | NR | TAPPOO FEMMINA COMPLETO 6L | COMPLETE 6L FEMALE CAP |
| RT10 | RT001000 | NR | TAPPOO FEMMINA COMPLETO 8L | COMPLETE 8L FEMALE CAP |
| RT11 | RT001100 | NR | Tappo cilindrico TCEI+guarnizione GAS CI 5.8 3/4 Z.Bianca | cylindrical socket head cap + seal GAS CI 5.8 3/4 Z. White |
| RT12 | RT001200 | NR | Tappo cilindrico TCEI+guarnizione GAS CI 5.8 1/2 Z.Bianca | cylindrical socket head cap + seal GAS CI 5.8 1/2 Z. White |
| RV1 | RV000100 | NR | VITE PER OCCHIO GAS 1/4" H=29 *K* | SCREW EYE FOR GAS 1/4 "H = 29 * K * |
| RV2 | RV000200 | NR | VITE PER OCCHIO DOPPIA GAS 3/8" | SCREW EYE DOUBLE FOR GAS 3/8 " |
| RV3 | RV000300 | NR | VITE PER OCCHIO GAS 1/2" H= 50 | SCREW EYE FOR GAS 1/2 "H = 50 |
| RV4 | RV000400 | NR | VITE PER OCCHIO DOPPIA GAS 1/4" | DOUBLE EYE SCREW FOR GAS 1/4" |
| RV5 | RV000500 | NR | VITE PER OCCHIO GAS 3/8" | SCREW EYE FOR GAS 3/8" |
| RV6 | RV000600 | NR | VITE PER OCCHIO GAS 1/8" | SCREW EYE FOR GAS 1/8" |

PARTS FINDER

**Search Website
by Part Number**



**Search Manual
Library For Parts
Manual & Lookup Part
Numbers – Purchase
or Request Quote**

Search Manuals

Enter your information to help us find the right parts manual for your machine.

* Brand:

* Model:

* Serial:

* Part Number:

SEARCH

**Can't Find Part or
Manual? Request Help
by Manufacturer,
Model & Description**

Parts Order Form

Please fill in the following information to help us find the right part for your machine.

| | |
|---------------|----------------------|
| Manufacturer: | <input type="text"/> |
| Model: | <input type="text"/> |
| Description: | <input type="text"/> |
| Part Number: | <input type="text"/> |
| Quantity: | <input type="text"/> |
| Notes: | <input type="text"/> |

Submit

Discount-Equipment.com is your online resource for quality parts & equipment.

Florida: **561-964-4949** Outside Florida TOLL FREE: **877-690-3101**

Need parts?

Click on this link: <http://www.discount-equipment.com/category/5443-parts/> and choose one of the options to help get the right parts and equipment you are looking for. Please have the machine model and serial number available in order to help us get you the correct parts. If you don't find the part on the website or on one of the online manuals, please fill out the request form and one of our experienced staff members will get back to you with a quote for the right part that your machine needs.

We sell worldwide for the brands: Genie, Terex, JLG, MultiQuip, Mikasa, Essick, Whiteman, Mayco, Toro Stone, Diamond Products, Generac Magnum, Airman, Haulotte, Barreto, Power Blanket, Nifty Lift, Atlas Copco, Chicago Pneumatic, Allmand, Miller Curber, Skyjack, Lull, Skytrak, Tsurumi, Husquvarna Target, Stow, Wacker, Sakai, Mi-T-M, Sullair, Basic, Dynapac, MBW, Weber, Bartell, Bennar Newman, Haulotte, Ditch Runner, Menegotti, Morrison, Contec, Buddy, Crown, Edco, Wyco, Bomag, Laymor, EZ Trench, Bil-Jax, F.S. Curtis, Gehl Pavers, Heli, Honda, ICS/PowerGrit, IHI, Partner, Imer, Clipper, MMD, Koshin, Rice, CH&E, General Equipment, Amida, Coleman, NAC, Gradall, Square Shooter, Kent, Stanley, Tamco, Toku, Hatz, Kohler, Robin, Wisconsin, Northrock, Oztec, Toker TK, Rol-Air, APT, Wylie, Ingersoll Rand / Doosan, Innovatech, Con X, Ammann, Mecalac, Makinex, Smith Surface Prep, Small Line, Wanco, Yanmar