

# **morrison**

CONCRETE EQUIPMENT

**INSTRUCTION MANUAL & PARTS BOOK**  
Serial Number 6500000 and BELOW

## **MORRISON UNI-SCREED**

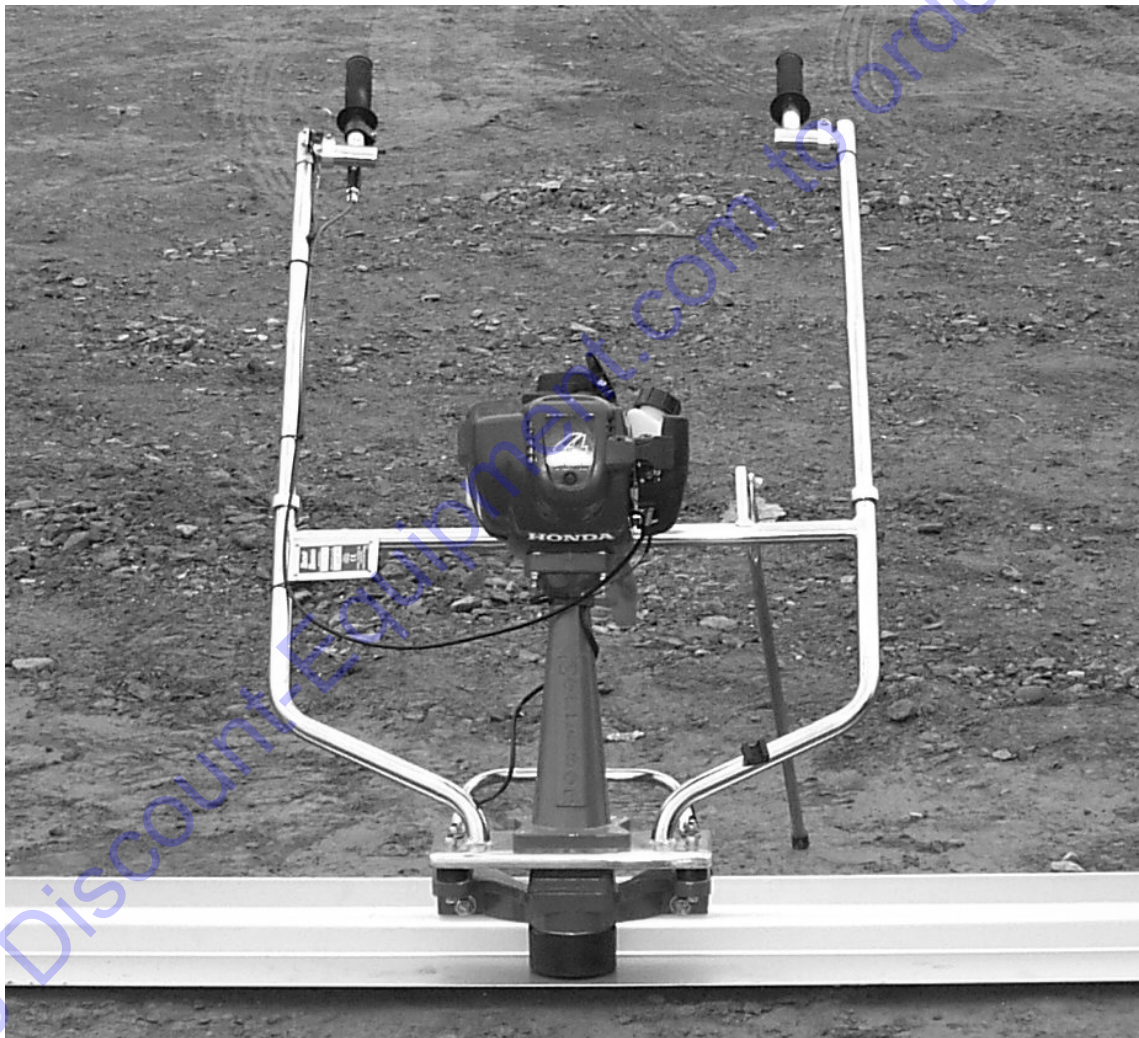

**POWERFUL - EFFICIENT - DEPENDABLE**

Doc. # OIPB – M09202  
Orig. Rel. – 06/2007  
Curr. Rev. – 10  
Rev. Date – 06/2014



[www.discount-equipment.com](http://www.discount-equipment.com)

# PARTS FINDER

**Search Website  
by Part Number**



**Search Manual  
Library For Parts  
Manual & Lookup Part  
Numbers – Purchase  
or Request Quote**

**Search Manuals**

Enter your information to help us find the right parts manual for your machine.

\* Brand:

\* Model:

\* Serial:

\* Part Number:

SEARCH

**Can't Find Part or  
Manual? Request Help  
by Manufacturer,  
Model & Description**

**Parts Order Form**

Please fill in the following information to help us find the right part for your machine.

Manufacturer:	<input type="text"/>
Model:	<input type="text"/>
Description:	<input type="text"/>
Part Number:	<input type="text"/>
Quantity:	<input type="text"/>
Notes:	<input type="text"/>

Submit

Discount-Equipment.com is your online resource for quality parts & equipment.











Florida: **561-964-4949** Outside Florida TOLL FREE: **877-690-3101**

**Need parts?**

Click on this link: <http://www.discount-equipment.com/category/5443-parts/> and choose one of the options to help get the right parts and equipment you are looking for. Please have the machine model and serial number available in order to help us get you the correct parts. If you don't find the part on the website or on one of the online manuals, please fill out the request form and one of our experienced staff members will get back to you with a quote for the right part that your machine needs.

We sell worldwide for the brands: Genie, Terex, JLG, MultiQuip, Mikasa, Essick, Whiteman, Mayco, Toro Stone, Diamond Products, Generac Magnum, Airman, Haulotte, Barreto, Power Blanket, Nifty Lift, Atlas Copco, Chicago Pneumatic, Allmand, Miller Curber, Skyjack, Lull, Skytrak, Tsurumi, Husquvarna Target, Stow, Wacker, Sakai, Mi-T-M, Sullair, Basic, Dynapac, MBW, Weber, Bartell, Bennar Newman, Haulotte, Ditch Runner, Menegotti, Morrison, Contec, Buddy, Crown, Edco, Wyco, Bomag, Laymor, EZ Trench, Bil-Jax, F.S. Curtis, Gehl Pavers, Heli, Honda, ICS/PowerGrit, IHI, Partner, Imer, Clipper, MMD, Koshin, Rice, CH&E, General Equipment, Amida, Coleman, NAC, Gradall, Square Shooter, Kent, Stanley, Tamco, Toku, Hatz, Kohler, Robin, Wisconsin, Northrock, Oztec, Toker TK, Rol-Air, APT, Wylie, Ingersoll Rand / Doosan, Innovatech, Con X, Ammann, Mecalac, Makinex, Smith Surface Prep, Small Line, Wanco, Yanmar

# MORRISON UNI-SCREED INSTRUCTION MANUAL

SAFETY PRECAUTIONS	
	<p> <b>DANGER</b></p> <p><b>EXPLOSION HAZARD</b> Never operate the machine in an explosive atmosphere, near combustible materials or where ventilation does not clear exhaust fumes.</p>
	<p> <b>WARNING</b></p> <p><b>BURN HAZARD</b> Never come into contact with the engine or muffler when engine is operating or shortly after it is turned off. Serious burns may occur.</p>
	<p> <b>WARNING</b></p> <p><b>ROTATING HAZARD</b> Never place hands or feet inside safety guard rings. Serious injury will result from contact with rotating blades.</p>
	<p> <b>CAUTION</b></p> <p><b>MOVING PARTS</b> Before starting the machine ensure that all guards and safety devices are in place and functioning properly.</p>
	<p> <b>ATTENTION</b></p> <p><b>READ OWNERS MANUAL</b> Read and understand operator's manual before using this machine. Failure to follow operating instructions could result in serious injury or death.</p>

# MORRISON UNI-SCREED INSTRUCTION MANUAL

## TABLE OF CONTENTS

QUALITY ASSURANCE AND MACHINE BREAK IN .....	3
MORRISON UNI-SCREED WARRANTY .....	4
PREVENTATIVE MAINTENANCE AND ROUTINE SERVICE PLAN ..	5
ROUTINE SERVICE INTERVALS .....	6
GENERAL HEALTH AND SAFETY TIPS .....	7
MAINTENANCE AND CLEANING .....	7
INITIAL SETUP OF THE UNI-SCREED .....	8
OPERATION OF THE UNI-SCREED .....	9
TECHNICAL SERVICE BULLETIN .....	10
DRAWINGS AND PARTS LIST .....	11
NOTES .....	14

## **QUALITY ASSURANCE / MACHINE BREAK IN**

The Morrison Uni-screed is the product of extensive engineering development designed to give long life and unmatched performance. You can help ensure that your Uni-screed will perform at top levels by observing a simple routine on first use. Consider that your new Uni-screed is like a new car. Just as you would break in a new car to the road or any new machine to the job, you should start gradually and build up to full use. Learn what your machine can do and how it will respond. Refer to the engine manufacturer's manual for run-in times. Full throttle and control may be used after this time period, as allowed by material. This will serve to further break in the machine on your specific application, as well as provide you with additional practice using the machine.

We thank you for the confidence you have placed in us by purchasing a Morrison Uni-screed and wish you many years of satisfied use.

## MORRISON UNI-SCREED INSTRUCTION MANUAL

### MORRISON UNI-SCREED WARRANTY

Bartell Morrison Inc. agrees to furnish without charge, F.O.B. our plant, a replacement for any part or portion thereof, comprising the base unit of the Morrison Uni-screed, consisting of the drive shaft assembly and the clutch assemblies, save and except power units and/or bearing or electrical controls which prove upon our examination, to be defective in either material or workmanship within a period of twelve (12) months from date of purchase, provided that notice of such defective part or portion thereof is given to Bartell Morrison Inc. within the twelve month warranty period. No further or other guarantee or warranty expressed or implied in connection with the sale of the Morrison Uni-screed is given and our sole liability consists in replacing defective parts or portions thereof. We shall not be responsible for any special, indirect or consequential damages arising in any manner whatsoever.

This guarantee is for the sole benefit of the original purchaser as end user. Our responsibility under this guarantee ends in the case the original purchaser transfers ownership of the Morrison Uni-screed, makes any changes or adds any parts or devices not of our manufacture to the Uni-screed.

Go to Discount-Equipment.com to order your parts



# MORRISON UNI-SCREED INSTRUCTION MANUAL

## MAINTENANCE RECORD

### PREVENTATIVE MAINTENANCE AND ROUTINE SERVICE PLAN

This Bartell Morrison Uni-screed has been assembled with care and will provide years of service. Preventative maintenance and routine service are essential to the long life of your Morrison Uni-screed. Your dealer is interested in your new trowel and has the desire to help you get the most value from it. After reading through this manual thoroughly you will find that you can do some of the regular maintenance yourself. However, when in need of parts or major service be sure to see your Bartell Morrison dealer. For your convenience we have provided this space to record relevant data about your Uni-screed. When in need of parts or service be prepared to provide your Uni-screed serial number. Locate the serial number now and record in the space below.

Date Purchased:		Type of Machine:	
Dealer Name:		Model:	
Dealer Phone:		Serial Number:	

REPLACEMENT PARTS USED				MAINTENANCE LOG	
PART NO.	QUANTITY	COST	DATE	DATE	OPERATION

## MORRISON UNI-SCREED INSTRUCTION MANUAL

<b>Routine Service Intervals</b>		Each use	After 1.5 months or 50 hrs	Each 3 months or 100 hrs	Each 6 months or 200 hrs	Each 9 months or 300 hrs	Each 12 months or 400 hrs
<b>General Inspection:</b>							
Rubber Cap	Check		o	o	o	o	o
Warning stickers	Check		o	o	o	o	o
Test run:	Check operation		o	o	o	o	o
<b>Engine:</b>							
Engine oil	Check Level	o	o	o	o	o	o
	Change		o		o		o
Engine oil filter	Replace				o		o
Oil cooler	Clean			o	o	o	o
Cooling Fins	Clean		o	o	o	o	o
Air cleaner	Check - clean	o	o	o	o	o	o
	Replace						o
Air Intake Line	Check				o		
	Replace						2 yrs
Fan Belt	Check tightness				o		o
	Replace						500 hrs
Valve clearance	Check-adjust				o		o
Fuel filter	Check & Clean			o	o	o	o
	Replace				o		o
Fuel Tank	Clean						500 hrs
Engine wiring	Check						o

Go to Discount-Equipment.com to order your parts

# MORRISON UNI-SCREED INSTRUCTION MANUAL

## **GENERAL HEALTH & SAFETY TIPS**

- Do not use the Morrison Uni-screed, fitted with a gasoline engine, indoors or in poorly ventilated areas. Ensure there is sufficient ventilation to avoid inhaling exhaust gasses, as they may be harmful.
- Avoid touching the electrical cables or spark plug cap while the engine is running to avoid electric shock.
- Check the fuel tank and lines for leaks before starting engine.
- Wear appropriate personal protective equipment while operating the Morrison Uni-screed. Protective footwear, safety glasses, hearing protection, padded gloves, and a dust mask are highly recommended.
- Wear work gloves and safety glasses while refueling the Morrison Uni-screed.
- Ensure sufficient ventilation during refueling to avoid a build-up of dangerous fumes.
- Refuel the Morrison Uni-screed only after the engine has cooled after use.
- Avoid smoking or open ignition sources such as furnaces, welders or torches during refueling.
- Avoid contact of limbs with the vibrating blade or base unit during operation. Use only the handles to control the Morrison Uni-screed.
- Some vibration in the control handles during operation is normal. Take appropriate measures dictated by your workplace regulations to minimize health effects of vibration exposure.
- Regular maintenance and inspection of the Morrison Uni-screed can prevent injuries caused by worn-out or damaged equipment and will extend the useful life of your unit.
- Carry the Morrison Uni-screed by the carry handle, lifting carefully to avoid back injury.
- NEVER carry the Morrison Uni-screed while the engine is running.
- Always avoid direct skin contact with fresh concrete.

## **MAINTENANCE AND CLEANING**

Due to the nature and environment of use, the Uni-screed is exposed to severe operating conditions. Some general maintenance guidelines will extend the useful life of your trowel.

- It is highly recommended that all maintenance and repairs are carried out by approved Bartell Morrison dealers.
- Always use genuine Bartell Morrison replacement parts; use of foreign parts may void your warranty and result in injury or damage to property.
- Refer to your engine manual for details of engine cleaning, maintenance, and your engine's warranty coverage.
- Clean concrete, dust, and residue from the blade and base unit daily. Failure to do so will result in decreased performance and premature failure.
- The blade and lower base unit (i.e. below the engine) can be cleaned with a water sprayer. Avoid getting water inside the engine housing or into the on/off switch on the handle.
- Clean the engine ventilation openings using a brush or damp cloth. Dirt, grease, or concrete entering the ventilation openings will reduce engine cooling, leading to premature engine wear and failure. Refer to your engine manual for more information.
- Inspect the Morrison Uni-screed at the end of each working day for signs of wear or damage.
- Store the Morrison Uni-screed in a clean, dry, and dust free place.



# MORRISON UNI-SCREED INSTRUCTION MANUAL

## INITIAL SETUP OF THE UNI-SCREED

Upon removing the Morrison Uni-screed from its box for the first time, you will find the base unit with the handles removed for shipping. The left handle is sitting freely in the box, while the right handle is attached to the base unit by its electrical cable and throttle control cable. The throttle control cable is not connected to the engine during shipping to avoid damage to the cable and engine.

To connect the throttle cable, first set up the handles using the clamps and hex key provided. Set the length and rotation to suit the operator. Then:

- Open the Honda engine air filter cover by gently squeezing the clip on the inside front of the black filter housing, and rotate the housing cover back out of the way.
- Pull the throttle cable over to the engine throttle wheel.
- Rotate the silver throttle wheel so that the larger hole is pointing toward the top of the engine.
- Slide the stainless steel throttle cable through the slot in the throttle wheel.

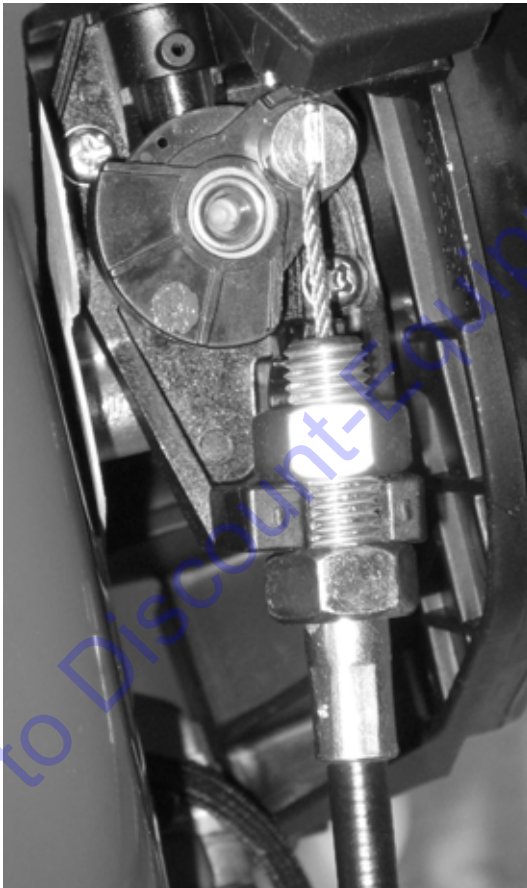

**CORRECTLY INSTALLED CABLE**



- Pull the stainless steel throttle cable downward to insert the slug fitting into the large hole in the throttle wheel.
- Place the threaded fitting of the throttle cable conduit into the clamp below the throttle wheel.
- Tighten the nuts of the threaded fitting onto the clamp to lock the conduit in place. Adjust the tension and length of the throttle cable by moving these nuts.
- With the throttle grip at the end of the right operator handle released, the throttle wheel on the Honda engine should be at the zero position.
- After verifying the operation of the throttle cable by squeezing the throttle grip a few times, replace the air filter cover on the Honda engine. Your Morrison Uni-screed is now ready to use!

# MORRISON UNI-SCREED INSTRUCTION MANUAL

## OPERATION OF THE UNI-SCREED

### OPERATING PRINCIPLE

An eccentric weight mounted on the exciter shaft contained within the vibration housing is driven at high speed by a clutch drive system. This high speed shaft revolution causes the rapid vibratory motion of the blade as well as imparting a forward motion.

The Morrison Uni-screed is designed to run at an engine speed (engine take off shaft) of 3600 rpm. (normally considered full throttle). Running the engine at lower rpm's will result in a decrease of consolidation force and lower travel speed. It will create excessive "out-of-synch" vibrations resulting in poor consolidation, maneuverability, excessive wear to the machine, and discomfort to the operator.

### STARTING PROCEDURE:

#### \* *WARM CLIMATE*

Open fuel valve on gas tank. Set throttle lever to "Fast" idle position, set choke to closed position, start engine. Open choke slightly to prevent flooding. Move to "Open" or "Run" position when engine is warm, increase throttle to maximum operation position (3600 rpm).

### STARTING PROCEDURE:

#### \* *COLD CLIMATE*

Follow same procedure as above but allow longer warm-up period – 3 to 5 minutes. In cold weather, oil is much heavier to move and requires more time to work its way into the moving parts. If maximum power is not attained, allow further warm-up time. Fill fuel tank with clean gasoline, use safety approved gas containers. DO NOT MIX OIL WITH GASOLINE – USE UNLEADED GAS ONLY.

### STOPPING PROCEDURE

1. Throttle engine down.
2. Depress or turn off stop switch.

### OPERATION

1. On level surfaces the Uni-screed moves forward or backward rapidly, depending on the tilt of the handle. On uneven surfaces or inclines, light forward pressure on handle may be required to assist the Uni-screed in moving. Lean the handle up or away from you to make the Uni-screed travel toward you (i.e. forward). Lean the handle down or toward you to make the Uni-screed travel away from you (i.e. backward).
2. ALWAYS OPERATE THE MACHINE AT FULL THROTTLE. If excessive vibration is felt through the handle, do not operate until the engine is checked and set at its maximum running speed of 3600 rpm.
3. The handle has four (4) adjustment clamps to allow the operator to use the Uni-screed more comfortably. Ensure that the screws of all of these clamps are tightened to securely hold the handle sections rigidly. A loose clamp will cause that section to rotate and/or slide away from the desired position.

### LUBRICATION

#### ENGINE OIL

Always check engine oil before starting and at regular intervals thereafter. Use proper engine oil as recommended – see chart below. Keep engine oil clean, change accordingly. Fill crankcase to levels as recommended in manufacturer's engine manual.

# MORRISON UNI-SCREED INSTRUCTION MANUAL

## TECHNICAL SERVICE BULLETIN TC0008

### **SUBJECT:**

Install M12 thick square washers on the blade side instead of regular flat washers when mounting the screed blade to the Uni-Screed.

### **EFFECTIVITY:**

All new Morrison Uni-Screeds and replacement blades.

### **DETAILS:**

The thick square washer will help distribute the mounting pressure evenly across a larger mounting surface.

### **INSTRUCTIONS:**

#### **STEP 1:**

Install the thick M12 square washer and assemble as indicated in the following figures. Two M12 square washer required, p/n 23150.

**Figure 1: Blade side (one shown)**

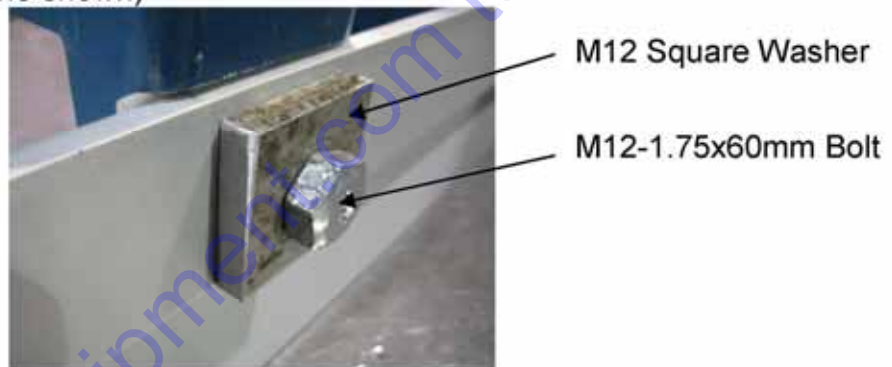

**Figure 1: Other side**

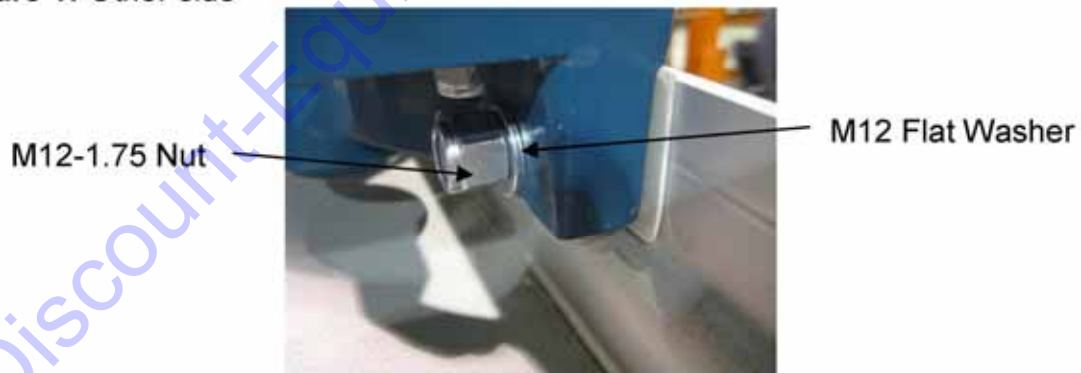

# ASSEMBLY DRAWINGS AND PARTS LIST



Go to Discount-Equipment.com to order your parts

# MORRISON UNI-SCREED INSTRUCTION MANUAL

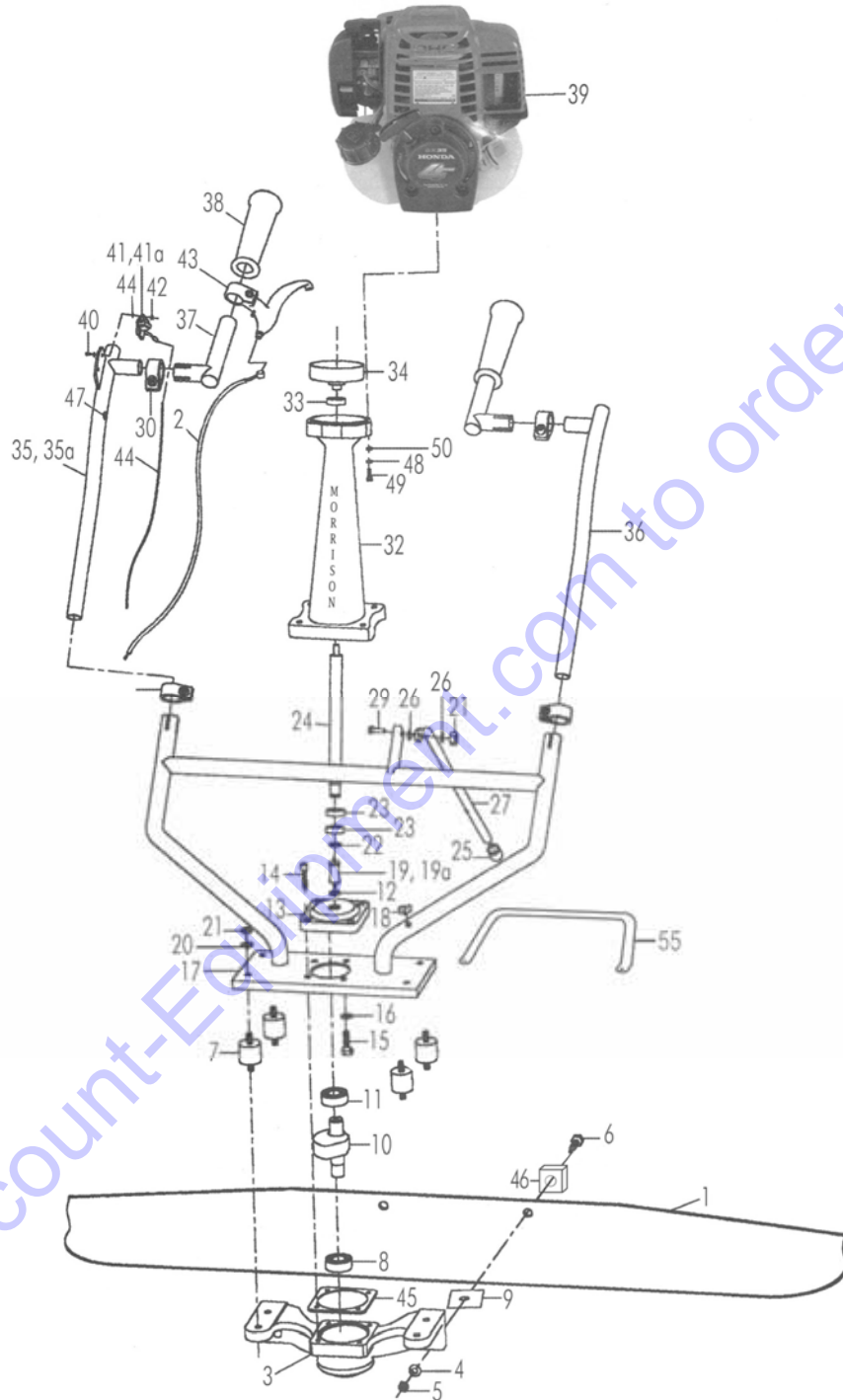

Go to Discount-Engine.com to order your parts

# MORRISON UNI-SCREED INSTRUCTION MANUAL

## MORRISON UNI-SCREED PARTS LIST

<u>ITEM NO.</u>	<u>PART NO.</u>	<u>DESCRIPTION</u>	<u>QTY.</u>
1	22901	SCREED BLADE (12' SHOWN)	1
2	11069	THROTTLE CABLE	1
3	23001	VIBRATION BASE	1
4	10993	FLAT WASHER, M12, YELLOW ZINC	2
5	14268	LOCK NUT, M12, YELLOW ZINC	2
6	10992	HEX HEAD BOLT, M12 X 60MM LG. YELLOW ZINC	2
7	11049	VIBRATION ISOLATION MOUNT	4
8	12464	BEARING, LOWER BASE	1
9	10995	SPACER, PLASTIC	2
10	23005	SHAFT W/ COUNTERWEIGHT	1
11	12449	BEARING, UPPER BASE	1
12	10670	OIL SEAL, SHAFT	1
13	23006	FLANGE, UPPER CONNECTOR	1
14	11028	HEX SOCKET CAP SCREW, M6 X 30MM LG, BLACK	4
15	10997	HEX HEAD BOLT, M8 X 20MM LG, YELLOW ZINC	4
16	10998	LOCK WASHER, M8, YELLOW ZINC	4
17	23002	BASE UNIT HANDLE, CHROME PLATED	1
18	11053	RUBBER CLIP, KICKSTAND	1
19	11051	VIBRATION ISOLATION SHAFT	1
19a	23019	VIBRATION ISOLATION SHAFT (ALTERNATE)	1
20	11000	FLAT WASHER, M8, YELLOW ZINC	8
21	11054	LOCK NUT, M8, ZINC PLATED	9
22	11059	RETAINING RING, EXTERNAL SHAFT	1
23	12466	BEARING, LOWER DRIVE SHAFT	2
24	23003	DRIVE SHAFT	1
25	11060	RUBBER CAP, KICKSTAND	1
26	11055	PLASTIC WASHER, KICKSTAND	2
27	23004	KICK STAND, CHROME PLATED	1
29	10999	HEX HEAD BOLT, M8 X 20MM LG, YELLOW ZINC	1
30	11058	HANDLE CLAMP	4
31	11772	HEX SOCKET CAP SCREW, M8 X 25MM LG, ZINC PLATED	4
32	23000	HOUSING, SHAFT	1
33	12467	BEARING, UPPER DRIVE SHAFT	1
34	11061	CLUTCH DRUM	1
35	23007	HANDLE SECTION, RIGHT, SWITCH MOUNT TYPE	1
35a	11792	HANDLE SECTION, RIGHT, PUSH BUTTON SWITCH TYPE	1
36	23008	HANDLE SECTION, LEFT	1
37	23009	HANDLE GRIP SECTION	2
38	11056	HAND GRIPS, HANDLE, PAIR	1
39	21365	ENGINE, HONDA GX35, 1.3 HP, 7000 RPM	1
40	11035	ROUND HEAD MACHINE SCREW, M4 X 10MM LG, ZP	2
41	11322	ON/OFF SWITCH (TOGGLE TYPE)	1
41a	11892	ON/OFF SWITCH (PUSH BUTTON TYPE) ASSEMBLY WITH WIRE	1



## MORRISON UNI-SCREED INSTRUCTION MANUAL

41a	11791	ON/OFF SWITCH (PUSH BUTTON TYPE) ASSEMBLY WITHOUT WIRE	1
42	11036	HEX NUT, M4, ZINC PLATED	2
43	11064	THROTTLE HANDLE	1
45	23013	GASKET	1
46	23150	SQUARE BUSHING, ALUMINUM	2
47	23153	GROMMET	2
48	14448	LOCK WASHER, M6, ZINC PLATED	4
49	31238	HEX SOCKET CAP SCREW, M6X35MM LG	4
50	14447	FLAT WASHER, M6, ZINC PLATED	4
52	11893	SCREW, M5 X 8MM LG; ZP	1
53	11844	LOCKWASHER, M5, ZINC PLATED	1
54	30846	FLAT WASHER, M5, ZINC PLATED	1
55	23151	CARRY HANDLE	1

Go to Discount-Equipment.com to order your parts

# PARTS FINDER

**Search Website  
by Part Number**



**Search Manual  
Library For Parts  
Manual & Lookup Part  
Numbers – Purchase  
or Request Quote**

**Search Manuals**

Enter your information to help us find the right parts manual for your machine.

\* Brand:

\* Model:

\* Serial:

\* Part Number:

SEARCH

**Can't Find Part or  
Manual? Request Help  
by Manufacturer,  
Model & Description**

**Parts Order Form**

Please fill in the following information to help us find the right part for your machine.

Manufacturer:	<input type="text"/>
Model:	<input type="text"/>
Description:	<input type="text"/>
Part Number:	<input type="text"/>
Quantity:	<input type="text"/>
Notes:	<input type="text"/>

Submit

Discount-Equipment.com is your online resource for quality parts & equipment.

Florida: **561-964-4949** Outside Florida TOLL FREE: **877-690-3101**

**Need parts?**

Click on this link: <http://www.discount-equipment.com/category/5443-parts/> and choose one of the options to help get the right parts and equipment you are looking for. Please have the machine model and serial number available in order to help us get you the correct parts. If you don't find the part on the website or on one of the online manuals, please fill out the request form and one of our experienced staff members will get back to you with a quote for the right part that your machine needs.

We sell worldwide for the brands: Genie, Terex, JLG, MultiQuip, Mikasa, Essick, Whiteman, Mayco, Toro Stone, Diamond Products, Generac Magnum, Airman, Haulotte, Barreto, Power Blanket, Nifty Lift, Atlas Copco, Chicago Pneumatic, Allmand, Miller Curber, Skyjack, Lull, Skytrak, Tsurumi, Husquvarna Target, Stow, Wacker, Sakai, Mi-T-M, Sullair, Basic, Dynapac, MBW, Weber, Bartell, Bennar Newman, Haulotte, Ditch Runner, Menegotti, Morrison, Contec, Buddy, Crown, Edco, Wyco, Bomag, Laymor, EZ Trench, Bil-Jax, F.S. Curtis, Gehl Pavers, Heli, Honda, ICS/PowerGrit, IHI, Partner, Imer, Clipper, MMD, Koshin, Rice, CH&E, General Equipment, Amida, Coleman, NAC, Gradall, Square Shooter, Kent, Stanley, Tamco, Toku, Hatz, Kohler, Robin, Wisconsin, Northrock, Oztec, Toker TK, Rol-Air, APT, Wylie, Ingersoll Rand / Doosan, Innovatech, Con X, Ammann, Mecalac, Makinex, Smith Surface Prep, Small Line, Wanco, Yanmar