

THE
BARRETO

**MODEL 30SG CENTER PIVOT
HYDRAULIC TRACK STUMP GRINDER
OPERATOR'S MANUAL – ORIGINAL INSTRUCTIONS**

STUMP GRINDER INTENDED USE

The Barreto Stump Grinder is designed to remove in-ground tree stumps and exposed roots. It should not be used to cut any material other than wood stumps and the surface soil around the stumps or exposed roots.

TABLE OF CONTENTS

LUBRICATION REQUIREMENTS	2
SAFETY MESSAGES	3
SAFETY INSTRUCTIONS OVERVIEW	4
BATTERY & ELECTRIC STARTER SAFETY INSTRUCTIONS	6
STUMP GRINDER OPERATING INSTRUCTIONS	7
CONTROLS	7
ENGINE CONTROLS	9
ENGINE START UP PROCEDURE	10
KOHLER START UP PROCEDURE	11
BRIGGS/VANGUARD CONTROLS & START UP PROCEDURE	12
OPERATOR PREPARATION	13
NOISE EMISSION DATA	13
VIBRATION EMISSION DATA	14
DETERMINE LOCATION OF UNDERGROUND UTILITIES	15
WORK SITE ASSESSMENT	16
CONTRACT WITH UNDERGROUND UTILITIES	17
GRINDING PROCEDURE	18
GRINDING TIPS	18
SHUT DOWN PROCEDURE	18
JUMP STARTING ENGINE WITH ELECTRIC STARTER	19
GROUND TRANSPORT OF THE GRINDER	20
EMERGENCY TOWING	21
ROAD TRANSPORT OF THE GRINDER	22
INDEX	24



www.discount-equipment.com

PARTS FINDER

**Search Website
by Part Number**



**Search Manual
Library For Parts
Manual & Lookup Part
Numbers – Purchase
or Request Quote**

Search Manuals

Enter your information to help us find the right parts manual for your machine.

* Brand:

* Model:

* Serial:

* Part Number:

SEARCH

**Can't Find Part or
Manual? Request Help
by Manufacturer,
Model & Description**

Parts Order Form

Please fill in the following information to help us find the right part for your machine.

Manufacturer:	<input type="text"/>
Model:	<input type="text"/>
Description:	<input type="text"/>
Part Number:	<input type="text"/>
Quantity:	<input type="text"/>
Notes:	<input type="text"/>

Submit

Discount-Equipment.com is your online resource for quality parts & equipment.

Florida: **561-964-4949** Outside Florida TOLL FREE: **877-690-3101**

Need parts?

Click on this link: <http://www.discount-equipment.com/category/5443-parts/> and choose one of the options to help get the right parts and equipment you are looking for. Please have the machine model and serial number available in order to help us get you the correct parts. If you don't find the part on the website or on one of the online manuals, please fill out the request form and one of our experienced staff members will get back to you with a quote for the right part that your machine needs.

We sell worldwide for the brands: Genie, Terex, JLG, MultiQuip, Mikasa, Essick, Whiteman, Mayco, Toro Stone, Diamond Products, Generac Magnum, Airman, Haulotte, Barreto, Power Blanket, Nifty Lift, Atlas Copco, Chicago Pneumatic, Allmand, Miller Curber, Skyjack, Lull, Skytrak, Tsurumi, Husquvarna Target, Stow, Wacker, Sakai, Mi-T-M, Sullair, Basic, Dynapac, MBW, Weber, Bartell, Bennar Newman, Haulotte, Ditch Runner, Menegotti, Morrison, Contec, Buddy, Crown, Edco, Wyco, Bomag, Laymor, EZ Trench, Bil-Jax, F.S. Curtis, Gehl Pavers, Heli, Honda, ICS/PowerGrit, IHI, Partner, Imer, Clipper, MMD, Koshin, Rice, CH&E, General Equipment, Amida, Coleman, NAC, Gradall, Square Shooter, Kent, Stanley, Tamco, Toku, Hatz, Kohler, Robin, Wisconsin, Northrock, Oztec, Toker TK, Rol-Air, APT, Wylie, Ingersoll Rand / Doosan, Innovatech, Con X, Ammann, Mecalac, Makinex, Smith Surface Prep, Small Line, Wanco, Yanmar

LUBRICATION REQUIREMENTS

Grease at the intervals indicated per the illustration of grease lubrication points. There is also a grease diagram decal on the machine.

GREASE AT INTERVALS INDICATED

1. TRACK REAR IDLERS: WEEKLY, OR 30 HOURS USE.
2. TRACK FRONT IDLERS: WEEKLY, OR 30 HOURS USE.
3. HEAD LIFT PIN: WEEKLY, OR 30 HOURS USE.
4. SWING CYLINDER TRUNION: (2 SIDES) WEEKLY OR 30 HOURS USE.
5. HEAD SWING PIN: WEEKLY OR 30 HOURS USE.
6. LIFT CYLINDER TRUNION: (2 SIDES) WEEKLY OR 30 HOURS USE.
7. LIFT ROD PIN: WEEKLY OR 30 HOURS USE.
8. CUTTER WHEEL BEARINGS: (2 SIDES) DAILY OR 6 HOURS USE.

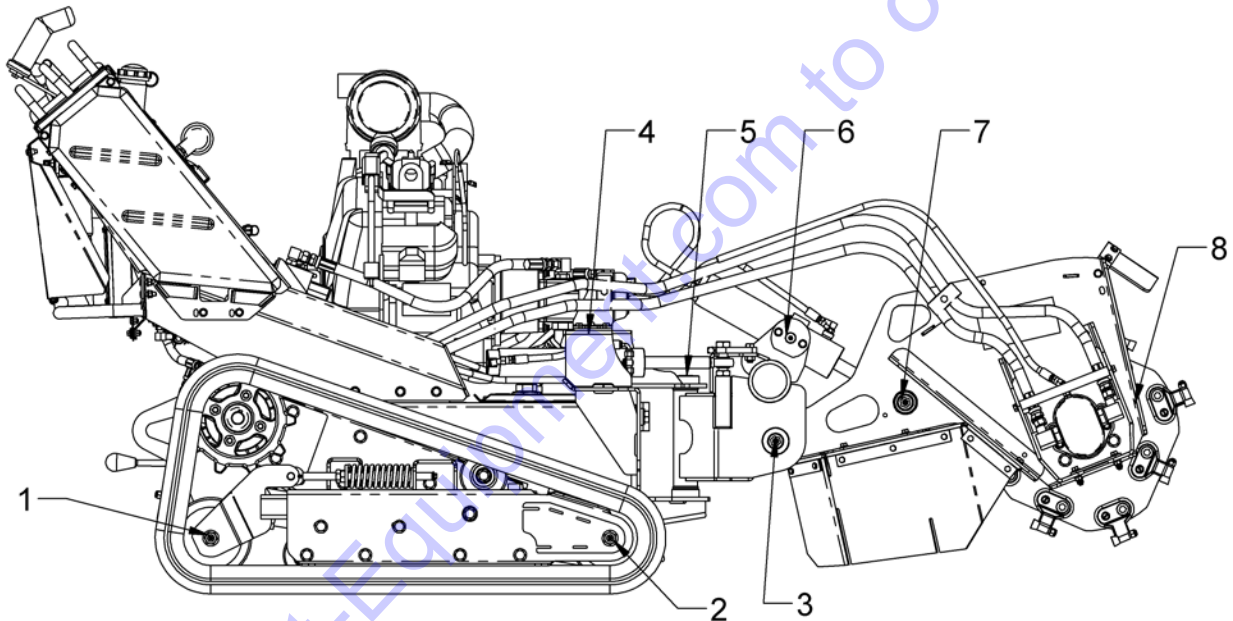

SAFETY MESSAGES

General safety messages are listed in this Safety Messages section. Specific safety messages appear as appropriate in this manual where a potential hazard may occur if procedures or instructions are not followed correctly and completely.

SAFETY SYMBOL



This is the international safety alert symbol. This symbol is used in combination with a signal word and written message to warn you of a potential for bodily injury or death.

A signal word "DANGER", "WARNING", or "CAUTION" is used with the safety alert symbol.



DANGER: Imminent hazards, that if not avoided, will result in serious personal injury or death.



WARNING: Potential hazards or unsafe practices, that if not avoided, could result in serious personal injury or death:



CAUTION: Potential hazards or unsafe practices, that if not avoided, could result in minor personal injury, product damage, or property damage.

Safety decals with a signal word "DANGER", "WARNING", or "CAUTION" are affixed to the stump grinder near specific hazards.

This machine shall always be used in accordance with this manual. Study it and ALL decals on the stump grinder before operating the stump grinder.

ALWAYS make sure the engine is turned off before performing maintenance, cleaning, or transport by means other than under its own power.

Before using, always visually inspect to see that the tools are not worn or damaged. Replace worn or damaged elements and bolts in sets to preserve balance.

Use extreme caution when reversing the machine towards you.

Do not change the engine governor settings or over speed the engine.

SAFETY INSTRUCTIONS OVERVIEW

READ SAFETY AND OPERATING INSTRUCTIONS BEFORE OPERATING!

USE COMMON SENSE AND PLENTY OF IT!

Call before you cut. If you do not call, you may cause an accident; suffer injuries or death; cause interruption of services; damage the environment; and/or incur project delays. Expect to be held liable for any damages caused, if you fail to call.

 **DANGER:** Buried electric cables or gas lines can cause serious injury or death if struck with cutter wheel. Always determine location of utilities before cutting.

 **WARNING:** Fiber optic cables convey laser light that can injure your eyesight.



STAY CLEAR of moving parts on the stump grinder.

 **DANGER:** Cutter wheel and other moving parts can cut off arms, legs, or fingers. Contact with the cutter wheel while in operation will cause serious injury or even death. Stay in the operator's position at the controls when the cutter wheel is operating. Keep all observers and helpers at a safe distance from the machine. Stop the cutter wheel immediately if anyone gets too close to the operating machine.

Wear a face safety shield and hard hat while operating or observing!

 **WARNING:** The cutter wheel may throw chips, rocks and debris into the area around the machine. Keep all bystanders at a safe distance from the machine. Always wear eye protection when operating or observing the machine in operation.



Wear adequate hearing protection while operating or observing.

 **WARNING:** The machine and cutter wheel are loud when in operation. Wear ear protection when operating the machine. Exposure to loud noise is cumulative and may permanently damage your hearing.

Wear safety boots and gloves. Wear close-fitting clothing. Contain long hair. Do not wear jewelry. Wear reflective clothing if working near traffic.

Only operate outdoors and avoid breathing engine exhaust and fumes.

 **WARNING:** Engine exhaust contains carbon monoxide gas that is toxic. Breathing it can cause unconsciousness and death.

Adequate lighting is required, daylight or artificial, for safe operation of the stump grinder. Allow adequate side and overhead clearances between machine and buildings, fences, and trees.

SAFETY INSTRUCTIONS OVERVIEW (continued)



WARNING: Contact with the cutter wheel while in operation will cause serious injury or even death. The teeth of the cutter wheel are sharp. Avoid contact even when the wheel is not moving.

Avoid inclines if at all possible.



WARNING: Navigating on any incline increases the danger of the machine losing traction or rolling over, especially if the surface is wet. If you lose control, get out of the way immediately to avoid personal injury. Navigation on inclines should be especially slow and turns very gradual. Refer to the incline diagram in the section, "GROUND TRANSPORT".

Avoid operating adjacent to drop-offs or embankments.

Keep away from tracks to avoid being crushed.



WARNING: Being run over by the machine will cause injury.

Always leave machine parked on a level surface.



WARNING: Do not park on incline. Move the machine to a level surface and set the parking brake located behind the left hand track motor. Move the handle down to engage the brake.

Do not leave machine unattended with the engine running.

Do not operate machine near any source of flammable dust or vapors.



WARNING: Sparks from the engine exhaust can cause an explosion or fire in a flammable or explosive atmosphere. Fuel fumes can catch fire or explode.

Do not operate machine near flames or sparks.



WARNING: Fuel fumes can catch fire or explode. If fuel is spilled, do not attempt to start engine but move the machine away from the area of spillage and avoid creating any source of ignition until the vapors have dissipated.

Shut off engine and allow it to cool before refueling.



WARNING: Fuel fumes can catch fire or explode. Refuel outdoors and do not smoke when refueling. Do not refuel near a source flames or sparks. Always store fuel in containers specifically designed for this purpose. Add fuel before starting engine. Never remove the cap on the fuel tank or add fuel while the engine is running or when the engine is hot.



WARNING: Replace all fuel tank and container caps securely.

Do not touch the engine, muffler, or any of the hydraulic components until cool.



WARNING: Muffler and engine get hot enough to cause serious burns. For the safety of yourself and others, allow enough time for the engine, muffler, and the hydraulic fluid to cool completely before performing any cleaning or maintenance.



WARNING: Stay clear of the articulation area while the engine is running.

SAFETY INSTRUCTIONS OVERVIEW (continued)

Avoid contact with hydraulic fluid.



WARNING: When machine is operating, hydraulic fluid is under extreme pressure and can get under skin and burn or poison.



WARNING: Keep safety guards and shields in place while the engine is running and keep all operator protection systems in place and in operational condition.



WARNING: Never store the equipment with petrol in the tank inside a building where fumes can reach an open flame or spark. Allow the engine to cool before storing in an enclosure. To reduce fire hazard, keep the engine, muffler, battery compartment and fuel storage area free of any vegetative material and excessive grease.

Keep others away. If the job site is near a road or pedestrian path, warn and divert both motorized traffic and pedestrians. As appropriate, use traffic flag personnel, signs, cones, and lighting devices to insure safety.

Never allow anybody to ride on the machine.

Never lift machine over any person at any time.



WARNING: If machine should fall, it would crush anybody under it.

We recommend having a fire extinguisher suitable for petrol fires in the operating area.

BATTERY & ELECTRIC STARTER SAFETY INSTRUCTIONS

Shield entire face, especially your eyes, and wear rubber gloves to avoid acid burns whenever doing anything with the battery. Battery caps must be tightly in place if the battery has removable caps.



WARNING: The battery contains sulfuric acid that can cause blindness and severe burns. Avoid contact with eyes, skin, and clothing. If acid contacts eyes, call 911 immediately and flush eyes with water for 15 minutes or until emergency medical help arrives. If acid contacts skin, flush area with plenty of water. If acid is ingested, drink large quantities of water or milk then follow with milk of magnesia, beaten egg, or vegetable oil, and get medical attention immediately.

Avoid contact with battery components. Wear rubber gloves and wash hands after handling any battery components.



WARNING: Battery posts, terminals, and related accessories contain lead and lead compounds, chemicals known to cause cancer and reproductive harm. Acid can cause blindness and severe burns if leaked from the battery.

Do not charge or jump-start the battery near flames or sparks, or while smoking.



WARNING: Battery fumes are flammable and explosive. Avoid explosion hazard that could blind and burn. Tools and jumper cable clamps can make sparks, so use them with care. Shield eyes and face, and wear rubber gloves.

BATTERY MAINTENANCE is in the OWNER'S MANUAL.

STUMP GRINDER OPERATING INSTRUCTIONS

READ SAFETY INSTRUCTIONS BEFORE OPERATING! Both the SAFETY INSTRUCTIONS and OPERATING INSTRUCTIONS are in this manual.

Be sure that the engine oil and fuel, and the machine hydraulic fluid are all at proper levels before starting the engine.

STUDY AND UNDERSTAND CONTROLS BEFORE BEGINNING OPERATION.

CONTROLS

1. **KEYED IGNITION SWITCH:** Used to start and stop the engine with an electric starter.

KOHLER: The key switch is located with the grinder controls, to the top right of the control panel.

VANGUARD: The key switch is located on the engine adjacent to the choke and can be seen while standing behind the machine.

Refer to the ENGINE START UP PROCEDURE.

2. **THROTTLE:** Controls engine speed. Operate at full throttle when cutting (all the way forward).

3. **TRACK CONTROL:** Controls the travel direction and speed.

- Track controls are designed to be operated with two hands.
- Pushing the control handles forward from neutral position causes the machine to move forward.
- Pulling the control handles back from neutral position causes the machine to move backward.
- Moving the track control handles farther from the neutral position increases the speed.
- Steer the machine by moving one track control handle farther than the other handle. This causes the track on one side to rotate at a different speed than the opposite track. Pivot turns can be made by moving one control forward and the other control back.

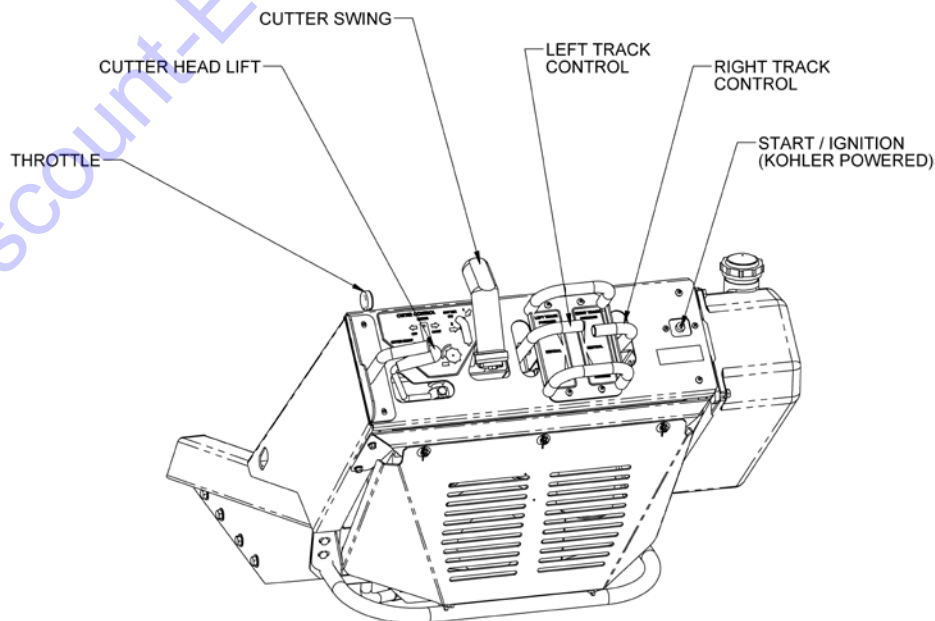

CONTROLS (continued)

4. **CUTTER WHEEL CONTROL:** To start the cutter wheel, hold down the thumb button on the control handle. Then pull the trigger back. After the wheel is started, **the thumb button can be released**, but the trigger must be held to keep the cutter wheel turned on. To raise the cutter head, pull the cutter height control bar back. To lower the cutter head, push the cutter height control bar forward. The cutter head swings to the left and right by moving the control lever left or right.

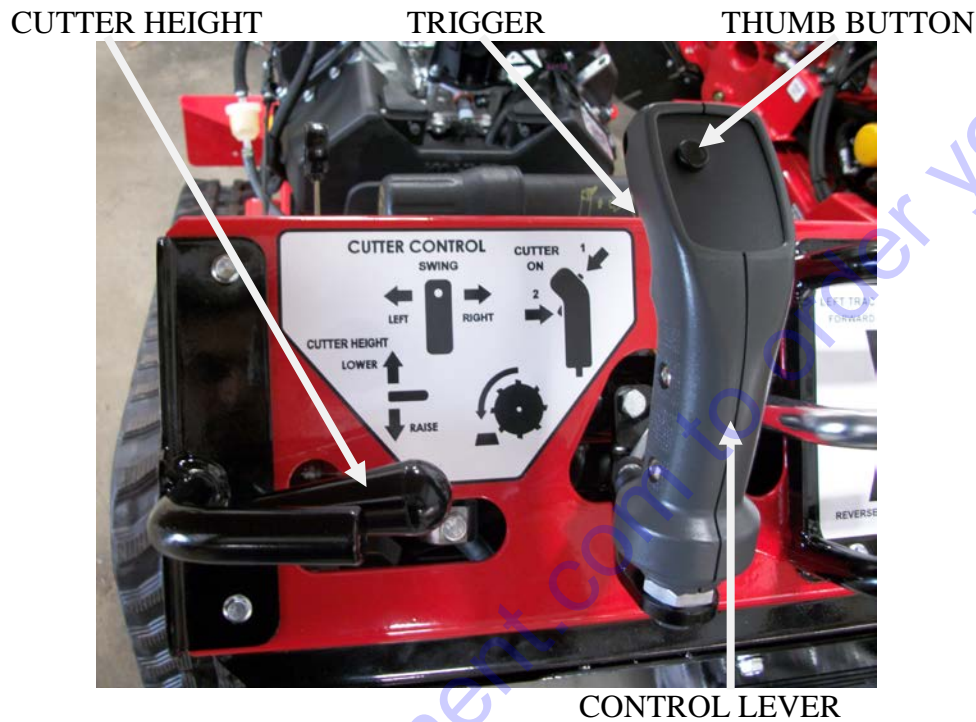

5. **PARKING BRAKE:** It is located behind the left hand track motor. Move the handle down to engage the brake, and up to disengage it.



ENGINE CONTROLS

FUEL SHUTOFF VALVE: Must be in OPEN position for engine to run.

CHOKE: Use while starting the VANGUARD engine, only needed if engine has not reached operating temperature. (Refer to the ENGINE START UP PROCEDURE)

THROTTLE: Controls engine speed. Operate at full throttle when cutting (all the way forward).

KEYED IGNITION SWITCH: Used to start and stop the engine with an electric starter.

KOHLER: The key switch is located with the grinder controls, to the top right of the control panel.

VANGUARD: The key switch is located on the engine adjacent to the choke and can be seen while standing behind the machine.

FUEL SHUTOFF VALVE



VANGUARD CHOKE

VANGUARD KEYED IGNITION SWITCH

KOHLER KEYED IGNITION SWITCH



ENGINE START UP PROCEDURE

Only operate machine outdoors and avoid breathing engine exhaust and fumes.



WARNING: Engine exhaust contains carbon monoxide gas that is toxic. Breathing it can cause unconsciousness and death. Avoid any areas or actions that expose you to carbon monoxide.

Check hydraulic oil level prior to operating the stump grinder. If the oil level is below the sight glass, see the SERVICE INFORMATION SECTION located in the OWNER'S MANUAL.

HYDRAULIC OIL LEVEL



COLD WEATHER OPERATIONS: Before operating in cold weather, refer to the Engine Owner's Manual for recommended engine oil. Do not spray starting fluid into the air cleaner as engine damage could result. If the machine is operated at temperatures below +32°F (0°C) then changing the hydraulic fluid to ISO 46 is recommended. If you do not want to change the hydraulic fluid but want to operate the machine at temperatures below +32°F (0°C), then do the following:

- Warm up engine at a low speed.
 - Gradually increase engine speed, allowing **30 minutes for the hydraulic fluid to warm up.**
- Reduce the engine speed if the hydraulic pump whines. Pump noise may indicate a lack of hydraulic fluid flow that could damage the pump.

For frequent starts below 18°F consult your Barreto Manufacturing, Inc. dealer.

KOHLER START UP PROCEDURE

1. Check the engine oil. Add oil if low. Do not overfill.
2. Check the fuel level. Add fuel if low. Check the fuel system components and lines for leaks.
3. Check and clean the cooling areas, air intake areas and external surfaces of the engine (particularly after storage).
4. Check that the air cleaner components and all shrouds, equipment covers, and guards are in place and securely fastened.
5. Check the spark arrestor (if equipped).
6. Place the throttle control midway between slow and fast positions.
7. Turn the key switch to the START position. Release the switch as soon as engine starts. If the starter does not turn the engine over, shut off the key switch immediately. Do not make further attempts to start engine until condition is corrected. Do not jump start. See your Kohler authorized dealer for trouble analysis.

NOTE: To prime a dry fuel system, turn the key switch to ON position for one minute. Allow fuel pump to cycle and prime system. Turn the key switch OFF.

NOTE: Do not crank the engine continuously for more than 10 seconds. Allow a 60 second cool down period between starting attempts. Failure to follow these guidelines can burn out the starter motor.

NOTE: Upon start-up, a metallic ticking may occur. Run the engine for 5 minutes. If noise continues, run the engine at mid throttle for 20 minutes. If noise persists, take the engine to your local Kohler authorized dealer.

Only operate the stump grinder outdoors and avoid breathing engine exhaust and fumes.



WARNING: Engine exhaust contains carbon monoxide gas that is toxic. Breathing it can cause unconsciousness and death. Avoid any areas or actions that expose you to carbon monoxide.

BRIGGS/VANGUARD CONTROLS & START UP PROCEDURE

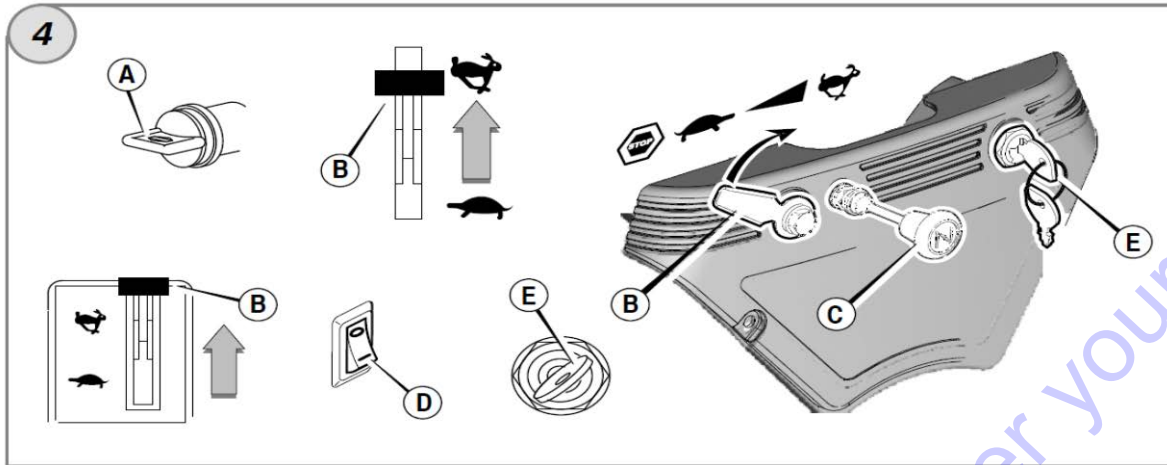

STARTING THE ENGINE

Note: Some engines and equipment have remote controls. See the equipment manual for location and operation of remote controls.

1. Check the engine oil level. See the How To Check/Add Oil section in the engine owner's manual.
2. Make sure equipment drive controls, if equipped, are disengaged.
3. Turn the fuel shut-off valve (A), if equipped, to the on position (Figure 4).
4. Move the throttle control (B) to the fast position. Operate the engine in the fast position.
5. Pull out the choke control (C), if equipped, to the choke position.

Note: To start the engine with a dry fuel system (first time starting or after running out of fuel), additional cranking time in the choke position will be required. This will give the fuel pump time to prime the fuel system.

6. Push the stop switch (D), if equipped, to the on position.
7. Turn the electric start switch (E) to the on/start position (Figure 4).
8. If the engine fires but will not continue to run, move the choke control (C) to the run position to start the engine.

NOTICE: To extend the life of the starter, use short starting cycles (five seconds maximum). Wait one minute between starting cycles. **Note:** If the engine does not start after repeated attempts, go to VanguardEngines.com or call 1-800-999-9333 (in USA).

9. As the engine warms up, move the choke control (C) to the run position.

Only operate the stump grinder outdoors and avoid breathing engine exhaust and fumes.



WARNING: Engine exhaust contains carbon monoxide gas that is toxic. Breathing it can cause unconsciousness and death. Avoid any areas or actions that expose you to carbon monoxide.

OPERATOR PREPARATION

Each operator must:

- Become familiar with the controls and operation of the stump grinder, preferably under the supervision of an experienced operator.
- Be at least 18 yrs. of age and be mentally and physically capable of operating the stump grinder safely.
- Have studied the SAFETY AND OPERATING INSTRUCTIONS in this manual.

PERSONAL PROTECTION: For safety, stump grinder operator should wear personal protection equipment. Keep observers at a safe distance and do not operate if people are near, especially children and pets.

Wear a face safety shield and hard hat while operating or observing!

 **WARNING:** The cutter wheel may throw wood chips, stones and debris.

Wear safety boots and gloves. Wear close-fitting clothing. Contain long hair. Do not wear jewelry. Wear reflective clothing if working near traffic.

Wearing adequate hearing (ear) protection while operating or observing is recommended.

 **WARNING:** Exposure to loud noise is cumulative

Hearing protection devices do not all provide the same level of protection. Those that completely surround each ear are better than earplugs. It is important to select a device that is adequate and appropriate for your specific work environment since the peak noise level varies. A local environmental noise specialist may help you to determine the level of hearing protection required.



NOISE EMISSION DATA

Machinery Directive declaration

DECLARED DUAL-NUMBER NOISE EMISSION VALUES in accordance with ISO 4871	
	Normal Operation
Measured A-weighted sound power level, L_{WA} (ref. 1pW) in decibels	104
Uncertainty, K_{WA} , in decibels	3
Measured A-weighted sound pressure level, L_{pA} (ref. 20μPa) at the operator's position in decibels	85
Uncertainty, K_{pA} , in decibels	4
Values determined according to noise test code given in BS EN ISO 4254-1 Annex B using the basic standard ISO 3744: 1994	
NOTE 1 - The sum of a measured noise emission value and its associated uncertainty represents an upper boundary of the range of values, which is likely to occur in measurements.	
Values listed above are rounded to the nearest decibel according to ISO 4871	

Noise Emissions Directive result.

Guaranteed sound power level	107 dB
-------------------------------------	---------------

NOTE - The guaranteed sound power level is calculated from unrounded values, and may differ from the values above

VIBRATION EMISSION DATA

Declared vibration emission value in accordance with EN 12096: the average measured vibration emission value is 2.0 m/s². The uncertainty in the measurement is 2.4 m/s². Safety gloves help to isolate the hands from the vibration, keep them warm and dry, maintain blood circulation, and make operators less susceptible to vibration induced injury.

The Barreto Stump Grinder, Model E30SG when operated in accordance with its instructions, and tested in accordance with EN 1033:1995, results in the following vibration emission declared in accordance with EN 12096:1996.

Average measured vibration emission value	a_{hv}	2.0 m/s²
Uncertainty	K	2.4 m/s²

These values are suitable for comparison with the vibration emission levels of other tools that have been obtained using the same test method.

Note: these figures represent the average value over 5 tests, with the figures in the x, y, and z axes

combined in a vector sum ($a_{hv} = \sqrt{a_{hvx}^2 + a_{hvy}^2 + a_{hvw}^2}$). It is this sum that is averaged over all tests.

Since the value stated above is an average of several tests, and is based on data from all three axes, we consider it to be a reasonable approximation of the true value, particularly considering the uncertainty in the results (K).

This machine is unlikely to cause hand-arm vibration syndrome, as the average emission level is equal to or less than 2.5 m/s²

DETERMINE LOCATION OF UNDERGROUND UTILITIES

OSHA CFR 29 1926.651 requires that the estimated location of underground utilities be determined before beginning excavation or an underground drilling operation. When the actual excavation or bore approaches an estimated utility location, the exact location of the underground installation must be determined by a safe, acceptable and dependable method. If any utility cannot be precisely located, the appropriate utility company must shut it off.

Call before you cut. If you do not call, you may cause an accident; suffer injuries or death; cause interruption of services; damage the environment; and/or incur project delays. Expect to be held liable for any damages caused, if you fail to call.



DANGER: Buried electric cables or gas lines can cause serious injury or death if struck with cutter wheel. Always determine location of utilities before operating the machine.



WARNING: Fiber optic cables convey laser light that can injure your eyesight.

To locate utilities before beginning your grinding project, call 811 or 1-888-258-0808 (US. or Canada). This free service will provide a “One-Call” number for the geographic area that you select. Before you start any cutting project, be sure to call the local One-Call system in your area and any utility company that does not subscribe to the One-Call system. The One-Call representative will notify participating utility companies of your proposed cutting activities. Utilities will then mark their underground facilities by using the following international marking codes:

Red	Electric
Yellow	Gas, oil, or petroleum
Orange	Communication, telephone, television
Blue	Potable water
Green/brown	Sewer
White	Proposed excavation
Pink	Surveying

For areas not represented by One-Call Systems International, contact the appropriate utility companies to locate and mark the underground installations. Do not rely on visual evidence of underground utilities such as manhole covers or electrical drop boxes...**CALL!**



**Know what's below.
Call before you dig.**

WORK SITE ASSESSMENT

Examine the work area for any conditions or obstructions that may inhibit cutting or create a safety hazard for the operator or others. Use the information in this manual combined with good judgment to identify any hazards to avoid.

In addition to calling to DETERMINE LOCATION OF UNDERGROUND UTILITIES (see previous section for details) the operator and/or job foreman should visually inspect the work site. Look for electrical drop boxes; notices of underground placements; manhole covers; recent cutting activity; any evidence of possible underground placements; banks; overhangs; drop-offs; rocks; tree limbs; wire; uneven terrain; any existing trenches or holes; and toxic ground conditions.

Only operate stump grinder outdoors and avoid breathing engine exhaust and fumes.



WARNING: Engine exhaust contains carbon monoxide gas that is toxic. Breathing it can cause unconsciousness and death.

Do not operate stump grinder near any source of flammable dust or vapors.



WARNING: Sparks from the engine exhaust can cause an explosion or fire in a flammable or explosive atmosphere. Fuel fumes can catch fire or explode.

Allow adequate side and overhead clearances between stump grinder and any objects such as buildings, fences, and trees.

Adequate lighting is required, daylight or artificial, for safe operation of the stump grinder.

Keep others away. If the job site is near a road or pedestrian path, warn and divert both motorized traffic and pedestrians. As appropriate, erect barriers, use traffic flag personnel, signs, cones, and lighting devices to insure safety.

CONTACT WITH UNDERGROUND UTILITIES

After LOCATING UNDERGROUND UTILITIES and performing the WORK SITE ASSESSMENT, accidental contact with a buried utility might still occur. If it does, stop and call 911 for help.

If you cut a wire or cable, assume that you do not know what kind it is. It may be electrical or any one of several communication lines: telephone, television, or fiber optic. In any case, do not touch it or even look at the ends of it. Stop cutting and call 911 for help. Do not cut any more until the appropriate utility company has assessed the situation, taken appropriate action, and informed you that it is safe to proceed.

If you strike a pipe, it could be gas, oil, petroleum, water, or sewer. In any case, stop cutting, shut off the engine, and evacuate the area immediately. Call 911 for help.

Electrical wires or cables: If you think that you may have severed electrical wires, stop cutting and call 911 for help. Keep yourself and other people away from the area.



DANGER: An electric shock could kill you. Assume that any severed wire or cable is HOT with voltage and do not touch it!

Gas lines: If you think that you may have struck a gas line, shut off the engine and evacuate the area immediately. Call 911 for help.



DANGER: A gas explosion could kill you. Sparks will likely occur from the cutter head scraping the metal pipe. If gas leaks out an explosion could easily occur.

Fiber optic cables: If you think that you may have severed a fiber optic cable, do not touch or even look at the ends of it.



WARNING: Fiber optic cables convey laser light that can injure your eyesight. Call 911 for help.

STUMP GRINDING PROCEDURE

1. Raise the cutter head and move the machine into position to cut. Position the machine so the cut head can swing across near the edge of the stump.
2. Have engine at full throttle (throttle lever forward).
3. Start cutter wheel.
4. Using the cutter head control lever, slowly swing the cutter wheel across the edge of the stump. Adjust cut depth and swing speed to prevent the engine from bogging and to prevent cutter wheel stall.
5. After the swing is complete, move the cutter wheel down a few inches, and repeat the cutter wheel swing.
6. Continue making a series of cuts down the edge of the stump until the edge is cut to below ground level or the teeth are cutting at a depth below half the wheel radius.
7. Depending on the diameter of the stump it may be necessary to move the stump grinder. After cutting the first edge move the machine forward and repeat the grinding procedure until the stump is completely cut to below ground level.

GRINDING TIPS

Clear the work area of debris, branches and rocks.

Operate the cutter with engine at full throttle.

Listen to engine speed and watch cutter wheel speed. Adjust swing speed and cut depth to maintain high engine and cutter speed. Avoid bogging the engine and stalling cutter wheel.

It is more efficient to cut the edge of the stump, rather than cutting a wide area. Once the teeth are cutting at a depth below half the wheel radius, lift the cutter and move the machine forward to begin cutting a new edge.

SHUT DOWN PROCEDURE

1. Always leave machine parked on a level surface.

 **WARNING:** Do not park on incline. Move the machine to a level surface and set the parking brake located behind the left hand track motor, near decal shown. Move the handle down to engage the brake.

2. Unless loaded on a trailer, lower the cutter head to the ground.
3. Reduce the ENGINE THROTTLE to idle.
4. Move the IGNITION KEYED SWITCH to the OFF position to stop the engine, and remove the key.
5. Close the FUEL SHUTOFF VALVE.

Shut off engine and allow it to cool before refueling.

 **WARNING:** Fuel fumes can catch fire or explode. Do not smoke or allow flames or sparks in the area.

Do not touch the engine, muffler, or any of the hydraulic components until cool.

 **WARNING:** Muffler and engine get hot enough to cause serious burns. For the safety of yourself and others, allow enough time for the engine, muffler, and the hydraulic fluid to cool completely before performing any cleaning or maintenance.



JUMP STARTING ENGINE WITH ELECTRIC STARTER

Shield entire face, especially your eyes, and wear rubber gloves to avoid acid burns whenever doing anything with the battery. Battery caps must be tightly in place if the battery has removable caps.

 **WARNING:** The battery contains sulfuric acid that can cause blindness and severe burns. Avoid contact with eyes, skin, and clothing. If acid contacts eyes, call 911 immediately and flush eyes with water for 15 minutes or until emergency medical help arrives. If acid contacts skin, flush area with plenty of water. If acid is ingested, drink large quantities of water or milk then follow with milk of magnesia, beaten egg, or vegetable oil, and get medical attention immediately.

Avoid contact with battery components. Wear rubber gloves and wash hands after handling any battery components.

 **WARNING:** Battery posts, terminals, and related accessories contain lead and lead compounds, chemicals known to cause cancer and reproductive harm. Acid can cause blindness and severe burns if leaked from the battery.

Do not jump start the battery near flames or sparks, or while smoking.

 **WARNING:** Battery fumes are flammable and explosive. Avoid explosion hazard that could blind and burn. Tools and jumper cable clamps can make sparks, so use them with care. Shield eyes and face, and wear rubber gloves.

Do not jump-start or charge a battery that is frozen or low on electrolyte.

IMPORTANT: Use only a 12-volt system for jump-starting. Never allow the vehicle used to jump-start to contact the disabled machine. If the vehicles contact, a spark may occur when the positive jumper cable is connected or disconnected. If equipped with battery caps, they must be in place and tight to reduce risk of battery explosion.

DO NOT JUMP START KOHLER ENGINES, SEE YOUR KOHLER AUTHORIZED DEALER FOR TROUBLE ANALYSIS.

JUMP STARTING PROCEDURE:

1. Turn ignition switch to OFF.
2. Connect jumper cables in the following order:
 - a) Clamp one RED cable end to the discharged battery POSITIVE (+) terminal.
 - b) Clamp the other end of the RED cable to the booster battery POSITIVE (+) terminal.
 - c) Clamp one BLACK cable end to the booster battery NEGATIVE (-) terminal.
 - d) Clamp the other end of the BLACK cable to the frame of machine with the discharged battery, away from battery.
3. Start the engine.
4. Disconnect the cables in reverse order of connection and cover each jumper cable terminal. To avoid sparks near the battery, never disconnect the red jumper cable without first disconnecting the black jumper cable.

GROUND TRANSPORT OF THE STUMP GRINDER

Raise the cutter head.



WARNING: Contact with the cutter wheel while in operation will cause serious injury or even death. The teeth of the cutter are sharp. Avoid contact even when the cutter is not moving.

TRACK CONTROL: Controls the travel direction and speed.

- Track controls are designed to be operated with two hands.
- Pushing the control handles forward from neutral position causes the machine to move forward.
- Pulling the control handles back from neutral position causes the machine to move backward.
- Moving the track control handles farther from the neutral position increases the speed.
- Steer the machine by moving one track control handle farther than the other handle. This causes the track on one side to rotate at a different speed than the opposite track. Pivot turns can be made by moving one control forward and the other control back.

Keep away from tracks to avoid being crushed.



WARNING: Being run over by the stump grinder will cause injury.

Never allow anybody to ride on the machine.

Never make sudden changes in speed or direction.

Use extra caution on soft or uneven ground.

Avoid operating adjacent to drop-offs or embankments.

Avoid inclines if at all possible. Never use on any incline exceeding the angles shown below.



WARNING: Navigating on any incline increases the danger of the machine losing traction or rolling over, especially if the surface is wet. If you lose control get out of the way immediately to avoid personal injury. Navigation on inclines should be especially slow and turns very gradual.

A 20° maximum incline is allowed.

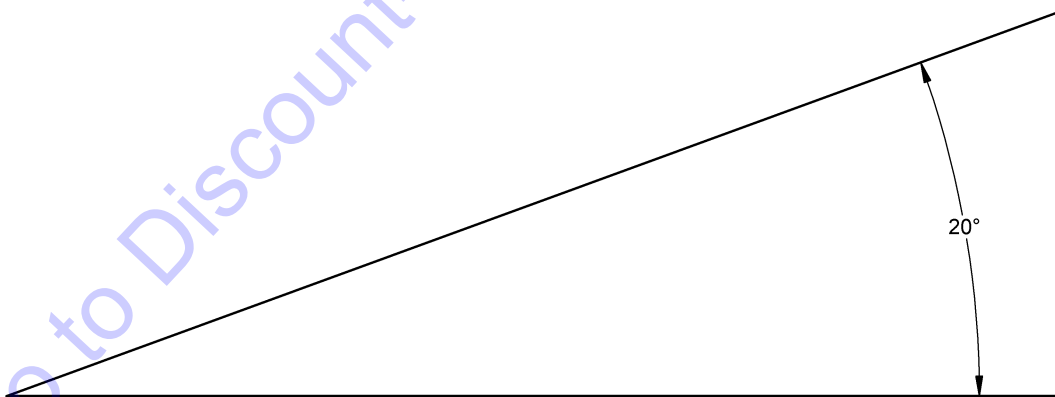

EMERGENCY TOWING

In case of engine failure there is a provision that allows the machine to be towed a short distance.

The drive tracks are driven by a set of tandem pumps. The front pump drives right track, and the other pump drives left track. The drive pump by-pass valves located on the side of the pump may be opened to allow the machine to be towed.

- Set the parking brake if on a slope to prevent rolling. It is located behind the left hand track motor. Move the handle down to engage the brake.

 **WARNING:** Navigating on any slope increases the danger of the machine losing traction or rolling over, especially if the surface is wet. Stay out of the way to avoid personal injury.

- Loosen (**do not remove**) the by-pass plugs two complete turns counterclockwise, see bottom drawing.
- Loosen both cartridges in the counter balance valve on each track drive motor, see below.

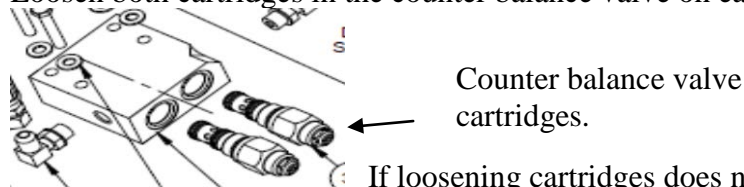

- If loosening cartridges does not work, disconnect hydraulic hoses to motor.
- Disengage the parking brake by moving the handle up.
- The machine may be towed short distance (1/8 mile or 1/4km) at slow speed, 2 mph or 200 feet per minute maximum (3kph or 60m per min).
- After towing, close both by-pass valves by closing the plugs with 10 foot-pounds torque.
- Use a trailer or truck for road transport.

If you need to raise the cutter head without power, do the following:

1. Use straps or chains to support the cutter head.
2. Loosen the hose at the back port of the lift cylinder and raise the cutter head end with a hoist or forklift if available.
3. If it still will not lift, then also loosen the hose at the front port of the lift cylinder.

 **WARNING:** The cutter head is heavy. Manpower alone is not recommended, but if necessary, use a team of two strong workers to raise the head, and a third worker to tighten the hose(s) after the head is up.

4. Secure the head in the up position with a strap or chain on the cut head housing.

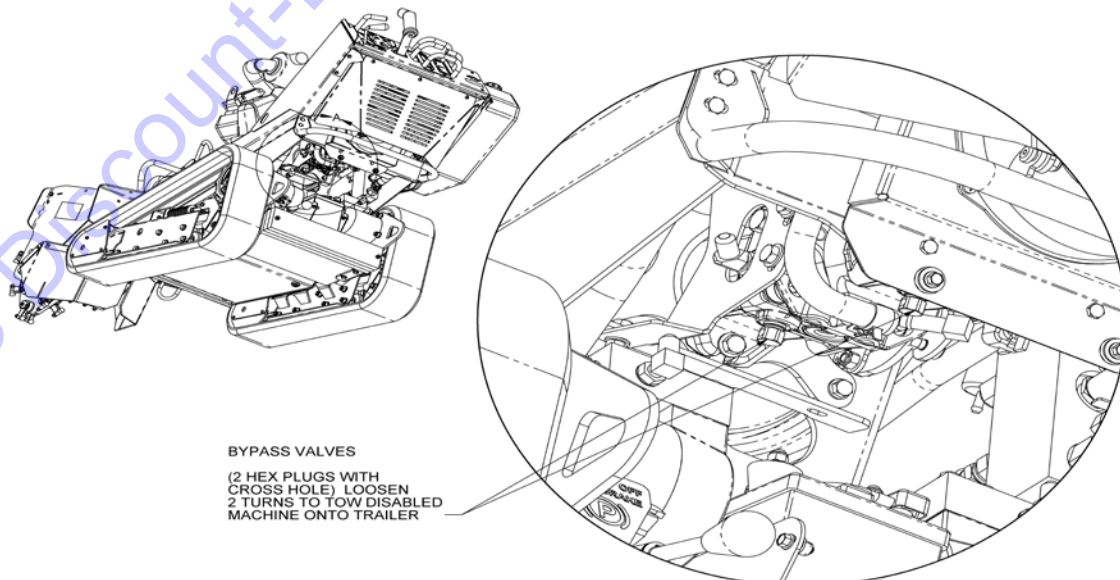

ROAD TRANSPORT OF THE STUMP GRINDER

The BEST way to transport the stump grinder over roads is with the **BARRETO E4X6 TILT BED TRAILER**.

Refer to the following checklist before towing:

- Towing vehicle should have a 2" (5cm) ball. Be sure it is in good repair and securely fastened to the vehicle.
- Securely fasten the hitch to the ball by tightening the hitch nut.
- Cross the chains under the trailer tongue to prevent the tongue from dropping to the ground if the trailer comes loose.
- Allow only enough slack in the chains to permit proper turning of the vehicle. Do not let the chains drag on the ground or be drawn up too tight. Slack strength should hold the tongue and coupler off the ground with the trailer loose.
- Attach the safety chain to the towing vehicle in such a way that it cannot come off accidentally.
- Check the hitch-to-ball connection after driving a few blocks and re-tighten if necessary.

Always exercise extreme caution and allow extra clearance while towing a trailer. **DRIVE SAFELY!**

LOADING PROCEDURE of the stump grinder onto the **Barreto E4X6 tilt bed trailer**:

1. Position the tow vehicle and attached trailer on level ground.
2. Unlatch the trailer tilt bed latch pin to tip up the trailer bed. Leave the latch pin where the spring-loaded action will engage the pin with the latch when the bed is leveled again.
3. Line up the stump grinder with the rear of the trailer. The cut head should be toward the trailer.
4. Drive the stump grinder slowly forward onto the trailer bed. As the weight of the stump grinder reaches the balance point the bed will level itself.

 **WARNING:** Navigating on the inclined trailer bed increases the danger of the tracks losing traction, especially if the bed surface is wet. Stay out of the way to avoid personal injury if you lose control.

5. The chains of the 00340 TIE-DOWN KIT are long enough to adjust for desired trailer tongue weight.
6. Loop front chain through D-ring on front of stump grinder and into keyhole slot in mount.
7. Back up stump grinder until front chain is tight.
8. Throttle down and shut off the engine, then close the fuel shutoff valve. Refer to the SHUT DOWN PROCEDURE for details.
9. Loop rear chain through chain loops on rear of stump grinder and D-rings on trailer.
10. Hook to ratchet load binder and tighten.



The quick link is provided to prevent losing the chain when not in use. Attach it between chain links next to one of the trailer D-rings. Never apply the tie-down load to it.

Check that the trailer tilt bed latch pin is engaged with the latch.

UNLOADING PROCEDURE of the stump grinder from the **Barreto E4X6 tilt bed trailer**:

1. Position the tow vehicle and attached trailer on level ground.
2. Remove all chains or straps connecting the stump grinder to the trailer D-rings
3. Start the engine using the ENGINE START UP PROCEDURE.
4. Unlatch the trailer tilt bed latch pin and rotate the latch pin handle to lock it open.
5. Drive the stump grinder slowly backward. As the weight of the stump grinder reaches the balance point the trailer bed will tilt up. Continue backward until tracks are completely on the ground.

ROAD TRANSPORT OF THE STUMP GRINDER (continued)

 **WARNING:** Navigating on the inclined trailer bed increases the danger of the tracks losing traction, especially if the bed surface is wet. If you lose control, get out of the way to avoid personal injury.

Move the trailer tilt bed latch pin handle so that the spring-loaded action will engage the pin with the latch when the bed is leveled.

LOADING PROCEDURE of the stump grinder onto a truck bed using ramps:

1. Position the truck and stump grinder on level ground.
2. Set up suitable ramps, insuring that they are **secure to the back of the truck bed**.
3. Line up the stump grinder with the ramps with the cutter head pointing away from the back of the truck.
Drive the stump grinder slowly backward up the ramps onto the truck bed.

 **WARNING:** Navigating on the ramps increases the danger of the stump grinder tracks losing traction, especially if the surface is wet. Stay out of the way to avoid personal injury if you lose control.

4. Throttle down and shut off the engine, then close the fuel shutoff valve. Refer to the SHUT DOWN PROCEDURE for details.
5. Chain or strap the stump grinder to the truck using the two chain loops at the rear of the stump grinder lower body and D-ring on front of stump grinder.

UNLOADING PROCEDURE of the stump grinder from a truck bed using ramps:

1. Position the truck on level ground.
2. Set up suitable ramps, insuring that they are **secure to the back of the truck bed**.
3. Remove all chains or straps connecting the stump grinder to the truck.
4. Start the engine using the ENGINE START UP PROCEDURE.
5. Drive the stump grinder slowly down the ramps onto the ground.

 **WARNING:** Navigating on the ramps increases the danger of the stump grinder tracks losing traction, especially if the surface is wet. Stay out of the way to avoid personal injury if you lose control.

LOADING PROCEDURE of the stump grinder onto a truck bed using a hoist:

Never attempt to hoist the stump grinder unless suitable equipment is available to lift and lower machine onto the truck. If using a sling, the minimum required working load limit per sling leg is 1000 lb (450 kg). Minimum sling leg length is 6 ft (2 m).

1. Position the truck and stump grinder on level ground.
2. Follow the stump grinder SHUT DOWN PROCEDURE.
3. Attach lifting sling legs around both rear tie down loops and around the chain motor housing. Ensure machine weight is evenly distributed, then hoist onto the truck bed.

Never lift stump grinder over any person at any time.

 **WARNING:** If stump grinder should fall it would crush anybody under it.

4. Chain or strap the stump grinder to the truck using the two chain loops at the rear of the stump grinder lower body and D-ring on front of the stump grinder.



INDEX

BATTERY, 1, 6, 19
CHOKE, 9, 10
COLD WEATHER OPERATIONS, 10
CONTACT WITH UNDERGROUND UTILITIES, 17
CONTROLS, 1, 7, 8, 12
EMERGENCY TOWING, 1, 21
ENGINE, 3, 4, 5, 6, 7, 9, 10, 11, 12, 16, 17, 18, 19, 21, 22, 23
ENGINE CONTROLS, 1, 9
FUEL SHUTOFF VALVE, 9, 10, 18
GREASE, 2, 6
GRINDING, 1, 18
GROUND TRANSPORT, 1, 5, 20
HYDRAULIC FLUID, 5, 6, 7, 10, 18
IGNITION SWITCH, 7, 9
JUMP STARTING, 1, 19
LOADING PROCEDURE, 22, 23
LUBRICATION, 1, 2
MAINTENANCE, 3, 5, 18
NOISE EMISSION, 1, 13
OPERATING INSTRUCTIONS, 1, 4, 7, 13
PARKING BRAKE, 5, 8, 18, 21
PERSONAL PROTECTION, 13
PROTECTION, 4, 6, 13
ROAD TRANSPORT OF THE STUMP GRINDER, 22, 23
SAFETY INSTRUCTIONS, 1, 4, 5, 6, 7
SAFETY MESSAGES, 3
SHUT DOWN PROCEDURE, 1, 18, 22, 23
START UP PROCEDURE, 1, 7, 9, 10, 11, 12, 22, 23
STUMP GRINDER INTENDED USE, 1
THROTTLE, 7, 9, 10, 11, 12, 18
TRACK CONTROL, 7, 20
TRANSPORT, 3, 21, 22
UNDERGROUND UTILITIES, 1, 15, 16, 17
UNLOADING PROCEDURE, 22, 23
VIBRATION, 1, 14
WORK SITE ASSESSMENT, 1, 16, 17

TO PURCHASE THIS PRODUCT PLEASE CONTACT US



**Equipment Financing and
Extended Warranties Available**



**Discount-Equipment.com is your online resource for
commercial and industrial quality parts and equipment sales.**

561-964-4949

visit us on line @ www.discount-equipment.com

Select an option below to find your Equipment

Search by Manufacturer

Search by Product Type

Request a Quote

We sell worldwide for the brands: Genie, Terex, JLG, MultiQuip, Mikasa, Essick, Whiteman, Mayco, Toro Stone, Diamond Products, Generac Magnum, Airman, Haulotte, Barreto, Power Blanket, Nifty Lift, Atlas Copco, Chicago Pneumatic, Allmand, Miller Curber, Skyjack, Lull, Skytrak, Tsurumi, Husquvarna Target, Stow, Wacker, Sakai, Mi-T-M, Sullair, Basic, Dynapac, MBW, Weber, Bartell, Bennar Newman, Haulotte, Ditch Runner, Menegotti, Morrison, Contec, Buddy, Crown, Edco, Wyco, Bomag, Laymor, EZ Trench, Bil-Jax, F.S. Curtis, Gehl Pavers, Heli, Honda, ICS/PowerGrit, IHI, Partner, Imer, Clipper, MMD, Koshin, Rice, CH&E, General Equipment, Amida, Coleman, NAC, Gradall, Square Shooter, Kent, Stanley, Tamco, Toku, Hatz, Kohler, Robin, Wisconsin, Northrock, Oztec, Toker TK, Rol-Air, APT, Wylie, Ingersoll Rand / Doosan, Innovatech, Con X, Ammann, Mecalac, Makinex, Smith Surface Prep, Small Line, Wanco, Yanmar