

BARRETO

MODEL 912RM/912HM

HYDRAULIC TRENCHER OPERATOR'S MANUAL

TRENCHER INTENDED USE

This machine is designed for digging trenches in "normal" ground of reasonably soft dirt and stones up to 6" (15cm) in diameter. Ground with larger stones, high clay content, very hard packed, very dry, or in a frozen condition may be unsuitable for normal trenching. Consider using a backhoe or other heavier equipment for such conditions.

TABLE OF CONTENTS

LUBRICATION REQUIREMENTS	2
SAFETY MESSAGES	3
SAFETY INSTRUCTIONS OVERVIEW	4
OPERATING INSTRUCTIONS	6
TRENCHING TIPS	7
OPERATOR PREPARATION	8
SHUT DOWN PROCEDURE	8
GROUND TRANSPORT OF THE TRENCHER	9
LOCATING UNDERGROUND UTILITIES	10
WORKSITE ASSESSMENT	11
CONTACT WITH UNDERGROUND UTILITIES	12

PARTS FINDER

**Search Website
by Part Number**



**Search Manual
Library For Parts
Manual & Lookup Part
Numbers – Purchase
or Request Quote**

Search Manuals

Enter your information to help us find the right parts manual for your machine.

* Brand:

* Model:

* Serial:

* Part Number:

SEARCH

**Can't Find Part or
Manual? Request Help
by Manufacturer,
Model & Description**

Parts Order Form

Please fill in the following information to help us find the right part for your machine.

Manufacturer:	<input type="text"/>
Model:	<input type="text"/>
Description:	<input type="text"/>
Part Number:	<input type="text"/>
Quantity:	<input type="text"/>
Notes:	<input type="text"/>

Submit

Discount-Equipment.com is your online resource for quality parts & equipment.

Florida: **561-964-4949** Outside Florida TOLL FREE: **877-690-3101**

Need parts?

Click on this link: <http://www.discount-equipment.com/category/5443-parts/> and choose one of the options to help get the right parts and equipment you are looking for. Please have the machine model and serial number available in order to help us get you the correct parts. If you don't find the part on the website or on one of the online manuals, please fill out the request form and one of our experienced staff members will get back to you with a quote for the right part that your machine needs.

We sell worldwide for the brands: Genie, Terex, JLG, MultiQuip, Mikasa, Essick, Whiteman, Mayco, Toro Stone, Diamond Products, Generac Magnum, Airman, Haulotte, Barreto, Power Blanket, Nifty Lift, Atlas Copco, Chicago Pneumatic, Allmand, Miller Curber, Skyjack, Lull, Skytrak, Tsurumi, Husquvarna Target, Stow, Wacker, Sakai, Mi-T-M, Sullair, Basic, Dynapac, MBW, Weber, Bartell, Bennar Newman, Haulotte, Ditch Runner, Menegotti, Morrison, Contec, Buddy, Crown, Edco, Wyco, Bomag, Laymor, EZ Trench, Bil-Jax, F.S. Curtis, Gehl Pavers, Heli, Honda, ICS/PowerGrit, IHI, Partner, Imer, Clipper, MMD, Koshin, Rice, CH&E, General Equipment, Amida, Coleman, NAC, Gradall, Square Shooter, Kent, Stanley, Tamco, Toku, Hatz, Kohler, Robin, Wisconsin, Northrock, Oztec, Toker TK, Rol-Air, APT, Wylie, Ingersoll Rand / Doosan, Innovatech, Con X, Ammann, Mecalac, Makinex, Smith Surface Prep, Small Line, Wanco, Yanmar

DAILY LUBRICATION REQUIREMENTS

Be sure to grease all lubrication points as outlined below.

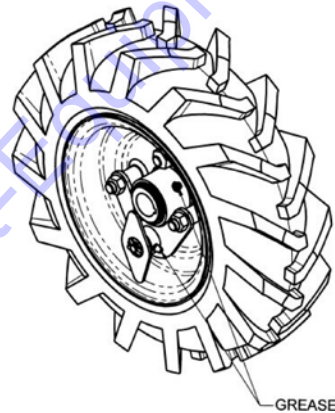
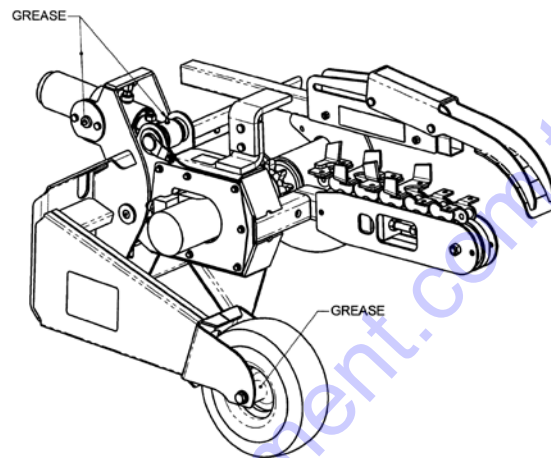
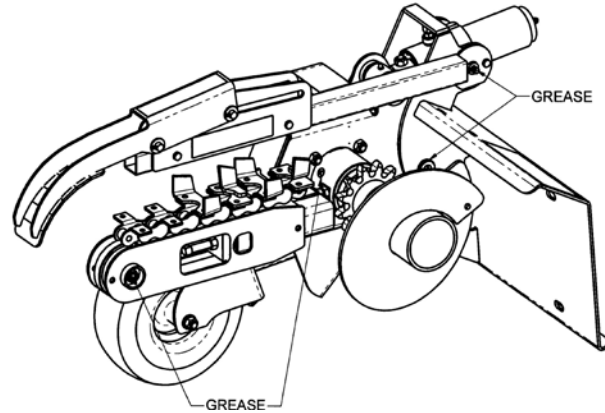

- The grease zerk on chain shaft housing should be greased after every 4 to 8 hours of use.
- The grease zerk in the front wheel should be greased after every 8 hours of use.
- Grease zerks on cylinder rod end and boom pivot should be greased daily.
- Grease zerks on each side of the boom cylinder and on front wheel hub should be greased once a week.
- Grease zerks on the wheel hubs and hub lock screws should be greased and freewheeled once a week or so, depending upon free wheel use.

SAFETY MESSAGES

General safety messages are listed in this Safety Messages section. Specific safety messages appear as appropriate in this manual where a potential hazard may occur if procedures or instructions are not followed correctly and completely.

SAFETY SYMBOL



This is the international safety alert symbol. This symbol is used in combination with a signal word and written message to warn you of a potential for bodily injury or death.

A signal word "DANGER", "WARNING", or "CAUTION" is used with the safety alert symbol.



DANGER: Imminent hazards, that if not avoided, will result in serious personal injury or death.



WARNING: Potential hazards or unsafe practices, that if not avoided, could result in serious personal injury or death.



CAUTION: Potential hazards or unsafe practices, that if not avoided, could result in minor personal injury, product damage, or property damage.

Safety decals with a signal word "DANGER", "WARNING", or "CAUTION" are affixed to the trencher near specific hazards.

Read this manual and study ALL decals on the trencher before operating the trencher.

SAFETY INSTRUCTIONS OVERVIEW

READ SAFETY AND OPERATING INSTRUCTIONS BEFORE OPERATING!

USE COMMON SENSE AND PLENTY OF IT!

The CLUTCH LEVER on the left handlebar is for the operator's protection. All motion stops when the lever is released.

DO NOT TAPE THE CLUTCH LEVER UP or otherwise by-pass this safety feature!

Call before you dig. If you do not call, you may cause an accident; suffer injuries or death; cause interruption of services; damage the environment; and/or incur project delays. Expect to be held liable for any damages caused, if you fail to call.

 **DANGER:** Buried electric cables or gas lines can cause serious injury or death if struck with dig chain. Always determine location of utilities before trenching.

 **WARNING:** Fiber optic cables convey laser light that can injure your eyesight.

STAY CLEAR of moving parts on the trencher.

 **DANGER:** Digging chain, auger and other moving parts can cut off arms, legs, or fingers. Contact with the digging chain or auger while in operation will cause serious injury or even death.

Wear safety goggles and a hard hat while operating or observing!

 **WARNING:** The dig chain may throw stones and debris.

Wear adequate hearing protection while operating or observing.

 **WARNING:** Exposure to loud noise is cumulative and may permanently damage your hearing.

Wear safety boots and gloves. Wear close-fitting clothing. Contain long hair. Do not wear jewelry. Wear reflective clothing if working near traffic.

Only operate outdoors and avoid breathing engine exhaust and fumes.

 **WARNING:** Engine exhaust contains carbon monoxide gas that is toxic. Breathing it can cause unconsciousness and death.

Adequate lighting is required, daylight or artificial, for safe operation of the trencher.

Allow adequate side and overhead clearances between trencher and buildings, fences, and trees.

 **WARNING:** If the dig chain contacts an object the digging chain can climb upward quickly and tip the trencher toward the operator. Serious injury or death will result by operator contact with the moving chain. The digging chain can suddenly drag the machine forward if the trencher is forced too quickly into the ground or catches on a buried object.

Insure that the CHAIN FORWARD/NEUTRAL/REVERSE LEVER is in NEUTRAL when not actually trenching.

 **WARNING:** Contact with the dig chain or auger while in operation will cause serious injury or even death. The teeth of the dig chain are sharp. Avoid contact even when the chain is not moving.



SAFETY INSTRUCTIONS OVERVIEW (continued)

Avoid inclines if at all possible.

 **WARNING:** Navigating on any incline increases the danger of the trencher losing traction or rolling over, especially if the surface is wet. If you lose control get out of the way immediately to avoid personal injury. Navigation on inclines should be especially slow and turns very gradual. Refer to the incline diagram in the section, "GROUND TRANSPORT".

 **WARNING:** The weight of the trencher or walking near the edge of the trench could cause collapse of the trench wall.
Avoid operating adjacent to drop-offs or embankments.

Keep away from tires to avoid getting crushed.

 **WARNING:** Getting run over by the trencher will cause injury.

Always leave trencher parked on a level surface.

 **WARNING:** Do not park on incline. Move the trencher to a level surface.
Do not leave trencher unattended with the engine running.

Do not operate trencher near any source of flammable dust or vapors.

 **WARNING:** Sparks from the engine exhaust can cause an explosion or fire in a flammable or explosive atmosphere. Fuel fumes can catch fire or explode.

Do not operate trencher near flames or sparks.

 **WARNING:** Fuel fumes can catch fire or explode.

Shut off engine and allow it to cool before refueling.

 **WARNING:** Fuel fumes can catch fire or explode. Do not smoke when refueling. Do not refuel near a source of flames or sparks.

Do not touch the engine, muffler, or any of the hydraulic components until cool.

 **WARNING:** Muffler and engine get hot enough to cause serious burns. For the safety of yourself and others, allow enough time for the engine, muffler, and the hydraulic fluid to cool completely before performing any cleaning or maintenance.

Avoid contact with hydraulic fluid.

 **WARNING:** When machine is operating, hydraulic fluid is under extreme pressure and can get under skin and burn or poison.

Keep others away. If the job site is near a road or pedestrian path, warn and divert both motorized traffic and pedestrians. As appropriate, use traffic flag personnel, signs, cones, and lighting devices to insure safety.

 **WARNING:** Someone could step into the trench by accident. Walking near the edge of the trench could cause collapse of the trench wall and possibly cause someone to fall onto the moving chain. Contact with the digging chain or auger while in operation will cause serious injury or even death.

Never allow anybody to ride on the trencher.

SAFETY INSTRUCTIONS OVERVIEW (continued)

Never lift trencher over any person at any time.



WARNING: If trencher should fall it would crush anybody under it. The trencher is very heavy. DO NOT attempt to manually lift it.

We recommend having a fire extinguisher suitable for petrol fires in the operating area.

Attachments can change the center of mass and machine operations. Use only Barreto attachments.

912 TRENCHER OPERATING INSTRUCTIONS

READ SAFETY INSTRUCTIONS BEFORE OPERATING!

Be sure that the engine oil, fuel and hydraulic oil are at proper levels before starting the engine.

STUDY AND UNDERSTAND CONTROLS BEFORE BEGINNING OPERATION.

1. **FREE WHEELING HUBS:** To engage either hub, turn the lock pin handle in (clockwise). This allows the spring-loaded pin to engage. Repeat for the other wheel. Push the trencher a bit if necessary until each pin finds a hole to drop into. The hubs are now locked. Disengaging one hub makes it much easier to turn the trencher when transporting under power.
2. **ENGINE IGNITION:** Must be in ON position to start the engine. Move to OFF position to stop the engine.
3. **ENGINE THROTTLE:** Controls engine speed. Operate at full throttle.
4. **CLUTCH LEVER:** Squeeze to activate the Wheel Drive and Dig Chain. All motion stops when the lever is released. It is located on the left handlebar.
5. **WHEEL DRIVE CONTROL:** Controls travel direction and speed. Very slow speed is required for trenching in most conditions. Begin trenching with the wheel control in neutral. Then adjust the reverse speed when trenching. **NOTE:** Be sure operator understands that the machine moves **BACK** when trenching, not forward.
6. **DIG CHAIN ON/OFF CONTROL:** To trench, hold the lever in the ON position while clutch lever is activated. The ON/OFF lever will stay in position as long as the clutch lever is held. This automatically will activate the **CHAIN FORWARD/REVERSE LEVER** to the **FORWARD** position.
7. **CHAIN FORWARD/REVERSE LEVER;** Use this lever to reverse chain to help clear debris from the chain. The clutch lever must be released to put the chain lever in reverse.
8. **DIGGING BOOM CONTROL:** Pull to raise the digging boom and push to lower the boom. During normal operation you will hear a relief valve working.

912 TRENCHER OPERATING INSTRUCTIONS (continued)

GETTING STARTED:

1. Start and warm up engine.
2. Put the Wheel Drive Control in neutral.
3. One wheel hub may be disengaged (free wheeling) for easier steering before driving machine to work location.
4. Squeeze the clutch lever and change the Wheel Direction Control to desired speed and direction.
5. Adjust the wheel speed and navigate the trencher to the starting position. The trencher is designed to dig toward the operator (with the Wheel Drive Control in reverse). With this in mind, position the machine to start the trench.

COLD WEATHER OPERATIONS: Before operating in cold weather, refer to the Engine Owner's Manual for recommended engine oil. Do not spray starting fluid into the air cleaner as engine damage could result. If the machine is operated at temperatures below +32°F (0°C) then changing the hydraulic fluid to ISO 46 is recommended. If you do not want to change the hydraulic fluid but want to operate the machine at temperatures below +32°F (0°C), then do the following:

- Warm up engine at a low speed.
 - Gradually increase engine speed, allowing **30 minutes for the hydraulic fluid to warm up**. Reduce the engine speed if the hydraulic pump whines. Pump noise may indicate a lack of hydraulic fluid flow that could damage the pump.
- For frequent starts below 18°F consult your Barreto Manufacturing dealer.

TRENCHING PROCEDURE:

1. Put the Wheel Drive Direction Control in neutral.
2. Be sure both hubs are engaged.
3. Have engine at full throttle (forward).
4. Hold the Dig Chain On/Off Control in On position.
5. Squeeze the clutch lever.
6. Slowly lower the digging boom until the desired trench depth is achieved.
7. Put the Wheel Drive Control in reverse. Start at slow speed.
8. Adjust the wheel speed until a workable speed is reached. Use a very slow speed for trenching and adjust for soil conditions as necessary. If objects such as rocks or roots jam in the chain, release the clutch lever, and then reverse the chain to dislodge the debris. If necessary move the trencher forward a few inches and trench the area again.

TRENCHING TIPS

THE PLUNGE CUT:

If the boom bounces when lowering it, use a more gradual "boom down" action. A little ground travel toward the operator during the plunge cut may help reduce bounce. Adjust the boom lowering speed for soil conditions as necessary.

Do not overload engine. If the engine lugs down or the digging chain slows down, raise the boom until speed increases, then continue lowering the boom slowly.

Do not attempt to force the boom down faster than the digging chain can remove the material!

OPERATOR PREPARATION

Each operator must:

- Become familiar with the controls and operation of the trencher, preferably under the supervision of an experienced operator.
- Be at least 18 yrs. of age and be mentally and physically capable of operating the trencher safely.
- Have studied the SAFETY AND OPERATING INSTRUCTIONS in this manual.

PERSONAL PROTECTION: For safety, trencher operator should wear personal protection equipment. Keep observers at a safe distance.

Wear safety eye goggles and a hard hat while operating or observing!

 **WARNING:** The dig chain may throw stones and debris.

Wear safety boots and gloves. Wear close-fitting clothing. Contain long hair. Do not wear jewelry. Wear reflective clothing if working near traffic.

Wear adequate hearing (ear) protection while operating or observing.

 **WARNING:** Exposure to loud noise is cumulative and may permanently damage your hearing.



SHUT DOWN PROCEDURE

1. Always leave trencher parked on a level surface.

 **WARNING:** Do not park on incline. Move the trencher to a level surface.

2. Unless loaded on a trailer, lower the boom to the ground.

3. Reduce the ENGINE THROTTLE to idle.

4. Move the IGNITION SWITCH to the OFF position to stop the engine.

5. **CLOSE THE FUEL SHUTOFF VALVE.** Failure to close this valve could cause fuel to leak down into the cylinder & crankcase. Damage resulting from this **WOULD NOT** be covered by your engine warranty!



Shut off engine and allow it to cool before refueling.

 **WARNING:** Fuel fumes can catch fire or explode. Do not smoke or allow flames or sparks in the area.

Do not touch the engine, muffler, or any of the hydraulic components until cool.

 **WARNING:** Muffler and engine get hot enough to cause serious burns. For the safety of yourself and others, allow enough time for the engine, muffler, and the hydraulic fluid to cool completely before performing any cleaning or maintenance.

GROUND TRANSPORT OF THE TRENCHER

Raise the digging chain boom.



WARNING: Contact with the dig chain or auger while in operation will cause serious injury or even death. The teeth of the dig chain are sharp. Avoid contact even when the chain is not moving.

Use the Wheel Drive Control to control travel direction. The Wheel Drive Engage Lever must be pulled and held to move the trencher.

- Pushing the Wheel Drive Control forward causes the machine to move forward.
- Pulling the Wheel Drive Control back causes the machine to move backward.
- If you are not experienced operating this trencher, a slow ground speed is recommended for your safety. Use half throttle for slower transport speed.



Keep away from tires to avoid getting crushed.

WARNING: Getting run over by the trencher will cause injury.

Never allow anybody to ride on the trencher.

Never make sudden changes in speed or direction.

Use extra caution on soft or uneven ground.

Avoid operating adjacent to drop-offs or embankments.

Avoid inclines if at all possible. Never use on any incline exceeding the angles shown below.



WARNING: Navigating on any incline increases the danger of the trencher losing traction or rolling over, especially if the surface is wet. If you lose control get out of the way immediately to avoid personal injury. Navigation on inclines should be especially slow and turns very gradual.

A 20° maximum incline is allowed. Honda engines have an Oil Alert system that will automatically stop the engine if tipped more than 20°.

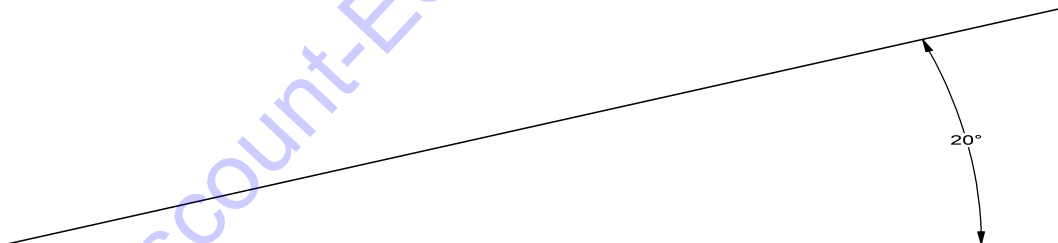

DETERMINE LOCATION OF UNDERGROUND UTILITIES

OSHA CFR 29 1926.651 requires that the estimated location of underground utilities be determined before beginning excavation or an underground drilling operation. When the actual excavation or bore approaches an estimated utility location, the exact location of the underground installation must be determined by a safe, acceptable and dependable method. If any utility cannot be precisely located, the appropriate utility company must shut it off.

Call before you dig. If you do not call, you may cause an accident; suffer injuries or death; cause interruption of services; damage the environment; and/or incur project delays. Expect to be held liable for any damages caused, if you fail to call.



DANGER: Buried electric cables or gas lines can cause serious injury or death if struck with dig chain. Always determine location of utilities before trenching.



WARNING: Fiber optic cables convey laser light that can injure your eyesight.

CALL 1-888-258-0808 TO LOCATE UTILITIES BEFORE TRENCHING (US. OR CANADA). This free service will provide a “One-Call” number for the geographic area that you select. Before you start any digging project, be sure to call the local One-Call system in your area and any utility company that does not subscribe to the One-Call system. The One-Call representative will notify participating utility companies of your proposed digging activities. Utilities will then mark their underground facilities by using the following international marking codes:

Red	Electric
Yellow	Gas, oil, or petroleum
Orange	Communication, telephone, television
Blue	Potable water
Green/brown	Sewer
White	Proposed excavation
Pink	Surveying

For areas not represented by One-Call Systems International, contact the appropriate utility companies to locate and mark the underground installations. Do not rely on visual evidence of underground utilities such as manhole covers or electrical drop boxes...**CALL!**

WORK SITE ASSESSMENT

Examine the work area for any conditions or obstructions that may inhibit trenching or create a safety hazard for the operator or others. Use the information in this manual combined with good judgment to identify any hazards to avoid.

In addition to calling to DETERMINE LOCATION OF UNDERGROUND UTILITIES (see previous section for details), the operator and/or job foreman should visually inspect the work site. Look for electrical drop boxes, notices of underground placements, manhole covers, recent trenching activity, any evidence of possible underground placements, banks, overhangs, drop-offs, rocks, tree limbs, wire, uneven terrain, any existing trenches or holes and toxic ground conditions.



Only operate trencher outdoors and avoid breathing engine exhaust and fumes.
WARNING: Engine exhaust contains carbon monoxide gas that is toxic. Breathing it can cause unconsciousness and death.



Do not operate trencher near any source of flammable dust or vapors.
WARNING: Sparks from the engine exhaust can cause an explosion or fire in a flammable or explosive atmosphere. Fuel fumes can catch fire or explode.



Allow adequate side and overhead clearances between trencher and any objects such as buildings, fences, and trees.
WARNING: If the digging chain contacts an object, the digging chain can climb upward quickly and tip the trencher toward the operator. Serious injury or death will result by operator contact with the moving chain or auger. The digging chain can suddenly drag the machine forward if the trencher is forced too quickly into the ground or catches on a buried object.

Adequate lighting is required, daylight or artificial, for safe operation of the trencher.

Keep others away. If the job site is near a road or pedestrian path, warn and divert both motorized traffic and pedestrians. As appropriate, erect barriers, use traffic flag personnel, signs, cones, and lighting devices to insure safety.



WARNING: Someone could step into the trench by accident. Walking near the edge of the trench could cause collapse of the trench wall and possibly cause someone to fall onto the moving chain. Contact with the digging chain or auger while in operation will cause serious injury or even death.

MACHINE FUNCTION CHECK: If the operator releases the WHEEL DRIVE or DIG CHAIN LEVERS, these functions should stop. This is intended for your safety and must be maintained in good functional condition. Contact your dealer or the factory if anything on the trencher does not function properly.

CONTACT WITH UNDERGROUND UTILITIES

After LOCATING UNDERGROUND UTILITIES and performing the WORK SITE ASSESSMENT, accidental dig chain contact with a buried utility might still occur. If it does, stop digging and call 911 for help.

If you cut a wire or cable, assume that you do not know what kind it is. It may be electrical or any one of several communication lines: telephone, television, or fiber optic. In any case, do not touch it or even look at the ends of it. Stop digging and call 911 for help. Do not dig any more until the appropriate utility company has assessed the situation, taken appropriate action, and informed you that it is safe to proceed.

If you strike a pipe, it could be gas, oil, petroleum, water or sewer. In any case, stop digging, shut off the engine, and evacuate the area immediately. **Call 911 for help.**

Electrical wires or cables: If you think that you may have severed electrical wires, stop digging and call 911 for help. Keep yourself and other people away from the area.



DANGER: An electric shock could kill you. Assume that any severed wire or cable is HOT with voltage and do not touch it!

Gas lines: If you think that you may have struck a gas line, shut off the engine and evacuate the area immediately. Call 911 for help.



DANGER: A gas explosion could kill you. Sparks will likely occur from the dig chain scraping the metal pipe. If gas leaks out an explosion could easily occur.

Fiber optic cables: If you think that you may have severed a fiber optic cable, do not touch or even look at the ends of it.



WARNING: Fiber optic cables convey laser light that can injure your eyesight. Call 911 for help.