

Self-Prime Diesel Trash Pump

Owner's Manual

MTP4DZD • MTP4DZV • MTP6DZD • MTP6DZV

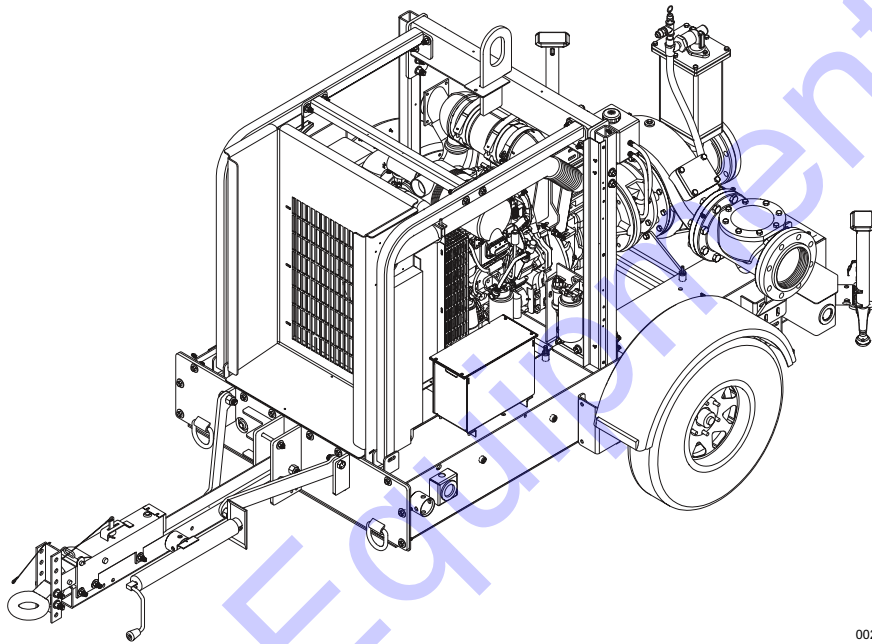

002073

MODEL NUMBER: _____

SERIAL NUMBER: _____

DATE PURCHASED: _____

**Discount
Equipment**

www.discount-equipment.com

SAVE THIS MANUAL FOR FUTURE REFERENCE

Discount Equipment

Discount-Equipment.com is your online resource for commercial and industrial quality parts and equipment sales.

Locations:

Florida (West Palm Beach): [561-964-4949](tel:561-964-4949)

Outside Florida TOLL FREE: [877-690-3101](tel:877-690-3101)

Need parts? Check out our website at www.discount-equipment.com

Can't find what you need?

Click on this link: <http://www.discount-equipment.com/category/5443-parts/> and fill out the request form.

Please have the machine model and serial number available in order to help us get you the correct parts. One of our experienced staff members will get back to you with a quote for the right part that your machine needs.

We sell worldwide for the brands: Genie, Terex, JLG, MultiQuip, Mayco, Toro/Stone, Diamond Products, Magnum, Airman, Mustang, Power Blanket, Nifty Lift, Atlas Copco, Chicago Pneumatic, Allmand Brothers, Essick, Miller Spreader, Skyjack, Lull, Skytrak, Tsurumi, Husquvarna/Target, Whiteman-Concrete/Mortar, Stow-Concrete/Mortar, Baldor, Wacker, Sakai, Snorkel, Upright, Mi-T-M, Sullair, Neal, Basic, Dynapac, MBW, Weber, Bartell, Bennar Newman, Haulotte, Ditch Runner, Blaw-Knox, Himoina, Best, Buddy, Crown, Edco, Wyco, Bomag, Laymor, Terremite, Barreto, EZ Trench, Takeuchi, Basic, Bil-Jax, Curtis, Gehl, Heli, Honda, ICS/PowerGrit, Puckett, Waldon, ASV, IHI, Partner, Imer, Clipper, MMD, Koshin, Rice, Gorman Rupp, CH&E, Cat Pumps, Comet, General Pump, Giant, AMida, Coleman, NAC, Gradall, Square Shooter, Kent, Stanley, Tamco, Toku, Hatz, Kohler, Robin, Wisconsin, Northrock, Oztec, Toker TK, Rol-Air, Small Line, Wanco, Yanmar

New Equipment - Used Equipment - Rental Equipment - Parts and Accessories

Discount Equipment

www.discount-equipment.com

561-964-4949

Parts: wbparts@Discount-Equipment.com

Sales: info@Discount-Equipment.com

▲WARNING

California Proposition 65. Engine exhaust and some of its constituents are known to the state of California to cause cancer, birth defects, and other reproductive harm. (000004)

▲WARNING

California Proposition 65. This product contains or emits chemicals known to the state of California to cause cancer, birth defects, and other reproductive harm. (000005)

Table of Contents

Section 1 Introduction and Safety

Introduction	1
Safety Rules	1
General Hazards	1
Explosion and Fire Hazards	2
Trailer Hazards	2
Battery Hazards	2
Pump Hazards	3
Reporting Trailer Safety Defects	3

Section 2 General Information

Unit Dimensions	5
Unit Serial Number Locations	6
Component Locations	9
Trailer Tongue Preparation for Use	13
Hood Operation	14
To open the rear hood:	14
To close the rear hood:	14
Welding on Equipment with Electronic Controls	15

Section 3 Operation

Control Panel Operation	17
LED Indicators	17
Auto Standby LED (Green)	17
Preheat LED (Amber)	17
Engine Stop LED (Red)	17
Warning LED (Amber)	17
Throttle Control	17
Ramp Throttle (Speed Control Switch)	18
Automatic START and STOP	18
Start and Stop Events	19
Start and Stop Modes:	19
Start and Stop Functions:	19
Maintain Functions	19
Dead Band	20
Digital Controller	20
Button Lock	20
Analog Gauge Pages	21
Digital Gauge Pages	21
Single Analog Gauge	21

Analog Transducer/Switch Gauge	22
Digital Transducer Gauge	22
Active Alarms	22
Alarm List	22
Configuration Menu	22
Display Menu	23
Units Menu	23
Language Menu	23
Button Beep	23
Gauges Menu	23
Max RPM	24
Max Speed	24
Quad Adjust	24
Voltmeter	24
Service Timers	24
System Menu	24
Demo	24
Restore Defaults	24
Com Viewer	25
J1939 Viewer	25
Engine Configuration	25
J1939 Settings	25
Engine Source	26
Display CAN Add	26
Alarm Filter	26
SPN Version	26
Speed Source	26
PIN Settings	26
PIN Entry	26
PIN Change	26
About	27
Autostart Menu	27
Mode	27
Function	27
Throttling Menu	27
Idle RPM	28
Intermediate RPM	28
Run RPM	28
Ramp Up/Down	28
Servo	28
Transducer	28
Starter	29

Settings Menu	29	Checking the Oil Level Sight Gauge (Diaphragm Pump Only)	45
Governor	29	Changing the Engine Oil	45
CP750 CAN Add	29	Changing the Oil Filter	45
Calibrate RPM	29	Adding Coolant	45
Aux Output	30	Jack Maintenance	45
Alarm Settings	30	Side-Wind Models	45
Telemetry Menu	30	Top-Wind Models	46
Telem J1939 Address	30	Wear Rings	46
Modbus Address	30	Servicing The Pump	46
Status	30	Pump Disassembly	46
DB Viewer	31	Pump Assembly	48
Preferred Screen Store	31	Impeller Lockscrew Installation	49
Pop-Up Messages and Alerts	31	Lubrication	49
Service Required	31	Impeller Lockscrew Removal	49
Data Communications Failure	31	Frame Disassembly and Assembly	49
Data Not Available	31	Disassembly	49
Adjusting Lighting and Contrast	31	Assembly	50
Data Parameters Monitored	32	Lubrication Instructions	50
Pump Set Up	34	Mechanical Seal Maintenance	50
Pump Pre-use Checkpoints	36	Mechanical Seal Oil	50
Prestart Checklist	36	Removing the Mechanical Seal	51
Starting the Unit	37	Removing the O-ring Seat	51
Flow Rates	38	Installing the O-ring Seat	51
Diaphragm Pump System	39	Installing the Mechanical Seal	51
Operation	39	Priming Chamber	52
Mechanical Seal	39	Float Removal	52
Liquid Temperature and Overheating	39	Installation	52
Pump Vacuum Check	39	Prime Valve Removal and Installation	52
Bearing Temperature Check	39	Float Valve Linkage Removal and Installation	52
Stopping The Unit	39	Linkage Replacement	52
Emergency Stop Switch	40	Strainer/Baffle	52
Automatic Shutdown	40	Separator	52
Remote/Auto Starting Option	40	Discharge Check Valve	53
Towing the Unit	40	Maintenance	53
Lifting the Unit	41	Disassembly	53
Section 4 Maintenance		Assembly	53
Daily Walk Around Inspection	43	Diaphragm Pump System	54
General Maintenance	44	Disassembly	54
Checking the Engine Oil	44	Assembly	56
		Suction Valve Removal and Installation	56
		Actuator Neck Seal Removal and Installation	56

Table of Contents

Crankshaft Removal and Installation	56	Section 5 Troubleshooting	
Removal	56	Pump Troubleshooting Guide	59
Installation	57	Engine Fault Shutdown Troubleshooting	60
Crankshaft Lip Seal Removal and Installation	57	Control System Troubleshooting	61
Roller Bearing Removal and Installation	57	Diagnostic Trouble Codes (DTS)	61
Connecting Rod/Drive Rod Assembly	57	SPN Codes	61
Pedestal Bearing and Seals Removal and Installation	58	FMI Codes	62
Trailer Wheel Bearings	58	Section 6 Installation Diagrams and Service Log	
Storage	58	DC Wiring Diagram	63
Extended Storage Preparation	58	Trailer Lights Wiring Diagram	64
Winter Storage	58	Service Log	65
Commission Unit for Use	58		

Section 1 Introduction and Safety

Introduction

Thank you for purchasing a Generac Mobile Product. This unit has been designed to provide high-performance, efficient operation, and years of quality use when maintained properly.

The unit is mounted on a trailer that has a chain attach point. The fully enclosed design protects the operating components, allowing all-weather storage and operations.



WARNING

Consult Manual. Read and understand manual completely before using product. Failure to completely understand manual and product could result in death or serious injury. (000100a)

The unit is mounted on a trailer that has a chain attach point. The fully enclosed design protects the operating components, allowing all-weather storage and operations.

If any section of the manual is not understood, contact your nearest Authorized Service Dealer.

The owner is responsible for proper maintenance and safe use of the equipment.

SAVE THESE INSTRUCTIONS for future reference. This manual contains important instructions for the pump that should be followed during installation, operation and maintenance of the pump and batteries. **ALWAYS** supply this manual to any individual that will use this machine.

THE INFORMATION CONTAINED HEREIN WAS BASED ON MACHINES IN PRODUCTION AT THE TIME OF PUBLICATION. GENERAC RESERVES THE RIGHT TO MODIFY THIS MANUAL AT ANY TIME.

Safety Rules

The manufacturer cannot anticipate every possible circumstance that might involve a hazard. The warnings in this manual, and on tags and decals affixed to the unit are, therefore, not all inclusive. If using a procedure, work method or operating technique that the manufacturer does not specifically recommend, verify that it is safe for others. Also verify the procedure, work method or operating technique utilized does not render the equipment unsafe.

Throughout this publication, and on tags and decals affixed to the unit, **DANGER**, **WARNING**, **CAUTION**, and **NOTE** blocks are used to alert personnel to special instructions about a particular operation that may be hazardous if performed incorrectly or carelessly. Observe them carefully. Their definitions are as follows:

DANGER

Indicates a hazardous situation which, if not avoided, will result in death or serious injury.

(000001)

WARNING

Indicates a hazardous situation which, if not avoided, could result in death or serious injury.

(000002)

CAUTION

Indicates a hazardous situation which, if not avoided, could result in minor or moderate injury.

(000003)

NOTE: Notes contain additional information important to a procedure and will be found within the regular text of this manual.

These safety alerts cannot eliminate the hazards that they indicate. Common sense and strict compliance with the special instructions while performing the action or service are essential to preventing accidents.

General Hazards



DANGER

Asphyxiation. Running engines produce carbon monoxide, a colorless, odorless, poisonous gas. Carbon monoxide, if not avoided, will result in death or serious injury. (000103)

WARNING

Do not operate this unit while transporting. Doing so could result in death or serious injury.

(000231)



WARNING

Hearing Loss. Hearing protection is recommended when using this machine. Failure to wear hearing protection could result in permanent hearing loss. (000107)



⚠️ WARNING

Moving Parts. Keep clothing, hair, and appendages away from moving parts. Failure to do so could result in death or serious injury.

(000111)



⚠️ WARNING

Hot Surfaces. When operating machine, do not touch hot surfaces. Keep machine away from combustibles during use. Hot surfaces could result in severe burns or fire.

(000108)

⚠️ CAUTION

Equipment or property damage. Do not block air intake or restrict proper air flow. Doing so could result in unsafe operation or damage to unit.

(000229)

⚠️ CAUTION

Equipment Damage. The emergency stop switch is not to be used to power down the unit under normal operating circumstances. Doing so will result in equipment damage.

(000246)

Explosion and Fire Hazards



⚠️ DANGER

Explosion and Fire. Fuel and vapors are extremely flammable and explosive. Add fuel in a well ventilated area. Keep fire and spark away. Failure to do so will result in death or serious injury.

(000105)



⚠️ WARNING

Risk of Fire. Unit must be positioned in a manner that prevents combustible material accumulation underneath. Failure to do so could result in death or serious injury.

(000147)

Trailer Hazards

⚠️ WARNING

Trailer must be securely coupled to the hitch and chains correctly attached. Uncoupled or unchained towing could result in death or serious injury.

(000233)

⚠️ WARNING

Verify unit is properly secured with wheel chocks and on level ground. Failure to do so could result in death or serious injury.

(000234)

⚠️ WARNING

Property or Equipment Damage. Tighten wheel lug nuts after first 50 miles to factory specifications. Failure to do so could result in death, serious injury, property or equipment damage.

(000235)

Battery Hazards



⚠️ WARNING

Explosion. Batteries emit explosive gases while charging. Keep fire and spark away. Wear protective gear when working with batteries. Failure to do so could result in death or serious injury.

(000137a)



⚠️ WARNING

Explosion. Do not dispose of batteries in a fire. Batteries are explosive. Electrolyte solution can cause burns and blindness. If electrolyte contacts skin or eyes, flush with water and seek immediate medical attention.

(000162)



⚠️ WARNING

Risk of burn. Do not open or mutilate batteries. Batteries contain electrolyte solution which can cause burns and blindness. If electrolyte contacts skin or eyes, flush with water and seek immediate medical attention.

(000163a)

⚠️ WARNING

Accidental Start-up. Disconnect the negative battery cable, then the positive battery cable when working on unit. Failure to do so could result in death or serious injury.

(000130)

⚠️ WARNING

Environmental Hazard. Always recycle batteries at an official recycling center in accordance with all local laws and regulations. Failure to do so could result in environmental damage, death or serious injury.

(000228)

Pump Hazards

WARNING

Personal Injury. Do not pump volatile, corrosive, or flammable materials. Doing so could result in death or serious injury and pump damage.

(000271)

WARNING

Personal Injury. Verify all hoses are securely fastened. Failure to do so could result in death or serious injury.

(000272)

WARNING

Personal Injury. Do not operate pump with flow completely restricted. Doing so could cause pump casing to explode and could result in death or serious injury.

(000273)

WARNING

Personal Injury. Allow pump to cool completely before removal of any parts. Failure to do so could cause parts to be ejected with great force and could cause death or serious injury.

(000274)

Reporting Trailer Safety Defects

If you believe your trailer has a defect which could cause a crash or could cause injury or death, you should immediately inform the National Highway Traffic Safety Administration (NHTSA) in addition to notifying Generac Mobile Products, LLC.

If NHTSA receives similar complaints, it may open an investigation; and if it finds that a safety defect exists in a group of vehicles, it may order a recall and remedy campaign. However, NHTSA cannot become involved in an individual problem between you, your dealer, or Generac Mobile Products, LLC.

To contact NHTSA, you may either call the Auto Safety Hotline toll-free at 1-888-327-4236 (TTY: 1-800-424-9153), go to <http://www.safercar.gov>; or write to:

Administrator
NHTSA
1200 New Jersey Avenue S.E.
Washington, DC 20590

You can also obtain other information about motor vehicle safety from <http://www.safercar.gov>.

Section 2 General Information

Unit Dimensions

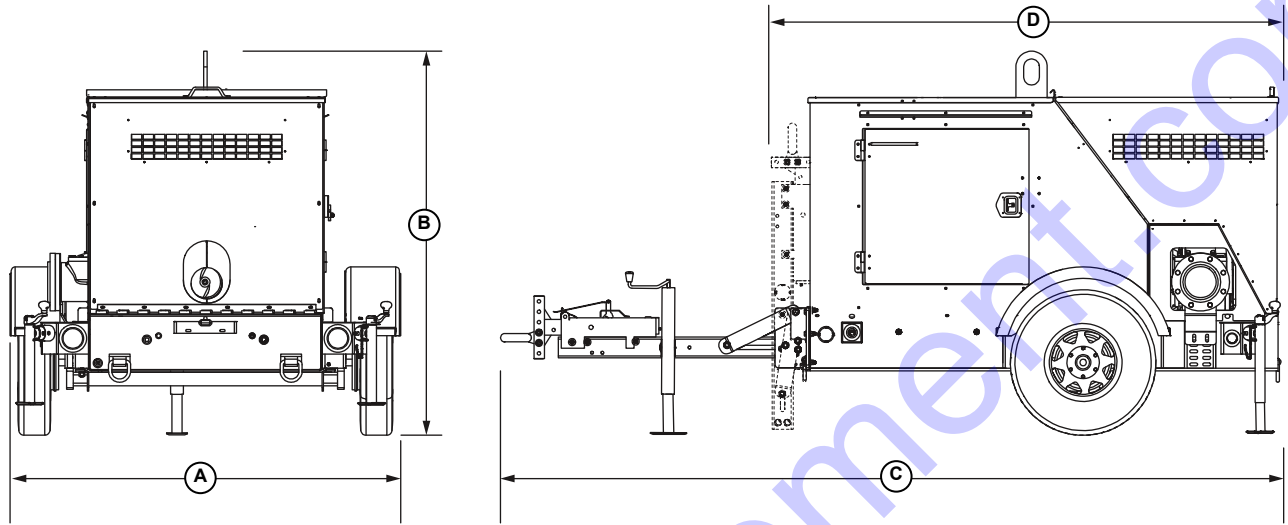

002132

Figure 2-1. Unit Dimensions

	A	B	C	D
MTP4DVD	75.00 in (1.905 m)	73.88 in (1.877 m)	150.12 in (3.813 m)	98.00 in (2.489 m)
MTP4DVZ				
MTP6DVD				
MTP6DVZ				

Specifications are subject to change without notice.

Unit Serial Number Locations

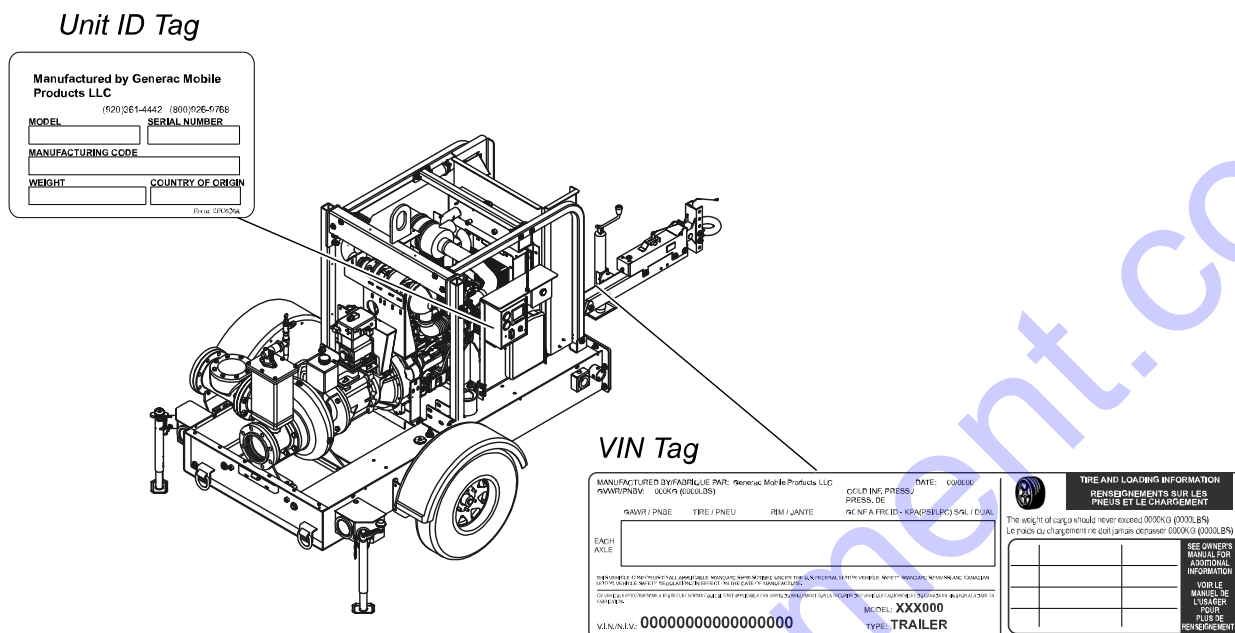

002291

Figure 2-2. Serial Number Locations

Safety Decal Locations

NOTE: Locations may vary slightly from unit to unit.

ID	Description	ID	Description
A	General safety: keep hands clear of belt, hot surfaces, and fan, and do not remove guard	N	Beware of moving blades
B	Float switch port location	P	Suction port location
C	Do not step	Q	Fuel tank drain location
D	Tie down location	R	Discharge port location
E	Towing instructions	S	Lubricant Grease every 1500 hours for optional equipment
F	Operator's manual storage location	T	Lubricant Grease every 1500 hours
G	Disconnect battery before servicing	U	Engine oil drain location
H	Fuel requirement	V	Engine coolant drain location
J	Stop the engine. Do not smoke while refueling. Do not breathe in fuel vapors. See the operators manual for further instructions. Fill the tank with diesel.	W	Disconnect battery before servicing
K	Autostart, understand operator's manual before operation, hearing protection required while operating unit	X	Hot surface
L	Pump operation instructions	Y	Lifting point
M	Do not pump dangerous liquids.	Z	Keep hands free of belt

PUMP OPERATION

- Level unit with three jacks.
- Attach intake and outlet hoses/piping.
- Emergency stop off. Engine start switch to "Start".
- Allow pump to prime.
- Allow pump to cool if overheated.
- If overloaded, vent pump slowly at casing drain.
- Read operator's manual before restarting.

FONCTIONNEMENT DE LA POMPE

- Mettez la pompe à niveau avec les trois crics.
- Attachez les tuyaux/canalisations d'arrivée/d'écoulement.
- Débranchez l'arrêt d'urgence. Mettez l'interrupteur de démarrage du moteur sur "Start" (démarrage).
- Laissez la pompe s'amorcer.
- Laissez la pompe refroidir si elle est surchauffée.
- Si la liquéide est pressurisée, vider lentement la pompe par le vidage du carter.
- Lire le manuel d'utilisation avant la remise en service.

BEIDUNGUNG DER PUMPE

- Gerät mit allen drei wagenstützen nivellieren.
- Ansaug- und austrittschläuche/-rohre anschließen.
- Not-stop ausschalten, Motorstartschalter auf "Start" stellen.
- Pumpe vorfüllen lassen.
- Bei Überlastung Pumpe abblättern lassen.
- Bei druckaufbau Pumpe langsam am rohraustritt entlüften.
- Vor dem erneuten anlassen gebrauchsanweisung beachten.

PUMP INLET (SUCTION) PORT
 IMPRIMBENTRITTSPUNKT
 ORIFICO DE ENTRADA (SUCCIÓN) DE LA BOMBA
 GRIJSSE INSLUITINGSPUNTIJN (SUCCIÓN) DE LA BOMBA

PUMP CLEAROUT COVER
 PLAMPREINREINIGUNGSABDECKUNG
 COBERTA DE LIMPIEZA DE LA BOMBA
 COUVERTURE DE NETTOYAGE DE LA POMPE

PUMP OUTLET (DISCHARGE) PORT
 IMPRIMISCHIESSPUNKT
 ORIFICO DE SALIDA (DESCARGA) DE LA BOMBA
 GRIJSSE UITSLUITINGSPUNTIJN (DESCARGA) DE LA BOMBA

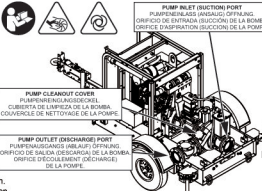

WARNING

This pump is designed for use only with water containing suspended solids. Do not operate in an explosive environment. Do not attempt use with volatile, corrosive or flammable materials or liquids. Damage to the pump or severe bodily damage may occur.

WARNING

Diese Pumpe ist nur zum Einsatz mit Wasser mit schwebfesten Gerüsten. Bei explosionsgefährlicher nicht einsetzen. Nicht für flüchtige, korrosive oder entzündbare Materialien oder Flüssigkeiten verwenden. Dies kann zur Beschädigung der Pumpe und zu schweren Körperverletzungen führen.

ADVERTENCIA

Esta bomba está diseñada para usarse solo con agua que contenga sólidos en suspensión. No la haga funcionar en un ambiente explosivo. No intente usarla con materiales o líquidos volátiles, corrosivos o inflamables. Puede causar daños a la bomba o lesiones corporales graves.

AVERTISSEMENT

Cette pompe est conçue pour être utilisée uniquement avec de l'eau contenant des matières solides en suspension. Ne pas faire fonctionner la pompe dans un environnement explosif. Ne pas l'utiliser avec des matériaux ou des liquides volatils, corrosifs ou inflammables. La pompe risque d'être endommagée et de provoquer des blessures graves.

WARNING

ADVERTENCIA

AVERTISSEMENT

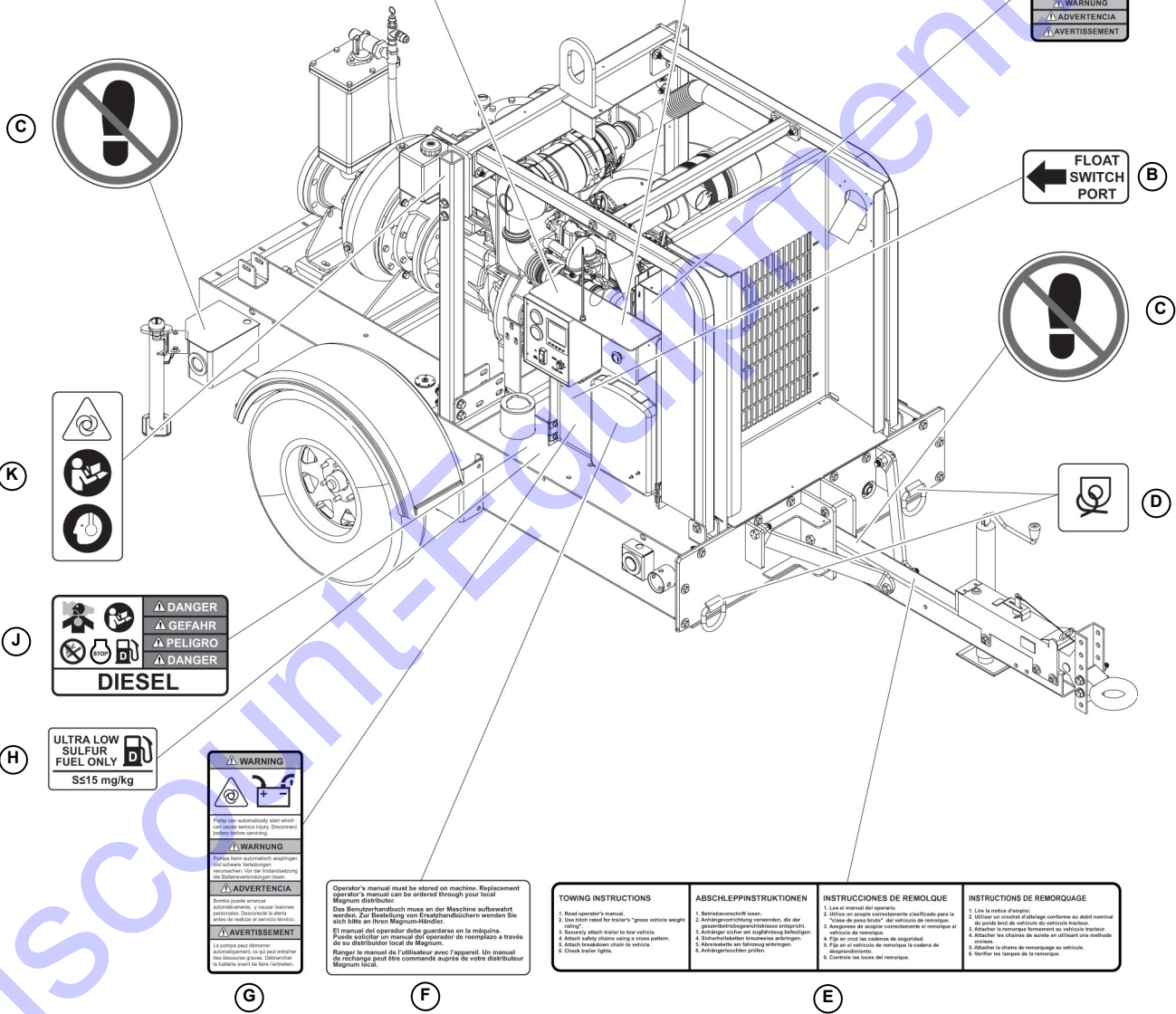

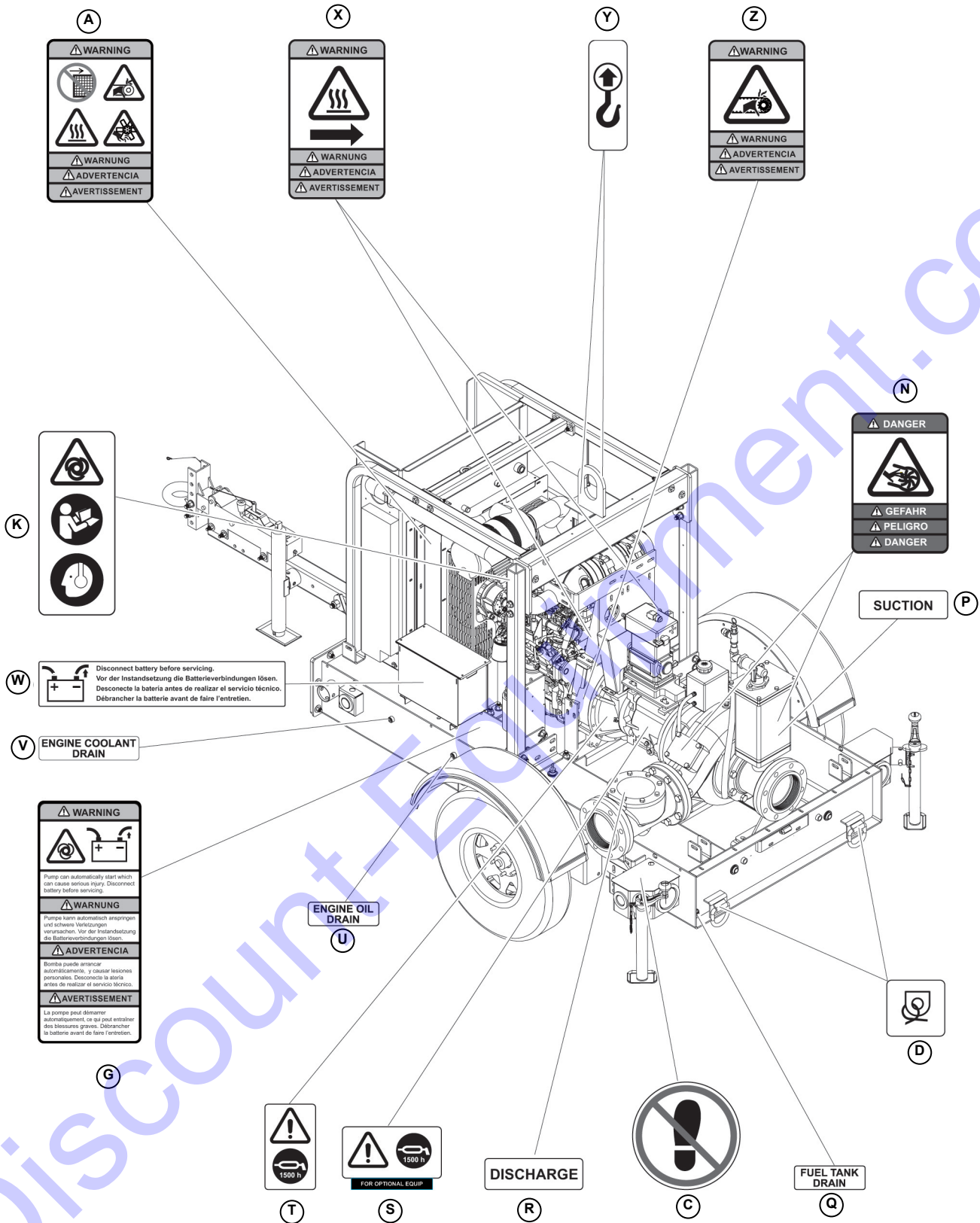

002756

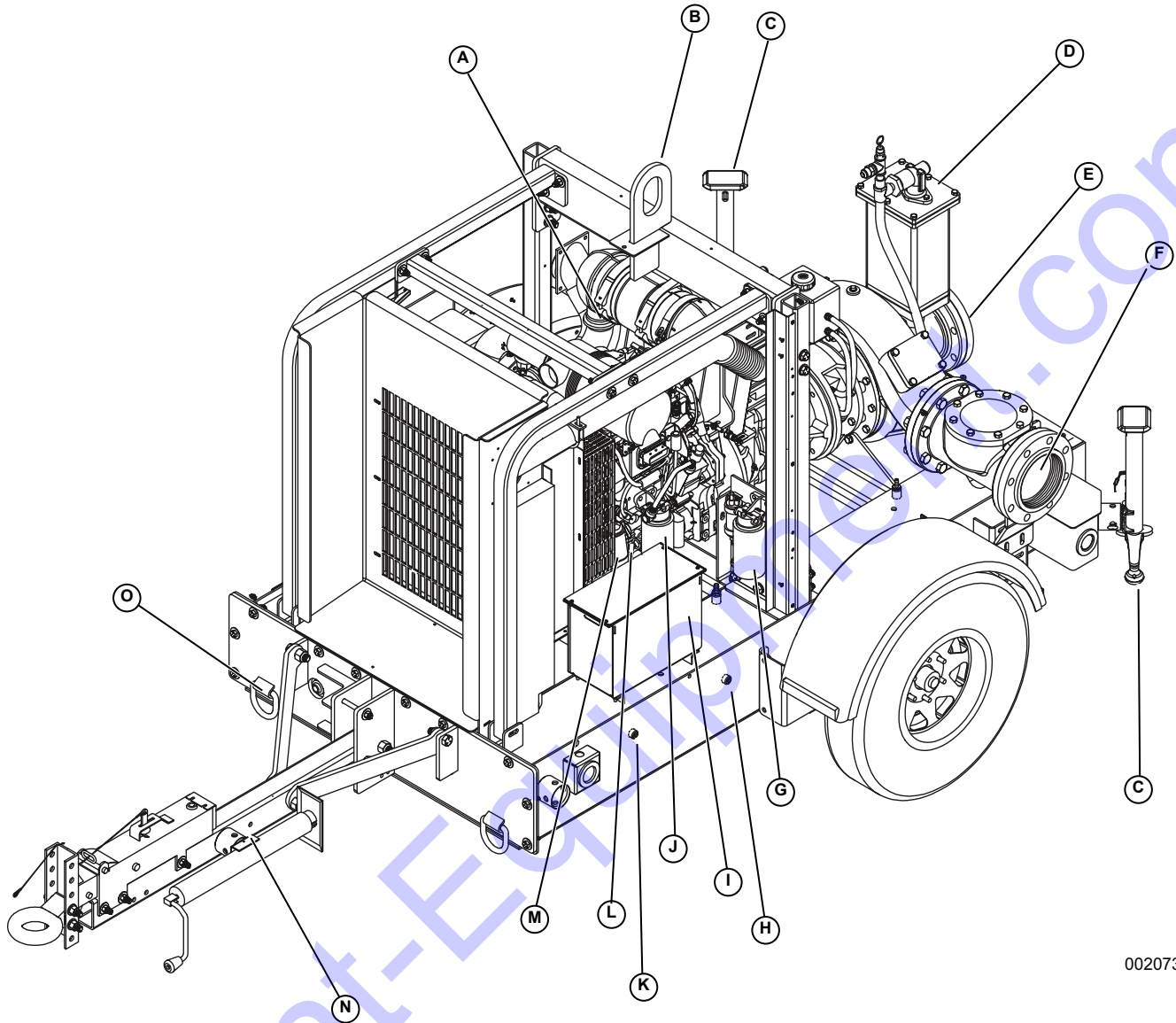

002757

Component Locations



002073

Figure 2-3. Left Side (6 Inch DZV Pump Shown)

- | | |
|---------------------------------|------------------------|
| A. Air cleaner | I. Battery |
| B. Central lift point | J. Fuel filter (main) |
| C. Rear leveling jacks (2) | K. Coolant drain |
| D. Priming chamber | L. Engine oil dipstick |
| E. Pump inlet (suction) port | M. Engine oil filter |
| F. Pump outlet (discharge) port | N. Front leveling jack |
| G. Fuel pre-filter | O. Tie down ring |
| H. Engine oil drain | |

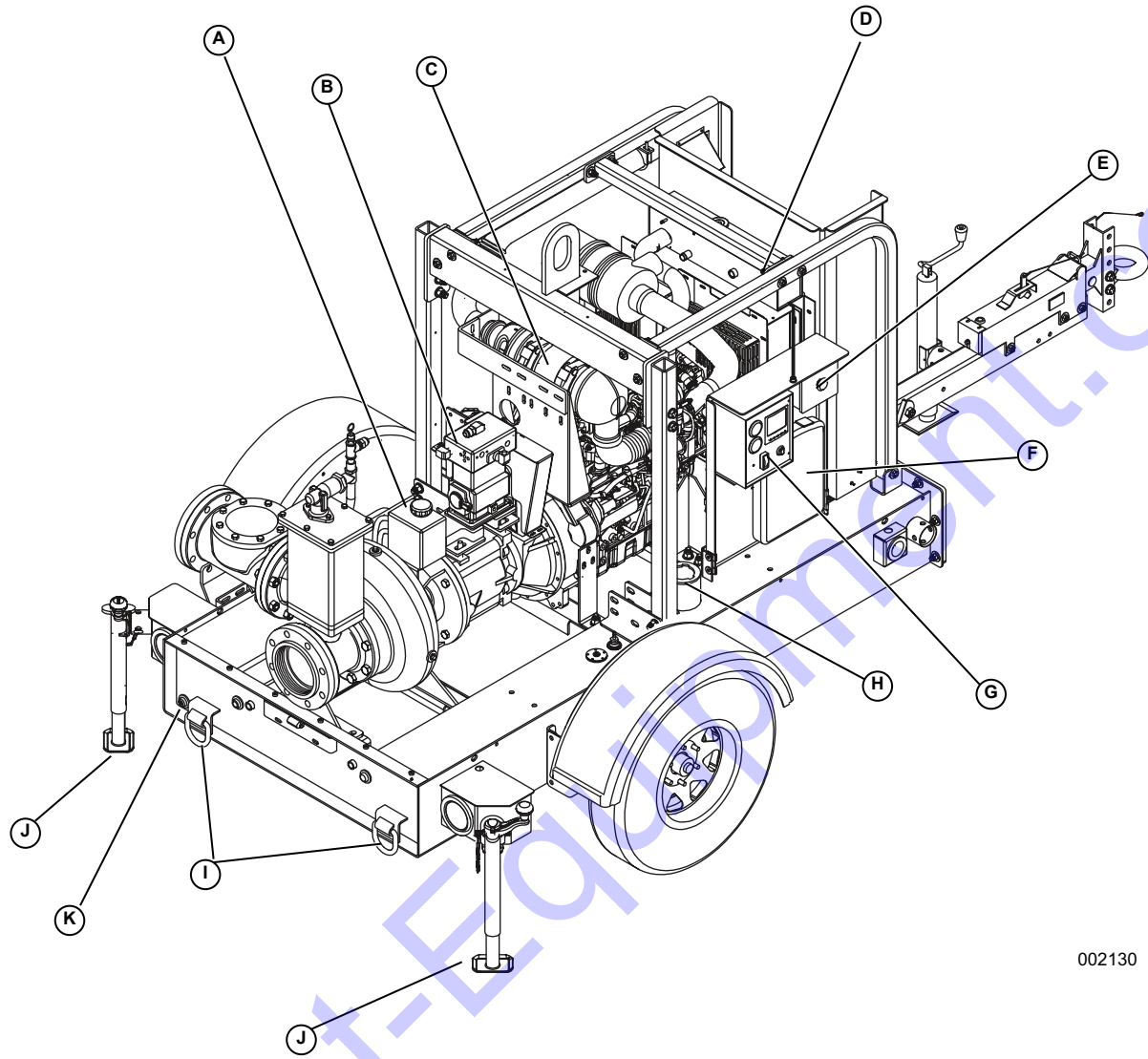

002130

Figure 2-4. Right Side (6 Inch DZV Pump Shown)

- | | |
|----------------------------------|------------------------|
| A. Mechanical seal oil reservoir | G. Control panel |
| B. Compressor | H. Fuel fill port |
| C. DOC | I. Tie down rings |
| D. Radiator sight glass | J. Rear leveling jacks |
| E. Emergency stop switch | K. Fuel tank drain |
| F. Manual holder | |

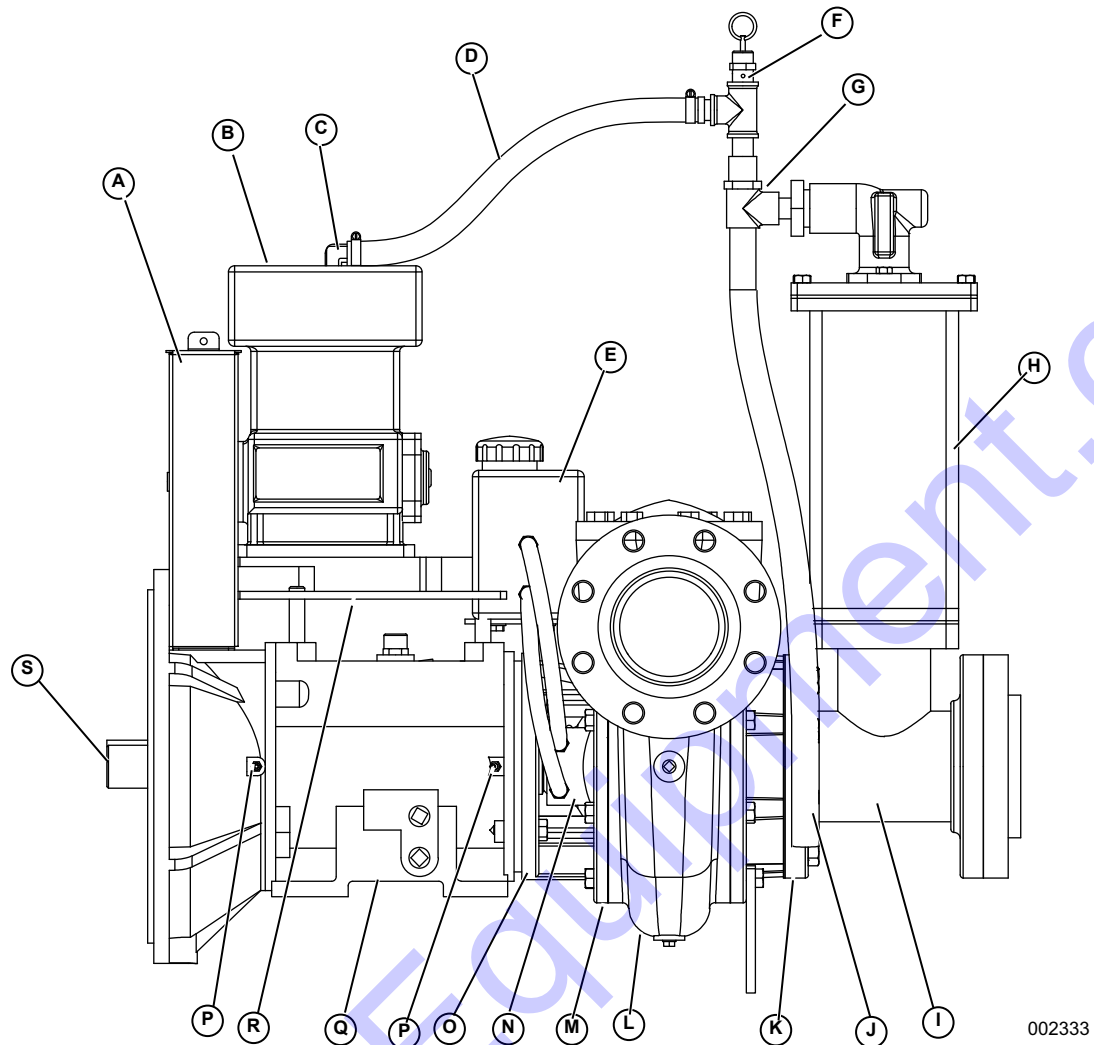

Figure 2-5. Venturi-Prime Pump Components - Left Side (4 Inch Shown)

- | | | | |
|----|-------------------------------|----|-------------------------|
| A. | Belt and guard | K. | Suction cover |
| B. | Compressor | L. | Volute |
| C. | Compressor output fitting | M. | Backplate |
| D. | Compressor hose | N. | Mechanical seal |
| E. | Mechanical seal oil reservoir | O. | Frame bracket |
| F. | Relief valve | P. | Grease fittings |
| G. | Venturi fitting | Q. | Bearing frame |
| H. | Priming chamber | R. | Compressor bracket |
| I. | Suction spool | S. | Drive end shaft and key |
| J. | Air discharge hose | | |

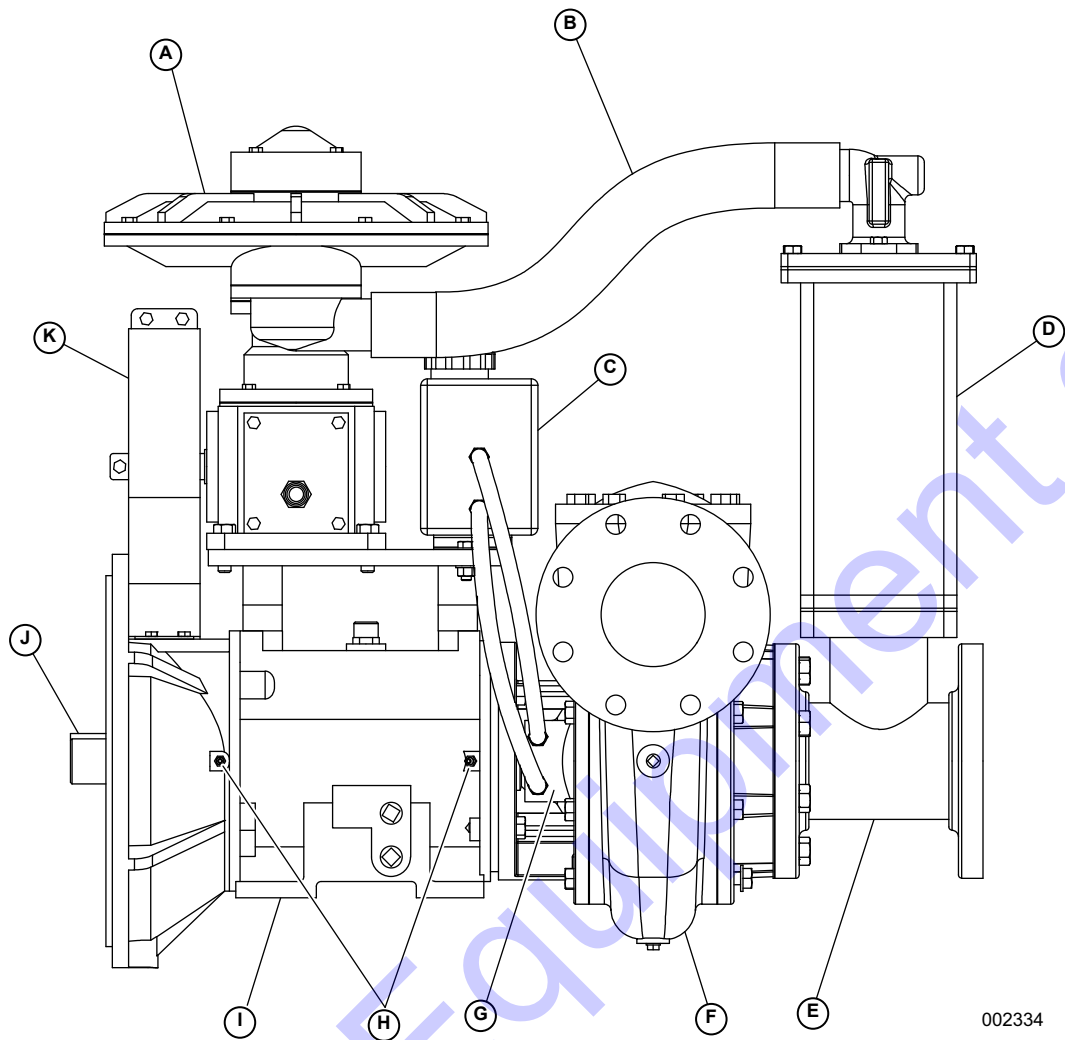

Figure 2-6. Diaphragm Vacuum Pump Components - Left Side (4 Inch Shown)

- | | | | |
|----|-------------------------------|----|-------------------------------|
| A. | Diaphragm vacuum pump | G. | Run dry gland |
| B. | Air discharge hose | H. | Grease fittings |
| C. | Mechanical seal oil reservoir | I. | Frame |
| D. | Priming chamber | J. | Shaft and Drive end shaft key |
| E. | Suction spool | K. | Belt and guard |
| F. | Volute | | |

Trailer Tongue Preparation for Use

If the unit is shipped with the trailer tongue in the upright position, follow the steps below to lower the tongue.

1. See **Figure 2-7**. Move the front jack from the tongue to the location shown and lower the jack.
2. Lower the rear jacks to prevent the unit from tipping backwards during procedure.

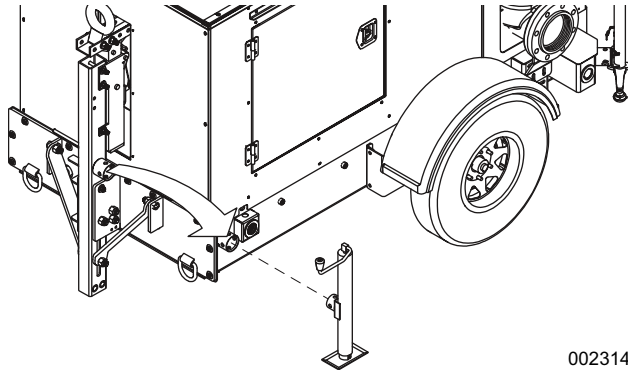

Figure 2-7. Install Tongue Jack

3. See **Figure 2-8**. Loosen but do not remove the nylon lock nuts on bolts **A** and **B**.
4. Remove the lower bolt and nylon lock nut securing the tongue braces to the tongue (**C**).

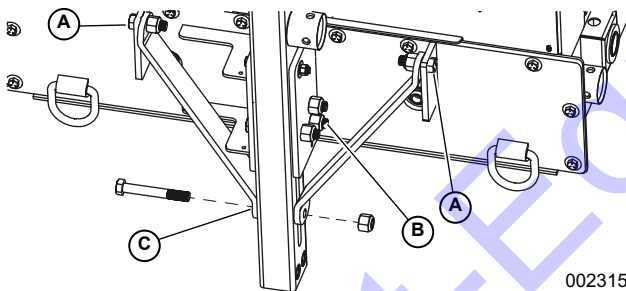

Figure 2-8. Remove Lower Bolt

5. See **Figure 2-9**. Move the right tongue brace (**D**) upward to allow access and then remove the rear bolts and nylon lock nuts (**E**) as shown.

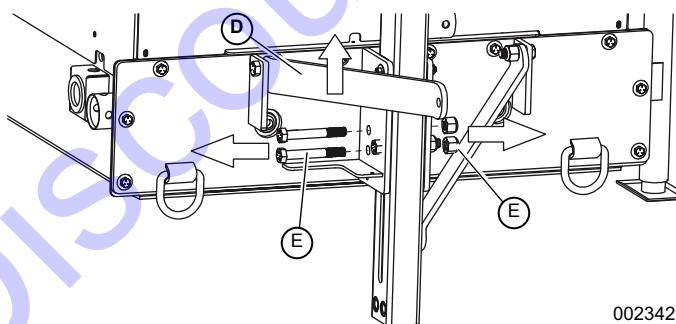

Figure 2-9. Remove Rear Bolts

6. See **Figure 2-10**. Remove the upper bolt, nut, and washers (**F**) to allow the tongue to pivot.

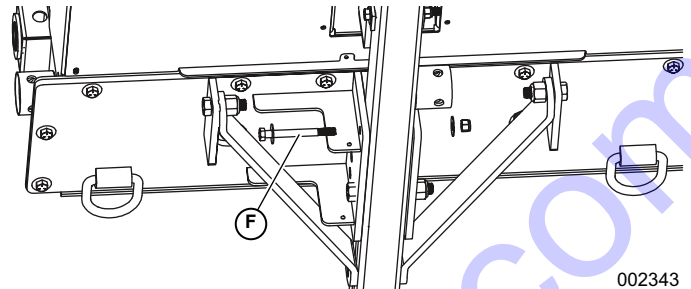

Figure 2-10. Remove Upper Bolt, Nut, and Washer

7. See **Figure 2-11**. Lower the trailer tongue and install bolts (**E**) removed in step 4 with **new** nylon lock nuts. Do not tighten until bolt (**G**) is installed and tightened.

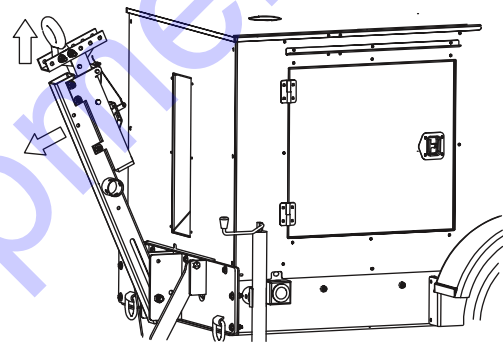

Figure 2-11. Lower Tongue

8. See **Figure 2-12**. Align the lower holes on the tongue braces with the slot in the tongue. Install the bolt with a **new** nylon lock nut (**G**). Tighten to 80-109 ft-lbs (108-148 Nm).
9. Tighten bolt (**E**) to 80-109 ft-lbs (108-148 Nm).
10. Install the upper bolt, nut, and washers (**F**) in the hole near the top of the tongue mounting bracket. The bolt should be snug against the bracket.
11. Tighten the nylon lock nuts on bolts **A** and **B** to 80-109 ft-lbs (108-148 Nm).

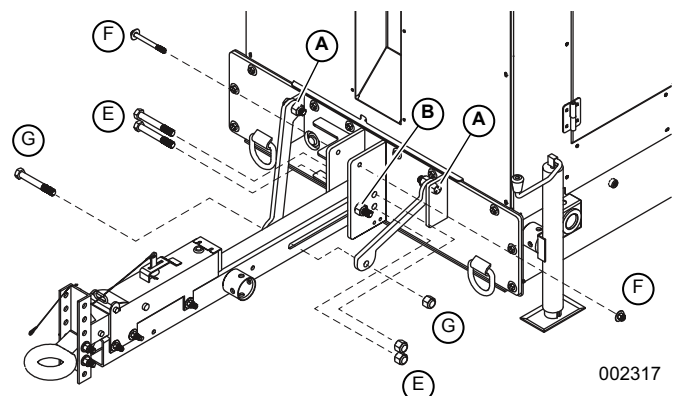

Figure 2-12. Install Fasteners

Hood Operation

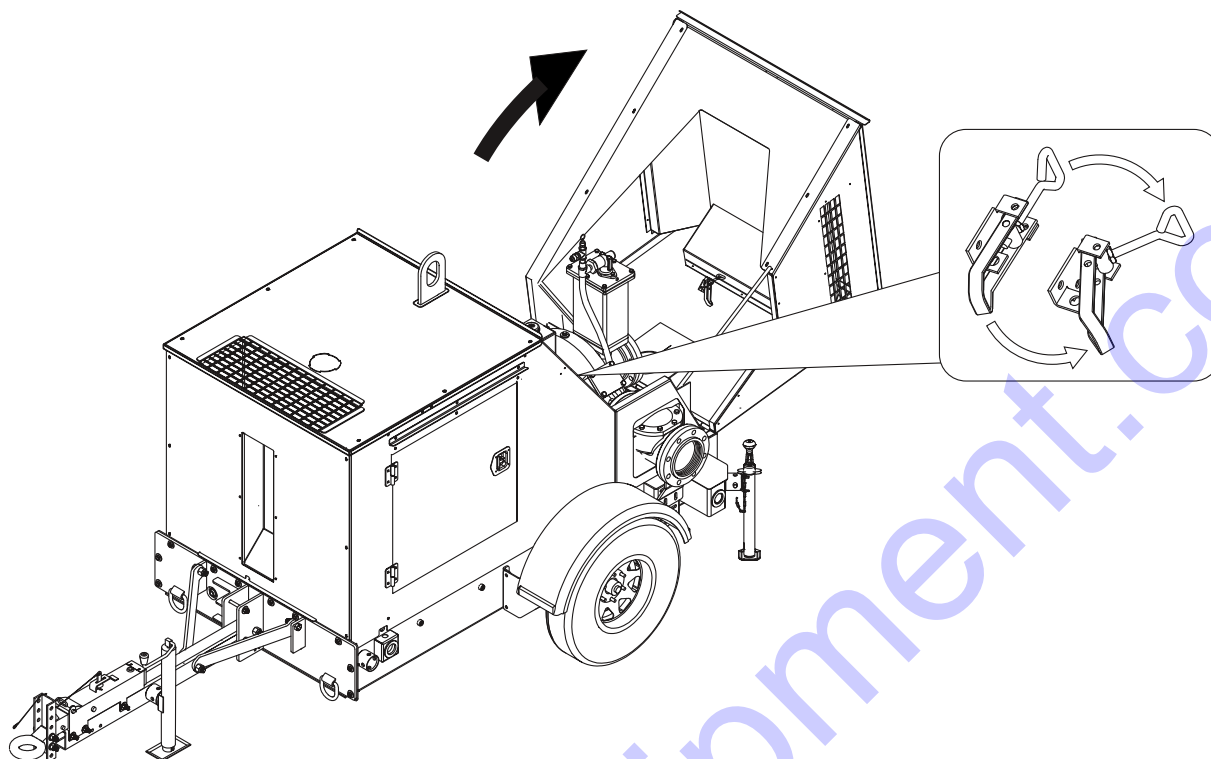

Figure 2-13. Hood Latches

002312

NOTE: Pump enclosures are optional.

To open the rear hood:

1. Verify there is proper clearance to accommodate swing of hood to the full-open position.
2. Release hood latches.
3. Stand at the rear of the unit and firmly grasp the handle at the rear of the hood and slowly tilt the hood rearward until fully open.

To close the rear hood:

1. Verify all contact surfaces for hood are clean of debris.
2. Stand at the rear of the unit and firmly grasp the handle at the rear of the hood and slowly tilt the hood forward until fully closed.
3. Verify hood has fully seated and secure the hood latches.



WARNING

Pinch Point. Hood could slam shut. Keep hands and fingers clear. Failure to do so could result in death or serious injury.

(000267)

NOTE: Pump hoods are heavy. Use caution when opening or closing.

Welding on Equipment with Electronic Controls

Proper welding procedures are required to avoid damage to electronic controls, sensors and associated components. The component should be removed for welding if possible.

The following procedure must be followed if the component must be welded while installed on equipment with electronic controls. This procedure will minimize the risk of component damage.

NOTE: Do not ground the welder to electrical components such as the control ground or sensors. Improper grounding can cause damage to electrical components. Clamp the ground cable from the welder to the component being welded. Place the clamp as close as possible to the weld to reduce the possibility of damage.

1. Stop the engine. Turn the Key switch to the OFF position.
2. Disconnect the negative (-) battery cable from the battery.
3. Open any installed Battery Disconnect switch.
4. Unplug the control system if possible.
5. Connect the welding ground cable as close as possible to the area to be welded.
6. Protect the wiring harness from welding debris and splatter.
7. Use standard welding methods to weld the materials.

Section 3 Operation

Control Panel Operation

Turning the Key switch to the RUN position energizes the ECU (Engine Control Unit), illuminates all LED indicators (A) once, and displays a startup screen while a self test is performed. If the display beeps for longer than one second, it indicates a self test fault. Users can attempt to rectify the fault by restoring factory defaults. Refer to the [Configuration Menu](#) for details.

Refer to the [Troubleshooting](#) for fault troubleshooting information. Contact Generac Mobile Products for assistance if the fault persists.

After the startup screen is cleared, the display shows readings on its virtual gauges. Initially the analog gauges are displayed, but the display uses the last displayed screen on subsequent startups. Refer to [Preferred Screen Store](#) for details.

If the ECU is preheating when the Key switch is turned to the RUN position, the Preheat LED is illuminated. Preheat time varies with atmospheric and engine conditions. After Preheat LED extinguishes, the crank the engine by turning and holding the Key switch in the START position until the engine starts.

LED Indicators

Auto Standby LED (Green)

A solidly illuminated Auto Standby LED indicates the Key switch is in the AUTO START position and the system is ready to start.



Preheat LED (Amber)

A solidly illuminated Preheat LED indicates the engine is preheating. When the LED extinguishes, the preheat period is complete and the engine may be cranked.

NOTE: The CANplus display only reports when the ECU is requesting preheat. Cold starting aids may not be installed in all engine configurations.



Engine Stop LED (Red)

A solidly illuminated Engine Stop LED indicates the ECU has stopped the engine due to a fault.

NOTE: ECU programming determines the response to warnings and failures. Typically the ECU can be programmed to shut down, derate, or run to failure. The CANplus display only displays ECU reported conditions.



Warning LED (Amber)

A solidly illuminated Warning LED indicates a warning reported by the ECU.

NOTE: The Warning LED is not used in Mechanical Governor mode.

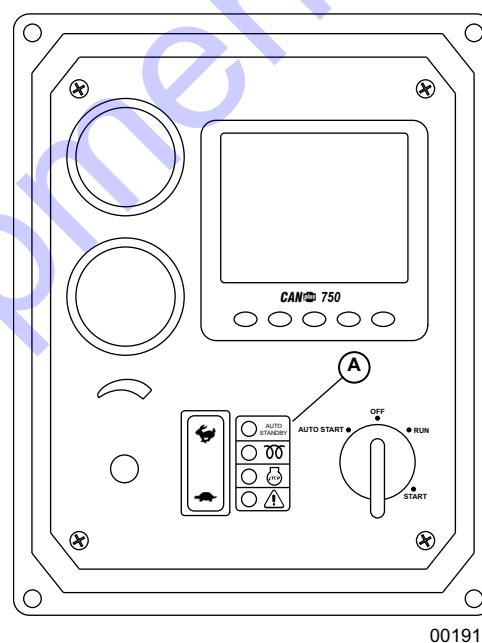

Figure 3-1. Control Panel

Throttle Control

The type of throttle operators installed, along with the configured values of minimum requested RPM, idle RPM, intermediate RPM, run RPM and maximum requested RPM, determine throttle operation. The engine speed can be adjusted above run RPM and below idle RPM, but the requests can not fall below the set minimum requested RPM or above the set maximum requested RPM. The ECU determines how the engine responds to the throttle requests and will not allow the engine speed

to fall below the ECU minimum or exceed the maximum RPM.

NOTE: To change the minimum requested RPM and maximum requested RPM settings, contact Generac Mobile Products, LLC.

Ramp Throttle (Speed Control Switch)

The standard ramp throttle uses a momentary rocker switch to adjust the requested engine speed. When first started, the requested engine speed is Idle RPM. Pressing and releasing the Rabbit icon increases the speed requested by 25 RPM. Pressing and holding the Rabbit icon causes the speed to accelerate to full speed in a few seconds. Similarly, pressing the Turtle icon decreases the requested speed.

Automatic START and STOP

The pump can be configured to start automatically by adding dry-contact closure float level switches. Verify that the dry-contact closure float switch harness is connected to the port on the back of the control box. Contact the Generac Mobile Products, LLC Technical Service Department at 1-800-926-9768 for more information.

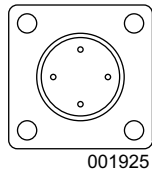

Turning the key switch to AUTO START causes all LEDs to illuminate. While a self test is performed, the AUTO STANDBY indicator is illuminated and the startup screen is displayed. After the startup screen is cleared, the display shows the transducer reading and switch status on the Transducer/Switch gauge. All other CANbus values will show since the ECU is not energized at this time. After one minute, the display is powered down to reduce battery drain. The automatic start and stop system is still function-

ing as indicated by the Auto Standby LED.

For electronically governed units, once the configured automatic start condition exists, the display powers up, the panel starts the engine and follows the throttle control profile configured (see *Figure 3-2*). The flexible throttle profile includes various speeds and times for a variety of scenarios. See *Autostart Menu*.

Single switch mode allows reliable operation with a single switch. Dual switch operation allows greater hysteresis when needed.

The transducer input supports simple start and stop operation by level or pressure and maintenance modes with speed modification.

- Programmable high and low set points control start and stop operation.
- Level maintenance modes monitor the operating point and adjust the engine speed to match the targeted set point with configurable aggressiveness.
- Dual switch inputs can be combined with the transducer input for redundant safety to protect against transducer sensor clog or failure.

When the configured stop conditions exist, the panel reduces the engine speed per the throttle profile and stops the engine. If the configured start conditions exist before the shutdown process is complete, the engine will return to the previous speed until the stop condition exists.



WARNING
Accidental Start-up. Do not configure the control panel with the key turned to AUTO START. The equipment could start suddenly, which could result in death or serious injury. (000269)

Configure the control panel with the key in RUN.

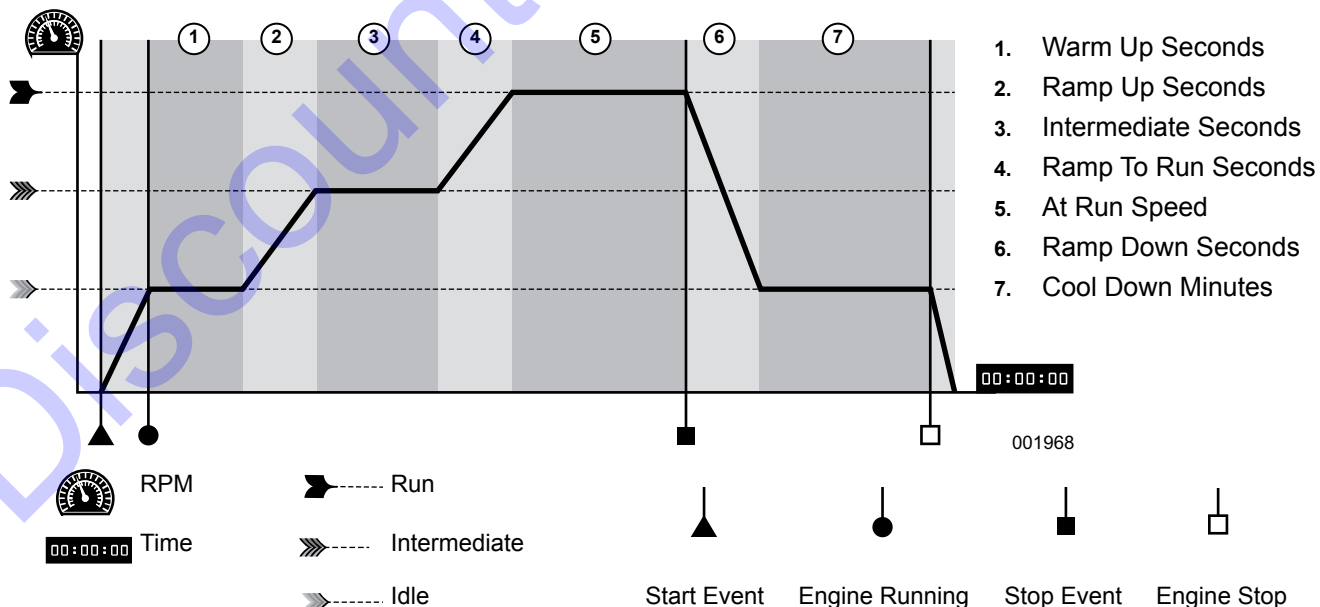

Figure 3-2. Throttle Control Profile

Start and Stop Events

The start and stop events are determined by the combination of START and STOP mode and function.

Start and Stop Modes:

Single Switch

Switch one controls automatic operation.

Dual Switch

Both switch inputs control automatic operation.

Transducer

Transducer input controls automatic operation.

Transducer & Switch

The transducer input controls automatic operation with dual switch mode as the backup. The switch inputs override the transducer if actuated when the transducer is not calling for an automatic cycle.

Start and Stop Functions:

Empty

Uses the selected mode to *reduce* the level or pressure.

Fill

Uses the selected mode to *increase* the level or pressure.

Maintain Out

Uses the transducer to maintain the level or pressure at or *below* the target.

Maintain In

Uses the transducer to maintain the level or pressure at or *above* the target.

Table 1 - Start and Stop Events

Mode ▼	Function ►	Empty	Fill	Maintain Out	Maintain In
Single Switch	Start	SW1 Close	SW1 Open	SW1 Close	SW1 Open
	Stop	SW1 Open	SW1 Close	SW1 Open	SW1 Close
Dual Switch	Start	SW1 and SW2 Close	SW1 and SW2 Open	SW1 and SW2 Close	SW1 and SW2 Open
	Stop	SW1 and SW2 Open	SW1 and SW2 Close	SW1 and SW2 Open	SW1 and SW2 Close
Transducer	Start	Above High Set Point	Below Low Set Point	Above High Set Point	Below Low Set Point
	Stop	Below Low Set Point	Above High Set Point	Below Low Set Point	Above High Set Point
Transducer & Switch	Start	Above High Set Point or SW1 and SW2 Close	Below Low Set Point or SW1 and SW2 Open	Above High Set Point or SW1 and SW2 Close	Below Low Set Point or SW1 and SW2 Open
	Stop	Below Low Set Point or SW1 and SW2 Open	Above High Set Point or SW1 and SW2 Close	Above High Set Point or SW1 and SW2 Close	Below Low Set Point or SW1 and SW2 Open

NOTE: When the switch inputs are the source of the start event in Transducer & Switch mode, only the switches will stop the engine.

Maintain Functions

The Maintain In and Maintain Out functions adjust the engine speed to keep the transducer level at the Target Set Point. The Servo Gain adjusts how aggressively the throttle is adjusted while the Servo Delay controls how often the throttle is adjusted.

NOTE: Maintain functions are only available in the Transducer or Transducer & Switch modes.

The direction of the throttle adjustment is dependent upon the selected mode as shown in the table.

Table 2 - Maintain Functions

Transducer State	Maintain Out	Maintain In
Above Target	Increase Speed	Decrease Speed
Below Target	Decrease Speed	Increase Speed

Dead Band

In some situations, the transducer level may fluctuate around the Target Set Point. To limit throttle hunting using the maintain functions, a dead band can be programmed. This value prevents throttle adjustment while the level is within the band (refer to *Figure 3-3*). In essence, the speed is considered to be at the target whenever it is within the dead band.

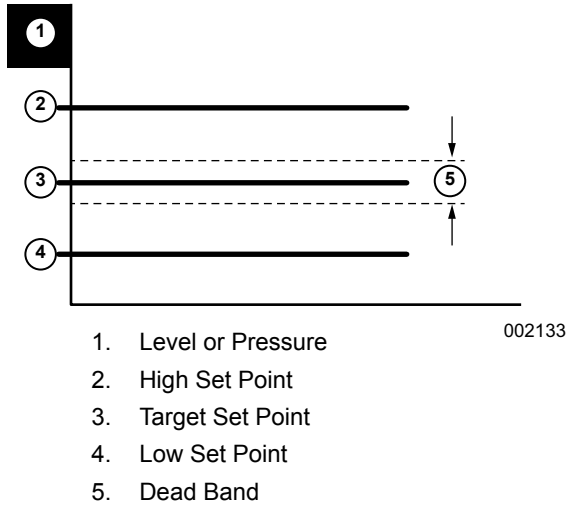

Figure 3-3. Dead Band Set Points

NOTE: The dead band entered is the amount above and below the target point. For example, if the target is 5.0 ft (1.52 m) with a 0.1 ft (.03 m) dead band, the dead band is 4.9 to 5.1 ft (1.49 to 1.55 m).

Digital Controller

A graphical menu is displayed when any button from 1 to 4 of the five soft buttons is pressed. The menu structure uses icons to indicate the current function of each button. The menu disappears after five seconds of inactivity.

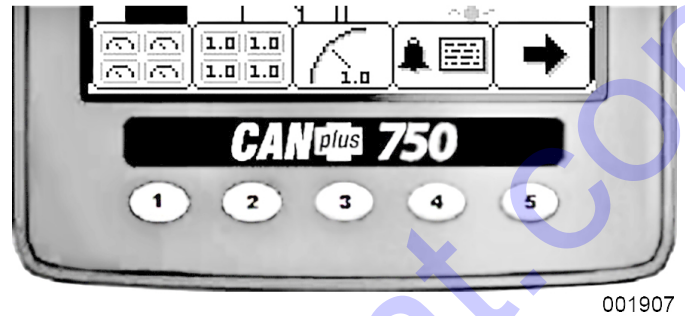

Figure 3-4. CANbus Soft Buttons

NOTE: Most problems with electronically controlled engines can be pinpointed via ECU diagnostic messages. Use the display or ECU diagnostic tool to view fault codes. Engine state information and diagnostic codes displayed by the CANplus display are provided via the CANbus.

Button Lock

The controller's five buttons can be locked so the operator does not accidentally change settings or access another display mode. Button Lock is enabled by pressing and holding buttons 1 and 5 simultaneously for one second. Repeating this operation restores normal button operation.

Button 1	Button 2	Button 3	Button 4	Button 5
Analog Gauge Pages	Digital Gauge Pages	Single Analog Gauge	Active Alarm Page	Gauge Adjust
Press repeatedly to cycle through four pages of analog gauges (16 total)	Press repeatedly to cycle through four pages of digital gauges (16 total)	Press repeatedly to cycle through available analog gauges	Displays active alarms with description	Configures the parameters displayed by gauge pages. (Quad Adjust must be enabled.)

Figure 3-5. Digital Controller Button Menu

Analog Gauge Pages

Analog Gauge Pages provide four independent pages of analog gauges. To enable Analog Gauge Pages, press any of the first four buttons to show the top level button bar and then press button 1 . Alternate pages are selected by repeated pressing of button 1. The four standard gauge pages are shown in [Figure 3-6](#).

NOTE: Engine Hours are displayed as a digital value even on Analog Gauge Pages. The default gauge pages represent 13 selections since the tachometer is repeated in the upper right quadrant of each page.

All 16 gauges may be configured by the user to create an application-specific view of CANbus data. Gauges on the current page can be changed via Adjust mode, accessed by pressing button 5  when the button bar is visible. Gauges can be changed on any of the four pages by selecting the page to be changed and then entering Adjust mode.

NOTE: Quad Adjust must be enabled to access the Adjust mode.

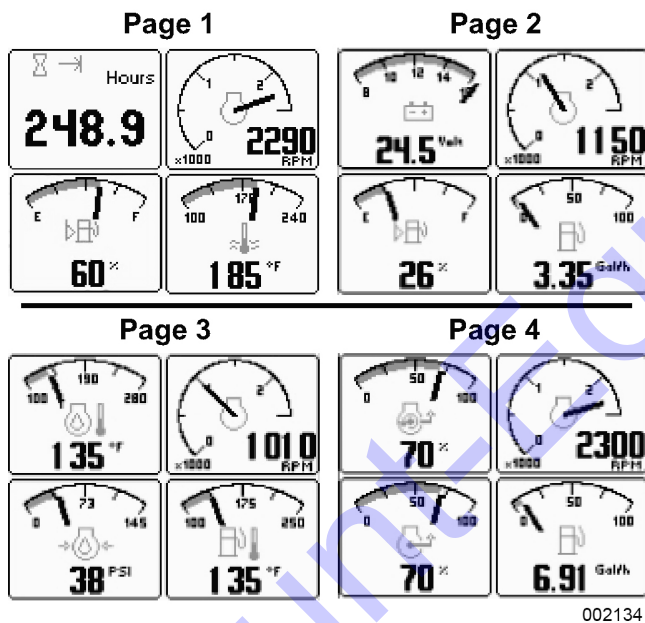







Figure 3-6. Analog Gauge Pages

In Adjust mode, a new button bar is displayed identifying the button functions. Button 1  corresponds to the upper left gauge, button 2  to the upper right gauge, button 3  to the bottom left gauge and button 4  to the bottom right gauge. Successive presses of the buttons selects a different parameter for the gauge. Adjust mode is exited by pressing button 5  and storing the new configuration even when power is removed.

NOTE: A gauge selection can only appear once per page. To move a gauge selection, the existing gauge location must be changed first. Gauge selections are limited to the data currently being received. Analog Gauge Pages can be configured in Demo mode to select

any supported parameter. Refer to for a complete list of available parameters.

Adjust mode can be disabled in the Configuration menu (Quad Adjust - Off) to prevent accidental changes.

Digital Gauge Pages

Digital Gauge Pages display the same data as the Analog Gauge Pages but in digital only format. To enable Digital Gauge Pages, press any of the first four buttons to show the top level button bar and then press button 2 . Alternate pages are selected by repeated pressing of button 2. The four standard Digital Gauge Pages are shown in [Figure 3-7](#).

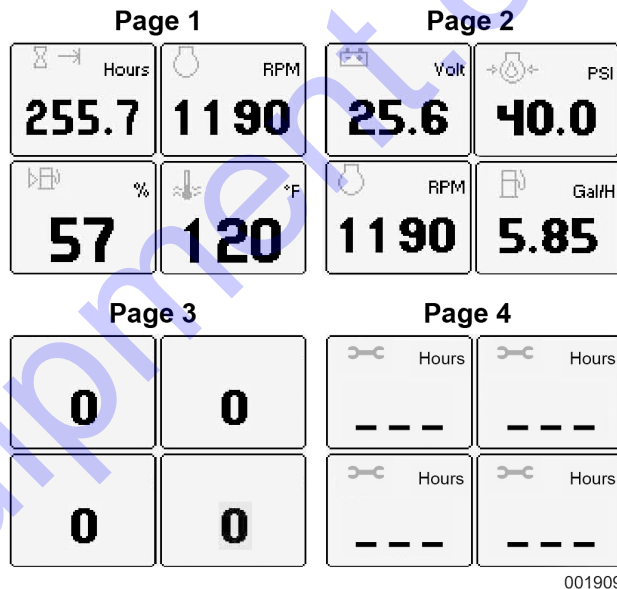



Figure 3-7. Digital Gauge Pages

NOTE: The 16 gauges are the same for Analog and Digital Gauge Pages. Adjustments in either Analog Gauge Pages or Digital Gauge Pages affect the same gauge in the other mode.

Single Analog Gauge

Single Analog Gauge uses the entire display for a single large analog gauge. This mode is enabled by pressing any of the first four buttons to show the top level button bar and then pressing button 3. The gauge displayed is selectable by repeatedly pressing button 3  while in the Single Analog Gauge mode while the menu bar is visible. The currently displayed gauge is stored when power is removed. Refer to [Preferred Screen Store](#).

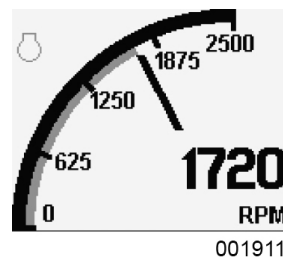

Figure 3-8. Single Analog Gauge

NOTE: Gauge selections are limited to the data currently being received.

Analog Transducer/Switch Gauge

The Analog Transducer/Switch Gauge displays the transducer value and the switch input states. The left column represents the values as a bar graph with a digital value displayed below. The right column shows whether the switches are open, represented by the pointer being down, or closed, represented by the pointer being up.

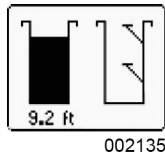

Figure 3-9. Analog Transducer/Switch Gauge

Digital Transducer Gauge

The Digital Transducer Gauge displays the transducer value as a digital only value. The switch state is not displayed on the Digital Transducer Gauge.

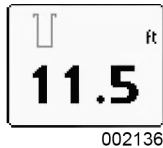

Figure 3-10. Analog Transducer/Switch Gauge

Active Alarms

A flashing pop-up window is overlaid on the current screen when an active alarm is received. The pop-up includes a description in addition to the standard SPN/FMI (Suspect Parameter Number/Failure Mode Indicator) pair defined by the SAE J1939 standard. Additionally, if enabled, the beeper sounds as an audible cue.

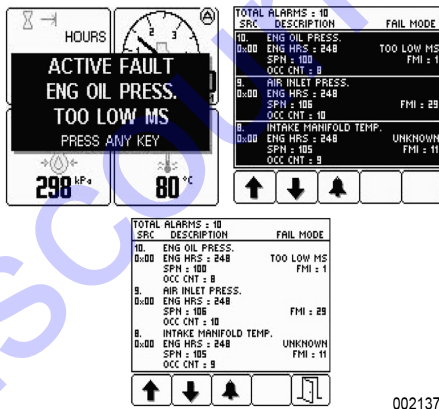

Figure 3-11. Active Alarms

The examples in Figure 3-11 are alarm list screens showing unacknowledged conditions and acknowledged alarms. After acknowledgment, the exit button becomes active.

NOTE: Standard J1939 abbreviations are used for alarms. MS = Most Severe, MOD= Moderately Severe, LS = Least Severe.

Refer to *Diagnostic Trouble Codes (DTS)* for more information on SPN/FMI codes.

Alarm List

To access the Alarm List, press any button while an alarm pop-up is displayed or pres any of the first four buttons to show the button bar and then press button 4. Alarms not yet acknowledged are shown in gray on black while acknowledged alarms are shown in black on gray (see Figure 3-11). The list also indicates when the alarm occurred if engine hours are available. The most recent alarm is displayed at the top of the list. The list can be scrolled using buttons 1 and 2 and alarms acknowledged by pressing button 3.

To close the Alarm List, press button 5 once the alarms are acknowledged.

An alarm indicator is displayed near the upper right corner of the display as long as alarms are active.

NOTE: Only active faults are displayed in the alarm list. Once a fault is corrected, it is automatically removed from the list. To view previously active faults, use the engine diagnostic tool.

Configuration Menu

The Configuration menu allows the user to set various operating parameters such as US or Metric units, scale limits for tachometer and service timers.

NOTE: Infrequently changed parameters and those parameters that typically need to be restricted, such as Maximum RPM, are accessible only through the CANplus Configuration. The CANplus Configurator is a Windows® PC program and a hardware adapter that allows total access to the parameters of the panel. For more information about the CANplus Configurator, please contact Generac Mobile Products.

The Configuration menu is entered by pressing and holding button 5 in any mode for at least three seconds. If PIN (Personal Identification Number or 'password') entry is enabled, the correct PIN must be entered to access the Configuration menu. The top level Configuration menu is displayed as shown (see Figure 3-12). Buttons 1 and 2 allow you to choose from Display, System, Autostart, Settings, Telemetry or Db Viewer. Pressing button 4 selects the chosen menu item indicated by bold text and the selection arrow. Each item is described in detail on the following pages. Settings are automatically stored when exiting the current menu even when power is removed.

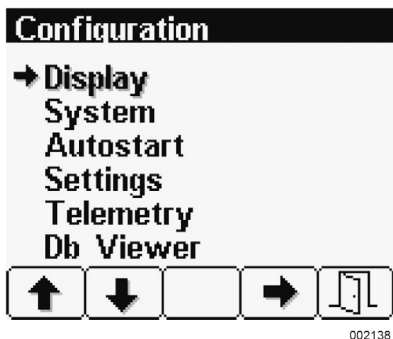

Figure 3-12. Configuration Menu

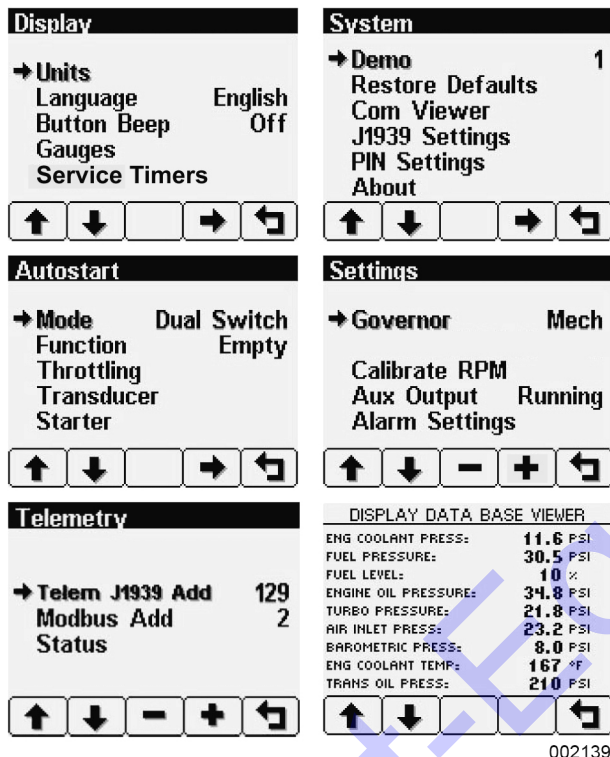

Figure 3-13. Configuration Menus

NOTE: Most configuration changes take effect immediately. Some, such as Idle RPM, take effect on the next power up.

Display Menu

The Display menu allows the user to configure items affecting how information is displayed.

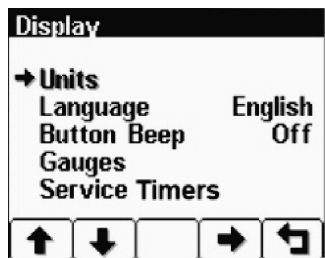

Figure 3-14. Display Menu

Units Menu

This menu allows the user to set the units used for speed, distance, pressure, volume, and temperature independently. Button 4 (right arrow) cycles through the available values for the selected item.

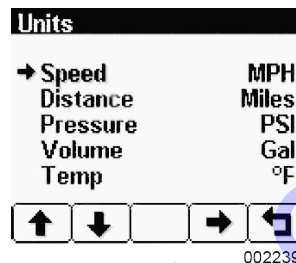

Figure 3-15. Units Menu

- Speed** MPH (miles per hour); km/h (kilometers per hour); Knts (knots)
- Distance** Miles; km (kilometers); NM (nautical miles)
- Pressure** PSI (pounds per square inch); bar (barometric units); kPa (kilopascals)
- Volume** Gal (US gallons); IGal (Imperial gallons); Liters
- Temperature** °F (Fahrenheit); °C (Celsius)

Language Menu

This menu allows the user to choose between English, Swedish, French, German, Spanish, Italian, Dutch and Portuguese. The currently selected value is indicated by the check mark . Button 4 (right arrow) selects the highlighted value.

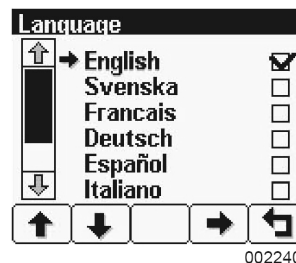

Figure 3-16. Language Menu

Button Beep

The soft buttons emit an audible beep when this item is On. Button beep is disabled by setting this item to Off. The audible beep still sounds when an alarm occurs. Button 4 (right arrow) cycles between On and Off.

Gauges Menu

This menu allows the user to configure aspects of the gauges displayed. Button 3 (left arrow) selects the previous value while button 4 (right arrow) selects the next value of the highlighted item.

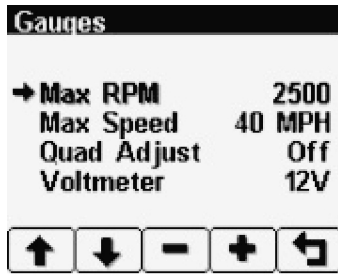

Figure 3-17. Gauges Menu

Max RPM

Sets the full scale RPM indicated by the tachometer gauge.

RPM 2500, 3000, 3500, 4000, 4500, 5000, 6000, 7000, 8000, or 9000

Max Speed

Sets the full scale speed indicated by the speedometer gauge.

MPH	15, 20, 25, 30, 35, 40, 45, 50, 55, 60, 70, 75, 80, 85, 95, or 100
km/h	20, 30, 40, 50, 60, 70, 80, 90, 100, 110, 120, 130, 140, 150, or 160

Quad Adjust

Allows the user to disable Adjust mode of the Analog and Digital Gauge Pages. Button 3 disables while button 4 enables Quad Adjust. Disabling Adjust mode locks the current gauge configuration and prevents the operator from accidentally changing the gauge configuration.

Voltmeter

Leave setting at the 12V factory default. (24V is not available on this unit.)

Service Timers

Sets the 16 service timers used to alert operator of needed maintenance and resets the service timer. Setting the service interval to 0 disables the timer and the word Off is displayed.

Pressing button 4 allows adjusting the selected service timer.

Button 1 decreases the service interval time while button 2 increases the service interval time in 10 hour increments. Holding button 3 for approximately three seconds resets Next Service In to the current service interval. The service timer descriptions can be changed using the CANplus Configurator.

The message is displayed on each power up until the elapsed timer is disabled or reset.

NOTE: It is not possible to set the service timers if engine hours are not being received by the display

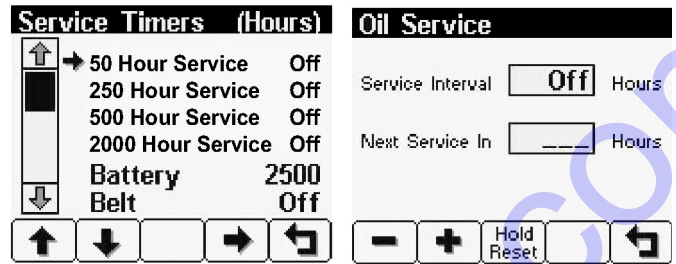

Figure 3-18. Service Timers Menu

System Menu

The System menu allows the user to configure items affecting how the system functions. Button 4 cycles through the available values for the selected item.

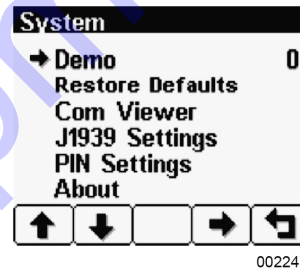

Figure 3-19. System Menu

Demo

The display supports several demo modes to operate with simulated data. Mode 1 simulates speed data and engine parameters. Mode 2 only simulates engine parameters. Mode 3 simulates speed data, engine parameters, and alarms. Mode 0 disables Demo mode. Demo is automatically set to 0 (Off) if live data is received.

Restore Defaults

This allows resetting of all configuration information to default US or Metric units. Additionally, the display is reset to the initial configuration.

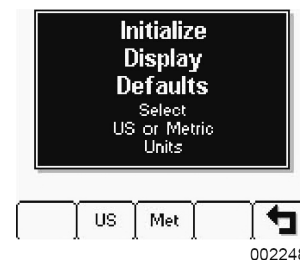

Figure 3-20. Restore Defaults Menu

The default settings are:

Setting	US	Metric
Language	English	
Button Beep	On	
Service Timers	Off	
Display Mode	Analog Gauges	
Gauge Pages	Defaults	
Quad Adjust	On	
Demo Mode	0 (Off)	
Engine Source	0	
Display CAN Address	40	
Alarm Filter	Glb	
SPN Version	1	
Speed Source	Auto	
PIN Entry	Off	
PIN	1111	
Max Gauge RPM	2500	
Max Gauge Speed	40 MPH	60 km/h
Speed Units	MPH	km/h
Distance Units	Miles	km
Pressure Units	PSI	kPa
Volume Units	Gal	l
Temperature Units	°F	°C

Com Viewer

Displays CANbus data received and engine configuration transmitted by the ECU.

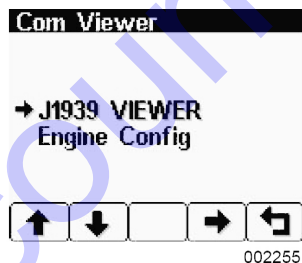

Figure 3-21. Com Viewer Menu

J1939 Viewer

This screen provides a hexadecimal dump of the messages received on the CANbus. This viewer displays the raw data. To see the decoded data, use the Db Viewer.

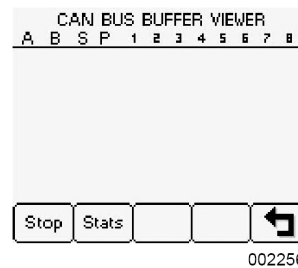

Figure 3-22. J1939 Viewer Menu

Button 1 (Stop) freezes the display while button 2 (Stats) shows the CANbus data statistics screen.

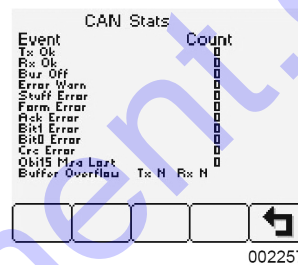

Figure 3-23. J1939 Viewer Menu

Engine Configuration

This screen displays the engine configuration information received from the ECU. Button 2 (right arrow) selects the next page of engine configuration while button 1 (left arrow) selects the previous page.

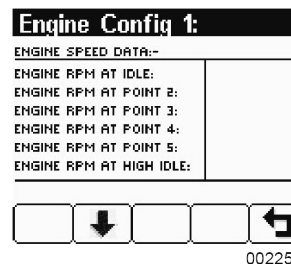

Figure 3-24. Engine Config Menu

J1939 Settings

This screen allows adjustments specific to the J1939 data link.

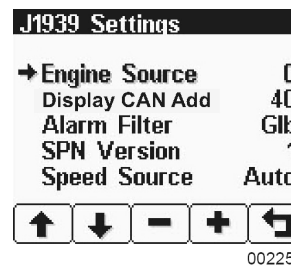

Figure 3-25. J1939 Settings Menu

Engine Source

Selects which source the display listens to for gauge data. Every device on a J1939 network has a unique address (in the range 0-254) to which the display can choose to listen. The display listens to a single data source; usually the ECU at address 0.

NOTE: Incorrectly configuring the Engine Source address will result in no data available for display.

Display CAN Add

The default display has the unique address of 40, the recommended address for single engine setups.

NOTE: Incorrectly configuring the Display CAN Address can result in data collisions on the CANbus.

Alarm Filter

This setting specifies whether the display will display alarms from all sources (*Glb* or global) or only the source address specified in the “Engine Source” setting (*Src* or source).

SPN Version

Selects the default SPN (Suspect Parameter Number) conversion method version automatically.

NOTE: Selecting the wrong version will cause alarm data to be displayed incorrectly.

Speed Source

There are three sources of speed data the display can decode. The settings for this parameter are Auto, NMEA, Wheel, Nav, and Off. Auto prioritizes the sources (highest to lowest); NMEA, Wheel (PGN 65265), Nav (PGN 65272). The selection can be forced to one of the available sources by selecting it explicitly. Selecting Off stops the display listening to any source of speed data.

PIN Settings

By default, PIN (Personal Identification Number) security is disabled. The user is prompted to enter a PIN every time the Configuration menu is accessed after this feature is enabled.

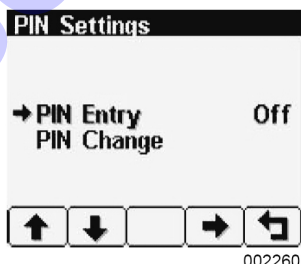

Figure 3-26. PIN Settings Menu

PIN Entry

This menu allows the user to turn PIN Entry on or off. To enable the PIN Entry feature, select PIN Settings and press button 4 to enable. As a security feature, a default pin number must be entered. Contact Generac Mobile Products to obtain the number. Once the PIN has been entered, the feature is enabled. PIN Entry is disabled by setting PIN Entry to Off.

The digits of the PIN are entered by using the buttons corresponding to the digits of the PIN.

Button 1 adjusts the first digit of the PIN. Button 2 adjusts the second digit, button 3 the third digit and button 4 the fourth digit. The PIN is entered using button 5 .

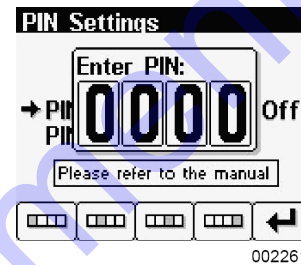

Figure 3-27. PIN Entry

PIN Change

This allows changing of the PIN. The user is prompted for the current PIN.

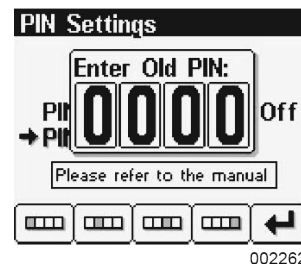

Figure 3-28. PIN Change - Old PIN

The user is prompted for the new PIN.

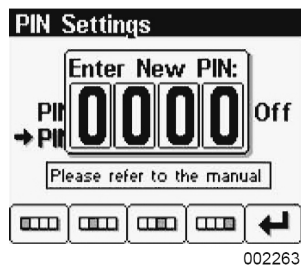
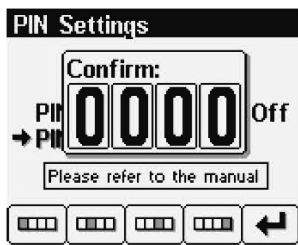

Figure 3-29. PIN Change - New PIN

The new PIN must be confirmed before the PIN is changed.



002264
Figure 3-30. PIN Change - Awaiting Confirmation

If the new PINs match, a confirmation screen is displayed.

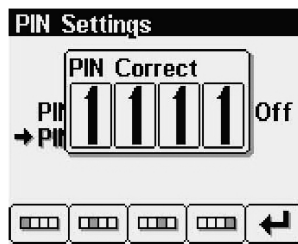

002265
Figure 3-31. PIN Change - Confirmed

If the two PINs do not match, an error message is displayed and the PIN is unchanged.

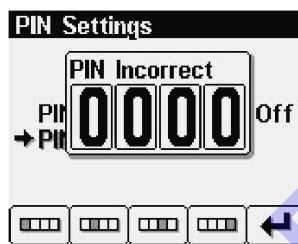

002266
Figure 3-32. PIN Change - PIN Incorrect

IMPORTANT NOTE: If the PIN is changed from the default and the new PIN is lost, the configuration mode will not be accessible. Clearing the PIN requires returning the display to LOFA Industries Inc. for service.

About

Displays the following product information:



002267
Figure 3-33. About Menu

JOB	N/A
CONFIG	Generac programmed controller part number
ADAPTER	Last adapter serial number used to program the controller
VERS	Software version number
PRODUCT	Controller model name
RUN TIME	Hours the unit has been run

NOTE: This screen can not be exited until the checksum calculation is complete. Checksum calculation takes approximately 10 seconds and is complete when the checksum value changes from “Calculating”... to a hexadecimal value such as 0x704E – OK.

Autostart Menu

This submenu allows the user to configure automatic start/stop operation. Refer to *Automatic START and STOP* for more information.

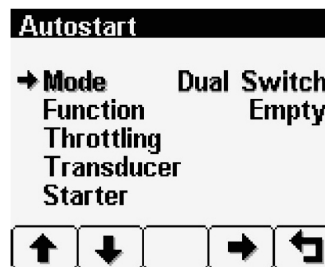

002268
Figure 3-34. Autostart Menu

Mode

This menu selects the basic automatic start and stop operation mode. Button 4 cycles between Single Switch, Dual Switch, Transducer, and Transducer & Switch.

Function

This menu selects the automatic start and stop function. Button 4 cycles between Empty, Fill, Maintain Out and Maintain In.

Throttling Menu

The throttling menu allows the user to configure throttle control. It also allows programming of the automatic start and stop throttle profiles as shown in *Figure 3-2*.

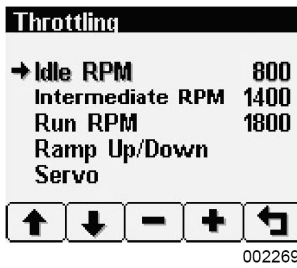

Figure 3-35. Throttling Menu

Idle RPM

Selects the RPM that the control system will request for idle speed. Idle can be set to compensate for parasitic loads such as hydraulic pumps or compressors. Idle RPM is the low speed setting of the optional two state or three state throttle switches.

NOTE: The minimum engine speed is set by the ECU. Requesting a lower speed causes the engine to run at the ECU minimum speed. RPM limits are programmed into the panel to limit the requested speed. Contact Generac Mobile Products for information on changing the panel minimum requested RPM and maximum requested RPM.

Intermediate RPM

Selects the RPM that the control system will request for intermediate speed. The intermediate speed can be used to prime pump or charge lines during automatic start and stop operation. Intermediate RPM is the middle setting of optional three state throttle switches.

NOTE: Setting the Intermediate RPM to the same speed as Idle RPM and Ramp to Run to zero seconds is effectively two speed automatic operation.

Run RPM

Selects the RPM that the control system will request for run speed. The run speed is the normal operating speed during automatic start and stop operation. Run RPM is the high speed setting of the optional two state or three state throttle switches.

Ramp Up/Down

This submenu configures the speed profile for automatic start and stop operation.

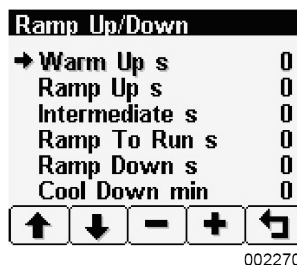

Figure 3-36. Ramp Up/Down Menu

Warm Up s

Selects the number of seconds to operate at idle speed before beginning the ramp to intermediate speed. The warm-up time begins when the starter is disengaged.

Ramp Up s

Selects the number of seconds to ramp from idle speed to intermediate speed after warm-up.

Intermediate s

Selects the number of seconds to operate at intermediate speed before ramping to run speed.

Ramp to Run s

Selects the number of seconds to ramp from intermediate speed to run speed after intermediate warm-up.

Ramp Down s

Selects the number of seconds to ramp from current speed to idle speed. The ramp down time begins when the automatic start and stop system detects a stop event.

Cool Down m

Selects the number of minutes to operate at idle speed after ramp down time. At the end of the cool down period, the engine will be stopped.

Servo

Configures the servo profile for autostart maintain modes.

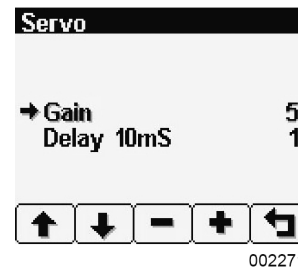

Figure 3-37. Servo Menu

Gain

Controls the aggressiveness of the maintain servo modes.

Delay 10mS

Controls how quickly the maintain servo mode responds to changes in level.

Transducer

This submenu configures the transducer type and set points.

Type

Selects between Level and Pressure CANplus Configurator.

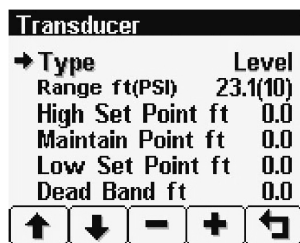

Figure 3-38. Transducer Type Menu

Range

Selects appropriate range for the transducer type.

High Set Point

For Empty and Maintain Out modes, sets the level that begins and autostart cycle. For Fill and Maintain In modes, sets the level that ends the cycle.

Maintain Point

Sets the target point for maintain modes.

Low Set Point

For Empty and Maintain Out modes, sets the level that ends an autostart cycle. For Fill and Maintain In modes, sets the level that begins a cycle.

Dead Band

Sets the amount of change from the target point required to alter the engine speed.

Starter

This submenu configures starter control options for auto-start.



Figure 3-39. Starter Menu

Restart Attempts

Selects the number of times to attempt restart.

Restart Delay Sec

Selects the number of seconds to wait before attempting a restart.

Start on Sec

Selects the maximum number of seconds the starter can be engaged.

Settings Menu

This submenu allows the user to configure CANplus hardware.

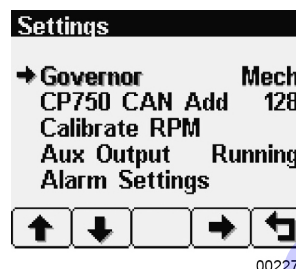

Figure 3-40. Settings Menu

Governor

Selects between Elect (electronically governed) and Mech (mechanically governed) engines modes. For mechanically governed engines, the CANplus I/O Board functions as an ECU, broadcasting engine parameters such as oil pressure and temperature on the CANbus.

NOTE: Switching governor modes requires cycling power before calibrating the RPM. The CANplus Configurator must be used to configure mechanical engine parameters.

CP750 CAN Add

Selects the address used by the display to communicate with the CANplus I/O Board. The default I/O Board address is 128.

NOTE: Engine data is always transmitted using address 0 in mechanically governed mode.

IMPORTANT NOTE: Incorrectly configuring the CP750 CAN Address prevents the display from receiving I/O Board data for the display menus and can result in data collisions on the CANbus.

Calibrate RPM

Calibrates the tachometer input for mechanically governed engines to allow the CANplus I/O Board to measure the engine speed. This signal may be provided by an alternator frequency tap, proximity switch. An optional amplifier/divider can be added for use with a magnetic pickup.

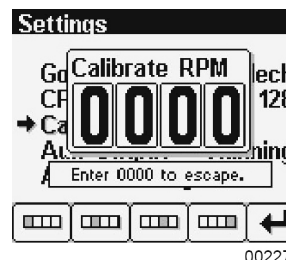







Figure 3-41. Calibrate RPM Menu

NOTE: Calibrate RPM is only available on mechanically governed engines. The RPM must be calibrated for automatic start and stop operation to function.

Crank the engine and measure the engine RPM with a hand-held tachometer. Select Calibrate RPM and enter the digits of the measured RPM using the buttons corresponding to the digits of the RPM. Button 1  adjusts the first digit of the RPM. Button 2  adjusts the second digit, button 3  the third digit, and button 4  the fourth digit. The RPM is entered using button 5 .

When the calibration is complete, the LEDs will begin a blinking sequence. The power must be cycled to continue configuration or operation.

Aux Output

Selects the Aux Output function and provides a one amp low side switch.

- Running** The output is active when the engine RPM exceeds 500 RPM.
- AS Armed** The output is active when the Key switch is in the Autostart position and the engine has not stopped due to a fault.
- At Speed** The output is active when the engine is at or above the operating RPM.
- Prestart** The output is prestart alarm activated 10 seconds before the engine automatically starts.

NOTE: The Aux Output is available on a connector in the I/O Board only. Changing the prestart alarm time requires using the LOFA Configurator.

Alarm Settings

Configures the set points for the transducer alarm messages. The alarm is transmitted as SPN 1083 with FMI 1 for a low alarm and FMI 0 for a high alarm.

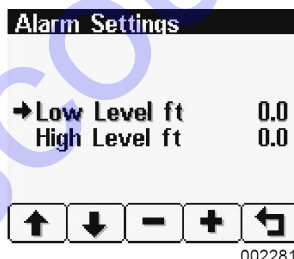

Figure 3-42. Alarm Settings Menu

Low Level ft

Sets the transducer low level alarm set point.

High Level ft

Sets the transducer high level alarm set point.

Telemetry Menu

This menu allows configuring the optional telemetry system.

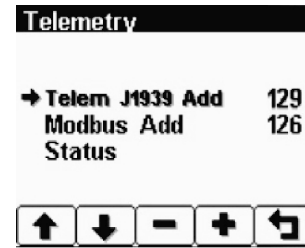

Figure 3-43. Telemetry Menu

Telem J1939 Address

Defines the address the telemetry module is using for CANbus communications.

NOTE: The display will be unable to communicate with the telemetry module if this address is incorrect.

Modbus Address

Selects the Modbus slave address the telemetry module will use for Modbus communications.

Status

Displays telemetry and modem status information retrieved from the telemetry module:

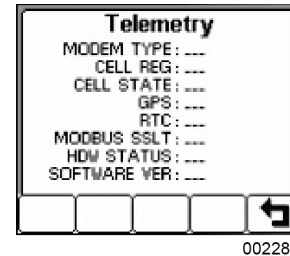





Figure 3-44. Status Menu

MODEM TYPE	Identifies the modem type
CELL REG	Identifies cell modem registration
CELL STATE	Indicates cell state and signal strength
GPS	Indicates GPS status
RTC	Indicates number of days since real time clock cellular update
MODBUS SSLT	Indicates Modbus slave status
HDW STATUS	Indicates various hardware status items
SOFTWARE VER	Indicates the version of software in the Messenger

DB Viewer

The Database Viewer displays and decodes all data monitored by the display. This diagnostic tool allows viewing data not normally displayed.

The list can be scrolled using buttons 1  and 2  and closed by pressing button 5 .

NOTE: The Database Viewer is always in English regardless of language selected.

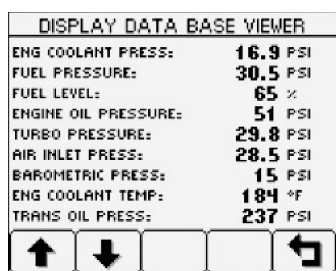

002290

Figure 3-45. DB Viewer Menu

Preferred Screen Store

The display automatically stores the current screen as the preferred screen after a delay of approximately 15 seconds. The display will use the last stored screen on the next power up.

NOTE: Selecting Restore Defaults restores the Analog Gauge Pages and default gauges.

Pop-Up Messages and Alerts

Service Required

Users can set up to 16 service timers in hours in the Configuration menu (refer to [Service Timers](#)). The Service Required pop-up is displayed at power up when one or more service timers has expired. Pressing any button removes the pop-up. If no button is pressed, the pop-up closes in approximately five seconds.

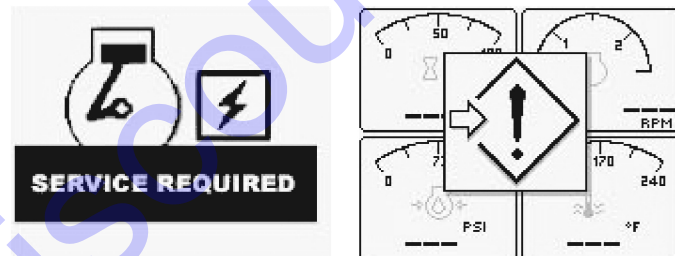

002286

Figure 3-46. Pop-up Warnings of Service Required and Data Communications Failure

Data Communications Failure



The Data Communications Failure pop-up icon flashes if the display does not detect data. The warning disappears and normal operation resumes once data is detected.

NOTE: Incorrectly configuring the Engine Source address will result in no data available for display.

Data Not Available

Gauges and the Db Viewer will display  if the desired data is not available. The display value returns to normal when parameter data is received.

Adjusting Lighting and Contrast

Pressing button 5 when there is no menu bar opens the lighting and contrast menu bar. The display has a number of backlighting levels, allowing the display to be read in the dark. The level is adjusted by pressing button 1 to decrease, or button 2 to increase  illumination. Contrast is adjusted in the same manner using buttons 3 and 4 .

NOTE: The display adjusts the contrast with ambient temperature. Manual contrast adjustments are only necessary with extreme climate change.

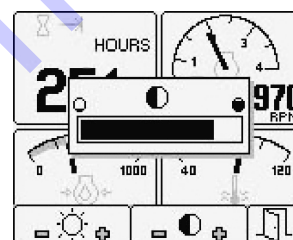

002289

























Figure 3-47. Lighting And Contrast Menu































Exit menu by pressing button 5 . The lighting and contrast settings are retained after the unit is powered off.

NOTE: If the contrast has been adjusted poorly, the factory setting is restored by pressing buttons 1 through 4 simultaneously. This action does not change other user-configured settings.

Data Parameters Monitored

This table lists the engine and transmission parameters that are monitored via the CANbus. The parameters can be displayed by the user-configurable gauge pages or the single analog gauge. DB is an abbreviation for the internal database which stores all data transmitted from the engine/transmission. The complete database can be accessed on the display via the DB Viewer in the Configuration menu.

Icon	Parameter	Gauge Pages	Single Gauge	Database
	Electrical Potential	●	●	●
	Battery Voltage, Switched	●	●	●
	Net Battery Current	●		●
	Alternator Voltage	●	●	●
	Alternator Current	●	●	●
Fuel (L, Gal, iGal) or (L/h, Gal/h iGal/h) or (km/L, MPG or IMPG)				
	Fuel Level	●	●	●
	Fuel Rate	●	●	●
	Fuel Temperature	●	●	●
	Instantaneous Fuel Economy	●		●
	Trip Fuel Economy	●		●
	Trip Fuel	●		●
	Trip Fuel Rate	●		●
	Total Fuel Used			●
	Fuel Leakage 1			●
	Fuel Leakage 2			●
Distance (km, Miles or Nmiles)				
	Distance Remaining	●		●
	Trip Distance	●		●
	Total Vehicle Distance	●		●
Pressure (kPa, PSI or bar)				
	Fuel Pressure	●		●
	Barometer Pressure	●		●
	Auxiliary Pressure 1	●		●
	Turbo Pressure	●	●	●
	Air Inlet Pressure	●		●
	Air Filter Differential Pressure	●		●
	Injector Metering Rail 1 Pressure	●		●
	Injector Metering Rail 2 Pressure	●		●
	Engine Coolant Pressure	●		●
	Engine Oil Pressure	●	●	●

Icon	Parameter	Gauge Pages	Single Gauge	Database
	Transmission Oil Pressure	●	●	●
	Clutch Pressure	●		●
	Air Start Pressure	●		●
	Injector Control Pressure	●	●	●
Temperature (°C, °F)				
	Engine Coolant Temperature	●	●	●
	Engine Intercooler Temperature	●		●
	Engine Oil Temperature	●	●	●
	Transmission Oil Temperature	●	●	●
	Turbo Oil Temperature	●		●
	Intake Manifold Temperature	●	●	●
	Air Inlet Temperature	●	●	●
	Exhaust Temperature	●	●	●
	Auxiliary Temperature 1	●	●	●
	Engine ECU Temperature			●
	Exhaust Gas Port 1 Temperature	●		●
	Exhaust Gas Port 2 Temperature	●		●
	Turbo Inlet Temperature	●		●
Percentage (%)				
	Acceleration Position	●		●
	Engine Oil Level	●	●	●
	Coolant Level	●	●	●
	Fan Speed	●		●
	Drivers Demand Percent Torque	●		●
	Actual Engine Percent Torque	●	●	●
	Percent Load at RPM	●	●	●
Speed (RPM, km/h, MPH or KTS)				
	Input Shaft Speed	●		●
	Output Shaft Speed	●		●
	Engine Speed	●	●	●
	Turbo 1 Speed	●		●
	Engine Desired Operating Speed	●		●
	Fan Speed	●		●
	Vehicle Speed	●	●	●

Icon	Parameter	Gauge Pages	Single Gauge	Database
Time (h)				
⌘ →	Total Engine Hours	●		●
⌘ ←	Trip Engine Hours	●		●
	Service Hours			●
Miscellaneous				
	Torque Converter Lock-Up Engaged			●
⌈	Transducer	●	●	●
F N R	Current Gear	●		●
F N R	Selected Gear	●		●
	CANTX Disable			●
	CANplus I/O			●

Pump Set Up

1. Disconnect the pump from the tow vehicle by turning the tongue jack handle clockwise to raise the tongue from the hitch.
2. Block the wheels to prevent the unit from rolling.
3. Disconnect all safety chains, surge brake cables, and the trailer wiring harness.
4. Lower the rear leveling jacks from the travel position. Turn the jack handles clockwise until the leveling feet are in firm contact with the ground. Adjust the jacks until the pump is as level as possible.
5. Attach fittings to both the intake and outlet openings of the pump, verifying they match the fittings on the hoses. Verify that a gasket/seal is in place between the pump volute and the flange on the attached fitting.
6. Tighten all hardware completely to maintain an airtight seal. Threaded fittings require the use of pipe thread sealant.
7. Attach a rigid hose/pipe to the intake (suction) side of the pump.

NOTE: For best performance, the suction hose/piping should be at least as large as the pump flange, never smaller.

NOTE: The pump should be at the highest point of the hose/piping.

NOTE: All suction piping and fittings should be checked for any foreign material (rocks, bolts, wire, etc.) and also any sharp burrs that could disrupt the flow.

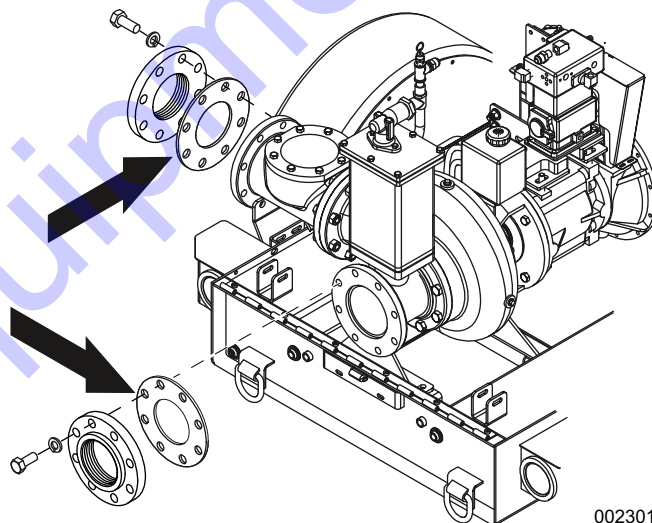

Figure 3-48. Pump Seals

NOTE: Verify the O-ring seal is present in the fitting on the pump before attaching the fitting. Lubricate the O-ring seal with grease to maintain an airtight seal.

NOTE: The suction and discharge pipe/hose material must be compatible with the liquid being pumped. Hoses used on a suction line must be of the reinforced type to prevent collapse under suction lift.

NOTE: If a manual shutoff valve is installed in the discharge line, it must be open during operation.

8. Attach a rigid intake screen or strainer to the end of the suction hose before placing it in the liquid. This will prevent large items or excessive trash from entering the pump housing.

NOTE: The intake screen must have enough openings to equal 28 sq. in. (181 sq. cm) or more (6 in. pump). The

screen should be rigid enough to prevent collapse when flow is reduced due to clogging.

9. Place the intake hose into the liquid to be pumped.

NOTE: The submergence of the suction pipe into the liquid should be at least four to five times the pipe diameter. If this is not possible, provide a baffle or a floating board. This is to prevent any vortex action from allowing air into the pipe/hose.

NOTE: For best performance, a bell mouth fitting is recommended.

NOTE: Recommended bell diameters and pipe submergences for various flows are shown in [Table 3](#). The table data is referenced from ANSI/HI 9.8-1998.



Equipment damage. Exceeding maximum suction lift height of pump could result in cavitation/damage to the pump.

(000268)

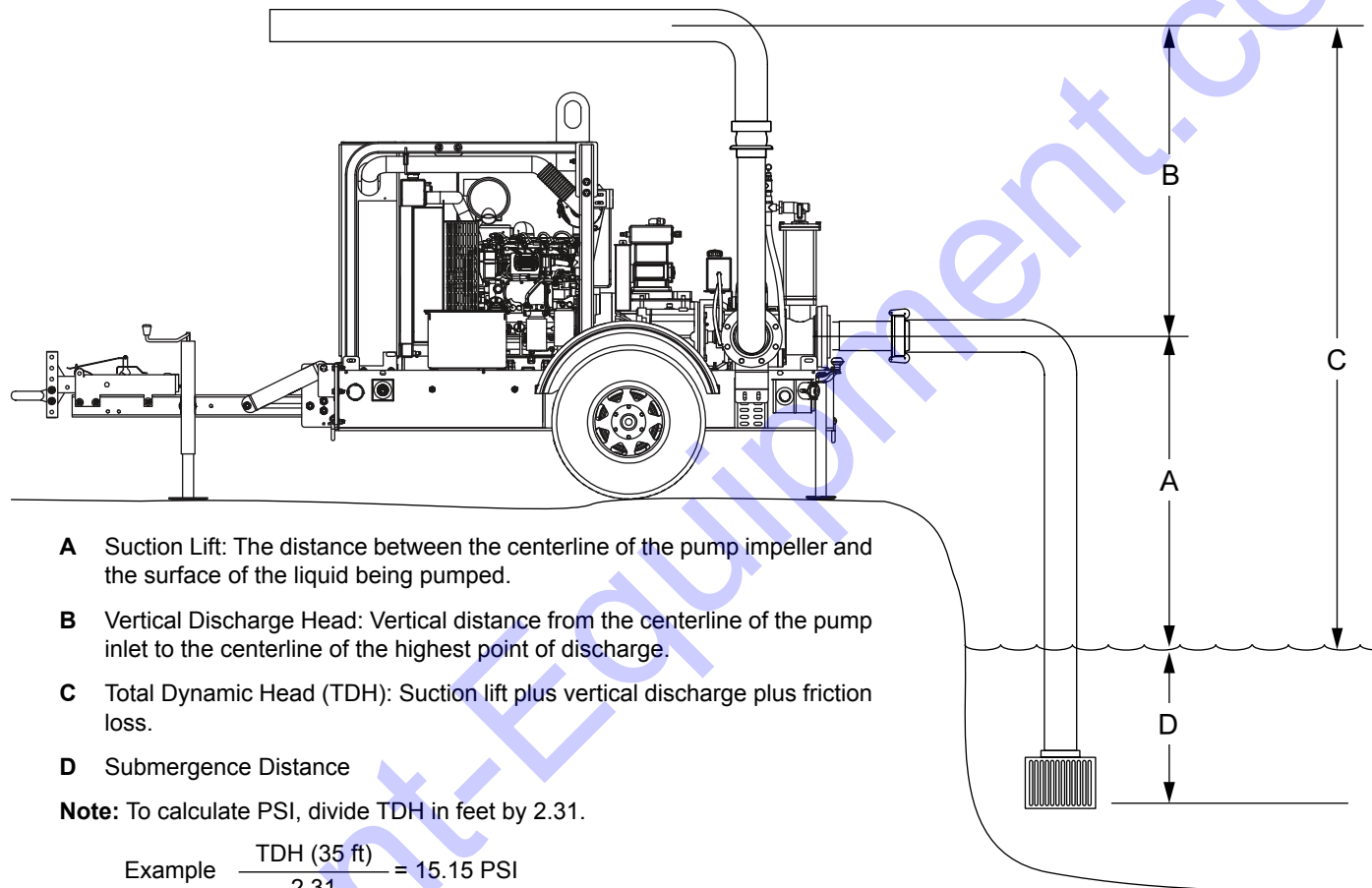

002302

Figure 3-49. Suction Specifications

Table 3: Pipe Submergences

FLOW (GPM)	500	1000	1500	2000	2500	3000	3500	4000	4500
SUMMERGENCE WITH BELL (FT)									
Bell Diameter (in)	6.1	8.6	10.6	12.2	13.6	14.9	16.1	17.2	18.3
Submergence (ft)	2.1	2.6	3.0	3.3	3.5	3.7	3.9	4.1	4.3
SUBMERGENCE WITHOUT BELL (FT)									
PIPE ID (in) - No Bell	SUBMERGENCE WITHOUT BELL (FT)								
3	4.7								
4	3.3	6.3							

Table 3: Pipe Submergences

FLOW (GPM)	500	1000	1500	2000	2500	3000	3500	4000	4500
6	2.1	3.7	5.3						
8	1.7	2.8	3.8	4.9	6.0				
10	1.6	2.3	3.1	3.8	4.6	5.4	6.1	6.9	7.6

10. Attach a flexible hose/pipe to the outlet (discharge) side of the pump.

NOTE: Verify the O-ring seal is present in the fitting on the pump before attaching the fitting. Lubricate the O-ring seal with grease to maintain an airtight seal.

11. Use a concentric taper on the discharge side to increase discharge pipe/hose diameters.

NOTE: All valving and additional fittings should be the same size as the discharge main-line. The discharge size should be adequate to maintain reasonable velocities and reduce friction losses. It is strongly recommended that a pressure relief valve is installed on the discharge piping.

12. Check the intake and outlet hoses for sharp bends or kinks that may restrict pump flow. The intake hose should slope upwards toward the pump to avoid development of air pockets in the hose, which may lead to pump cavitation. Keep the hoses as straight as possible.

Pump Pre-use Checkpoints

Before using the pump, check the following:

- Place the pump as close as possible to the liquid being pumped, keeping the number of hose sections and couplings to a minimum.
- The pump should be the highest point between the intake and outlet section of the suction hoses.
- Verify the ground is firm and as level as possible.
- Block the wheels on the trailer to keep it from moving.
- Check the pump discharge area; verify discharge will not erode the material under the pump or damage any nearby structures.
- Verify all hose couplings are of the same size and type.
- All hoses/piping should be supported, braced and lined up square before connecting to the pump flanges.
- A flexible fitting is recommended on both suction and discharge to eliminate misalignment loads or stresses being transmitted to the pump.

NOTE: Flexible pipe couplings must be restrained so as not to transmit any strain to the pump flanges when expanding or contracting under pressure. Unrestrained expansion fittings can transmit enormous forces to the pump flanges.



Equipment damage. Use recommended strainer to prevent debris from entering the pump. Failure to do so could result in equipment damage.

(000241)

Prestart Checklist

- Verify all fasteners at gasketed surfaces are properly tightened.
- Verify belts and couplings (shaft) are properly adjusted and aligned, and all guards are in place.
- Verify all protective covers and screens are in place.
- Verify pump drain is closed.
- Check the valves for proper position. If connecting to a system that has a discharge gate valve, start with the valve closed. The speed of opening depends upon the size and length of the discharge pipe and capacity of the pump. The valve should not be more than 0.25 in. (6.35 mm) open until the line is filled. This will reduce the possibility of a water hammer of shock if filling is too rapid.
- Verify all hose couplings, covers and plugs are tight.



Personal Injury. Verify all hoses are securely fastened. Failure to do so could result in death or serious injury.

(000272)

- Check the oil level in the mechanical seal oil reservoir bottle. Do not allow the bottle to run dry.
- For diaphragm vacuum pumps: Check the oil level in the sight glass located at the base of the assembly. Add oil if necessary.

CAUTION

Equipment damage. Verify proper type and quantity of oil prior to starting pump. Failure to do so could result in pump damage.

(000275)

- Check lip seal vent for leakage. The bearing oil and mechanical seal oil are each sealed by a shaft lip seal, and a vent to atmosphere exists between these two lip seals to indicate oil leaks from either cavity. If either the bearing oil or mechanical seal oil lip seals leak, oil will leak from the vent.

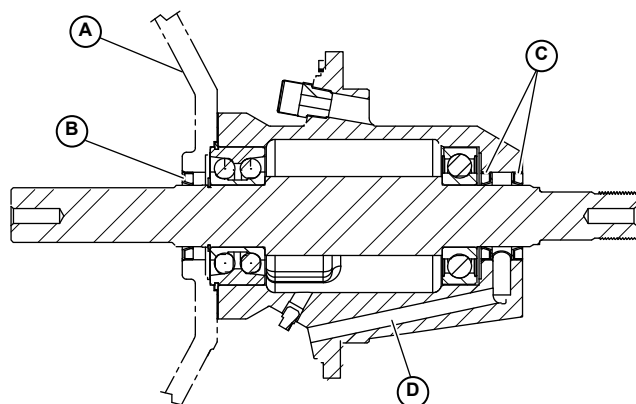

002303

- A. Engine Bracket
- B. Drive End Lip Seal
- C. Pump End Lip Seals
- D. Oil Leak Path

Figure 3-50. Lip Seals

- Check the engine oil level, coolant level and fuel level.
- Verify the battery is connected.
- Verify the Emergency Stop switch is pulled out (deactivated).

The unit is now ready for use.

Starting the Unit

1. Turn the key switch to the right RUN position. A startup screen will appear. After the startup screen is cleared, the display will show readings on virtual gauges.
2. Once the gauges appear, crank the engine by turning and holding the key switch in the start position until the engine starts. Refer to **Control Panel Operation** for details.
3. The pump should self prime and begin to discharge liquid within minutes.

NOTE: The pump may not prime immediately because the suction line must first fill with liquid. If the pump fails

to prime within five minutes, stop it and check the suction line for leaks.

NOTE: Refer to **Throttle Control** for information on adjusting the pump flow. Several factors can influence pump output:

- The temperature, viscosity, and amount of entrained solids in the liquid being moved.
- The length, diameter, and number of bends of the intake and outlet hoses.
- The total suction height (lift) of the pump.
- The altitude above sea level where the pump is operating.

WARNING

Personal Injury. Do not operate pump with flow completely restricted. Doing so could cause pump casing to explode and could result in death or serious injury.

(000273)

NOTE: As the pump operates, avoid sucking an air/liquid mixture into the intake side of the pump as this may cause the pump to cavitate, causing damage to the pump impeller. The intake hose must be kept 4-5 times the hose diameter (4-5 x 6 in. = 24-30 in. [4-5 x 15 cm = 60-75 cm]) below the surface of the liquid being pumped.

NOTE: Do not exceed the maximum recommended operating pressure for the pump.

Flow Rates

Use the following charts for approximate flow rates.

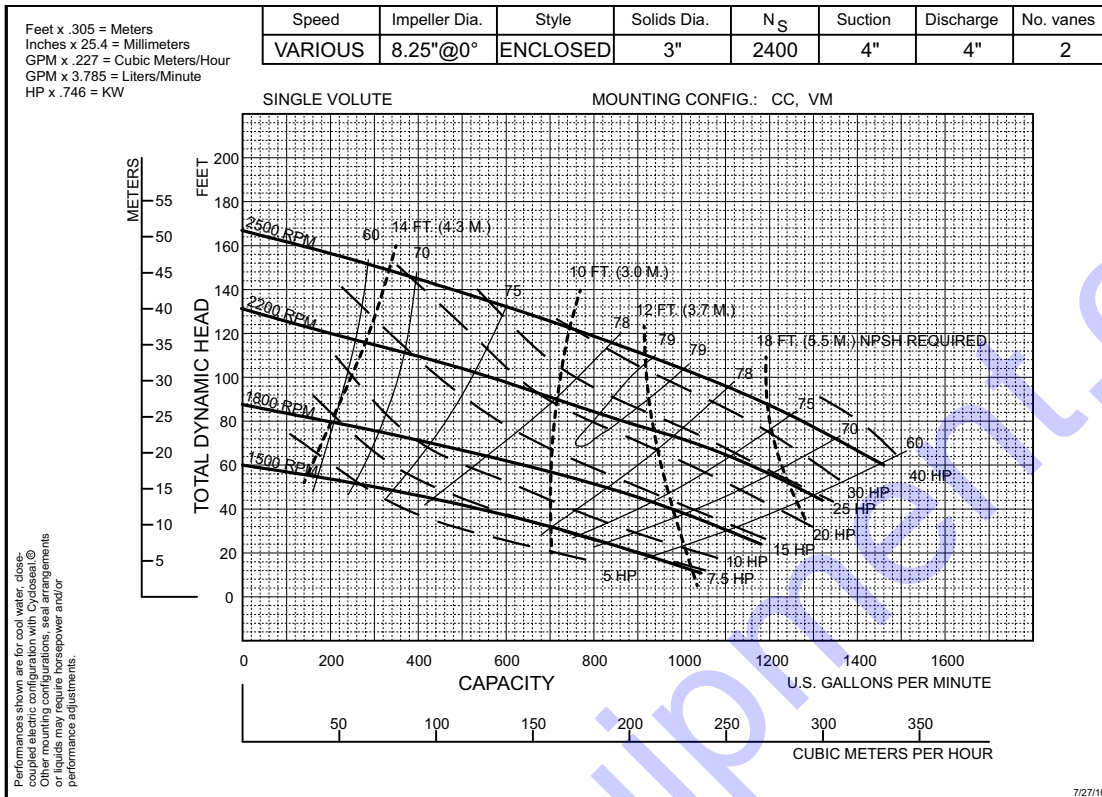

Figure 3-51. 4 Inch Pump Flow Rate Chart

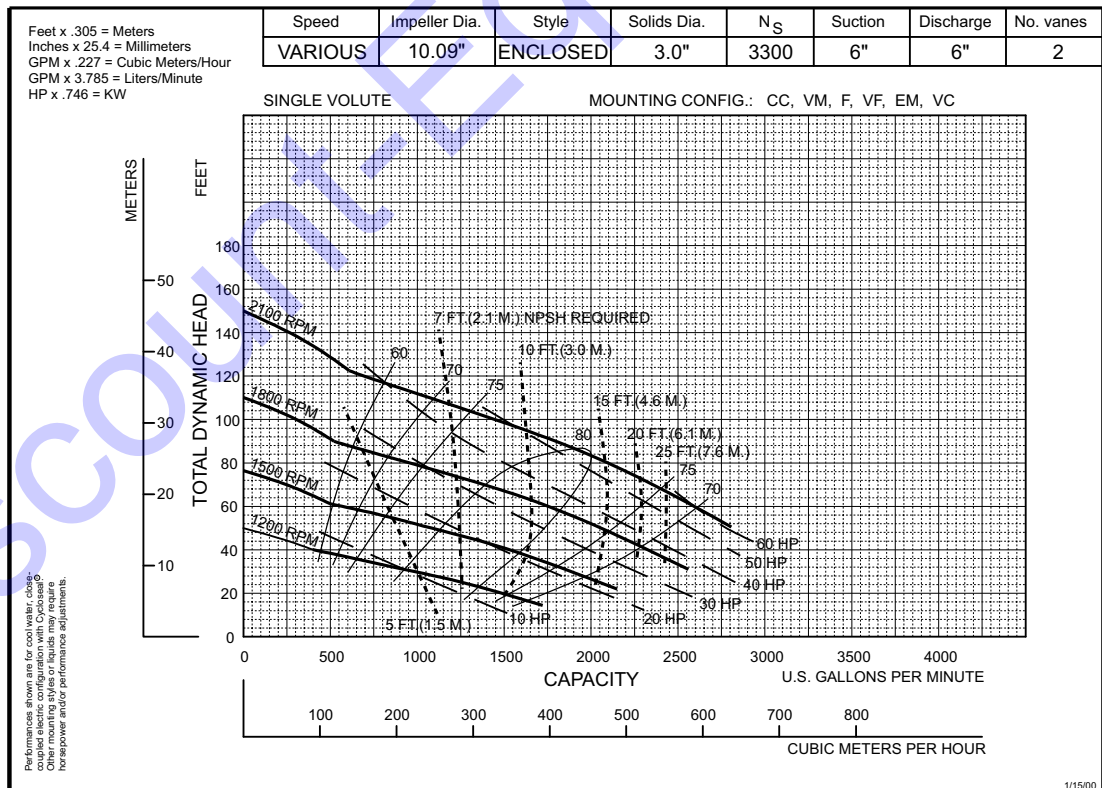

Figure 3-52. 6 Inch Pump Flow Rate Chart

Diaphragm Pump System

Some pumps are equipped with a diaphragm system. The system is a fully automatic self-priming, dry-prime vacuum pump. It can rapidly prime and re-prime completely unattended. The pump utilizes a diaphragm, which creates vacuum on the suction side of the pump, causing air to be displaced by water moving up the suction pipe. The water approaches the ball valve and forces the ball valve closed, shutting off the air flow diaphragm pump. The pump is then primed and operating at full flow.

NOTE: The diaphragm vacuum pump system also comes with run-dry capability, which allows indefinite dry running of the seal.

Operation

Priming time is a function of the volume of air in the suction line and the RPM of the vacuum pump. High lifts and larger suction line diameters will require longer priming times. If the pump will not prime or maintain prime, or if the vacuum pump runs hot or passes water, refer to [Troubleshooting](#).

IMPORTANT NOTE: Do not attempt to reduce the priming time by operating the pump at speeds exceeding recommendations. Doing so will shorten the life of the vacuum pump.

When pumping in extremely cold conditions, ice may form on the prime valve seat or linkage, preventing closure and allowing water into the vacuum pump. Close observation must be maintained and the pump shut down at the first signs of excessive water coming from the vacuum pump.

Should the discharge check valve become plugged, the pump must be shut down and the valve cleaned out. Refer to [Discharge Check Valve](#). Clogging of the suction strainer or hose may result in loss of prime without recovery. A vacuum gauge can be connected to the tap on the side of the priming chamber to aid in diagnosing such clogs.

Mechanical Seal

The pump is equipped with a run-dry feature. The run-dry feature employs an auxiliary gland and reservoir mounted to the backplate. The rotation of the drive shaft circulates oil from the reservoir to the gland, then back to the reservoir. The oil serves to cool the seal faces even when there is no liquid in the pump casing. A V-ring may be installed when space allows.

With the backup run-dry feature, the pump can operate for a short period of time with no liquid in the pump casing without causing damage to the mechanical seal. The run-dry option is not intended for extended periods of operation without liquid in the pump casing, but rather as a safety feature to save the mechanical seal should the pump unexpectedly lose prime or inadvertently be started without being primed.

Recommended reservoir oil:

- Chevron Turbine Oil GST32 or other ISO viscosity grade 32 or below (synthetic oil recommended)
- Transmission fluid or hydraulic oil

The reservoir oil should be a non-volatile substance that is compatible with the mechanical seal elastomers, will not cause rusting, and will not freeze in cold climates. Refer to [Wear Rings](#) for more information.

CAUTION

Equipment Damage. Always run pump with water in the priming chamber. Failure to do so will result in equipment damage and/or failure.

(000280)

Liquid Temperature and Overheating

The maximum liquid temperature for this pump is 160 °F (71 °C). Do not apply it at a higher operating temperature. Overheating can occur if the pump is operated with the valves in the suction and/or discharge lines closed. Operating against closed valves could bring the liquid to a boil, build pressure, and cause the pump to rupture or explode. If overheating occurs, stop the pump and allow it to cool before servicing it. Fill the pump casing with cool liquid.

WARNING

Personal Injury. Do not operate pump with flow completely restricted. Doing so could cause pump casing to explode and could result in death or serious injury.

(000273)

Pump Vacuum Check

With the pump inoperative, install a vacuum gauge in the system. Block the suction line and start the pump. At operating speed, the pump should pull a vacuum of 20 in. (67.7 kPa) of mercury or more. If it does not, check for air leaks at the suction piping gaskets.

Bearing Temperature Check

Bearings normally run at higher than ambient temperatures because of heat generated by friction. Temperatures up to 160 °F (71 °C) are considered normal for bearings, and they can operate safely to at least 180 °F (82 °C). Measure the bearing temperature with a contact-type thermometer.

Stopping The Unit

Allow the engine to idle briefly before switching the Key switch to the OFF position.

Emergency Stop Switch

The unit is equipped with one emergency stop switch. For location of the emergency stop switch, refer to [Component Locations](#). The red button is clearly labeled “EMERGENCY STOP.”

Activate the emergency stop switch by pushing the button in until it locks down. This opens the fuel circuit, shutting down the engine. The switch will remain locked until it is pulled out.

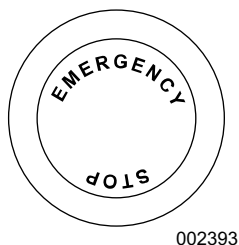

Figure 3-53. Emergency Stop Switch

CAUTION

Equipment Damage. The emergency stop switch is not to be used to power down the unit under normal operating circumstances. Doing so will result in equipment damage. (000246)

Automatic Shutdown

The unit is equipped with a low oil pressure and a high temperature automatic shutdown system. This system will automatically shut off the fuel supply to stop the engine if oil pressure drops too low or the engine exceeds normal operating temperature. Return the key switch to the OFF position to reset the controller; restart the engine after you have determined the cause of the shutdown. Refer to [Engine Fault Shutdown Troubleshooting](#) for more information.

Remote/Auto Starting Option

The unit can be configured to start automatically by adding dry-contact closure float level switches.

Towing the Unit

1. Use the jack to raise or lower the trailer onto the hitch of the towing vehicle. Lock the hitch coupling and attach the safety chains or cables to the vehicle. Raise the jack foot completely.
2. Raise the rear leveling jacks to the travel position. Turn the jack handles counterclockwise until the leveling feet are fully retracted.

3. Connect any trailer wiring to the tow vehicle. Check for proper operation of the directional and brake lights.
4. Verify all doors and flip hood are properly latched.
5. Check for proper inflation of the trailer tires. The maximum tire pressures is 65 PSI.
6. Check the wheel lugs. Tighten or replace any that are loose or missing. If a tire has been removed for axle service or replaced, tighten the lugs in the order shown to the following specifications:

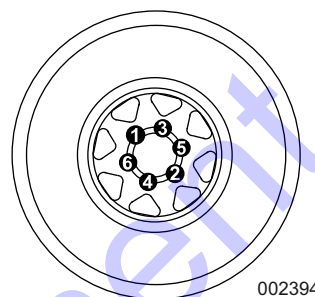

Figure 3-54. Lug Sequence

- a. Start all lug nuts by hand.
- b. First pass tighten to 20-25 ft-lbs (27-33 Nm).
- c. Second pass tighten to 50-60 ft-lbs (67-81 Nm).
- d. Third pass tighten to 90-120 ft-lbs (122-162 Nm).

NOTE: After the first road use, tighten the lug nuts to the specified torque value.

7. Maximum recommended speed for highway towing is 45 mph (72 km/h). Recommended off-road towing speed is not to exceed 10 mph (16 km/h) or less, depending on terrain.

Lifting the Unit

Remove the suction and discharge piping from the pump prior to moving. Verify the equipment being used to lift the unit is in good condition and has sufficient capacity.

Always remain aware of the position of other people and objects around you as you move the unit.

A central lift point (A) is located on the top of the unit. Attach any slings, chains or hooks directly to the lift point.

The tie down rings (B) at the front and back corners of the trailer are intended for tie down use only.

⚠ WARNING

Personal injury. Excessive weight. Use only appropriate lifting eyes and lifting equipment to lift unit. Improper lifting techniques could result in equipment damage, death or serious injury. (000224)

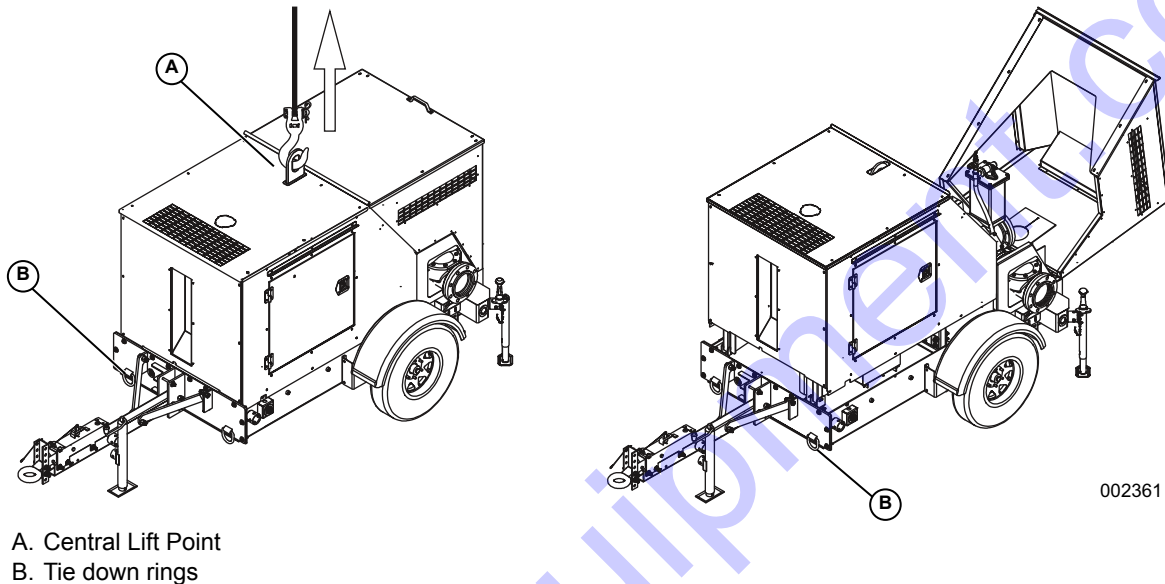

Figure 3-5. Lifting Points

Section 4 Maintenance

Normal maintenance, service, and replacement of parts are the responsibility of the owner/operator and, as such, are not considered defects in materials or workmanship within the terms of the warranty.

Poorly maintained equipment can become a safety hazard. In order for the equipment to operate safely and properly over a long period of time, periodic maintenance and occasional repairs are necessary.

WARNING

Accidental Start-up. Disconnect the negative battery cable, then the positive battery cable when working on unit. Failure to do so could result in death or serious injury. (000130)

Attach a "DO NOT START" sign to the control panel. This will notify everyone that the unit is being serviced and will reduce the chance of someone inadvertently trying to start the unit.

For detailed engine maintenance procedures, refer to the engine operator's manual, which was supplied with the unit when it was shipped from the factory.



WARNING

Consult Manual. Read and understand manual completely before using product. Failure to completely understand manual and product could result in death or serious injury. (000100a)

Before servicing:

1. Verify that the key switch is turned to OFF and the negative (-) cable on the battery is disconnected.
2. If the pump or components are hot, allow adequate cooling prior to servicing the unit.
3. Close the suction and discharge valves.
4. Vent the pump slowly and drain completely.



WARNING

Risk of burns. Do not open coolant system until engine has completely cooled. Doing so could result in serious injury. (000154)

Do not allow compressed air to pressurize the pump or vent-off compressed air through the pump, as this may damage the pump and cause serious personal injury.

If this unit is used to handle any hazardous materials that can cause injury or illness, take precautions by wearing approved protective clothing and use appropriate safety equipment.

When servicing the unit, use only components provided by the OEM or Generac Mobile Products, LLC. Any use of non-authorized parts could result in sub-standard performance, damage to equipment and possible injury to personnel. Use of unauthorized parts will also void the warranty.

Refer to Section 5 *Troubleshooting* to help diagnose operational or performance problems. Only disassemble the unit components required to remedy the problem condition. Select a clean suitable location for any required maintenance, and note that all work must be performed by qualified personnel.

Daily Walk Around Inspection

Look for conditions that could hinder performance or safety, such as (but not limited to) oil/coolant/fuel leakage, blocked vents, loose/missing hardware and electrical connections.

Visually inspect the engine fan belt for cracks, fraying, and stretching. Verify the belt is properly seated in pulley grooves. Replace the belt according to the manufacturer's recommendations.

Failure to perform a daily inspection may result in serious damage to the prime mover.

General Maintenance

Refer to the original equipment manufacturer's operating manual for a complete list of maintenance requirements. Failure to comply with the procedures as described in the

engine operator manual will nullify the warranty, decrease performance and cause equipment damage or premature equipment failure. Maintenance records may be required to complete a warranty request.

Use the schedule in the following table as a guide for regular maintenance intervals.

Table 4 - Basic Maintenance Schedule

Item	Daily	50 Hours	Every 500 Hours	Every 1000 Hours	Every 1500 Hours	Every 2 Years
Check Coolant Level	◆					
Check Oil Level Sight Gauge (diaphragm only)	◆					
Check Fuel Level	◆					
Check Tire Pressure	◆					
Check Electrical Connections	◆					
Inspect Radiator Fins for Debris (clean as required)	◆					
Check Mechanical Seal Oil Level	◆					
Check Flange Fitting Hardware	◆					
Check Engine for Leaks	◆					
Check Exhaust System for Leaks	◆					
Check Suction Air Filter/Dry Air Filter	◆					
Empty Water Tank in the Fuel Pre-filter	◆					
Check Engine V-belts			◆			
Check Coolant (additive concentration)			◆			
Check Intake Air Pipes for Damage			◆			
Replace Pump Lubricating Oil			◆			
Replace Fuel Filter Cartridge			◆			
Change Engine Oil and Filter		◆*	◆			
Check Battery and Cable Connectors				◆		
Check Engine Mounting (tighten, replace if damaged when necessary)				◆		
Check Fastenings & Hose Unions/Clips				◆		
Replace Engine Air Cleaner Element				◆		
Replace V-belt				◆		
Change Compressor Air Cleaner Element				◆		
Grease Pump Bearings					◆**	
Replace Coolant						◆

* Change the engine oil and oil filter after the initial 50 hours of operation, then at the appropriate interval thereafter. Refer to engine manual for engine oil recommendations.

** Add three to six pumps of grease at each grease fitting with a hand grease gun. Refer to [Figure 2-5](#) and [Figure 2-6](#) for grease fitting locations.

Checking the Engine Oil

Low engine oil and overfilling lead to engine damage. The oil level may only be checked with the engine in a horizontal position and switched off. If the engine is warm, switch off the engine and check the oil level after five minutes. If the engine is cold, you can check it immediately.

WARNING

Skin irritation. Avoid prolonged or repeated contact with used motor oil. Used motor oil has been shown to cause skin cancer in laboratory animals. Thoroughly wash exposed areas with soap and water.

(000210)

WARNING

Risk of burns. Allow engine to cool before draining oil or coolant. Failure to do so could result in death or serious injury.

(000139)

1. Pull out the dipstick and wipe off with a lint-free, clean cloth.
2. Insert the dipstick into the engine again as far as it will go.
3. Pull out the dipstick again and read the oil level. The oil level must always be between the MIN and MAX marks. Add oil up to the MAX mark if necessary.

CAUTION

Engine damage. Verify proper type and quantity of engine oil prior to starting engine. Failure to do so could result in engine damage.

(000135)

Checking the Oil Level Sight Gauge (Diaphragm Pump Only)

Check that oil is visible in the sight glass located on the side of the bearing housing of the diaphragm vacuum pump. (It is recommended that the sight glass be checked daily.) If no oil is visible, oil will need to be added.

1. Shut down the unit.
2. Remove the pipe plug located at the top of the housing (refer to *Figure 4-6*).
3. Add 10W-30 oil until the static oil level is below the center of the sight glass. **DO NOT OVERFILL.**
4. Install the pipe plug.

Changing the Engine Oil

1. Warm up the engine (oil temperature greater than 176 °F (80 °C)).
2. Verify the engine is in a level position.
3. Turn the engine off.
4. Place a collecting receptacle underneath the lube oil drain.
5. Open the oil drain valve and drain the oil into the receptacle.
6. After the oil has drained completely, close the oil drain valve.
7. Remove the engine oil fill cap and add the recommended amount and type of oil. Refer to the engine manual for specifications.
8. Warm up the engine (oil temperature greater than 176 °F (80 °C)).

9. Verify the engine is level and check the oil level. Refer to *Checking the Engine Oil*.

Changing the Oil Filter

NOTE: The filter cartridge should never be pre-filled. There is a danger of dirt contamination.

1. Loosen and unscrew the filter with filter tool. Refer to engine manual for more information.
2. Collect the draining engine oil.
3. Clean the sealing surface of the filter support with a lint-free, clean cloth.
4. Oil the gasket of the new filter cartridge lightly.
5. Screw on the new filter by hand until the gasket is touching and then torque to 11-13 ft-lbs (15-17 Nm).

Adding Coolant

1. Visually check the coolant level in the sight glass located near the top of the radiator. If coolant is not visible, coolant will need to be added to the system.
2. Let engine cool (not at operating temperature, not running), before adding coolant.
3. Add a 50/50 mixture of the correct antifreeze and distilled or deionized water to the coolant system. Add until it is 3/4 in. (19 mm) below the filler neck.

WARNING

Risk of burns. Do not open coolant system until engine has completely cooled. Doing so could result in serious injury.

(000154)

Jack Maintenance

The following procedures should be performed at least annually.

Side-Wind Models

- The internal gearing and bushings of the jack must be kept lubricated. Apply a small amount of automotive grease to the internal gearing by removing the jack cover, or if equipped, use a needle nose applicator or standard grease gun on the lubrication point found on the side of the jack near the crank. Rotate the jack handle to distribute the grease evenly.
- A lightweight oil must be applied to the handle unit at both sides of the tube.

Top-Wind Models

- Apply a lightweight oil to the screw stem.

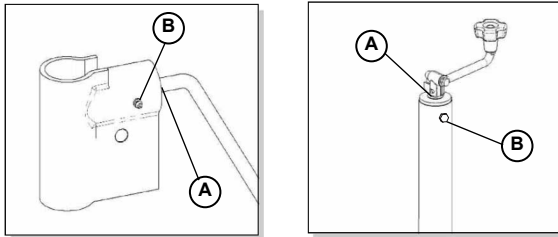

002755

A = Oil

B = Grease

Figure 4-1. Lubrication Points

compression and collapsing the three sections together. Use care not to drill into the volute casting. Better control is obtained if small pilot holes are first drilled and then enlarged to “cut” the ring. This same technique can be used to remove the hub wear ring.

Wear Rings

Wear rings are vital for successful pump operation. They reduce the pressure at the stuffing box and they reduce axial thrust loads. Wear rings should be replaced if the clearance has increased to about 0.03 in (0.76 mm) per side.

Servicing The Pump

Pump Disassembly

1. Remove all capscrews from the volute. Insert two of the capscrews into the tapped holes in the backplate. Do not allow the volute to fall onto the impeller.
2. See [Figure 4-2](#) and [Figure 4-3](#). Remove the impeller lockscrew with a breaker bar. Do not use an impact wrench. Apply steady and even torque to break lockscrew loose. Allen head tooling to remove the lockscrew should be in excellent condition. Discard the lockscrew. Remove the impeller washer.
3. Remove any flush lines to the seal gland.
4. Remove the gland capscrews evenly until capscrews are free of the backplate.
5. Space wedges in pairs 180° apart between the impeller and backplate. Verify the wedges are placed along impeller vanes. Tap opposed wedges at the same time to force off the impeller. Use extreme care to avoid damage to impeller, shaft and bearings.
6. Remove the impeller and impeller key.
7. Unbolt and remove the backplate from the bracket.
8. Remove the mechanical seal.
9. The suction wear ring can be removed by drilling the ring longitudinally in three places to relieve

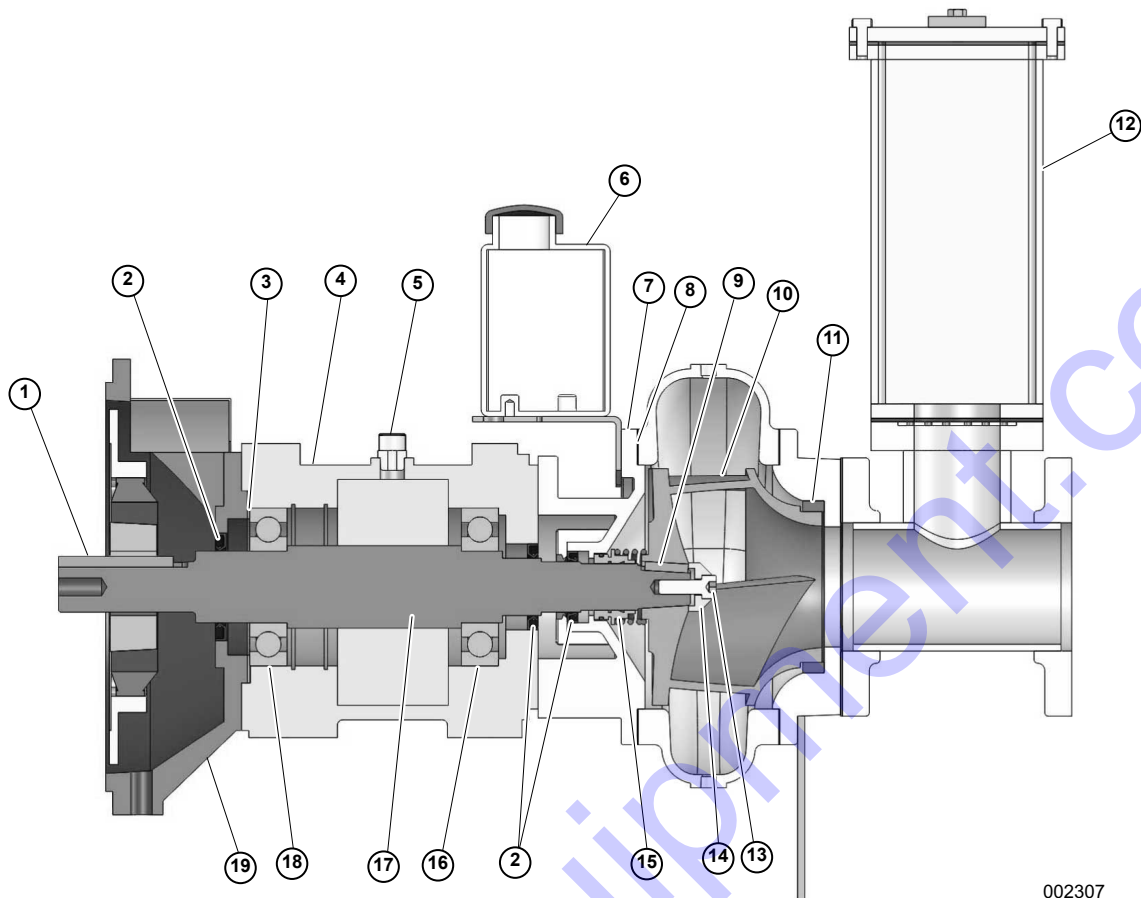

002307

Figure 4-2. 4 Inch Pump Cross-Section

- | | |
|----------------------------------|------------------------|
| 1. Shaft key | 11. Wear ring |
| 2. Lip seals (3) | 12. Priming chamber |
| 3. Shims | 13. Impeller lockscrew |
| 4. Frame | 14. Impeller washer |
| 5. Breather | 15. Mechanical seal |
| 6. Mechanical seal oil reservoir | 16. Pump end bearing |
| 7. Backplate | 17. Shaft |
| 8. Volute gasket | 18. Drive end bearing |
| 9. Impeller key | 19. Engine bracket |
| 10. Impeller | |

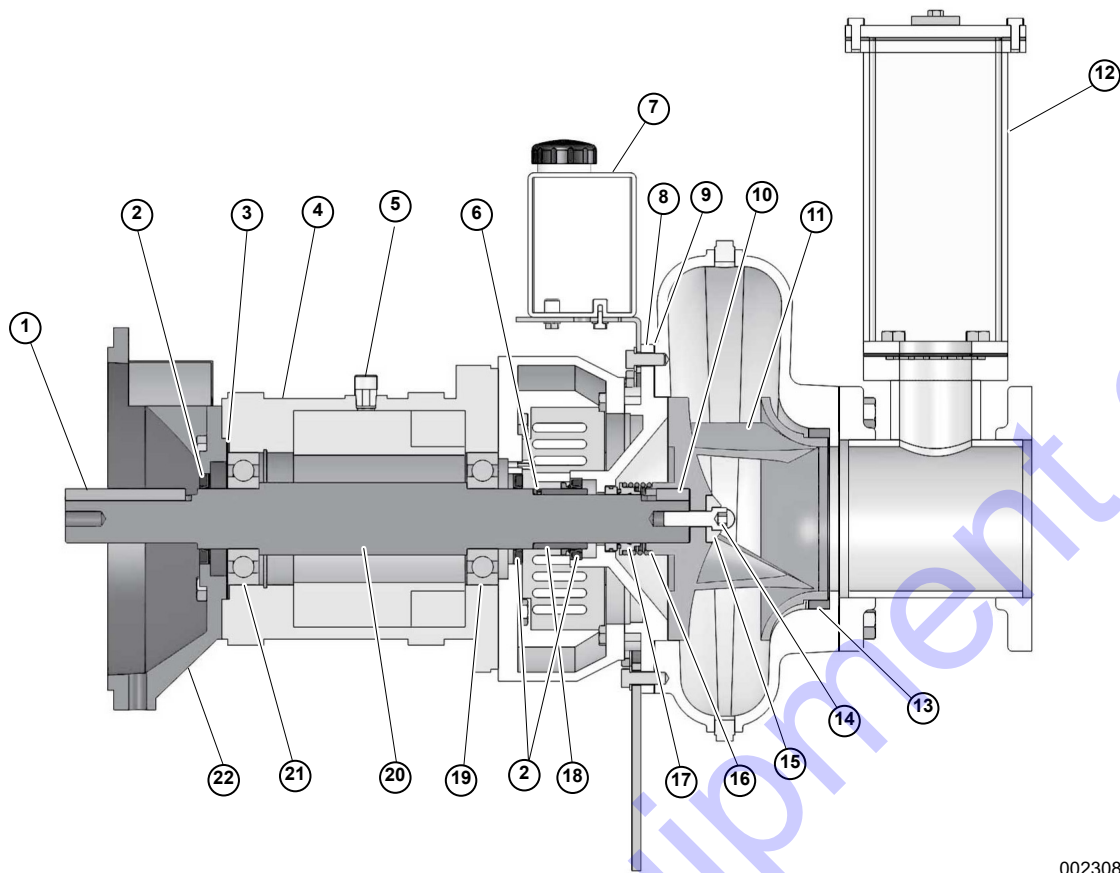

Figure 4-3. 6 Inch Pump Cross-Section

002308

- | | |
|----------------------------------|------------------------|
| 1. Shaft key | 12. Priming chamber |
| 2. Lip seals (3) | 13. Wear ring |
| 3. Shims | 14. Impeller lockscrew |
| 4. Frame | 15. Impeller washer |
| 5. Breather | 16. Impeller shims |
| 6. O-ring (sleeve) | 17. Mechanical seal |
| 7. Mechanical seal oil reservoir | 18. Shaft sleeve |
| 8. Backplate | 19. Pump end bearing |
| 9. Volute gasket | 20. Shaft |
| 10. Impeller key | 21. Drive end bearing |
| 11. Impeller | 22. Engine bracket |

Pump Assembly

- Each mechanical seal has its own particular assembly procedures. Refer to **Wear Rings**.
- Install the backplate.
- Use new gaskets. In case of an emergency situation where you need to reuse the old gaskets, verify the gaskets are moist and flat.
- Install the impeller key and impeller. For solids handling pumps, install the impeller shims to maintain 0.030 inch (.76 mm) minimum clearance between the backplate and impeller backvanes. Use the a long capscrew and several washers to press on the impeller. Do not use the impeller lockscrew. The threads must be long enough to enter the shaft approximately eight threads or eight turns by hand. This is necessary to protect the threads in the shaft.
- After installing the impeller, remove the long capscrew and replace with the impeller lockscrew with the impeller washer. The impeller lockscrew should always be new. Refer to table **Lockscrew Torque Values** for torque requirements.
- Install the volute, sliding it carefully over the register. Bolt the volute to the backplate.

- For seals, bring the gland and gasket against the face at the seal chamber and tighten the bolts evenly.

capscrews. Stainless steel lock screws are supplied with Loctite 262, which should be applied to lock screw threads and shaft prior to installation.

First determine the size and material of the lock, then torque to the appropriate value listed in the table below.

Impeller Lockscrew Installation

Impeller lock screws are always right hand socket head

Table 5 - Lockscrew Torque Values

Size	Torque for Stainless Steel Lockscrew (nonmagnetic) 302, 303, 304, 316 Series
.38- 6UNC	20 ft-lbs (27 Nm)
.50-13UNC	40 ft-lbs (54 Nm)
.62-UNC	90 ft-lbs (122 Nm)
.75-10UNC	135 ft-lbs (183 Nm)
1.00-8UNC	265 ft-lbs (359 Nm)
1.12-7UNC	360 ft-lbs (488 Nm)
1.25-7UNC	510 ft-lbs (691 Nm)
1.50-7UNC	875 ft-lbs (1186 Nm)

Lubrication

Do not lubricate the impeller lock screw or tapped hole, between the lock screw and impeller washer, or between the impeller washer and impeller. Verify parts are clean and dry; however, it is not necessary to remove the protective coating from the screw. Lubricated bolts can be overstressed with the torques indicated.

NOTE: Do not use the lock screw to install the impeller.

NOTE: Lock screw failure can damage the impeller and volute. The impeller screw must be of the best material, properly forged and machined to rigid specifications not available from local suppliers. Purchase only lock screws available from Generac Power Products for assurance of quality.

Impeller Lockscrew Removal

- Break the impeller lock screw loose with a breaker bar.

NOTE: Care should be taken when removing lock screw to prevent damaging the screw head.

- If the breaker bar will not loosen the impeller lock screw, apply heat to the lock screw for 2-4 minutes. Do not exceed 400°F (204°C).



Risk of Burns. Take care when applying heat to the lock screw. Failure to do so could result in serious injury.

(000276)

- Allow lock screw to cool and remove with a breaker bar.

Frame Disassembly and Assembly

Disassembly

- Remove the deflectors from the shaft.
- Remove the drive end shaft key.
- Remove the capscrews from the bearing cover or drive end bracket.

NOTE: Grease lubricated frames have a single lip seal at the drive end pump ends. If the lip seals are to be saved, the shaft should be cleared of burrs or sharp protrusions which would cut the seal. If the seals are removed or replaced, refer to [Figure 4-2](#) or [Figure 4-6](#) for orientation of the lips. Paired seals have a grease passageway between them and are arranged so that the grease will move through the inner and outer seal.

- Slide the bearing cover or drive end bracket off the shaft. Remove the capscrews from the pump bracket. Slide the pump bracket off the shaft.
- The shaft and bearings can now be removed by pressing on the drive end of the shaft.
- Remove the bearings from the shaft with a bearing puller. If the bearings are to be saved, keep them absolutely clean. If contaminated, wash only in clean fluid.

NOTE: Never hammer the shaft or parts attached to the shaft or you will damage both the shaft and the bearings.

Assembly

1. Press the drive end and pump end bearings onto the shaft. Pressure should be applied to the inner race.
2. Press the shaft into the frame through the drive end until the pump end bearing is approximately flush with the pump end of the frame.
3. Install the pump end lip seal(s) into the bracket. Slide the pump bracket over the shaft, taking care not to damage or fold the lip seal(s). Install and tighten the capscrews.
4. Install the lip seal(s) in the bearing cover or drive end bracket. Install the shims in the drive end of the frame (if present when disassembled). If new shaft, bearings, frame, bearing cover or drive end bracket are being installed, insert shims to maintain 0.007-0.012 in. (0.177-0.304 mm) shaft end play. Slide the bearing cover or drive end bracket over the shaft. Install and tighten the capscrews.
5. Install the deflector and lubricate. Refer to [Lubrication Instructions](#).

Lubrication Instructions

Bearings in all frames are greased at the factory before shipment.

Lubrication requirement vary with speed, power, load,

ambient temperatures, exposure to contamination and moisture, seasonal or continuous operation and other factors. The brief recommendations which follow are general in nature and must be coupled with good judgment and consideration of the application conditions. For re-greasing periods, refer to the table below. When adding grease, verify the grease and fittings are absolutely clean.

Grease used for these bearings should be equivalent to one of the following manufacturer's products:

- G.E. Long Life Grease No. D682C5
- Mobil Mobilux No. EP2
- Shell Alvania EP2
- Texaco Multifak AFB 2

To lubricate frame bearings, remove the plastic cover and grease fittings. Verify the fitting and end of the grease gun are clean. Use a hand-operated grease gun and pump a small amount into each bearing cavity. The surplus grease will go through the bearing and into the center part of the frame.

For re-greasing periods and approximate quantity, refer to the table below.

First determine frame size (located on serial number plate).

Example: 5HH-65B4, 4NNT-VF16, 10YB-F18DB, 6NHTA-VC18, 4RB-EM16

Table 6 - Recommended Re-Greasing Periods for Frames

	Frame Size				
	2-5-11 and EM309	6-7-8-16 60B4 through 68B4	10-12-13-13D 18-18D	20-24	30
Total Running Time	2,000 hours	1,500 hours	1,000 hours	1,350 hours	2,000 hours
8 Hour Day Service	36 weeks	27 weeks	18 weeks	24 weeks	36 weeks
24 Hour Day Service	12 weeks	9 weeks	6 weeks	8 weeks	12 weeks
Approximate Amount of Grease per Line Fitting	.5 cubic inch	1.25 cubic inch	2 cubic inch	3 cubic inch	4 cubic inch
Approximate No. of Pumps with Grease Gun (hand operated)	3 pumps	6 pumps	12 pumps	18 pumps	23 pumps

Mechanical Seal Maintenance

The location of the mechanical seal in your pump is shown in [Figure 4-3](#). The stationary seat is held in the backplate. All other parts of the seal rotate with the shaft and impeller. The seal chamber must be full of liquid before operating the pump.

No maintenance is required for the mechanical seal. However, the pump should be examined at regular intervals for leakage resulting from wear of the sealing faces. Occasionally, new installations will leak for a short time. These must be inspected daily. If the leakage does not reduce to almost zero, the assembly should be examined for proper seal installation. Replace damaged

seals or mechanical seal oil as necessary.

Mechanical Seal Oil

The mechanical seal oil level should be maintained to the top line of the reservoir; however, oil will circulate as long as the oil level is above line of the reservoir. Refer to the [Table 4](#) for recommended mechanical seal oil change interval.

Mechanical seal oil can be added either during pump operation or while shut down. If water begins to accumulate in the reservoir, or the oil level depletes rapidly, this may indicate mechanical seal failure. Leakage of oil from the

gland would indicate a damaged or worn lip seal. Refer to [Mechanical Seal](#) for oil recommendations.

Removing the Mechanical Seal

If the seal is to be removed, remove the impeller according to the instructions for dismantling the pump. The rotating

portion of the seal may now be seen. Slide off the seal spring. Lubricate the shaft and remove the remainder of the rotating portion, being careful to avoid damaging the primary seal. The rubber bellows will be firmly attached to the shaft and considerable pressure will be required to remove it. Refer to [Figure 4-4](#).

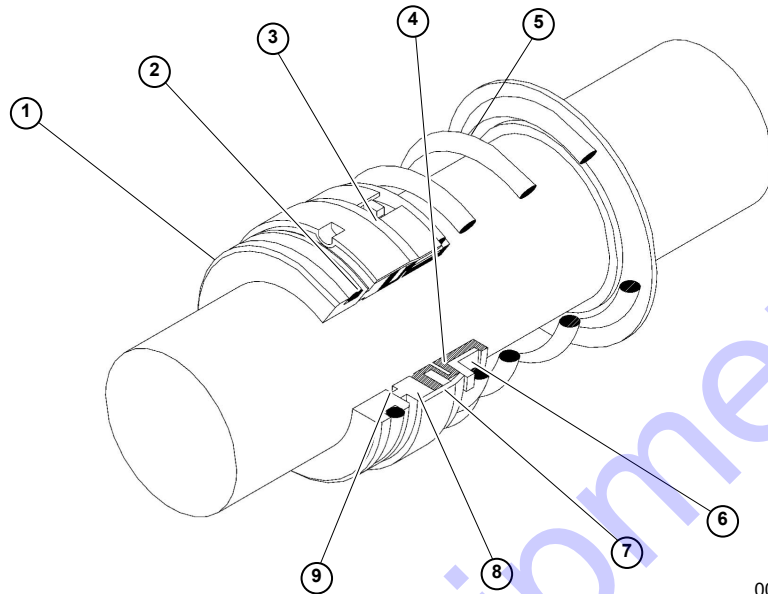

002309

Figure 4-4. Mechanical Seal Components

- | | |
|--------------------|-------------------------|
| 1. Stationary seat | 6. Driving band |
| 2. O-ring seat | 7. Disc |
| 3. Retainer | 8. Rotating seal face |
| 4. Bellows | 9. Stationary seal face |
| 5. Spring | |

Removing the O-ring Seat

If the seal is being replaced, remove the backplate (gland is built in) and press out the stationary seat.

Installing the O-ring Seat

Clean all parts before starting assembly. Oil the outer surface of the seat and the O-ring with a light oil (not grease). Place a cardboard disc on the sealing face to avoid damage. Press the seat into the gland or stuffing box using firm, steady pressure. Verify the seat is all the way in. Slide the gland with the gasket or backplate over the shaft. Install the backplate, then press the seat into the backplate.

Installing the Mechanical Seal

Clean all parts of the pump before starting assembly. Special attention should be given to the backplate and the impeller hub.

1. Clean and lubricate the shaft.

NOTE: Once the rotating portion has been placed on the shaft, the rest of the installation must be made at once.

2. Install the stationary seat in the backplate.
3. Oil the outer surface of the seat and the O-ring with a light oil (not grease). Place a cardboard disc on the sealing face to avoid damage. Press the seat into the gland or stuffing box using firm, steady pressure. Verify the seat is all the way in. Slide the gland with the gasket over the shaft.
4. Wipe the lapped sealing faces of the seat and the primary seal perfectly clean. Use extreme care to avoid marking the sealing face or the primary seal. Slide the rotating portion of the seal, including the spring, along the shaft.

NOTE: Once the rotating portion has been placed on the shaft, the rest of the installation must be made at once. Delay may result in the rubber bellows seizing on the shaft in the wrong position.

5. Install the impeller. Verify that the spring slides over the impeller hub and pushes against the backshroud of the impeller.

Priming Chamber

Float Removal

1. Loosen the hose clamp and disconnect the air hose from the prime valve.
2. Remove the four 3/8 in. hex nuts and capscrews from the priming chamber cover.
3. Lift off the priming chamber cover, complete with float linkage and prime valve assemblies.
4. Unscrew the float from the rod set screw.

Installation

1. Screw the float onto the rod and lock with set screw.
2. Install the priming chamber cover, complete with float linkage and prime valve assemblies.
3. Install the four 3/8 in. hex nuts and capscrews and tighten against the gasket.
4. Reconnect the air hose and secure with a hose clamp.

Prime Valve Removal and Installation

1. Remove the priming chamber cover, complete with float linkage and prime valve assembly. Refer to [Float Valve Linkage Removal and Installation](#).
2. The valve body can be separated from the priming chamber cover by removing the 3/8 in. capscrews for access to the O-ring. No other parts are directly accessible from outside of the cover.

Float Valve Linkage Removal and Installation

There is normally no reason to remove or replace the float valve linkage unless parts have experience damage. In the event that replacement is required, use the following instructions:

1. Separate the linkage frame from the cover by removing the two 5/16 in. capscrews. There may also be stainless flat washers between the frame and cover. (It is important to replace these washers when replacing the frame, as the total mounting distance between the top of the cover and the frame is an essential element in proper priming valve operation.)
2. All elements of the linkage are held in position with clevis pins, side links and cotter pins. To remove any damaged element, straighten and remove the necessary cotter pins and clevis pins.

NOTE: The tow actuator arms are very similar in appearance. Before removing either of these parts, make special note of their position and direction in relationship to other assembly parts.

3. The valve stem assembly may be removed by a similar action of pin removal. Two cross-drilled holes in the lower end of this part, with slightly separated center lines, accommodate accumulated tolerances in the assembled linkage parts. In most instances the drill from which the clevis pin has been removed will be the one to re-use on reassembly.

Linkage Replacement

1. Reverse the previous procedure steps.
2. When the linkage is correctly assembled and fastened to the cover, the valve seat O-ring should seat firmly when the float ball is raised to its uppermost position, and a 1/8 in. (3 mm) minimum gap should remain between the two actuator arms. If the arms can come together, the valve may not be adequately seating.

Strainer/Baffle

At factory assembly, the strainer is pushed onto the bottom of the priming chamber and is held in place by friction. During normal operation this strainer can drop loose from the cone and rest on the slotted suction spool pipe. This is NOT a problem. Air being evacuated from the suction piping can travel freely through the slots and around the strainer.

Separator

There is no regular maintenance to be performed on the separator. However, there are precautions for operation during freezing conditions. In freezing conditions, verify that there is no ice in the separator chamber to impede the separator float movement. Warm water can be poured over the separator or into the separator chamber through the separator hose connection. When pumping in extremely cold conditions, ice may form on the separator valve seat, preventing closure and allowing water into the compressor. Close observation must be maintained and the pump shut down at the first signs of water coming from the compressor.

NOTE: During an initial re-prime, there may be liquid remaining in the suction spool above the slots. This may allow brief misting out the discharge before the prime valve has closed. If at any other time during operation pumpage is seen continuously exhausting from the compressor, the pump should immediately be shut down and the priming chamber cover should be removed. Inspect the float assembly for any impediment to its movement. It should be able to fully close the valve stem assembly to

the valve seat. Also check the prime valve for any damage or debris.

Discharge Check Valve

The discharge check valve enables automatic priming of the pump by closing the air leakage path on the discharge side of the pump. This allows the primer to pull the pump casing vacuum down sufficiently that atmospheric pressure will push the check valve open and allow the flow of liquid through the discharge.

The presence of the check valve, as with any other fitting in the piping system, add resistance (pipe friction) to the total head the pump must overcome during normal operation, and not just while priming for start-up. The amount of this added friction varies with the rate of flow,

as well as with pipe size. To determine the extent of the addition for a specific performance point, refer to the flow rate charts. See [Flow Rates](#).

If the check valve disc should be prevented from completely closing due to debris or damage, the pump will not re-prime. In such a case it will be necessary to remove the inspection cover and clean out the debris or service the valve.

Maintenance

The check valve requires no scheduled lubrication or maintenance. For service or inspection, the valve can be serviced without disconnecting the inlet or outlet hoses. If inspection of the valve is required, follow the disassembly instructions.

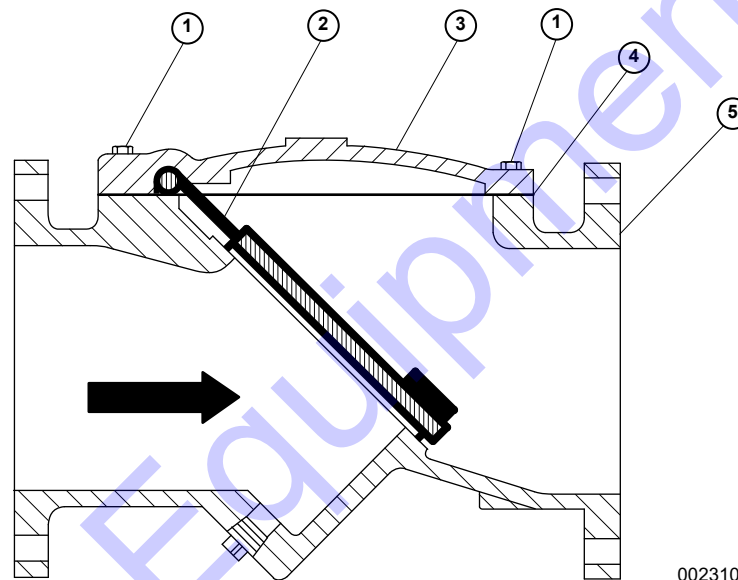

Figure 4-5. Discharge Check Valve

002310

- | | |
|----------------|---------------------|
| 1. Cover bolts | 4. Gasket |
| 2. Disc | 5. Check valve body |
| 3. Cover | |

Disassembly

The valve can be disassembled without removing it from the pump.



Personal injury. Drain water line to relieve pressure before removing cover. Failure to do so could result in minor or moderate injury.

(000270)

To relieve pressure and drain the pump:

1. Remove the cover bolts from the top cover.
2. Pry the cover loose and lift off the valve body.

3. Remove the disc and inspect for cracks, tears, or damage in the rubber sealing surface.
4. Clean and inspect the parts. Replace worn parts as necessary.

Assembly

All parts must be cleaned. Gasket surfaces should be cleaned with a stiff wire brush in the direction of the serrations or machine marks. Worn parts and gaskets should be replaced during assembly.

1. Place the disc over the seat with the beaded seating surface directed down.

2. Lay the cover gasket and cover over the bolt holes and disc hinge.
3. Insert the lubricated bolts, noting that the bolts in the hinge area are longer than the others.
4. Cover bolts should be tightened to the following specification during assembly.

Table 7 - Bolt Torque Values

Bolt Size	Torque
3/8 in.	24 ft-lbs (33 Nm)
1/2 in.	59 ft-lbs (80 Nm)
5/8 in.	117 ft-lbs (159 Nm)
3/4 in.	205 ft-lbs (278 Nm)

Diaphragm Pump System

Disassembly

1. Loosen the clamp and disconnect the air hose from the priming valve.
2. Drain the oil from the seal oil reservoir via the line on the lower reservoir connection.

3. Disconnect the lower oil line at the reservoir, hold the disconnected end over a container and move the line and container down to below the connected end of the oil line. This will drain the remaining oil from the lines and gland.
4. Disconnect the oil lines from the gland and unbolt the gland only if further pump disassembly is planned.
5. Remove the bolts and nuts holding the two halves of the vacuum pump belt guard together. Remove the two bolts and nuts holding the guard halves to the vacuum pump support table. Remove the belt guard halves.
6. Loosen (do not remove) the four bolts securing the vacuum pump to the support table. The belt is tensioned by means of shims under the vacuum pump. Loosen the support table bolts and insert a large screwdriver or pry bar between the vacuum pump and support table. Lift the vacuum pump enough so that the shims can be removed.
7. Lower the vacuum pump to create sufficient slack to remove the belt. Once the belt is removed, the vacuum pump can be completely unbolted and removed if desired.
8. The vacuum pump support table and seal oil reservoir can now be unbolted and removed if desired.

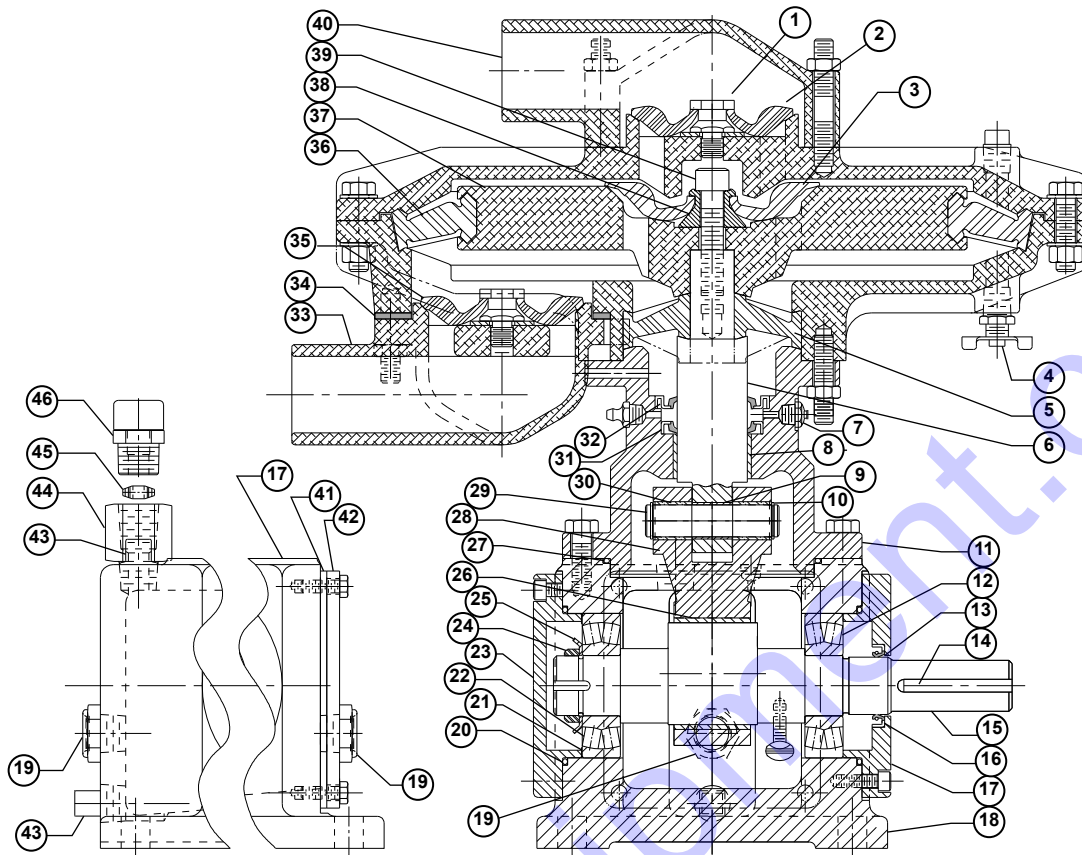

002311

Figure 4-6. Vacuum Pump Cross-section

- | | |
|------------------------------|-----------------------------------|
| 1. Valve stud | 24. Locknut |
| 2. Suction and exhaust valve | 25. Lock washer |
| 3. Actuator valve | 26. Crankshaft bearing |
| 4. Stop cock | 27. O-ring (pedestal) |
| 5. Actuator neck seal | 28. Connecting rod |
| 6. Actuator shaft | 29. Fulcrum pin |
| 7. Grease relief valve | 30. Fulcrum pin bearing |
| 8. Actuator shaft bearing | 31. Internal lip seal |
| 9. Pedestal bearing | 32. Wiper lip seal |
| 10. Retaining ring (2) | 33. Suction nozzle |
| 11. Pedestal | 34. Suction nozzle gasket |
| 12. Drive end bearing | 35. Suction and exhaust valve (2) |
| 13. Speed-sleeve location | 36. Actuator seal |
| 14. Shaft key | 37. Actuator |
| 15. Crankshaft | 38. Actuator washer |
| 16. Lip seal | 39. Actuator lock screw |
| 17. Drive end cover | 40. Exhaust nozzle |
| 18. Bearing housing | 41. Inspection plate gasket |
| 19. View gauge (2) | 42. Inspection plate |
| 20. O-ring (bearing cover) | 43. Pipe plug (remove to add oil) |
| 21. Shims | 44. Adapter |
| 22. O.D.E bearing | 45. Breather disc |
| 23. O.D.E. bearing cover | 46. Breather (bearing housing) |

Assembly

1. Install the vacuum pump support table and oil reservoir.
2. Orient the oil reservoir so that the inlet and outlet ports are on the same side of the pump as the inlet and outlet ports of the gland.
3. Install the oil lines between the gland and reservoir. The upper and lower ports of the gland and reservoir should be connected together.
4. Install the pulley on the pump main shaft. Position the toothed drive belt in the adapter support bracket and install the pulley. Alternately, the pulley can be installed into the SAE adapter support bracket before the belt is installed on the pulley. Install the SAE adapter bracket to the adapter support bracket. Install the engine drive coupling.
5. Place the vacuum pump on the support table and loosely install the bolts and nuts.
6. Place the drive belt over the pulleys on the main shaft and vacuum pump shaft. Place shims evenly under the vacuum pump mounting until proper belt tension is obtained and tighten the bolts. A load of 3.0 lbs (1.36 kg) applied across the belt at mid-span should give a deflection at that point of 1/8 in. (3.17 mm). Check the belt tension after tightening the vacuum pump mounting bolts. The belt need only be tight enough to prevent "jumping" from one tooth to another.
7. Connect the air hose between the inlet on the bottom side of the vacuum pump housing and the priming valve nozzle. Verify the clamps are properly tightened.

NOTE: During operation, once the pump is fully primed, no air should be felt exiting the vacuum pump exhaust. Close off the vacuum pump exhaust with the palm of the hand. If air pressure builds, then check all priming chamber to vacuum pump hose connections for leakage.

8. Verify the drain plugs are installed and fill the oil reservoir to within 1/2 in. (6.35 mm) of the upper level glass. Check the oil level in the vacuum pump bearing housing and add oil if necessary. The oil level should be visible in the center of the level glass. **DO NOT OVERFILL.**
9. Once the pump assembly has been mounted to the baseplate, and the couplings between the pump shaft and driver have been installed and aligned, replace the vacuum pump belt guard halves. Bolt the halves to each other and then to the support table.
10. Check all bolts for tightness.

Suction Valve Removal and Installation

1. Remove the hose to the priming chamber.

2. Remove the four 3/8 in. nuts.
3. Remove the suction valve elbow and discard the gasket.
4. Lift the valve over the head of the valve stud; do not remove the bolt.
5. Clean the valve chamber and seat.
6. Lubricate the valve stud and push the new valve on over the head of the stud. Tuck the elastomeric shoulder of the valve completely under the head of the valve stud.
7. Fit the new gasket and install the suction valve elbow and 3/8 in. nuts.
8. Connect the priming chamber hose and tighten the hose clamp.

Actuator Neck Seal Removal and Installation

1. Remove the actuator assembly as described in [Suction Valve Removal and Installation](#).
2. Remove the priming chamber hose from the suction nozzle.
3. Remove the four hex nuts holding the lower housing to the pedestal.
4. Remove the vacuum pump lower housing and actuator neck seal.
5. Lubricate the new actuator neck seal and push it into the vacuum pump lower housing.
6. Fit the assembly over the actuator shaft.
7. Orient the vacuum pump inlet suction nozzle to face the priming chamber and install the four hex nuts.
8. Install the actuator/seal assembly and remaining components. Refer to [Suction Valve Removal and Installation](#).

Crankshaft Removal and Installation

Removal

1. Remove the actuator neck seal as described in [Actuator Neck Seal Removal and Installation](#).
2. Remove the 1/2 in. NPT drain plug from bearing housing; drain and discard oil.
3. Remove the four 3/8 in. capscrews from the pedestal lower flange.
4. Carefully remove the vacuum pump pedestal complete with seals and linear bearing. Remove and discard the O-ring taking special care not to damage the actuator rod surface.
5. Remove the four 1/4 in. capscrews from the inspection plate.

6. Remove the inspection cover. Remove and discard gasket.
7. Remove the thumbscrew dippers from the crankshaft.
8. Remove the four 1/4 in. capscrews from the O.D.E. bearing cover.
9. Remove the bearing cover and O-ring. Discard the O-ring.
10. Bend back the lock washer tabs and remove the bearing locknut; use 'C' spanner SKF REF HN5 or equivalent.
11. Remove the lock washer.
12. Remove the four 1/4 in. capscrews from the drive end bearing cover.
13. Remove the drive end bearing cover complete with lip seal.
14. Remove the O-ring and discard.
15. Carefully pull the shaft from the housing, complete with drive end bearing.
16. Remove the connecting rod actuator shaft assembly and inspect the bushings.
17. Use a bearing puller to remove the bearing from the shaft.
9. Carefully lower the pedestal, complete with seal O-ring and linear bearing, over the actuator shaft. (Assembly tool [P/N: 52655] is available to assist with reassembly of the pedestal without damage to the lip seals. Contact Generac Technical Service.)
10. Secure the pedestal with the top flat relief properly oriented to clear the inlet nozzle.
11. Fit the actuator neck seal and remaining components. Refer to [Actuator Neck Seal Removal and Installation](#).
12. Fill the bearing housing with 10W-30 oil. Fill so static oil level is at the center of the sight glass. Do not overfill.

Crankshaft Lip Seal Removal and Installation

1. Remove the 1/2 in NPT drain plug from the bearing housing. Drain and discard oil.
2. Remove the four 1/4 in. capscrews from the drive end bearing cover.
3. Remove the drive end bearing cover complete with lip seal.
4. Remove and discard the O-ring.
5. Pull the lip seal from the cover and discard.
6. Clean and lubricate the lip seal cavity. Press in the lip seal fully against the shoulder (lip nearest the bearing).
7. Inspect the speed-sleeve; replace if required.
8. Lubricate the shaft sealing surface.
9. Fit the new O-ring on the bearing cover and slide the assembly over the shaft. Align the screw holes.
10. Secure the cover to the bearing housing with four 1/4 in. capscrews. Tighten to 10 ft-lbs (13.5 Nm).
11. Fill the bearing housing with 10W-30 oil to where the static oil level is below the center of the sight glass. Do not overfill.

Installation

1. On a new shaft, with a zero lead ground lip seal surface, no speed-sleeve is required. On an old shaft, when surface condition dictates, or on a new shaft with a turned surface, install a speed-sleeve 0.06-0.12 in. (1.52-3.0 mm) past the outside drive end shoulder. Refer to [Figure 4-6](#).
2. Carefully slide the opposite drive end of the shaft and bearing assembly into the drive end of the housing through the con-rod bushing and engage the shaft end in the ODE bearing.
3. Fit the lock washer, engaging locating tab in the shaft groove.
4. Fit the bearing locknut and tighten with 'C' spanner; bend lock washer tab into groove.
5. install the appropriate total thickness of shims to leave 0.007 in. to 0.010 in. (.177-.254mm) clearance between the ODE bearing and installed cover.
6. Fit the ODE bearing cover and new O-ring; secure with four 1/4 in. capscrews. Tighten to 10 ft-lbs (13.5 Nm).
7. Fit the drive end bearing cover complete with lip seal and new O-ring. Secure with four 1/4 in. capscrews. Tighten to 10 ft-lbs (13.5 Nm).
8. If the actuator shaft has been disassembled from connecting rod, assemble with the bushing fulcrum pin and snap rings before continuing.

Roller Bearing Removal and Installation

Follow procedures in [Crankshaft Removal and Installation](#) and [Crankshaft Lip Seal Removal and Installation](#).

Connecting Rod/Drive Rod Assembly

It is recommended that these items be purchased pre-assembled with bearing finish machined and reamed. For removal, refer to [Crankshaft Removal and Installation](#) and [Crankshaft Lip Seal Removal and Installation](#).

Pedestal Bearing and Seals Removal and Installation

1. Remove the vacuum pump pedestal assembly, complete with lip seals, following the steps in [Crankshaft Removal and Installation](#).
2. Remove the seals from the housing.
3. Use a bearing drift to push out the pedestal bearing.
4. Lubricate the new bearing and press it into the housing until the bottom edges of the bearing and housing are flush with one another.
5. Lubricate the seal housing and press in the lower seal (lip nearest to bearing). (Assembly tool [P/N: 52655] is available to assist with assembly of the lip seals in pedestal. Contact Generac Technical Service.)
6. Press the wiper seal into the pedestal with wiper lip uppermost.

Install the pedestal assembly and remaining components, complete with lip seal, following the steps in [Crankshaft Removal and Installation](#). Check the bearing housing oil level daily and add 10W-30 oil as necessary. Fill to the center of the sight glass. Do not overfill.

Every six months or every 1500 hours, drain the bearing housing and fill with fresh 10W-30 oil. If pumpage is seen exhausting from the vacuum pump discharge, shut the pump down and inspect the priming chamber.

Trailer Wheel Bearings

Some trailers are equipped with a grease fitting to allow lubrication of the wheel bearings without the need to disassemble the axle hub. To lubricate the axle bearings, remove the small rubber plug on the grease cap, attach a standard grease gun fitting to the grease fitting and pump grease into the fitting until new grease is visible around the nozzle of the grease gun. Use only a high quality grease made specifically for lubrication of wheel bearings. Wipe any excess grease from the hub with a clean cloth and install the rubber plug when finished. The minimum recommended lubrication is every 12 months or 12,000 miles (19,312 km). More frequent lubrication may be required under extremely dusty or damp operating conditions.

Storage

The unit is adequately prepared for outside storage prior to shipment. Use the following list of additional suggestions for extended storage.

Extended Storage Preparation

1. Disconnect the battery cables.
2. Store the unit off the ground so no water will accumulate around the equipment.

3. Protect the unit from blowing sand and dirt.
4. Stack no other items on top of the pump/equipment.
5. Protect the unit from the entry of any animals.
6. Periodically rotate shaft to lubricate bearings and protect bearings from brinelling.
7. Protect unit with approved drying agents (Silica Gel).
8. Verify all bare metal areas are coated with a rust preventative.
9. Inspect unit every four weeks and replace drying agents (Silica Gel) as required, or a minimum of every six months.
10. Keep an inspection record showing dates of inspection with any maintenance performed and condition of drying agents (Silica Gel).
11. Before use, verify that all rust protection has been removed. Also, remove any foreign material that may have accumulated during storage.
12. Before use, remove all drying agents (Silica Gel).
13. Drain all water from the main pump piping, including the suction line and discharge line. Remove the volute drain plug and vent plug to empty the pump casing.
14. Verify correct oil level in the engine and seal oil reservoir. Add oil as necessary.
15. Add grease to the main pump bearing frame fittings. Three to six strokes at each fitting with a hand grease gun should be sufficient.
16. Jog the main pump motor for 10 to 15 seconds. Install all plugs removed for draining.

Winter Storage

Follow the steps in [Extended Storage Preparation](#). Occasional motor starts once every month are recommended. Run the unit until it reaches operating temperature. This will help to replace and maintain a lubricating film on the bearings and operating parts.

Commission Unit for Use

In installations where winter shutdown and storage is the normal situation, it is recommended that lubricating oil and seal barrier oil be drained and replaced to correct levels before the beginning of each new season.

- Add fresh grease to the main bearing frame and vacuum pump pedestal fittings
- Check all gasketed flanges, especially those on the suction side of the pump, for bolt tightness to eliminate the effect of air leaks on the priming time.

Section 5 Troubleshooting

Pump Troubleshooting Guide

Symptom	Possible Cause
No discharge	1,2,3,4,5,7,8,9,10,17,18,19,20,37
Reduced capacity	2,3,4,5,7,8,9,10,11,17,19,20,21,38,39,40,47
Reduced pressure	5,7,8,11,13,18,19,38,39,40,47
Loss of prime	2,3,4,7,10,11,20,21,22,23
Power consumption excessive, engine runs hot	6,12,13,17,18,19,24,33,34,35,36,37,38,41,42,43,44
Vibration and noise	2,4,9,10,14,15,17,26,27,28,29,30,31,32,33,34,35,36,39,40,41,42,43,44,48
Seal: excessive leakage, short life, seal housing overheating	22,23,25,33,34,35,36,41,44,45,46
Bearings: overheating, short life, noise	26,27,28,29,30,31,32,33,34,35,36,41,42,43,44
Pump overheating, seizes	1,8,9,14,33,34,35,36,41,42,43,44
Corrosion, erosion, pitting, oxidation or other loss of material	7,8,11,14,15,16

1. Pump not primed	16. Electrolysis	33. Pipe strain
2. Suction line not filled	17. Impeller obstructed	34. Temperature growth
3. Air pocket in suction line	18. Rotation direction wrong	35. Misalignment
4. Suction inlet or foot valve obstructed, insufficiently submerged, or too small	19. Low speed	36. Coupling improperly installed
5. System head higher than pump design head	20. Air leak into suction line	37. Impeller installed backwards
6. System head lower than pump design head	21. Air leak through mechanical seal	38. Worn wear rings
7. Insufficient Net Positive Suction Head (NPSH)	22. Seal fluid contaminated, hot or insufficient	39. Impeller damage
8. Parallel pump application is incorrect	23. Seal fluid system not vented	40. Improper balance (after repair)
9. Suction pressure to vapor pressure below minimum	24. High speed	41. Bent shaft
10. Suction lift too high	25. Mechanical seal insufficient	42. Excessive thrust
11. Excess vapor in pumpage	26. Bearing housing excessively cooled	43. Rotational element dragging
12. Specific gravity of pumpage housing different than design	27. Low oil pressure (oil lube bearings)	44. Worn or incorrectly installed bearings
13. Viscosity of pumpage different than design	28. Improper or poor lubrication	45. Mechanical seal not properly set, O-rings damaged or hardened
14. Operation at below rated capacity	29. Lubrication defective	46. Shaft scored at seal
15. Cavitation	30. Dirt in lubrication/bearings	47. Volute O-ring
	31. Moisture in lubricant/bearing housing	48. Foundation not rigid or settled
	32. Lubricant excess	

Engine Fault Shutdown Troubleshooting

Symptom	Possible Cause	Solution
Low oil pressure shutdown	Low oil level	Check oil level, replace as necessary
	Faulty oil pressure sender	Replace oil pressure sender
	Incorrect oil grade	Change engine oil, refer to engine operating manual
	Worn oil pump	Refer to engine operating manual
	Oil leak	Refer to engine operating manual
High temperature shutdown	Low coolant level	Check coolant level, replace as necessary
	Faulty temperature sender	Replace temperature sender
	Coolant leaks	Refer to engine operating manual, replace components as necessary
	Worn water pump	Refer to engine operating manual
Overcrank shutdown	Pump engine will not start	Refer to engine operating manual
Overspeed shutdown	Pump cavitation	Reduce engine speed, lower intake hose
	Air trapped in intake hose	Relocate and/or straighten intake hose
	Intake insufficiently submerged	Lower intake hose
	Air leak in intake hose	Inspect intake hoses and couplings for damage or missing components and seals
	Air leak at pump housing	Inspect gaskets, seals and O-rings at pump intake flange, clean out cover and priming port
No speed signal shutdown	Engine magnetic pickup damaged or misaligned	Inspect magnetic pickup for damage/alignment
Low fuel shutdown	Low fuel level	Refill fuel tank with clean diesel fuel
Low coolant shutdown	Low coolant level	Allow engine to cool. Check coolant level in radiator. Add coolant until it is 3/4 in. (19 mm) below the filler neck

Control System Troubleshooting

Symptom	Possible Cause	Solution
Control system does not perform self test	Faulty connection to battery	Correct battery connections
	Faulty control system	Repair or replace control system
Control system shuts down	Engine stop LED illuminated	Correct ECU stop condition, use ECU diagnostics
Display does not display data	Display lost power	Turn on key, verify display plugged into harness
	Engine source address incorrect	Change engine address in <i>Configuration</i>
	Display address incorrect	Change display address to 40 (default)
	Display configuration problem	Reset display using <i>Restore Defaults</i>
	CANbus failure	Check CANbus
	ECU not sending data	Repair or replace ECU
Engine will not crank	Fuel level/pressure low (SPN 524057)	Check fuel level Check if fuel supply line is loose Prime fuel system: Turn key to Start position. Let pump run for 10-15 seconds. (May need to repeat.)

Diagnostic Trouble Codes (DTS)

CANbus Diagnostic Trouble Codes are a pair of numbers: the Suspect Parameter Number (SPN) and Failure Mode Identifier (FMI). The SPN indicates the faulting subsystem and the FMI identifies the type of failure.

SPN Codes

Standard SPN codes are defined by SAE J1939-71. Not all standard codes are provided by ECUs. Manufacturers may add additional SPN codes beyond the codes identified in J1939-71. Contact a Deutz dealer or Generac Technical Service for more information.

Table 8 - Typical SPN Codes

SPN	Description
51	Throttle Position
91	Accelerator Pedal Position
94	Fuel Delivery Pressure
98	Engine Oil Level
100	Engine Oil Pressure
110	Engine Coolant Temperature
111	Coolant Level

FMI Codes

FMI codes are defined by SAE J1939-71. Refer to ECU documentation for correct interpretation of FMI codes for a specific SPN.

Table 9 - FMI Codes

FMI	Description
0	Data valid but above normal operational range
1	Data valid but below normal operational range
2	Data erratic, intermittent or incorrect
3	Voltage above normal or shorted high
4	Voltage below normal or shorted low
5	Current below normal or open circuit
6	Current above normal or grounded circuit
7	Mechanical system not responding properly
8	Abnormal frequency, pulse width or period
9	Abnormal update rate
10	Abnormal rate of change
11	Failure mode not identifiable
12	Bad intelligent device or component
13	Out of calibration
14	Special instructions
15	Data valid but above normal operational range (least severe)
16	Data valid but above normal operational range (moderately severe)
17	Data valid but below normal operational range (least severe)
18	Data valid but below normal operational range (moderately severe)
19	Received network data in error
20-30	Reserved for future assignment
31	Not available or condition exists

Section 6 Installation Diagrams and Service Log

DC Wiring Diagram

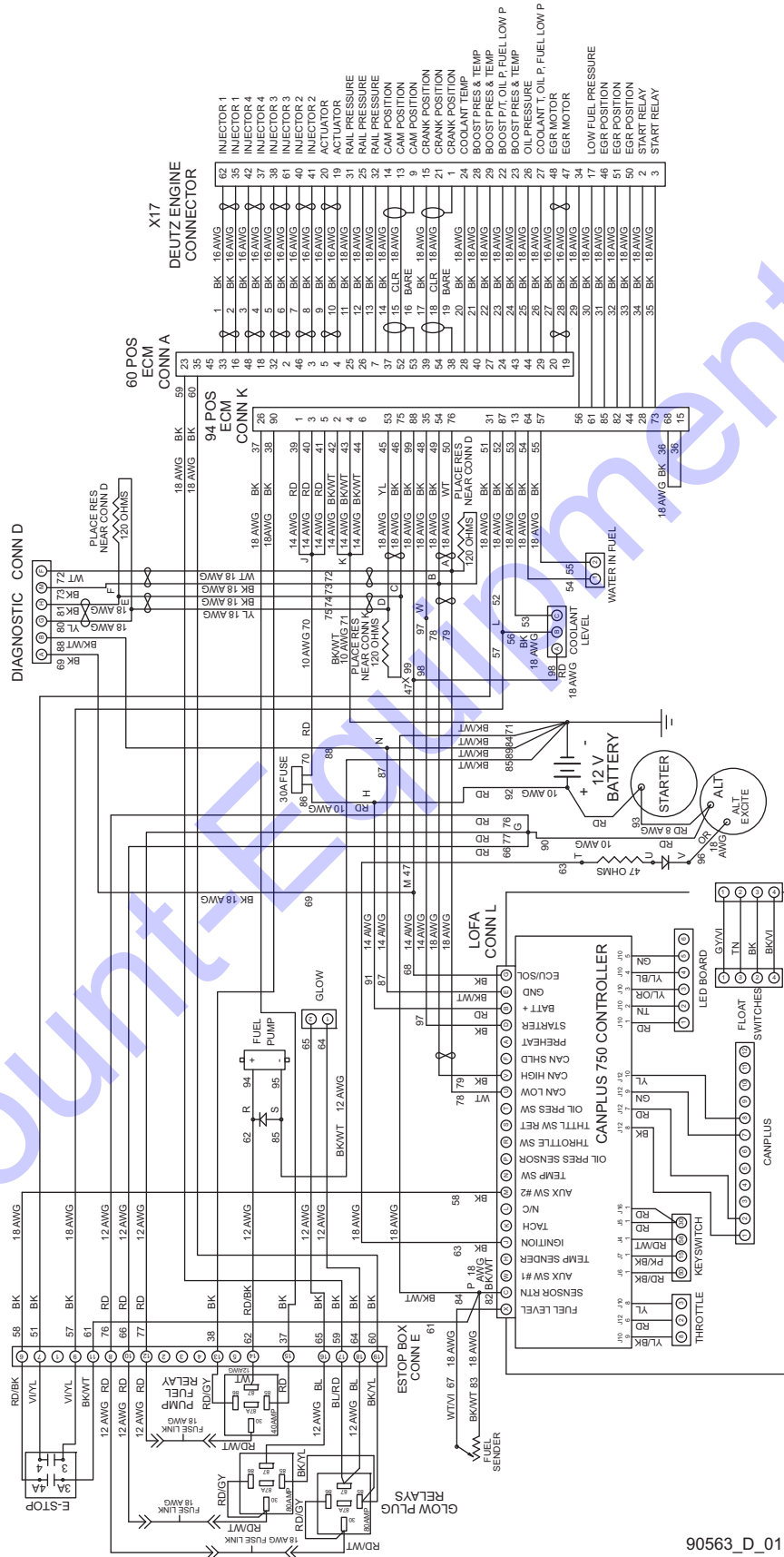

90563_D_01.26.15



www.discount-equipment.com

GENERAC[®]

MAGNUM

Part No. 54095 Rev. A 06/20/16
© Generac Mobile Products. All rights reserved
Specifications are subject to change without notice.
No reproduction allowed in any form without prior written
consent from Generac Mobile Products.