

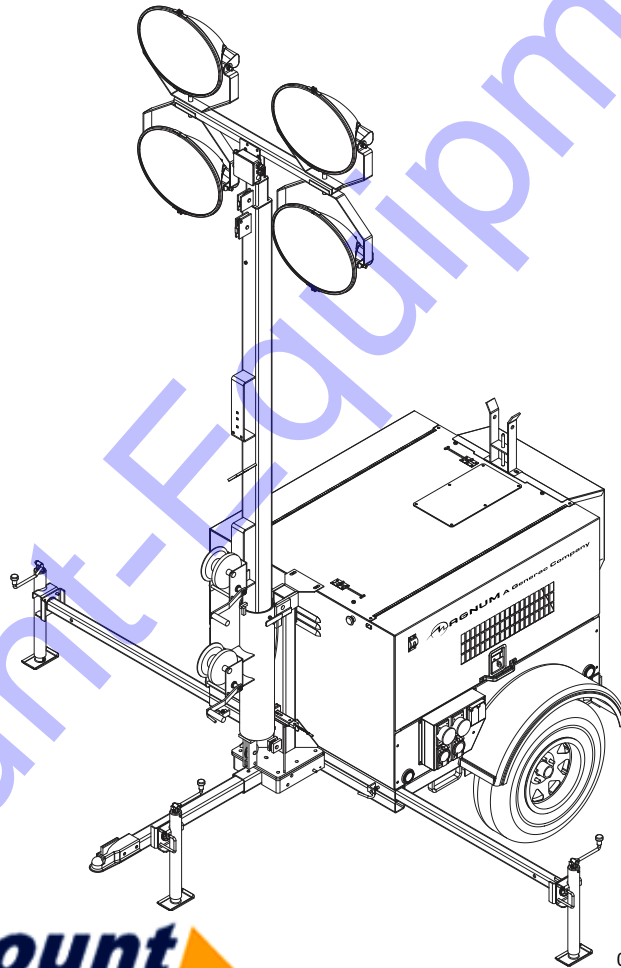

# MAGNUM™

A Generac Company

## LIGHT TOWER MLT4200IF4



00888



[www.discount-equipment.com](http://www.discount-equipment.com)

## OPERATING MANUAL

# **Discount Equipment**

Discount-Equipment.com is your online resource for commercial and industrial quality parts and equipment sales.

## **Locations:**

Florida (West Palm Beach): [561-964-4949](tel:561-964-4949)

Outside Florida TOLL FREE: [877-690-3101](tel:877-690-3101)

**Need parts?** Check out our website at [www.discount-equipment.com](http://www.discount-equipment.com)

## **Can't find what you need?**

Click on this link: <http://www.discount-equipment.com/category/5443-parts/> and fill out the request form.

Please have the machine model and serial number available in order to help us get you the correct parts. One of our experienced staff members will get back to you with a quote for the right part that your machine needs.

We sell worldwide for the brands: Genie, Terex, JLG, MultiQuip, Mayco, Toro/Stone, Diamond Products, Magnum, Airman, Mustang, Power Blanket, Nifty Lift, Atlas Copco, Chicago Pneumatic, Allmand Brothers, Essick, Miller Spreader, Skyjack, Lull, Skytrak, Tsurumi, Husquvarna/Target, Whiteman-Concrete/Mortar, Stow-Concrete/Mortar, Baldor, Wacker, Sakai, Snorkel, Upright, Mi-T-M, Sullair, Neal, Basic, Dynapac, MBW, Weber, Bartell, Bennar Newman, Haulotte, Ditch Runner, Blaw-Knox, Himoinsa, Best, Buddy, Crown, Edco, Wyco, Bomag, Laymor, Terremite, Barreto, EZ Trench, Takeuchi, Basic, Bil-Jax, Curtis, Gehl, Heli, Honda, ICS/PowerGrit, Puckett, Waldon, ASV, IHI, Partner, Imer, Clipper, MMD, Koshin, Rice, Gorman Rupp, CH&E, Cat Pumps, Comet, General Pump, Giant, AMida, Coleman, NAC, Gradall, Square Shooter, Kent, Stanley, Tamco, Toku, Hatz, Kohler, Robin, Wisconsin, Northrock, Oztec, Toker TK, Rol-Air, Small Line, Wanco, Yanmar

**New Equipment - Used Equipment - Rental Equipment - Parts and Accessories**

# **Discount Equipment**

[www.discount-equipment.com](http://www.discount-equipment.com)

**561-964-4949**

Parts: [wbparts@Discount-Equipment.com](mailto:wbparts@Discount-Equipment.com)

Sales: [info@Discount-Equipment.com](mailto:info@Discount-Equipment.com)

## INTRODUCTION

This manual provides information and procedures to safely operate and maintain the Magnum Power Products LLC unit. For your own safety and protection from physical injury, carefully read, understand, and observe the safety instructions described in this manual. Keep a copy of this manual with the unit at all times. *The information contained in this manual was based on machines in production at the time of publication. Magnum Power Products LLC reserves the right to change any portion of this information without notice.*

Read all of the manuals included with the unit. Each manual details specific information regarding items such as setup, use and service requirements. An engine operator's manual provides detailed operation and maintenance procedures for the engine. Additional copies of the engine operator's manual are available from the engine manufacturer.

**DO NOT MODIFY** or use this equipment for any application other than which it was designed for.

Magnum Power Products LLC recommends that a trained and licensed professional perform all electrical wiring and testing functions. Installation should be in compliance with the National Electrical Code (NEC), state and local regulations and Occupational Safety and Health Association (OSHA) guidelines.

Engine Make: \_\_\_\_\_

Engine Serial Number: \_\_\_\_\_

Engine Model Number: \_\_\_\_\_

Generator Make: \_\_\_\_\_

Generator Model Number: \_\_\_\_\_

Generator Serial Number: \_\_\_\_\_

Unit Model Number: \_\_\_\_\_

Unit Serial Number: \_\_\_\_\_

### **▲ WARNING**

**CALIFORNIA PROPOSITION 65 WARNING: Diesel engine exhaust and some of its constituents are known to the state of California to cause cancer, birth defects and other reproductive harm.**

# TABLE OF CONTENTS

	Page
INTRODUCTION .....	2
SAFETY NOTES .....	5
OPERATING SAFETY .....	5
ENGINE SAFETY .....	6
SERVICE SAFETY .....	7
TOWING SAFETY .....	7
REPORTING TRAILER SAFETY DEFECTS .....	8
SAFETY SYMBOL SUMMARY .....	9
SPECIFICATIONS .....	10
UNIT DIMENSIONS .....	11
UNIT SERIAL NUMBER LOCATIONS .....	12
COMPONENT LOCATIONS .....	13
LIGHT TOWER SET UP .....	14
RAISING THE MAST .....	15
RAISING THE MAST WITH ELECTRIC WINCH OPTION .....	16
MAIN CONTROL PANEL .....	17
L401 CONTROLLER .....	18
CONTROLLER FEATURES AND FUNCTIONS .....	18
OPERATOR SCREENS .....	23
PRESTART CHECKLIST .....	25
ENGINE BREAK-IN REQUIREMENTS .....	26
EMERGENCY STOP SWITCH .....	26
MANUAL STARTING OF THE UNIT .....	26
AUTO (REMOTE) STARTING OF THE UNIT .....	27
AUTOMATIC SHUTDOWN .....	27
LIGHT OPERATION .....	28
VOLTAGE REGULATION .....	28
DERATING FOR ALTITUDE .....	28
WET STACKING .....	29
RECEPTACLE PANEL .....	29
REMOTE START TERMINAL BLOCK .....	29
TRANSFER SWITCH .....	29
AUTO EXERCISE TIMER .....	30
SHUTTING DOWN THE UNIT .....	32
LOWERING THE MAST - MANUALLY .....	32
LOWERING THE MAST - ELECTRIC WINCH OPTION .....	33
REMOVING THE LIGHTS FOR TRANSPORTATION .....	34
TOWING THE UNIT .....	34
LIFTING THE UNIT .....	35
GENERAL MAINTENANCE .....	35
BASIC MAINTENANCE SCHEDULE - ISUZU ENGINE .....	36
RESETTING THE MAINTENANCE ALARMS .....	36
WINCH USE, OPERATION & MAINTENANCE - MANUAL .....	36
WINCH USE, OPERATION & MAINTENANCE - ELECTRIC .....	37
JACK MAINTENANCE .....	38
TRAILER WHEEL BEARINGS .....	38
LOWER RADIATOR HOSE HEATER OPTION - USE AND MAINTENANCE .....	39
TROUBLESHOOTING THE LIGHTS .....	39
TROUBLESHOOTING AUTOMATIC SHUTDOWN CONDITIONS .....	39
MAST LIGHT CONNECTIONS .....	40
AC WIRING DIAGRAM .....	41
AC WIRING DIAGRAM - RECEPTACLE PANEL .....	42
AC WIRING DIAGRAM - RECEPTACLE PANEL OPTIONS (1 OF 2) .....	43
AC WIRING DIAGRAM - RECEPTACLE PANEL OPTIONS (2 OF 2) .....	44
DC WIRING DIAGRAM .....	45
DC WIRING DIAGRAM - ELECTRIC WINCH .....	46



DC WIRING DIAGRAMS FOR OPTIONAL EQUIPMENT ..... 47  
TRAILER LIGHTS WIRING DIAGRAM ..... 48  
SERVICE LOG ..... 49  
NOTES ..... 50

Discount-Equipment.com

## SAFETY NOTES



This is the safety alert symbol. It is used to alert you to potential personal injury hazards. Obey all safety messages that follow this symbol to avoid possible injury or death.

This manual contains DANGERS, WARNINGS, CAUTIONS, NOTICES and NOTES which must be followed to prevent the possibility of improper service, damage to the equipment, personal injury or death. The following formatting options will apply when calling the readers attention to the DANGERS, WARNINGS, CAUTIONS, NOTICES and NOTES.

### **▲ DANGER**

**INDICATES A HAZARDOUS SITUATION WHICH, IF NOT AVOIDED, WILL RESULT IN DEATH OR SERIOUS INJURY.**

### **▲ WARNING**

**Indicates a hazardous situation which, if not avoided, could result in death or serious injury.**

### **▲ CAUTION**

Indicates a hazardous situation which, if not avoided, could result in minor or moderate injury.

### **NOTICE**

Indicates a hazardous situation which, if not avoided, could result in property or equipment damage.

**Note:** Notes contain additional information important to a procedure and will be found within the regular text body of this manual.

## OPERATING SAFETY



Before using the unit be sure to read and understand all of the instructions provided with the unit. This equipment was designed for specific applications; **DO NOT** modify or use this equipment for any application other than which it was designed for. Equipment operated improperly or by untrained personnel can be dangerous.

Read the operating instructions and familiarize yourself with the location and proper use of all instruments and controls. Inexperienced operators should receive instruction from someone familiar with the equipment before being allowed to operate or set up the unit. The following points should be practiced at all times:

- The area immediately surrounding the unit should be dry, clean, and free of debris.
- Position and operate the unit on a firm, level surface.
- **NEVER** start a unit in need of repair.
- **ALWAYS** lower the mast when not in use, or if high winds or electrical storms are expected in the area.
- Make certain the unit is well grounded and securely fastened to a good earthen ground. Follow the National Electrical Code (NEC), state and local regulations.
- The mast extends up to 30 ft (9.14 m). **ALWAYS** make sure the area above the unit is open and clear of overhead wires and obstructions.
- Keep area around the mast clear of people while raising and lowering the mast.
- Keep all body parts, clothing and other loose items clear of the winch, cables and pulleys during operation.
- Bulbs become extremely hot during use. Allow them to cool 10-15 minutes before handling.
- **NEVER** raise or lower the mast while lights are in operation.

- **ALWAYS** extend the outriggers and level the unit before raising the mast. **DO NOT** retract the outriggers while the mast is up.
- If for any reason any part of the mast hangs up or the winch cable develops slack while raising or lowering the mast, **STOP** immediately and contact an authorized service representative.
- **NEVER** use the unit if insulation on the electrical cord is cut or worn through.
- **NEVER** operate the lights without protective lens covers in place or with a lens cover that is cracked or damaged.
- Only use mild soap and water to clean the lens covers. Other chemicals may have an adverse effect on the glass.
- **NEVER** operate a unit while tired, distracted, or under the influence of drugs or alcohol.

## ENGINE SAFETY



Internal combustion engines present special hazards during operation and fueling. Failure to follow the safety guidelines described below could result in severe injury or death. Read and follow all safety warnings described in the engine operator's manual. A copy of this manual was supplied with the unit when it was shipped from the factory.

- **DO NOT** run engine indoors or in an area with poor ventilation unless exhaust hoses are used. Diesel engine exhaust contains carbon monoxide, a deadly, odorless and colorless gas which, if inhaled, can cause nausea, fainting or death. Make sure engine exhaust cannot seep into closed rooms or ventilation equipment.
- **DO NOT** operate the unit on a combustible surface.
- **DO NOT** fill fuel tank near an open flame, while smoking, or while engine is running. **DO NOT** fill tank in an enclosed area with poor ventilation.
- **DO NOT** operate with the fuel tank cap loose or missing.
- **DO NOT** touch or lean against hot exhaust pipes or engine cylinders.
- **DO NOT** clean air filter with gasoline or other types of low flash point solvents.
- **DO NOT** remove engine coolant cap while engine is hot.
- **DO NOT** operate the unit without a functional exhaust system. Prolonged exposure to sound levels in excess of 85 dB(A) can cause permanent hearing loss. Wear hearing protection when working around a running engine.
- Keep area around exhaust pipes and air ducts free of debris to reduce the chance of an accidental fire.
- Batteries contain sulfuric acid which can cause severe injury or death. Sulfuric acid can cause eye damage, burn flesh or eat holes in clothing. Protective eye wear and clothing are necessary when working on or around the battery. Always disconnect the negative (-) battery cable from the corresponding terminal before performing any service on the engine or other components.
- Shut the engine down if any of the following conditions exist during operation:
  1. Noticeable change in engine speed.
  2. Loss of electrical output.
  3. Equipment connected to the generator overheats.
  4. Sparking occurs.
  5. Engine misfires or there is excessive engine/generator vibration.
  6. Protective covers are loose or missing.
  7. If the ambient air temperature is above 120°F (49°C).

## SERVICE SAFETY



This unit uses high voltage circuits capable of causing serious injury or death. Only a qualified electrician should troubleshoot or repair electrical problems occurring in this equipment.

- Before servicing, make sure the Control Power switch and circuit breakers are in the OFF (O) position, and the negative terminal on the battery is disconnected. **NEVER** perform even routine service (oil/filter changes, cleaning, etc.) unless all electrical components are shut down.
- **NEVER** allow water to accumulate around the base of the unit. If water is present, **DO NOT** service.
- **NEVER** service electrical components if clothing or skin is wet. If the unit is stored outside, check the engine and generator for any moisture and dry the unit before use.
- **NEVER** wash the unit with a power washer or high pressure hose.
- Open the main circuit breaker before disconnecting battery cables.
- Keep all body parts, clothing, and other loose items away from moving parts on the unit.
- Make sure slings, chains, hooks, ramps, jacks, and other types of lifting devices are attached securely and have enough weight-bearing capacity to lift or hold the unit safely. Always remain aware of the position of other people around when lifting the unit.
- **NEVER** start the unit under load. The circuit breakers must be in the OFF (O) position when starting the unit.
- **ALWAYS** disconnect the negative (-) battery cable from the corresponding terminal before performing any service on the engine, generator or any other components. Remove the negative (-) battery cable from the corresponding terminal if the unit is to be stored or transported.
- Replace all guards and safety devices immediately after servicing.
- Wear heavy leather gloves when handling winch cables. Never let cables slip through bare hands.

## TOWING SAFETY



Towing a trailer requires care. Both the trailer and vehicle must be in good condition and securely fastened to each other to reduce the possibility of an accident. Some states require that large trailers be registered and licensed, contact your local Department of Transportation office to check on license requirements for your particular unit.

- Check that the hitch and coupling on the towing vehicle are rated equal to, or greater than, the trailer's Gross Vehicle Weight Rating (GVWR).
- Check tires on trailer for tread wear, inflation, and condition.
- **NEVER** tow trailer using defective parts. Inspect the hitch and coupling for wear or damage.
- Make sure the trailer hitch and the coupling are compatible. Make sure the coupling is securely fastened to the vehicle.
- Connect safety chains in a crossing pattern under the tongue and **ATTACH THE BREAKAWAY CABLE TO THE REAR BUMPER OF THE TOWING VEHICLE**. Do not attach the cable to the trailer hitch.
- Make sure directional and brake lights on the trailer are connected and working properly.
- Check that all lug nuts holding wheels on are tight and none are missing.
- Maximum recommended speed for highway towing is 45 mph (72 km/h). Recommended off-road towing speed is not to exceed 10 mph (16 km/h) or less, depending on terrain.
- When towing, maintain extra space between vehicles and avoid soft shoulders, curbs and sudden lane changes. If you have not pulled a trailer before, practice turning, stopping, and backing up in an area away from heavy traffic.

## REPORTING TRAILER SAFETY DEFECTS

If you believe your trailer has a defect which could cause a crash or could cause injury or death, you should immediately inform the National Highway Traffic Safety Administration (NHTSA) in addition to notifying Magnum Power Products LLC.

If NHTSA receives similar complaints, it may open an investigation; and if it finds that a safety defect exists in a group of vehicles, it may order a recall and remedy campaign. However, NHTSA cannot become involved in an individual problem between you, your dealer, or Magnum Power Products LLC.























To contact NHTSA, you may either call the Auto Safety Hotline toll-free at 1-888-327-4236 (TTY:1-800-424-9153), go to <http://www.safercar.gov>; or write to:

Administrator  
NHTSA  
1200 New Jersey Avenue S.E.  
Washington, DC 20590

You can also obtain other information about motor vehicle safety from <http://www.safercar.gov>.

## SAFETY SYMBOL SUMMARY

This equipment has been supplied with numerous safety and operating decals. These decals provide important operating instructions and warn of dangers and hazards. Replace any missing or hard-to-read decals and use care when washing or cleaning the unit. Decal placement and part numbers can be found in the parts manual. Below is a summary of the intended meanings for the symbols used on the decals.

	Safety alert symbol; used to alert you to potential hazards.		Asphyxiation hazard; operate in well ventilated area.		Belt/entanglement hazard; keep body parts clear of this area.
	Hot surface(s) nearby.		Burn/scald hazard; pressurized steam.		Fan hazard; keep body parts clear of this area.
	Dangerous voltage may be present.		Wind hazard; do not set up in wind speeds greater than 60 mph (95 km/h).		Crush hazard; keep body parts clear of this area.
	Ultraviolet radiation hazard; operate only with lens intact.		Electrical storm hazard.		Do not operate near power lines. Contact with power lines can cause electrocution.
	Check diesel fuel fill level.		Allow to cool.		Do not remove guard.
	Read and understand the operator's manual before operating.		Wait 15 minutes.		Fire/explosion hazard; keep open flames away from unit.
	Stop engine.		Disconnect battery before servicing.		Automatic Start
	Anchor/tie down point.		Unit electrical ground.		

00889



# SPECIFICATIONS

## MAGNUM MODEL

**MLT4200IF4**

### Engine

Make/Brand.....	Isuzu
Model .....	4LE2TAGV-03
EPA Tier .....	4f
Horsepower - prime <b>hp (kW)</b> .....	36.2 (27.0)
Horsepower - standby <b>hp (kW)</b> .....	40.2 (30.0)
Operating Speed <b>rpm</b> .....	1800
Displacement <b>in<sup>3</sup> (L)</b> .....	133 (2.18)
Cylinders - qty .....	4
Fuel Consumption - 100% prime <b>gph (Lph)</b> .....	2.1 (7.8)
Battery Type - Group Number .....	24
Battery Voltage (Quantity per Unit) .....	12V (1)
Battery Rating .....	720 CCA

### Generator

Make/Brand.....	Marathon Electric
Model .....	334CSA3028
Type, Insulation .....	Brushless, H

### Generator Set (Engine/Generator)

Output - Standby <b>kW (kVA)</b> .....	20.0 (20.0)
Output Voltage <b>V</b> .....	120/240, single phase
Output Amperes <b>120V (240V) A</b> .....	167 (83)
Frequency <b>Hz</b> .....	60
Power Factor.....	1 (1Ø)

### Weights

Dry Weight <b>lbs (kg)</b> .....	2105 (955)
Operating Weight <b>lbs (kg)</b> .....	2395 (1086)

### Capacities

Fuel Tank Volume <b>gal (L)</b> .....	50 (190)
Usable Fuel Volume <b>gal (L)</b> .....	50 (190)
Coolant (incl. engine) <b>qt (L)</b> .....	12 (11.3)
Oil (incl. filter) <b>qt (L)</b> .....	8.0 (7.6)
Maximum Run Time <b>hrs</b> .....	23.8

### AC Distribution

Circuit Breaker Size .....	100
Voltage Regulation.....	+/-1%
Voltages Available 1Ø .....	120, 240

### Lighting

Lighting Type, Ballast Type .....	Metal Halide, Coil & Core
Lumens.....	440,000
Coverage <b>acres (m<sup>2</sup>)</b> .....	5 - 7 (20,234 - 28,328)

### Trailer

Number of Axles.....	1
Capacity - Axle Rating <b>lbs (kg)</b> .....	3000 (1361)
Tire Size <b>in</b> .....	15
Hitch - Standard .....	2" Ball
Maximum Tire Pressure <b>psi</b> .....	50

*Specifications are subject to change without notice.*

# UNIT DIMENSIONS

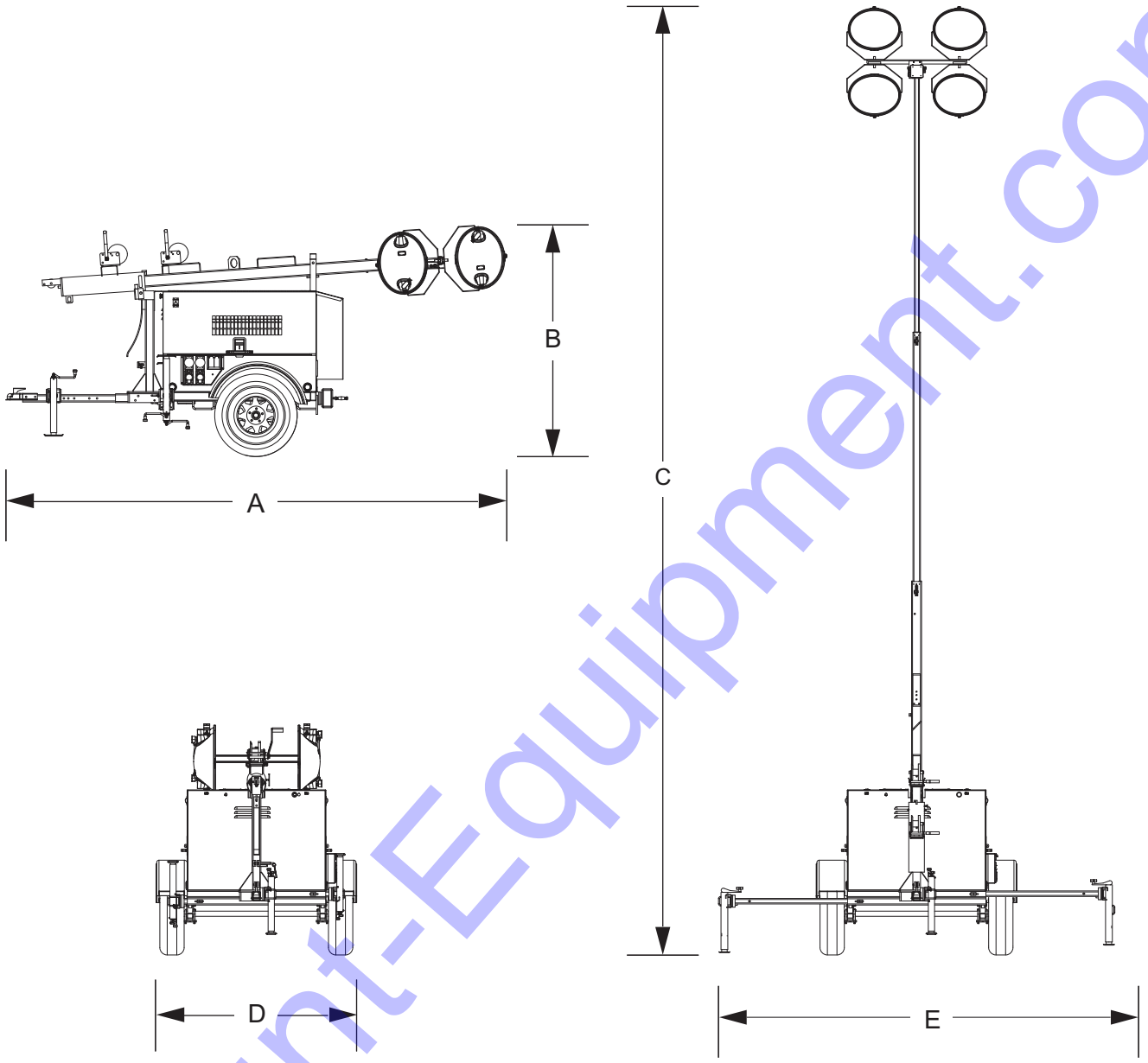

00890

	<b>A</b>	<b>B</b>	<b>C</b>	<b>D</b>	<b>E</b>
<b>MLT4200IF4</b>	115 in (2.92 m)	70 in (1.78 m)	30 ft (9.14 m)	68 in (1.73 m)	140 in (3.56 m)

Specifications are subject to change without notice.

# UNIT SERIAL NUMBER LOCATIONS

Refer to the illustration to locate the unit ID tag and Vehicle Identification Number (VIN) tag on the unit. Important information, such as the unit serial number, model number, VIN and tire loading information are found on these tags. Record the information from these tags so it is available if the tags are lost or damaged. When ordering parts or requesting assistance, you may be asked to provide this information.

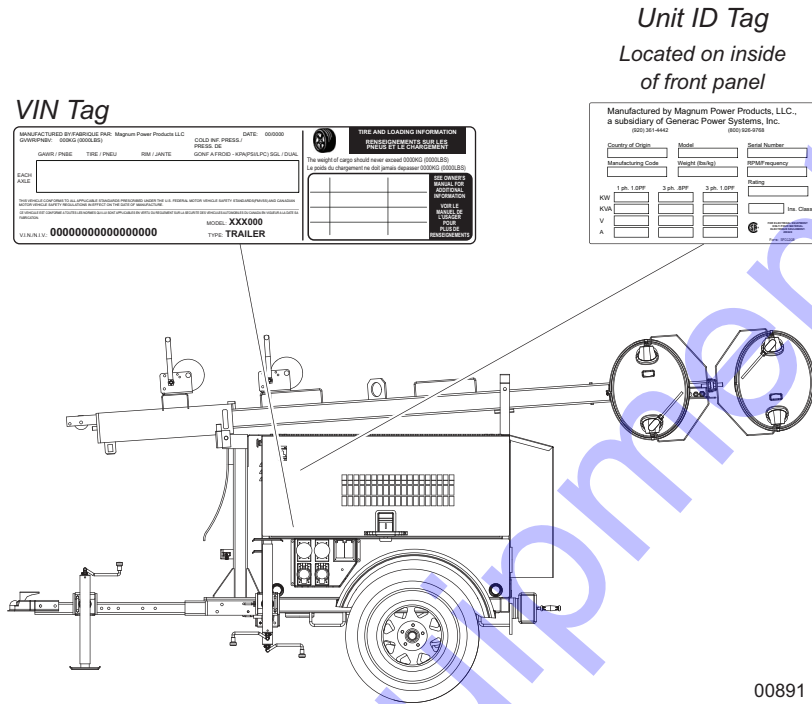

00891

# COMPONENT LOCATIONS

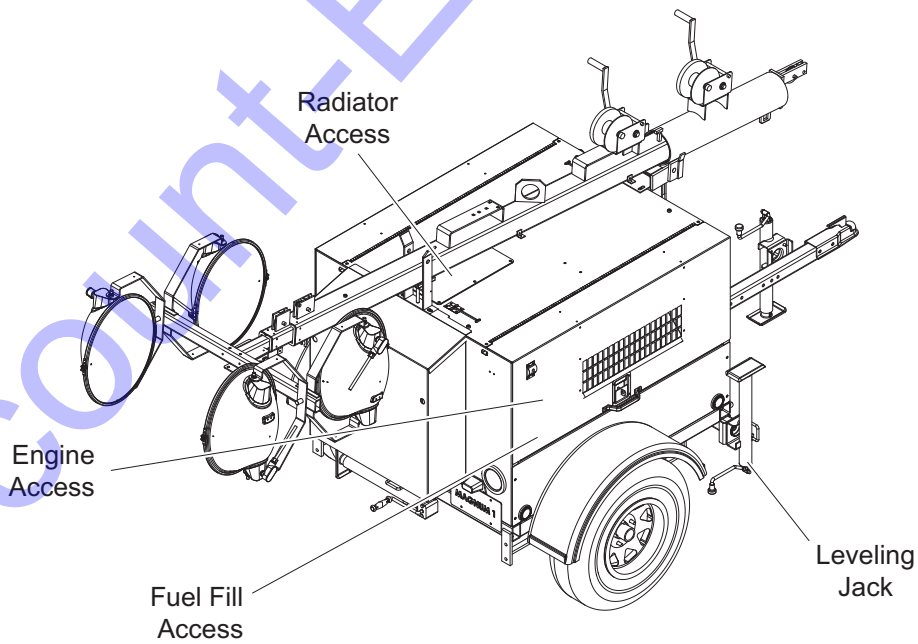
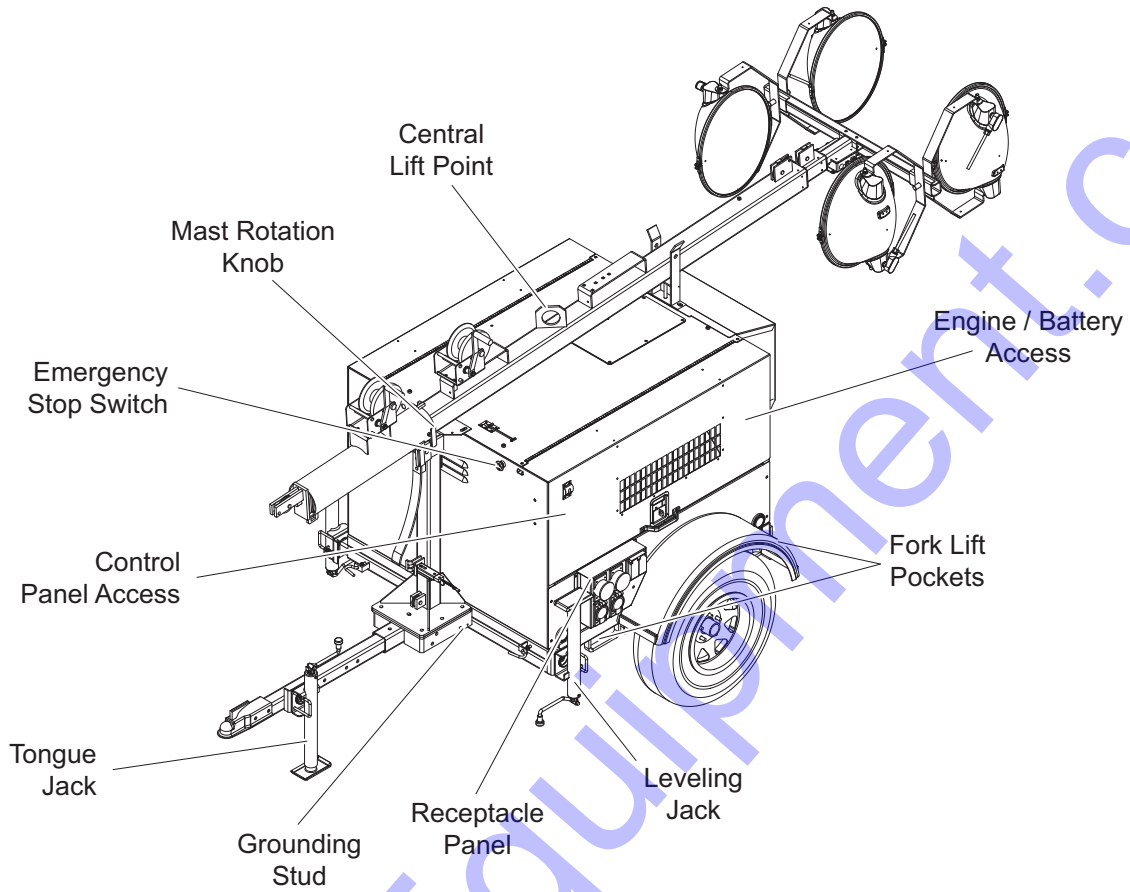

00892

## LIGHT TOWER SET UP

1. For maximum light coverage, locate the unit at ground level or in a spot higher than the area being illuminated by the lamps.

### ▲ WARNING

The mast extends up to 30 ft (9.14 m). Make sure the area above the unit is open and clear of overhead wires and obstructions.

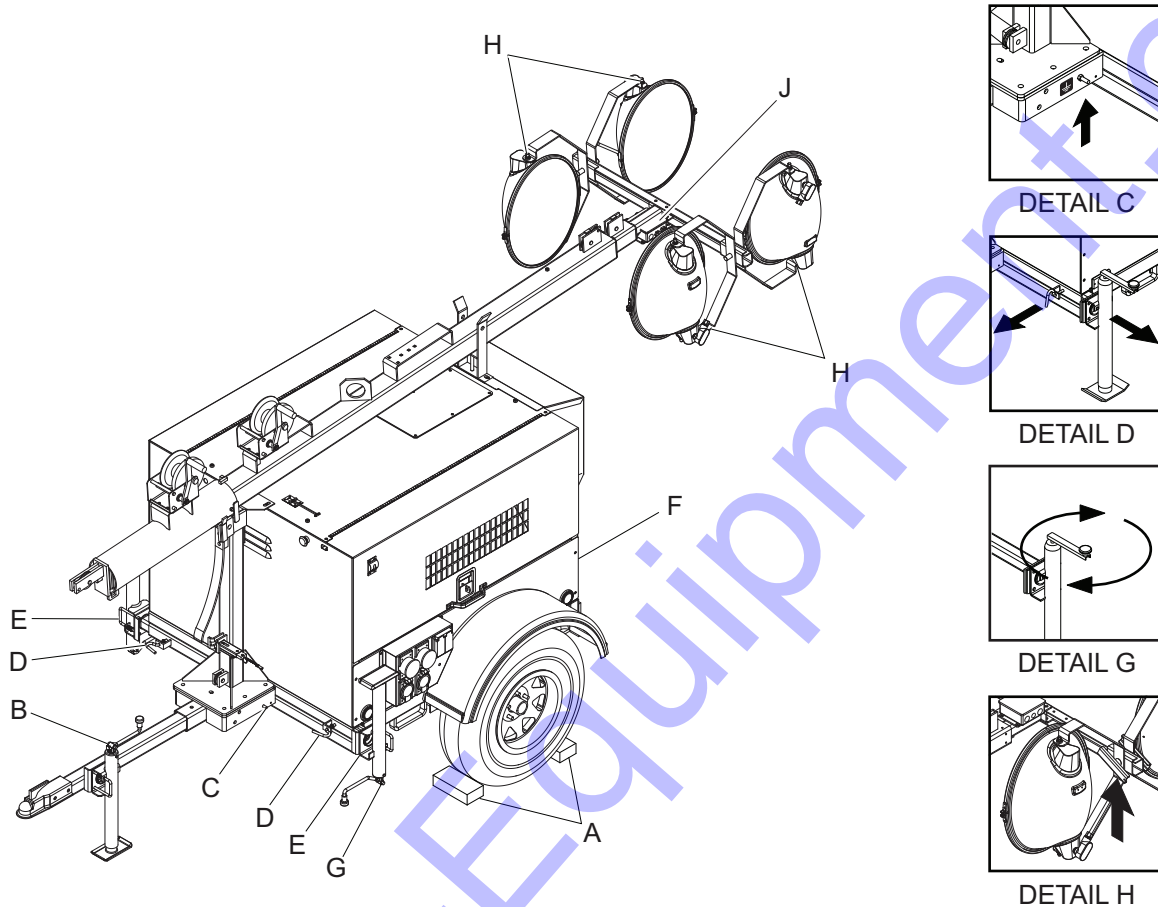

00893

2. Place the unit on firm ground that is relatively flat, then block the wheels to keep it from moving (A). This will make it easier to level the unit.
3. Pull the locking pin on the tongue jack and rotate the jack 90° until the spring loaded pin snaps back into place (B). Turn the jack handle clockwise to raise the trailer tongue off of the towing vehicle.
4. Connect a good earthen ground to the grounding stud on the frame of the trailer near the trailer tongue (C).

**Note:** Refer to local codes for proper grounding requirements.

5. Pull the locking pin (D) on the outrigger (E) and pull each outrigger out until the spring loaded locking pin snaps back into place. Pull the locking pin on the outrigger jack and rotate each 90° so the jack pad is facing down and the spring loaded pin snaps back into place.
6. Pull the locking pin on the rear jack (F) and rotate the jack 90° until the spring loaded pin snaps back into place. Turn the jack handle clockwise to start leveling the trailer. Adjust all four jacks by turning their handles clockwise (G) until they are firmly in contact with the ground and the trailer is as level as possible.
7. Before raising the mast, it may be necessary to adjust the lamps. The lamps may be adjusted up, down, left or right by loosening the wing nuts on the trunnion (H) and aiming them in the desired direction. Tighten the hardware completely and make sure the lamps are connected to the junction box (J).

## RAISING THE MAST

1. Set up and level the unit. Refer to “*Light Tower Set Up*” on page 14.

### ▲ WARNING

The unit must be leveled with the outriggers extended before raising the mast. The outriggers must remain extended while the mast is up. Failure to level the unit or extend the outriggers will severely reduce the stability and could allow the unit to tip and fall.

2. Remove mast cradle locking pin from mast cradle (A).
3. Check the mast cables for excessive wear or damage. Make sure the cables are properly centered in each pulley (B). Check the electrical cord for damage.

### ▲ WARNING

Do not start the unit if insulation on the electrical cord is cut or worn through. Bare wires in contact with the mast or frame may energize the unit and cause electrocution. Repair or replace a damaged cord.

4. Make sure the area around the unit is clear before raising the mast to the vertical position.
5. Remove the safety pin from the mast lock bar (C). Using the handle for the lower mast winch (D), raise the mast until it is vertical and the tab on the mast is positioned into the mast lock. The mast lock bar should snap into place automatically. Secure the lock with the safety pin (E).
6. After the mast is up and locked into place, use the upper mast winch (F) to telescope the mast to the desired height. Extend the mast slowly, making sure the electrical cord is extending at the top sections of the mast. If, for any reason, the winch cable begins to develop slack or any of the mast sections get stuck, **STOP IMMEDIATELY** and contact an authorized service center.

### ▲ CAUTION

Do not extend the mast beyond the colored mark on the middle mast tube (G).

7. The mast can be rotated by loosening the mast rotation knob at the bottom of the mast (H). Turn the mast until the lights face in the desired direction and then tighten the mast rotation knob to secure the mast in position.

### ▲ WARNING

Never raise or lower the mast while the unit is operating. Never remove the safety pin or release the mast lock while the mast is up. Releasing the lock will cause the mast to fall.

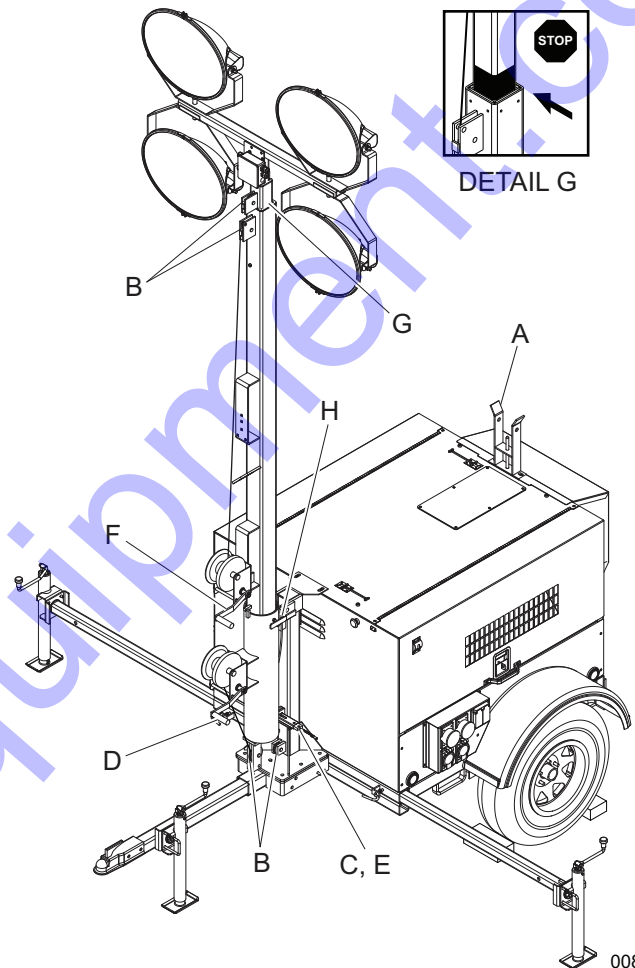
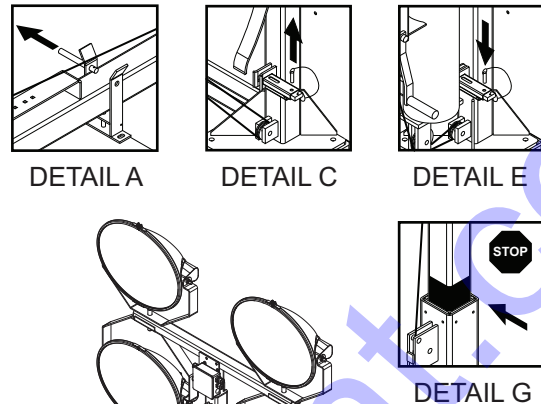

00894



## RAISING THE MAST WITH ELECTRIC WINCH OPTION

1. Set up and level the unit. Refer to “*Light Tower Set Up*” on page 14.

### ▲ WARNING

The unit must be leveled with the outriggers extended before raising the mast. The outriggers must remain extended while the mast is up. Failure to level the unit or extend the outriggers will severely reduce the stability and could allow the unit to tip and fall.

2. Remove mast cradle locking pin from mast cradle (A).
3. Check the mast cables for excessive wear or damage. Make sure the cables are properly centered in each pulley (B). Check the electrical cord for damage.

### ▲ WARNING

Do not start the unit if insulation on the electrical cord is cut or worn through. Bare wires in contact with the mast or frame may energize the unit and cause electrocution. Repair or replace a damaged cord.

4. Make sure the area around the unit is clear before raising the mast to the vertical position.
5. Remove the safety pin from the mast lock bar (C). Press the lower winch control switch (D) upward to raise the mast into the vertical position. Hold the switch until the mast lock is engaged. The mast lock bar should snap into place automatically. Secure the lock with the safety pin (E).

6. Remove the safety pin from the mast lock bar. Cycle through the screens until the mast screen is displayed.

**Note:** On units with the electric winch option, a limit switch on the mast tube will disconnect power to the lower electric winch to prevent deadheading the winch.

7. Press and hold the upper winch control switch (F) upward to telescope the mast to the desired height. Extend the mast, making sure that the coiled electrical cord is extending at the top sections of the mast. If, for any reason, the winch cable begins to develop slack or any of the mast sections get stuck, **STOP IMMEDIATELY** and contact an authorized service center.

### ▲ CAUTION

Do not extend the mast beyond the colored mark on the middle mast tube (G). On units equipped with the electric winch option, a limit switch on the main mast section will disconnect power to the upper electric winch to prevent overextending the mast.

8. The mast can be rotated by loosening the locking knob at the bottom of the mast (H). Turn the mast until the lights face in the desired direction and then tighten the mast rotation knob to secure the mast in position.

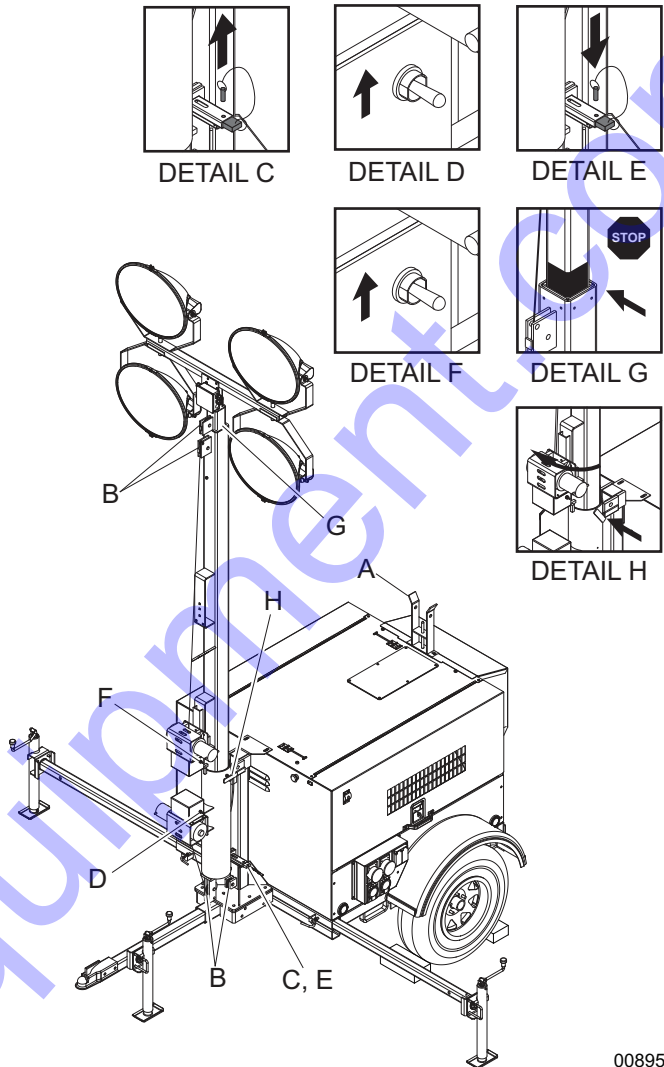

00895

## ⚠ WARNING

Never raise or lower the mast while the unit is operating. Never remove the safety pin or release the mast lock while the mast is up. Releasing the lock will cause the mast to fall.

### MAIN CONTROL PANEL

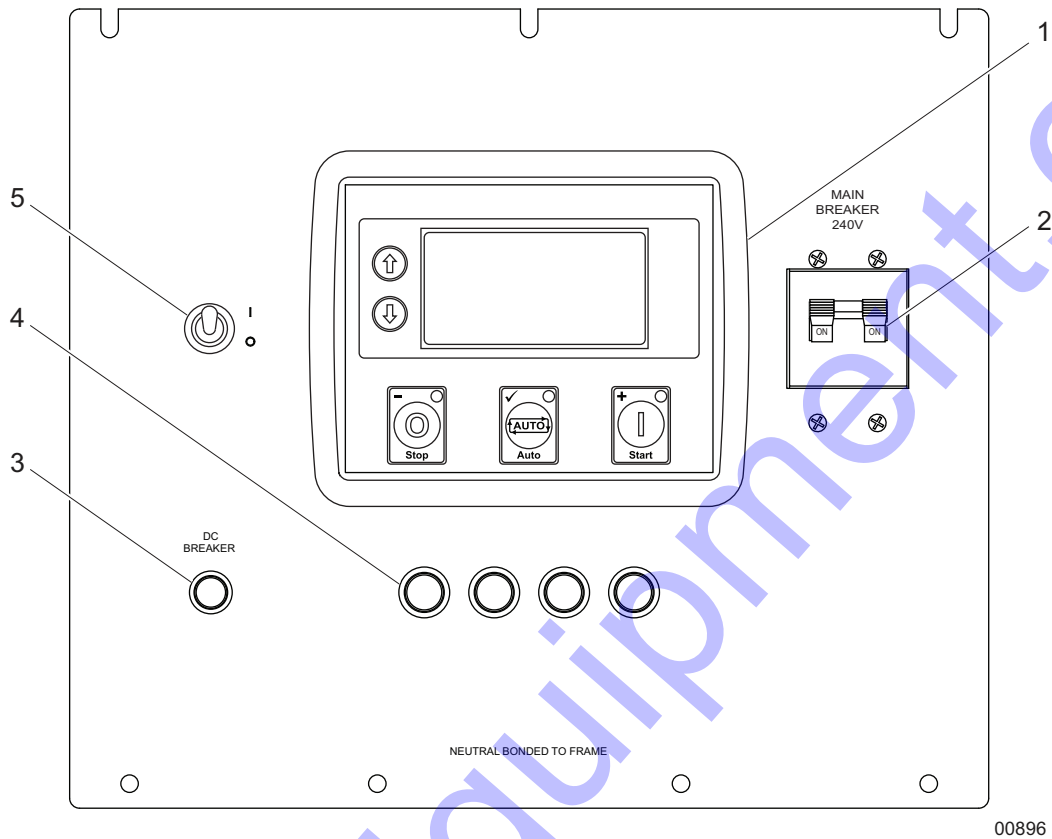

1. **L401 CONTROLLER:** Refer to "*L401 Controller*" on page 18.
2. **MAIN CIRCUIT BREAKER:** This 240V (100A) breaker will disconnect power to the lights and receptacles.
3. **DC BREAKER:** Circuit breaker (10A) for the engine electrical system.
4. **AC/LIGHT BREAKERS (4):** Circuit breakers for the lights.
5. **CONTROL POWER SWITCH:** Powers the L401 controller.

## L401 CONTROLLER

The L401 controller is an auto start controller that monitors the unit and indicates operational status and fault conditions. The controller can be programmed to automatically start or stop based on time schedule, fault condition, or load demand.

The controller constantly monitors vital generator and engine functions for a number of preprogrammed alarm and fault conditions. When a fault condition occurs, the engine can be shut down automatically and the LCD window will show the fault that caused the shutdown. To resume operation, the fault condition must be resolved.

This controller also records a history of unit performance, which may be viewed at any time and will not be lost when the controller is powered down.

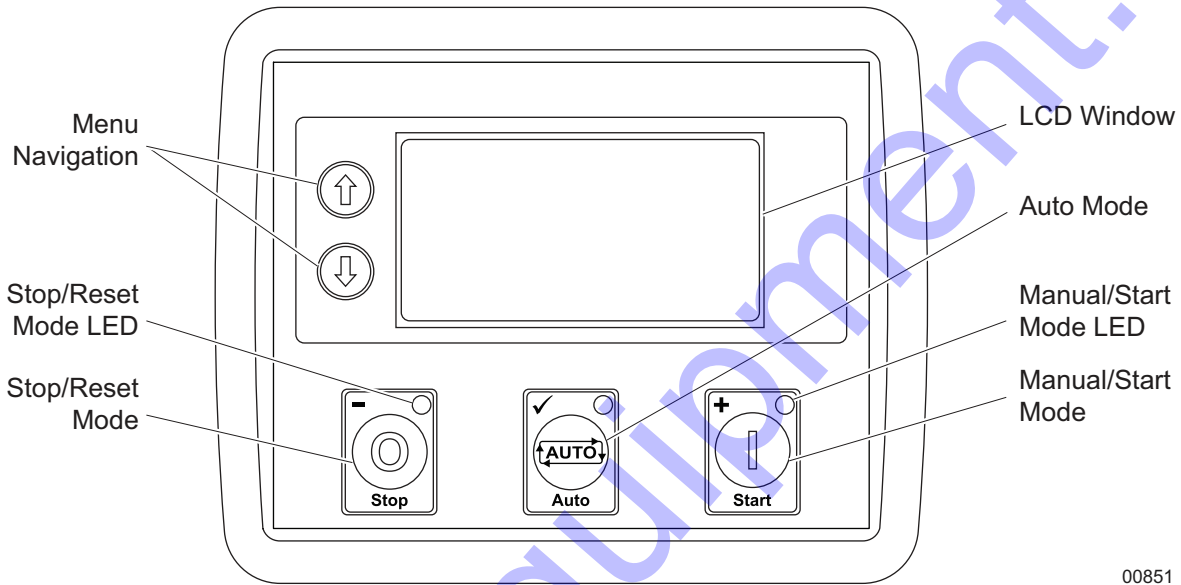

00851

## CONTROLLER FEATURES AND FUNCTIONS

























### THE LIQUID CRYSTAL DISPLAY (LCD) WINDOW







This window will display the various operator screens. By viewing these screens, the operator will be able to monitor both the engine and generator status while the unit is running.

Screen Icon	Screen Data	Unit	Alarm Icon
Active Config	Screen Data	Unit	
FPE/Auto Run	Screen Data	Unit	Mode Icon
<b>Light Output Icons</b>			













This table lists the possible non-alarm icons displayed on the operator screens.























Icon	Details
Screen Icons	
	The default home page which displays generator voltage and the Auto Run icon

Icon	Details
	Generator voltage and frequency screen
	Current and load screen
	Engine speed screen
	Hours run screen
	Battery voltage screen
	Oil pressure screen
	Coolant temperature screen
	Fuel sender screen
	Event log
	Current time held in the unit
	The current valve of the scheduler run time and duration
	ECU diagnostic trouble codes
	Oil filter maintenance timers
	Air filter maintenance timers
	Fuel filter maintenance timers
<b>Active Configurations</b>	
	Main configuration
	Alternative configuration
<b>Front Panel Editor (FPE) / Auto Run Icons</b>	
	Remote start input is active
	Low battery run is active
	Scheduled run is active
<b>Mode Icons</b>	
	Engine is at rest and the unit is in Stop mode
	Engine is at rest and the unit is in Auto mode
	Engine is at rest and the unit is waiting for a manual start
	A timer is active (i.e. cranking time, crank rest, etc.)





Icon	Details
	Engine is running, and all timers have expired, either on or off load. The animation speed is reduced when running in Idle mode.
	Unit is in the front panel editor
	USB connection is made to the controller
	Configuration file or engine file becomes corrupted
Light Output Icons	
	Corresponding light output has been configured and is not active
	Corresponding light output has been configured and is active
	A timer to delay the light output is activating or de-activating

This table lists the possible alarm icons displayed on the operator screens. In the event of a warning alarm, the LCD only displays the alarm icon. In the event of an electrical trip or shutdown alarm, the controller displays the alarm icon and the Stop mode button LED begins to flash. If multiple alarms are active at the same time, the alarm icon automatically cycles through all the appropriate icons to indicate each alarm which is active.

Icon	Fault	Description
Warning Alarm Icons		
	<b>Fail To Stop</b>	The controller has detected a condition that indicates that the engine is running when it has been instructed to stop.  <i>Note: 'Fail to Stop' could indicate a faulty oil pressure sensor. If engine is at rest, check oil sensor wiring and configuration.</i>
	<b>Low Fuel Level</b>	The level detected by the fuel level sensor is below the low fuel level setting.
	<b>Battery Under Voltage</b>	The DC supply has fallen below or risen above the low volts setting level.
	<b>Battery Over Voltage</b>	The DC supply has risen above the high volts setting level.
	<b>Generator Under Voltage</b>	The generator output voltage has fallen below the pre-set pre-alarm setting after the Safety On timer has expired.
	<b>Generator Over Voltage</b>	The generator output frequency has risen above the pre-set pre-alarm setting.
	<b>Generator Under Frequency</b>	The generator output frequency has fallen below the pre-set pre-alarm setting after the Safety On timer has expired.
	<b>Generator Over Frequency</b>	The generator output frequency has risen above the pre-set pre-alarm setting.
	<b>CAN ECU Fault</b>	The engine ECU has detected an alarm.
	<b>CAN Data Fail</b>	The controller is configured for CAN operation and does not detect data on the engine Can data link.
	<b>Immediate Over Current</b>	The measured current has risen above the configured trip level.
	<b>Delayed Over Current</b>	The measured current has risen above the configured trip level for a configured duration.

Icon	Fault	Description
	<b>Low Current</b>	The measured current has fallen below the configured trip level. This is used to detect lamp failure.
	<b>Oil Filter Maintenance Alarm</b>	Maintenance due for oil filter.
	<b>Air Filter Maintenance Alarm</b>	Maintenance due for air filter.
	<b>Fuel Filter Maintenance Alarm</b>	Maintenance due for fuel filter.
<b>Electrical Trip Alarm Icons</b>		
	<b>Engine High Temperature</b>	The controller detects that the engine coolant temperature has exceeded the high engine temperature pre-alarm setting level after the Safety On timer has expired.
	<b>Low Fuel Level</b>	The level detected by the fuel level sensor is below the low fuel level setting.
	<b>Delayed Over Current</b>	The measured current has risen above the configured trip level for a configured duration.
	<b>Low Current</b>	The measured current has fallen below the configured trip level. This is used to detect lamp failure.
<b>Shutdown Alarm Icons</b>		
	<b>Fail To Start</b>	The engine has failed to start after the configured number of start attempts.
	<b>Low Oil Pressure</b>	The controller detects that the engine oil pressure has fallen below the low oil pressure pre-alarm setting level after the Safety On timer has expired.
	<b>Under Speed</b>	The engine speed has fallen below the under speed pre-alarm setting.
	<b>Over Speed</b>	The engine speed has risen above the over speed pre-alarm setting.
	<b>Low Fuel Level</b>	The level detected by the fuel level sensor is below the low fuel level setting.
	<b>Battery Under Voltage</b>	The DC supply has fallen below or risen above the low volts setting level.
	<b>Battery Over Voltage</b>	The DC supply has risen above the high volts setting level.
	<b>Generator Under Voltage</b>	The generator output voltage has fallen below the pre-set pre-alarm setting after the Safety On timer has expired.
	<b>Generator Over Voltage</b>	The generator output frequency has risen above the pre-set pre-alarm setting.
	<b>Generator Under Frequency</b>	The generator output frequency has fallen below the pre-set pre-alarm setting after the Safety On timer has expired.
	<b>Generator Over Frequency</b>	The generator output frequency has risen above the pre-set pre-alarm setting.
	<b>CAN ECU Fault</b>	The engine ECU has detected an alarm.
	<b>CAN Data Fail</b>	The controller is configured for CAN operation and does not detect data on the engine Can data link.
	<b>Emergency Stop</b>	The emergency stop switch has been depressed.
	<b>Delayed Over Current</b>	The measured current has risen above the configured trip level for a configured duration.



Icon	Fault	Description
	<b>Low Current</b>	The measured current has fallen below the configured trip level. This is used to detect lamp failure.
	<b>Oil Filter Maintenance Alarm</b>	Maintenance due for oil filter.
	<b>Air Filter Maintenance Alarm</b>	Maintenance due for air filter.
	<b>Fuel Filter Maintenance Alarm</b>	Maintenance due for fuel filter.

Warnings are non-critical alarm conditions and do not affect the operation of the generator system, they serve to draw the operator's attention to an undesirable condition. By default, warning alarms are self-resetting when the fault condition is removed.

Electrical trips are latching and stop the generator but in a controlled manner. On initiation of the electrical trip condition, the controller de-energizes all the outputs, including the lights, to remove the load from the generator. Once this has occurred, the controller start the cooling timer and allows the engine to cool off-load before shutting down the engine.

Shutdown alarms are latching and immediately stop the generator. On initiation of the shutdown condition, the controller de-energized all the outputs, including the lights, to remove the load from the generator. Once this has occurred, the controller shuts the generator set down immediately to prevent further damage.

**Note:** *The alarm condition must be rectified before a reset will take place. If the alarm condition remains, it is not possible to reset the unit. The exception to this is the Low Oil Pressure alarm and similar 'active from safety on' alarms, as the oil pressure is low with the engine at rest.*

To remove the fault of the latching alarms, refer to ["Resetting the Maintenance Alarms" on page 36.](#)

**Note:** *The LCD backlight is on if the unit has sufficient voltage while the unit is turned on, unless the unit is cranking for which the backlight is turned off.*

If the controller is left in Stop mode without pressing any buttons for 30 minutes, the controller enters Power Save mode. To 'wake' the controller, press the Stop/Reset (O) button.

#### AUTO MODE

This button will place the unit into Auto mode. This mode allows the generator to operate fully automatic, starting and stopping as required with no user intervention.

#### MANUAL/START MODE LED

This LED will be lit when the unit is in Manual mode.

#### MANUAL/START MODE

This button will start the engine and place the unit in Manual mode, provided there are no shutdown errors, and the engine satisfies the start status.

#### STOP/RESET MODE

This button will shut down the unit and put the controller into Stop mode, whether in Manual mode or Auto mode.

### ⚠ CAUTION

In case of an emergency, always press the emergency stop switch located on the side of the unit to stop the engine immediately. The Stop/Reset (O) button may delay the engine shutdown if stop faults exist.

## NOTICE

To prevent damage to the generator and connected equipment, remove all loads from the generator by opening all circuit breakers (turn to the OFF (O) position) before pressing the Stop/Reset (O) button.

### STOP/RESET MODE LED

This LED will be lit when the unit is in Stop mode and will flash when an Electrical Trip and Shutdown Fault has occurred.

### MENU NAVIGATION

These buttons (↑, ↓) are used to navigate through the different operator screens.

## OPERATOR SCREENS

The information displayed on the operator screens can be used to identify, diagnose and troubleshoot unit shutdown conditions and poor unit performance.

To enter the navigation menu, use the following procedure:

1. Press both the ↑ and ↓ buttons simultaneously.

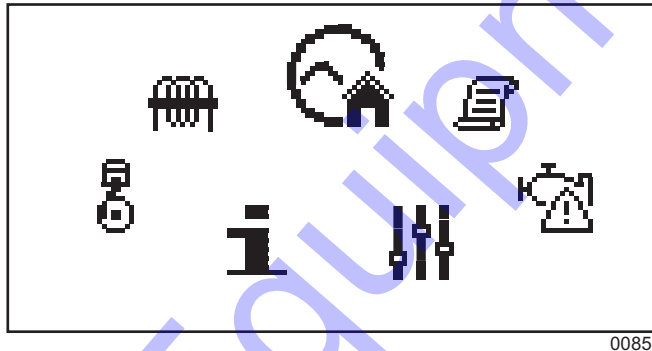

2. To select the required icon, press the ↑ button to cycle right and the ↓ button to cycle left until the desired operator screen section is reached.
3. Once the desired icon is at the top, press the Auto button to enter that operator screen section.

**Note:** If the Auto button is not pressed after five minutes of inactivity, the display automatically returns to the Home icon.

Icon	Description
	Home and generator voltage and frequency operator screens
	Generator current and load operator screens
	Engine screens
	Controller screens
	Mast and light screens
	Engine DTCs (Diagnostic Trouble Codes) if active
	Event log

## HOME SCREEN

The Home screen is the default screen of the controller and will display after the controller has powered up. The controller will automatically return to this screen from any other screen after a period of inactivity.

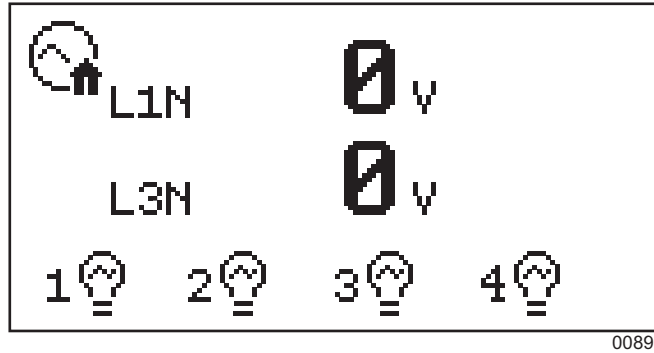

## ENGINE SCREENS

The Engine screens will display the speed, run time, battery voltage, coolant temperature, oil pressure, fuel level and when maintenance is due for the oil, air, and fuel filters.

## GENERATOR SCREENS

The Generator screens will display the voltage, frequency, current, load per phase, total load, power factor per phase, and average power factor.

## CONTROLLER SCREENS

The Info screens contain information about the controller such as the controller's date and time, the scheduler settings, the product description and USB identification number, and the application and engine version.

## MAST AND LIGHT SCREENS

The mast and light screens gives access to raise and lower the mast along with turning on and off the lights. For light operation, refer to "[Light Operation](#)" on page 28.

**Note:** Mast operation through the controller is only available for vertical mast units.

## ENGINE DTCS

This screen displays active Diagnostic Trouble Codes (DTC) only if the engine ECU generating a fault code. These alarm conditions are detected by the engine ECU and displayed by the controller.





To view the engine DTC(s), press both the ↑ and ↓ buttons simultaneously, the navigation menu is then displayed. Once entered, cycle to the DTC section and enter.

To view the active DTC(s) alarms, repeatedly press the ↑ and ↓ buttons until the LCD window displays the alarm.

Continue to press the ↑ and ↓ buttons will cycle through the alarms.

To exit the active DTC(s) alarm section, press the ↑ and ↓ buttons simultaneously to enter the navigation menu. Once entered, cycle to the desired operator screen.

Icon	Fault	DTC Description
	<b>Check Engine Fault</b>	The engine ECU has detected a fault not recognized by the controller, contact the engine manufacturer for support.
	<b>Low Oil Pressure</b>	The engine ECU has detected that the engine oil pressure has fallen below its configured low oil pressure alarm level.

Icon	Fault	DTC Description
	<b>Under Speed</b>	The engine ECU has detected that the engine speed has fallen below its configured under speed alarm level.
	<b>Over Speed</b>	The engine ECU has detected that the engine speed has risen above its configured over speed alarm level.
	<b>Low Fuel Level</b>	The engine ECU has detected that the engine's fuel level has fallen below its configured low fuel level alarm.
	<b>Battery Under/Over Voltage</b>	The engine ECU has detected that the engine's DC supply has fallen below or risen above its configured alarm level.

## EVENT LOG

The controller's event log displays a list of the last 15 record electrical trip or shutdown events and the engine hours at which they occurred. Once the log is full, any subsequent electrical trip or shutdown alarms overwrites the oldest entry in the log. Hence, the log always contains the most recent shutdown alarms.

To view the event log, press both ↑ and ↓ buttons simultaneously, the navigation menu is then displayed. Once entered, cycle to the event log section and press the Auto button to enter. Repeatedly press the ↑ or ↓ buttons until the LCD window displays the desired event.

Continuing to press down the ↑ or ↓ buttons will cycle through the past alarms after which they display shows the most recent alarm and the cycle begins again.

To exit the event log, press the ↑ and ↓ buttons simultaneously to enter the navigation menu. Once entered, cycle to the desired operator screen.

## PRESTART CHECKLIST

Before starting the unit, all items in the prestart checklist must be completed.

- Read and understand **ALL** safety sections at the beginning of this manual.
- Ensure all maintenance procedures are up to date. For more information, refer to *“General Maintenance” on page 35* and *“Basic Maintenance Schedule - Isuzu Engine” on page 36*.
- The unit must be level.
- The unit must be dry. Check for any water inside, on, or near the unit; dry if needed.
- Ensure the unit is properly grounded to a good earthen ground. Installation should be in compliance with the National Electrical Code (NEC), state and local regulations.
- Switch the Control Power switch to the OFF (O) position.
- Switch all circuit breakers to the OFF (O) position.
- Inspect all electrical cords; repair or replace any that are cut, worn, or bare.
- Ensure all winch cables are in good condition and centered on each pulley. Do not use if cables are kinked or beginning to unravel.
- Check oil, coolant, and fuel levels. For more information, refer to *“General Maintenance” on page 35*.
- Ensure engine battery connections are secure.
- Turn the battery disconnect switch on, if equipped.
- Check the engine fan belt tension and condition.
- Check the engine fan belt guard.
- Check the engine exhaust system for loose or rusted components.
- Ensure all covers are in place and secure.
- Ensure the emergency stop switch is pulled out.

## ENGINE BREAK-IN REQUIREMENTS

**Note:** The EPA final tier 4 Isuzu engines have an engine break-in duration that will prohibit the unit from providing rated standby power upon factory delivery. The unit is tested at the factory and is initially capable of a prime standby power output. The engine performance will increase to 95% of full rated power during the first 20 hours of loaded operation. The unit will provide full rated power after the complete engine break-in period of 70 hours of loaded operation.

Operate the engine at heavy loads (60-90% [24-36kW] of rated output maximum) as much as possible during the break-in period. If the engine has spent significant time at idle, constant speed(s) and/or light load or if makeup oil is required, a longer break in period may be needed. Refer to the engine operator's manual for a full description of necessary procedures on the addition of oil and extension of the break-in period. For more information on regular maintenance intervals, refer to *"Basic Maintenance Schedule - Isuzu Engine"* on page 36.

## EMERGENCY STOP SWITCH

The unit is equipped with one emergency stop switch. For location of the emergency stop switch, refer to *"Component Locations"* on page 13. The red switch is clearly labeled "EMERGENCY STOP." The switch can be accessed and activated with all doors closed and locked.

Activate the emergency stop switch by pushing the red button in until it locks down. This will open the fuel circuit, shutting down the engine. The switch will remain closed until it is pulled out.

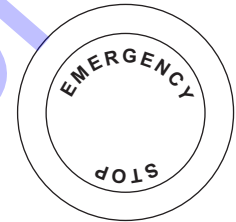

00230

### NOTICE

Use the emergency stop switch only when the unit must be shut down immediately. For any other shut down, refer to *"Shutting Down the Unit"* on page 32.

## MANUAL STARTING OF THE UNIT

All units equipped with the L401 controller will initially start up in Stop mode. Use the following procedure to start the generator in Manual mode:

1. Check that the main circuit breaker and the individual circuit breakers for each of the lights are in the OFF (O) position.
2. Move the Control Power switch to the ON (I) position.
3. When the controller powers up, the Home screen will be displayed and the controller will be in Stop mode as indicated by the Stop LED being lit. Press the Start button to initiate the startup procedure and start the engine, provided there are no engine faults preventing the unit from starting. The Start LED will now become lit.

**Note:** The controller can be started from any screen. It may take a few seconds for the engine to run smoothly and reach its governed operating speed.

4. If the engine does not start after the first cranking attempt, the engine will pause for 15 seconds to allow the starter to cool. The controller backlight will go out. The engine will make two more attempts to start for a total of three crank cycles.

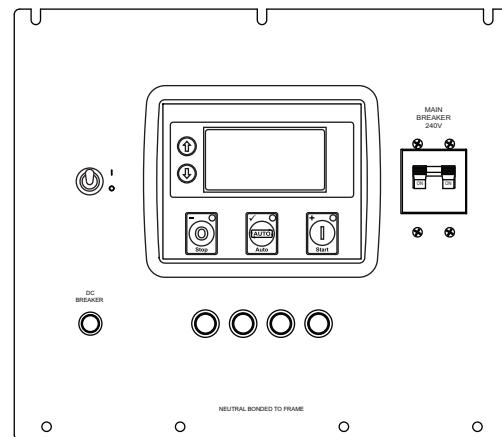

00898

5. Should the engine not start and run within three starting cycles, the LCD window will show the Fail to Start alarm icon (⚠️). The starting sequence may be repeated after the starter has had a minimum of two minutes to cool. Pressing the Stop/Reset (O) button will clear the alarm and reset the controller.
6. Once the engine starts, it will immediately begin speeding up to a constant 1800 rpm. The engine may hunt or change speeds until operating speed is reached. After a few minutes of operation, the engine will be warmed up and the operator screens will show engine and generator operating parameters. The animated engine running icon (🌀) will be displayed.
7. Check the generator for excessive noise or vibration and any coolant, oil, or fuel leaks before applying any loads.
8. Check that the frequency (Hz) is correct on the Generator screen. With no loads connected to the generator, the frequency should read approximately 60 Hz, depending on the type of engine governing used.
9. If all wiring connections have been made correctly, switch the main circuit breaker to the ON (I) position and then add any loads attached to the receptacles by switching the respective circuit breaker to the ON (I) position. You will notice a slight change in engine sound when a load is applied to the unit.
10. Once the engine is running, allow it to reach normal operating temperature before switching on any loads.

## AUTO (REMOTE) STARTING OF THE UNIT

Auto mode is used when the unit is started from a location other than the control panel by using a transfer switch. Auto (remote start) is the normal setting when the generator is being used as a standby power supply. Before putting the unit in the Auto mode, review the *“Prestart Checklist” on page 25* and *“Manual Starting of the Unit” on page 26*. Also following any warnings and information on isolating the generator with a transfer switch if the unit is to be used as a standby power supply. Then continue with the steps described below:

1. Perform a manual start of the unit at least once to verify that the engine is operating correctly.

**Note:** *The lights are automatically disconnected on startup. The main circuit breaker can be left on if no other loads are connected, except for the lights. Any connected external loads must be disconnected by a transfer switch when starting the unit.*

2. If a check of the remote start circuit is desired:
  - a. Remove the wires from the remote start terminal block. Press the Auto button. The Auto LED will be lit.
  - b. Attach a jumper wire (minimum 16 gauge) across the two terminals on the remote start terminal block. This applies a ground to the L401 controller to close the starting circuit contacts. The engine should crank, start and run.
  - c. Remove the jumper wire from the remote start terminal block and the engine will stop.
  - d. Reconnect any necessary wires from the remote start switch (transfer switch) to the remote start terminal block.
3. Confirm the unit is in Auto mode. The Auto LED should be lit.
4. Secure the unit by closing and locking all access doors.
5. The unit is now ready for remote starting.

## AUTOMATIC SHUTDOWN

This unit is equipped with a low oil pressure and high coolant temperature automatic shutdown system. This system will automatically shut off the fuel supply to stop the engine if oil pressure drops too low or the engine exceeds normal operating temperature. Return the Control Power switch to the OFF (O) position to reset the unit after you have determined the cause of the shutdown.

**Note:** *The unit will turn off the lights at the stop time, but the engine will continue to run for up to five minutes as a cool down. If the stop button is pressed, the unit will immediately stop.*



## LIGHT OPERATION

The lights are turned on and off using the L401 controller. To view the mast and light screens, press both ↑ and ↓ buttons simultaneously, the navigation menu is then displayed. Once entered, cycle to the mast and light section and enter.

### ▲ WARNING

**NEVER operate the lights without the protective lens cover, or with a lens cover that is cracked or damaged. The bulbs in the light fixtures produce high temperatures and operate under pressure. A broken or missing lens cover could cause the bulbs to shatter, causing injury.**

1. Once the engine is up to temperature and running smoothly, switch the main circuit breaker to the ON (I) position.
2. Cycle through the mast and light screens until you find the screen that selects the light (s) to be turned on or off. To turn the light(s) on, press and hold the ↑ button until the timer bar finishes. To turn the light(s) off, press and hold the ↓ button until the timer bar finishes.

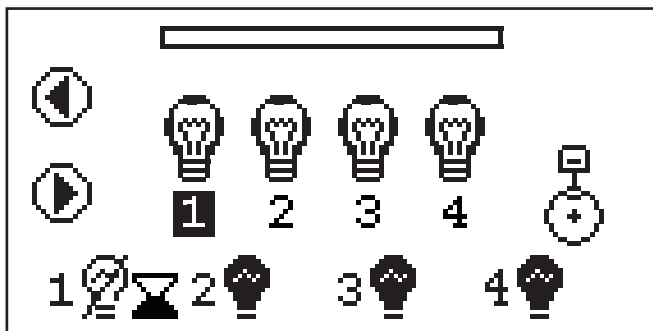

Turn Lights On or Off Individually

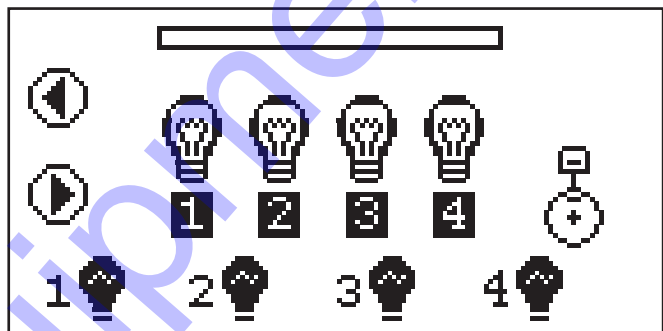

Turn Lights On or Off at Same Time

00899

**Note:** The lights can be turned on or off individually or all together.

3. The lights require a warm up period of 5-15 minutes before they reach full output. If the lights are shut down, they require a cool down period of approximately 10 minutes before they can be switched on again.
4. The light tower uses four 1000W bulbs. When checking or replacing the bulbs, wipe them with a clean cloth to avoid leaving any grease, oil residue or fingerprints on the glass. Any residue can create a hot spot on the bulb, causing premature bulb failure.

### ▲ CAUTION

Bulbs become extremely hot when in use. Allow bulb fixture to cool 10-15 minutes before handling or lowering the mast.

## VOLTAGE REGULATION

Units are equipped with an electronic voltage regulator. The voltage regulator controls the output of the generator by regulating the current into the exciter field. The regulator has three screwdriver adjustable potentiometers that may be adjusted for voltage, stability and voltage roll-off (U/F). The voltage regulator is adjusted before shipment from the factory. Contact Magnum Power Products LLC for additional information before attempting to adjust the voltage regulator.

## DERATING FOR ALTITUDE

All units are subject to derating for altitude and temperature; this will reduce the available power for operating tools and accessories connected to the receptacles. Typical reductions in performance are 2-4% for every 1000 ft (305 m) of elevation and 1% per 10°F (5.6°C) increase in ambient air temperature over 72°F (22°C).

## WET STACKING

The unit is powered by a diesel engine. Diesel engines are susceptible to wet stacking if lightly loaded. Wet stacking occurs when an engine is run at less than 30% of its full load capacity, causing unburned fuel to accumulate in the exhaust system. Wet stacking can be detected by continuous black exhaust when the unit is under a constant load. It can also cause fouling of injectors and buildup on engine valves. Diesel engines operate properly when applied loads are between 30% and 100% capacity. Appropriate generator sizing is determined by the anticipated load. If the unit is in a wet stack condition, load the unit heavily for five hours or until the exhaust is clear.

## RECEPTACLE PANEL

The receptacle panel is equipped with six receptacles for running accessories or tools from the generator. Power is supplied to the receptacles any time the engine is running and the main circuit breaker is switched to the ON (I) position. Each receptacle has an individual circuit breaker which is located behind the receptacle panel. The breakers are labeled with the corresponding amperage for the receptacle they protect. The standard receptacle panel is equipped with two of each of the following receptacles:

1. 240V/30A twist-lock
2. 120V/20A GFCI
3. 240V/50A twist-lock

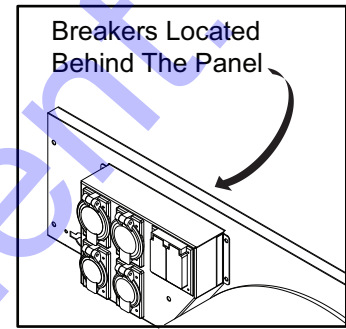
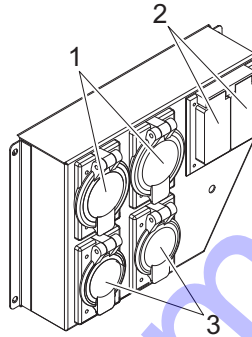

00194

Should the main breaker trip, remove some of the load to the receptacles before turning them back on.

With all of the lights off, the full generator output may be used with the receptacles.

**Note:** To ensure proper grounding, anytime the generator is providing power to any equipment or load panels that do not have a grounded plug, a ground wire **MUST BE** added between the equipment and the grounding stud on the receptacle panel per the National Electrical Code (NEC), state and local regulations.

## REMOTE START TERMINAL BLOCK

The remote start terminal block provides a connection for installation of a remote start switch which will allow the unit to be started by a remote dry-contact closure switch. For location of the remote start terminal block, refer to "[Main Control Panel](#)" on page 17.

Before entering Auto mode, verify that the contacts on any remote switch linked to the unit are **OPEN**. If the contacts on a remote switch are closed, the engine will crank and start when Auto mode is entered. Attach the switch leads to the two unused terminals on the unit's remote start terminal block. For additional information, refer to "[Auto \(Remote\) Starting of the Unit](#)" on page 27.

Remote Start  
Switch Terminals

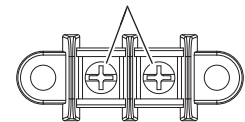

00886

## TRANSFER SWITCH

### NOTICE

The generator neutral is bonded to ground when shipped from the factory. The bonding plate will need to be removed when the generator is used as a standby power supply. Installation should be in compliance with the National Electrical Code (NEC), state and local regulations.

When the generator is used as a standby power supply, it must be equipped with a transfer switch which isolates it from the utility's distribution system. A transfer switch is designed to transfer electrical loads from the normal power source (utility) to the emergency power source (generator) when normal voltage falls below a prescribed level. The transfer switch automatically returns the load back to the normal source when power is restored back to operating

levels.

### ⚠ DANGER

**FAILURE TO ISOLATE THE GENERATOR FROM THE NORMAL POWER UTILITY CAN CAUSE POTENTIALLY LETHAL VOLTAGE TO BACKFEED INTO THE UTILITY LINES. THIS MAY RESULT IN INJURY OR ELECTROCUTION OF UTILITY WORKERS NEARBY. MAKE SURE THE GENERATOR IS ISOLATED BY A TRANSFER SWITCH FROM ANY LOCAL UTILITY LINES. THIS ALSO APPLIES IF THE GENERATOR IS BEING USED AS A BACKUP TO SOME OTHER TYPE OF POWER SUPPLY.**

Installation of a transfer switch or other type of remote starting device is the responsibility of the generator user. Installation of such devices must be performed by following all directions supplied by the manufacturer of the switch. If attaching the generator to a power supply normally serviced by a utility company, notify the utility company and check state and local regulations. Familiarize yourself with all instructions and warning labels supplied with the switch.

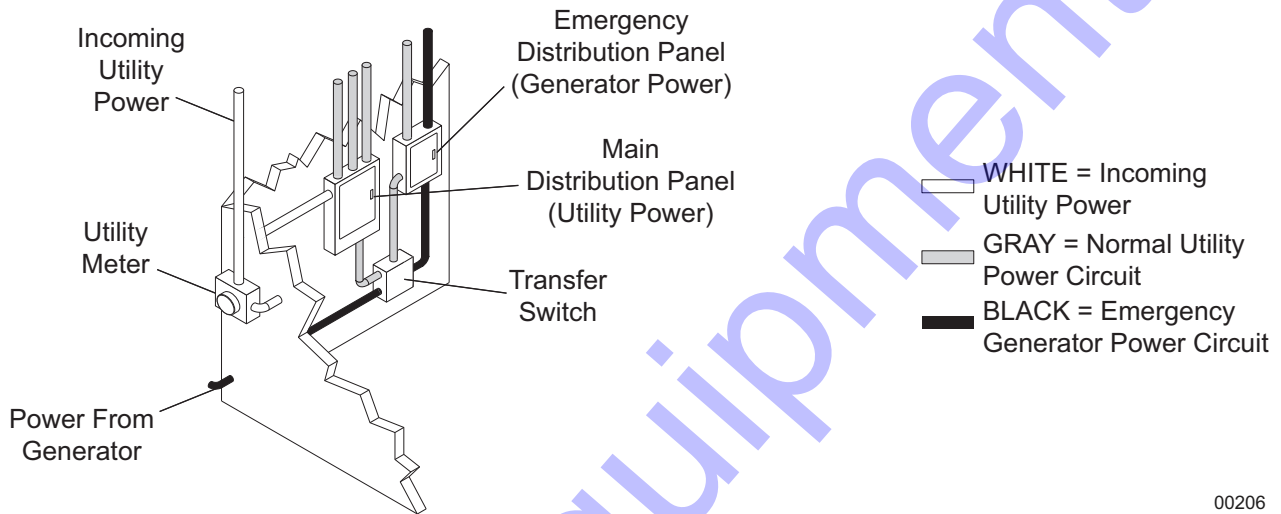

00206

### ⚠ WARNING

**ONLY a licensed electrician should perform wiring or related connections to the generator. Installation should be in compliance with the National Electrical Code (NEC), state and local regulations. Failure to follow these procedures could result in property damage, personal injury or death. Before any connections are attempted, make sure the main circuit breaker and the Control Power switch are in the OFF (O) position and that the negative (-) battery cable has been disconnected from the battery.**

### NOTICE

When using the generator as a standby or substitute power supply, make sure the output voltage and phase rotation of the generator match those of the local power utility. Improper voltage or phase rotation may cause equipment damage or malfunction.

## AUTO EXERCISE TIMER

The L401 controller is capable of starting and stopping the unit automatically, based on a programmable schedule.

Units installed in a standby application should be exercised regularly to maintain operating condition and to ensure responsiveness in an emergency situation. Use the following procedures to operate the unit in Auto mode:

**Note:** The controller **MUST** be in Auto mode to run at the programmed time. Use a trickle or solar battery charger to prevent the controller from draining the battery while in Auto mode.

1. Push both the Stop/Reset (O) and Auto buttons simultaneously.

2. Push the ↑ button until the wrench (🔧) icon is selected. Push the Auto button to select it and enter the parameters.
3. Adjust the parameter number to enable the desired timer. When the correct parameter number is showing, press the Auto button to enter it. Press the Manual/Start (I) button to change it to 1 to enable the timer and press the Auto button to save it.

**Note:** The ↑ and ↓ buttons will adjust the hundredths place of the parameter number and the Manual/Start (I) and Stop/Reset (O) buttons will adjust the low digits. Up to eight events can be scheduled at a time.

4. Adjust the parameter number to adjust the time of the desired event and then press the Auto button to enter it. Press the Manual/Start (I) and Stop/Reset (O) buttons to change the time. Holding down either button will change the time faster. Press the Auto button to save the time.
5. Adjust the parameter number to adjust the day of the week and press the Auto button to enter it. Press the Manual/Start (I) and Stop/Reset (O) button to change to the desired day and press the Auto button to save it.

**Note:** Only one day can be chosen per event if parameter 903 is “1” (monthly).

6. Adjust the parameter number to adjust duration of the timer and press the Auto button to enter it. Press the Manual/Start (I) or Stop/Reset (O) buttons to change the duration and press the Auto button to save it.

**Note:** If any of the scheduled time slots are currently active, the controller will begin the starting sequence and start the unit provided there are no shutdown conditions present.

The times for the scheduled timers/events are based on the internal clock for the controller. Use the corresponding parameters to adjust to the correct time of the day and correct date.

This table lists the parameters needed to schedule an event and to adjust the clock within the controller.

**Note:** If parameter 902 is “0”, then the auto exercise timer is enabled and if it is “1”, then the autolight timer is enabled.

Parameter	Description	Details
<b>Configuration Parameters - Scheduler</b>		
901	Enable Scheduler	On (1), Off (0)
902	Schedule Run On or Off Load	On (1), Off (0)
903	Schedule Period	Weekly (0), Monthly (1)
904	Scheduler (1) Start Time	0:00:00
905	Scheduler (1) Start Day	0 (1=Monday)
906	Scheduler (1) Start Week	1,2,3,4
907	Scheduler (1) Duration	0:00:00
908	Scheduler (2) Start Time	0:00:00
909	Scheduler (2) Start Day	0 (1=Monday)
910	Scheduler (2) Start Week	1,2,3,4
911	Scheduler (2) Duration	0:00:00
912	Scheduler (3) Start Time	0:00:00
913	Scheduler (3) Start Day	0 (1=Monday)
914	Scheduler (3) Start Week	1,2,3,4
915	Scheduler (3) Duration	0:00:00
916	Scheduler (4) Start Time	0:00:00
917	Scheduler (4) Start Day	0 (1=Monday)
918	Scheduler (4) Start Week	1,2,3,4
919	Scheduler (4) Duration	0:00:00

Parameter	Description	Details
920	Scheduler (5) Start Time	0:00:00
921	Scheduler (5) Start Day	0 (1=Monday)
922	Scheduler (5) Start Week	1,2,3,4
923	Scheduler (5) Duration	0:00:00
924	Scheduler (6) Start Time	0:00:00
925	Scheduler (6) Start Day	0 (1=Monday)
926	Scheduler (6) Start Week	1,2,3,4
927	Scheduler (6) Duration	0:00:00
928	Scheduler (7) Start Time	0:00:00
929	Scheduler (7) Start Day	0 (1=Monday)
930	Scheduler (7) Start Week	1,2,3,4
931	Scheduler (7) Duration	0:00:00
932	Scheduler (8) Start Time	0:00:00
933	Scheduler (8) Start Day	0 (1=Monday)
934	Scheduler (8) Start Week	1,2,3,4
935	Scheduler (8) Duration	0:00:00
<b>Configuration Parameters - Time and Date</b>		
1001	Time of Day	0:00:00
1002	Day of Month	1-31
1003	Month of Year	1-12
1004	Year	0-99

## SHUTTING DOWN THE UNIT

Check with personnel using power supplied by the unit and let them know the power is going to be turned off. Make sure the power shut down will not create any hazards by accidentally turning off equipment that needs to be kept on (pumps, compressors, lights, etc.).

1. Remove all loads from the receptacles.
2. Switch the individual circuit breakers for each light to the OFF (O) position.
3. Switch the main circuit breaker to the OFF (O) position.
4. Press the Stop/Reset (O) button.
5. After the unit shuts down, move the Control Power switch to the OFF (O) position.

**Note:** For extended storage time, disconnect the battery. For extended storage requirements, refer to the engine operator's manual.

## LOWERING THE MAST - MANUALLY

1. Shut down the lights and engine, refer to *"Shutting Down the Unit"* on page 32. Allow the lights to cool 10-15 minutes before lowering the mast.
2. Loosen the mast rotation knob. Rotate the mast until the white arrows are aligned and the metal stop tabs are touching. Tighten the mast rotation knob.

3. Turn the upper mast winch handle counterclockwise to collapse the mast to its lowest position. Ensure the electrical cord does not get caught in, or pinched by, the mast while it is being lowered.

### **▲ CAUTION**

**STOP IMMEDIATELY** if the mast hangs up or the winch cable begins to develop slack. Excess slack in the cable could cause the mast to collapse, which could result in personal injury or equipment damage. Contact an authorized service center.

4. Release the mast lock by pulling the safety pin on the mast lock and pulling the lock bar free. Turn the handle of the lower mast winch counterclockwise until the mast rests in the transport cradle.

**Note:** *If the mast lock bar does not pull free, activate the lower winch slightly to relieve pressure on the mast bar.*

5. After the mast is completely down, insert the mast cradle locking pin and secure it with the safety pin.

**Note:** *If the trailer is going to be moved, Magnum Power Products LLC strongly recommends the lights be removed from the mast and stowed for transportation. Refer to "Removing the Lights for Transportation" on page 34.*

## **LOWERING THE MAST - ELECTRIC WINCH OPTION**

1. Shut down the lights and engine, refer to "[Shutting Down the Unit](#)" on page 32. Allow the lights to cool 10-15 minutes before lowering the mast.
2. Loosen the mast rotation knob. Rotate the mast until the white arrows are aligned and the metal stop tabs are touching. Tighten the mast rotation knob.
3. Press and hold the upper winch control switch downward to collapse the mast to its lowest position. Ensure the electrical cord does not get caught in, or pinched by, the mast while it is being lowered.

**Note:** *Some electric winch models are equipped with an anti-backlash safety limit switch. This switch will disconnect power to the winch if excess cable slack is detected, preventing accidental lowering of the mast.*

### **▲ CAUTION**

**STOP IMMEDIATELY** if the mast hangs up or the winch cable begins to develop slack. Excess slack in the cable could cause the mast to collapse, which could result in personal injury or equipment damage. Contact an authorized service center.

4. Release the mast lock by pulling the safety pin on the mast lock and pulling the lock bar free. Lower the mast by holding the lower winch control switch to the right until the mast is resting in the transport cradle.

**Note:** *If the mast lock bar does not pull free, activate the lower winch slightly to relieve pressure on the mast bar.*

5. After the mast is completely down, insert the mast cradle locking pin and secure it with the safety pin.

**Note:** *If the trailer is going to be moved, Magnum Power Products LLC strongly recommends that the lights be removed from the mast and stowed for transportation. Refer to "Removing the Lights for Transportation" on page 34.*



## REMOVING THE LIGHTS FOR TRANSPORTATION

1. On units equipped with quick disconnect fittings for the lights, disconnect the power cords from the junction box at the top of the mast. Replace the dust caps on the junction box. On hard wired units, remove the junction box cover, located on the top of the mast, and disconnect **ONLY** the mast light wires from the connectors. To release the mast light wires from the connectors, flip the locking levers down and pull out the appropriate wires.
2. Remove the lights by removing the wing nut that holds the light fixture bracket to the cross tube. Attach the lights to the storage brackets (if equipped) located on the mast tube on either side of the central lift point.

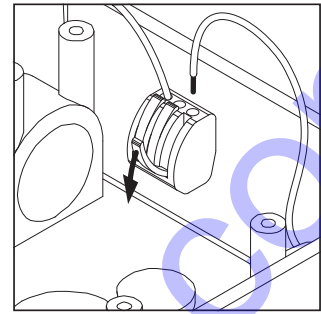

00232

## TOWING THE UNIT

Once the engine is shut down and the mast and lights are properly stowed, follow these steps to prepare the unit for towing.

1. Raise the rear jack completely and release the locking pin to rotate it up into the travel position. Make sure the locking pin snaps into place.
2. Raise the outrigger jacks completely and release the jack locking pin to swing the jacks up into the travel position. Make sure the locking pins snap into place. Release the outrigger locking pins and slide the outriggers into the trailer frame until the locking pins snap into place.
3. Use the tongue jack to raise or lower the trailer onto the hitch of the towing vehicle. Lock the hitch coupling and attach the safety chains or cables to the vehicle. Remove the jack locking pin and rotate the jack into the travel position. Replace the locking pin.

**Note:** A film of grease on the coupler will extend coupler life and eliminate squeaking. Wipe the coupler clean and apply fresh grease each time the unit is towed.

4. To ensure proper operation of the jacks, lube the grease fittings located on the leveling jacks. Refer to “[Jack Maintenance](#)” on page 38. For maintenance interval information, refer to “[Basic Maintenance Schedule - Isuzu Engine](#)” on page 36.
5. Connect any trailer wiring to the tow vehicle. Check for proper operation of the directional and brake lights.
6. Make sure the mast cradle locking pin is in place.
7. Make sure the doors are properly latched.
8. If the unit is going to be driven over rough ground, remove the bulbs from the light fixtures.
9. Check for proper inflation of the trailer tires. Refer to “[Specifications](#)” on page 10.
10. Check the wheel lugs. Tighten or replace any lugs that are loose or missing. If a tire has been removed for axle service or replaced, tighten the lugs, in the order shown, to the following specifications:

- A. Start all lug nuts by hand.
- B. First pass tighten to 20-25 ft-lbs (27-33 Nm).
- C. Second pass tighten to 50-60 ft-lbs (67-81 Nm).
- D. Third pass tighten to 90-120 ft-lbs (122-162 Nm).

**Note:** After the first road use, re-torque the lug nuts in sequence.

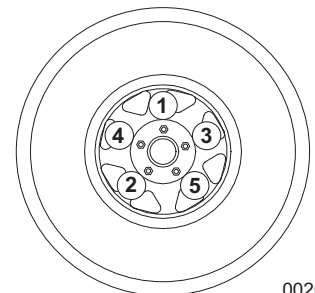

00204

11. Maximum recommended speed for highway towing is 45 mph (72 km/h). Recommended off-road towing speed is not to exceed 10 mph (16 km/h) or less, depending on the terrain.



## LIFTING THE UNIT

When lifting the unit, attach any slings, chains or hooks directly to the central lift point.

1. Make sure the equipment being used to lift the unit has sufficient capacity. For approximate weights, refer to *“Specifications” on page 10.*
2. Make sure the cradle locking pin is in place.
3. Always remain aware of people and objects around the unit while moving.
4. Use the upper or lower forklift pockets with care. Approach the unit as perpendicular as possible to avoid any damage to the unit. Make sure the mast winch handles or any other obstructions are clear of the forklift tines before lifting.

## GENERAL MAINTENANCE

Poorly maintained equipment can become a safety hazard. In order for the equipment to operate safely and properly over a long period of time, periodic maintenance and occasional repairs are necessary. **NEVER** perform routine service (oil/filter changes, cleaning, etc.) unless all electrical components are shut off. Before servicing the unit, always follow the instructions listed below.

- Ensure the Control Power switch is turned to the OFF (O) position.
- Ensure the circuit breakers are open, in the OFF (O) position.
- Activate (push in) the emergency stop switch.
- Disconnect the negative (-) terminal on the battery.
- Attach a “Do Not Start” sign to the control panel. This will notify everyone that the unit is being serviced and will reduce the chance of someone inadvertently trying to start the unit.
- Never wash the unit with a high pressure hose or with any kind of power washer.
- Never wash the engine block or fuel tank with a power washer or steam cleaner. Water may enter the cabinet and collect in the generator windings or other electrical parts, causing damage.
- If the unit is stored outside, check for water inside the cabinet and generator before each use. If wet, dry the unit thoroughly before starting.
- Inspect condition of electrical cords. **DO NOT** use the unit if insulation is cut or worn through.
- Check that winch cables are in good condition and are centered on each pulley. **DO NOT** use a cable that is kinked or starting to unravel.
- Check that the safety pins for the mast lock rod and mast lock bar are present and secured with a chain. Check that the spring located in the mast lock bar is not broken or missing. Check the operation of the mast lock bar.
- Check the wheel lugs. Refer to *“Towing the Unit” on page 34.*
- Check coolant levels. Refer to the engine operator’s manual when determining proper mixture.
  - Coolant is checked visually by inspecting the level in the coolant overflow jug near the radiator.
  - Normal operation is between the full and add markings on the overflow jug, this is known as normal range.
  - **WHEN ENGINE IS STOPPED AND COMPLETELY COOL**, coolant may be added directly to the jug.
- Check the oil levels. Refer to the engine operator’s manual when determining proper viscosity.
  - **DO NOT** start the unit if the engine oil level is below the add mark on the dipstick.
  - Normal operation is between the full and add markings on the dipstick.
  - Add oil only if oil level is below cross-hatch pattern on the dipstick. **DO NOT OVERFILL** crankcase.
- Check fuel level.

PROPER MAST CABLE ROUTING

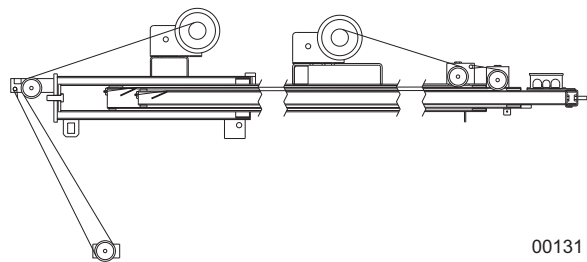

00131

**Note:** If the engine was run out of fuel or the fuel tank was drained, it may be necessary to bleed the fuel lines. Refer to the engine operator’s manual supplied with the unit.

## BASIC MAINTENANCE SCHEDULE - ISUZU ENGINE

### NOTICE

Refer to the original equipment manufacturer's operating manual for a complete list of maintenance requirements. Failure to comply with the procedures as described in the engine operator's manual will nullify the warranty, decrease performance and cause equipment damage or premature equipment failure. Maintenance records may be required to complete a warranty request.

Use the schedule in the following table as a guide for regular maintenance intervals. For additional or replacement copies of the engine operator's manual, contact an authorized dealer in your area.

Item	Daily	250 Hours	500 Hours	1000 Hours
Check Oil Level	◆			
Check Coolant Level	◆			
Check Fuel Level	◆			
Drain Fuel Filter	◆			
Check Tire Pressure	◆			
Check All Electrical Connections	◆			
Clean Battery	◆			
Check Fan Belt Tension (Replace If Necessary)	◆			
Inspect Radiator Fins For Debris, Clean As Required	◆			
Preheating Condition Check	◆			
Check Engine Starting Conditions And Noise Conditions	◆			
Check Exhaust Smoke Condition	◆			
Inspect Light Tower Winch For Proper Operation	◆			
Replace Engine Oil		◆		
Replace Fuel Filter Element		◆		
Clean Water Sedimenter Element		◆		
Electromagnetic Pump Filter Replacement or Cleaning		◆		
Check Fan Belt Tension (Replace If Necessary)			◆	
Oil Filter Element Replacement			◆	
Replace Air Filter Element			◆	
Lubricate Leveling Jacks			◆	
Replace Heated Fuel Filter (If Equipped)				◆
Inspect Engine Starting Battery				◆

### RESETTING THE MAINTENANCE ALARMS

The L401 controller will display a warning message when the unit is due for maintenance or service. The maintenance or service intervals are set at 250 and 500 hours of engine running time. Once the unit has been serviced, the appropriate maintenance alarm reminder needs to be reset.

To remove the fault of the latching alarms, press the Stop/Reset (O) button on the controller for 10 seconds on the desired Maintenance Alarm Status page.

### WINCH USE, OPERATION & MAINTENANCE - MANUAL

#### PRIOR TO USE

- Inspect rope or cable and replace if damaged.
- Check mounting hardware for proper tightness and re-torque if necessary.

- Gears, ratchet pivot point and shaft bushings must be kept lubricated with a thin oil or grease.

## OPERATION

### *Take Line/Load In:*

1. The cable must be securely fastened to the object being lifted and to the winch drum.
2. Always be sure that the cable and cable attachments are not damaged and are strong enough for the load. Ensure there is an adequate safety factor of at least three times the maximum load for all components used.
3. Referring to the "Cable In/Cable Out" decal on the winch, turn handle according to the specified direction to lift. The ratchet **MUST** make a loud clicking sound while pulling line in.

### *Let Line/Load Out:*

1. Referring to the "Cable In/Cable Out" decal on the winch, turn handle according to the specified direction to lower. No clicking will be heard because the brake system is activated.

## MAINTENANCE

The following procedures should be performed at least annually:

1. The gears and bushings of the winch must be kept lubricated. Apply a thin film of grease to the gear teeth, and oil the bushings as needed.
2. The ratchet pawl pivot point must be kept lubricated with a thin oil.
3. Do not get oil or grease on the friction discs.

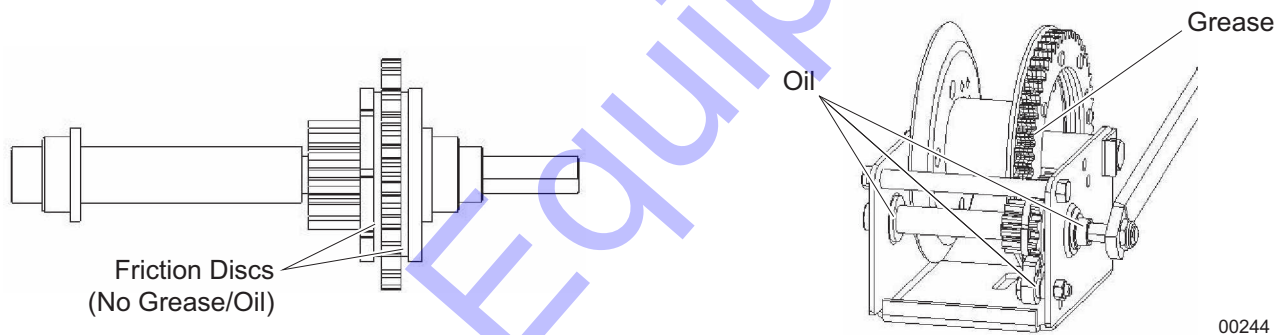

## WINCH USE, OPERATION & MAINTENANCE - ELECTRIC

- Keep winch free of dirt, oil, grease, water and other substances.
- Check all mounting bolts and make sure they are tightened to the recommended torque values. Replace any damaged fasteners.
- Periodically check all connections to be sure they are tight and free of corrosion.
- Check cable for visible damage every time winch is operated. Examples of damage are: cuts, knots, mashed or frayed portions, and broken strands. Replace cable immediately if damaged. Failure to replace a damaged cable could result in breakage.
- Regularly check brake for slippage or drift. This is detected visually when winch is under load. If winch drum continues to turn after controls are released, the brake may need to be replaced.
- Periodically clean and grease brake assembly. This will ensure proper performance and extend the life of the winch. If winch seems to labor or get excessively hot during the lowering of loads, the brake will need to be serviced or replaced.
- Check motor brushes periodically and replace when necessary.

**Note:** Only the motor brushes and brake assembly require periodic replacement.

## PREVENTIVE MAINTENANCE SCHEDULE

Maintenance Activity	After First Operation	Before Each Use	Semi-Annually Or After Each 25 Hours Of Operation
Check Fasteners	◆		◆
Check Electrical Connections	◆		◆
Clean And Grease Brake Assembly			◆
Check Motor Brushes			◆
Visually Check Winch And Control	◆	◆	◆

### MECHANICAL BRAKE

The mechanical brake generates heat when loads are lowered and the wire cable is powered out. Care must be taken to avoid overheating the mechanical brake.

Whine or chatter associated with a new mechanical brake is normal and typically disappears with use.

Overheating the mechanical brake may result in permanent damage to, or failure of, the brake. Replace any damaged brake components before resuming use of the winch.

### JACK MAINTENANCE

The following procedures should be performed at least annually.

#### SIDE-WIND MODELS

- The internal gearing and bushings of the jack must be kept lubricated. Apply a small amount of automotive grease to the internal gearing by removing the jack cover, or if equipped, use a needle nose applicator or standard grease gun on the lubrication point found on the side of the jack near the crank. Rotate the jack handle to distribute the grease evenly.
- A lightweight oil must be applied to the handle unit at both sides of the tube.
- If equipped, the axle bolt and nut assembly of the caster wheel must also be lubricated with the same light weight oil.

#### TOP-WIND MODELS

- Apply a lightweight oil to the screw stem.

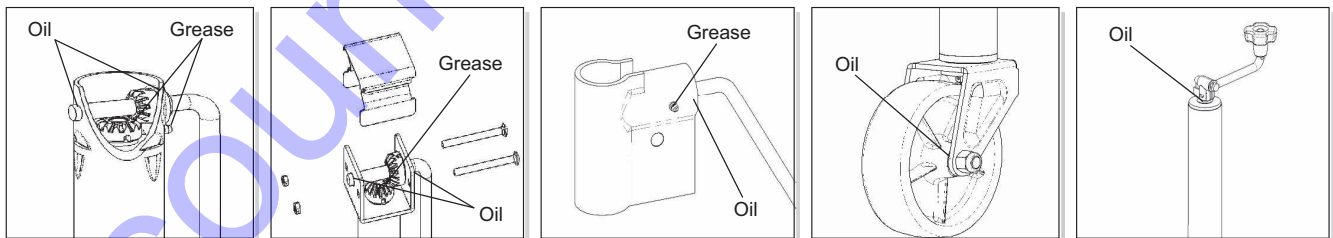

00243

### TRAILER WHEEL BEARINGS

The trailer axles are equipped with a grease zerk fitting to allow lubrication of the wheel bearings without the need to disassemble the axle hub. To lubricate the axle bearings, remove the small rubber plug on the grease cap, attach a standard grease gun fitting to the grease zerk fitting and pump grease into the fitting until new grease is visible around the nozzle of the grease gun. Use only a high quality grease made specifically for lubrication of wheel bearings. Wipe any excess grease from the hub with a clean cloth and replace the rubber plug when finished. The minimum recommended lubrication is every 12 months or 12,000 miles (19,312 km). More frequent lubrication may be required

under extremely dusty or damp operating conditions.

## LOWER RADIATOR HOSE HEATER OPTION - USE AND MAINTENANCE

### ▲ CAUTION

Improper use of the lower radiator hose heater could result in damage to the engine or personal injury. Do not modify the location of the lower radiator hose heater.

The following points should be followed when operating a unit equipped with a lower radiator hose heater.

- Ensure the cooling system is full of the proper mixture of water and engine coolant before each heater use.
- The heater is designed for all-night operation, however, 2-5 hours of heating just prior to starting is usually sufficient for proper engine starting.
- The unit must be level to maintain proper orientation of the heater while it is in operation.
- Use only an undamaged, outdoor rated, three-prong grounded 120VAC extension cord with a minimum amperage rating of 10A. Connect the cord to a properly grounded 120VAC, GFCI receptacle.
- Before starting the engine, unplug the extension cord from the power first, then unplug the heater cordset from the extension cord.

## TROUBLESHOOTING THE LIGHTS

### ▲ DANGER

**THIS UNIT USES HIGH VOLTAGE CIRCUITS CAPABLE OF CAUSING SERIOUS INJURY OR DEATH. ONLY A QUALIFIED ELECTRICIAN SHOULD TROUBLESHOOT OR REPAIR ELECTRICAL PROBLEMS OCCURRING IN THIS EQUIPMENT.**

#### MAST LIGHTS ON BUT THE LIGHT OUTPUT IS LOW

1. Fixture and/or lens is dirty. Clean reflective surface inside fixture and both inside and outside surface of glass lens. Use mild soap and water to clean lens. Other chemicals may have an adverse effect on the glass.
2. Bulb worn due to normal use. Replace bulb.
3. Check the mast coil cord, mast junction box and mast light connections.
4. Generator output incorrect. Incoming voltage should be 120V +/- 5V. If the voltage is incorrect, adjust the voltage regulator.
5. Low transformer output. The voltage from the transformer should read approximately 400VAC as the light "strikes" (induces an arc), then drop and slowly rise back up to stabilize at 240-260VAC. On quick disconnect models, measure across the junction box terminals when the light is unplugged. On hard wired models, remove the mast junction box cover and insert the wire probes into the connector blocks for the light and ground. If proper voltage is not achieved, perform capacitor check to determine if the capacitor or coil needs to be replaced.

If problems persist, contact Magnum Power Products LLC Technical Service at 1-800-926-9768 for assistance.

## TROUBLESHOOTING AUTOMATIC SHUTDOWN CONDITIONS

### ▲ WARNING

**Allow engine to cool before performing any troubleshooting procedures. Contacting the engine when it is hot will cause severe personal injury.**

#### LOW OIL PRESSURE SHUTDOWN

1. Check the level of the engine oil with the dipstick. The engine controller will shut the engine down when the oil pressure is less than 15 psi (103 kPa). Add oil if required.
2. Visually inspect the engine for oil leaks.
3. If the oil level is good, restart the unit and verify the loss of oil pressure. Shut the engine down immediately if the oil pressure value does not read 5 psi (34 kPa) within five seconds.

4. Check the oil pressure sender. To identify corrective action, refer to the troubleshooting section of the engine operator's manual provided with the unit.

## HIGH COOLANT TEMPERATURE SHUTDOWN

1. Check the coolant level in the overflow jug.
2. Restart the engine and read the coolant temperature to verify a high coolant temperature shutdown. Stop the engine immediately if the coolant temperature is 210°F (99°C) or more.
3. Allow the engine to cool. Add coolant to the overflow jug if it is low and then check the level of coolant in the radiator. To access the radiator cap, you must remove the access panel from the top of the enclosure directly above the radiator. Add coolant until it is 3/4 in. (1.9 cm) below the filler neck. Secure the radiator cap back into its original position.
4. Check the radiator shroud and ducting for blockage and remove any foreign matter.
5. Inspect coolant hoses, engine block and water pump for visible leaks.
6. Check the tension of the serpentine drive belt for the water pump.
7. If no other problems are found, remove the load on the generator and restart the engine. Check the coolant temperature and shut the engine down immediately if it starts to overheat. Refer to the engine operator's manual for additional information on engine overheating.

## MAST LIGHT CONNECTIONS

MAST JUNCTION BOX WIRING  
4-LIGHT

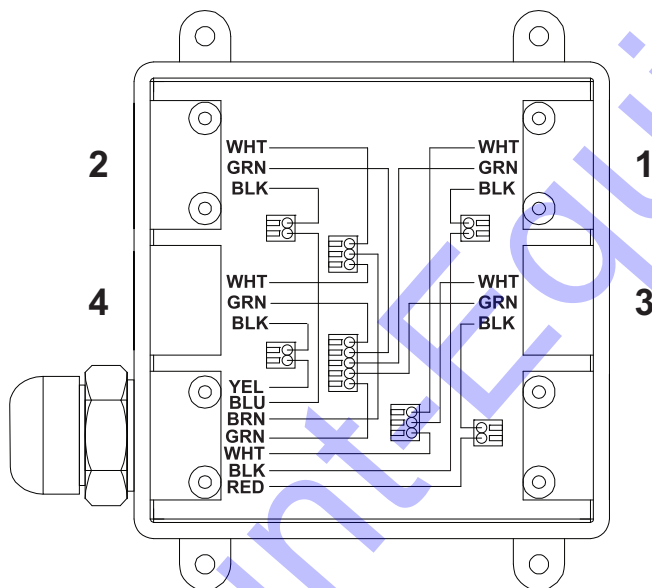

MAST LIGHT CONNECTIONS  
4-LIGHT

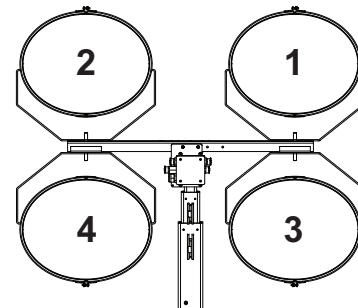

00175

# AC WIRING DIAGRAM

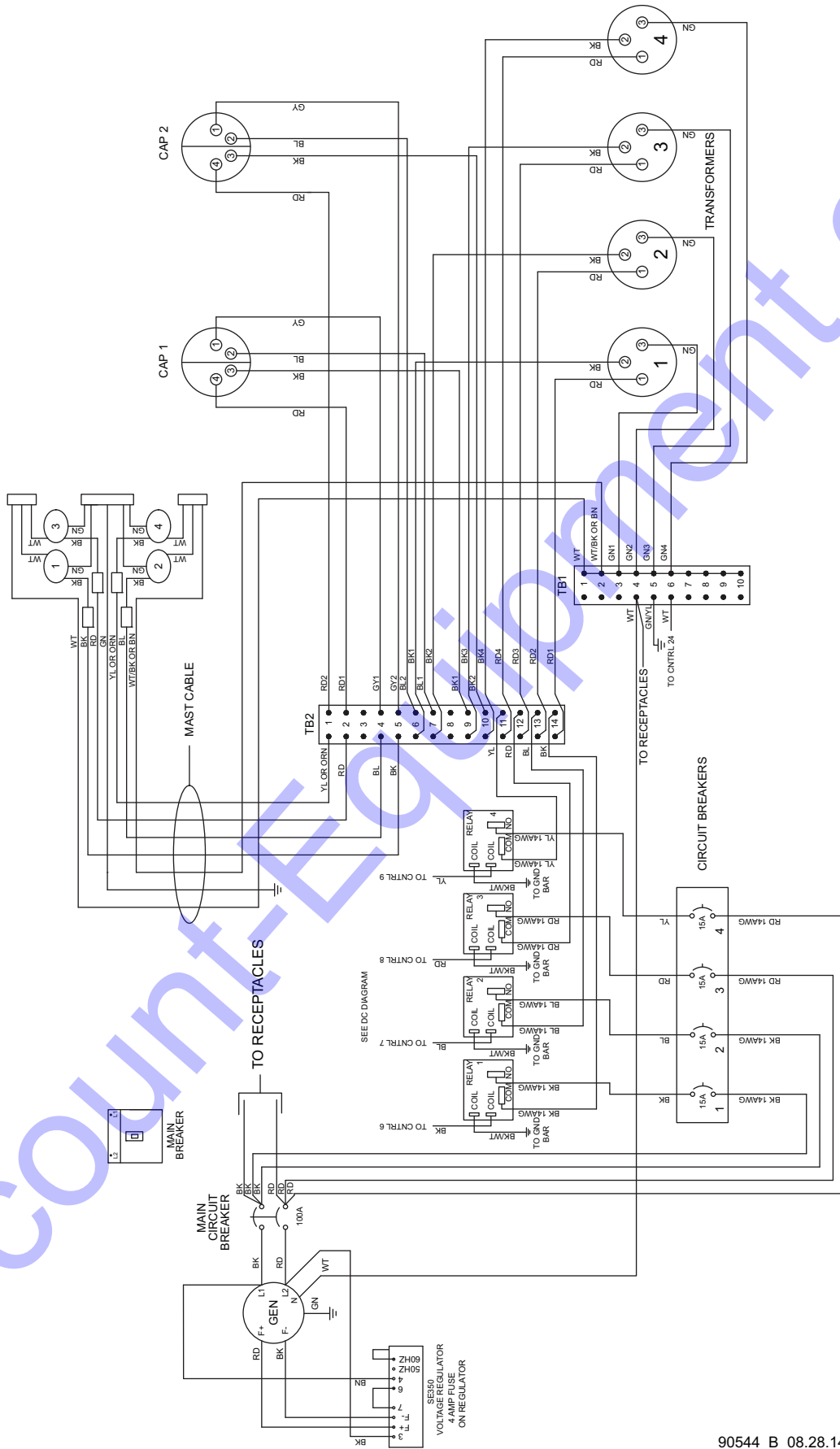

90544\_B\_08.28.14



# AC WIRING DIAGRAM - RECEPTACLE PANEL

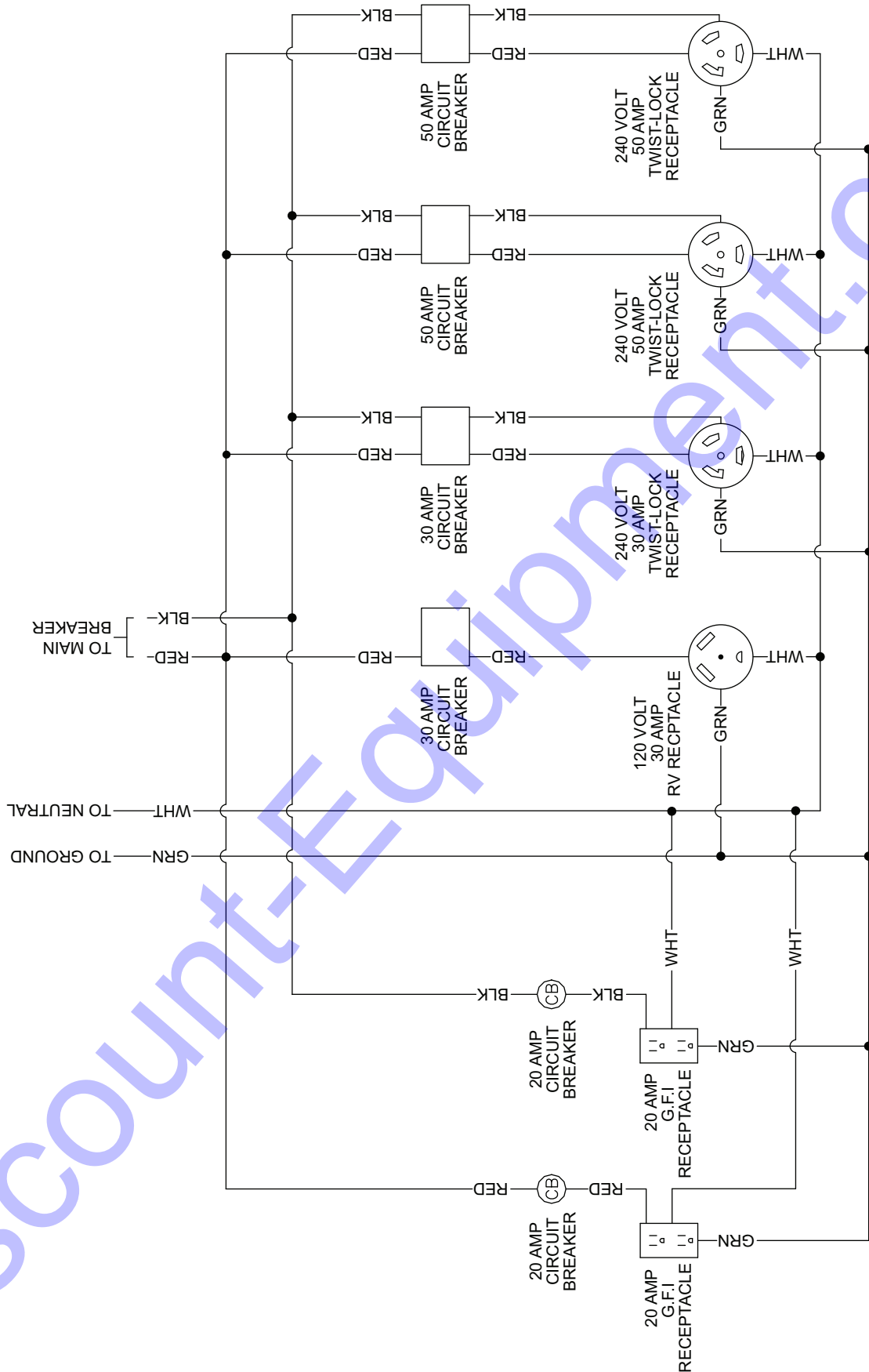

(2x5-20R, 1xTT-30, 1xL14-30R, 2x14-50)

90317\_ORG\_07.06.11

# AC WIRING DIAGRAM - RECEPTACLE PANEL OPTIONS (1 OF 2)

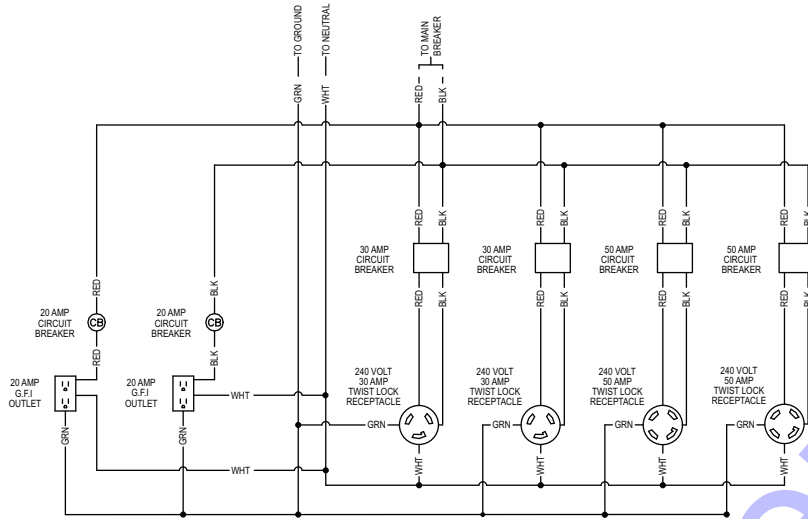

Receptacle Panel (2x5-20R, 2xL6-30R, 2xL14-50)

90315\_ORG\_10.14.11

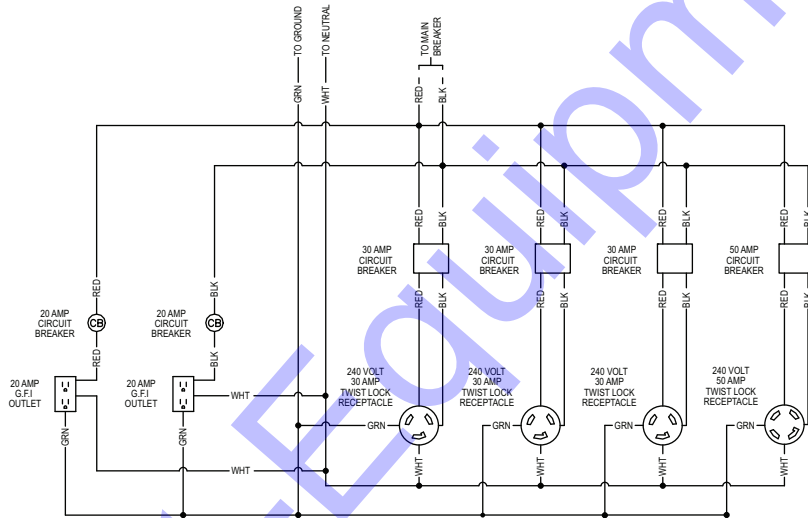

Receptacle Panel (2x5-20R, 3xL6-30R, 1xL14-50)

90318\_ORG\_07.06.11

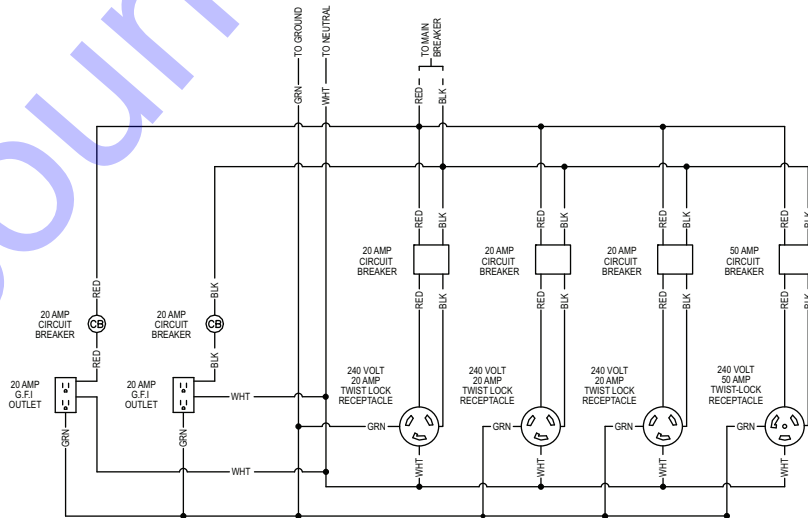

Receptacle Panel (2x5-20R, 3xL6-20R, 1x50A)

90319\_ORG\_07.06.11

# AC WIRING DIAGRAM - RECEPTACLE PANEL OPTIONS (2 OF 2)

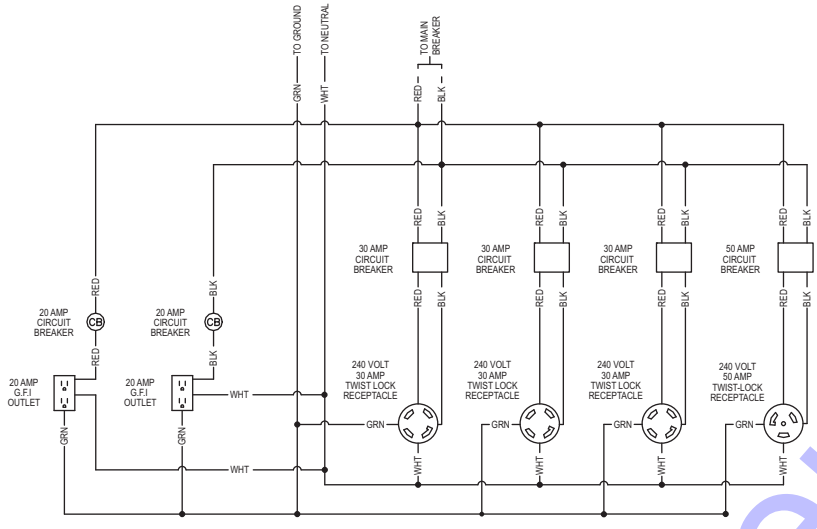

Receptacle Panel (2x5-20R, 3x14-30R, 1x50A)

90320\_ORG\_07.06.11

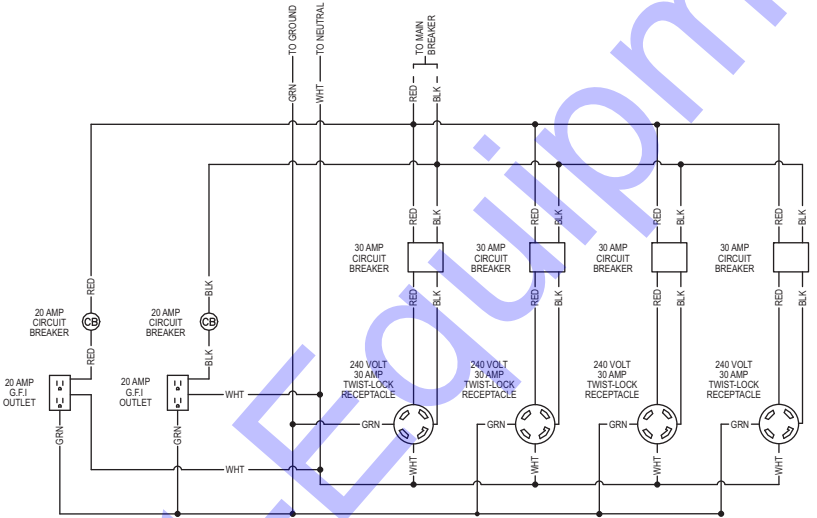

Receptacle Panel (2x5-20R, 4x14-30R)

90321\_ORG\_07.06.11

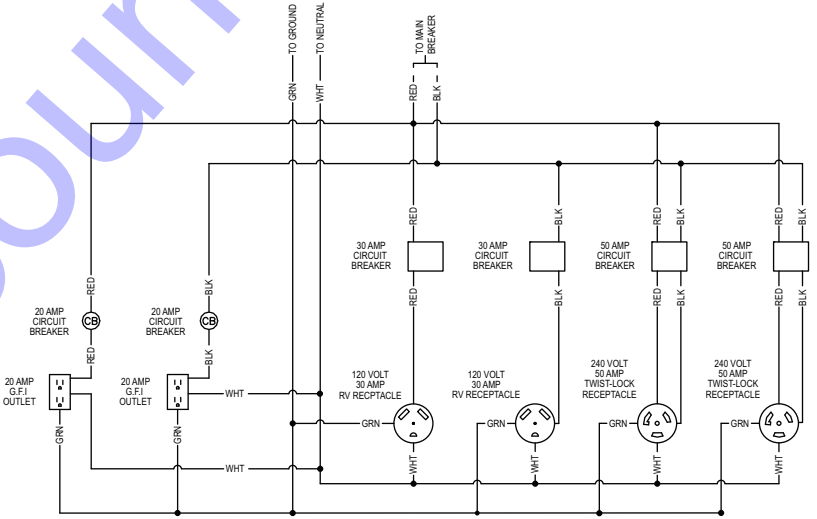

Receptacle Panel (2x5-20R, 2xTT-30, 2x14-50)

90355\_ORG\_07.06.11



# DC WIRING DIAGRAM - ELECTRIC WINCH

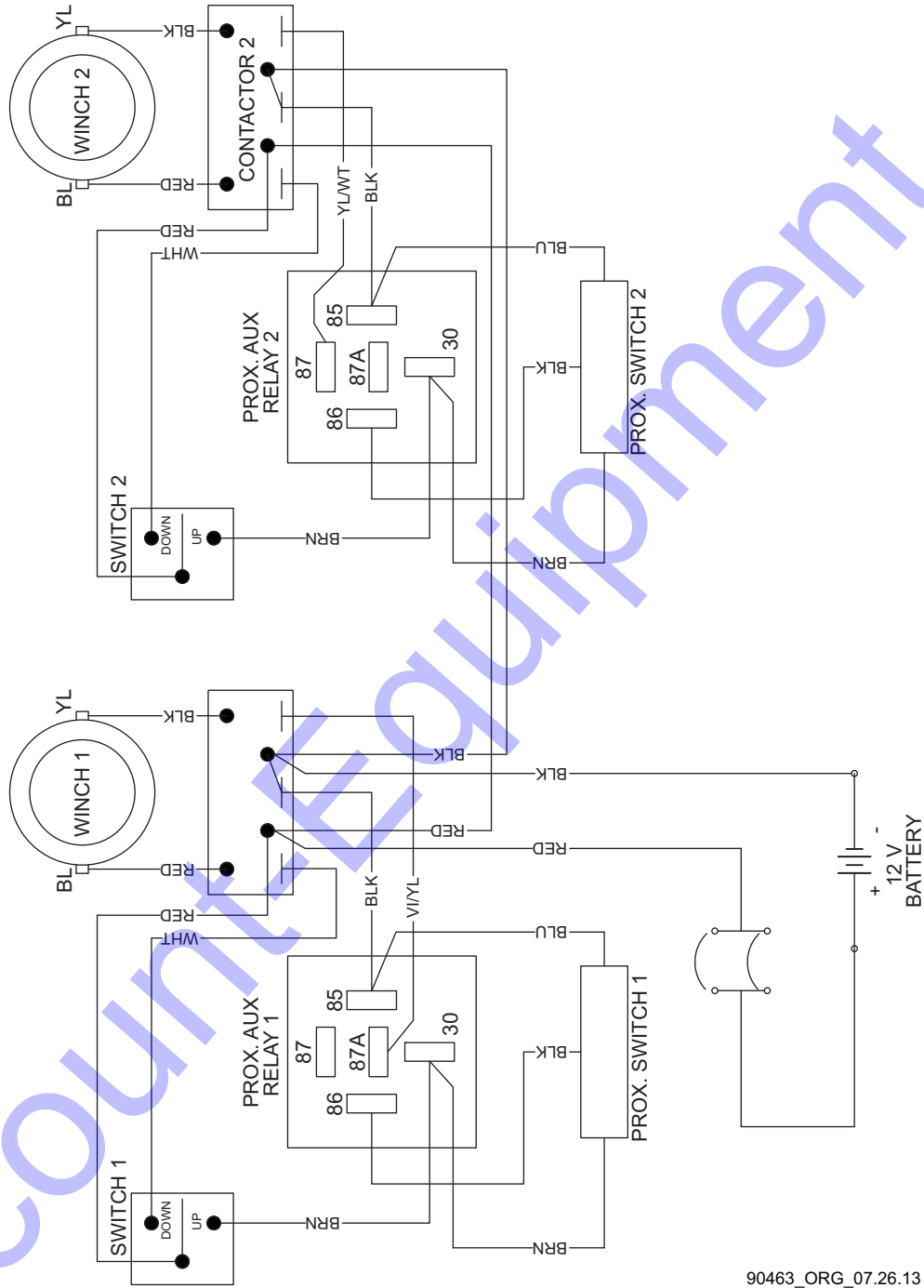

90463\_ORG\_07.26.13

# DC WIRING DIAGRAMS FOR OPTIONAL EQUIPMENT

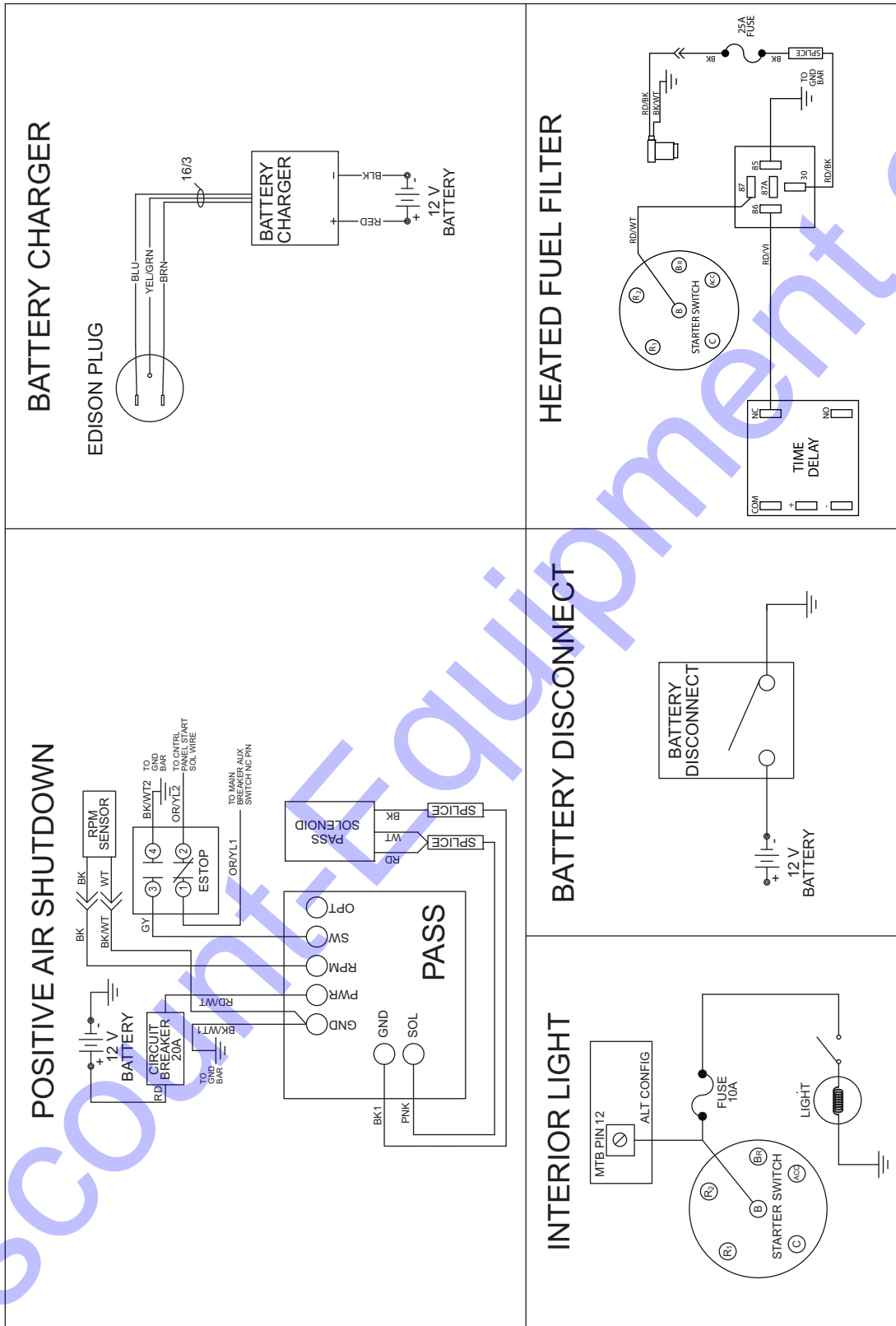

90323\_1\_11.18.13

# TRAILER LIGHTS WIRING DIAGRAM

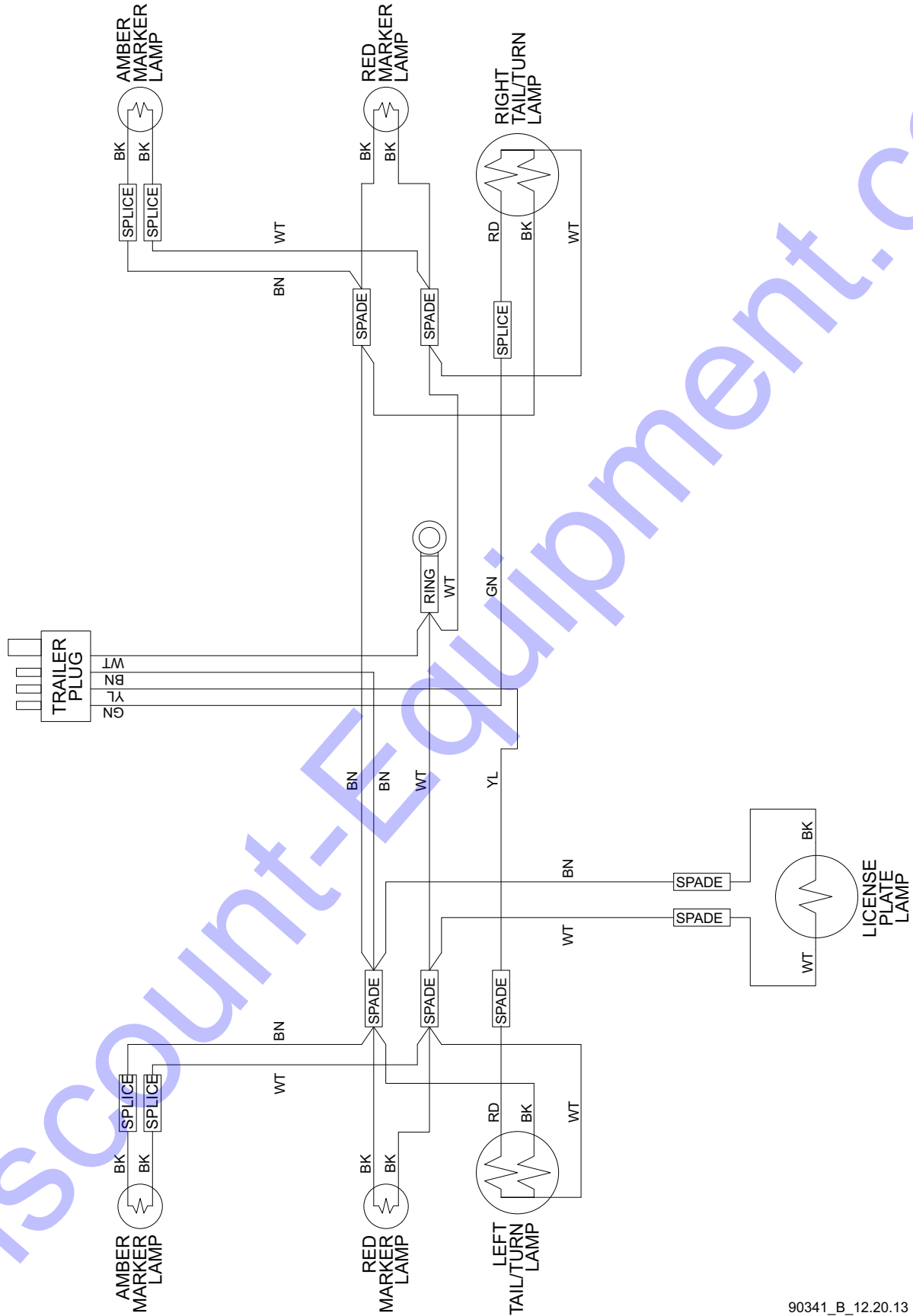

90341\_B\_12.20.13





# **Discount Equipment**

Discount-Equipment.com is your online resource for commercial and industrial quality parts and equipment sales.

## **Locations:**

Florida (West Palm Beach): [561-964-4949](tel:561-964-4949)

Outside Florida TOLL FREE: [877-690-3101](tel:877-690-3101)

**Need parts?** Check out our website at [www.discount-equipment.com](http://www.discount-equipment.com)

## **Can't find what you need?**

Click on this link: <http://www.discount-equipment.com/category/5443-parts/> and fill out the request form.

Please have the machine model and serial number available in order to help us get you the correct parts. One of our experienced staff members will get back to you with a quote for the right part that your machine needs.

We sell worldwide for the brands: Genie, Terex, JLG, MultiQuip, Mayco, Toro/Stone, Diamond Products, Magnum, Airman, Mustang, Power Blanket, Nifty Lift, Atlas Copco, Chicago Pneumatic, Allmand Brothers, Essick, Miller Spreader, Skyjack, Lull, Skytrak, Tsurumi, Husquvarna/Target, Whiteman-Concrete/Mortar, Stow-Concrete/Mortar, Baldor, Wacker, Sakai, Snorkel, Upright, Mi-T-M, Sullair, Neal, Basic, Dynapac, MBW, Weber, Bartell, Bennar Newman, Haulotte, Ditch Runner, Blaw-Knox, Himoina, Best, Buddy, Crown, Edco, Wyco, Bomag, Laymor, Terremite, Barreto, EZ Trench, Takeuchi, Basic, Bil-Jax, Curtis, Gehl, Heli, Honda, ICS/PowerGrit, Puckett, Waldon, ASV, IHI, Partner, Imer, Clipper, MMD, Koshin, Rice, Gorman Rupp, CH&E, Cat Pumps, Comet, General Pump, Giant, AMida, Coleman, NAC, Gradall, Square Shooter, Kent, Stanley, Tamco, Toku, Hatz, Kohler, Robin, Wisconsin, Northrock, Oztec, Toker TK, Rol-Air, Small Line, Wanco, Yanmar

**New Equipment - Used Equipment - Rental Equipment - Parts and Accessories**

# **Discount Equipment**

[www.discount-equipment.com](http://www.discount-equipment.com)

**561-964-4949**

Parts: [wbparts@Discount-Equipment.com](mailto:wbparts@Discount-Equipment.com)

Sales: [info@Discount-Equipment.com](mailto:info@Discount-Equipment.com)



[www.discount-equipment.com](http://www.discount-equipment.com)

REV: ORG  
PART NO: 37096  
09.10.14