

CROWN
CONSTRUCTION EQUIPMENT

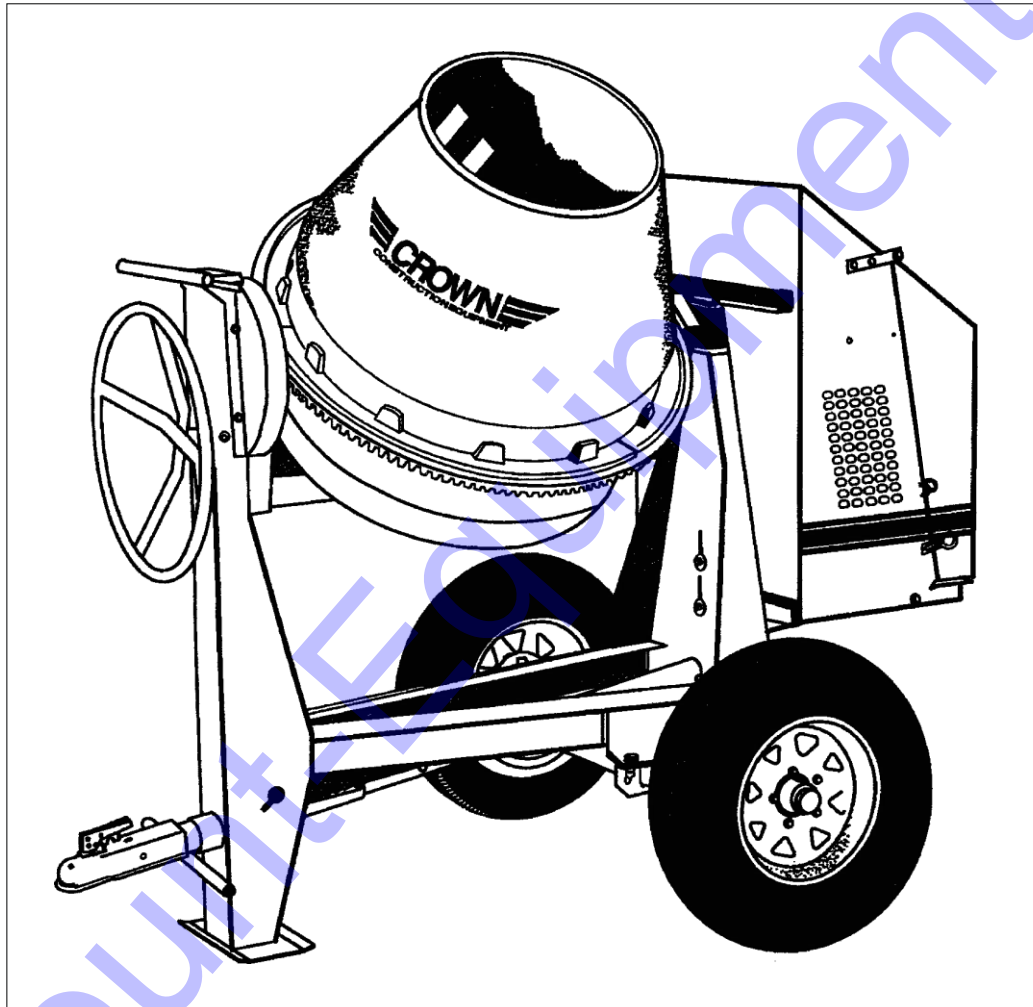

**CONCRETE MIXER MODELS:
C3-C, C6-C, C6-P, C9-C & C12-C**

OPERATOR'S MANUAL

Discount Equipment

Discount-Equipment.com is your online resource for commercial and industrial quality parts and equipment sales.

Locations:

Florida (West Palm Beach): [561-964-4949](tel:561-964-4949)

Outside Florida TOLL FREE: [877-690-3101](tel:877-690-3101)

Need parts? Check out our website at www.discount-equipment.com

Can't find what you need?

Click on this link: <http://www.discount-equipment.com/category/5443-parts/> and fill out the request form.

Please have the machine model and serial number available in order to help us get you the correct parts. One of our experienced staff members will get back to you with a quote for the right part that your machine needs.

We sell worldwide for the brands: Genie, Terex, JLG, MultiQuip, Mayco, Toro/Stone, Diamond Products, Magnum, Airman, Mustang, Power Blanket, Nifty Lift, Atlas Copco, Chicago Pneumatic, Allmand Brothers, Essick, Miller Spreader, Skyjack, Lull, Skytrak, Tsurumi, Husquvarna/Target, Whiteman-Concrete/Mortar, Stow-Concrete/Mortar, Baldor, Wacker, Sakai, Snorkel, Upright, Mi-T-M, Sullair, Neal, Basic, Dynapac, MBW, Weber, Bartell, Bennar Newman, Haulotte, Ditch Runner, Blaw-Knox, Himoina, Best, Buddy, Crown, Edco, Wyco, Bomag, Laymor, Terremite, Barreto, EZ Trench, Takeuchi, Basic, Bil-Jax, Curtis, Gehl, Heli, Honda, ICS/PowerGrit, Puckett, Waldon, ASV, IHI, Partner, Imer, Clipper, MMD, Koshin, Rice, Gorman Rupp, CH&E, Cat Pumps, Comet, General Pump, Giant, AMida, Coleman, NAC, Gradall, Square Shooter, Kent, Stanley, Tamco, Toku, Hatz, Kohler, Robin, Wisconsin, Northrock, Oztec, Toker TK, Rol-Air, Small Line, Wanco, Yanmar

New Equipment - Used Equipment - Rental Equipment - Parts and Accessories

Discount Equipment

www.discount-equipment.com

561-964-4949

Parts: wbparts@Discount-Equipment.com

Sales: info@Discount-Equipment.com

CROWN'S CONDITIONS OF SALES & LIMITED WARRANTY

All sales made by Crown Construction Equipment Division of BTM Equipment Inc. are subject to these conditions unless otherwise agreed in writing with a duly authorized officer of Crown. In all cases of conflict between these conditions and the requirements of the purchase order, these conditions shall prevail.

(1) **SALES POLICY:** Nothing herein shall be construed as abridging the right of Crown to sell directly or indirectly to: (a) Federal, State or Provincial Governments or Agencies thereof, or to Agencies employing Federal, State or Provincial Government aid; (b) Purchasers who buy Crown's products for sale as integral or assembled parts of their products; (c) Firms operating on a national scale; (d) Any other class of purchaser to whom Crown may from time to time, elect to sell.

(2) **PRICES:** All prices are F.O.B. our warehouses, freight allowance as specified on Distributor Net Price Lists. The suggested list prices and discounts schedules are established by Crown and are intended to act as a guide for our distributors. Unless otherwise stated in writing, prices are subject to change without notice and will be applied as in effect at time of shipment.

(3) **TERMS:** Unless otherwise agreed upon in writing by an officer of Crown, all invoices become due and payable net 30 days following the date in invoice. Interest at the maximum legal rate will be charged on all overdue accounts. Minimum net charge per invoice is \$75.00

(4) **CANCELLATION AND CHANGES:** No orders or sales may be cancelled or changed without the consent of Crown. At Crown's option cancelled/changed orders are subject to payment of cancellation charges equal to all costs incurred by Crown up to the date of cancellation/change.

(5) **DELAYED DELIVERIES:** Crown shall not be liable for any delay of merchandise for any cause whatsoever.

(6) **CLAIMS:** All goods shall be deemed delivered to purchaser at the time they are placed in the hands of carrier and consigned to purchaser: loss, damage or destruction of any said merchandise is assumed by purchaser. No claims may be made for shortages unless made in writing within ten days from receipt of merchandise.

(7) **RETURN OF GOODS:** Written permission from Crown must be obtained before returning any merchandise. All transportation charges must be borne by the purchaser. Credit for returned goods will be based on the original price paid, less 20%.

Special parts or custom-built items cannot be returned for credit.

(8) **LIMITATION OF LIABILITY:** Crown's liability on any claim of any kind, including negligence, for any loss or damage arising out of, connected with, or resulting from contract, or the performance or breach thereof, or the design, manufacture, sale, delivery, resale, installation, technical direction of installation, inspection, repair, operation or use of any equipment covered by or furnished under contract shall in no case exceed the price paid by the purchaser for the equipment. Crown also disclaims all purchaser for the equipment. Crown also disclaims all liability, whether in contract, tort, warranty, or otherwise, to any party other than purchaser.

(9) All Price Lists, Catalogues and other material shall remain the property of Crown and are subject to return on demand. The Suggested List Prices are established by Crown and are intended to act as a guide. All shipping weights shown are approximate.

LIMITED CROWN WARRANTY

For one year from date of purchase, Crown will replace or repair for the original purchaser, free of charge, any part or parts, found upon examination by any Crown Authorized Service Depot or by the Crown factory, to be defective in material or workmanship or both. Crown extends the warrantee for the drum bearings and seals on plaster/mortar mixers to "Lifetime" and agrees to furnish, free of charge, the seals and bearings only upon receipt of the defective parts and evaluation at the factory. Crown extends the warranty on the mortar mixer gear box to five years and agrees to replace or repair for the original purchaser, free of charge, the gear box, found upon examination by the factory to be defective in material or workmanship, or both. Equipment and accessories not manufactured by Crown are warranted only to the extent of the original manufacturer's warranty. All transportation charges on parts submitted for replacement or repair under this warranty must be borne by the purchaser. For warranty service contact your nearest Crown Authorized Service Depot.

THERE IS NO OTHER EXPRESS WARRANTY, IMPLIED WARRANTIES, INCLUDING THOSE OF MERCHANTABILITY AND FITNESS FOR A PARTICULAR PURPOSE ARE LIMITED TO ONE YEAR FROM PURCHASE AND TO THE EXTENT PERMITTED BY LAW. LIABILITY FOR CONSEQUENTIAL DAMAGES UNDER ANY AND ALL WARRANTIES ARE EXCLUDED TO THE EXTENT EXCLUSION IS PERMITTED BYLAW. (THIS WARRANTY IS AN ADDITION TO ANY STATUTORY WARRANTY.)

WARRANTY VOID IF NOT REGISTERED

CROWN CONSTRUCTION EQUIPMENT CONCRETE MIXER

WARRANTY REGISTRATION FORM & INSPECTION REPORT

WARRANTY REGISTRATION (please print)

This form must be filled out by the dealer and signed by both the dealer and the customer at the time of delivery.

Customer's Name _____ Distributor Name _____

Address _____ Address _____

City, State, Code _____ City, State, Code _____

Phone Number (____) _____ Check One:

Contact Name _____ Private

Mixer Model _____ Contractor

Serial Number _____ Other _____

Delivery Date _____

DISTRIBUTOR INSPECTION REPORT

- ___ Tire Pressure Checked
- ___ Wheel Bolts Torqued
- ___ Mixing Drum Turns
- ___ Mixing Drum Pivots
- ___ Drive Belt Tension
- ___ Pulley Alignment
- ___ Lubricate Machine
- ___ Fill Engine Crankcase
- ___ Check Engine Fluid Levels
- ___ Have Licensed Electrician Wire Motor And Provide Power

SAFETY

- ___ Safety Chain Attached
- ___ All Decals Installed
- ___ Review Operating And Safety Instructions

I have thoroughly instructed the buyer on the above described equipment which review included the Operator's Manual content, equipment care, adjustments, safe operation and applicable warranty policy.

Date _____ Dealer's Rep. Signature _____

The above equipment and Operator's Manual have been received by me and I have been thoroughly instructed as to care, adjustments, safe operation and applicable warranty policy.

Date _____ Owner's Signature _____

WHITE	YELLOW	PINK
CROWN CONSTR. EQ.	DISTRIBUTOR	CUSTOMER

TABLE OF CONTENTS

SECTION	DESCRIPTION	PAGE
	Reporting Safety Defects	i
	Proposition 65.....	ii
1	Introduction	1
2	Safety	2
2.1	General Safety	3
2.2	Operating Safety.....	4
2.3	Maintenance Safety	5
2.4	Transport Safety	5
2.5	Tire Safety	5
2.6	Storage Safety.....	5
2.7	Refueling Safety	6
2.8	Electrical Safety.....	6
2.9	Safety Signs	6
2.10	Sign-Off Form	7
3	Safety Sign Locations	8
4	Operation	11
4.1	To the New Operator or Owner	11
4.2	How The Machine Works	12
4.3	Pre-Operation Checklist.....	13
4.4	Pre-Start Procedures	13
4.5	Machine Break-In.....	14
4.6	Controls	15
4.7	Operating	18
4.8	Transporting.....	27
4.9	Storage	30
5	Service and Maintenance	31
5.1	Service	31
5.1.1	Fluids and Lubricants	31
5.1.2	Greasing	31
5.1.3	Servicing Intervals	32
5.1.4	Service Record	38
5.2	Maintenance	39
5.2.1	Engine Oil Changing	39
5.2.2	Engine Speed Setting.....	40
5.2.3	Air Cleaner Maintenance	41
5.2.4	Belt Tension and Alignment.....	42
5.2.5	Paddle Replacement.....	43
6	Trouble Shooting	44
7	Specifications	45
7.1	Mechanical.....	45
7.2	Bolt Torque	46
8	Index	47

REPORTING SAFETY DEFECTS

If you believe that your vehicle has a defect which could cause a crash or could cause injury or death, you should immediately inform the National Highway Traffic Safety Administration (NHTSA) in addition to notifying Crown Construction Equipment.

If NHTSA receives similar complaints, it may open an investigation, and if it finds that a safety defect exists in a group of vehicles, it may order a recall and remedy campaign. However, NHTSA cannot become involved in any individual problems between you, your dealer, or Crown Construction Equipment.

To contact NHTSA you may either call the Auto Safety Hotline toll free at 1-800-424-9393 (366-0123 in Washington, DC area) or write to:

NHTSA
U.S. DEPARTMENT of TRANSPORTATION
400 7th Street SW, (NSA-11)
Washington, DC
20590

You can also obtain other information about motor vehicle safety from the Hotline.



WARNING



CALIFORNIA - Proposition 65 Warning

Engine exhaust and some of its constituents and some dust created by power sanding, sawing, grinding, drilling and other construction activities contains chemicals known to the State of California to cause cancer, birth defects and other reproductive harm.

Some examples of these chemicals are:-

- Lead from lead-based paints
- Crystalline silica from bricks
- Cement and other masonry products
- Arsenic and chromium from chemically treated lumber

Your risk from these exposures varies, depending on how often you do this type of work. To reduce your exposure to these chemicals:

ALWAYS work in a well ventilated area, and work with approved safety equipment, such as dust masks that are specially designed to filter out microscopic particles.

1 INTRODUCTION

Congratulations on your choice of a Crown Construction Equipment Concrete Mixer to complement your construction operation. This equipment has been designed and manufactured to meet the needs of a discriminating buyer for the efficient mixing of concrete.

Safe, efficient and trouble free operation of your Crown Concrete Mixer requires that you and anyone else who will be operating or maintaining the Mixer, read and understand the Safety, Operation, Maintenance and Trouble Shooting information contained in the Operator's Manual.



This manual is applicable to all the Model C-3C, C-6C, C-6P and C-9C Concrete Mixers built by Crown Construction Equipment. Use the Table of Contents or Index as a guide when searching for specific information.

Keep this manual handy for frequent reference and to pass on to new operators or owners. Call your Crown Construction Equipment distributor or dealer if you need assistance or information.

OPERATOR ORIENTATION - The directions left, right, front and rear, as mentioned throughout this manual, are as seen from behind the machine and facing in the direction of towing.

2 SAFETY

SAFETY ALERT SYMBOL

This Safety Alert symbol means **ATTENTION! BECOME ALERT! YOUR SAFETY IS INVOLVED!**

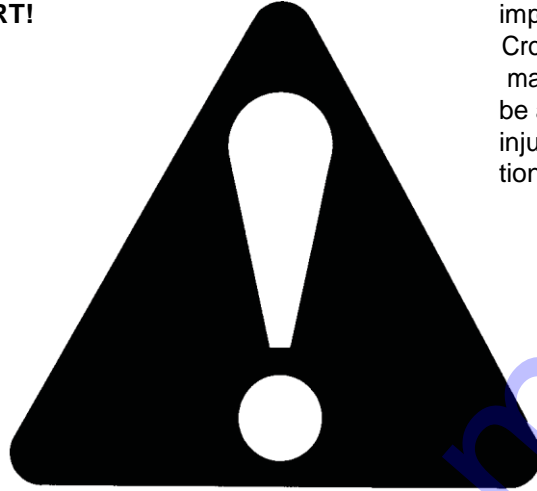

The Safety Alert symbol identifies important safety messages on the Crown Concrete Mixer and in the manual. When you see this symbol, be alert to the possibility of personal injury or death. Follow the instructions in the safety message.

Why is SAFETY important to you?

SIGNAL WORDS:

Note the use of the signal words **DANGER**, **WARNING** and **CAUTION** with the safety messages. The appropriate signal word for each message has been selected using the following guide-lines:

- | | |
|----------------|--|
| DANGER | Indicates an imminently hazardous situation that, if not avoided, will result in death or serious injury. This signal word is to be limited to the most extreme situations, typically for machine components that, for functional purposes, cannot be guarded. |
| WARNING | Indicates a potentially hazardous situation that, if not avoided, could result in death or serious injury, and includes hazards that are exposed when guards are removed. It may also be used to alert against unsafe practices. |
| CAUTION | Indicates a potentially hazardous situation that, if not avoided, may result in minor or moderate injury. It may also be used to alert against unsafe practices. |

SAFETY

YOU are responsible for the **SAFE** operation and maintenance of your Concrete Mixer. **YOU** must ensure that you and anyone else who is going to operate, maintain or work around the Concrete Mixer be familiar with the operating and maintenance procedures and related **SAFETY** information contained in this manual. This manual will take you step-by-step through your working day and alerts you to all good safety practices that should be adhered to while operating the Mixer.

Remember, **YOU** are the key to safety. Good safety practices not only protect you but also the people around you. Make these practices a working part of your safety program. Be certain that **EVERYONE** operating this equipment is familiar with the recommended operating and maintenance procedures and follows all the safety precautions. Most accidents can be prevented. Do not risk injury or death by ignoring good safety practices.

- Mixer owners must give operating instructions to operators or employees before allowing them to operate the machine, and at least annually thereafter.
- The most important safety device on this equipment is a SAFE operator. It is the operator's responsibility to read and understand ALL Safety and Operating instructions in the manual and to follow these. All accidents can be avoided.
- A person who has not read and understood all operating and safety instructions is not qualified to operate the machine. An untrained operator exposes himself and bystanders to possible serious injury or death.
- Do not modify the equipment in any way. Unauthorized modification may impair the function and/or safety and could affect the life of the equipment.

2.1 GENERAL SAFETY

1. Read and understand the Operator's manual and all safety signs before operating, maintaining, adjusting, servicing or cleaning the Mixer.

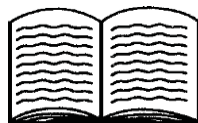

2. Only trained competent persons shall operate the Mixer. An untrained operator is not qualified to operate the machine.

3. Have a first-aid kit available for use, should the need arise and know how to use it.



4. Do not allow riders when towing.

5. Have a fire extinguisher available for use should the need arise and know how to use it.



6. Wear appropriate protective gear. This list includes, but is not limited to:

- A hard hat
- Protective boots with slip resistant soles
- Protective goggles
- Heavy gloves
- Hearing protection



7. Stop engine, disconnect spark plug wire and wait for all moving parts to stop before servicing, adjusting, repairing or cleaning.

8. Wear appropriate hearing protection when operating for long periods of time.



9. Dust Hazard ~ Wear appropriate dust mask around this equipment.



10. Ventilation ~ Never operate any gas powered equipment in a poorly ventilated or enclosed area. Avoid prolonged breathing of exhaust gases.



11. Hot Surface ~ Avoid contact with hot exhaust system and engine. Allow to cool before performing repairs or service.



2.1 GENERAL SAFETY

12. Electrocution Hazard ~ Always use proper size grounded extension cord. Inspect all extension cords for cuts, frayed wire and broken connectors. Do not use cords if not in good condition.



13. Do not refuel the machine while smoking or when near open flame or sparks.



2.2 OPERATING SAFETY

1. Read and understand the Operator's Manual and all safety signs before operating, servicing, adjusting, or cleaning the Mixer.
2. Do not allow riders on the machine during transport.
3. Install, close and secure all guards, shields and hoods before starting or operating.
4. Stop engine or motor, disconnect spark plug wire or unplug power cord, and wait for all moving parts to stop before servicing, adjusting, repairing, or cleaning.
5. Clear the area of all bystanders before starting.
6. Keep hands, feet, hair and clothing away from moving parts.
7. Keep working area clean and dry to prevent slipping and tripping.
8. Do not run the mixer in an explosive atmosphere or in a poorly ventilated or enclosed area.
9. Wear appropriate hearing protection when operating for long periods of time.
10. Always attach safety chain when towing.

11. Do not exceed a safe travel speed when towing. Slow down for corners and when going over rough terrain.
12. Review safety instructions with all operators annually.

Gas engine powered units:

- Do not place hands in the drum unless the engine is OFF and the spark plug wire is disconnected.
- Stay away from hot engine components during operation.
- Do not smoke when refueling gas engine.

Electric motor powered units:

- Do not place hands in the drum unless the motor is OFF and the power cord unplugged.
- Have a licensed electrician wire up and provide power to the motor.
- Only use a power cord that is grounded.
- Always use an electrical cord with the required power carrying capacity.

2.3 MAINTENANCE SAFETY

1. Review the Operator's Manual and all safety items before working with, maintaining or operating the Mixer.
2. Stop engine or motor, disconnect spark plug wire or unplug power cord, and wait for all moving parts to stop before servicing, adjusting, repairing, or cleaning.
3. Follow good shop practices:

- Keep service area clean and dry.
- Be sure electrical outlets and tools are properly grounded.
- Use adequate light for the job at hand.



4. Keep hands, feet, clothing and hair away from all moving and/or rotating parts.
5. Do not place hands in the drum unless the engine is off and the spark plug wire is disconnected or the power cord is unplugged.
6. Do not attempt any adjustment or maintenance to any system of the Mixer unless the power source is disabled.
7. Make sure that all guards, shields and hoods are properly installed and secured before operating the Mixer.
8. Securely support the machine using blocks or safety stands before working beneath it or changing tires.
9. Store and transfer gasoline, solvents, cleaners or any flammable liquids only in safety standard approved containers.

2.4 TRANSPORT SAFETY

1. Read and understand ALL the information in the Operator's Manual regarding procedures and SAFETY when operating the Mixer in the workplace and/or on the road.
2. Always travel at a safe speed. Use caution when making corners or on a rough surface.
3. Make sure all the lights and reflectors that are required by the local highway and transport authorities are in place, are clean and can be seen clearly by all overtaking and oncoming traffic.
4. Do not allow riders on any part of the machine during either road or highway travel.
5. Always use a safety chain between the Mixer and the towing vehicle when transporting.
6. Use a mechanical retainer through the ball hitch or clevis pin before transporting.

2.5 TIRE SAFETY

1. Failure to follow proper procedures when mounting a tire on a wheel or rim can produce an explosion which may result in serious injury or death.
2. Do not attempt to mount a tire unless you have the proper equipment and experience to do the job.
3. Have a qualified tire dealer or repair service perform required tire maintenance.

2.6 STORAGE SAFETY

1. Store unit in an area away from human activity.
2. Do not permit children to play on or around the stored Mixer.

2.7 REFUELING SAFETY

1. Handle fuel with care. It is highly flammable.
2. Allow engine to cool for 5 minutes before refueling. Clean up spilled fuel before restarting engine.
3. Do not refuel the machine while smoking or when near open flame or sparks.
4. Always use an approved fuel container.
5. Fill fuel tank outdoors.
6. Prevent fires by keeping machine clean of accumulated trash, grease and debris.



2.8 ELECTRICAL SAFETY

1. Have a licensed electrician wire up and supply power to the electric motor.
2. Always use a grounded power cord with the required capacity to carry the power to the motor.
3. Route the power cord out of the way or protect from damage.
4. Turn motor off, unplug power cord or turn off power at master panel and wait for all moving parts to stop before servicing, maintaining, adjusting or cleaning.
5. Keep all electrical components in good condition.

2.9 SAFETY SIGNS

1. Keep safety signs clean and legible at all times.
2. Replace safety signs that are missing or have become illegible.
3. Replaced parts that displayed a safety sign should also display the current sign.
4. Safety signs are available from your Distributor or the factory.

How to Install Safety Signs:

- Be sure that the installation area is clean and dry.
- Decide on the exact position before you remove the backing paper.
- Remove the smallest portion of the split backing paper.
- Align the sign over the specified area and carefully press the small portion with the exposed sticky backing in place.
- Slowly peel back the remaining paper and carefully smooth the remaining portion of the sign in place.
- Small air pockets can be pierced with a pin and smoothed out using the piece of sign backing paper.

2.11 SIGN-OFF FORM

Crown Construction Equipment follows the general Safety Standards specified by the Society of Automotive Engineers (SAE) and the Occupational Safety and Health Administration (OSHA). Anyone who will be operating and/or maintaining the Crown Concrete Mixer must read and clearly understand ALL Safety, Operating and Maintenance information presented in this manual.

Do not operate or allow anyone else to operate this equipment until such information has been reviewed. Annually review this information before the season start-up.

Make these periodic reviews of SAFETY and OPERATION a standard practice for all of your equipment. We feel that an untrained operator is unqualified to operate this machine.

A sign-off sheet is provided for your record keeping to show that all personnel who will be working with the equipment have read and understand the information in the Operator's Manual and have been instructed in the operation of the equipment.

SIGN-OFF FORM

DATE	EMPLOYEES SIGNATURE	EMPLOYERS SIGNATURE

3 SAFETY SIGN LOCATIONS

The types of safety signs and locations on the equipment are shown in the illustration below. Good safety requires that you familiarize yourself with the various Safety Signs, the type of warning and the area, or particular function related to that area, that requires your SAFETY AWARENESS.

• **Think SAFETY! Work SAFELY!**

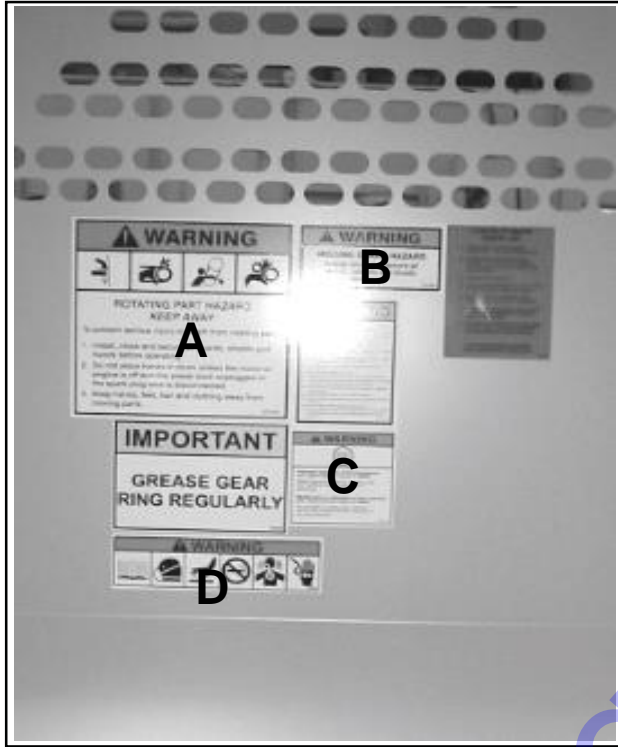

Located on inside of Hood

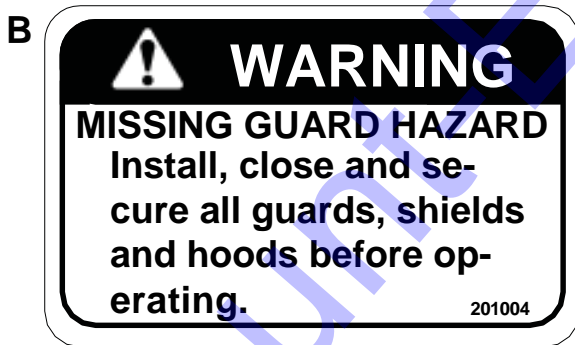
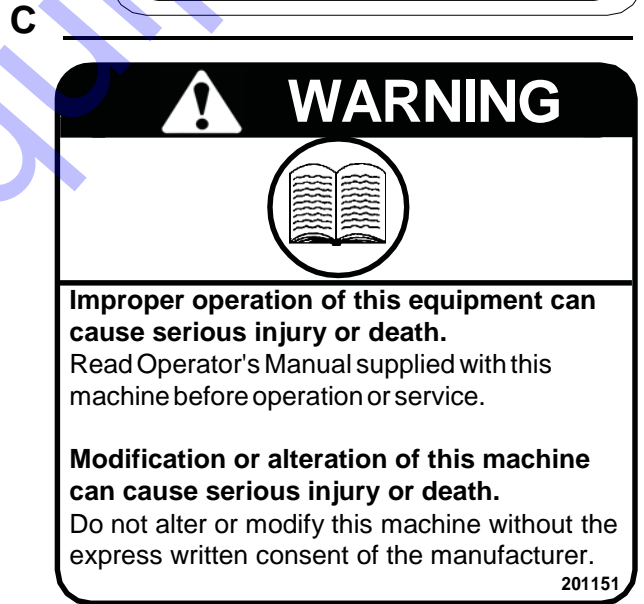

REMEMBER - If Safety Signs have been damaged, removed, become illegible or parts replaced without safety signs, new signs must be applied. New safety signs are available from your authorized dealer.

3 SAFETY SIGN LOCATIONS GAS ENGINE POWER UNIT

The types of safety signs and locations on the equipment are shown in the illustration below. Good safety requires that you familiarize yourself with the various Safety Signs, the type of warning and the area, or particular function related to that area, that requires your SAFETY AWARENESS.

- **Think SAFETY! Work SAFELY!**



DECAL 'E' ~ ALSO LOCATED ON OUTSIDE OF HOOD

E

WARNING

1. Read and understand Operator's Manual and safety signs before starting.
2. Stop engine, disconnect spark plug wire and wait for all moving parts to stop before servicing, maintaining, adjusting or cleaning.
3. Keep hands, feet, hair and clothing away from moving parts.
4. Install, close and secure all guards, shields and hoods before operating.
5. Do not place hands in the drum unless engine is OFF and spark plug wire is disconnected.
6. Stay away from hot engine components during operation.
7. Do not smoke when refueling.
8. Follow good safety procedures when handling fuel.
9. Do not operate in an explosive atmosphere or a poorly ventilated area without adequate ventilation.
10. Keep working area dry and clean to prevent slipping and tripping.
11. Always attach safety chain when towing.
12. Comply with applicable transporting regulations when towing.
13. Do not allow riders during transporting.
14. Do not exceed a safe travel speed when transporting. Slow down for corners and when going over rough terrain.

201001



F

**USE
GASOLINE
FUEL ONLY**

201152

G

DANGER

**FIRE HAZARD
NO SMOKING**

To prevent serious injury or death from fire:

1. Do not smoke when refueling.
2. Keep sparks, flames and hot material away from flammable substances.

201005

REMEMBER - If Safety Signs have been damaged, removed, become illegible or parts replaced without safety signs, new signs must be applied. New safety signs are available from your authorized dealer.

3 SAFETY SIGN LOCATIONS ELECTRIC MOTOR POWER UNIT

The types of safety signs and locations on the equipment are shown in the illustration below. Good safety requires that you familiarize yourself with the various Safety Signs, the type of warning and the area, or particular function related to that area, that requires your SAFETY AWARENESS.

- **Think SAFETY! Work SAFELY!**

DECAL 'H' ~ ALSO LOCATED ON OUTSIDE OF HOOD

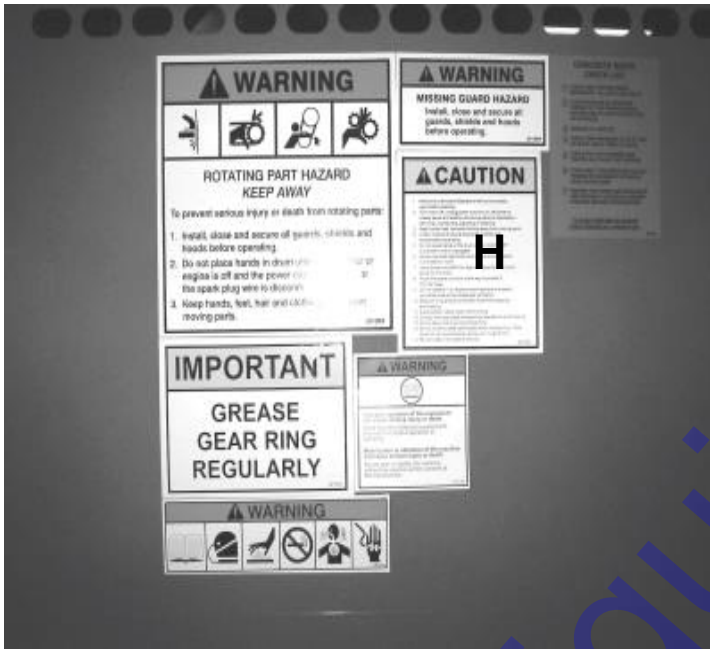

H

CAUTION

1. Read and understand Operator's Manual and safety signs before starting.
2. Turn motor off, unplug power cord or turn off power at master panel and wait for all moving parts to stop before servicing, maintaining, adjusting or cleaning.
3. Keep hands, feet, hair and clothing away from moving parts.
4. Install, close and secure all guards, shields and hoods before operating.
5. Do not place hands in the drum unless engine is OFF and power cord is unplugged.
6. Have a licensed electrician wire up and provide power to the electric motor.
7. Use a power cord with the required capacity to carry the power to the motor.
8. Route the power cord out of the way or protect it from damage.
9. Do not operate in an explosive atmosphere or a poorly ventilated area without adequate ventilation.
10. Keep working area dry and clean to prevent slipping and tripping.
11. Always attach safety chain when towing.
12. Comply with applicable transporting regulations when towing.
13. Do not allow riders during transporting.
14. Do not exceed a safe travel speed when transporting. Slow down for corners and when going over rough terrain.
15. Review safety instructions annually.

201002

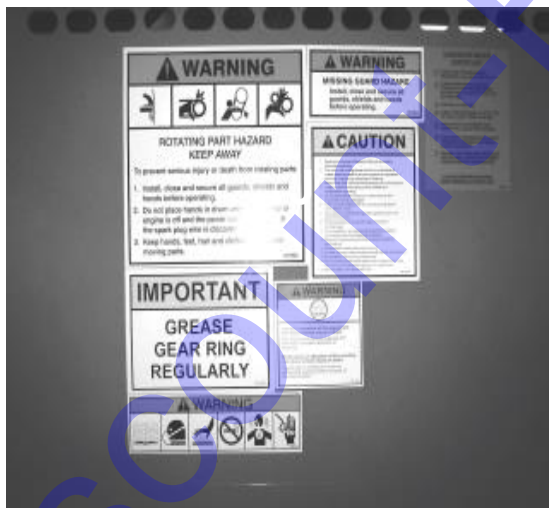

J

DANGER

ELECTROCUTION HAZARD

1. Turn machine OFF, shut down and lock out power source, unplug power cord and wait for all moving parts to stop before servicing or repairing machine or electrical components.
2. Keep electrical components in good repair.

201006

REMEMBER - If Safety Signs have been damaged, removed, become illegible or parts replaced without safety signs, new signs must be applied. New safety signs are available from your authorized dealer.

3 SAFETY SIGN LOCATIONS

The types of safety signs and locations on the equipment are shown in the illustration below. Good safety requires that you familiarize yourself with the various Safety Signs, the type of warning and the area, or particular function related to that area, that requires your SAFETY AWARENESS.

- **Think SAFETY! Work SAFELY!**



K

!
WARNING

105
km/h

Excessive towing speed can cause serious injury or death.
Do NOT exceed 65 mph (105 km/h)

1. Make certain that the wheel lug nuts and axle mounting hardware are tight.
2. Check pressure and overall condition of tires.

201151

L

!
CAUTION

WHEN TOWING, ENSURE DRAWBAR IS IN THE MIDDLE POSITION

201012

N

!
CAUTION

Use 2 people to lift and position hitch on and off tow vehicle.

201155

REMEMBER - If Safety Signs have been damaged, removed, become illegible or parts replaced without safety signs, new signs must be applied. New safety signs are available from your authorized dealer.

M

!
NOTICE

- ◆ Ensure tow vehicle has towing capacity for the weight of this machine.
- ◆ Do not tow the machine unless the draw bar is bolted in place and the safety bolt on the end of the draw bar is securely fastened.
- ◆ Close engine fuel cutoff (where applicable) before towing mixer to prevent leakage into the engine crankcase.
- ◆ Use 2 people to lift and position hitch (pintle and ball) on and off tow vehicle.
- ◆ Securely attach hitch to towing vehicle - pintle or ball type coupler (ball type shown).
- ◆ Be certain ball clamp captures ball and lever or handwheel is fully clamped. Ensure use of safety pin through latch or handwheel (for ball type coupler).
- ◆ Safety chain attachment (see illustration) chains must cross under the draw bar and be positioned to prevent the draw bar from dropping to the ground in the event of a hitch failure.
- ◆ Connect lighting plug/electric brake plug (where applicable).
- ◆ Make certain that the wheel lug nuts and axle mounting hardware are tight.
- ◆ Check pressure and overall condition of tires.
- ◆ Test brakes (if applicable).

201150

4 OPERATION



OPERATING SAFETY

1. Read and understand the Operator's Manual and all safety signs before operating, servicing, adjusting, or cleaning the Mixer.
2. Do not allow riders on the machine during transport.
3. Install, close and secure all guards, shields and hoods before starting or operating.
4. Stop engine or motor, disconnect spark plug wire or unplug power cord, and wait for all moving parts to stop before servicing, adjusting, repairing, or cleaning.
5. Clear the area of all bystanders before starting.
6. Keep hands, feet, hair and clothing away from moving parts.
7. Keep working area clean and dry to prevent slipping and tripping.
8. Do not run the mixer in an explosive atmosphere or in a poorly ventilated or enclosed area.
9. Wear appropriate hearing protection when operating for long periods of time.
10. Always attach safety chain when towing.
11. Do not exceed a safe travel speed when towing. Slow down for corners and when going over rough terrain.
12. Review safety instructions with all operators annually.

Gas engine powered units:

- Do not place hands in the drum unless the engine is OFF and the spark plug wire is disconnected.
- Stay away from hot engine components during operation.
- Do not smoke when refueling gas engine.

Electric motor powered units:

- Do not place hands in the drum unless the motor is OFF and the power cord unplugged.
- Have a licensed electrician wire up and provide power to the motor.
- Only use a power cord that is grounded.
- Always use an electrical cord with the required power carrying capacity.

4.1 TO THE NEW OPERATOR OR OWNER

The Crown Construction Equipment Concrete Mixer is designed to efficiently combine water, aggregate and cement into a mixture for forming concrete. It is the responsibility of the operator to be familiar with the machine before starting.

It is the responsibility of the owner or operator to read this manual before starting. Follow all safety instructions exactly. Safety is everyone's business. By following recommended procedures, a safe working environment is provided for the operator, bystanders and the environment.

Many features incorporated into this machine are the result of suggestions made by customers like you. Read this manual carefully to learn how to operate the machine safely and how to set it to provide maximum mixing efficiency. By following the operating instructions in conjunction with a good maintenance program, your Mixer will provide many years of trouble-free service.

4.2 HOW THE MACHINE WORKS

The Concrete Mixer consists of a large rotating drum with internal paddles for combining cement, aggregate and water into a mixture for forming concrete. The enclosure on the back end houses the gas engine for turning the mixing drum. A set of pulleys and drive belt within the enclosure transmits rotational power to the drum.

A lever or wheel on the front end of the drum assembly allows the operator to tilt the drum to the required position for mixing and emptying. An extendable hitch on the front of the frame allows the hitch to extend for towing and retracts during operation.



- A Steel Drum
- B Mixing Paddles
- C Power Enclosure
- D Plastic Drum
- F Gas Engine
- G Drum Drive Gear
- H Drum Tilt Wheel
- J Drum Tilt Lock
- K Tires
- L Hitch
- M Safety Chain
- N Emergency Stop

Fig. 1 MACHINE COMPONENTS

4.3 PRE-OPERATION CHECKLIST

Efficient and safe operation of the Mixer requires that each operator reads and understands the operating procedures and all related safety precautions outlined in this section. A pre-operation checklist is provided for the operator. It is important for both personal safety and maintaining the good mechanical condition of the machine that this checklist is followed.

Before operating the Mixer and each time thereafter, the following areas should be checked off:

1. Gas Engine Units:

- a. Check all fluid levels: fuel and engine oil. Refuel or top up engine oil as required.
- b. Check the tires and be sure that they are inflated to the specified pressure.
- c. Check the tension and alignment of drive belt. Tension or align as required.
- d. Check the engine speed at maximum. Be sure it is set to give a drum rotation speed of 18 to 24 RPM.
- e. Use the Emergency Stop switch to stop the engine to be sure that it works. Repair or replace if not functioning.
- f. Lubricate machine per Maintenance Section.
- g. Close and secure all guards, shields and hoods.

2. Electric motor units:

- a. Check the tension and alignment of drive belt. Tension and align as required.
- b. Check the tires and be sure that they are inflated to the specified pressure.
- c. Lubricate machine per Maintenance Section.
- d. Close and secure all guards, shields and hoods.

4.4 PRE-START PROCEDURES

All machines are sent from the factory in a special shipping configuration to prevent spilling oil or gas. As a result, the following items must be done prior to starting the machine:

1. Gas engine powered units:

- a. Fill the engine crankcase with its specified oil (SAE 30W or 10W30 oil).

IMPORTANT

Engine warranty is void if the engine is run without oil.

Refer to engine manual for oil specifications if operating in unusual temperature conditions.

- b. Fill the fuel tank with regular unleaded gas. Do not use an ethanol blend.
- c. Start the engine and set the high idle speed to give a drum rotation speed of 18 to 24 RPM.

IMPORTANT

The engine is supplied from the engine manufacture with the high idle speed set at approximately 3500 RPM and no gas or oil. As a result, the engine is not run when it is mounted to the Mixer. It is the responsibility of the customer to add oil and gas, start the engine and reset the high idle RPM to the operating range (Refer the Maintenance Section for procedure).

- d. Be sure that Emergency Stop switch is functioning properly.

2. Electric motor powered units:

- a. Have a licensed electrician provide power to the motor. Use only a grounded cord with sufficient capacity to carry the required load.
- b. Have a licensed electrician wire up the motor if it is not a 110 volt unit.

4.5 MACHINE BREAK-IN

A special break-in procedure has been developed to insure the integrity of the machine when first starting. When using the machine for the first time, follow this procedure.

A. Before Starting:

1. Read the engine and Mixer Operator's Manuals.
2. Review and follow pre-start procedures before starting machine (Section 4.4).

B. At 1/2, 2, 5 and 10 hours:

1. Check all machine fluid levels: Fuel and engine oil. Refuel or top up engine oil as required.
2. Retorque wheel bolts.
3. Check for loose hardware. Tighten to specified torque.
4. Check drive belt tension and alignment. Tension and align as required.
5. Lubricate the points defined in the Maintenance section.
6. Then go to the service schedule as defined in the Maintenance section.

C. At 10 hours:

1. Change the engine oil.
2. Replace with the specified oil.
3. Then go to the oil replacement schedule as defined in the Maintenance section and engine manual.

4.6 CONTROLS

Before starting to work, all operators should familiarize themselves with the location and function of the controls.

1. Gas Engine Model:

A Honda gas engine is available for use with the Mixer. Always read the engine Operator's Manual supplied with the machine for the detailed operating procedures for your engine. A typical engine:

a. Ignition switch:

This switch controls the electrical power to the engine electrical system. Turn the switch clockwise to turn the electrical system ON and the engine will run. Turn counterclockwise to stop the engine.

b. Fuel shutoff valve:

The engine is equipped with a valve between the fuel tank and the carburator. Slide the fuel valve toward the block to turn ON and away for OFF. Turn the fuel OFF when not in use or before transporting.

c. Throttle:

This lever controls the engine RPM. Move the lever laterally to increase or decrease the RPM. Always run at maximum throttle when operating.

d. Choke:

The choke controls the fuel/air mixture to the engine. Close the choke when starting if the engine is cold. Open the choke as the engine warms. Always open the choke fully during operation.

e. Starting rope:

This retracting rope and T bar is used to turn the engine over for starting. Grasp the T bar firmly and pull the rope sharply to start the engine. Close the choke if the engine is cold.



Fig. 2 GAS ENGINE CONTROLS

f. Centrifugal Clutch:

The 9Hp model is fitted with a Centrifugal Clutch. When starting engine adjust speed to 1800rpm to engage drum.

THIS UNIT HAS A CENTRIFUGAL CLUTCH
ADJUST MOTOR TO 1800 RPM TO ENGAGE DRUM

Decal: 9Hp Models

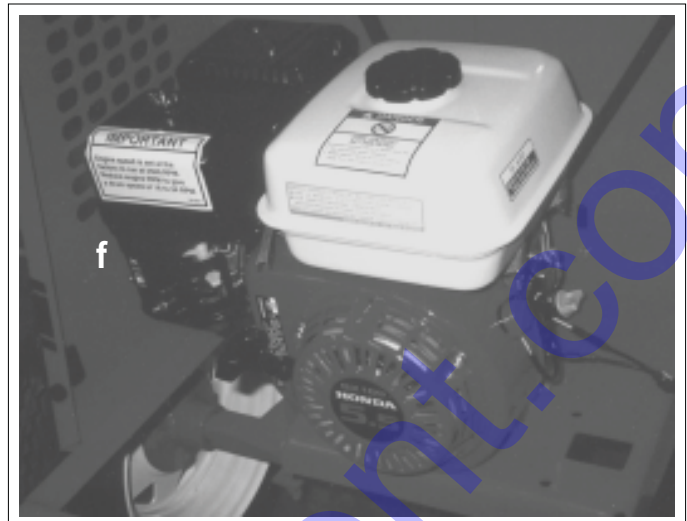

g. Emergency Stop Switch:

This push-pull switch shorts out the power to the engine ignition system and is located on the outside of the hood. Push the switch in to stop the engine and pull out to allow it to run.

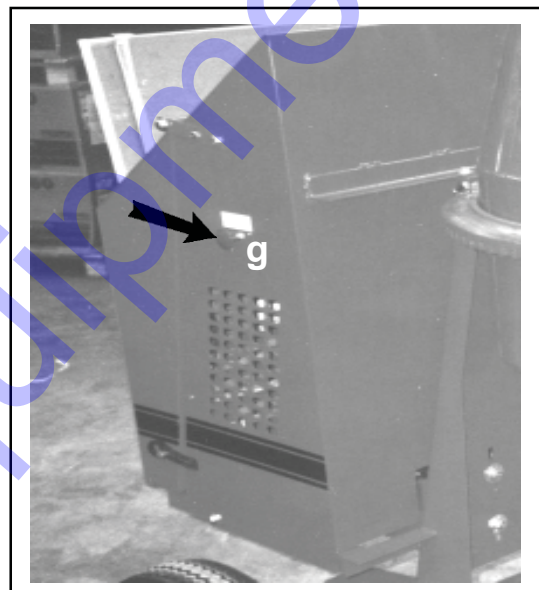



Fig. 3 EXTERNAL KILL SWITCH (TYPICAL)

2. Electric Motor(Typical):

a. Master ON/OFF:

This switch controls the power to the electric motor that turns the mixing drum. Move the switch rearward to turn ON and forward for OFF.

 **WARNING**
Machine is shown with engine hood open for illustrative purposes only. Never operate with hood open.

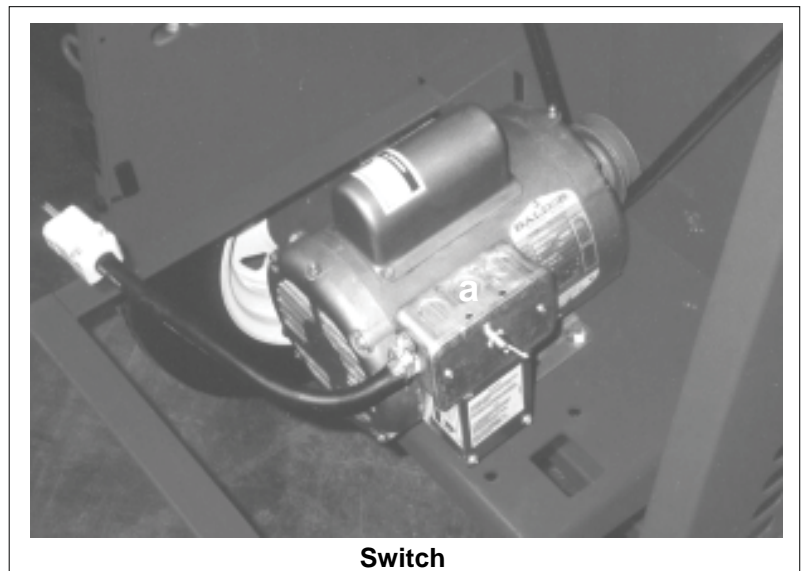

Switch

Fig. 4 ELECTRIC MOTOR (TYPICAL)

3. Drum Position:

This lever and lock assembly sets the position of the mixing drum.

- a. The C-3C model is equipped with a spring-loaded pin that seats into holes in the lock disc. Relieve the load on the pin and pull it out of the hole when changing the angle of the drum. The C-6C and C-9C are equipped with a spring-loaded lever that seats into cogs on an anchor disc. Relieve the load on the pin, lift the latch and turn the wheel when changing the angle of the drum.
- b. Change the drum angle on the C-3C model using lever and the wheel on the C-6C and C-9C models.



C-3C

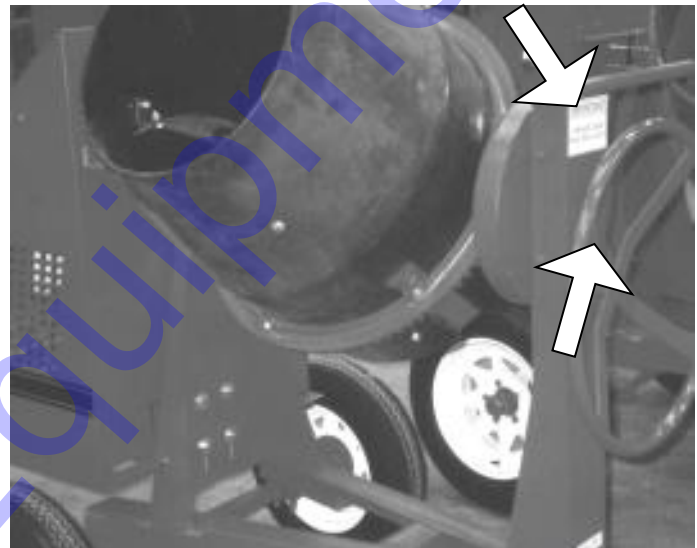

C-6C (LOCKED)



C-9C (UNLOCKED)

Fig. 5 LEVER AND LOCK ASSEMBLY

4.7 OPERATING



OPERATING SAFETY

1. Read and understand the Operator's Manual and all safety signs before operating, servicing, adjusting, or cleaning the Mixer.
2. Do not allow riders on the machine during transport.
3. Install close and secure all guards, shields and hoods before starting or operating.
4. Stop engine or motor, disconnect spark plug wire or unplug power cord, and wait for all moving parts to stop before servicing, adjusting, repairing, or cleaning.
5. Clear the area of all bystanders before starting.
6. Keep hands, feet, hair and clothing away from moving parts.
7. Keep working area clean and dry to prevent slipping and tripping.
8. Do not run the mixer in an explosive atmosphere or in a poorly ventilated or enclosed area.
9. Wear appropriate hearing protection when operating for long periods of time.
10. Always attach safety chain when towing.
11. Do not exceed a safe travel speed when towing. Slow down for corners and when going over rough terrain.
12. Review safety instructions with all operators annually.

Gas engine powered units:

- Do not place hands in the drum unless the engine is OFF and the spark plug wire is disconnected.
- Stay away from hot engine components during operation.
- Do not smoke when refueling gas engine.

Electric motor powered units:

- Do not place hands in the drum unless the motor is OFF and the power cord unplugged.
- Have a licensed electrician wire up and provide power to the motor.
- Only use a power cord that is grounded.
- Always use an electrical cord with the required power carrying capacity.

Each operator should review this section of the manual when starting a project and as often as required to be familiar with the machine. When operating, follow this procedure:

1. Review and follow the Pre-Start and Pre-Operation checklists.
2. Review the location and function of all controls.
3. Determine ratio of the cement, water and aggregate required for your mixture. Always use the same mixture ratio for each batch.
4. Be sure the drum turns at 18 to 24 RPM to insure proper mixing.
5. **Starting machine:**
 - A. **Electric motor powered units:**
 - a. Check that everyone is clear of the machine.
 - b. Unlatch and open the hood.
 - c. Turn the power switch ON.
 - d. Close and latch the hood.

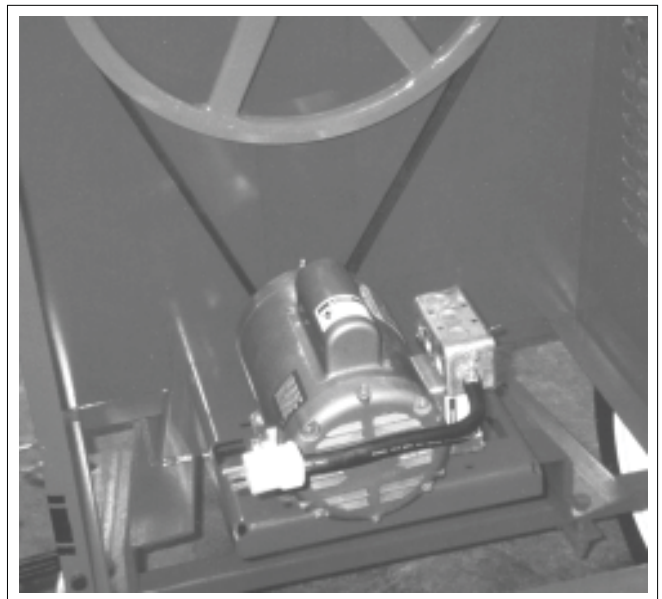

Fig. 6 ELECTRICAL POWER SWITCH (TYPICAL)

B. Gas engine powered units:

- a. Check that everyone is clear of the machine.
- b. Pull the Emergency Stop switch out.
- c. Unlatch and open the engine compartment hood.
- d. Move the throttle into its midrange position.
- e. Close the choke if starting when the engine is cold.
- f. Turn the ignition switch to its RUN position.
- g. Pull sharply on the T bar rope to start the engine.
- h. Allow the engine to run for a couple of minutes to warm up.
- i. Open the choke to its fully open position when the engine is warm.
- j. Move the throttle to its maximum RPM position.

IMPORTANT
Be sure the engine has been set to give a drum speed of 18 to 24 RPM.

- k. Close and secure the engine compartment hood.

! WARNING
Machine is shown with engine hood open for illustrative purposes only. Never operate with hood open.

6. Stopping machine:

A. Electric motor powered units:

- a. Empty the drum of the concrete mixture.
- b. Unlatch and open the hood.
- c. Turn the power switch OFF.
- d. Close and latch the hood.

B. Gas engine powered units:

- a. Empty the drum of the concrete mixture.
- b. Unlatch and open the hood.
- c. Move the throttle to its low idle position.
- d. Stop the engine by turning the switch OFF or depressing the Emergency Stop switch.
- e. Close and secure the engine compartment hood.

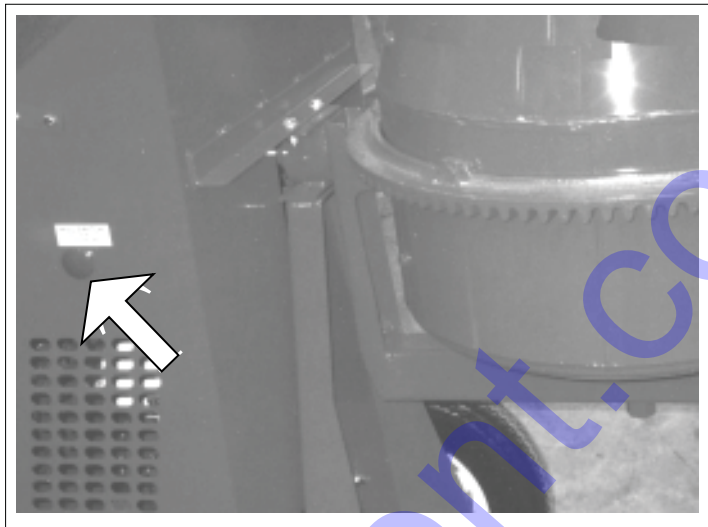
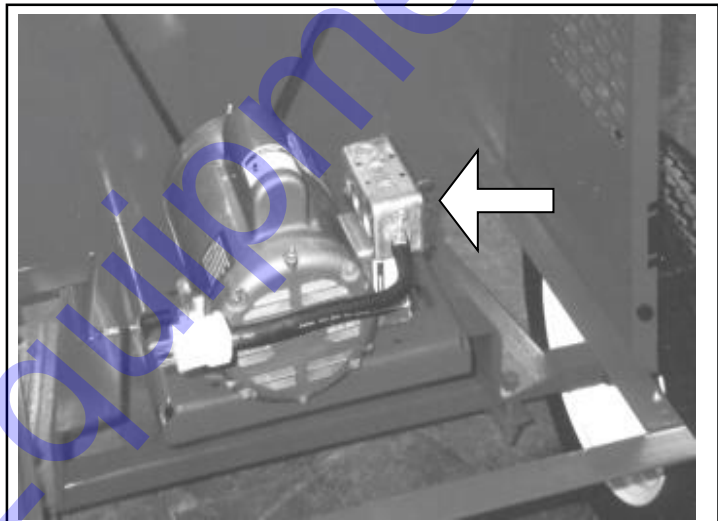
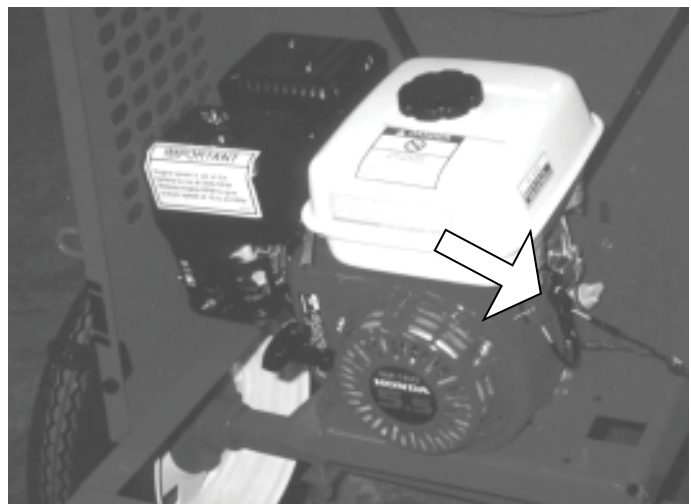

Fig. 7 EMERGENCY STOP SWITCH



Power Switch



Stop Switch

Fig. 8 STOPPING

7. Emergency Stopping:

If an emergency arises, stop the machine by turning the power switch OFF or by pushing the Emergency Stop switch in.

8. Machine placement:

Always place the Mixer in a location so the operator has easy access to the mixture ingredients when adding to the mixing drum. Always position to provide adequate clearance for the machine or equipment removing the concrete mixture from the mixing drum. On the electric motor models, route the power cord out of the way to prevent damage. Do not run the mixture in an explosive atmosphere or in a poorly ventilated or enclosed area.

9. Filling:

When mixing concrete, follow this procedure:

- a. Clear the working area of unauthorized personnel.
- b. Start the mixer.
- c. Add half the required amount of water into the mixing drum.
- d. Add a small amount of aggregate into the drum.
- e. Add the cement required for the batch.
- f. Add the rest of the water.
- g. Add the aggregate until the desired workability is obtained.

NOTE

Add aggregate a little at a time until the desired consistency is obtained.

- h. Mix until there is an even consistency throughout the mixture. Look into the drum. When the entire mixture is an even khaki green color, the cement is evenly distributed throughout the mixture.



- i. Slowly tilt the drum down to discharge the mixture.
- j. Move the drum back into its mixing position and immediately add half the water for the next batch. This will help to keep the drum and mixing paddles clean and prevent lumps from forming in the concrete.

10. Mixing time:

After all the ingredients have been added to the drum, allow time for the material to reach a uniform color and consistency. Watch the color and consistency of the mixture as the drum is turning. When the entire mixture becomes a deep khaki green color, it means the cement is uniformly distributed throughout the mixture and can be discharged. If the mixture is not uniform, the concrete will have weak spots.

11. Emptying drum:

All Mixers are equipped with a lock for anchoring the drum at a pre-determined angle. Move the wheelbarrow or other concrete receiver up to the side of the Mixer. To empty the drum:

a. C-3C Model:

Lift the tilt lever to release the load on the anchor pin. Pull the spring-loading anchor pin out of the hole in the anchor disc. Slowly lower the drum to discharge the mixture into the wheelbarrow. Lift the drum back into its mixing position and secure with the lock pin.

b. C-6C and C-9C Models:

Turn the tilt wheel to release the load on the anchor pin. Pull and lift the anchor lock bracket to release the lock. Use the tilt wheel to slowly lower the drum into its discharge position. Do not engage the anchor lock unless the drum has stopped moving. Raise the drum back into its mixing position and secure with the lock after the drum has been emptied.



C-3C Model

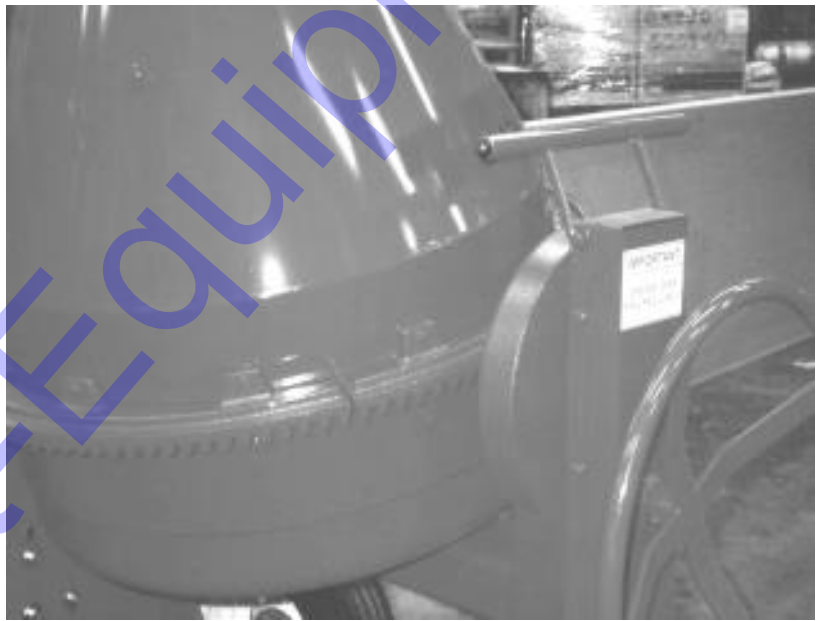

Tilt Lock

Fig. 9 EMPTYING DRUM

12. Cleaning:

Under normal operating conditions, adding water and some aggregate to the drum immediately after emptying will wash and clean the mixing paddles and the inside of the drum and keep them clean. If a slow build up of residue is occurring, add water and coarse aggregate to the drum at the end of the working day and let it run for 15 minutes. If the coarse aggregate does not remove the build-up, disable the machine by unplugging the power cord or disconnecting the spark plug wire and using a hammer and chisel to remove the lumps.

If your machine is equipped with a poly drum, use a rubber mallet to strike the outside and break the build-up loose. If you do not have a rubber mallet, lay a 2 x 4 against the drum. Hit the 2 x 4 with a hammer. The wood will provide protection for the poly drum.

At the end of the working day, thoroughly wash the inside of the drum and the outside of the machine to remove any residue build-up or clumps. **Do not get water on the electric motor or gas engine.**

13. Drum speed:

The best mixing action occurs when the drum is turning 18 to 24 RPM. Do not operate outside of this speed range. Increasing the drum speed does not significantly change mixing characteristics. Mixing time is much more important and the mixture must be thoroughly blended to obtain uniform and consistent concrete.

14. Capacities:

Each model has its own specified capacity. When that capacity is exceeded, the excess spills out of the drum making a mess of the working area and increases the required time for mixing. It is recommended to use an additional mixer if more mixing capacity is required.



Steel Drum



Poly Drum

Fig. 10 CLEANING

Table 1 Capacity

C-3C	C-6P C-6C	C-9C
3 1/2 ft ³	6 ft ³	9 ft ³

15. Mixes for ordinary jobs:

Kind of work.	Trial Mixture for First Batch			Imperial gals/liters Water to Add to Each 1 Sack Batch			Maximum Aggregate	Material needed for 1 Cubic Yard C (cubic Metre) of Concrete		
	Cement sacks	Sand Cu. ft. (kg)	Stone Cu. ft. (kg)	Dry sands	Moist Sand	Wet Sand		Size Inches (mm)	Cement sacks	Sand Cu. ft. (kg)
Thick footing or foundation walls that need not be watertight, retaining walls, etc.	1	2-1/2 (100)	4 (180)	5 (22)	4-1/2 (20)	3-1/2 (16)	1-1/2 (40)	5-1/3 (7)	13 (655)	21 (1245)
Watertight basement walls, floors, 1 steps, sidewalks, driveways, piers, columns, beams, etc.		2 (77)	3 (136)	4-1/4 (20)	3-3/4 (17)	3-1/4 (15)	1 (25)	6-1/2 (8.5)	13 (655)	19-1/2 (1157)
Fence posts, flower boxes, benches, bird baths and any thin section about 2 inches or less.	1	2 (77)	2 (77)	3-1/2 (16)	3 (13.7)	2-3/4 (12.5)	3/4 (20)	8 (10.5)	16 (307)	16 (949)

16. Material Requirement Calculations:

Example:

A concrete driveway 100 feet long (30m) by 10 feet wide (3M) by 6 inches deep (150 mm).

- Determine volume of concrete required
 $\text{Length} \times \text{Width} \times \text{Depth}$
 $= 100 \times 10 \times 0.5 = 500 \text{ cu.ft.}$
 $(= 30 \times 3 \times .15 = 13.5 \text{ cu. metres})$
- Select mix required for the application (refer to table above) in this case a 1:2:3 mix by volume is suitable.

NOTE

500 cu. ft. divided by 27 cu. ft. = 18.5 cu. yds.

- Calculate the material required from the values in the table.
Cement $18.5 \times 6-1/2 = 120 \text{ sacks}$
 $(13.5 \times 8.5 = 115 \text{ sacks})$
Sand $18.5 \times 13 = 240.5 \text{ cu. ft.} - 8.9 \text{ cubic yards}$
 $(13.5 \times 655 = 8842 \text{ kg} - 6.5 \text{ cu. metres})$
Stone $18.5 \times 19-1/2 = 360.75 \text{ cu. ft.} 13.4 \text{ cu. yards}$
 $(13.5 \times 1157 = 15620 \text{ kg} 9.76 \text{ cu. metres})$

17. Volumes and weights of materials:

1 Bag of Cement	88 lb	1 Bag of Cement	40 Kg
1 Cu. ft. Sand/Gravel	85-100 lb	1 Cu. metre Sand/Gravel	1360-1600 Kg
1Cu. ft. Plain Concrete	140-150 lb	1Cu. metre Plain Concrete	2240-260 Kg
1 Cu. ft. Water	62-65 lb	1 litre Water	1 kg
1 Imperial Gallon of Water	10 lb	1 Cu. metre Water	1000 kg
1 Cu. Yard		27 cu. ft. = 7646 cu. metre	

18. Finishing:

For driveways, sidewalks, livestock floors, paved yards, and other work where a non-skid surface is required, a wood float or belt finish is recommended. For such a finish the fresh concrete is struck off flush with the top of the forms as soon as it is placed, then the wood float is used to make an even surface.

The final finishing is delayed until the concrete hardens enough to become quite stiff, then finishing is done with a wood float which results in a uniform gritty surface.

A final finish on driveways, pavements, and similar work can be produced with a strip of canvas or rubber, not less than 6 nor more the 12 inches wide, and at least 2 feet longer than the width of the slab being finished. This is used immediately after the wood float and is moved back and forth in a sideways direction as it is advanced. For the first time, vigorous 12 inch strokes cross-wise of the slab are used. Advance slowly along the slab as the surface is made smooth and even. Repeat immediately after the water sheen disappears. This time the length of the side-wise strokes of the strip of canvas or rubber should not be more than 4 inches and the forward movement should be slightly faster than the first time over. Surface water should be avoided. However, when there is a small amount present, it should be allowed to evaporate before finishing. If there is considerable water, it is removed with a broom, belt, float, or other convenient means. It is never good practice to sprinkle dry cement or a mixture of cement and fine aggregate on fresh concrete to take up surface water as such fine material will form a layer on the surface that is likely to dust or hair check when the concrete hardens.

For a smooth finish such as is required for feed mangers, poultry house floors, dairy barn, gutters, basement floors, and similar work, follow the wood float with a steel trowel only after the surface has become quite stiff. Excessive trowelling or the use of the steel trowel before the mix has become stiff forces the larger hard wearing particles of aggregate to the bottom, leaving a collection of the paste and fine, weak particles on the surface. The excess water near the surface evaporates, leaving a thin honeycombed layer of weak material just where toughness and extra strength are required. Excessive cracking, spalling and dusting may result. Use the steel trowel sparingly.

19. Curing concrete:

Concrete hardens because of chemical reaction between the cement and water. This reaction takes place only as long as the temperatures are favourable and moisture is present to hydrate the cement. Maintaining freshly placed concrete in a moist condition to promote hardening and strength increase is called curing.

Moist curing greatly increases the strength of concrete. Tests show that concrete damp cured for 7 days will be approximately 50% stronger than similar concrete which is permitted to dry out. Concrete damp cured for 1 month will be approximately 100 percent stronger than similar concrete kept in dry air. Tests show that the strength of damp cured concrete is influenced by the length of time the concrete is kept damp; also that it hardens faster at higher temperatures. Concrete cured at 21°C (70°F) generally hardens more than twice as fast as concrete cured at a temperature slightly above freezing. At high curing temperatures, the concrete cures rapidly giving a higher than normal initial strength. However after approximately 30 days, the strength of concrete cured at 70°F (21°C) gradually exceeds the strength of that cured at higher temperatures.

Thorough moist curing aids in producing water tight concrete. As the cement paste in concrete hardens, additional solid matter is formed, which closes off the space between the cement particles through which water might otherwise seep. The more complete the hydration of the hardening process, the denser and more water tight becomes the cement paste.

Increase resistance to wear also results from proper curing, which emphasizes the importance of damp curing floors, pavements, and other surfaces subject to wear. Continuous damp curing, particularly in the early stages of hardening, helps to get a hard, dense surface and to prevent checking and dusting.

20. Common methods used in curing concrete:

Cover with wet burlap, canvas, sand or straw coverings as soon as it can be done without marring the surface. Keep the covering continuously wet by sprinkling. When a cover is not used, wetting should be started as soon as possible after finishing, and the surface should not be permitted to dry during the curing period. Floors, sidewalks, pavements, and other flat surfaces require careful attention as moisture is lost very rapidly by evaporation due to the relatively large exposed surface. Ponding (flooding) is a good method of curing flat surfaces. With this method the surface to be cured is surrounded by small earth dikes and then kept flooded with water.

Walls and other vertical surfaces can be protected by leaving the forms in place temporarily, or by hanging canvas or burlap over them. Such coverings are kept constantly moist by sprinkling. Curing should continue for at least 7 days, and for longer periods of time when it is practical to do so.

21. Ring Gear:

It is recommended that a light coating of grease be applied to the ring gear and driving sprocket every week to reduce wear.

22. Operating hints:

- a. Keep the working area as clean and dry as possible to prevent slipping and tripping.
- b. Provide sufficient space around the machine for adding material to the drum and removing the mixture.
- c. Always add the materials in the same ratio to give a uniform mixture for concrete.
- d. Provide sufficient time to thoroughly combine the mixture to a uniform consistency before discharging from the drum.
- e. The water requirements for the mixture can vary depending on moisture content of the aggregate. Vary the amount of water in the mixture to give the consistency of the concrete desired.



Fig. 11 RING GEAR / SPROCKET

4.8 TRANSPORTING



TRANSPORT SAFETY

1. Read and understand ALL the information in the Operator's Manual regarding procedures and SAFETY when operating the Mixer in the workplace and/or on the road.
2. Always travel at a safe speed. Use caution when making corners or on a rough surface.
3. Make sure all the lights and reflectors that are required by the local highway and transport authorities are in place, are clean and can be seen clearly by all overtaking and oncoming traffic.
4. Do not allow riders on any part of the machine during either road or highway travel.
5. Always use a safety chain between the mixer and the towing vehicle when transporting.
6. Use a mechanical retainer through the ball hitch or clevis pin before transporting.

Crown Construction Mixers are designed to be easily and conveniently moved from place to place.

When moving the machine, follow this procedure:

1. On the C-9C, extend the pole to its full length. To make the Mixer easier to move.
2. Secure with the lock pin and retainer.
3. Use 2 men to lift the hitch and pull the Mixer to the new location.

Note

Never transport the Mixer with Tow Pole in extended position, only transport in middle position.



Fig. 12 MOVING ~ By Hand with two people

4. Retract and lock the pole.
When transporting the machine, follow this procedure:

1. On the electric motor powered units, unplug the power cord.
2. On gas engine powered units, open the hood and close the fuel valve to prevent flooding the carburetor.

 **WARNING**
Machine is shown with engine hood open for illustrative purposes only. Never operate with hood open.



Fig. 13 FUEL SHUT OFF

3. Move the drum to its straight down position and lock.
4. Attach the optional lighting bar and secure.



Fig. 14 DRUM DOWN

5. On the larger models, extend the hitch pole to its middle position and secure with the lock pin and retainer. **Never transport in fully extended position.**
6. Securely attach the machine to the towing vehicle.
7. Use a mechanical retainer through the ball hitch or the pintle hitch.

IMPORTANT

Be sure the ball on the truck is the correct size for the hitch.
Do not use an undersized ball with the hitch.

8. Attach the safety chain to prevent unexpected separation. Cross the chains under the hitch for support.
9. Plug the wiring harness into the truck. Be sure all the lights are working.
10. Check that the wheel bolts are tightened to their specified torque.
11. Check that the tires are inflated to their required pressure.
12. Use special care when transporting during times of limited visibility. Be sure that you can be seen by oncoming and overtaking traffic. Always use the lighting bar.
13. Never exceed the speed appropriate for the terrain and conditions. Slow down for turns and when traveling over rough terrain.



Ball Hitch



Pintle Hitch

Fig. 15 ATTACHMENT



Draw Bar at Mid position for Towing

4.9 STORAGE



STORAGE SAFETY

1. Store unit in an area away from human activity.
2. Do not permit children to play on or around the stored Mixer.

At the end of the season or when the machine will not be used for a period, inspect all major components of the Mixer. Repair or replace any worn or damaged components to prevent any unnecessary down time at the start of next project. When preparing for storage, follow this procedure:

1. Drain the fuel from gas tank.
2. Turn the fuel supply valve OFF or unplug the power cord.
3. Close and secure the hood.
4. Thoroughly wash the machine using a water hose or pressure washer to remove all dirt, dust or residue.

IMPORTANT

Do not get water on the electric motor or gas engine. Use an air hose to clean the motor or engine.

5. Inspect the inside of the drum. Chip out or break loose any build-up.
6. Lubricate all the grease fittings.
7. Rotate the drum so it is pointing straight down or in its emptying position and lock in place.
8. Cover the machine with a tarpaulin and tie down if the machine is not stored inside.



Fig. 16 STORED

5 SERVICE AND MAINTENANCE



MAINTENANCE SAFETY

1. Review the Operator's Manual and all safety items before working with, maintaining or operating the Mixer.
2. Stop engine or motor, disconnect spark plug wire or unplug power cord, and wait for all moving parts to stop before servicing, adjusting, repairing, or cleaning.
3. Follow good shop practices:
Keep service area clean and dry. Be sure electrical outlets and tools are properly grounded. Use adequate light for the job at hand.
4. Keep hands, feet, clothing and hair away from all moving and/or rotating parts.
5. Do not place hands in the drum unless the engine is off and the spark plug wire is disconnected or the power cord is unplugged.
6. Do not attempt any adjustment or maintenance to any system of the Mixer unless the power source is disabled.
7. Make sure that all guards, shields and hoods are properly installed and secured before operating the Mixer.
8. Securely support the machine using blocks or safety stands before working beneath it or changing tires.
9. Store and transfer gasoline, solvents, cleaners or any flammable liquids only in safety standard approved containers.

5.1 SERVICE

5.1.1 FLUIDS AND LUBRICANTS

1. Grease
Use an SAE multi-purpose high temperature grease or a multi-purpose lithium base grease.
2. Gasoline
Use a standard unleaded gasoline for all operating conditions. Do not use gasoline with an ethanol blend.

Capacities:

5.5 Honda: 0.95 US Gal (3.6 Lts, 0.79 Imp Gal)

9.0 Honda : 1.59 US Gal (6.0 Lts, 1.32 Imp Gal)

3. Engine oil:

Use an SAE 10W30 multi-viscosity oil meeting the American Petroleum Institute (API) classification of SF or SG for normal operating temperatures. Consult the engine manual for unusual operating conditions. Do not mix oil types or viscosities.

Crankcase Capacity:

5.5 hp: 0.53 US Qts (0.5 Lts, 0.44 ImpQts)

9.0 hp: 1.16 US Qts (1.1 Lts, 1.94 ImpQts)

4. Storing Lubricants and Fluids

Your machine can operate at top efficiency only if clean lubricants are used. Use clean containers to handle all fluids. Store them in an area protected from dust, moisture and other contaminants.

5.1.2 GREASING

Refer to section 5.1.1 for recommended grease. Use the Maintenance Checklist provided to keep a record of all scheduled maintenance.

1. Use only a hand-held grease gun for all greasing. An air-powered greasing system can damage the seals on bearings and lead to early failures.
2. Wipe grease fitting with a clean cloth before greasing to avoid injecting dirt and grit.
3. Replace and repair broken fittings immediately.
4. If fittings will not take grease, remove and clean thoroughly. Also clean lubricant passage. Replace fitting if necessary.

5.1.3 SERVICING INTERVALS

Daily or 8 Hours

1. Check engine fluid levels. Top as required.
 - a. Check engine oil level. Top up as required.
 - b. Check fuel level. Add as required.



2. Check the drive belt tension.

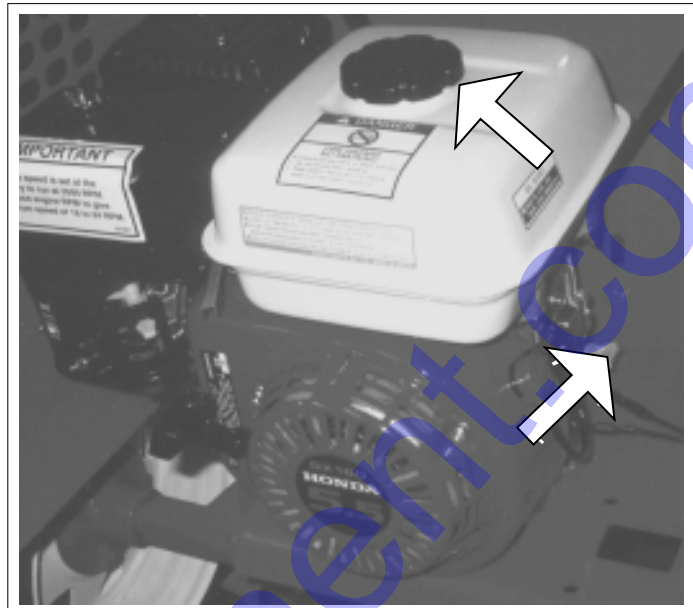
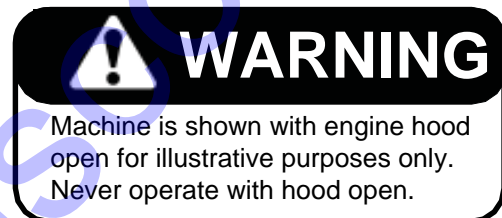

Gas Engine (Typical)

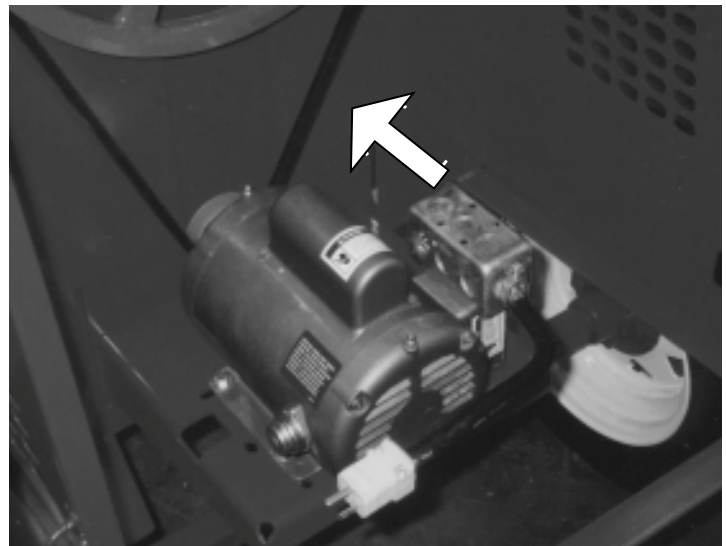

Electric Motor

Fig. 18 DRIVE BELT TENSION

Daily or 8 Hours

3. Grease the drum assembly bearings.

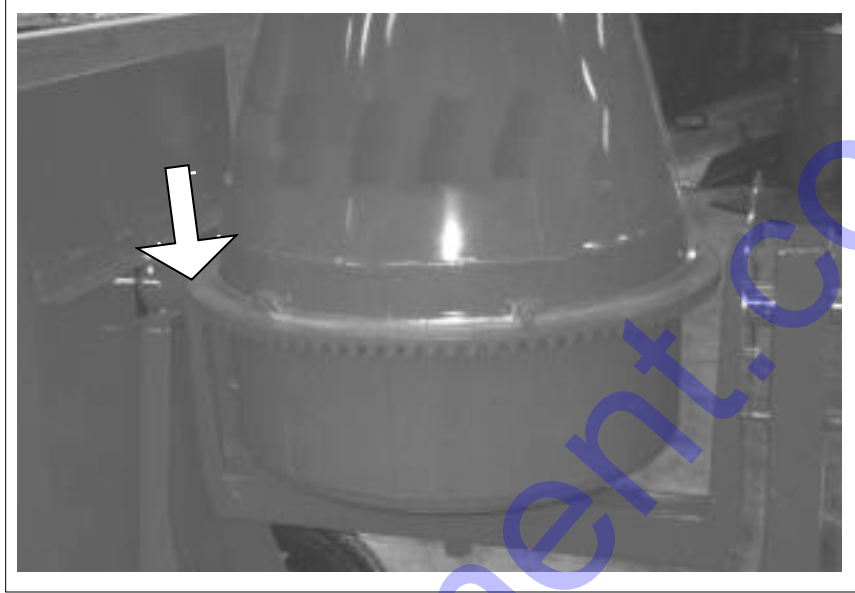

Fig. 19 DRUM ASSEMBLY BEARINGS

4. Grease the tilt lock assembly shaft on the Models with a tilt wheel (1 location).
5. On C9-C Models only, grease the lower bowl bearing. (whereshown)

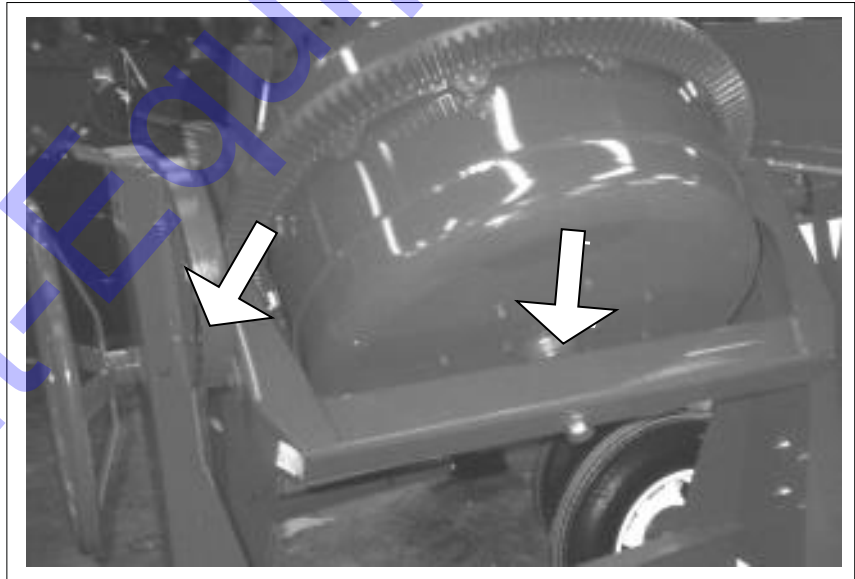

Fig. 20 TILT LOCK SHAFT & BOWL BEARING

6. Use an air hose to blow out and clean the engine, motor and compartment.

 **WARNING**

Machine is shown with engine hood open for illustrative purposes only. Never operate with hood open.



Gas Engine (Typical)

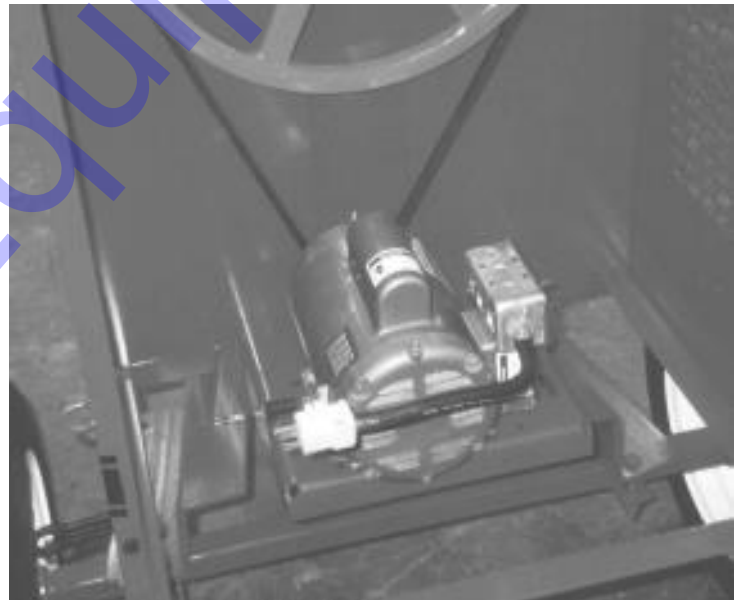

Electric Motor

Fig. 21 DRIVE COMPARTMENT

Weekly or 50 Hours

1. Change the engine oil.

IMPORTANT

Change more frequently if operating in high ambient temperatures or in very dusty or dirty conditions.

- a. Drain plug.
- b. Fill plug.



WARNING

Machine is shown with engine hood open for illustrative purposes only. Never operate with hood open.



5.5 HP



9.0 HP

Fig. 22 ENGINE OIL

- Clean the engine air intake filter.

! WARNING
Machine is shown with engine hood open for illustrative purposes only. Never operate with hood open.



Fig. 23 ENGINE AIR INTAKE FILTER (TYPICAL)

- Grease the ring gear and pinion, this will reduce pinion wear, (a).

Grease pinion bearings, (b).

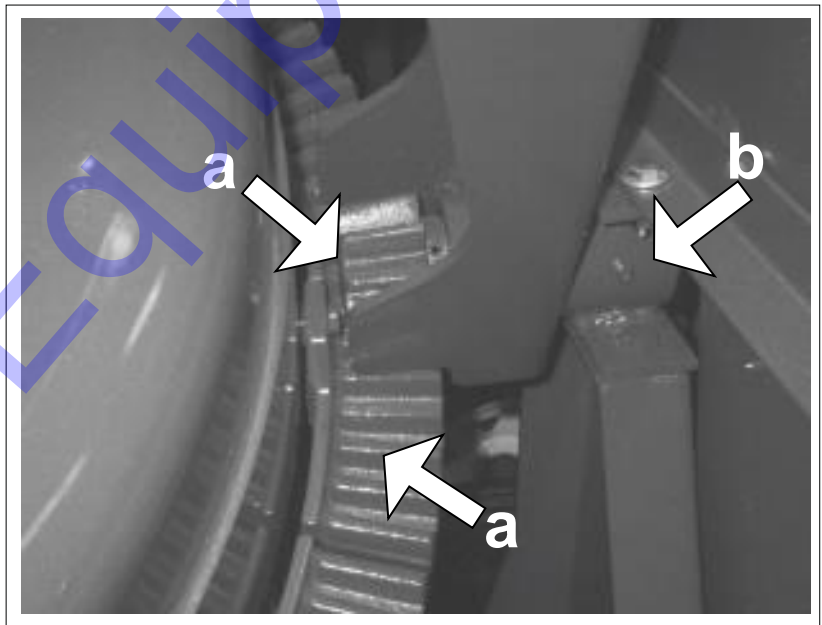

Fig. 24 RING GEAR / SPROCKET

Annually or 400 Hours

1. Grease the electric motor bearings with 1/2 shot of grease (2 locations).

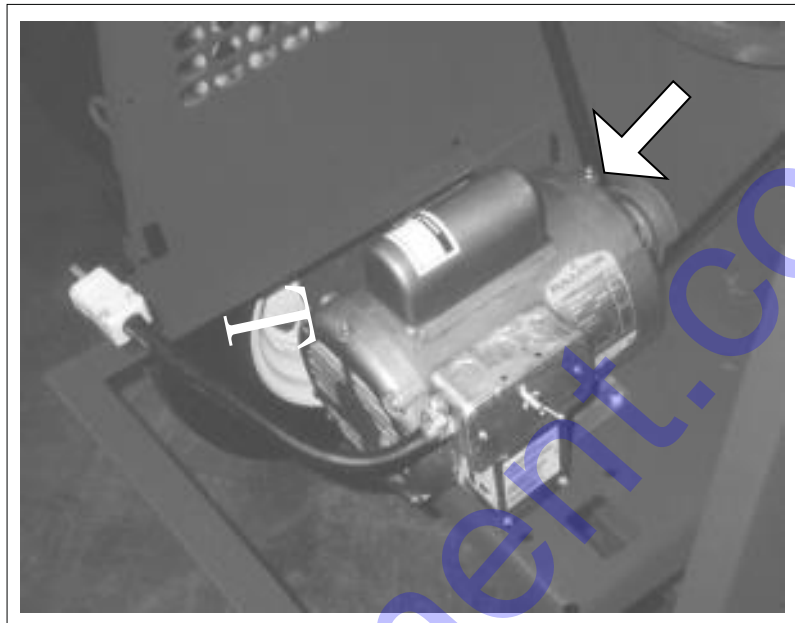

Fig. 25 ELECTRIC MOTOR

2. Repack wheel bearings on the Mixer (2 locations).



Fig. 26 WHEELS

5.1.4 SERVICE RECORD

See Lubrication and Maintenance sections for details of service. Copy this page to continue record.

ACTION CODE: § CHECK C CHANGE CL CLEAN
 L LUBRICATE RE REMOVE R REPACK

MAINTENANCE	HCURS												
	SEVICED BY												
DAILY OR 8 HOURS													
§ Engine Fluid Levels													
§ Engine Oil Level & Fuel Level													
§ Drive Belt Tension													
L Drum Assembly Bearings (2)													
L Tilt Lock Assembly Shaft C-9C (1)													
CL Engine, Motor & Compartment													
WEEKLY OR 50 HOURS													
C Engine Oil, Drain Plug & Fill Plug													
CL Engine Air Intake Filter													
L Ring Gear / Sprocket													
ANNUALLY OR 400 HOURS													
L Electric Motor Bearings (2)													
R Wheel Bearings (2)													

5.2 MAINTENANCE

By following a careful service and maintenance program for your machine, you will enjoy many years of trouble-free service.

5.2.1 ENGINE OIL CHANGING

1. Review the Operator's Manual for the engine.
2. Allow the engine to cool before changing oil. Hot oil can cause burns if it contacts exposed skin. Draining works best if the oil is warm.
3. Be sure the ignition switch is off and fuel valve is turned off.
4. Place a pan under the drain plug.
5. Remove the drain plug and allow oil to drain for 10 minutes.
6. Install the engine drain plug and tighten.
7. Dispose of the oil in an approved container.
8. Add the specified type and amount of motor oil. Refer to Section 5.1.1 or the engine manual.
9. Run the engine for 1 minute and check for leaks.
10. If leaks are found around the drain plug, tighten slightly and repeat Step 9.
11. Check engine oil level. Top up as required.

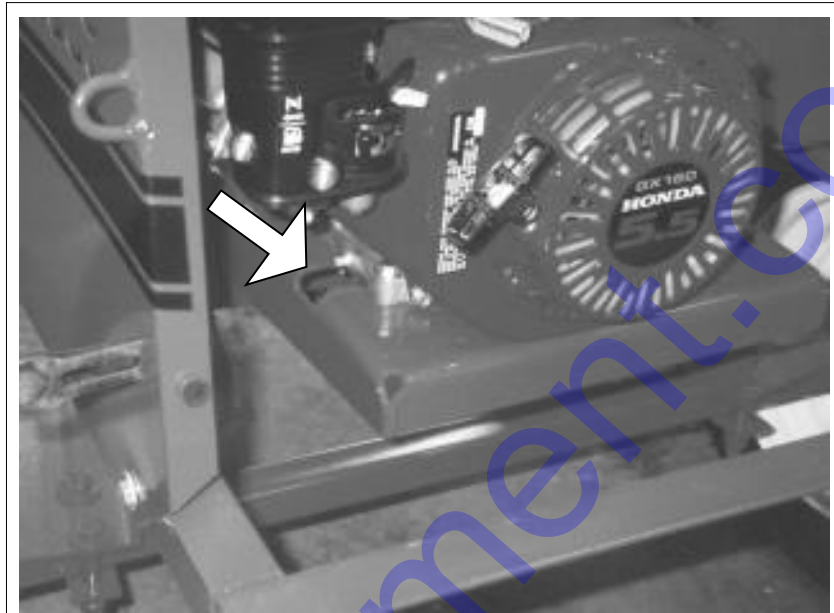

5.5 HP



9.0 HP

Fig. 27 ENGINE OIL DRAIN PLUG



WARNING

Machine is shown with engine hood open for illustrative purposes only. Never operate with hood open.

5.2.2 ENGINE SPEED SETTING

Every engine is shipped from the engine factory without gas or oil because of fire hazards during shipping. They are all set with a high idle of 3500 RPM. Since no fluids are added at the Mixer factory, the RPM is not reset. When the Mixer is delivered, the fluids must be added and the RPM reset. To reset the RPM, follow this procedure:

1. Read the engine manual supplied with the machine.
2. Add fuel and the specified motor oil to the crankcase.
3. Start the engine and run at wide open throttle.
4. Use a screwdriver to reset the high idle stop screw.

NOTE

It may be helpful to remove air cleaner cover to provide access to screw.

5. Use the drum revolutions to determine engine RPM setting. Set the engine RPM to give a drum rotation speed of 18-20 RPM when the drum is loaded.
6. Reset if the speed changes as required.

WARNING

Machine is shown with engine hood open for illustrative purposes only. Never operate with hood open.

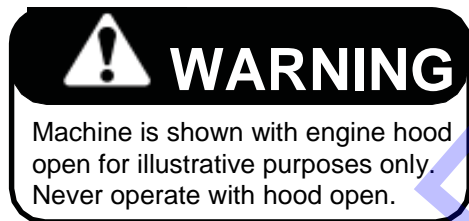

Fig. 28 ENGINE SPEED SETTING (TYPICAL)

5.2.3 AIR CLEANER MAINTENANCE

Each engine is equipped with filter to remove dust and dirt from entering the air intake. To clean the filter, follow this procedure:

1. Read the engine manual supplied with the machine.
2. Unlatch and open the hood.
3. Remove the filter cover.
4. Remove filter and shake out.
5. Wash in a filter cleaning detergent if heavily caked with dirt. Allow time to dry before re-installing.
6. Replace filter after washing 5 times.
7. Install clean filter and secure cover.



5.5 HP



9.0 HP

Fig. 29 AIR CLEANER (TYPICAL)

5.2.4 BELT TENSION AND ALIGNMENT

A drive belt and pulley system transmits power from the motor or engine to the pinion gear for rotating the drum. The tension must be maintained to prevent slipping and the pulleys aligned to prevent belt wear. To set the tension and alignment, follow this procedure:

1. Unlatch and open hood.
2. Disable power source by unplugging power cord or disconnecting spark plug wire.
3. Loosen motor or engine mounting platform bolts (from back side).
4. Slide or tap platform down to tighten belt.
5. The belt is properly tensioned when the mid-span deflects 1/4 inch (6 mm) when pushed on with a 10 lb force.
6. Tighten platform mounting bolts to their specified torque.
7. Align the pulleys by loosening the motor or engine mounting bolts.
8. Slide or tap the power unit into position to align the pulleys.
9. Tighten power unit mounting bolts to their specified torque.
10. Close and secure the hood.

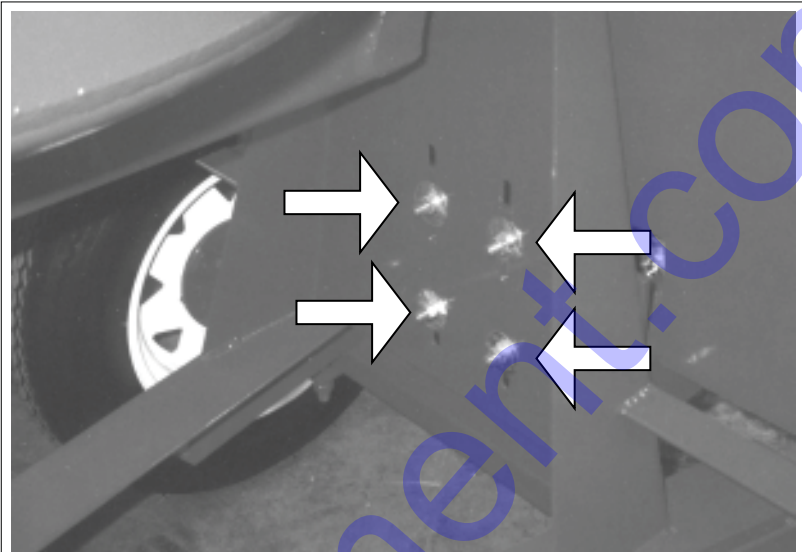

Back Mounting Platform (Typical)

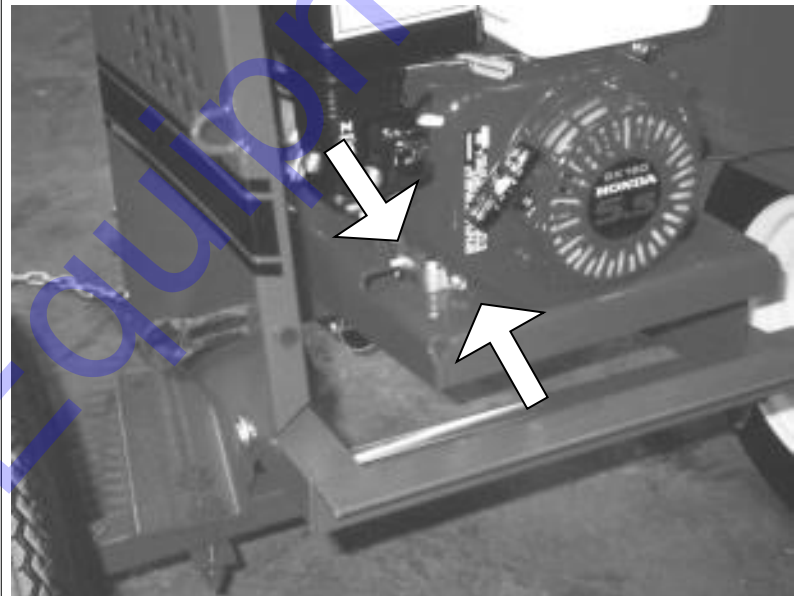

Mounting Bolts

Fig. 30 BELT TENSION AND ALIGNMENT



WARNING

Machine is shown with engine hood open for illustrative purposes only. Never operate with hood open.

5.2.5 PADDLE REPLACEMENT

Each machine is equipped with 3 equally spaced paddles on the inside of the drum. After extended use, they will wear. To replace paddles, follow this procedure:

1. Open hood and disable power source by unplugging power cord or removing spark plug wire.
2. Remove paddle mounting bolts.
3. Remove old paddles and install new ones.
4. Install mounting bolts and tighten to their specified torque.



Plastic Drum

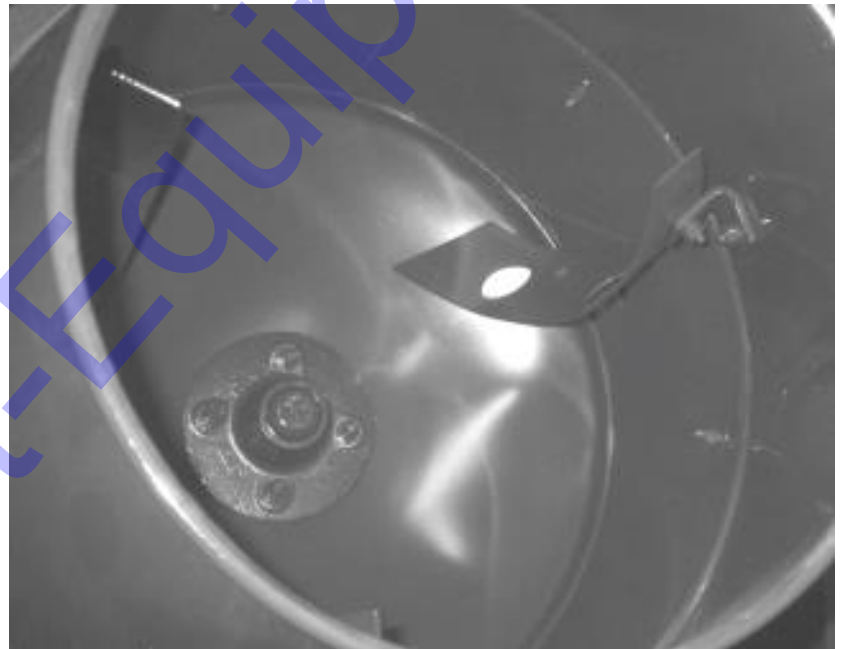

Steel Drum

Fig. 31 PADDLES

6 TROUBLE SHOOTING

The Crown Construction Concrete Mixer uses a large heavy-duty rotating drum with paddles for combining water, cement and aggregate in a mixture for forming concrete. It is a well engineered machine that requires minimum maintenance.

In the following trouble shooting section, we have listed many of the problems, causes and solutions to the problems which you may encounter.

If you encounter a problem that is difficult to solve, even after having read through this trouble shooting section, please contact your authorized dealer, distributor or the factory. Before you call, please have this Operator's Manual and the serial number from your machine ready.

PROBLEM	CAUSE	SOLUTION
Engine won't start.	No fuel.	Fill the fuel tank.
	Low engine oil.	Fill the crankcase with oil.
	Cold engine.	Open choke.
	Ignition switch off.	Turn ignition switch on.
	Emergency Stop switch off.	Pull Emergency Stop switch out.
	Engine problem.	Refer to engine manual.
Motor won't run.	Power off.	Turn power on at master panel. Trip breaker at master panel. Turn switch on at motor.
	Overload switch tripped.	Reset overload switch on motor.
	Drum won't turn.	No power.
Drum won't turn.	Loose drive belt.	Tighten drive belt.
	Belt off pulleys.	Install belt and align pulleys.

7 SPECIFICATIONS

7.1 MECHANICAL

Model	C3C Discontinued	C6C	C6P	C9C	C12C
R.P.M. Max:	29	29	29	29	29
Drum Diameter:	24"	24"	24"	32"	32"
Drum Height:	27"	31"	31"	32"	40"
Opening Diameter:	17"	17"	17"	19"	19"
Bottom Thickness:	10 USG	10 USG	1/4"	10 USG	10 USG
Bowl Thickness:	10 USG	10 USG	1/4"	10 USG	10 USG
Neck Thickness:	10 USG	10 USG	N/A	10 USG	10 USG
Overall Height Drum Up):	60"	64"	64"	69"	77-1/2"
Overall Height (Drum Down):	57"	57"	57"	69"	74-1/2"
Width:	46"	46"	46"	51-1/2"	51-1/2"
Length:	72"	72"	72"	82-1/2"	82-1/2"
Capacity Bags:	1/2	1/2 to 1	1/2 to 1	1 plus	2
Capacity Cubic Feet:	3 1/2	6	6	9	12
Mixing Blades:	3	3	3	4	4
Tires (Pneumatic):	4.00 x 8	4.00 x 8	5.50 x 12	6.00 x 12	6.50 X 13

ELECTRIC POWER

HP	1/2 Hp	1 Hp	1.5 Hp	1.5 Hp	2 Hp
Volts	110/220	110/220	110/220	230/460	110/220
Phase	1	1	1	3	1
Amps	8.4/4.2	12.4/6.2	18.0/9.0	4.8/2.4	20.4/10.2

ELECTRIC POWER

HP	2 Hp	3 Hp	3 Hp	5 Hp	5Hp
Volts	230/460	220	230/460	220	230/460
Phase	3	1	3	1	3
Amps	6.4/3.2	16	8.6/4.3	23	14.0/7.0

SPECIFICATIONS SUBJECT TO CHANGE WITHOUT NOTICE

7.2 BOLT TORQUE

CHECKING BOLT TORQUE

The tables shown below give correct torque values for various bolts and capscrews. Tighten all bolts to the torques specified in chart unless otherwise noted. Check tightness of bolts periodically, using bolt torque chart as a guide. Replace hardware with the same strength bolt.

Imperial Torque Specifications

Bolt Dia. "A"	Bolt Torque*					
	SAE 2		SAE 5		SAE 8	
	Nm	Ft-Lbs	Nm	Ft-Lbs	Nm	Ft-Lbs
1/4	8	6	12	9	17	12
5/16	13	10	25	19	36	27
3/8	27	20	45	33	63	45
7/16	41	30	72	53	100	75
1/2	61	45	110	80	155	115
9/16	95	60	155	115	220	165
5/8	128	95	215	160	305	220
3/4	225	165	390	290	540	400
7/8	230	170	570	420	880	650
1	345	225	850	630	1320	970

Metric Torque Specifications

Bolt Dia. "A"	Bolt Torque*			
	8.8		10.9	
	Nm	Ft-Lbs	Nm	Ft-Lbs
M4	3	2.2	4.5	3.3
M5	6	4	9	7
M6	10	7	15	11
M8	25	18	35	26
M10	50	37	70	52
M12	90	66	125	92
M14	140	103	200	148
M16	225	166	310	229
M20	435	321	610	450
M24	750	553	1050	774



Torque figures indicated above are valid for non-greased or non-oiled threads and heads unless otherwise specified. Therefore, do not grease or oil bolts or capscrews unless otherwise specified in this manual. When using locking elements, increase torque values by 5%.

WHEEL LUG NUT TORQUE:

Use the tightening pattern shown below, to ensure the even tightening of the lug nuts on each wheel.

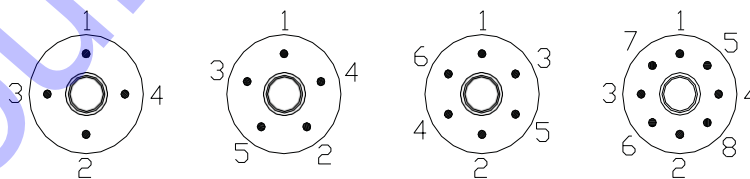

Bolt Dia	Bolt Torque	
	Nm	Ft-Lbs
1/2"	136	100
9/16"	203	150

* Torque value for bolts and capscrews are identified by their head markings.

8 INDEX

I	PAGE
Introduction	1

O	
Operation	11
Controls	15
How The Machine Works.....	12
Machine Break-In.....	14
Operating	18
Pre-Operation Checklist.....	13
Pre-Start Procedures	13
Storage	30
To The New Operator or Owner	11
Transporting	27

P	
Proposition 65	ii

R	
Reporting Safety Defects.....	i

S	PAGE
Safety	2
General Safety	3
Electrical Safety.....	6
Maintenance Safety	5
Operating Safety	4
Refueling Safety	6
Safety Signs	6
Sign-Off Form.....	7
Storage Safety	5
Tire Safety.....	5
Transport Safety.....	5
Safety Sign Locations	8
Service and Maintenance	31
Maintenance	39
Air Cleaner Maintenance	41
Belt Tension and Alignment.....	42
Engine Oil Changing	39
Engine Speed Setting.....	40
Paddle Replacement	43
Service	31
Fluids and Lubricants	31
Greasing.....	31
Service Record	38
Servicing Intervals	32
Specifications	45
Bolt Torque	46
Mechanical	45

T	
Trouble Shooting	44

SERIAL NUMBER LOCATION

Always give your dealer, distributor or factory the serial number of your Concrete Mixer when ordering parts or requesting service or other information.

The serial number plate is located where indicated and stamped into the frame. Please mark the number in the space provided for easy reference.

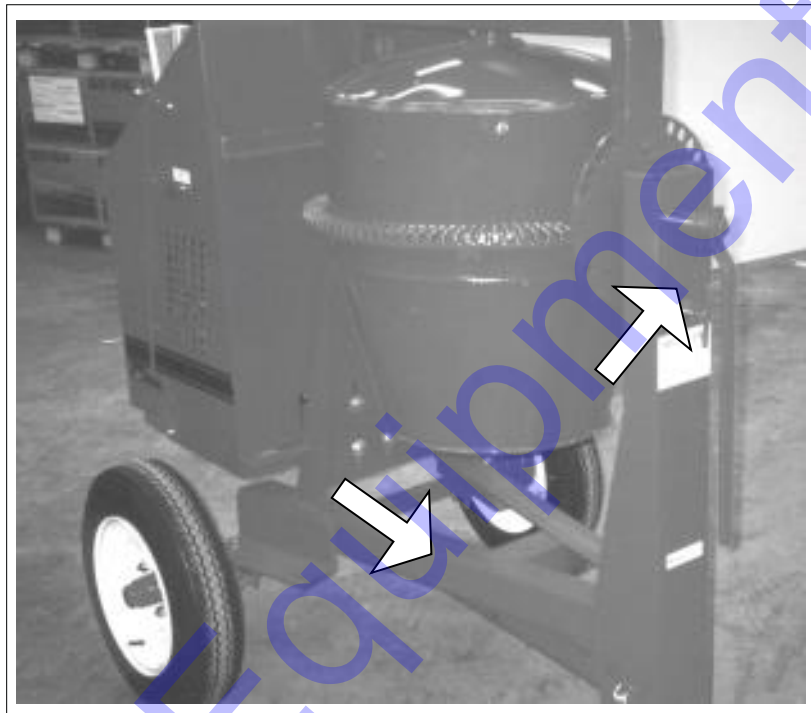

SERIAL NUMBER LOCATIONS

Model _____

Serial Number _____

Discount Equipment

Discount-Equipment.com is your online resource for commercial and industrial quality parts and equipment sales.

Locations:

Florida (West Palm Beach): [561-964-4949](tel:561-964-4949)

Outside Florida TOLL FREE: [877-690-3101](tel:877-690-3101)

Need parts? Check out our website at www.discount-equipment.com

Can't find what you need?

Click on this link: <http://www.discount-equipment.com/category/5443-parts/> and fill out the request form.

Please have the machine model and serial number available in order to help us get you the correct parts. One of our experienced staff members will get back to you with a quote for the right part that your machine needs.

We sell worldwide for the brands: Genie, Terex, JLG, MultiQuip, Mayco, Toro/Stone, Diamond Products, Magnum, Airman, Mustang, Power Blanket, Nifty Lift, Atlas Copco, Chicago Pneumatic, Allmand Brothers, Essick, Miller Spreader, Skyjack, Lull, Skytrak, Tsurumi, Husquvarna/Target, Whiteman-Concrete/Mortar, Stow-Concrete/Mortar, Baldor, Wacker, Sakai, Snorkel, Upright, Mi-T-M, Sullair, Neal, Basic, Dynapac, MBW, Weber, Bartell, Bennar Newman, Haulotte, Ditch Runner, Blaw-Knox, Himoina, Best, Buddy, Crown, Edco, Wyco, Bomag, Laymor, Terremite, Barreto, EZ Trench, Takeuchi, Basic, Bil-Jax, Curtis, Gehl, Heli, Honda, ICS/PowerGrit, Puckett, Waldon, ASV, IHI, Partner, Imer, Clipper, MMD, Koshin, Rice, Gorman Rupp, CH&E, Cat Pumps, Comet, General Pump, Giant, AMida, Coleman, NAC, Gradall, Square Shooter, Kent, Stanley, Tamco, Toku, Hatz, Kohler, Robin, Wisconsin, Northrock, Oztec, Toker TK, Rol-Air, Small Line, Wanco, Yanmar

New Equipment - Used Equipment - Rental Equipment - Parts and Accessories

Discount Equipment

www.discount-equipment.com

561-964-4949

Parts: wbparts@Discount-Equipment.com

Sales: info@Discount-Equipment.com