



OPERATOR MANUAL

MODELS: 655PM, 755PM & 855PM



CHAMPION® PLASTER MORTAR MIXER

A 100% employee-owned American manufacturer

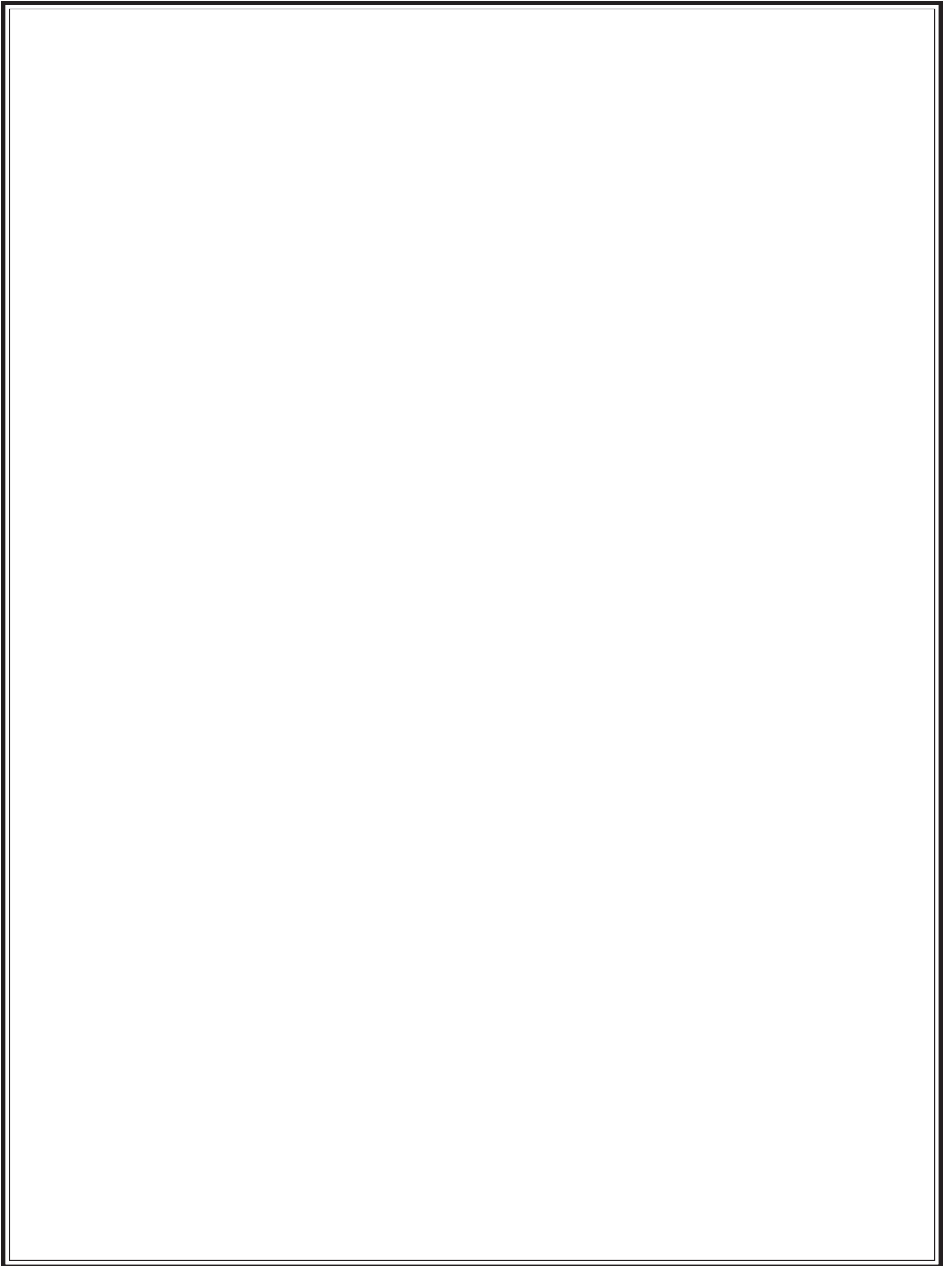

Table of Contents

655PM, 755PM, 855PM

TABLE OF CONTENTS	3
FOREWORD	4
LIMITED WARRANTY	5
TECHNICAL DATA	6-9
Machine Specifications	6
Hardware Identification	7
Torque Chart - Imperial	8
Torque Chart - Metric	9
HEALTH & SAFETY	10-13
Safety Training	10
Safety Precautions	11-13
INTRODUCTION	14-16
Intro	14
Operating Principle	14
Delivery Checks	14
Before Starting	14
Determining the Right Machine	14
Standard Features	15
Preparation for Service	15
Hardware	16
Fuel	16
Location and Use of Controls	16
OPERATIONS	17-18
To Start	17
To Stop	17
Initial Operation	18
MAINTENANCE	19-20
Maintenance and Lubrication	19
Cleaning	20
CALIFORNIA PROPOSITION 65	IBC

User Information

Foreword

These instructions include:

- Safety regulations
- Operating instructions
- Maintenance instructions

These instructions have been prepared for operation on the construction site and for the maintenance engineer.

These instructions are intended to simplify operation of the machine and to avoid malfunctions through improper operation.

Observing the maintenance instructions will increase the reliability and service life of the machine when used on the construction site and reduce repair costs and down-times.

Always keep these instructions at the place of use of the machine.

Only operate the machine as instructed and follow these instructions.

Observe the safety regulations as well as the guidelines of the civil engineering trade association. Observe safety rules for the operation of equipment and the pertinent regulations for the prevention of accidents.

Stone Construction Equipment, Inc. is not liable for the function of the machine when used in an improper manner and for other than the intended purpose.

Operating errors, improper maintenance and the use of incorrect operating materials are not covered by the warranty.

The above information does not extend the warranty and liability conditions of business of Stone Construction Equipment, Inc.

1. Machine Type: _____

Machine S/N: _____

2. Engine Type: _____

Engine S/N: _____

3. VIN: _____

4. Purchase Date: _____

5. Dealer/Distributor Information:

Name: _____

Address: _____

Phone #: _____

Fax #: _____

6. Battery
Manufacturer: _____

Battery Type: _____

Battery S/N: _____

Location of above information:

1. Information on S/N tag.
2. Information on engine tag.
3. Information on S/N tag - if applicable.
4. Date you purchased machine.
5. Dealer machine was purchased from.
6. Information on battery and battery warranty card.

Stone Construction Equipment, Inc.
P.O. Box 150, Honeoye, New York 14471
Phone: (800) 888-9926
Fax: (716) 229-2363

Limited Warranty

The Manufacturer warrants that products manufactured shall be free from defects in material and workmanship that develop under normal use for a period of 90 days for concrete vibrators and electric pumps, one year for Rhino®, Bulldog®, WolfPac Rollers™, trowels, Stompers®, saws, forward plates, engine powered pumps, Lift Jockey™, Mortar Buggy™ and 6 months for all other products from the date of shipment. The foregoing shall be the exclusive remedy of the buyer and the exclusive liability of the Manufacturer. Our warranty excludes normal replaceable wear items, i.e. gaskets, wear plates, seals, O-rings, V-belts, drive chains, clutches, etc. Any equipment, part or product which is furnished by the Manufacturer but manufactured by another, bears only the warranty given by such other manufacturer. (The Manufacturer extends the warranty period to "Lifetime" for the drum bearings and seals for the mortar mixers, and agrees to furnish, free of charge, the bearings and seals only upon receipt of the defective parts. The warranty is two years for eccentric bearings on the forward plate compactors, mortar and plaster mixer drums, trowel gearboxes and five years on the Bulldog trench roller eccentric bearings.) A Warranty Evaluation Form must accompany all defective parts. Warranty is voided by product abuse, alterations, and use of equipment in applications for which it was not intended, use of non-manufacturer parts, or failure to follow documented service instructions. The foregoing warranty is exclusive of all other warranties whether written or oral, expressed or implied. No warranty of merchantability or fitness for a particular purpose shall apply. The agents, dealer and employees of Manufacturer are not authorized to make modification to this warranty, or additional warranties binding on Manufacturer. Therefore, additional statements, whether oral or written, do not constitute warranty and should not be relied upon.

The Manufacturer's sole responsibility for any breach of the foregoing provision of this contract, with respect to any product or part not conforming to the Warranty or the description herein contained, is at its option (a) to repair, replace or refund such product or parts upon the prepaid return thereof to location designated specifically by the Manufacturer. Product returns not shipped prepaid or on an economical transportation basis will be refused (b) as an alternative to the foregoing modes of settlement - the Manufacturer's dealer to repair defective units with reimbursement for expenses, except labor, and be reviewed with the Manufacturer prior to repair. A Warranty Evaluation Form must accompany all warranty claims.

Except as set forth hereinabove and without limitation of the above, there are no warranties or other affirmations which extends beyond the description of the products and the fact hereof, or as to operational efficiency, product reliability or maintainability or compatibility with products furnished by others. In no event whether as a result of breach of contract or warranty or alleged negligence, shall the Manufacturer be liable for special or consequential damages including but not limited to: Loss of profits or revenues, loss of use of the product or any associated product, cost of capital, cost of substitute products, facilities or services or claims of customers.

No claim will be allowed for products lost or damaged in transit. Such claims should be filed with the carrier within fifteen days.

Effective July 2002.

Stone Construction Equipment, Inc. • 8662 Main Street, P.O. Box 150 • Honeoye, NY 14471-0150
Phone: 1-800-888-9926 • 1-585-229-5141 Fax: 1-585-229-2363
www.stone-equip.com • e-mail: sceny@mcimail.com

Technical Data

655PM, 755PM, 855PM – Specifications

MODEL	655PM	755PM	855PM
Origin	U.S.A.	U.S.A.	U.S.A.
Dimensions Operating Wt. lbs/Kg	550 / 250	565 / 257	605 / 275
Batch Capacity (Bags)	1 1/2 - 2 bags	2 - 2 1/2 bags	2 1/2 - 3 bags
Batch Capacity cu. ft. / cu. m.	6 / .17	7 / .20	8 / .23
Total Volume cu. ft. / cu. m.	6.9 / .20	8.1 / .23	9.0 / .25
L x W x H in. / cm	64 x 34 x 54 / 163 x 86 x 137	68 x 34 x 54 / 173 x 86 x 137	76 x 34 x 54 / 193 x 86 x 137
Operating System Engine	5 hp B&S / 3.7 kw 5.5 hp Honda / 4.10 kw 6 hp Robin / 4.5 kw 8 hp B&S / 6.0 kw 8 hp B&S I/P / 6.0 kw 8.5 hp Robin / 6.3 kw 8 hp B&S / 6.0 kw 8 hp Honda / 6.0 kw 1 1/2 hp / 1.1 kw Electric	6 hp Robin / 4.5 kw 8 hp B&S / 6.0 kw 8 hp B&S I/P / 6.0 kw 8.5 hp Robin / 6.3 kw 8 hp B&S / 6.0 kw 8 hp Honda / 6.0 kw 1 1/2 hp / 1.1 kw Electric	8 hp B&S / 6.0 kw 8 hp B&S I/P / 6.0 kw 8.5 hp Robin / 6.3 kw 8 hp B&S / 6.0 kw 8 hp Honda / 6.0 kw 10 hp B&S I/C / 7.5 kw 2 hp / 1.5 kw Electric 3 hp / 2.2 kw Electric
Drive & Clutch	V-Belt to Gears Front Post Hand Clutch	V-Belt to Gears Front Post Hand Clutch	V-Belt to Gears Front Post Hand Clutch
Standard Features Drum Wrap in. / mm	11 ga. .120 / 3.05	11 ga. .120 / 3.05	11 ga. .120 / 3.05
Drum End in. / mm	7 ga. .179 / 4.55	7 ga. .179 / 4.55	7 ga. .179 / 4.55
Pour Lip in. / mm	7 ga. .179 / 4.55	7 ga. .179 / 4.55	7 ga. .179 / 4.55
Drum Lock in. / mm	automatic (patented)	automatic (patented)	automatic (patented)
Paddles: Number	4	4	4
Mixing Action	Simple figure 8	Simple figure 8	Simple figure 8
Paddle Shaft	1 1/2" / 38.1 mm round	1 1/2" / 38.1 mm round	1 1/2" / 38.1 mm round
Frame/Axle: Tow Pole	Post Gussett, pintle, pin or ball hitch	Post Gussett, pintle, pin or ball hitch	Post Gussett, pintle, pin or ball hitch
Axle - extendible	34" - 46" / 86 - 117 cm	34" - 46" / 86 - 117 cm	34" - 46" / 86 - 117 cm
Tires	4.8 x 12 (high speed)	4.80 x 12 (high speed)	B78 x 13 (high speed)
Cowl:	16 galv., stainless steel hinge, diamond shaped expanded steel vent panels	16 galv., stainless steel hinge, diamond shaped expanded steel vent. panels	16 galv., stainless steel hinge, diamond shaped expanded steel vent. panels
Other Features: Bag Splitter	standard	standard	standard
Safety Guard	lift away, heavy-duty	lift away, heavy-duty	lift away, heavy-duty
Guard Lifter	standard (patented)	standard (patented)	standard (patented)
Safety Chain	standard	standard	standard
Warranty: Warranty Machine	6 months	6 months	6 months
Warranty Drum Bearing	lifetime on patented quadruple bearings and seals	lifetime on patented quadruple bearings and seals	lifetime on patented quadruple bearings and seals
Drum Warranty	2 years	2 years	2 years
Options:	spiral blades	spiral blades 13 in. / 33 cm tire spring axle	spiral blades plastic drums spring axle

Technical Data

Hardware

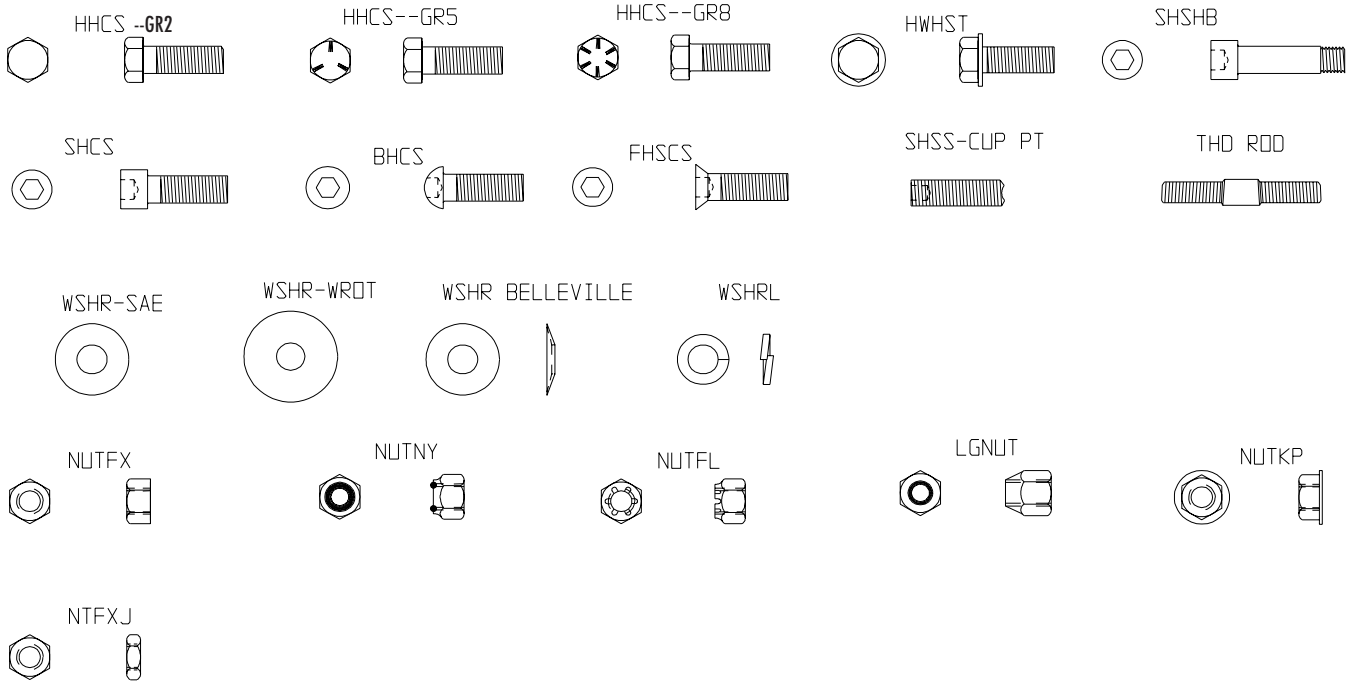

Technical Data

Torque Chart - Imperial

SAE GRADE 5 Coarse Thread

SIZE	PLATED	
1/4 - 20 (.250)	6 ft. lbs.	8 Nm
5/16 - 18 (.3125)	13 ft. lbs.	18 Nm
3/8 - 16 (.375)	23 ft. lbs.	31 Nm
7/16 - 14 (.4375)	37 ft. lbs.	50 Nm
1/2 - 13 (.500)	57 ft. lbs.	77 Nm
9/16 - 12 (.5625)	82 ft. lbs.	111 Nm
5/8 - 11 (.625)	112 ft. lbs.	152 Nm
3/4 - 10 (.750)	200 ft. lbs.	271 Nm
7/8 - 9 (.875)	322 ft. lbs.	436.5 Nm
1 - 8 (1.000)	483 ft. lbs.	655 Nm

SAE GRADE 5 Fine Thread

SIZE	PLATED	
1/4 - 28 (.250)	7 ft. lbs.	10Nm
5/16 - 24 (.3125)	14 ft. lbs.	19 Nm
3/8 - 24 (.375)	26 ft. lbs.	35 Nm
7/16 - 20 (.4375)	41 ft. lbs.	56 Nm
1/2 - 20 (.500)	64 ft. lbs.	87 Nm
9/16 - 18 (.5625)	91 ft. lbs.	123 Nm
5/8 - 18 (.625)	128 ft. lbs.	173 Nm
3/4 - 16 (.750)	223 ft. lbs.	302 Nm
7/8 - 14 (.875)	355 ft. lbs.	481 Nm
1 - 12 (1.000)	529 ft. lbs.	717 Nm
1 - 14 (1.000)	541 ft. lbs.	733 Nm

SAE GRADE 8 Coarse Thread

SIZE	PLATED	
1/4 - 20 (.250)	9 ft. lbs.	12 Nm
5/16 - 18 (.3125)	18 ft. lbs.	24 Nm
3/8 - 16 (.375)	33 ft. lbs.	45 Nm
7/16 - 14 (.4375)	52 ft. lbs.	70 Nm
1/2 - 13 (.500)	80 ft. lbs.	108 Nm
9/16 - 12 (.5625)	115 ft. lbs.	156 Nm
5/8 - 11 (.625)	159 ft. lbs.	215 Nm
3/4 - 10 (.750)	282 ft. lbs.	382 Nm
7/8 - 9 (.875)	454 ft. lbs.	615 Nm
1 - 8 (1.000)	682 ft. lbs.	925 Nm

SAE GRADE 8 Fine Thread

SIZE	PLATED	
1/4 - 28 (.250)	10 ft. lbs.	14Nm
5/16 - 24 (.3125)	20 ft. lbs.	27 Nm
3/8 - 24 (.375)	37 ft. lbs.	50 Nm
7/16 - 20 (.4375)	58 ft. lbs.	79 Nm
1/2 - 20 (.500)	90 ft. lbs.	122 Nm
9/16 - 18 (.5625)	129 ft. lbs.	175 Nm
5/8 - 18 (.625)	180 ft. lbs.	244 Nm
3/4 - 16 (.750)	315 ft. lbs.	427 Nm
7/8 - 9 (.875)	501 ft. lbs.	679 Nm
1 - 12 (1.000)	746 ft. lbs.	1011 Nm
1 - 14 (1.000)	764 ft. lbs.	1036 Nm

Technical Data

Torque Chart - Metric

Property Class 8.8

ZINC-PLATED

SIZE	Coarse Thread		Fine Thread	
	Nm	ft. lbs.	Nm	ft. lbs.
M6	9.9	7	10	7
M8	24	18	25	18
M10	48	35	49	36
M12	83	61	88	65
M14	132	97	140	103
M16	200	148	210	155
M20	390	288	425	313
M24	675	498	720	531

Property Class 10.9

ZINC-PLATED

SIZE	Coarse Thread		Fine Thread	
	Nm	ft. lbs.	Nm	ft. lbs.
M6	14	10	14	10
M8	34	25	35	26
M10	67	49	68	50
M12	117	86	125	92
M14	185	136	192	142
M16	285	210	295	218
M20	550	406	600	443
M24	950	701	1000	738

Property Class 12.9

ZINC-PLATED

SIZE	Coarse Thread		Fine Thread	
	Nm	ft. lbs.	Nm	ft. lbs.
M6	16.5	12	16.5	12
M8	40	30	42	31
M10	81	60	82	60
M12	140	103	150	111
M14	220	162	235	173
M16	340	251	350	258
M20	660	487	720	531
M24	1140	841	1200	885

Conversion Factor: 1 ft. lb. = 1.3558 Nm

SAFETY

These machines are designed to carry out the function of mixing material of the non-cohesive, bituminous and granular varieties.

If used correctly, they will provide an effective and safe means of mixing and meet the appropriate performance standards.

It is essential that the operator of the machine is adequately trained in its safe operation, be authorized to operate it, and have sufficient knowledge of the machine to ensure that it is in full working order, before being put to use.



- Before using this equipment, study the entire Owner's Manual to become familiar with its operation. Do not allow untrained or unauthorized personnel, especially children, to operate this equipment. Use only factory authorized parts for service.



- When warning decals are destroyed or missing, contact the Manufacturer immediately at 1-800-888-9926 for replacement. For the safety of yourself and others, it is imperative that the following rules are observed. Failure to do so may result in serious injury or death.



- This notation appears before warnings in this manual. It means that the following steps must be carried out to avoid the possibility of personal injury or death. These warnings are intended to help the technician avoid potential hazards encountered in normal service procedures. We strongly recommend the reader take advantage of the information provided to prevent personal injury or injury to others.

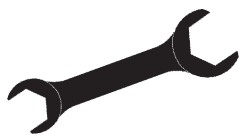

Warning - Loose Hardware

- With power off, daily check for loose hardware. Immediately inform your supervisor to have it corrected--Do Not Run the Mixer.

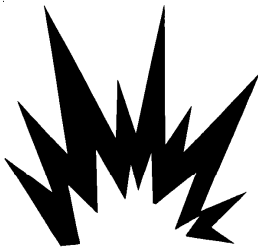

Warning-Handling Fuel

- Transport and handle fuel only when contained in approved safety containers.
- Do not smoke when refueling the mixer or during any other fuel handling operation.
- Do not refuel the mixer with the unit running or while hot.
- If fuel is spilled during refueling, wipe it off the engine immediately and discard the rag in a safe place.
- Do not operate the equipment if fuel or oil leaks exist – repair immediately.
- Never operate this equipment in an explosive atmosphere.

Health & Safety

Safety Precautions



Warning-Operating

- Never perform any work on the mixer while it is running.
- Before working on the mixer, stop the engine and unplug/disconnect the spark plug wire(s) to prevent accidental starting. If electric, unplug motor.
- Keep cowl closed during operation.
- Keep hands, clothing and jewelry away from all moving parts.
- Keep all guards in place, including drum guards.
- Never stick your hands or any solid object into the drum while it is in operation.



Warning-Hot Surfaces

- Avoid contact with hot exhaust system and engines.
- Allow engine to cool before performing any repairs or service.



Warning-Ventilation

- Never operate any gas powered mixer in a poorly ventilated or enclosed area.
- Avoid prolonged breathing of exhaust gases.

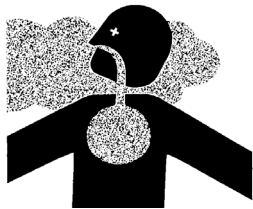

Warning-Extension Cords

- Always use the proper size grounded extension cord, conforming to the National Electric Code and Local Ordinances.
- Inspect all extension and electrical cords for cuts, frayed wire and broken connectors before use. Do not use cords if not in good condition.
- Do not route extension cords through standing water.
- Do not operate the mixer in standing water.
- When cleaning the mixer, never spray water over the motor.



Health & Safety

Safety Precautions



Warning-Eye Protection

- Always wear splash goggles when operating mixer.

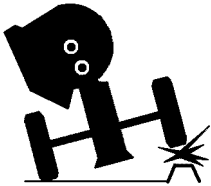

Warning-Towing

- Warning: Do not tow the mixer with the drum in the dump position. Mixer may become unstable and tip over when hitting a curb, pothole, or other obstruction.



- Warning: Always properly attach safety chains before mixer is towed. Maximum towing speed 55 m.p.h. (90 km/hr). Reduce speed according to highway conditions.



- Never leave mixer unattended while running.
- Mix only Mortar, Plaster, Terrazzo, Fireproofing and Grout.
- Do Not operate machine if rocks, stones, ice or frozen materials are in mix and/or in drum of mixer. The machine could jam, causing damage to the equipment or injury to the operator.

Introduction

Intro/Operating Principle/Delivery Checks/Before Starting/ Determining the Right Machine

Congratulations on your purchase of Stone Champion™ Mortar Mixers! You've made an excellent choice! Stone mixers have been specifically designed as the ideal machine for the professional contractor.

Upon receipt of your equipment, **CAREFULLY CHECK FOR ANY FREIGHT DAMAGE.** Any damage should be immediately reported to the carrier and a claim registered.

Stone Champion™ Mortar Mixers are manufactured to the strictest specifications and inspection procedures. If any material or manufacturing defects are found, return the tag on the machine with assembler's signature and your findings to the manufacturer. We want to know when a product is less than perfect. We also welcome any and all input on how the product may serve you better.

OPERATING PRINCIPLE

The following instructions were compiled to provide you information on how to obtain long and trouble free use of the unit. Periodic maintenance of this unit is essential. Read the manual in its entirety and follow the instructions carefully. Failure to do so may injure yourself or a bystander.

DELIVERY CHECKS--Immediately on taking delivery of your new equipment and before putting it into service:

- Read the handbook completely--it could save a great deal of unnecessary expense.
- Read the engine manual supplied.
- Check the general condition of the equipment--has it been damaged during delivery?
- Check engine oil level.
- Check fuel levels.

Recommended lubricants are detailed in the Care and Maintenance section.

BEFORE STARTING--These starting instructions are general guidelines only. Consult the engine manual included with this unit for specific instructions.

DETERMINING THE RIGHT MACHINE

655PM--Ideal for jobs requiring a 6 cu.ft. mixer.

755PM--Ideal mid-range all purpose size with 7 cu.ft. capacity.

855PM--Utilized for jobs requiring maximum productivity with an 8 cu.ft. size.

Mix only Mortar, Plaster, Terrazzo, Fireproofing and Grout. Do not operate machine if rocks, stones, ice or frozen materials are in mix and/or in drum of mixer.

The Stone Champion™ mixer line provides the most popular sizes and configurations available. Engine options available can accommodate any job. Engines available are 5hp B&S, 6hp Robin, 8.5hp Robin, 8hp B&S, 8hp B&S I/P, 5.5hp Honda, 8hp Honda, 10hp B&S, 1.5hp Electric, 2hp Electric.

Introduction

Standard Features/Preparation for Service

STANDARD FEATURES

Your new mixer comes standard with the following features:

Patented Automatic Guard Lifter--Lifts the drum guard as drum is tilted to prevent mix from being poured through the guard causing build up. The guard and guard lifter system is designed for your safety and convenience, please **DO NOT** operate the mixer with the guard lifter disconnected or the guards removed.

Quadruple Shaft Seal--Provides a life long neoprene and urethane seal system that completely isolates the sealed ball bearings in the drum trunnions from the mix.

Extendible Axle--Collapses to less than 36 inches total width for ease in maneuvering mixer around the work site or to save space while the mixer is in storage, extends to 46 inches total width to provide stability and safety when towing the mixer.

PREPARATION FOR SERVICE

READ ENGINE OWNERS MANUAL.

Before Starting--Mixers are shipped completely assembled and ready for operation except for installation of the safety chain.

Safety Chain Installation--Remove the safety chain kit from the engine compartment. The kit includes (1) 12 ft. length of safety chain and (2) connecting links. Pull one end of the chain through the (2) key hole slots located in the front post of the mixer with a hook (see drawing below and decal on mixer front post). Attach the connecting links to each end of the chain. Follow the instructions in the **TOWING** section of this manual and on the mixer front post to attach the safety chain to the towing vehicle.

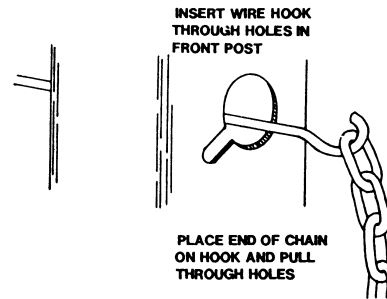

INSTALLING CHAIN TO MIXER

Dump Handle Installation--Remove the dump handle from the mixer drum where it is attached to the paddle shaft. Consult the **FRAME AND DRUM ASSEMBLY** section of this manual and use the (2) 3/8 bolts and nuts provided near the top, tow pole end of the drum to install the drum handle as shown in the exploded view. Do not torque bolt that holds the guard - see note in the **TORQUE CHART** section of this manual.

Oil Levels and Lubrication--Be sure to check the oil levels in the engine and engine reduction unit **BEFORE** starting this unit. The engine warranty is **VOID** if it is run without oil. Consult the **ENGINE MANUAL** supplied with this unit for specific instructions and oil recommendations.

Axle Blocks (Spring Axle Option Only)--Before your mixer was shipped, wood blocks were placed in the axle springs to avoid bouncing during transport. Before operation, loosen spring bolts, remove blocks and retighten spring bolts until locknut is fully engaged.

Rubber Blades--Are factory pre-set. Due to local preferences, some readjustment may be desired.

Introduction

Hardware/Fuel/Location and Use of Controls



Before working on machine, make sure engine spark plug wire is disconnected, or, if electric, that the electric cord is disconnected, to prevent any accidental starting.

Hardware--Check all hardware on mixer and engine/motor before starting. Consult the **TORQUE CHART** section of this manual and tighten any loose hardware accordingly.

Fuel--If your mixer is equipped with a gasoline engine, fill the gas tank with clean gasoline from a safety can. Consult the **ENGINE MANUAL** supplied with this unit for the proper type of gasoline required.

DO NOT mix oil with gasoline.

Before operating this unit, it is important to familiarize yourself, and any other personnel who will be using it, with the location and proper use of the controls to insure safe and efficient operation.

A. Always make sure that the drum latch is in the lock position (down) before starting up machine. With engine running, turn clutch lever to the right to turn paddles or to the left to stop.

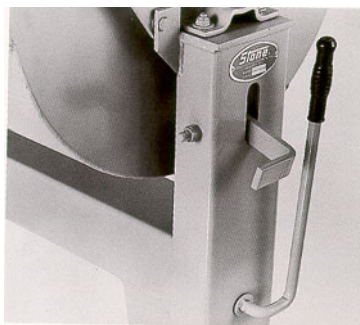

B. To dump mix from drum, stop paddles, move drum latch up and pull dump handle down. Always use caution when dumping mix.

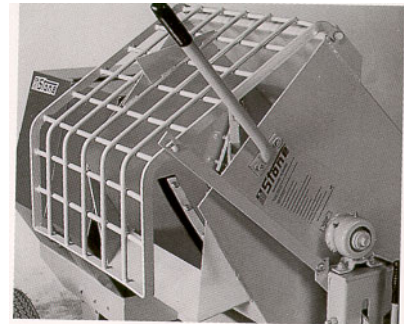

C. Always grease drum seals (both ends as recommended in the maintenance chart). The grease purges dirt--prolonging bearing life.

D. Always keep drum and paddles clean. Never run machine with hardened mix or foreign objects in drum--doing so damages paddles and/or engine.

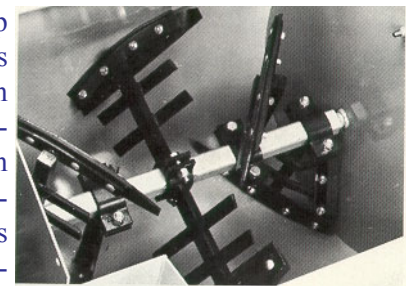

Operations

To Start/To Shut Off/Initial Operation



Follow the guidelines found in the **SAFETY PRECAUTION** section of this manual whenever handling gasoline.

NOTE: These starting instructions are general guidelines only. Since many engine Options are available on the manufacturer's PM mixers, consult the **ENGINE MANUAL** included with this unit for specific instructions.

TO START

Disengage Drive Train--Move clutch lever located at front of mixer to the up position (lever parallel to front post)

Check Drum Dump Latch--Make sure that the drum latch is engaged with the drum in the upright or mixing position.

START THE ENGINE/MOTOR GASOLINE ENGINE

Cold Start--Open the fuel valve under the gas tank all the way. Open the throttle approximately half way and apply the choke. Pull the starter rope sharply about (3) times. When the engine starts, open the choke and adjust the throttle as necessary to keep it running. Allow the engine to warm up for a few minutes before placing it under the load. If the engine doesn't start after (3) pulls, open choke slightly to prevent flooding. Always operate the engine at full throttle when under load.

Hot Start--Open the valve under the gas tank all the way if it has been shut off. Open the throttle approximately half way. Do not apply the choke. Pull the starter rope sharply until the engine starts. When the engine starts, adjust the throttle. Always operate the engine at full throttle when under load.



ELECTRIC MOTORS--Use the proper size (3) wire (grounded) extension cord, conforming to the National Electric Code and Local Ordinances. **DO NOT** use (2) wire extension cord. Check any extension cord which you plan on using carefully for broken connectors, bare wires and damaged insulation. **DO NOT** use any cord found to be in poor condition. Make sure the extension cord is not routed through standing water and that all the connections are tight. Use the shortest extension cord possible. Turn motor on.

Electric Motor Switch--Located on the motor. It is used to start and stop the electric mixer.

TO STOP THE ENGINE / MOTOR

Gasoline Engines--To improve the engine service life, move the clutch lever to the up position to disengage the drive train and allow the engine to idle without load for (2) to (5) minutes before shutting it down. When the idling period is up, use the grounding clip, kill switch or oil minder switch to stop the engine. Consult the **ENGINE MANUAL** included with this unit for specific instructions.

IF THE MIXER IS TO BE LEFT UNATTENDED FOR ANY LENGTH OF TIME, CLOSE THE FUEL VALVE UNDER THE GAS TANK.

Operations

Operating

Electric Motors--Disengage the drive train by moving the clutch lever to the down position.

TURN THE MOTOR OFF. IF THE MIXER IS TO BE LEFT UNATTENDED FOR ANY LENGTH OF TIME, DISCONNECT THE POWER CORD.

OPERATING

Start the engine / motor as instructed above and allow gasoline engines to reach operating temperatures. Close the engine cowl. **NEVER** operate the mixer with cowl open. **NEVER** operate the mixer with the drum guard open or removed. Move the clutch lever clockwise to the down position to engage the drive train and set mixer paddles in motion.

The mixer is now ready for the addition of the mortar mix. For best results proceed as follows:

1. Pour half the required amount of water into drum.
2. Add half the required amount of sand.
3. Add the total required amount of mortar mix (cement, lime, etc.).
4. Add the balance of sand and water.

After mixing for the proper length of time (homogeneous mix obtained), discharge the mix from the drum by using the dump handle to dump the drum and control the discharge.

After discharge, if another batch of mortar is to be mixed, return the drum to the mixing position and make sure the drum latch is engaged. Immediately pour in half of the required water for the next batch with paddles turning. This will clean the paddles and drum between batches and help prevent lumps of dried mortar from forming and contaminating the next batch.

If no more mortar is to be mixed in the next hour or so, the mixer drum and paddles should be thoroughly cleaned. If no more mortar is to be mixed that day, the entire mixer should be thoroughly cleaned inside and outside to insure maximum life and performance.

Maintenance



NEVER POUR OR SPRAY WATER OVER THE ENGINE OR MOTOR.



NEVER PUT HANDS OR ANY OBJECT INTO THE DRUM WHILE THE ENGINE OR MOTOR IS RUNNING.



ALWAYS DISCONNECT THE SPARK PLUG WIRE OR ELECTRIC CORD WHEN CLEANING INSIDE DRUM.



ALWAYS MAKE SURE GUARD LIFTER IS RECONNECTED TO GUARD BEFORE USING MIXER, DO NOT OPERATE THE MIXER WITH DRUM GUARD OPEN OR REMOVED.

MAINTENANCE AND LUBRICATION

To get long and trouble-free service from this mixer, it is essential that you perform periodic maintenance on the engine and machine mechanisms. Follow the guide lines listed below:

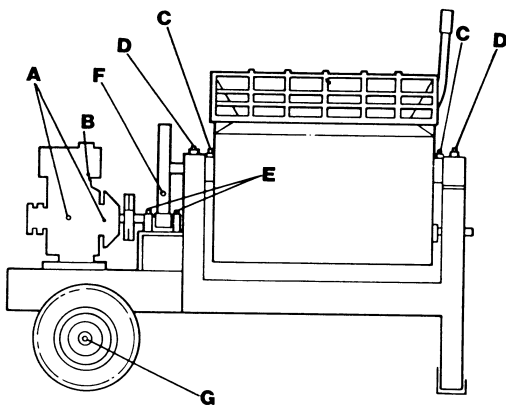

(Engine housing not shown for clarity--Do not operate mixer with cowl removed.)

Maintenance and Lubrication

- A. **Engine** - Daily check the oil levels in the engine and engine reduction unit. The engine warranty is **VOID** if run without oil. Since there are many options available on this mixer, consult the **ENGINE MANUAL** for specific recommendation as to oil level, oil type required and frequency of oil changes required. For maximum service life from the engine, follow those recommendations.
- B. **Engine Air Filter** - A supply of clean, unrestricted air is essential for long engine life and maximum performance. Check the air filter daily and clean or replace as necessary, again following the specific instructions found in the **ENGINE MANUAL**. **NEVER** run the engine without the air cleaner.
- C. **Drum Seals** - Greasing the drum seals is particularly important, as the lifetime warranty on the seal is **VOID** if they are not greased properly.
- D. **Trunnions** - Grease the trunnion to allow easy turning of the drum.
- E. **Pillow Block Bearings** - Need to be greased after each 40-50 hours of operation. Use any grade #1 lithium based grease.
- F. **Bull Gear** - Lightly grease the bull gear and pinion after each 250 hours of operation. Avoid over-greasing as this will attract dirt and accelerate wear.
- G. **Wheel Hubs** - Repack with torque wrench (4) tapered roller bearings in wheel hubs and replace wheel seals. Install washer and nut. Torque to 20 ft. lbs., back off one turn, torque to 7 ft. lbs., back off to first slot in nut and insert cotter key.

CLEANING



WARNING

FAILURE TO FOLLOW CLEANING INSTRUCTION AND/OR ROTATION OF DRUM WITHOUT GUARD LIFTER CONNECTED CAN RESULT IN SERIOUS INJURY.

For consistent performance, long life and continued high quality mixing of plaster or mortar, thoroughly clean the mixer inside and out at the end of each day's operation. To prevent lumps of dried plaster from forming and contaminating future batches of plaster or mortar, do not allow build up materials to form on drum guards, around paddles or anywhere inside the drum.

Before cleaning, shut the engine or motor and disconnect the spark plug wire or electric cord to prevent accidental starting.

- Before cleaning, shut the engine or motor and disconnect the spark plug wire or electric cord to prevent accidental starting.
- Keep drum guard closed.
- Always keep guard lifter connected.
- Keep drum in upright, mixing position.
- Spray mixer with water before mix dries to remove accumulation.
- Rotate drum to dump position to remove debris.

DO NOT beat on the drum with a shovel, hammer or other device to break up accumulations of dried mix, as this will dent and damage the drum.

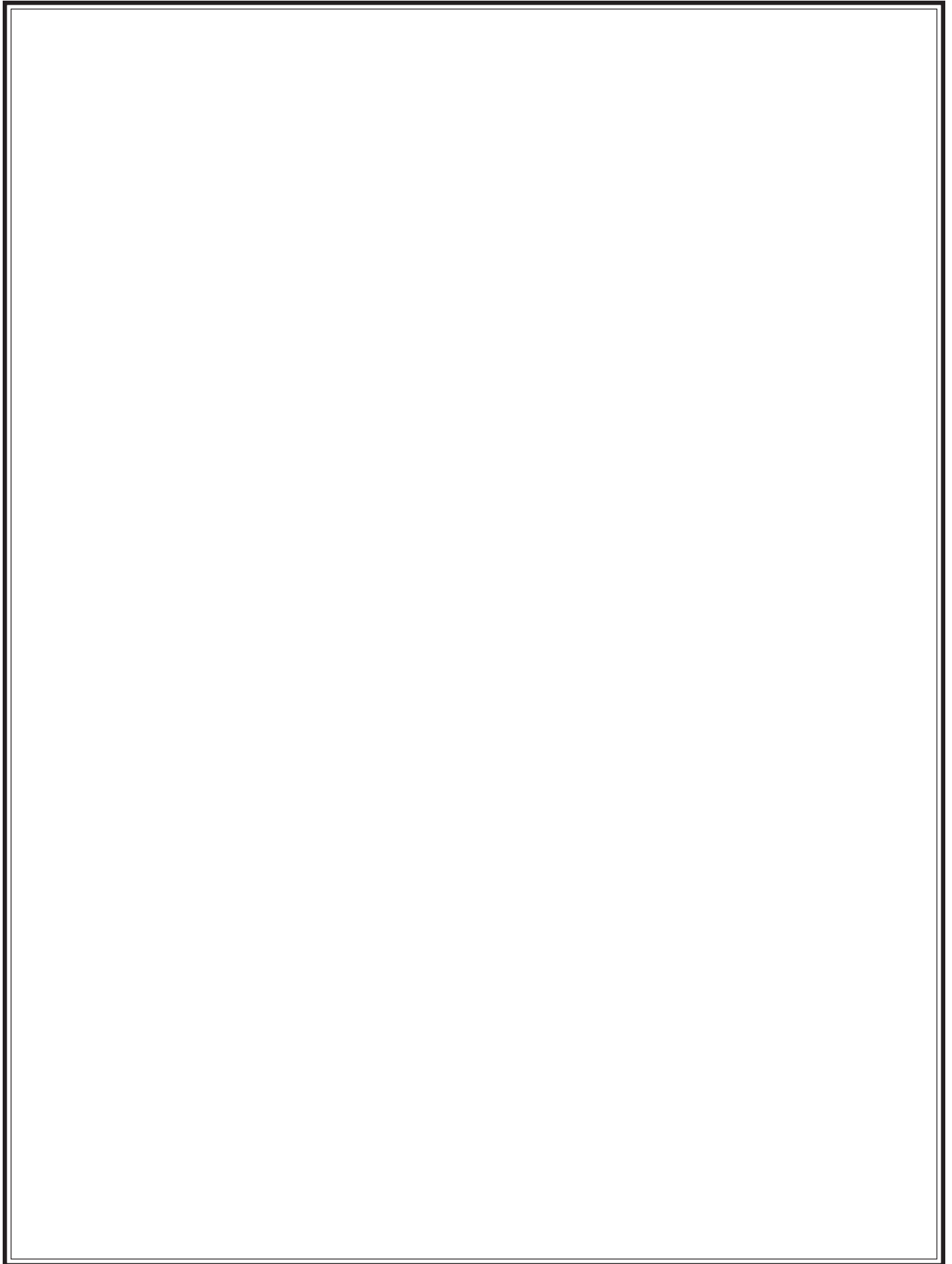

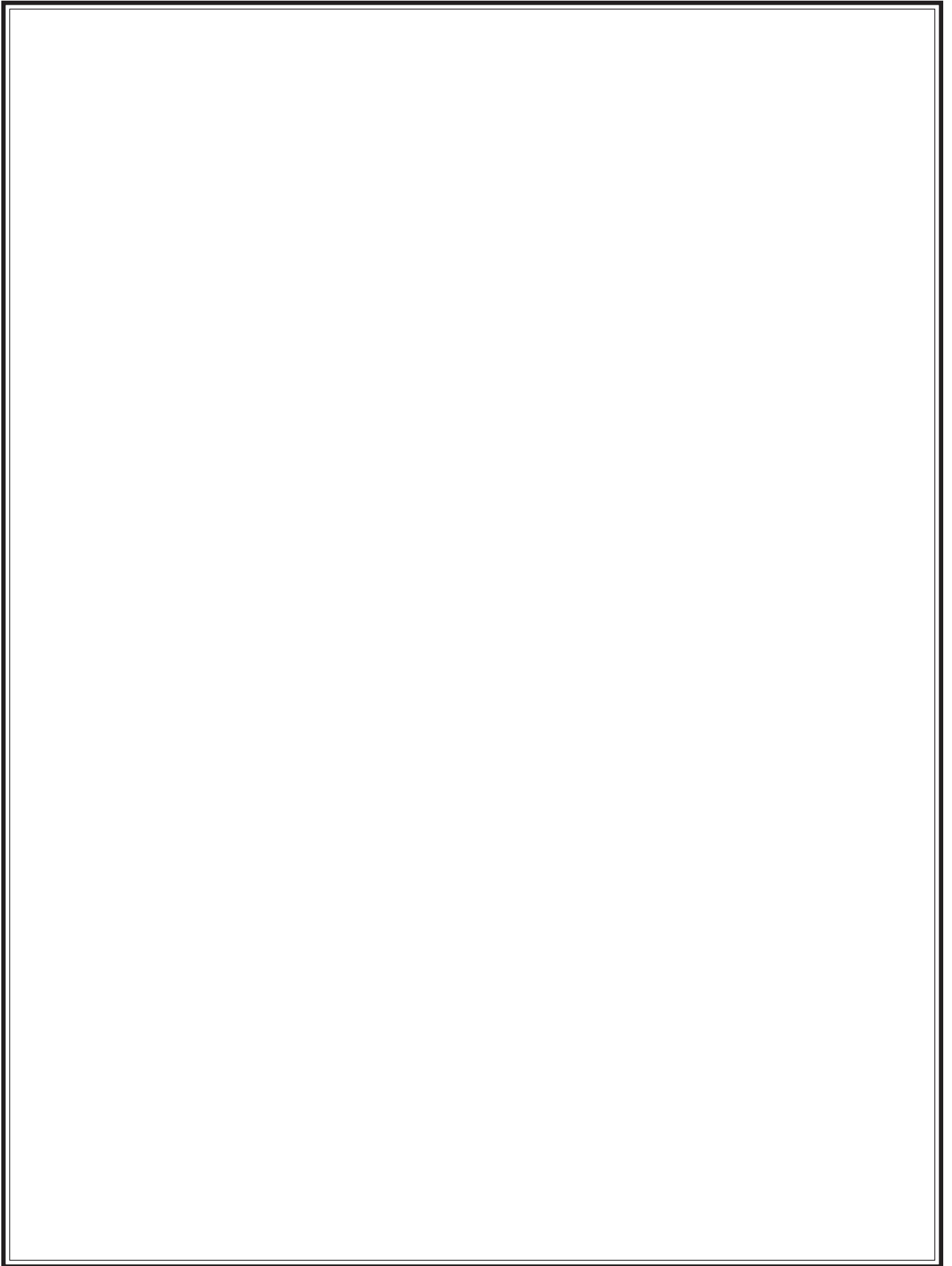

**CALIFORNIA PROPOSITION 65 WARNING:
Operation of this equipment and/or engine
exhaust from this product contains chemicals
known to the State of California to cause cancer,
birth defects, or other reproductive harm.**



***Bred Tough. Born to Work.
The Way It Ought To Be.***

Stone Construction Equipment, Inc.
P.O. Box 150, Honeoye, New York 14471
Phone: (800) 888-9926
Fax: 716-229-2363
e-mail: sceny@mcimail.com
www: stone-equip.com

A 100% employee-owned American manufacturer

© 1987 Stone Construction Equipment, Inc.
Printed in U.S.A.