

EN

T190



Bobcat®

Operation & Maintenance Manual

S/N 531711001 & Above

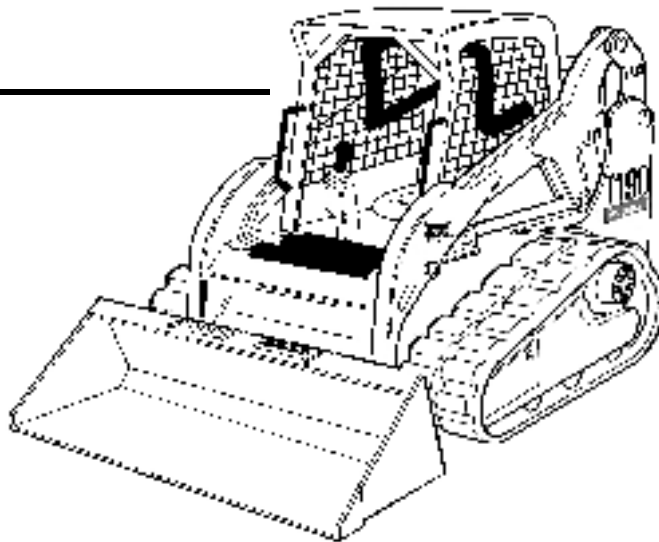

EQUIPPED WITH
BOBCAT INTERLOCK
CONTROL SYSTEM (BICS)

6904144-EN (09-06)

An  Ingersoll Rand business

Printed in Europe

© Bobcat Europe 2006

OPERATOR SAFETY WARNINGS



WARNING

Operator must have instructions before running the machine. Untrained operators can cause injury or death.

W-2001-1285



Safety Alert Symbol: This symbol with a warning statement, means: "Warning, be alert! Your safety is involved!" Carefully read the message that follows.

CORRECT



B-10731A

⚠ Never use the loader without instructions. See machine signs (decals), Operation & Maintenance Manual, and Operator's Handbook.

CORRECT

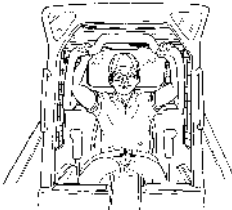

B-15570

⚠ Always use the seat bar and fasten seat belt snugly.
⚠ Always keep feet on the foot pedals or foot rest when operating loader.

WRONG

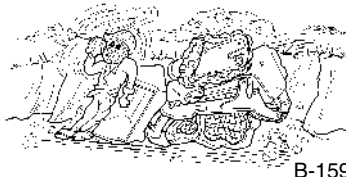

B-15953

⚠ Never use loader without operator cab with ROPS and FOPS approval. Fasten your seat belt.

WRONG

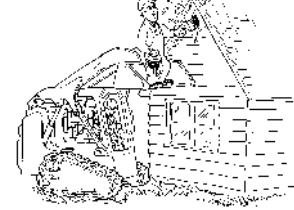

B-15962

⚠ Never use loader as man lift or elevating device for personnel.

WRONG



B-15968

⚠ Do not use loader in atmosphere with explosive dust, explosive gas, or where exhaust can contact flammable material.

WRONG



B-15952

⚠ Never carry riders.
⚠ Keep bystanders away from work area.

WRONG

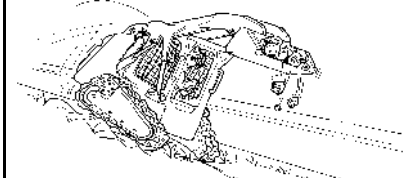

B-15970

⚠ Always carry bucket or attachments as low as possible.
⚠ Do not travel or turn with lift arms up.
⚠ Load, unload, and turn on flat level ground.

WRONG

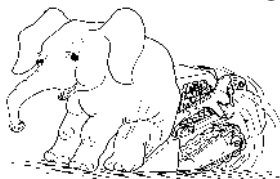

B-15948

⚠ Never exceed Rated Operating Capacity.

WRONG

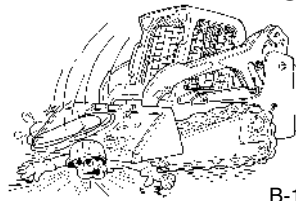

B-15957

⚠ Never leave loader with engine running or with lift arms up.
⚠ To park, engage parking brake and put attachment flat on the ground.

WRONG



B-15969

⚠ Never modify equipment.
⚠ Use only attachments approved by Bobcat Company for this model loader.

SAFETY EQUIPMENT

The Bobcat Loader must be equipped with safety items necessary for each job. Ask your dealer about attachments and accessories.

1. SEAT BELT: Check belt fasteners and check for damaged webbing or buckle.
2. SEAT BAR: When up, it must lock the loader controls.
3. OPERATOR CAB (ROPS and FOPS): It must be on the loader with all fasteners tight.
4. HANDBOOK: Must be in the cab.
5. SAFETY SIGNS (DECALS): Replace if damaged.
6. SAFETY TREADS: Replace if damaged.
7. GRAB HANDLES: Replace if damaged.
8. LIFT ARM SUPPORT DEVICE: Replace if damaged.
9. PARKING BRAKE
10. BOBCAT INTERLOCK CONTROL SYSTEM (BICS)

OSW12-0805

CONTENTS

FOREWORDIII
SAFETY XI
OPERATING INSTRUCTIONS 1
PREVENTIVE MAINTENANCE61
SYSTEM SETUP & ANALYSIS107
SPECIFICATIONS119

REFERENCE INFORMATION

Write the correct information for YOUR Bobcat Loader in the spaces below. Always use these numbers when referring to your Bobcat Loader.

Loader Serial Number _____
Engine Serial Number _____

NOTES:

YOUR BOBCAT DEALER:

ADDRESS: _____

PHONE: _____



Bobcat Europe
Drève Richelle 167
B-1410 WATERLOO
Belgium

FOREWORD

SAFETY

**OPERATING
INSTRUCTIONS**

**PREVENTIVE
MAINTENANCE**

**SYSTEM SETUP &
ANALYSIS**

SPECIFICATIONS



Bobcat®

This Operation & Maintenance Manual was written to give the owner / operator instructions on the safe operation and maintenance of the Bobcat Loader. **READ AND UNDERSTAND THIS OPERATION & MAINTENANCE MANUAL BEFORE OPERATING YOUR LOADER.** If you have any questions, see your Bobcat dealer.

BOBCAT COMPANY IS ISO 9001:2000 CERTIFIED V

DELIVERY REPORT VI

FEATURES, ACCESSORIES AND ATTACHMENTS VIII

 Attachments IX

 Buckets Available IX

 Options and Accessories VIII

 Special Applications Kit..... X

 Special Applications Kit Inspection And Maintenance X

 Standard Items..... VIII

LOADER IDENTIFICATION..... VII

MOTOR OIL..... V

REGULAR MAINTENANCE ITEMS..... V

SERIAL NUMBER LOCATIONS..... VI

 Engine Serial Number VI

 Loader Serial Number..... VI



Bobcat®

BOBCAT COMPANY IS ISO 9001:2000 CERTIFIED













ISO 9001:2000 is an international standard that controls the processes and procedures which we use to design, develop, manufacture and distribute Bobcat products.

British Standards Institute (**BSI**) is the Certified Registrar Bobcat Company chose to assess the Company's compliance with the ISO 9001:2000 standard. The BSI registration certifies that the two Bobcat manufacturing plants and the Bobcat corporate offices (Gwinner, Bismarck & West Fargo) in North Dakota are in compliance with ISO 9001:2000. Only certified assessors, like BSI, can grant registrations.

ISO 9001:2000 means that as a company we say what we do and do what we say. In other words, we have established procedures and policies, and we provide evidence that the procedures and policies are followed.

REGULAR MAINTENANCE ITEMS

	ENGINE OIL FILTER (6 Pack) 6675517		HYDROSTATIC FILTER, In-Line 6661022
	FUEL FILTER 6667352		BATTERY 6674687
	AIR FILTER, Outer 6598492		FLUID, Hydraulic / Hydrostatic 6903117 - (9,5 L) 6903118 - (19 L) 6903119 - (208 L)
	AIR FILTER, Inner 6598362		COOLANT PRESSURE CAP 6733429
	HYDROSTATIC FILTER 6661248		PROPYLENE GLYCOL Premixed - 6724094 Concentrate - 6724354

MOTOR OIL

6903105 -	SAE 15W40 CE/SG (12 L)	6903106 -	SAE 15W40 CE/SG (3,8 L)
6903107 -	SAE 10W30 CE/SG (12 L)	6903108 -	SAE 10W30 CE/SG (3,8 L)
6903109 -	SAE 30W CE/SG (12 L)	6903110 -	SAE 30W CE/SG (3,8 L)
6903113 -	SAE 15W40 CE/SG (9,5 L)	6903111 -	SAE 30W CE/SG (9,5 L)
6903112 -	SAE 10W30 CE / SG (9,5 L)		

SERIAL NUMBER LOCATIONS

Always use the serial number of the loader when requesting service information or when ordering parts. Early or later models (identification made by serial number) may use different parts, or it may be necessary to use a different procedure in doing a specific service operation.

Figure 1

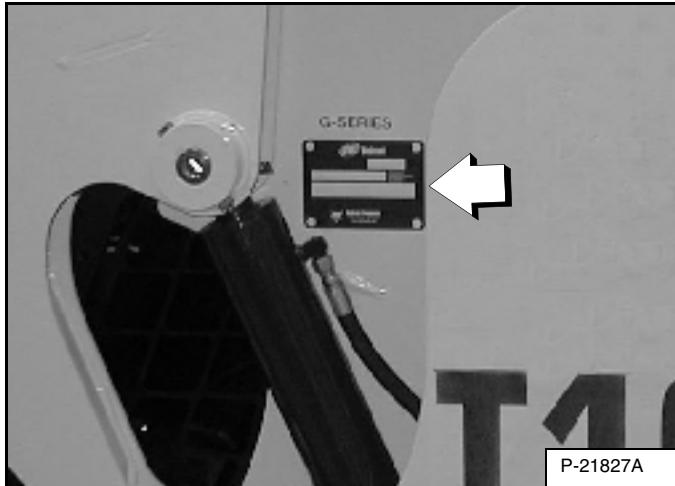

Loader Serial Number

The loader serial number plate is located on the outside of the loader frame [Figure 1].

Explanation of loader Serial Number:

XXXX XXXXX

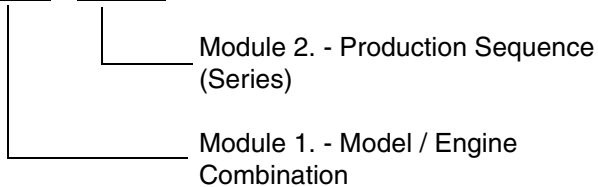

1. The four digit Model / Engine Combination Module number identifies the model number and engine combination.
2. The five digit Production Sequence Number identifies the order which the loader is produced.

Engine Serial Number

Figure 2

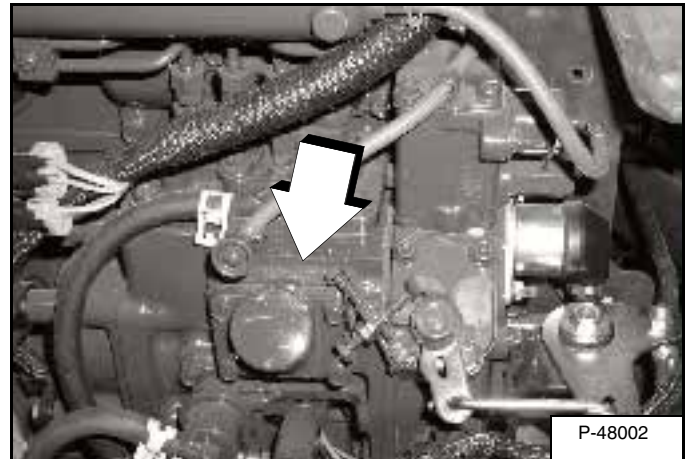

The engine serial number is located on the side of the engine [Figure 2] above the oil filter.

DELIVERY REPORT

Figure 3

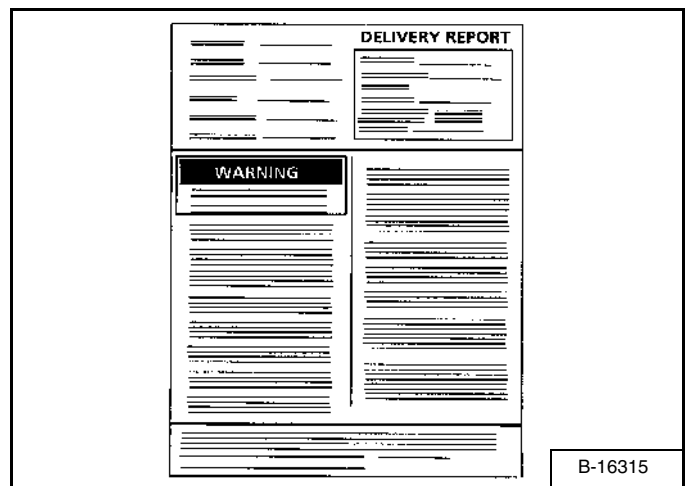

The delivery report must be filled out by the dealer and signed by the owner or operator when the Bobcat Loader is delivered. An explanation of the form must be given to the owner. Make sure it is filled out completely [Figure 3].

LOADER IDENTIFICATION

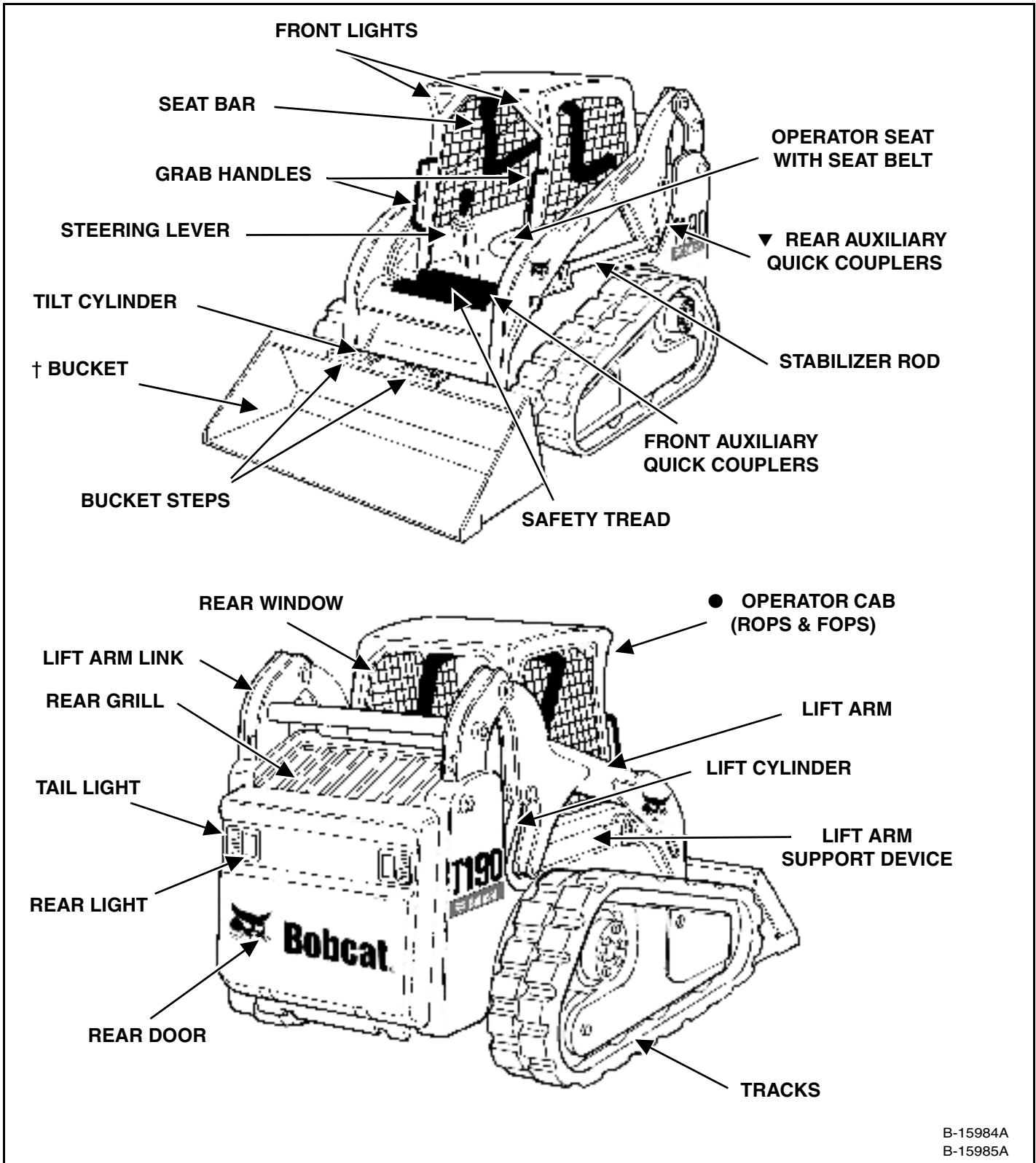

B-15984A
B-15985A

▼ OPTIONAL OR FIELD ACCESSORY (Not Standard Equipment)

† BUCKET - Several different buckets and other attachments are available from the Bobcat Loader.

● ROPS, FOPS - Roll Over Protective Structure, per ISO 3471, and Falling Object Protective Structure per SAE and ISO 3449, Level I. Level II is available. The Bobcat Loader is base-equipped with a standard operator cab as shown. Extra insulated cab is available as an option (Reduced noise level).

FEATURES, ACCESSORIES AND ATTACHMENTS

Standard Items

Model T190 Bobcat Loaders are equipped with the following standard items:

- Adjustable cushion seat
- Automatically activated glow-plugs
- Auxiliary hydraulics: variable flow / maximum flow
- Bobcat Interlock Control System (BICS)
- Bob-Tach™ frame
- CE certification
- Deluxe operator cab*
Includes interior cab foam, side, top and rear windows, Deluxe wire harness, dome light, and electrical power port
- Front door w / windshield wiper
- Electrically activated proportional front auxiliary hydraulics
- Engine / hydraulics system shutdown
- Hydraulic bucket positioning (including ON / OFF switch)
- Instrumentation
- Lift arm support
- Operating lights, front and rear
- Parking brake
- Seat bar
- Seat belt
- Tracks - rubber - 320 mm
- Turbo-charger with approved spark arrestor
- Warranty: 12 months or 2000 hours

* **Roll Over Protective Structure (ROPS)** - meets requirements of SAE-J1040 and ISO 3471; **Falling Object Protective Structure (FOPS)** - meets requirements of SAE-J1043 and ISO 3449, Level I

Options and Accessories

Below is a list of some equipment available from your Bobcat Loader dealer as Dealer and / or Factory Installed Accessories and Factory Installed Options. See your Bobcat dealer for other available options, accessories and attachments.

- Dealer Installed Accessories
 - 7-pin attachment control kit (standard with T190H)
 - Back up alarm kit
 - Cab enclosure kit
 - Deluxe instrument panel
 - Door sensor kit
 - FOPS kit **
 - Four-point lift kit
 - Fresh air heater kit
 - Front door kit
 - Fuel cap locking kit
 - Operator cab, CE, enclosure kit
 - Plumbing kit for fresh air heater
 - Power Bob-Tach™ kit
 - Rear auxiliary hydraulic kit
 - Replacement Bob-Tach™
 - Replacement operator cab structure
 - Single-point lift kit
 - Special applications kit
- Factory Options
 - Advanced Control System (ACS)
 - Advanced Hand Controls (AHC)
 - Air conditioning
 - Cab enclosure with heat
 - Deluxe instrument panel
 - Power Bob-Tach™

** **Falling Objects Protective Structure (FOPS)** - meets requirements of SAE-J1043 and ISO 3449, Level II

Specifications subject to change without notice.

FEATURES, ACCESSORIES AND ATTACHMENTS (CONT'D)

These and other attachments are approved for use on this model loader. Do not use unapproved attachments. Attachments not manufactured by Bobcat may not be approved.

The versatile Bobcat Loader quickly turns into a multi-job machine with a tight-fit attachment hook-up . . . from bucket to grapple to pallet fork to backhoe and a variety of other attachments.

See your Bobcat dealer for more details on these and other attachments and field accessories.

Increase the versatility of your Bobcat Loader with a variety of bucket styles and sizes.

Attachments

For specific model availability, see Bobcat Product Price List.

- Angle broom*†
- Auger
- Backhoe
- Box blade
- Brushcat rotary cutter
- Buckets
- Chipper*
- Combination bucket
- Concrete pump*
- Cutter crusher*
- Digger
- Dozer blade*
- Dumping hopper
- Farm grapple
- Grader*
- Hydraulic breaker**
- Industrial grapple
- Landplane
- Landscape rake
- Mixing bucket*
- Pallet fork - hydraulic
- Pallet fork - standard
- Planer*
- Scarifier
- Snow blower*
- Sod layer*
- Soil conditioner*
- Spreader
- Stump grinder*
- Super scraper
- Sweeper
- Three-point hitch
- Tiller
- Tree transplanter*
- Trench compactor
- Trencher
- Utility forks
- Utility frame
- Vibratory roller
- Wheel saw
- Whisker broom

* Attachment control kit required.

** When operating the loader with this attachment, a Special Applications Kit, which includes a 12 mm Lexan front door with 6 mm top and rear windows, must be used.

† Optional water kit.

Buckets Available

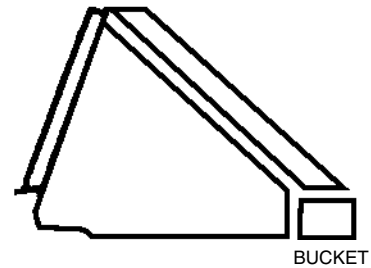

Many bucket styles, widths and different capacities are available for a variety of different applications. They include Construction & Industry, Low profile, Fertilizer and Snow, to name a few. See your Bobcat dealer for the correct bucket for your Bobcat Loader and application.

FEATURES, ACCESSORIES AND ATTACHMENTS (CONT'D)

Special Applications Kit

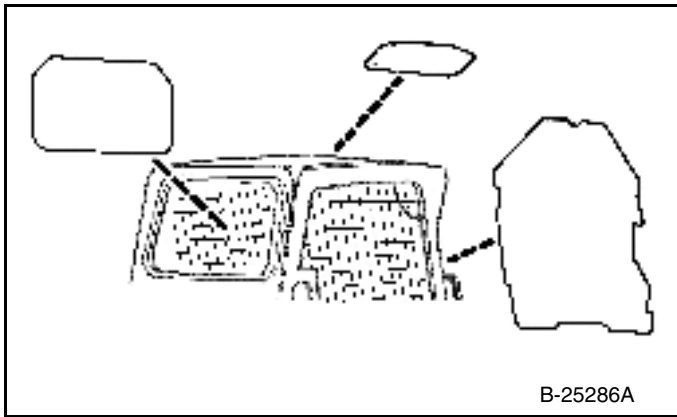

Available for special applications to restrict material from entering cab openings. Kit includes 12 mm Lexan™ front door, top and rear windows.

See your Bobcat dealer for availability.

Special Applications Kit Inspection And Maintenance

- Inspect for cracks or damage. Replace if required.
- Pre-rinse with water to remove gritty materials.
- Wash with a mild household detergent and warm water.
- Use a sponge or soft cloth. Rinse well with water and dry with a clean soft cloth or rubber squeegee.
- Do not use abrasive or highly alkaline cleaners.
- Do not operate windshield wipers on a dry surface.
- Do not clean with metal blades or scrapers.

SAFETY

MACHINE SIGNS (DECALS)	XV
SAFETY INSTRUCTIONS.....	XIII
Before Operation.....	XIII
Fire Prevention.....	XIV
Safe Operation Is The Operator's Responsibility	XIII
Safe Operation Needs A Qualified Operator.....	XIII

SAFETY



Bobcat®

SAFETY INSTRUCTIONS

Before Operation

Carefully follow the operating and maintenance instructions in this manual.

The Bobcat Loader is highly maneuverable and compact. It is rugged and useful under a wide variety of conditions. This presents an operator with hazards associated with off highway, rough terrain applications, common with Bobcat Loader usage.

The Bobcat Loader has an internal combustion engine with resultant heat and exhaust. All exhaust gasses can kill or cause illness so use the Loader with adequate ventilation.

The dealer explains the capabilities and restrictions of the Bobcat Loader and attachment for each application. The dealer demonstrates the safe operation according to Bobcat instructional materials, which are also available to operators. The dealer can also identify unsafe modifications or use of unapproved attachments. The attachments and buckets are designed for a Rated Operating Capacity (some have restricted lift heights). They are designed for secure fastening to the Bobcat Loader. The user must check with the dealer, or Bobcat literature, to determine safe loads of materials of specified densities for the machine - attachment combination.

The following publications and training materials provide information on the safe use and maintenance of the Bobcat machine and attachments:

- The Delivery Report is used to assure that complete instructions have been given to the new owner and that the machine and attachment is in safe operating condition.
- The Operation & Maintenance Manual delivered with the machine or attachment gives operating information as well as routine maintenance and service procedures. It is a part of the machine and can be stored in a container provided on the machine. Replacement Operation & Maintenance Manuals can be ordered from your Bobcat dealer.
- Machine signs (decals) instruct on the safe operation and care of your Bobcat machine or attachment. The signs and their locations are shown in the Operation & Maintenance Manual. Replacement signs are available from your Bobcat dealer.

- An Operator's Handbook is fastened to the operator cab of the Loader. It's brief instructions are convenient to the operator. The Handbook is available from your dealer in an English edition or one of many other languages. See your Bobcat dealer for more information on translated versions.

SI SSL-0206

SAFETY INSTRUCTIONS (CONT'D)

Safe Operation Is The Operator's Responsibility

**Safety Alert Symbol**

**This symbol with a warning statement means:
"Warning, be alert! Your safety is involved!"
Carefully read the message that follows.**

**WARNING**

Operator must have instructions before running the machine. Untrained operators can cause injury or death.

W-2001-1285

IMPORTANT

This notice identifies procedures which must be followed to avoid damage to the machine.

I-2019-0284

**WARNING**

Warnings on the machine and in the manuals are for your safety. Failure to obey warnings can cause injury or death.

W-2044-1285

The Bobcat Loader and attachment must be in good operating condition before use.

Check all of the items on the Bobcat Service Schedule Decal under the 8-10 hour column or as shown in the Operation & Maintenance Manual.

Safe Operation Needs A Qualified Operator

For an operator to be qualified, he or she must not use drugs or alcoholic drinks which impair alertness or coordination while working. An operator who is taking prescription drugs must get medical advice to determine if he or she can safely operate a machine.

A Qualified Operator Must Do The Following:

Understand the Written Instructions, Rules and Regulations

- The written instructions from Bobcat Company include the Delivery Report, Operation & Maintenance Manual, Operator's Handbook and machine signs (decals).
- Check the rules and regulations at your location. The rules may include an employer's work safety requirements. Regulations may apply to local driving requirements or use of a Slow Moving Vehicle emblem. Regulations may identify a hazard such as a utility line.

Have Training with Actual Operation

- Operator training must consist of a demonstration and verbal instruction. This training is given by your Bobcat dealer before the product is delivered.
- The new operator must start in an area without bystanders and use all the controls until he or she can operate the machine and attachment safely under all conditions of the work area. Always fasten seat belt before operating.

Know the Work Conditions

- Know the weight of the materials being handled. Avoid exceeding the Rated Operating Capacity of the machine. Material which is very dense will be heavier than the same volume of less dense material. Reduce the size of the load if handling dense material.
- The operator must know any prohibited uses or work areas, for example, he or she needs to know about excessive slopes.
- Know the location of any underground lines.
- Wear tight fitting clothing. Always wear safety glasses when doing maintenance or service. Safety glasses, hearing protection or Special Applications Kits are required for some work. See your Bobcat dealer about Bobcat Safety Equipment for your model.

SI SSL-0206

SAFETY INSTRUCTIONS (CONT'D)

Fire Prevention

The machines and some attachments have components that are at high temperatures under normal operating conditions. The primary source of high temperatures is the engine and exhaust system. The electrical system, if damaged or incorrectly maintained, can be a source of arcs or sparks.

Flammable debris (leaves, straw, etc.) must be removed regularly. If flammable debris is allowed to accumulate, it can cause a fire hazard. Clean often to avoid this accumulation. Flammable debris in the engine compartment is a potential fire hazard.

The spark arrestor exhaust system is designed to control the emission of hot particles from the engine and exhaust system, but the muffler and the exhaust gases are still hot.

- Do not use the machine where exhaust, arcs, sparks or hot components can contact flammable material, explosive dust or gases.
- The operator cab, engine compartment and engine cooling system must be inspected every day and cleaned if necessary to prevent fire hazards and overheating.
- Check all electrical wiring and connections for damage. Keep the battery terminals clean and tight. Repair or replace any damaged part.
- Check fuel and hydraulic tubes, hoses and fittings for damage and leakage. Never use open flame or bare skin to check for leaks. Tighten or replace any parts that show leakage. Always clean fluid spills. Do not use gasoline or diesel fuel for cleaning parts. Use commercial nonflammable solvents.
- Do not use ether or starting fluids on any engine that has glow plugs. These starting aids can cause explosion and injure you or bystanders.
- Always clean the machine, disconnect the battery, and disconnect the wiring from the Bobcat controllers before welding. Cover rubber hoses, battery and all other flammable parts. Keep a fire extinguisher near the machine when welding. Have good ventilation when grinding or welding painted parts. Wear dust mask when grinding painted parts. Toxic dust or gas can be produced.
- Stop the engine and let it cool before adding fuel. No smoking!
- Use the procedure in the Operation & Maintenance Manual for connecting the battery and for jump starting.

- Use the procedure in the Operation & Maintenance Manual for cleaning the spark arrestor muffler (if equipped).

Figure 4

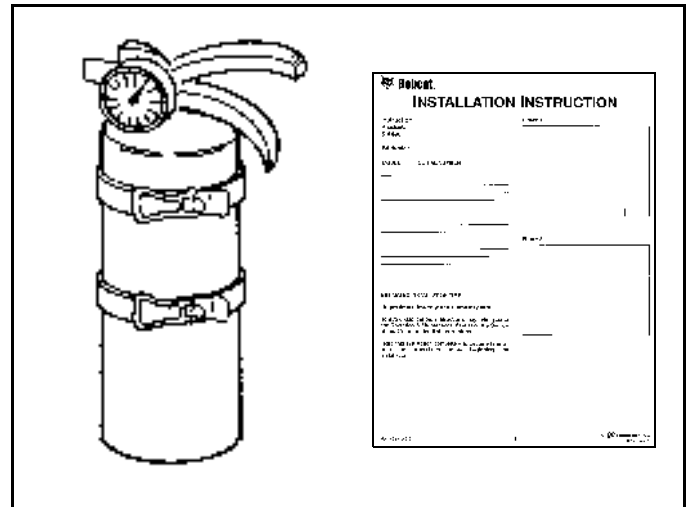

- Know where fire extinguishers and first aid kits are located and how to use them. Fire extinguishers are available from your Bobcat dealer [Figure 4].

SI SSL-0206

MACHINE SIGNS (DECALS)

Follow the instructions on all the Machine Signs (Decals) that are on the loader. Replace any damaged machine signs and be sure they are in the correct locations. Machine signs are available from your Bobcat Loader dealer.

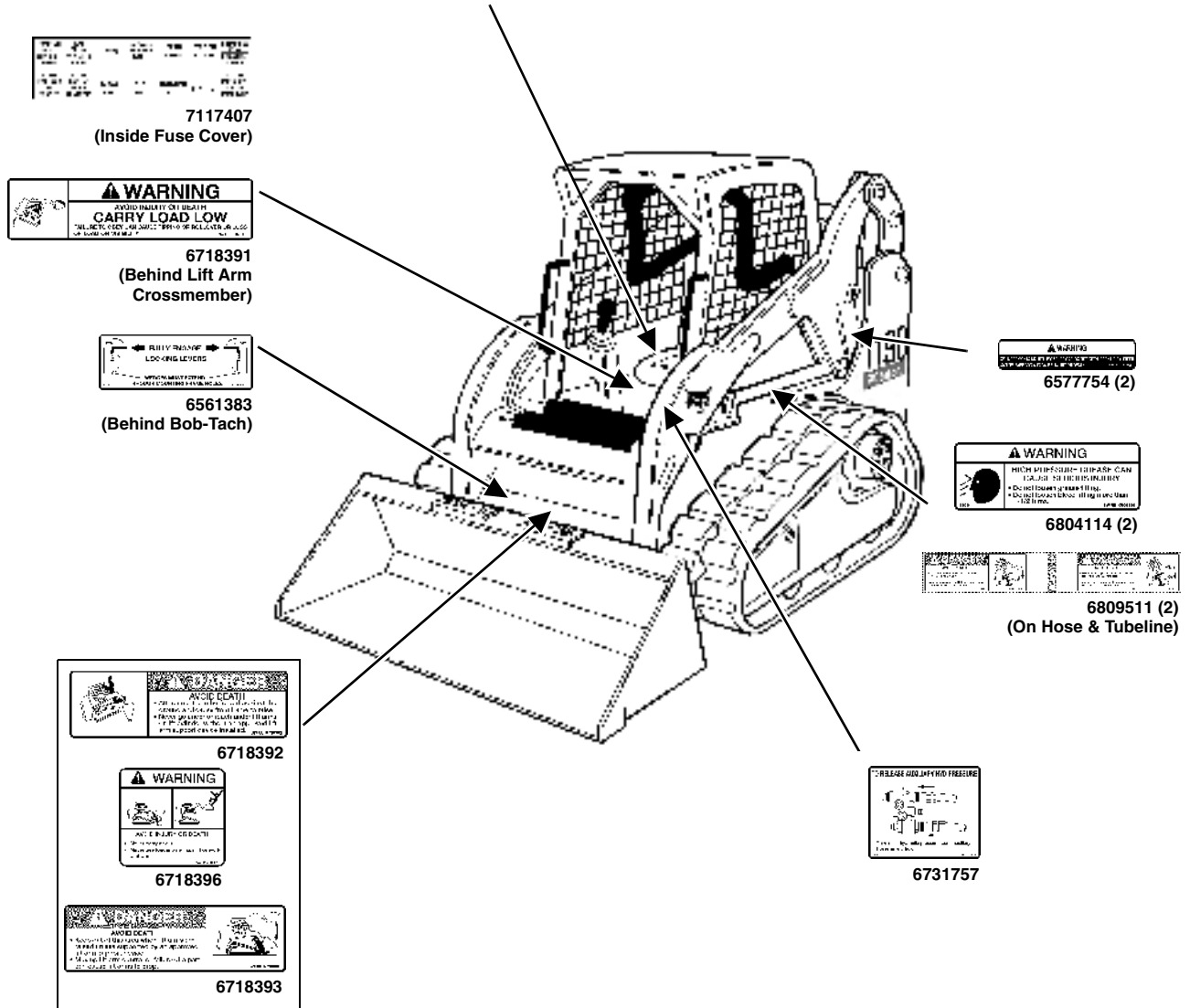
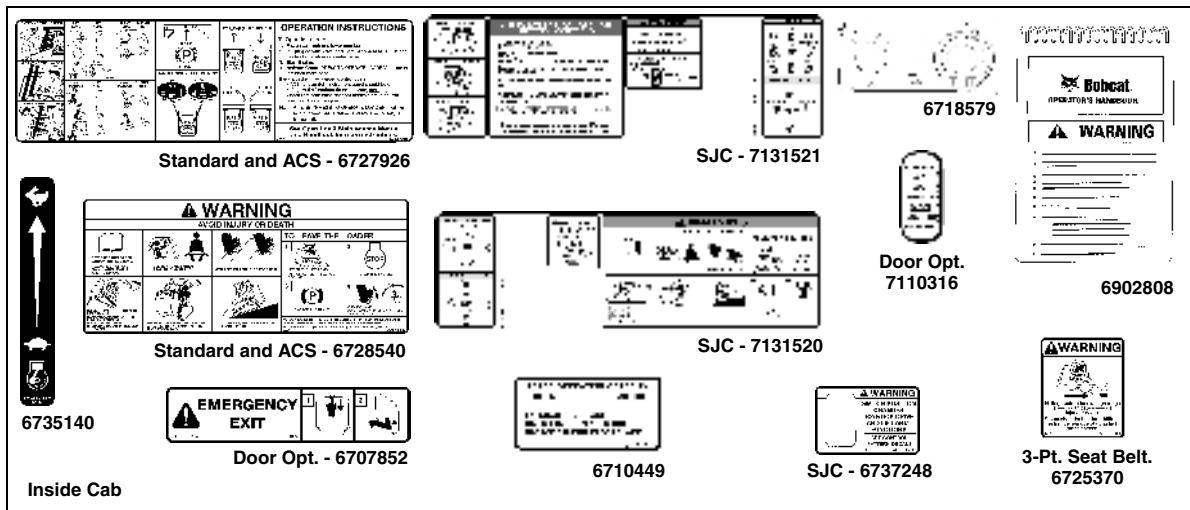

(ACS) - Advanced Control System
(SJC) - Selectable Joystick Control

B-15984A

MACHINE SIGNS (DECALS) (CONT'D)

Follow the instructions on all the Machine Signs (Decals) that are on the loader. Replace any damaged machine signs and be sure they are in the correct locations. Machine signs are available from your Bobcat Loader dealer.

BOBCAT HYDROSTATIC FLUID



6565990

IMPORTANT

DO NOT ADD ETHYLENE GLYCOL COOLANT TO THE COOLANT SYSTEM PROTECTED TO -34°F (-37°C) WITH BOBCAT PG COOLANT (Propylene Glycol). Check Condition With Refractometer. See Operation and Maintenance Manual.

6560573

DO NOT Add Ethylene Glycol Coolant COOLANT SYSTEM PROTECTED TO -34°F (-37°C) WITH BOBCAT PG COOLANT (Propylene Glycol)

Check Condition With Refractometer. See Operation and Maintenance Manual.

6708929

6733996

WARNING

UNDER COVER, MUFFLER, AND IN REAR OF TRACK GUIDE CLEAR FOR ALL OPERATIONS.

6577754 (2)

PUSH TO RELEASE STOP

6578368

WARNING

DO NOT OPERATE TRACKS ON STEEP SLOPES. OPERATE TRACKS ON SLOPES UP TO 30° MAXIMUM. OPERATE TRACKS ON SLOPES UP TO 45° MAXIMUM. OPERATE TRACKS ON SLOPES UP TO 60° MAXIMUM. OPERATE TRACKS ON SLOPES UP TO 75° MAXIMUM. OPERATE TRACKS ON SLOPES UP TO 90° MAXIMUM.

6719018

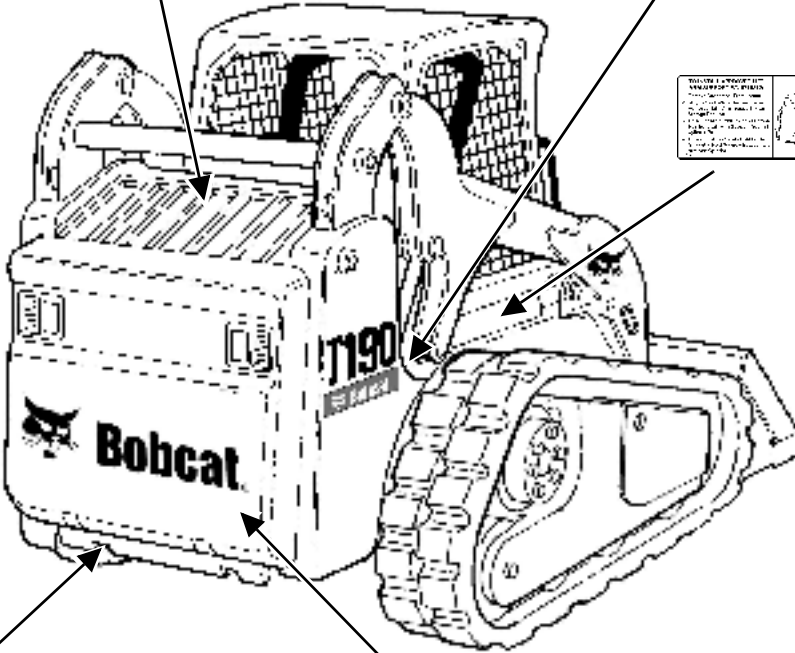

XC

6727595 (5)

SPRING LOADED IDLER ADJUSTING PROCEDURE

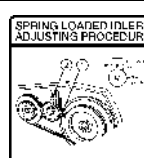

6709030

6734534B

Inside Rear Door

B-15985A



Bobcat®

OPERATING INSTRUCTIONS

ATTACHMENTS	38
Choosing The Correct Bucket	38
Installing And Removing The Attachment (Hand Lever Bob-Tach)	39
Installing And Removing The Attachment (Power Bob-Tach Option)	42
Pallet Forks	38
BOBCAT INTERLOCK CONTROL SYSTEM (BICS)	11
Operation	11
DAILY INSPECTION.....	25
Daily Inspection And Maintenance.....	26
DRIVING AND STEERING THE LOADER.....	14
Available Controls Configurations	14
Operation (SJC) In 'H' Control Pattern.....	15
Operation (SJC) In 'ISO' Control Pattern	16
Operation (Standard and ACS)	14
ENGINE SPEED CONTROL.....	13
Operation	13
HYDRAULIC CONTROLS	18
Advanced Control System (ACS) In HAND Control Mode	19
Attachment Control Device (ACD) (If Equipped)	24
Auxiliary Hydraulics Operation (MAXIMUM FLOW ONLY).....	21
Auxiliary Hydraulics Operation (VARIABLE FLOW)	21
Bucket Position Valve Operation (If Equipped).....	20
Description	18
FRONT Auxiliary Hydraulics Operation (CONTINUOUS FLOW).....	22
FRONT Auxiliary Hydraulics Operation (MAXIMUM FLOW).....	21
FRONT Auxiliary Hydraulics Operation (VARIABLE FLOW).....	21
High-Flow Hydraulics Operation (If Equipped)	23
Quick Couplers.....	22
REAR Auxiliary Hydraulics Operation (If Equipped)	22
Relieve Hydraulic Pressure (Loader And Attachment).....	23
Secondary Front Auxiliary Hydraulics (If Equipped).....	24
Selectable Joystick Control (SJC) In 'H' Control Pattern.....	19
Selectable Joystick Control (SJC) In 'ISO' Control Pattern	20
Standard Controls (Also ACS In FOOT Pedal Mode).....	18
INSTRUMENT PANEL IDENTIFICATION.....	5
Cab Light.....	8
Left Panel	5
Option And Field Accessory Panels.....	9
Right Panel (Key Switch).....	6
Right Panel (Keyless)	7
LIFT ARM BY-PASS CONTROL.....	12
Operation	12

**OPERATING
INSTRUCTIONS**

OPERATING INSTRUCTIONS (CONT'D)

LIFTING THE LOADER	58
Four Point Lift	58
Single Point Lift.....	58
MONITORING THE DISPLAY PANELS	34
Left Panel.....	34
Right Panel (Key Switch)	34
Right Panel (Keyless)	35
Warning And Shutdown.....	35
OPERATING PROCEDURE	46
Digging And Filling A Hole (ACS - Handles, SJC - 'H' Pattern)	53
Digging And Filling A Hole (Foot Pedals).....	50
Digging And Filling A Hole (SJC - 'ISO' Pattern)	56
Filling And Emptying The Bucket (ACS - Handles, SJC - 'H' Pattern)....	51
Filling And Emptying The Bucket (Foot Pedals)	48
Filling And Emptying The Bucket (SJC - 'ISO' Pattern)	54
Inspect The Work Area.....	46
Leveling The Ground Using Float (ACS - Handles, SJC - 'H' Pattern)....	52
Leveling The Ground Using Float (Foot Pedals).....	49
Leveling The Ground Using Float (SJC - 'ISO' Pattern)	55
Operating With A Full Bucket.....	46
Operating With An Empty Bucket	47
PARKING BRAKE	13
Operation.....	13
PRE-STARTING PROCEDURE.....	27
Entering The Loader.....	27
Seat Adjustment	27
Seat Bar.....	28
Seat Belt Adjustment	28
SEAT BAR RESTRAINT SYSTEM	10
Operation.....	10
SPEED MANAGEMENT (SJC OPTION)	17
Operation.....	17
STARTING THE ENGINE	29
Cold Temperature Starting.....	33
Key Switch	29
Keyless	31
Warming The Hydraulic / Hydrostatic System	33
STOPPING THE ENGINE AND LEAVING THE LOADER.....	36
Emergency Exit	37
Procedure	36
STOPPING THE LOADER.....	17
Using The Control Levers Or Joysticks.....	17

OPERATING INSTRUCTIONS (CONT'D)

TOWING THE LOADER	57
Procedure	57
TRACK CARRIAGE SYSTEM.....	44
Compact Track Loader Operating And Maintenance Tips	44
Introduction	44
TRACTION LOCK OVERRIDE.....	12
Operation	12
TRANSPORTING THE LOADER ON A TRAILER	59
Fastening	59
Loading And Unloading.....	59



Bobcat®

INSTRUMENT PANEL IDENTIFICATION

Left Panel

Figure 5

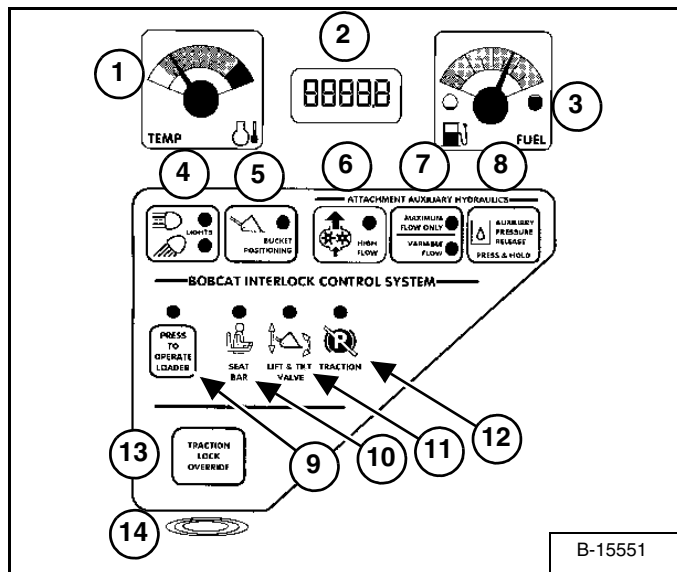

The left instrument panel is the same for both the Key Switch and Keyless Instrument Panels [Figure 5].

The table below shows the DESCRIPTION and FUNCTION / OPERATION for each of the components of the left panel.

REF. NO	DESCRIPTION	FUNCTION / OPERATION
1	TEMPERATURE GAUGE	Shows the engine coolant temperature.
2	HOURMETER / CODE DISPLAY / GLOW PLUG COUNTDOWN	HOURMETER - Records operating hours of loader. CODE DISPLAY - Display numeric SERVICE CODES* relating to the loader monitoring system. COUNTDOWN - Preheat time remaining
3	FUEL GAUGE	Shows the amount of fuel in the tank.
4	LIGHTS / HOLD FOR CODES	LIGHTS - Press once for FRONT LIGHTS. Press a second time for FRONT AND REAR lights. Press a third time to turn all lights off. HOLD FOR CODES - Press and hold two seconds for display of SERVICE CODES (2). (CODES* show only when there is an error found by loader monitoring system.)
5	BUCKET POSITIONING (Option)	Press to engage the BUCKET POSITIONING function. Press again to disengage. Press and hold 2 seconds to view SHTDN (SHUTDOWN) feature & Operational Code Number in HOURMETER / CODE DISPLAY.
ATTACHMENT AUXILIARY HYDRAULICS		
6	HIGH FLOW (Option)	Press to engage the HIGH FLOW auxiliary hydraulics. Press again to disengage.
7	MAXIMUM FLOW / VARIABLE FLOW	Press once to engage the VARIABLE FLOW auxiliary hydraulics. Press a second time to engage MAXIMUM FLOW. Press a third time to disengage all auxiliary hydraulics. [VARIABLE FLOW allows for slow-to-fast movement of auxiliary functions. (The farther you move the switch, the faster the movement of auxiliary functions.) MAXIMUM FLOW allows for only fast movement.]
8	AUXILIARY PRESSURE RELEASE	Rear Auxiliary Only - With key ON or engine running, press and hold button for 5 seconds. (See Relieve Hydraulic Pressure (Loader And Attachment) on Page 23 for front auxiliary pressure release.)
BOBCAT INTERLOCK CONTROL SYSTEM (BICS) (See SYSTEM ANALYSIS, Page 109 for more information.)		
9	PRESS TO OPERATE LOADER	Press to activate BICS System when the Seat Bar is down and operator is seated in operating position.
10	SEAT BAR	The light comes ON when the seat bar is down.
11	LIFT & TILT VALVE	The light comes ON when the seat bar is down and the PRESS TO OPERATE Button is pressed. The lift and tilt functions <u>can</u> be operated when the light is ON.
12	TRACTION	The light comes ON when the seat bar is down, engine is running, and parking brake is released. The loader <u>can</u> be moved forward or backward when the light is ON.
13	TRACTION LOCK OVERRIDE	(Function Only When Seat Bar Is Raised And The Engine Is Running) Press to unlock the brakes. Allows you to use the steering levers to move the loader forward or backward when using the backhoe attachment or for loader service. (See TRACTION LOCK OVERRIDE on Page 12). Press a second time to lock the brakes.
14	ALARM	The ALARM beeps when there is an Error, WARNING or SHUTDOWN condition.

* See SYSTEM SETUP & ANALYSIS, Page 110 for further description of SERVICE CODES.

INSTRUMENT PANEL IDENTIFICATION (CONT'D)

Right Panel (Key Switch)

Figure 6

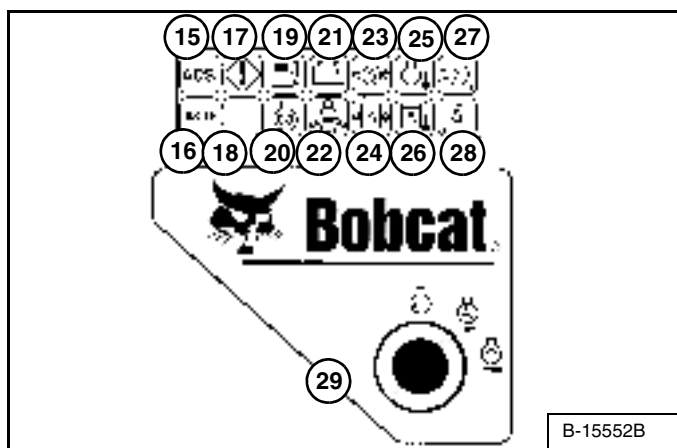

The right instrument panel shown [Figure 6] is the Key Switch Panel.

The table below shows the Icons and other components of the Right Key Switch Panel.

* These functions are monitored and have SERVICE CODES associated with them. For descriptions of DIAGNOSTICS SERVICE CODES. (See DIAGNOSTIC SERVICE CODES on Page 110.)

REF.	FUNCTION	ICON / LIGHT	ALARM	CODE	CONDITION	DESCRIPTION
15	Advanced Control System (ACS)	ON	3 Beeps	*	Error	Error with Advanced Control System (ACS).
16	Attachment Control Device (ACD)	ON FLASHING	--- 3 Beeps	--- *	--- Error	Electrical controlled attachment is present. Error with Attachment Control Device (ACD).
17	General Warning	ON ON FLASHING	3 Beeps 3 Beeps Continuous	* * *	Error WARNING SHUTDOWN	Error with one or more engine or hydraulic functions. Engine speed high or in shutdown. Engine speed very high. Engine will stop in 10 seconds.
18	NOT USED					
19	Fuel Level	ON FLASHING	3 Beeps 3 Beeps	* *	Error WARNING	Fuel level sender system fault. Fuel level low.
20	Glow Plugs	ON FLASHING	--- 3 Beeps	--- *	--- Error	Glow plugs are energized. Error with glow plugs.
21	System Voltage	ON	3 Beeps	*	WARNING	Voltage low, high or very high.
22	Seat Belt	ON	---	---	---	Light stays on for 45 seconds to remind operator to fasten seat belt.
23	Engine Oil Pressure	ON ON FLASHING	3 Beeps 3 Beeps Continuous	* * *	Error WARNING SHUTDOWN	Engine oil pressure sender out of range. Engine oil level low. Engine oil pressure very low. Engine will shutdown in 10 seconds.
24	Hydrostatic Charge Pressure	ON ON FLASHING	3 Beeps 3 Beeps Continuous	* * *	Error WARNING SHUTDOWN	Hydraulic oil pressure sender out of range. Hydraulic oil pressure low. Hydraulic charge pressure very low. Engine will stop in 10 seconds.
25	Engine Coolant Temperature	ON ON FLASHING	3 Beeps 3 Beeps Continuous	* * *	Error WARNING SHUTDOWN	Engine coolant sender out of range. Engine coolant temperature high. Engine coolant temperature very high. Engine will stop in 10 seconds.
26	Hydraulic Oil Temperature	ON ON FLASHING	3 Beeps 3 Beeps Continuous	* * *	Error WARNING SHUTDOWN	Hydraulic oil temperature out of range. Hydraulic oil temperature high. Hydraulic oil temperature very high. Engine will stop in 10 seconds.
27	Engine Air Filter	ON FLASHING	3 Beeps 3 Beeps	* *	Error WARNING	Air filter with high restriction. Air filter switch not connected.
28	Hydraulic Filter	ON FLASHING	3 Beeps 3 Beeps	* *	Error WARNING	Hydraulic filter with high restriction. Hydraulic filter switch not connected.
29	Key Switch	---	---	---	---	Used to start and stop the engine.

* See SYSTEM SETUP & ANALYSIS, Page 110 for further description of SERVICE CODES.

INSTRUMENT PANEL IDENTIFICATION (CONT'D)

Right Panel (Keyless)

Figure 7

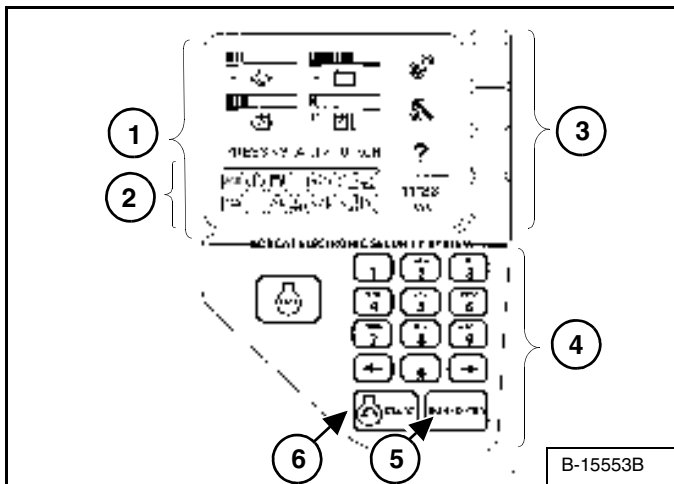

The right instrument panel shown [Figure 7] is the Keyless Panel.

1. **Display Panel:** The Display Panel is where all system setup, monitoring, troubleshooting, and error conditions are displayed.
2. **Function Icons:** The lower left area of the Keyless Panel has the same Icons as the Key Switch Panel. These Icons are only visible when the monitoring system has detected an error.
3. **Selection Buttons:** The four Selection Buttons allow you to select items from the Display Panel and scroll through screens.
4. **Keypad:** The numeric keypad (4) [Figure 7] has two functions:

To enter a number code (password) to allow starting the engine (Keyless Start).

To enter a number as directed for further use of the Display Panel.

Figure 8

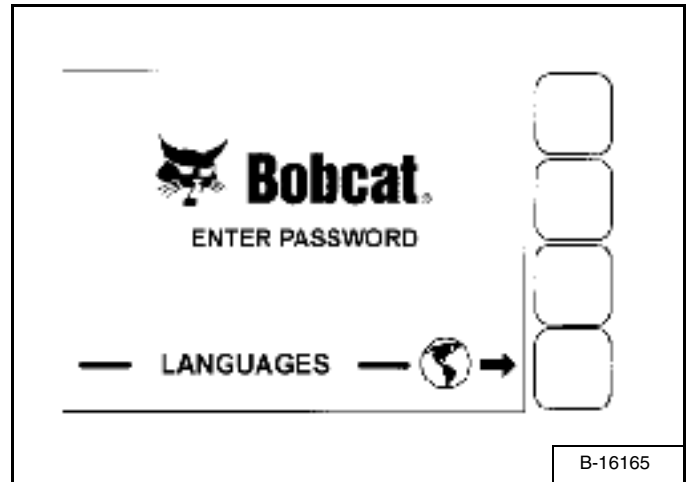

The first screen you will see on your new loader will be as shown in [Figure 8].

When this screen is on the display you can enter the password and start the engine or change the Display Panel setup features.

NOTE: Your new loader (with Keyless Instrument Panel) will have an Owner Password. Your dealer will provide you with this password. Change the password to one that you will easily remember to prevent unauthorized use of your loader. (See Panel Setup on Page 116.) Keep your password in a safe place for future needs.

Start Engine: Use the Keypad to enter the numbers (letters) of your password and press the RUN / ENTER key (5) [Figure 7].

Press and hold the START Button (6) [Figure 7] until the engine starts.

Change Language: Press the Selection Button at the end of the arrow [Figure 8] to go to the next screen.

INSTRUMENT PANEL IDENTIFICATION (CONT'D)

Right Panel (Keyless) (Cont'd)

Figure 9

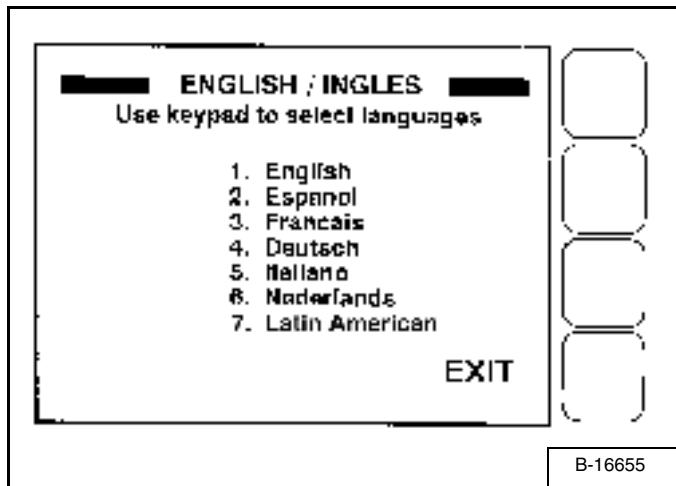

Use the Keypad to select the number of the language [Figure 9].

Press EXIT. The screen will return to [Figure 8]. You can then enter the password and start the engine.

For further description of screens to setup the system for your use (See Panel Setup on Page 116.)

NOTE: Pressing the EXIT key will go to the previous screen and you can continue pressing until you get to the initial (home) screen.
SHORTCUT: Press the "0" (zero) key to get to the home screen immediately.

Cab Light

Figure 10

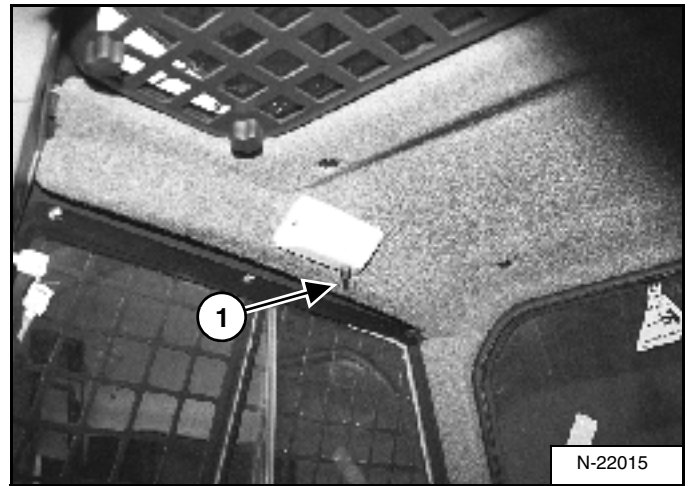

Push the button (1) [Figure 10] to turn the light ON. Push the button again to turn OFF.

INSTRUMENT PANEL IDENTIFICATION (CONT'D)

Option And Field Accessory Panels

Figure 11

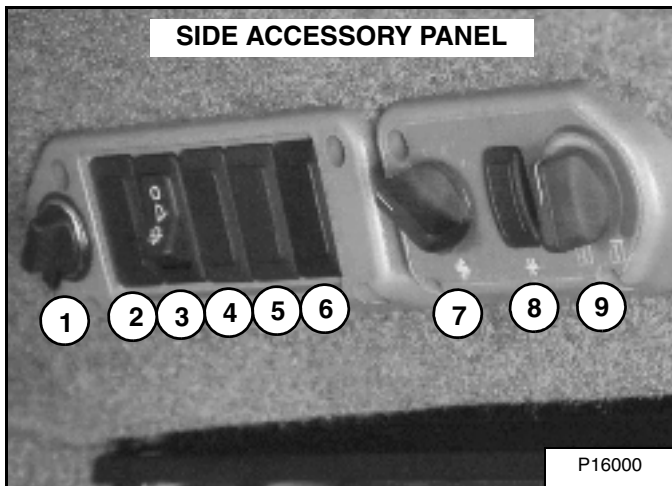

Side Accessory Panel [Figure 11]

REF. NO.	DESCRIPTION	FUNCTION / OPERATION
1	POWER PLUG	Provides a 12 V receptacle for accessories.
2	NOT USED	- - -
3	FRONT WIPER	Press the top of the switch to start the front wiper (press and hold for washer fluid). Press the bottom of the switch to stop the wiper.
4	REAR WIPER	Press the bottom of the switch to start the rear wiper. Press the top of the switch to provide washer fluid to clean the rear window.
5	NOT USED	- - -
6	NOT USED	- - -
7	FAN MOTOR	Turn clockwise to increase fan speed; counterclockwise to decrease. There are four positions; OFF-1-2-3.
8	AIR COND. SWITCH	Press top of switch to start; bottom to stop. Fan Motor (7) must be ON for A/C to operate.
9	TEMP. CONTROL	Turn clockwise to increase the temperature; counterclockwise to decrease.

Figure 12

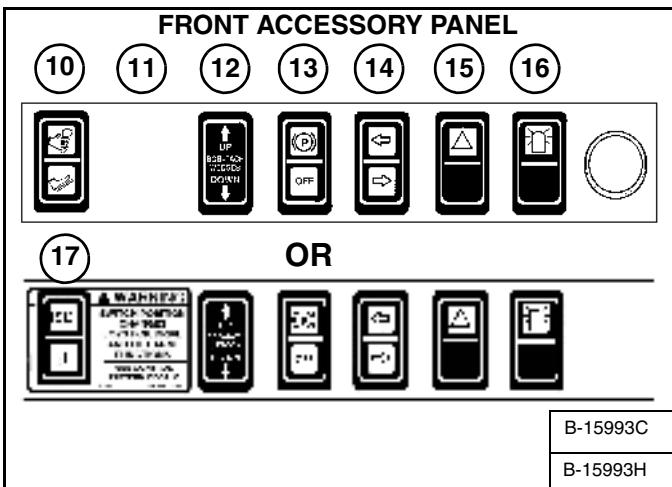

NOTE: Parking Brake (13) [Figure 12] is Standard on all loaders.

Front Accessory Panel [Figure 12]

REF. NO.	DESCRIPTION	FUNCTION / OPERATION
10	ADVANCED CONTROL SYSTEM (ACS)	Press the top to select Hand Controls; bottom to select Foot Controls.
11	NOT USED	- - -
12	POWER BOB-TACH	Press and hold the up arrow to disengage the Bob-Tach wedges. Press and hold the down arrow to engage the wedges into the mounting frame holes.
13	PARKING BRAKE (Standard on all Loaders)	Press the top to engage the PARKING BRAKE; bottom to disengage.
14	TURN SIGNAL INDICATORS	Indicates left or right TURN SIGNALS are ON.
15	HAZARD LIGHTS	Press the top to turn the HAZARD LIGHTS ON; right side bottom to turn OFF.
16	ROTATING BEACON	Press the top to turn the ROTATING BEACON ON; bottom to turn OFF.
17	SELECTABLE JOYSTICK CONTROL (SJC)	Press the top to select 'ISO' Control Pattern; bottom to select 'H' Control Pattern.

SEAT BAR RESTRAINT SYSTEM

Operation

Figure 13

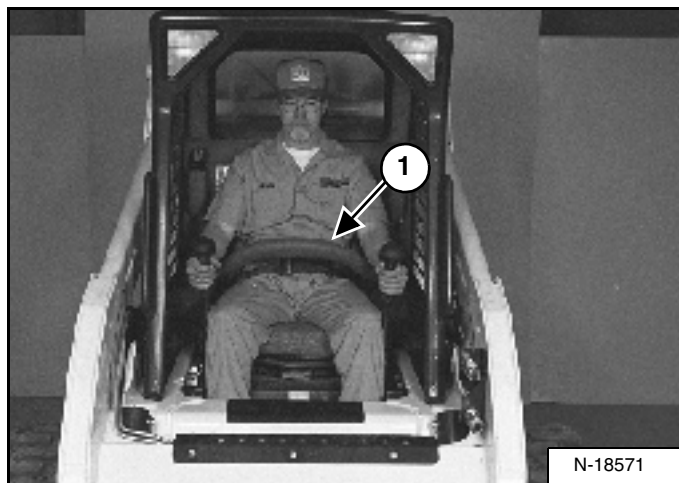

The seat bar restraint system has a pivoting seat bar with arm rests (1) [Figure 13].

The operator controls the use of the seat bar. The seat bar in the down position helps to keep the operator in the seat.

WARNING

AVOID INJURY OR DEATH

When operating the machine:

- Keep the seat belt fastened snugly.
- The seat bar must be lowered.
- Keep your feet on the pedal controls or footrests and hands on steering levers.

W-2261-0799

When the seat bar is down, PRESS TO OPERATE LOADER Button is activated, and the brake pedal is released, the lift, tilt, and traction drive functions can be operated. (Traction drive will operate only when the engine is running.)

When, the seat bar is up, the lift, tilt, and traction drive functions are deactivated and both foot pedals (if equipped) will be locked when returned to neutral position.

WARNING

Before you leave the operator's seat:

- Lower the lift arms, put the attachment flat on the ground.
- Stop the engine.
- Engage the parking brake.
- Raise seat bar.
- (Foot Pedal Controls) Move pedals until both lock.
- (Advanced Control system - ACS) Move the hydraulic controls to the NEUTRAL POSITION to make sure that both lift and tilt functions are deactivated.
The seat bar system must deactivate the lift and tilt control functions when the seat bar is up. Service the system if hand controls do not deactivate.
- (Selectable Joystick Controls - SJC) Move the joysticks to the NEUTRAL POSITION to make sure that travel and hydraulic functions are deactivated.
The seat bar system must deactivate these functions when the seat bar is up. Service the system if controls do not deactivate.

W-2463-0603

BOBCAT INTERLOCK CONTROL SYSTEM (BICS)

Operation



AVOID INJURY OR DEATH

The Bobcat Interlock Control System (BICS) must deactivate the lift, tilt and traction drive functions. If it does not, contact your dealer for service. **DO NOT** modify the system.

W-2151-0394

Figure 14



The Bobcat Interlock Control System (BICS) has a pivoting seat bar with arm rests (1) [Figure 14].

The operator controls the use of the seat bar. The seat bar in the down position helps to keep the operator in the seat.

The BICS requires the operator to be seated in the operating position with the Seat Bar (1) [Figure 14] fully lowered before the lift, tilt, auxiliary hydraulics, and traction functions can be operated. The seat belt must be fastened anytime you operate the machine.



AVOID INJURY OR DEATH

When operating the machine:

- Keep the seat belt fastened snugly.
- The seat bar must be lowered.
- Keep your feet on the pedal controls or footrests and hands on steering levers.

W-2261-0799

Figure 15

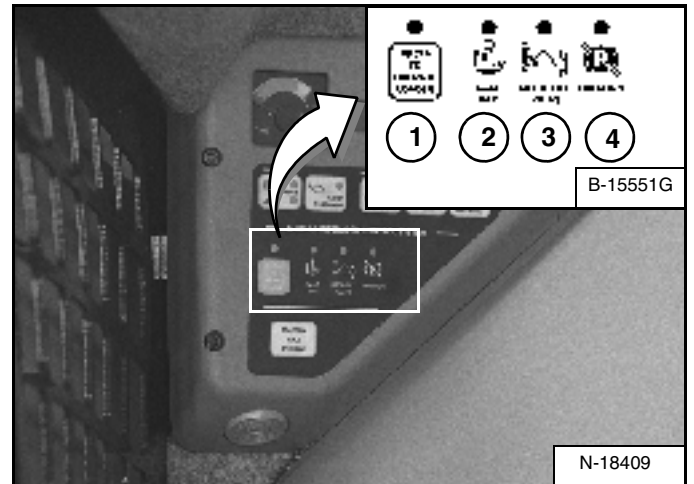

There are display lights (1, 2, 3, and 4) [Figure 15] located on the left instrument panel that must be ON to operate the machine.

When the seat bar is down, PRESS TO OPERATE LOADER Button is activated, and the parking brake is released, the lift, tilt, auxiliary hydraulics, and traction drive functions can be operated.

When, the seat bar is up, the lift, tilt, auxiliary hydraulics, and traction drive functions are deactivated.



Before you leave the operator's seat:

- Lower the lift arms, put the attachment flat on the ground.
- Stop the engine.
- Engage the parking brake.
- Raise seat bar.
- (Foot Pedal Controls) Move pedals until both lock.
- (Advanced Control system - ACS) Move the hydraulic controls to the NEUTRAL POSITION to make sure that both lift and tilt functions are deactivated.
- (Selectable Joystick Controls - SJC) Move the joysticks to the NEUTRAL POSITION to make sure that travel and hydraulic functions are deactivated.

The seat bar system must deactivate the lift and tilt control functions when the seat bar is up. Service the system if hand controls do not deactivate.

The seat bar system must deactivate these functions when the seat bar is up. Service the system if controls do not deactivate.

W-2463-0603

LIFT ARM BY-PASS CONTROL

Operation

Figure 16

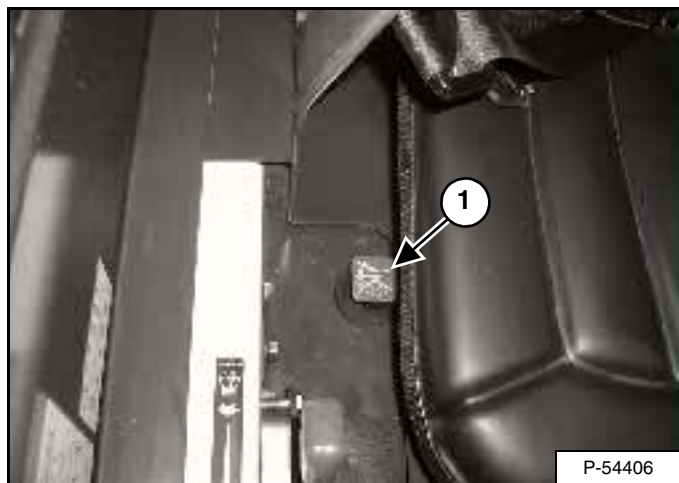

The lift arm by-pass control (1) [Figure 16] is used to lower the lift arms if the lift arms cannot be lowered during normal operations.

- Sit in the operator's seat.
- Fasten the seat belt and lower the seat bar.
- Turn the knob (1) [Figure 16] clockwise 1/4 turn.
- Pull up and hold the knob until the lift arms slowly lower.

TRACTION LOCK OVERRIDE

Operation

Figure 17

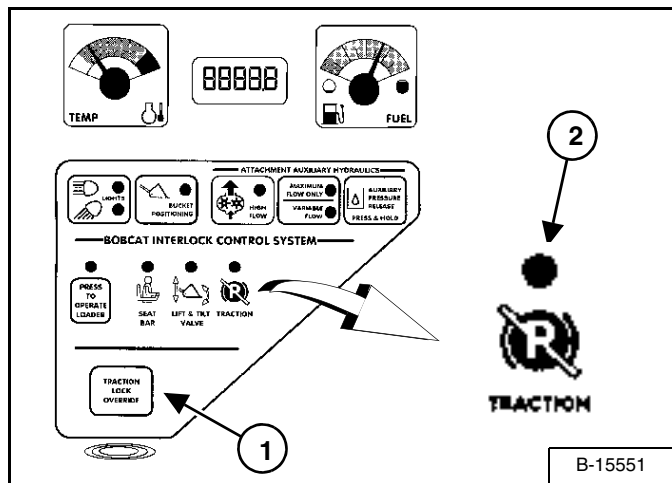

(Functions Only When The Seat Bar Is Raised And The Engine Is Running) There is a TRACTION LOCK OVERRIDE Button (1) [Figure 17] on the left instrument panel which will allow you to use the steering levers to move the loader forward & backward when using the backhoe attachment or for loader service.

- Press the TRACTION LOCK OVERRIDE Button once to unlock traction drive. The TRACTION light (2) [Figure 17] will be ON.
- Press the button a second time to lock the traction drive. The TRACTION light (2) [Figure 17] will be OFF.

NOTE: The TRACTION LOCK OVERRIDE Button will unlock the traction drive when seat bar is raised and the engine is running.

The TRACTION LOCK OVERRIDE Button will function if brake pedal is in the engaged or disengaged position and the engine is running.

ENGINE SPEED CONTROL

Operation

Figure 18

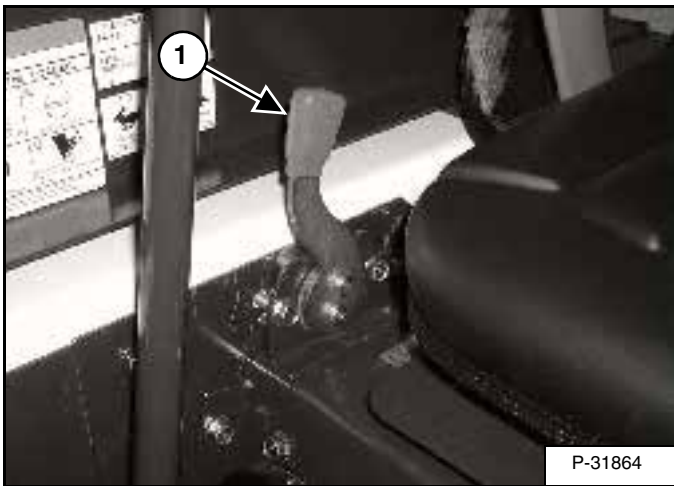

The speed control lever is at the right side of the operator's seat (1) [Figure 18].

Move the lever forward to increase engine speed. Move backward to decrease engine speed.

PARKING BRAKE

Operation

Figure 19

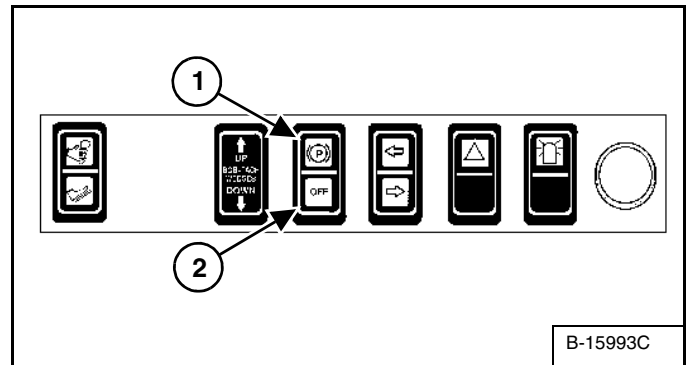

Press the top of the switch (1) [Figure 19] to engage the parking brake. The traction drive system will be locked.

Press the bottom of the switch (2) [Figure 19] to disengage the parking brake. The traction drive system will be unlocked.

NOTE: The TRACTION light on the left instrument panel will remain OFF until the engine is started, the PRESS TO OPERATE LOADER button is pressed and the parking brake is disengaged.

DRIVING AND STEERING THE LOADER

Available Controls Configurations

The loader has three configurations available:

- *Standard Controls* - Two Levers control drive and steering functions.
- *Advanced Control System (ACS) (Optional or Field Accessory)* - Two Levers control drive and steering functions.
- *Selectable Joystick Controls (SJC) (Option)* - (*'ISO' Pattern*) Left joystick controls the drive and steering functions. (*'H' Pattern*) Left and right joysticks control left and right side drive and steering functions.

Operation (Standard and ACS)

Figure 20

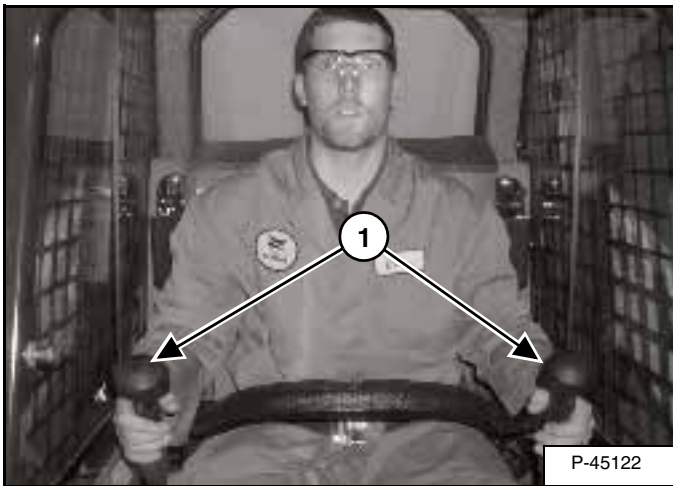

The control levers (1) [Figure 20] are on the left and right side in front of the seat.

Move levers smoothly. Avoid sudden starting and stopping.

Figure 21

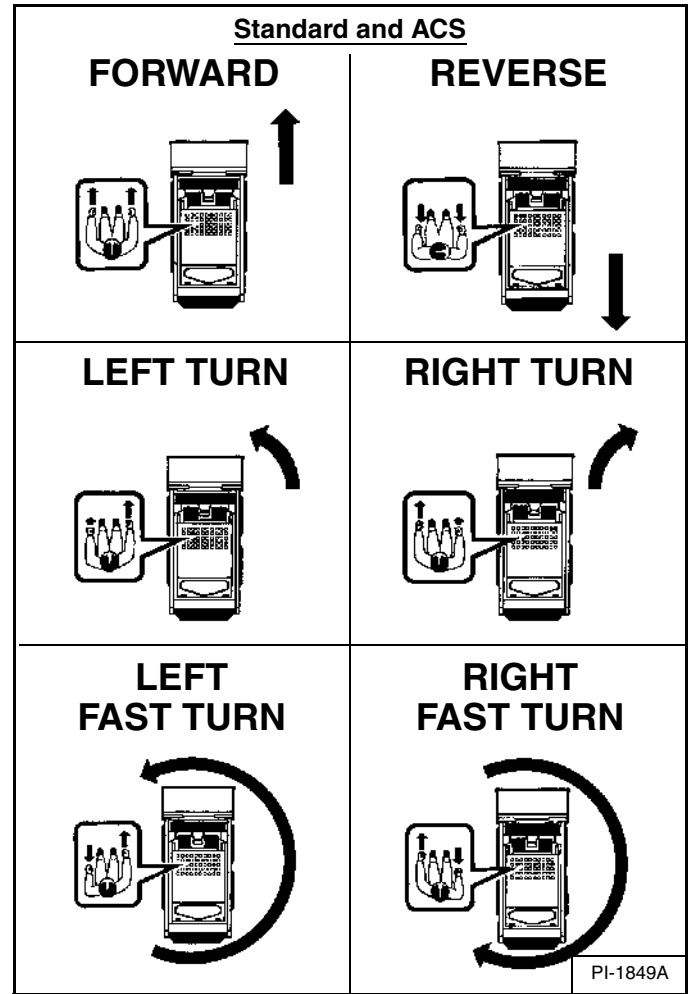

The steering levers control forward and reverse travel and turning the loader [Figure 21].

Forward Travel - Push both levers forward.

Reverse Travel - Pull both levers backward.

Normal Turning - Move one lever farther forward than the other.

Fast Turning - Push one lever forward and pull the other lever backward.

! WARNING

AVOID INJURY OR DEATH

When operating the machine:

- Keep the seat belt fastened snugly.
- The seat bar must be lowered.
- Keep your feet on the pedal controls or footrests and hands on steering levers.

W-2261-0799

DRIVING AND STEERING THE LOADER (CONT'D)

Operation (SJC) In 'H' Control Pattern

Figure 22

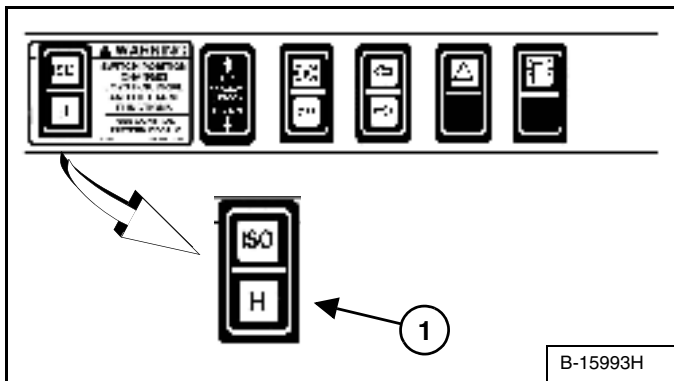

Select the 'H' control pattern by pressing the bottom of the switch (1) [Figure 22].



AVOID INJURY OR DEATH

When operating the machine:

- Keep the seat belt fastened snugly.
- The seat bar must be lowered.
- Keep your feet on the foot rests and hands on control levers.

W-2399-0501

Figure 23

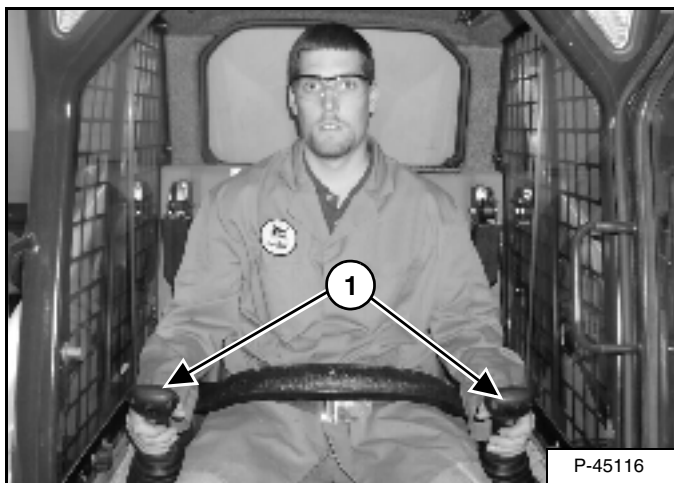

Both joysticks control drive and steering and are located on the right and left side in front of the seat (1) [Figure 23].

Move the joysticks smoothly. Avoid sudden starting and stopping.

Figure 24

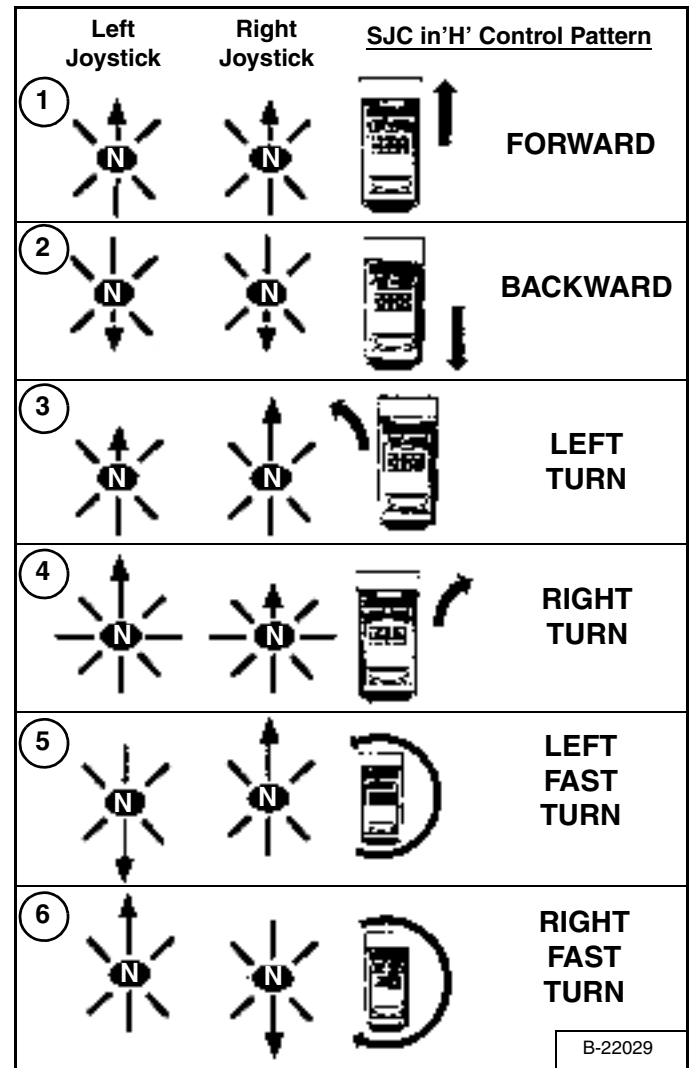

Hand Control Functions (Drive and Steering) [Figure 24]

1. **Forward Travel** - Move both joysticks forward.
2. **Backward Travel** - Move both joysticks backward.
3. **Forward Left Turn** - Move the right joystick farther forward than the left joystick.
4. **Forward Right Turn** - Move the left joystick farther forward than the right joystick.
5. **Left Fast Turn** - Move the left joystick backward and the right joystick forward.
6. **Right Fast Turn** - Move the left joystick forward and the right joystick backward.

DRIVING AND STEERING THE LOADER (CONT'D)

Operation (SJC) In 'ISO' Control Pattern

Figure 25

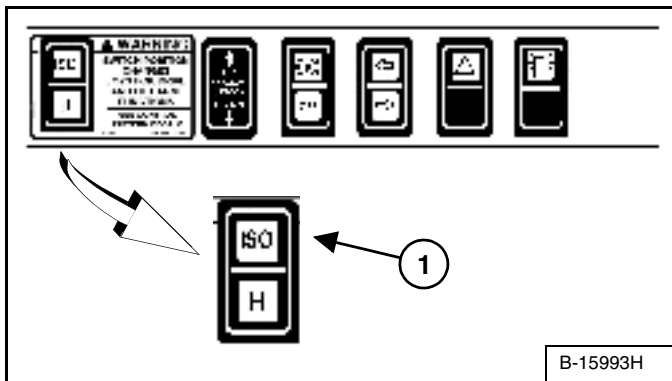

Select the 'ISO' control pattern by pressing the top of the switch (1) [Figure 25].



AVOID INJURY OR DEATH

When operating the machine:

- Keep the seat belt fastened snugly.
- The seat bar must be lowered.
- Keep your feet on the foot rests and hands on control levers.

W-2399-0501

Figure 26

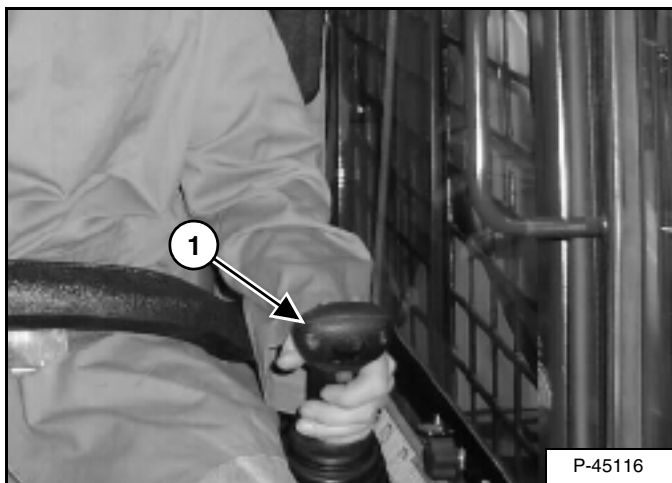

The joystick which controls drive and steering is on the left side in front of the seat (1) [Figure 26].

Move the joystick smoothly. Avoid sudden starting and stopping.

Figure 27

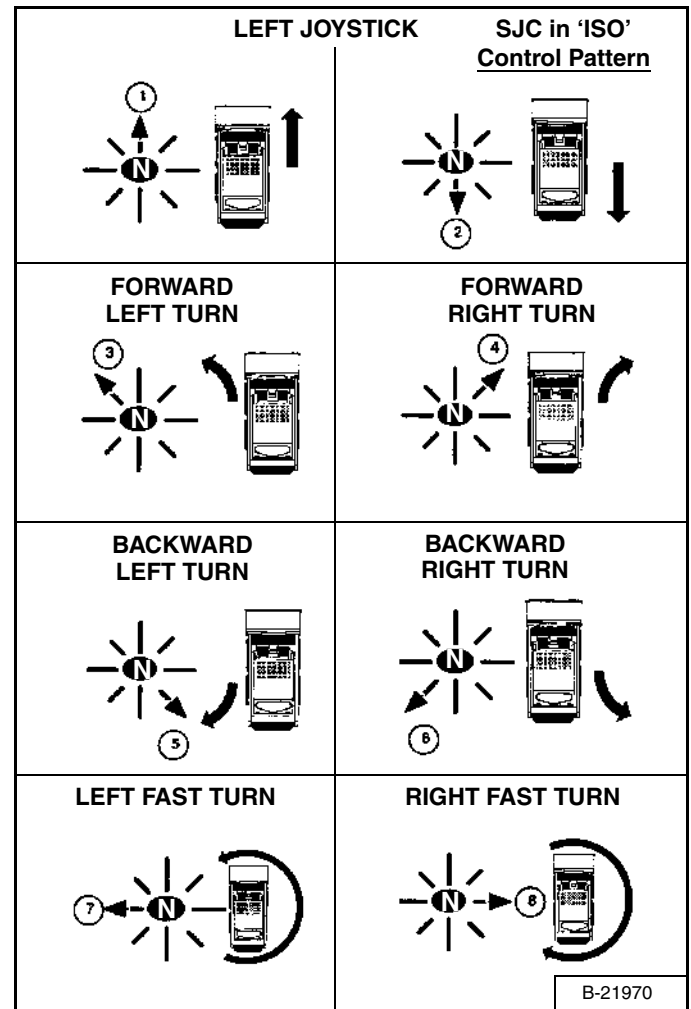

Left Joystick Functions (Drive and Steering) [Figure 27]

Move the joystick smoothly. Avoid sudden starting and stopping.

1. **Forward Travel** - Move joystick forward.
2. **Backward Travel** - Move joystick backward.
3. **Forward Left Turn** - Move joystick forward and to the left.
4. **Forward Right Turn** - Move joystick forward and to the right.
5. **Backward Left Turn** - Move joystick backward and to the right.
6. **Backward Right Turn** - Move joystick backward and to the left.
7. **Left Fast Turn** - Move joystick to the left.
8. **Right Fast Turn** - Move joystick to the right.

STOPPING THE LOADER

Using The Control Levers Or Joysticks

When the levers or joysticks are moved to the neutral position, the hydrostatic transmission will act as a *service brake* to stop the loader.

SPEED MANAGEMENT (SJC OPTION)

Operation

Speed Management allows the loader to be maneuvered at slow travel speed for installing attachments, loading or unloading, and work applications such as trenching, tilling and landscaping.

Figure 28

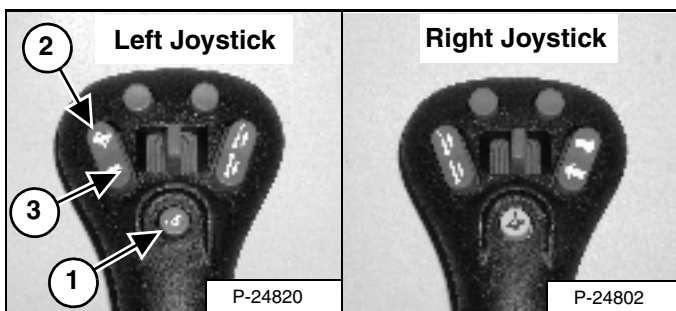

Press the button (1) [Figure 28] on the left joystick once to engage Speed Management.

Figure 29

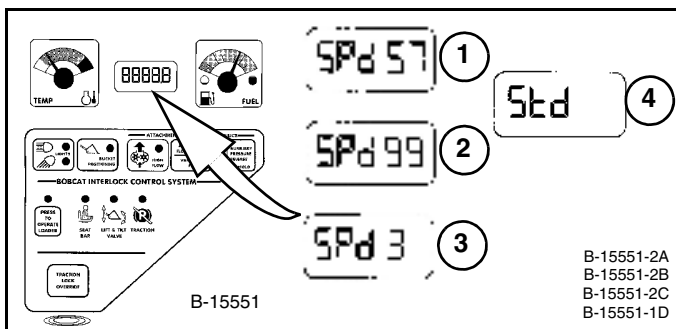

When Speed Management is engaged, the machine will travel at 57% of Standard travel speed and the percentage [SPd 57] will appear in the display (1) [Figure 29].

While Speed Management is engaged, press the top of the Speed Control switch (2) [Figure 28] to increase the speed up to 99% [SPd 99] or the bottom of the switch (3) [Figure 28] to decrease the speed down to 3% [SPd 3]. The percentages will appear in the display (1, 2 and 3) [Figure 29].

Press button (1) [Figure 28] again to disengage Speed Management and return to Standard Travel Speed [Std] (4) [Figure 29] will appear in display.)

NOTE: Early model loaders will show Sml in the display [Figure 29] instead of SPd.

The system will retain the speed percentage as long as the key remains ON (Key Switch Panel) or the STOP button has not been pressed (Keyless Panel).

EXAMPLE: You can be using the machine at 40% and then disengage Speed Management to reposition the loader, then re-engage Speed Management. The speed percentage will still be at 40%.

EXAMPLE: If you turn the key OFF or press the STOP button, the next time you start the engine and engage Speed Management, the speed will be at 57% of Standard Travel Speed. Press button (1) [Figure 28] to resume Speed Management Operation.

HYDRAULIC CONTROLS

Description

Two foot pedals (or optional hand controls) control the hydraulic cylinders for the lift and tilt functions.

Put your feet on the pedals (or footrests) and **KEEP THEM THERE** any time you operate the loader.

Standard Controls (Also ACS In FOOT Pedal Mode)

Figure 30

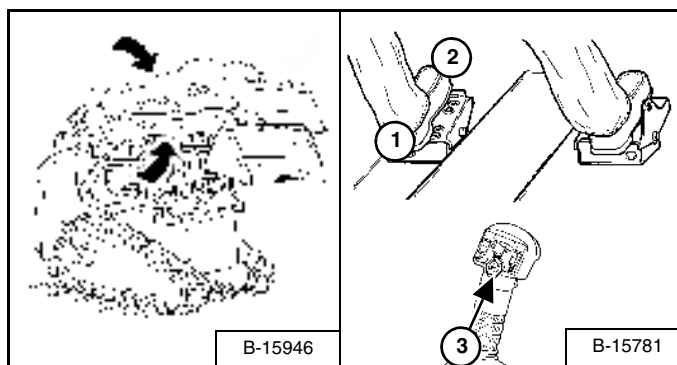

Lift Arm Operation - (Left Pedal)

Push the heel (1) **[Figure 30]** of the pedal to raise the lift arms.

Push the toe (2) **[Figure 30]** of the pedal to lower the lift arms.

Lift Arm Float Position Operation - (Left Pedal)

Push the toe (2) **[Figure 30]** of the pedal all the way forward until it locks into the float position.

Use the float position of the lift arms to level loose material while driving backward.

Raise the lift arms to disengage the float position.

Lift Arm Float Position (With ACS) - (Left Pedal)

Press and hold the Float button (3) **[Figure 30]**.

Push the toe (2) **[Figure 30]** of the pedal forward to lower the lift arms. Then release the float button.

Use the float position of the lift arms to level loose material while driving backward.

Raise the lift arms to disengage the float position.

Figure 31

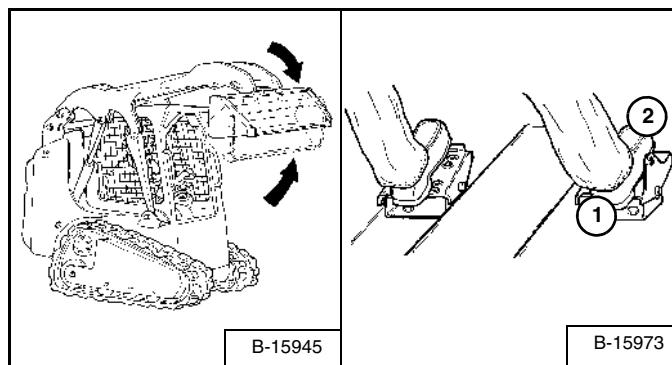

Tilt Operation - (Right Pedal)

Push the heel (1) **[Figure 31]** of the pedal to tilt the bucket backward.

Push the toe (2) **[Figure 31]** of the pedal to tilt the bucket forward.

HYDRAULIC CONTROLS (CONT'D)

Advanced Control System (ACS) In HAND Control Mode

Figure 32

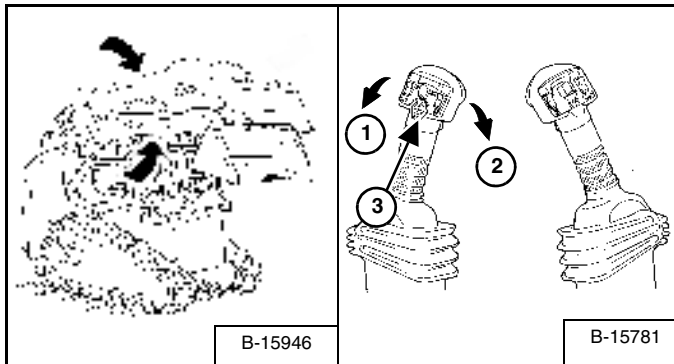

Lift Arm Operation - (Left Hand Lever)

Move the lever outward (1) [Figure 32] to raise the lift arms.

Move the lever inward (2) [Figure 32] to lower the lift arms.

Lift Arm Float Position - (Left Hand Lever)

Press and hold the Float Button (3) [Figure 32] while the lever is in neutral. Move the lever to lift arm down position (2) [Figure 32], then release the button.

Press Float Button (3) again or move the lever to lift arm up position (1) [Figure 32].

Use the float position of the lift arms to level loose material while driving backward.

Figure 33

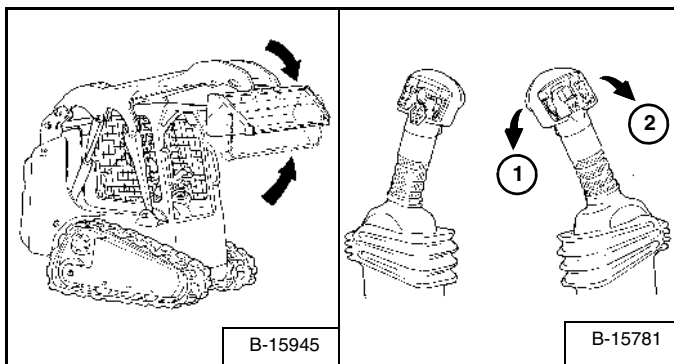

Tilt Operation - (Right Hand Lever)

Move the lever inward (1) [Figure 33] to tilt the bucket backward.

Move the lever outward (2) [Figure 33] to tilt the bucket forward.

Selectable Joystick Control (SJC) In 'H' Control Pattern

Figure 34

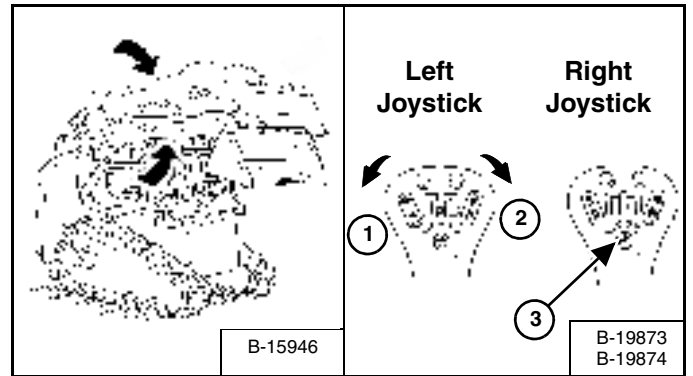

Lift Arm Operation - (Left Hand Joystick)

Move the joystick outward (1) [Figure 34] to raise the lift arms.

Move the joystick inward (2) [Figure 34] to lower the lift arms.

Lift Arm Float Position - (Left & Right Hand Joysticks)

Press and hold the Float Button (3) [Figure 34] while the joysticks are in neutral. Move the left joystick to lift arm down position (2) [Figure 34], then release the button.

Press Float Button (3) again or move the left joystick to lift arm up position (1) [Figure 34] to disengage.

Use the float position of the lift arms to level loose material while driving backward.

Figure 35

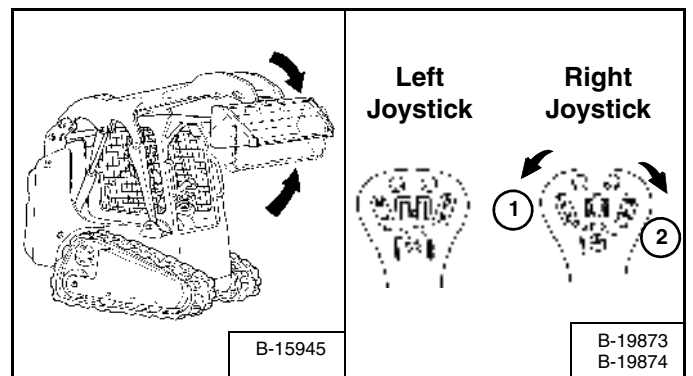

Tilt Operation - (Right Hand Joystick)

Move the joystick inward (1) [Figure 35] to tilt the bucket backward.

Move the joystick outward (2) [Figure 35] to tilt the bucket forward.

HYDRAULIC CONTROLS (CONT'D)

Selectable Joystick Control (SJC) In 'ISO' Control Pattern

Figure 36

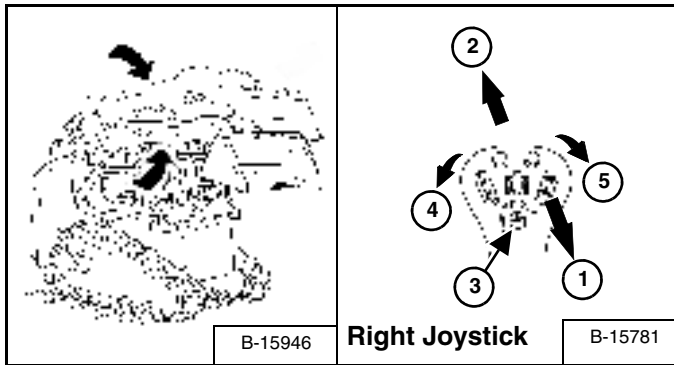

Lift Arm Operation - (Right Hand Joystick)

Move the joystick backward (1) [Figure 36] to raise the lift arms.

Move the joystick forward (2) [Figure 36] to lower the lift arms.

Lift Arm Float Position - (Right Hand Joystick)

Press and hold the Float Button (3) [Figure 36] while the joystick is in neutral. Move the joystick to lift arm down position (2) [Figure 36], then release the button.

Press Float Button (3) again or move the joystick to lift arm up position (1) [Figure 36] to disengage.

Use the float position of the lift arms to level loose material while driving backward.

Figure 37

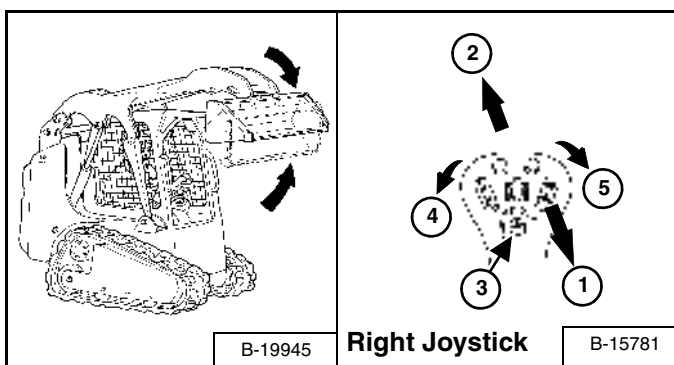

Tilt Operation - (Right Hand Joystick)

Move the joystick inward (4) [Figure 37] to tilt the bucket backward.

Move the joystick outward (5) [Figure 37] to tilt the bucket forward.

Bucket Position Valve Operation (If Equipped)

The function of the bucket position valve is to keep the bucket in the same approximate position it is in before you begin raising the lift arms.

Figure 38

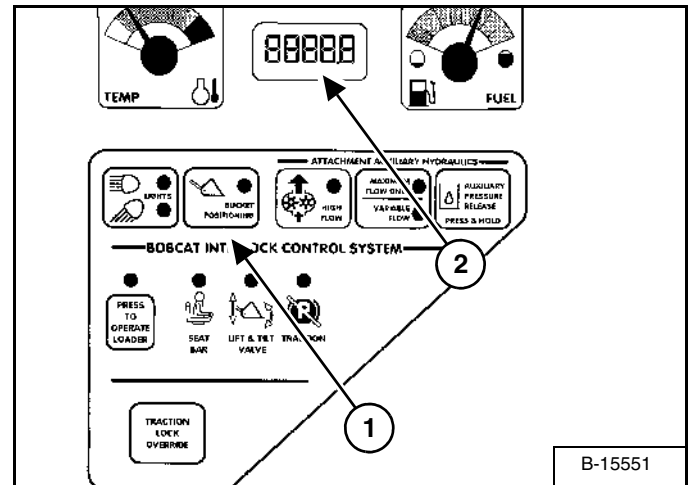

Press BUCKET POSITIONING button (1) [Figure 38] to engage the bucket position function. (The light will be on.) Press again to disengage.

Bucket Positioning functions only during upward lift cycle.

If the Bucket Positioning button is pressed and held for 2 seconds, the Warning and Shutdown status will be displayed (2) [Figure 38]. (See SHUTDOWN FEATURE on Page 118.)

HYDRAULIC CONTROLS (CONT'D)

Auxiliary Hydraulics Operation (VARIABLE FLOW)

Figure 39

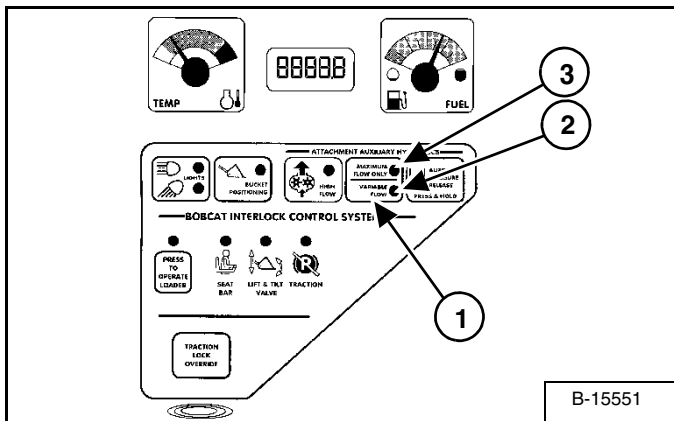
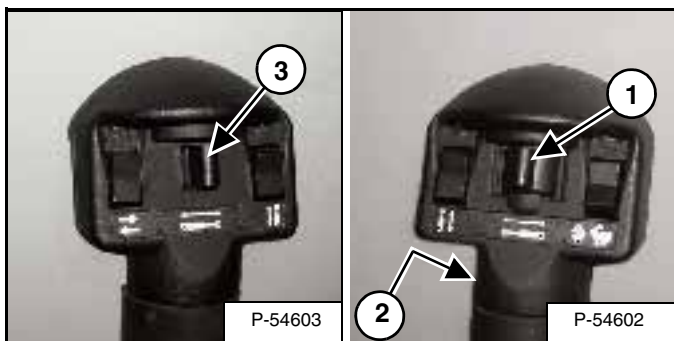

Figure 40



VARIABLE FLOW allows for slow-to-fast movement of auxiliary functions. If you move the auxiliary switch (1) [Figure 40] half-way, the auxiliary functions move at approximately one-half speed.

Press the auxiliary hydraulics button (1) [Figure 39] once.

The light (2) [Figure 39] will be ON.

To disengage, press the auxiliary hydraulics button (1) [Figure 39] two more times.

Both lights (2 and 3) [Figure 39] will be OFF.

NOTE: When the operator is seated and raises the seat bar, the Auxiliary Hydraulic System (Front and Rear) will deactivate.

Auxiliary Hydraulics Operation (MAXIMUM FLOW ONLY)

MAXIMUM FLOW ONLY allows for fast movement only. If you move the auxiliary switch (1 or 3) [Figure 40], the auxiliary functions move at fast speed; release the switch to stop auxiliary functions.

Press the auxiliary hydraulics button (1) [Figure 39] two times.

The light (3) [Figure 39] will be ON.

To disengage, press the auxiliary hydraulics button (1) [Figure 39] again.

Both lights (2 and 3) [Figure 39] will be OFF.

NOTE: When the operator is seated and raises the seat bar, the Auxiliary Hydraulic System (Front and Rear) will deactivate.

FRONT Auxiliary Hydraulics Operation (VARIABLE FLOW)

Figure 41

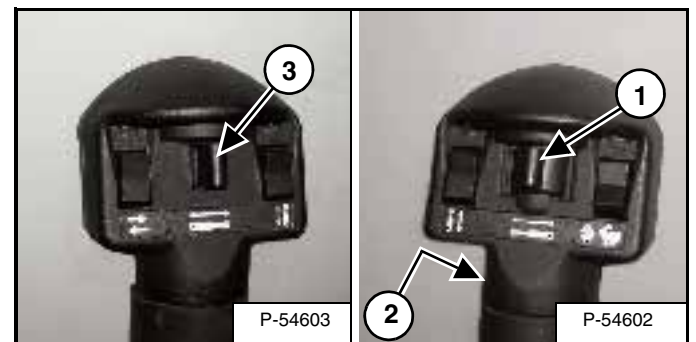

Press the auxiliary hydraulics button for *VARIABLE FLOW*.

Push the switch (1) [Figure 41] to the right or left to change the fluid flow direction of the front quick couplers. (EXAMPLE: Open and close grapple teeth.)

FRONT Auxiliary Hydraulics Operation (MAXIMUM FLOW)

Press the auxiliary hydraulics button for *MAXIMUM FLOW*.

Push the switch (1) [Figure 41] to the right or left to change the fluid flow direction of the front quick couplers. (EXAMPLE: Open and close grapple teeth.)

Press again to disengage.

HYDRAULIC CONTROLS (CONT'D)

FRONT Auxiliary Hydraulics Operation (CONTINUOUS FLOW)

After selecting VARIABLE or MAXIMUM FLOW, press the front switch (2) [Figure 40] to give the front quick couplers a constant flow of fluid with the female coupler being pressurized. (EXAMPLE: Operate a backhoe.)

REVERSE CONTINUOUS FLOW - To set reverse flow (male coupler pressurized), select VARIABLE or MAXIMUM FLOW, then, while holding the auxiliary switch (1) [Figure 40] to the left, press the front switch (2) [Figure 40]. Reverse flow can be used only with augers, power rakes, sweepers, tillers, and vibratory rollers.

To release from continuous operation, press the front switch (2) [Figure 40] a second time.

REAR Auxiliary Hydraulics Operation (If Equipped)

Figure 42



The switches on the left hand lever control the rear auxiliary hydraulics.

Press the auxiliary hydraulics button for MAXIMUM FLOW.

Push the switch (3) [Figure 41] to the right or left to change the fluid flow direction to rear quick couplers [Figure 42]. (EXAMPLE: Raise and lower rear stabilizers.)

Quick Couplers

WARNING

Diesel fuel or hydraulic fluid under pressure can penetrate skin or eyes, causing serious injury or death. Fluid leaks under pressure may not be visible. Use a piece of cardboard or wood to find leaks. Do not use your bare hand. Wear safety goggles. If fluid enters skin or eyes, get immediate medical attention from a physician familiar with this injury.

W-2072-0496

Figure 43

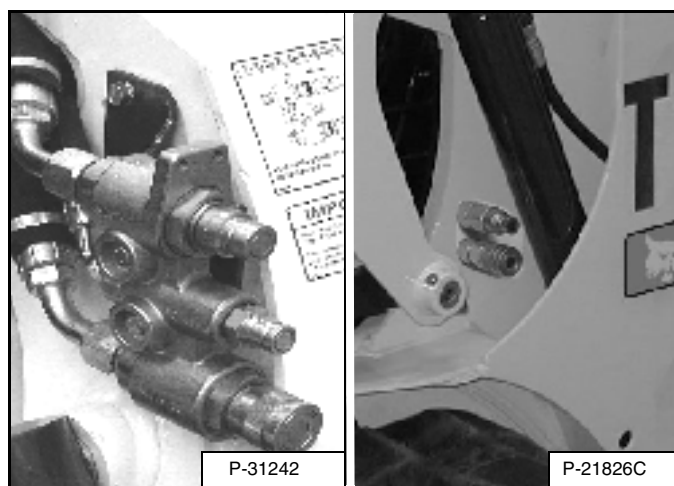

To Connect: Remove dirt or debris from the surface of both the male and female couplers, and from the outside diameter of the male coupler. Visually check the couplers for corroding, cracking, damage or excessive wear. If any of these conditions exist, the coupler(s) [Figure 43] must be replaced.

Install the male coupler into the female coupler. Full connection is made when the ball release sleeve slides forward on the female coupler.

To Disconnect: Hold the male coupler. Retract the sleeve on the female coupler until the couplers disconnect.

HYDRAULIC CONTROLS (CONT'D)

Relieve Hydraulic Pressure (Loader And Attachment)



AVOID BURNS

Hydraulic fluid, tubes, fittings and quick couplers can get hot when running machine and attachments. Be careful when connecting and disconnecting quick couplers.

W-2220-0396

Front Auxiliary Quick Couplers

When Connecting: Push the quick couplers tightly together and hold for five seconds; the pressure is automatically released as the couplers are installed.

When Disconnecting: Push the quick couplers tightly together and hold for five seconds; then retract the sleeve until the couplers disconnect.

Rear Auxiliary Quick Couplers

Figure 44

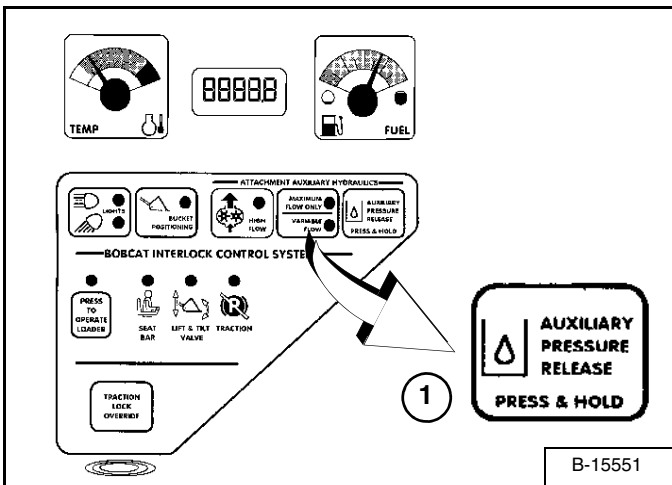

Press the AUXILIARY PRESSURE RELEASE Button (1) [Figure 44]. Hold it for two seconds after the engine comes to a complete stop. The pressure will be released.

High-Flow Hydraulics Operation (If Equipped)

Figure 45

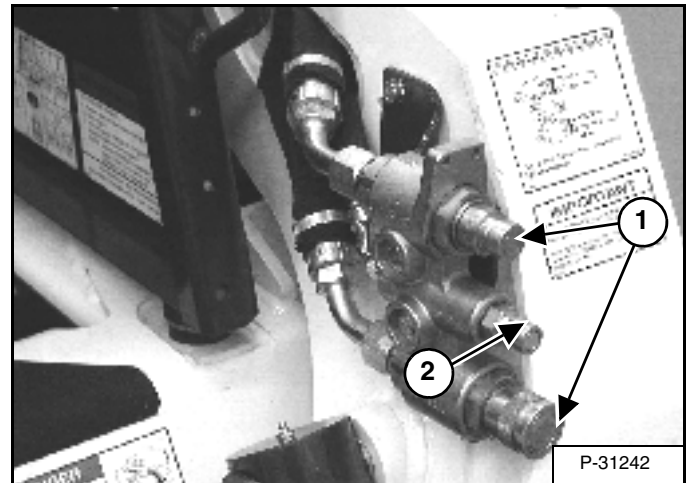

The High-Flow function provides additional flow to the system to operate an attachment which requires more hydraulic flow (EXAMPLE: Planer).

Connect the attachment to the quick couplers (1) [Figure 45].

Some attachments may have a case drain which needs to be connected to the small quick coupler (2) [Figure 45].

Figure 46

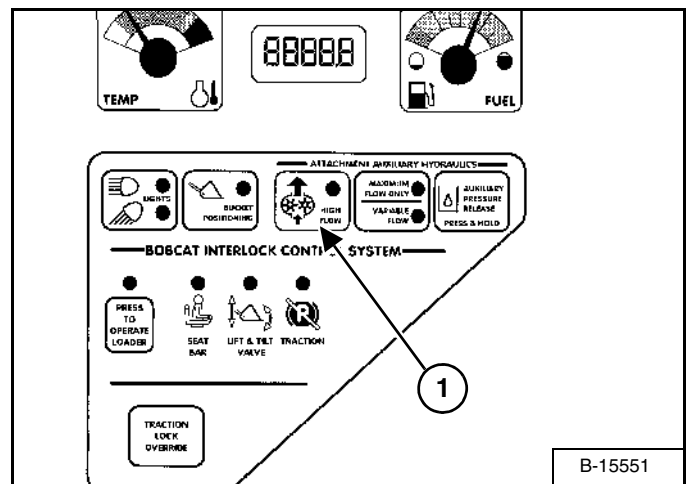

Press the HIGH FLOW button (1) [Figure 46].

Press a second time to disengage.

HYDRAULIC CONTROLS (CONT'D)

High-Flow Hydraulics Operation (If Equipped) (Cont'd)

Figure 47

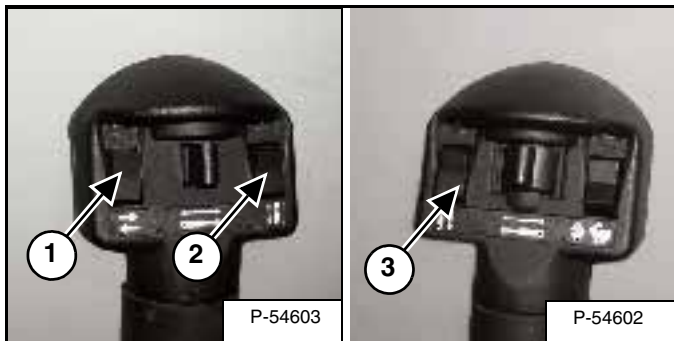

You can use additional switches (1, 2 and 3) [Figure 47] on the right and left control handles for functions which control some attachments.

See the appropriate Attachment Operation & Maintenance Manual for control details.

Attachment Control Device (ACD) (If Equipped)

Figure 48

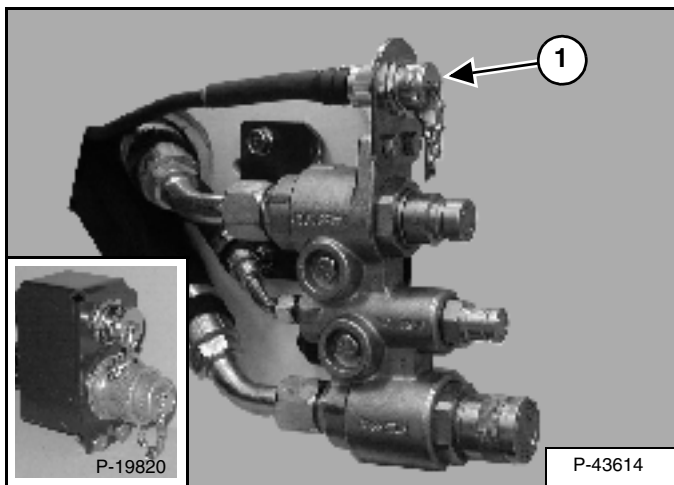

You will need the Dual-Connector (7-pin / 14-pin) kit (1) [Figure 48] to operate early model attachments. See your Bobcat Loader dealer.

Secondary Front Auxiliary Hydraulics (If Equipped)

Figure 49

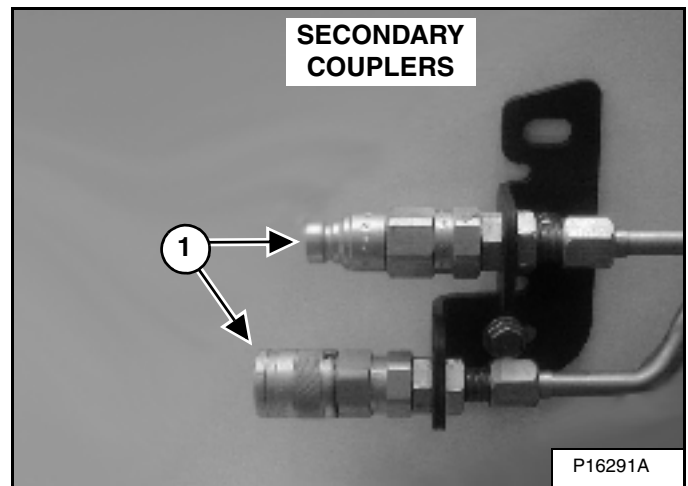

The secondary front auxiliary quick couplers (1) [Figure 49] are available as a Field Installed Accessory. These are used when there is a need for additional auxiliary hydraulics (EXAMPLE: Planer side shift).

Connect the attachment to the secondary auxiliary hydraulics (1) [Figure 49].

Set the Auxiliary Hydraulic Button for *Variable Flow* or *Maximum Flow Only*. (See Auxiliary Hydraulics Operation (VARIABLE FLOW) on Page 21) or (See Auxiliary Hydraulics Operation (MAXIMUM FLOW ONLY) on Page 21).

Figure 50

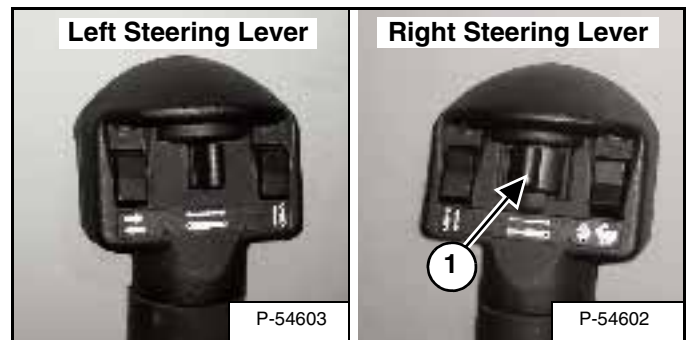

Push switch (1) [Figure 50] to the right or left to change fluid flow direction. (EXAMPLE: Side shift on the Planer.)

NOTE: The secondary front auxiliary hydraulics and the rear auxiliary hydraulics operate from the same auxiliary section of the control valve. To operate only one of these auxiliary functions, disconnect the other.

DAILY INSPECTION (CONT'D)

Daily Inspection And Maintenance

Maintenance work must be done at regular intervals. Failure to do so will result in excessive wear and early failures. The Service Schedule [Figure 51] is a guide for correct maintenance of the Bobcat Loader. It is located inside the rear door of the loader and also in this manual.

- Engine Oil Level
- Hydraulic / Hydrostatic Fluid Level
- Engine Air Filter, Check Air System for Damage or Leaks
- Engine Coolant Level, Check System for Damage or Leaks
- Operator Cab and Cab Mounting Hardware
- Seat Belt
- Seat Bar and Control Interlocks
- Grease Pivot Pins (Lift Arms, Bob-Tach, Cylinders, Bob-Tach Wedges)
- Tracks, Check for Wear or Damage
- Fuel Filter, Remove Trapped Water
- Loose or Broken Parts, Repair or Replace as necessary
- Safety Treads and Safety Signs (Decals), Replace as necessary
- Lift Arm Support Device. Replace if Damaged
- Bobcat Interlock Control System (BICS)

WARNING

Operator must have instructions before operating the machine. Untrained operators can cause injury or death.

W-2001-0502

NOTE: Fluids such as engine oil, hydraulic fluid, coolant, etc. must be disposed of in an environmentally safe manner. Some regulations require that certain spills and leaks on the ground must be cleaned in a specific manner. See local, state and federal regulations for correct disposal.

IMPORTANT

PRESSURE WASHING DECALS

- **Never direct the stream at a low angle toward the decal that could damage the decal causing it to peel from the surface.**
- **Direct the stream at a 90 degree angle and at least 300 mm from the decal. Wash from the center of the decal toward the edges.**

I-2226-0104

PRE-STARTING PROCEDURE

Entering The Loader

Figure 52

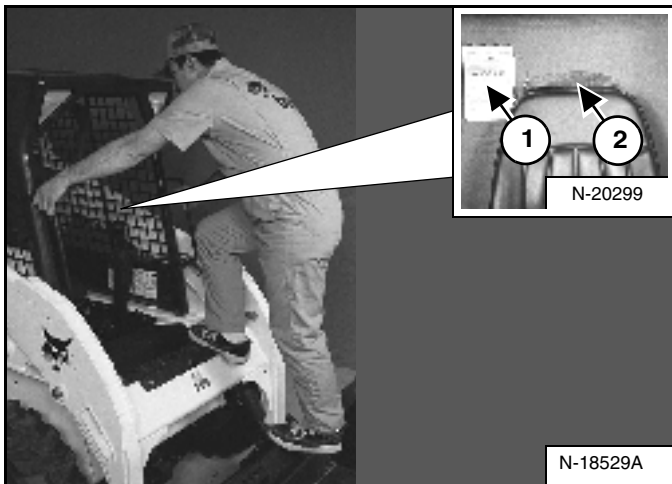

Use the bucket or attachment steps, grab handles and safety treads (on top of the loader lift arms and frame) to get on and off the loader [Figure 52]. Do not jump.

Safety treads are installed on the Bobcat Loader to provide a slip resistant surface for getting on and off the loader.

Keep safety treads clean and replace when damaged. Replacement treads are available from your Bobcat Loader dealer.

Read and understand the Operation & Maintenance Manual and the Operator's Handbook (1) [Figure 52] before operating the loader.

The Operation & Maintenance Manual and other manuals can be kept in a container (2) [Figure 52] provided behind the operator seat.

WARNING

Instructions are necessary before operating or servicing machine. Read and understand the Operation & Maintenance Manual, Operator's Handbook and signs (decals) on machine. Follow warnings and instructions in the manuals when making repairs, adjustments or servicing. Check for correct function after adjustments, repairs or service. Untrained operators and failure to follow instructions can cause injury or death.

W-2003-0903

Seat Adjustment

Figure 53

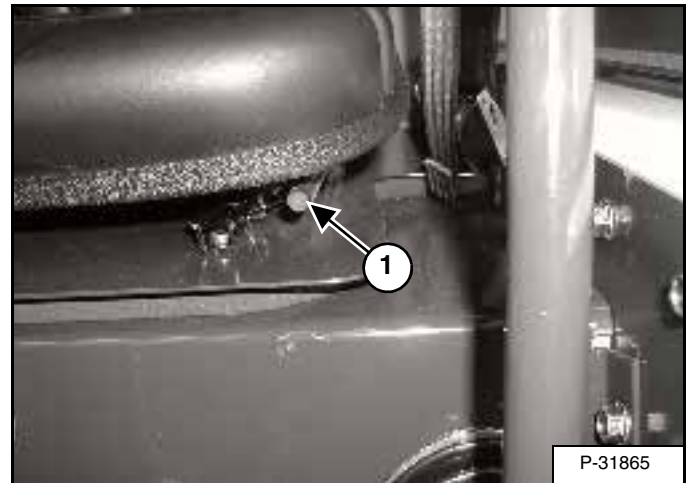

Release the seat lever (1) [Figure 53] and adjust the seat position for comfortable operation of the loader controls.

Figure 54

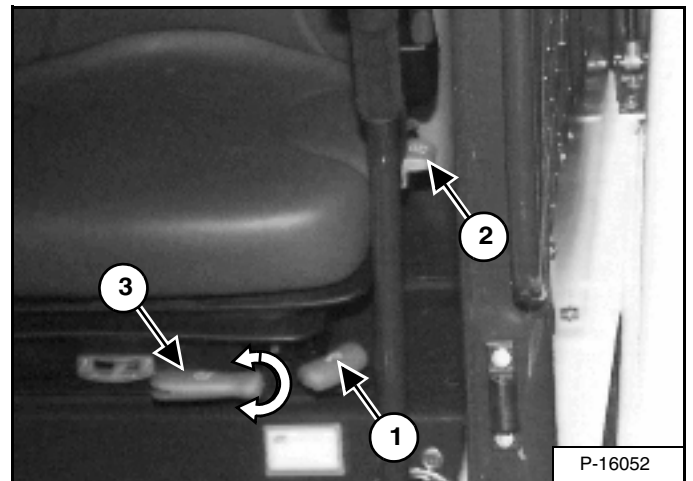

Suspension Seat - (Option & Field Accessory) Release the lever (1) [Figure 54] to adjust the seat distance from the levers and footrests.

Release the lever (2) [Figure 54] to adjust the angle of the seat back.

Turn the lever (3) [Figure 54] to adjust the seat cushion for weight of the operator.

PRE-STARTING PROCEDURE (CONT'D)

Seat Belt Adjustment

Figure 55

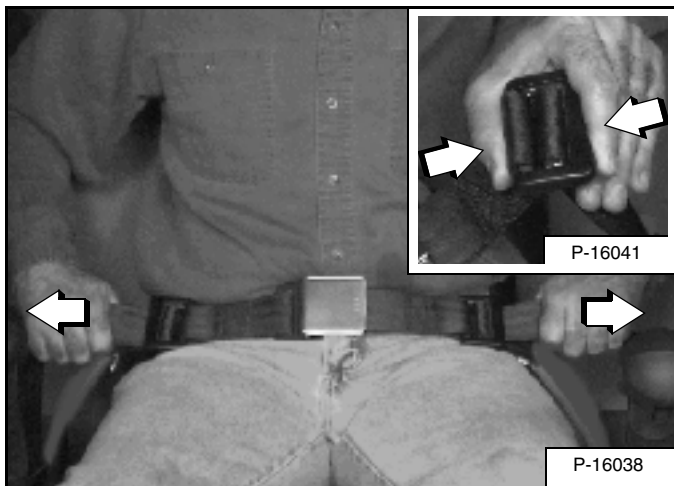

Squeeze both seat belt adjusters to release and lengthen each half of the seat belt [Figure 55].

Fasten the seat belt.

Pull the ends of the belt through the belt adjusters so that the seat belt is snug and the buckle is centered between your hips [Figure 55].

Figure 56

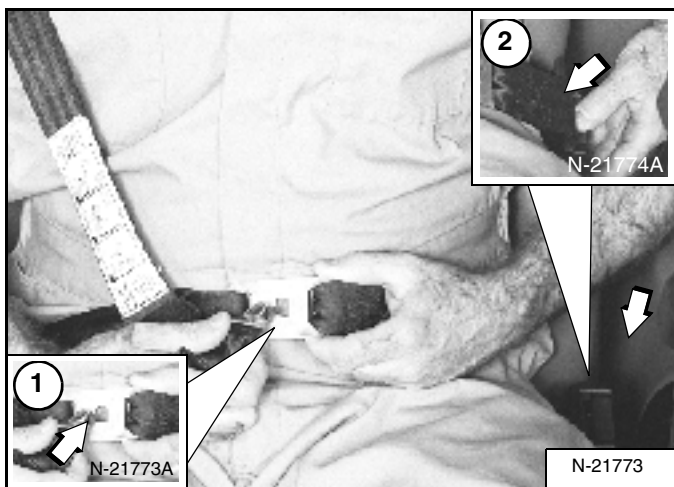

3-Point Restraint - (Option) Connect the shoulder belt to the lap belt (1) [Figure 56]. Pull the lap belt across to the left side of the seat (2) [Figure 56] and fasten.

The shoulder belt must be positioned over your right shoulder and the lap belt must be snug over your lower hips [Figure 56].

Seat Bar

Figure 57



Lower the seat bar and engage the parking brake (1) [Figure 57].

Put the foot pedals or hand controls in neutral position.

NOTE: Keep your hands on the steering levers and your feet on the foot pedals (or footrests) while operating the loader.

WARNING

AVOID INJURY OR DEATH

When operating the machine:

- Keep the seat belt fastened snugly.
- The seat bar must be lowered.
- Keep your feet on the pedal controls or footrests and hands on steering levers.

W-2261-0799

IMPORTANT

Check the seat belt and shoulder belt retractors for correct operation.

Keep retractors clean and replace as necessary.

I-2199-0200

STARTING THE ENGINE

Key Switch

! WARNING

AVOID INJURY OR DEATH

- Engines can have hot parts and hot exhaust gas. Keep flammable material away.
- Do not use machines in atmosphere containing explosive gas.

W-2051-1086

Perform the PRE-STARTING PROCEDURE. (See PRE-STARTING PROCEDURE on Page 27.)

Figure 58

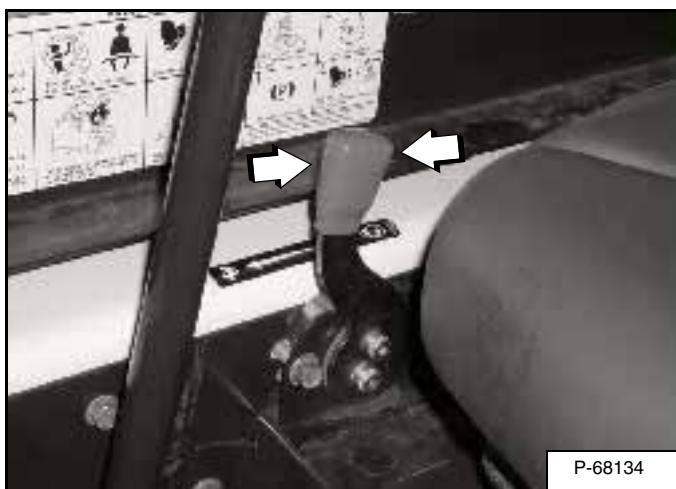

Set the engine speed control to the 1/2 speed position [Figure 58].

Figure 59

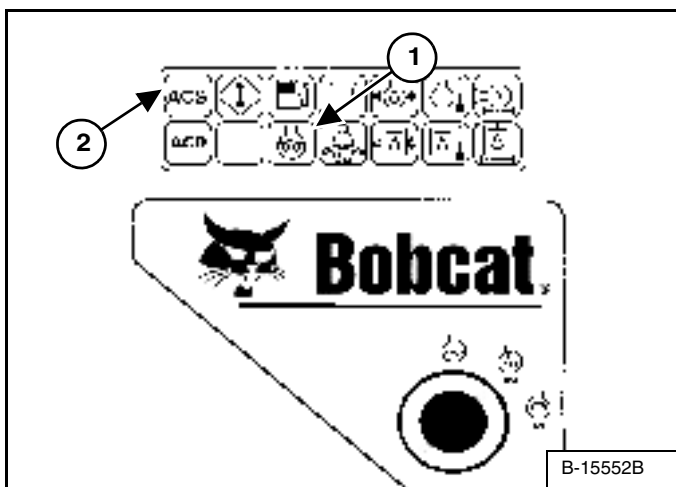

Turn the key switch to RUN [Figure 59]. The indicator lights on the right instrument panel [Figure 59] will come ON briefly and the Instrument Panel / monitoring system will do a self test.

If the temperature is cold, the intake air heater will automatically cycle. The Icon light (1) [Figure 59] will be ON and the cycle time remaining will show in the hour meter.

When the Icon light goes OFF, turn the key switch to START [Figure 59].

Advanced Control System (ACS): Make sure both hand controls are in the neutral position before starting the engine. Do not move the Hand Control levers from the neutral position when turning the key to RUN or START [Figure 59].

NOTE: Make sure both hand controls (ACS) or Joysticks (SJC) are in the neutral position before starting the engine. Do not move the levers or joysticks from the neutral position when turning the key to RUN or START [Figure 59].

If either hand control is moved:

a. The neutral position for the hydraulic valve spool and hand control may not be correctly calibrated. This can result in movement of the lift or tilt hydraulic cylinders when the hand control lever is returned to the neutral position after start-up.

OR

b. ACS (2) [Figure 59] indicator light on right instrument panel will be ON.

If either condition occurs, return key to STOP (3) [Figure 59]. Put the controls in neutral position and re-start the engine.

Release the key when the engine starts. It will return to the RUN position.

! WARNING

AVOID INJURY OR DEATH

- Fasten seat belt, start and operate only from the operator seat.
- Never wear loose clothing when working near machine.

W-2135-1188

STARTING THE ENGINE (CONT'D)

Key Switch (Cont'd)

Figure 60

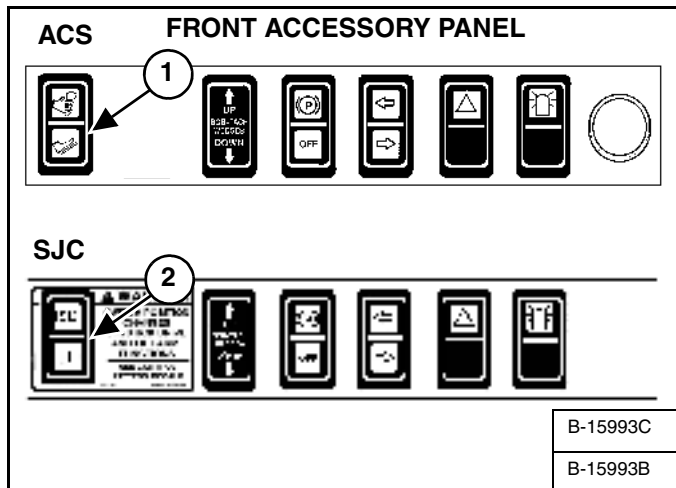

(ACS) Select hand control or foot pedal operation (1) [Figure 60].

OR

(SJC) Select 'ISO' or 'H' Control Pattern (2) [Figure 60].

Figure 61

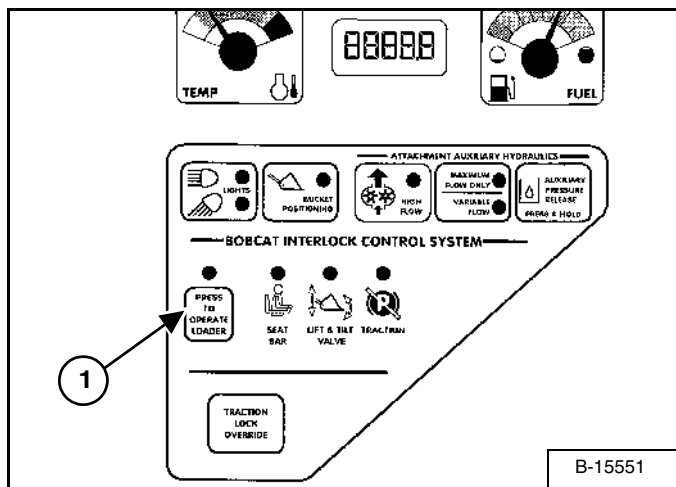

Press the PRESS TO OPERATE LOADER Button (1) [Figure 61] to activate the BICS system and to perform hydraulic and loader functions. (See Cold Temperature Starting on Page 33.)

NOTE: (SJC) The pending mode will flash which will indicate PRESS TO OPERATE LOADER is required. The light will flash when key is ON and continue to flash until the PRESS TO OPERATE LOADER button is pressed and thereafter it will light solid. If the mode (ISO / H) is changed while driving, the active mode will be solid and the pending mode will flash. When operation of the machine is returned to neutral, the active mode will then turn off and the pending mode will continue to flash until the PRESS TO OPERATE LOADER button is pressed.

WARNING

When an engine is running in an enclosed area, fresh air must be added to avoid concentration of exhaust fumes. If the engine is stationary, vent the exhaust outside. Exhaust fumes contain odorless, invisible gases which can kill without warning.

W-2050-1285

STARTING THE ENGINE (CONT'D)

Keyless

! WARNING

AVOID INJURY OR DEATH

- Engines can have hot parts and hot exhaust gas. Keep flammable material away.
- Do not use machines in atmosphere containing explosive gas.

W-2051-1086

Perform the PRE-STARTING PROCEDURE. (See PRE-STARTING PROCEDURE on Page 27.)

Figure 62

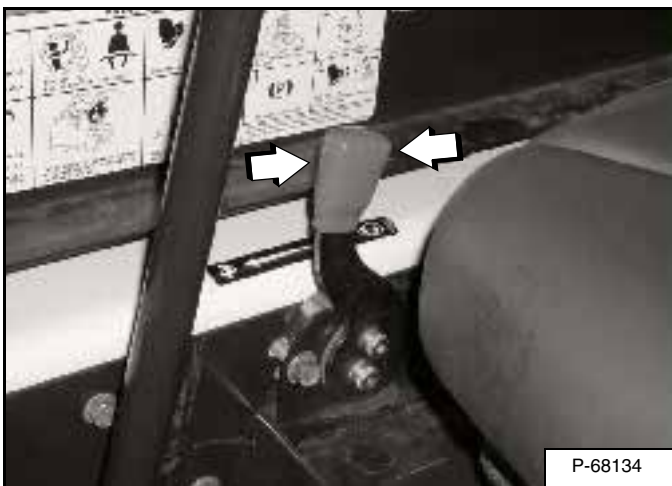

Set the engine speed control at the 1/2 speed position [Figure 58].

NOTE: Loaders with Keyless Instrument Panel have a permanent, randomly generated Master Password set at the factory. Your loader will be assigned an Owner Password. Your dealer will provide you with this password. Change the password to one that you will easily remember to prevent unauthorized use of your loader. (See Passwords on Page 116.) Keep your password in a safe place for future needs.

Figure 63

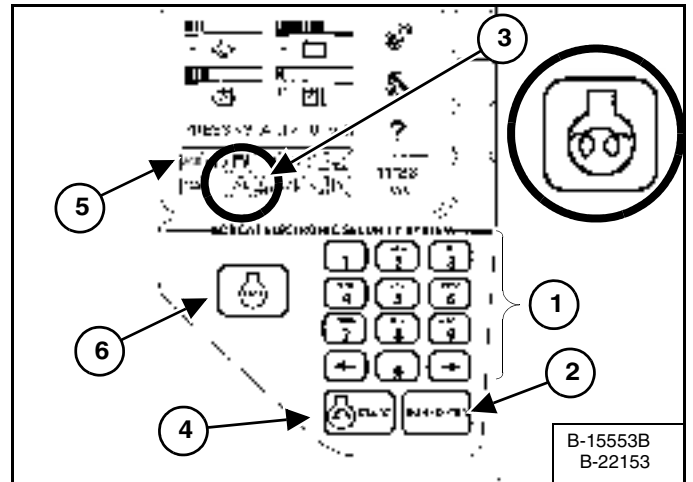

Use the numeric keypad (1) [Figure 63] to enter the password, then press the RUN/ENTER Button (2) [Figure 63].

If the temperature is cold, the intake air heater will automatically cycle and the Icon (3) [Figure 63] will be ON.

When the Icon light goes OFF, press the START Button (4) [Figure 63]. Release the button when the engine starts.

NOTE: Make sure both hand controls (ACS) or Joysticks (SJC) are in the neutral position before starting the engine. Do not move the levers or joysticks from the neutral position before attempting to start the engine.

If controls are moved:

a. The neutral position for the hydraulic valve spool and hand control may not be correctly calibrated. This can result in movement of the lift or tilt hydraulic cylinders when the hand control lever is returned to the neutral position after start-up.

OR

b. ACS indicator light (5) [Figure 63] on right instrument panel will be ON.

If either condition occurs, press the STOP button (6) [Figure 63]. Put the controls in neutral position and re-start the engine.

STARTING THE ENGINE (CONT'D)

Keyless (Cont'd)

Figure 64

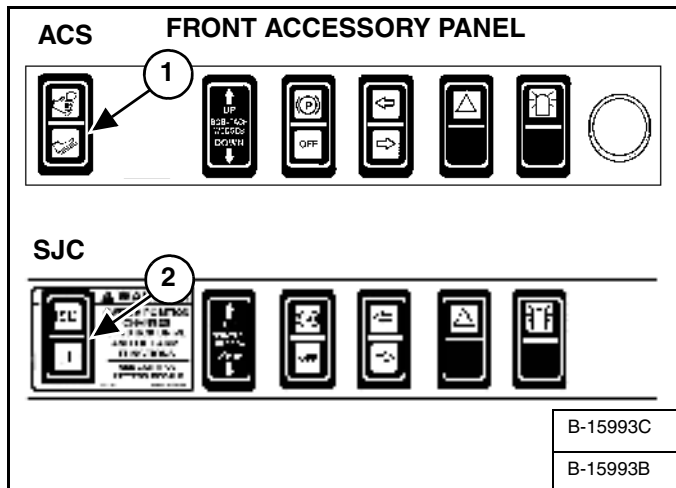

(ACS) Select hand control or foot pedal operation (1) [Figure 64].

OR

(SJC) Select 'ISO' or 'H' Control Pattern (2) [Figure 64].

Figure 65

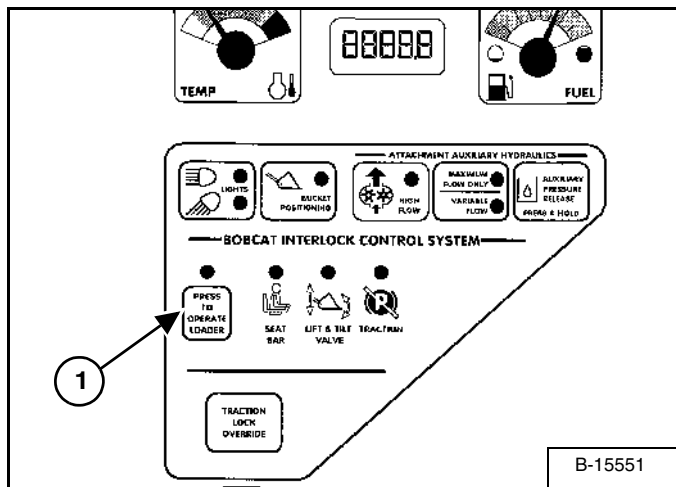

Press the PRESS TO OPERATE LOADER Button (1) [Figure 65] to activate the BICS system and to perform hydraulic and loader functions.

NOTE: (SJC) The pending mode will flash which will indicate PRESS TO OPERATE LOADER is required. The light will flash when key is ON and continue to flash until the PRESS TO OPERATE LOADER button is pressed and thereafter it will light solid. If the mode (ISO / H) is changed while driving, the active mode will be solid and the pending mode will flash. When operation of the machine is returned to neutral, the active mode will then turn off and the pending mode will continue to flash until the PRESS TO OPERATE LOADER button is pressed.

! WARNING

When an engine is running in an enclosed area, fresh air must be added to avoid concentration of exhaust fumes. If the engine is stationary, vent the exhaust outside. Exhaust fumes contain odorless, invisible gases which can kill without warning.

W-2050-1285

STARTING THE ENGINE (CONT'D)

Cold Temperature Starting

WARNING

Do not use ether with glow plug (preheat) systems. Explosion can result which can cause injury, death, or severe engine damage.

W-2071-0903

If the temperature is below freezing, perform the following to make starting the engine easier:

- Replace the engine oil with the correct type and viscosity for the anticipated starting temperature. (See ENGINE LUBRICATION SYSTEM on Page 84.)
- Make sure the battery is fully charged.
- Install an engine heater, available from your Bobcat Loader dealer.

NOTE: The LCD of the Keyless Panel may not be immediately visible when the temperature is below -26°C (-15°F). It may take 30 seconds to several minutes for the Display Panel to warm up. All systems remain monitored even when the display is off.

Warming The Hydraulic / Hydrostatic System

IMPORTANT

When the temperature is below -30°C (-20°F), hydrostatic oil must be warmed before starting. The hydrostatic system will not get enough oil at low temperatures and will be damaged. Park the machine in an area where the temperature will be above -18°C (0°F) if possible.

I-2007-1285

Let the engine run for a minimum of 5 minutes to warm the engine and hydrostatic transmission fluid before operating the loader.

Figure 66

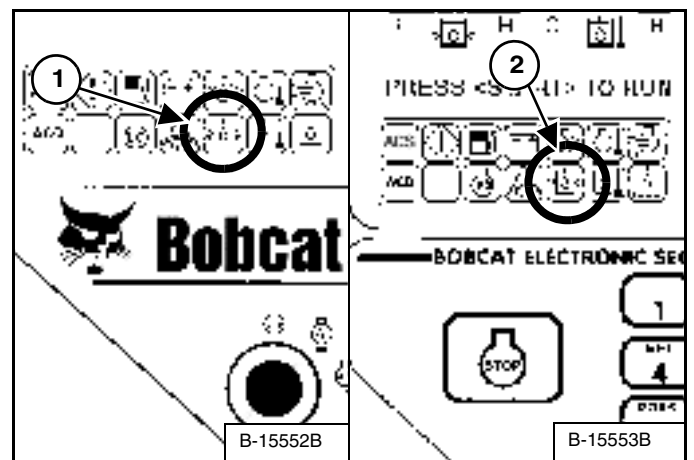

If the Fluid Pressure Icon light (1) [Figure 66] (Key Switch Panel) or (2) [Figure 66] (Keyless Panel) comes ON when operating the loader (cold), more warm up time is needed.

MONITORING THE DISPLAY PANELS

Left Panel

Figure 67

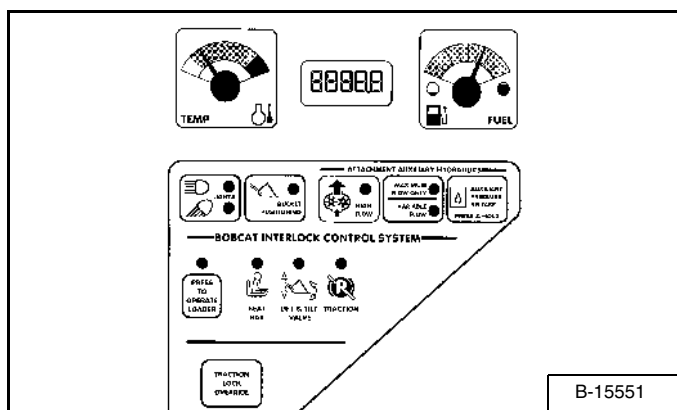

Frequently monitor the temperature and fuel gauges and BICES lights (all must be ON to operate loader) [Figure 67].

Right Panel (Key Switch)

Figure 68

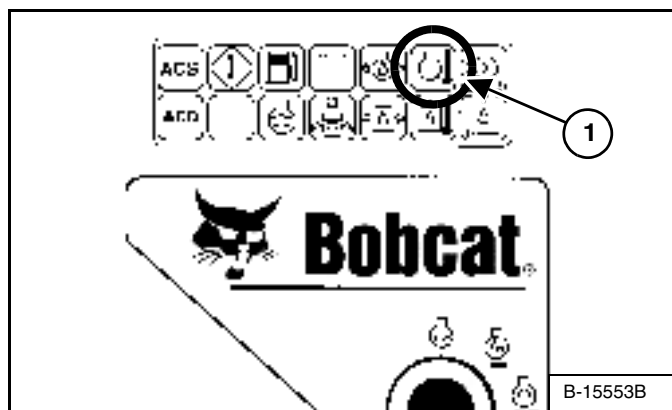

After the engine is running, frequently monitor the right instrument panel [Figure 68] for error conditions.

The associated icon will be ON if there is an error condition.

EXAMPLE: Engine Coolant Temperature is High

The Engine Temperature Icon (1) [Figure 68] will be ON.

Press and hold LIGHTS Button for 2 seconds. One of the following SERVICE CODES will be displayed.

- **08-10** Engine Coolant Temperature High
- **08-11** Engine Coolant Temperature Extremely High

Find the cause of the error code and correct before operating the loader again.

MONITORING THE DISPLAY PANELS (CONT'D)

Right Panel (Keyless)

Figure 69

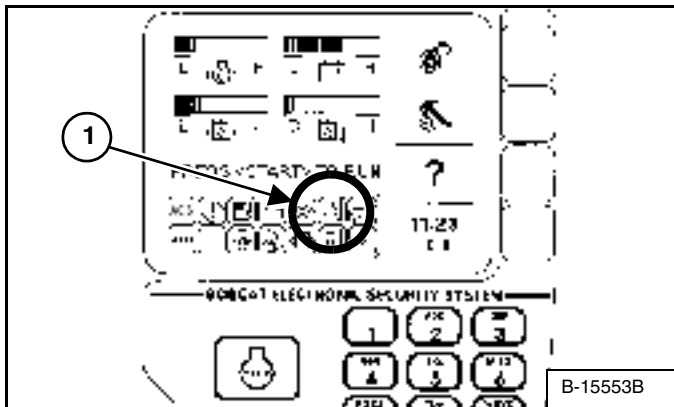

After the engine is running, frequently monitor the right instrument panel [Figure 69] for error conditions.

The associated icon will be ON if there is an error condition.

EXAMPLE: Engine Coolant Temperature is High

The Engine Temperature Icon (1) [Figure 69] will be ON.

Press and hold LIGHTS Button for 2 seconds. One of the following SERVICE CODES will be displayed.

- **08-10** Engine Coolant Temperature High
- **08-11** Engine Coolant Temperature Extremely High

In addition, the Keyless Panel display screen will describe the extreme condition that can cause damage to the engine or loader systems [Figure 69].

Find the cause of the error code and correct before operating the loader again.

Warning And Shutdown

When a WARNING condition exists, the associated Icon light will come ON and there will be 3 beeps from the alarm. Be aware that, if this condition is allowed to continue, there may be damage to the engine or loader hydraulic systems.

When a SHUTDOWN condition exists, the associated Icon light will come ON and there will be a continuous beep from the alarm and the monitoring system will automatically stop the engine in 10 seconds. The engine can be restarted to move or relocate the loader.

The SHUTDOWN feature is associated with the following Icons:

- **General Warning**
- **Engine Oil Pressure**
- **Engine Coolant Temperature**
- **Hydraulic Oil Temperature**
- **Hydrostatic Charge Pressure**

Whenever **STOP** appears on the display screen, lower the lift arms all the way, put the attachment flat on the ground and stop the engine to prevent damage to the engine or loader systems.

STOPPING THE ENGINE AND LEAVING THE LOADER

Procedure

Figure 70



Stop the Bobcat Loader on level ground.

Lower the lift arms fully and put the attachment flat on the ground [Figure 70].

Figure 71



Pull the engine speed control fully backward [Figure 71] to decrease the engine speed.

Figure 72

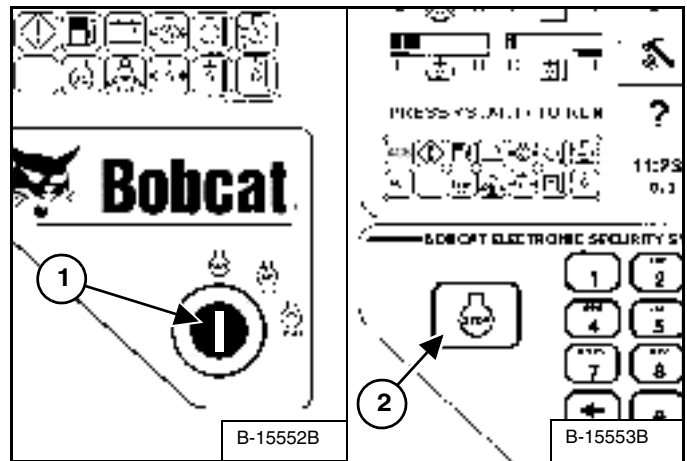

Engage the parking brake.

Turn the key switch to the STOP position (1) [Figure 72] (*Key Switch*) or press the STOP Button (2) [Figure 72] (*Keyless*).

Lift the seat bar and make sure the lift and tilt functions are deactivated.

Unbuckle the seat belt.

Remove the key from the switch (*Key Switch*) to prevent operation of the loader by unauthorized personnel.

Exit the loader using grab handles, safety tread and steps (maintaining a 3-point contact) [Figure 70].

WARNING

Before you leave the operator's seat:

- Lower the lift arms, put the attachment flat on the ground.
- Stop the engine.
- Engage the parking brake.
- Raise seat bar.
- (Foot Pedal Controls) Move pedals until both lock.
- (Advanced Control system - ACS) Move the hydraulic controls to the NEUTRAL POSITION to make sure that both lift and tilt functions are deactivated.
The seat bar system must deactivate the lift and tilt control functions when the seat bar is up. Service the system if hand controls do not deactivate.
- (Selectable Joystick Controls - SJC) Move the joysticks to the NEUTRAL POSITION to make sure that travel and hydraulic functions are deactivated.
The seat bar system must deactivate these functions when the seat bar is up. Service the system if controls do not deactivate.

W-2463-0603

STOPPING THE ENGINE AND LEAVING THE LOADER (CONT'D)

Emergency Exit

The front opening on the operator cab and rear window provide exits.

Rear Window (If Equipped)

Figure 73



Pull on the tag on the top of the rear window to remove the rubber cord [Figure 73].

Push the rear window out of the rear of the operator cab.

Figure 74



Exit through the rear of the operator cab [Figure 74].

Front Door (If Equipped)

NOTE: When an Operator Cab Enclosure Kit is installed, the window of the front door can be used as an emergency exit [Figure 75].

NOTE: If the loader has a Special Application Door Kit installed, the window of the front door is NOT an emergency exit.

Figure 75

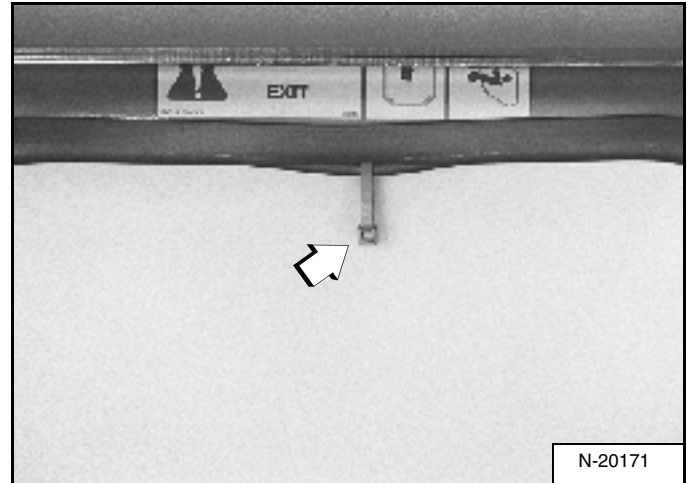

Pull the plastic loop at the top of the window in the front door to remove the rubber cord [Figure 75].

Figure 76

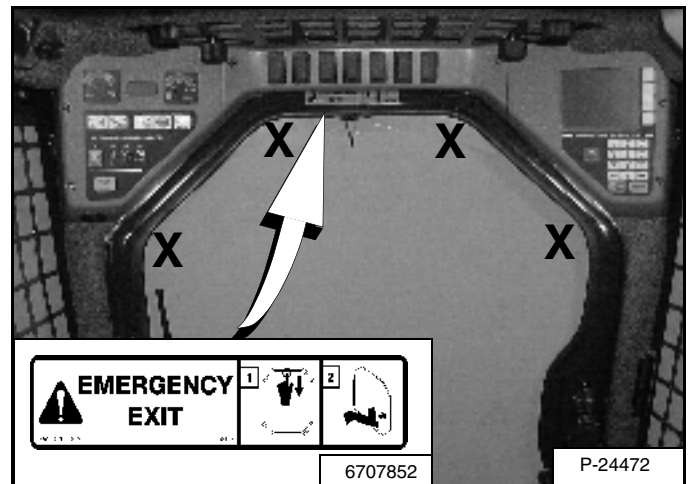

Push the window out with your foot [Figure 76] at any corner of the window.

Exit through the front door.

ATTACHMENTS

Choosing The Correct Bucket

! WARNING

Never use attachments or buckets which are not approved by Bobcat Company. Buckets and attachments for safe loads of specified densities are approved for each model. Unapproved attachments can cause injury or death.

W-2052-0500

NOTE: Warranty is void if non-approved attachments are used on the Bobcat Loader.

The dealer can identify, for each model loader, the attachments and buckets approved by Bobcat. The buckets and attachments are approved for Rated Operating Capacity and for secure fastening to the Bob-Tach.

The Rated Operating Capacity for this loader is shown on a decal in the operator cab. (See Machine Rating on Page 122.)

The Rated Operating Capacity is determined by using a standard dirt bucket, and material of normal density, such as dirt or dry gravel. If longer buckets are used, the load center moves forward and reduces the Rated Operating Capacity. If very dense material is loaded, the volume must be reduced to prevent overloading.

Figure 77

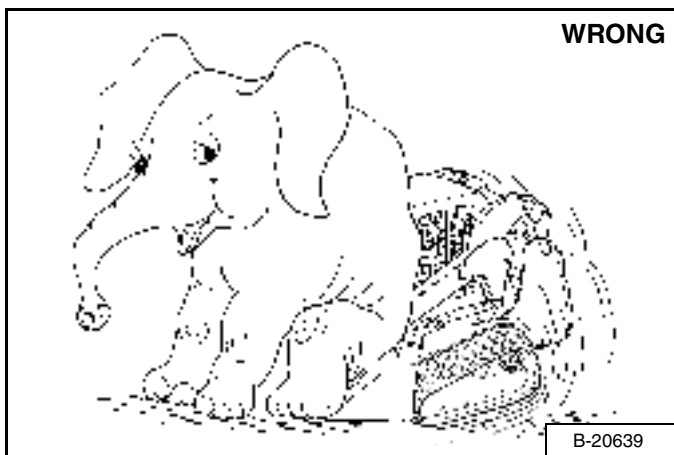

Exceeding the Rated Operating Capacity [Figure 77] can cause the following problems:

- Steering the loader may be difficult.
- Tracks will wear faster.
- There will be a loss of stability.
- The life of the Bobcat Loader will be reduced.

Use the correct size bucket for the type and density of material being handled. For safe handling of materials and avoiding machine damage, the attachment (or bucket) should handle a full load without going over the Rated Operating Capacity for the loader. Partial loads make steering more difficult.

Pallet Forks

Figure 78

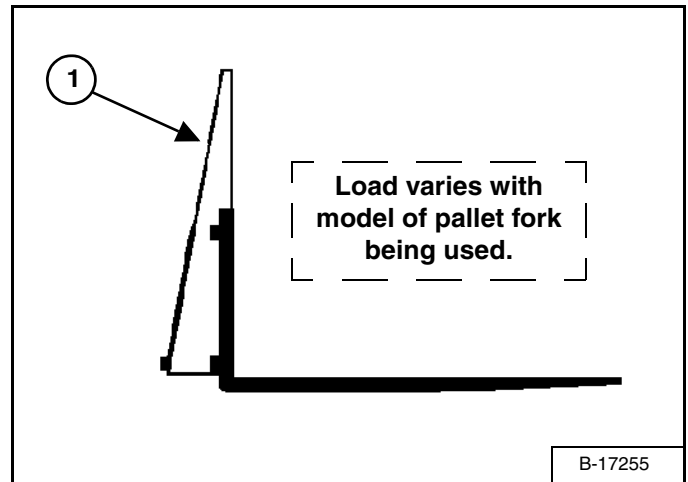

The maximum load to be carried when using a pallet fork is shown on a decal located on the pallet fork frame (1) [Figure 78].

! WARNING

AVOID INJURY OR DEATH

Do not exceed Rated Operating Capacity. Excessive load can cause tipping or loss of control.

W-2053-0903

See your Bobcat dealer for more information about pallet fork inspection, maintenance and replacement. See your Bobcat Loader dealer for Rated Operating Capacity when using a pallet fork and for other available attachments.

ATTACHMENTS (CONT'D)

Installing And Removing The Attachment (Hand Lever Bob-Tach)

The Bob-Tach is used for fast changing of buckets and attachments. See the appropriate Attachment Operation & Maintenance Manual to install other attachments.

Figure 79

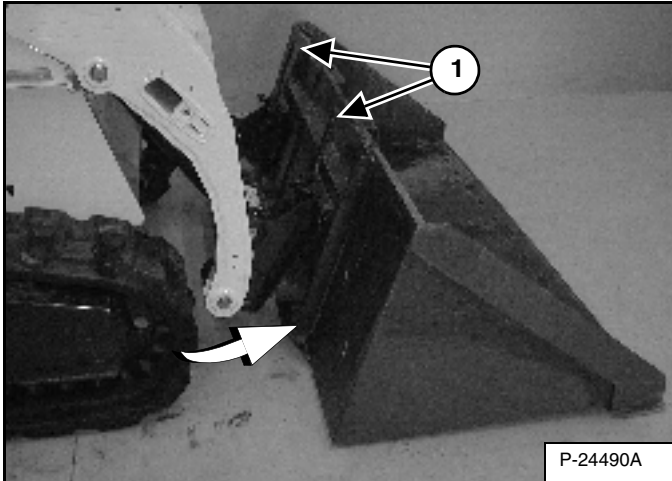

Installing

Pull the Bob-Tach levers all the way up (1) [Figure 79].

Enter the loader and perform the PRE-STARTING PROCEDURE. (See PRE-STARTING PROCEDURE on Page 27.)

Lower the lift arms and tilt the Bob-Tach forward.

Drive the loader forward until the top edge of the Bob-Tach is completely under the top flange of the bucket [Figure 79] (or other attachment). Be sure the Bob-Tach levers do not hit the bucket.

Figure 80

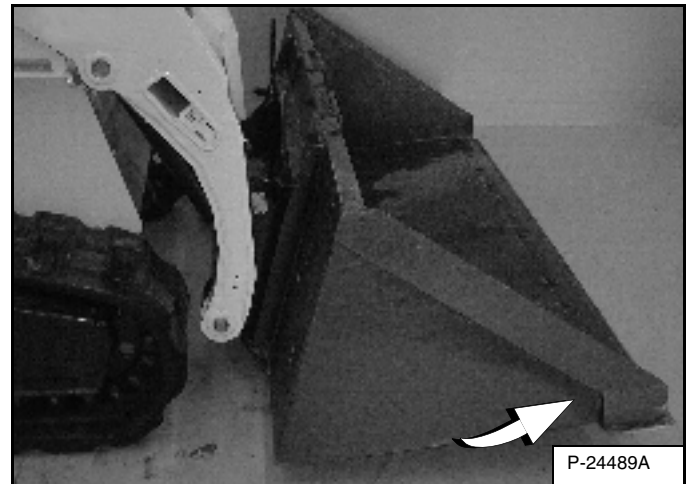

Tilt the Bob-Tach backward until the cutting edge of the bucket (or other attachment) is slightly off the ground [Figure 80].

Stop the engine and exit the loader.

WARNING

Before you leave the operator's seat:

- Lower the lift arms, put the attachment flat on the ground.
- Stop the engine.
- Engage the parking brake.
- Raise seat bar.
- (Foot Pedal Controls) Move pedals until both lock.
- (Advanced Control system - ACS) Move the hydraulic controls to the NEUTRAL POSITION to make sure that both lift and tilt functions are deactivated.
- (Selectable Joystick Controls - SJC) Move the joysticks to the NEUTRAL POSITION to make sure that travel and hydraulic functions are deactivated.

The seat bar system must deactivate the lift and tilt control functions when the seat bar is up. Service the system if hand controls do not deactivate.

The seat bar system must deactivate these functions when the seat bar is up. Service the system if controls do not deactivate.

W-2463-0603

ATTACHMENTS (CONT'D)

Installing And Removing The Attachment (Hand Lever Bob-Tach) (Cont'd)

Installing (Cont'd)

Figure 81

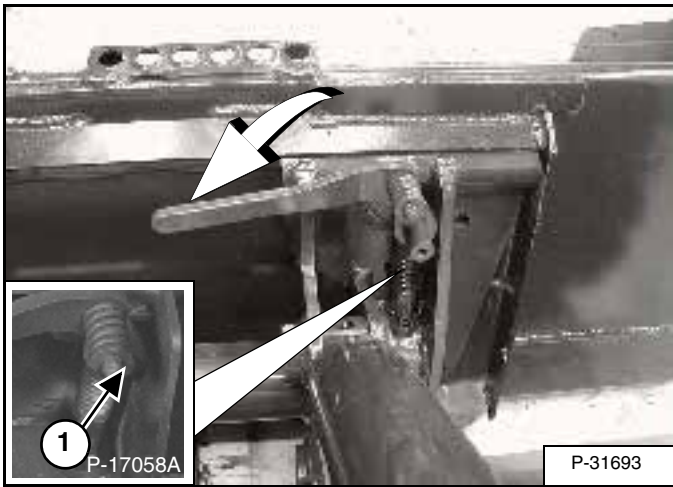

Push down on the Bob-Tach levers until they are fully engaged in the locked position (1) [Figure 81] (wedges fully extended).

Figure 82

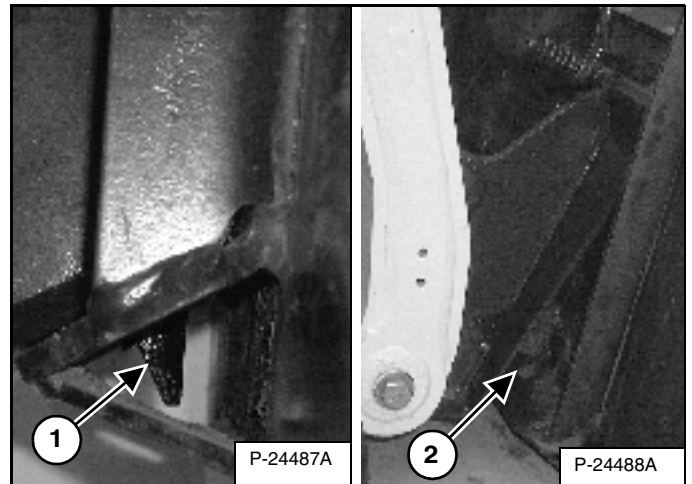

The wedges (1) [Figure 82] must extend through the holes (2) [Figure 82] in the mounting frame of the bucket (or attachment), securely fastening the bucket to the Bob-Tach.

WARNING

Bob-Tach wedges must extend through the holes in attachment. Levers must be fully down and locked. Failure to secure wedges can allow attachment to come off and cause injury or death.

W-2102-0588

ATTACHMENTS (CONT'D)

Installing And Removing The Attachment (Hand Lever Bob-Tach) (Cont'd)

Removing

Enter the loader.

Perform the PRE-STARTING PROCEDURE. (See PRE-STARTING PROCEDURE on Page 27.)

Start the engine.

Release the parking brake.

Be sure the lift arms are all the way down. Tilt the Bob-Tach forward.

Lower or close the hydraulic equipment (If Equipped).

- If the attachment is hydraulically controlled (combination bucket, backhoe, etc.), stop the engine and relieve hydraulic pressure at the quick couplers. (See Relieve Hydraulic Pressure (Loader And Attachment) on Page 23.)

Exit the loader and disconnect the hydraulic hoses from the attachment.

Enter the loader.

Perform the PRE-STARTING PROCEDURE. (See PRE-STARTING PROCEDURE on Page 27.)

Start the engine.

Release the parking brake.

Figure 83

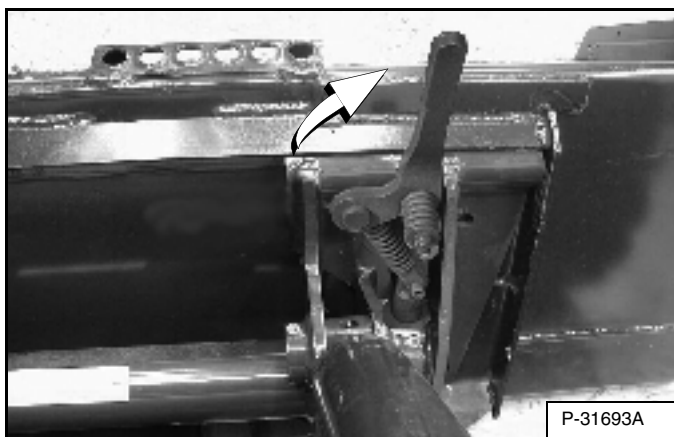

Pull the Bob-Tach levers [Figure 83] all the way up.

WARNING

Bob-Tach levers have spring tension. Hold lever tightly and release slowly. Failure to obey warning can cause injury.

W-2054-1285

Figure 84

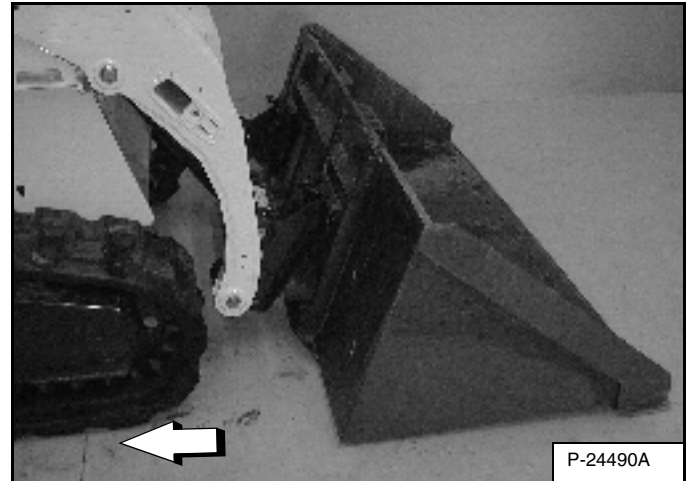

Move the loader backward, away from the bucket or attachment [Figure 84].

WARNING

Before you leave the operator's seat:

- Lower the lift arms, put the attachment flat on the ground.
- Stop the engine.
- Engage the parking brake.
- Raise seat bar.
- (Foot Pedal Controls) Move pedals until both lock.
- (Advanced Control system - ACS) Move the hydraulic controls to the NEUTRAL POSITION to make sure that both lift and tilt functions are deactivated.
The seat bar system must deactivate the lift and tilt control functions when the seat bar is up. Service the system if hand controls do not deactivate.
- (Selectable Joystick Controls - SJC) Move the joysticks to the NEUTRAL POSITION to make sure that travel and hydraulic functions are deactivated.
The seat bar system must deactivate these functions when the seat bar is up. Service the system if controls do not deactivate.

W-2463-0603

ATTACHMENTS (CONT'D)

Installing And Removing The Attachment (Power Bob-Tach Option)

Installing

The Bob-Tach is used for fast changing of buckets and attachments. See the appropriate Attachment Operation & Maintenance Manual to install other attachments.

Perform the PRE-STARTING PROCEDURE. (See PRE-STARTING PROCEDURE on Page 27.)

Lower the lift arms and tilt the Bob-Tach forward.

Figure 85

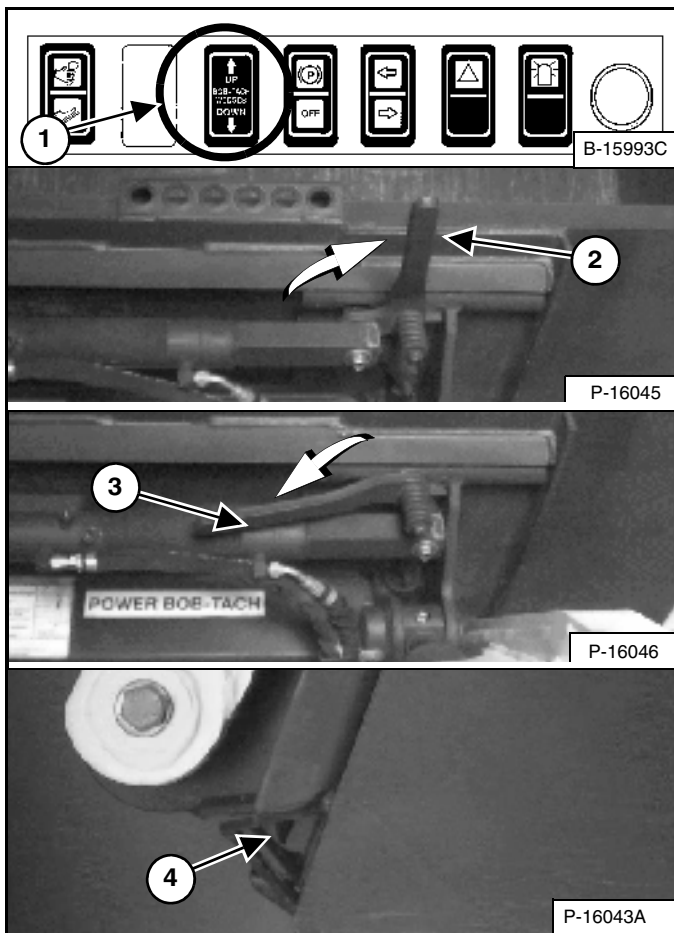

Push and hold BOB-TACH "WEDGES UP" switch (1) [Figure 85] (Front Accessory Panel) until levers (2) are in unlocked position (wedges fully raised).

NOTE: The Power Bob-Tach system has continuous pressurized hydraulic oil to keep the wedges in the engaged position and prevent attachment disengagement. Because the wedges can slowly lower, the operator may need to reactivate the switch (WEDGES UP) before installing an attachment to be sure both wedges are fully raised before installing the attachment.

Figure 86

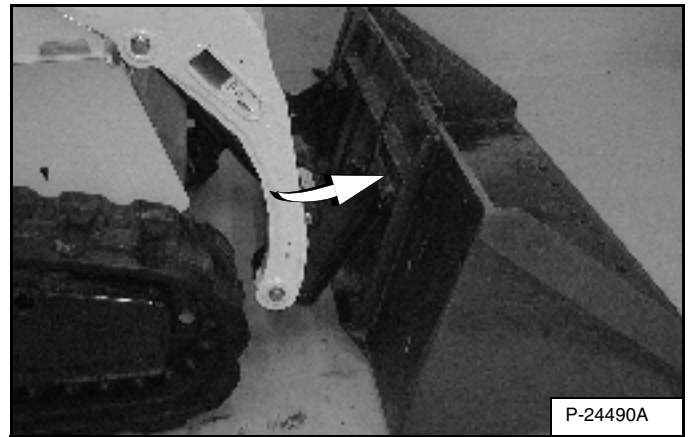

Drive the loader forward until the top edge of the Bob-Tach is completely under the top flange of the bucket [Figure 86] (or other attachment).

Figure 87

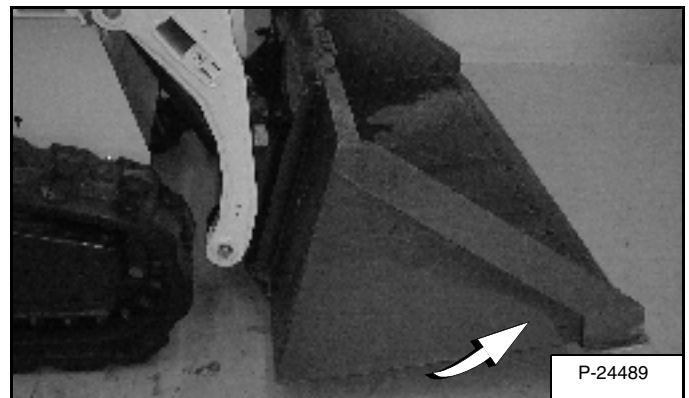

Tilt the Bob-Tach backward until the cutting edge of the bucket (or other attachment) is slightly off the ground [Figure 87].

Push and hold BOB-TACH "WEDGES DOWN" switch (Front Accessory Panel) until levers are fully engaged in the locked position (3) [Figure 85] (wedges fully extended).

The wedges (4) [Figure 85] must extend through the holes in the mounting frame of the bucket (or attachment), securely fastening the bucket to the Bob-Tach.

! WARNING

Bob-Tach wedges must extend through the holes in attachment. Levers must be fully down and locked. Failure to secure wedges can allow attachment to come off and cause injury or death.

W-2102-0588

ATTACHMENTS (CONT'D)

Installing And Removing The Attachment (Power Bob-Tach Option) (Cont'd)

Removing

Lower the lift arms and put the attachment flat on the ground.

- If the attachment is hydraulically controlled (combination bucket, backhoe, etc.):

Stop the engine and relieve hydraulic pressure in the auxiliary circuit. (See Relieve Hydraulic Pressure (Loader And Attachment) on Page 23.)

Exit the loader and disconnect the hydraulic hoses from the attachment.

Enter the loader.

Perform the PRE-STARTING PROCEDURE. (See PRE-STARTING PROCEDURE on Page 27.)

Start the engine.

Release the parking brake.

Figure 88

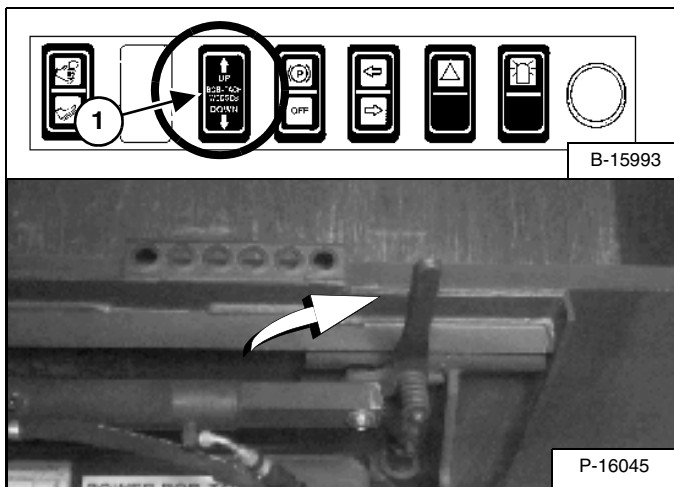

Push and hold the BOB-TACH "WEDGES UP" Switch (Front Accessory Panel) (1) [Figure 88] until the wedges are fully raised.

Tilt the Bob-Tach forward.

Figure 89

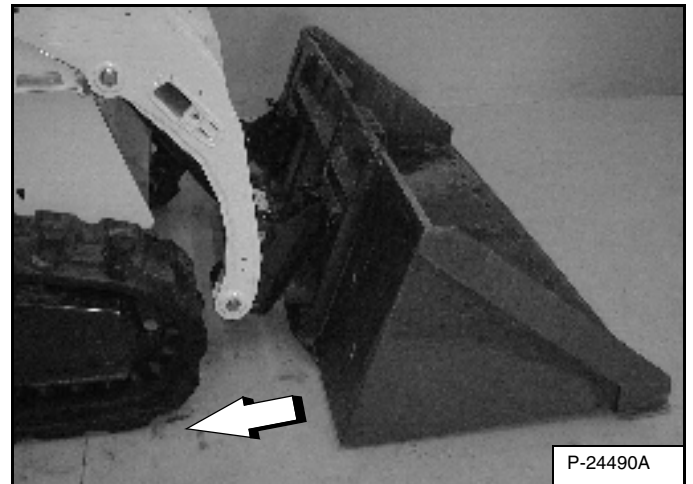

Move the loader backward, away from the bucket or attachment [Figure 89].

NOTE: The Power Bob-Tach system has continuous pressurized hydraulic oil to keep the wedges in the engaged position and prevent attachment disengagement. Because the wedges can slowly lower, the operator may need to reactivate the switch (WEDGES UP) before installing an attachment to be sure both wedges are fully raised before installing the attachment.

TRACK CARRIAGE SYSTEM

Introduction

There are many advantages of a Bobcat Compact Track Loader. They provide very high flotation, low ground pressure, turf friendly rubber tracks and excellent traction.

Compact Track Loader Operating And Maintenance Tips

Track Tension: Correct track tension is important. If the tracks are too loose, they can easily derail. If they are too tight, they will wear faster and cause increased stress on the complete track carriage system. (See TRACK TENSION on Page 96.)

Figure 90

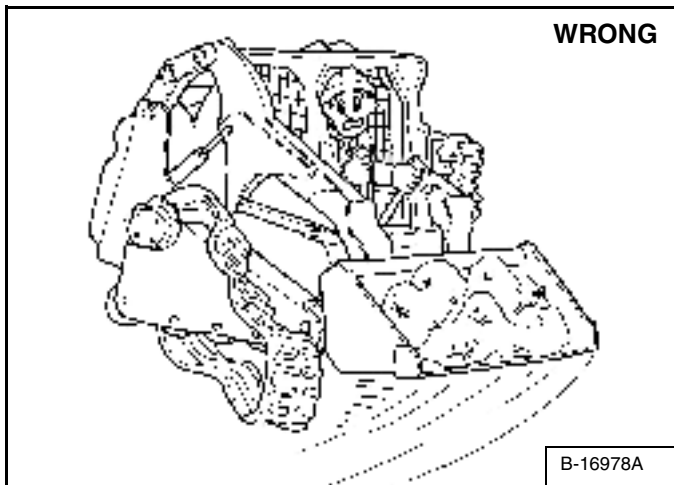

Turning: Use a gradual turn (one lever farther forward than the other) instead of a fast turn (one lever forward and one lever backward) on asphalt or concrete surfaces to prevent reduced track life or derailing of tracks [Figure 90].

Always carry the load low.

Figure 91

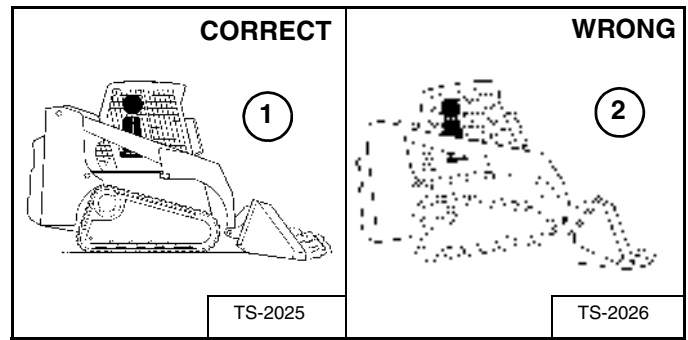

Digging And Leveling: Keep the full length of the tracks in contact with the ground (1) [Figure 91] for best traction. Raising the front end of the tracks off the ground (2) [Figure 91] will reduce traction and cause increased track wear.

Operating On Slopes: Go directly up or down a slope, not across the slope to prevent tracks from derailing.

Figure 92

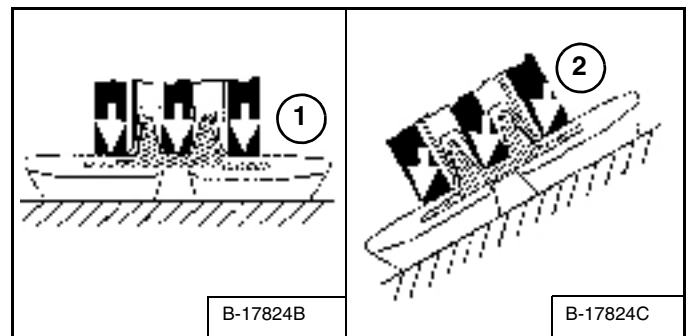

The track carriage components will wear faster when operated on a slope. When the machine is operated on a level surface, the weight of the machine is distributed throughout the entire surface of the rollers to the tracks (1) [Figure 92]. When operated on a slope, the weight is directed to the edge of the rollers and against the lugs of the track (2) [Figure 92] which causes increased wear.

TRACK CARRIAGE SYSTEM (CONT'D)

Compact Track Loader Operating And Maintenance Tips (Cont'd)

Figure 93

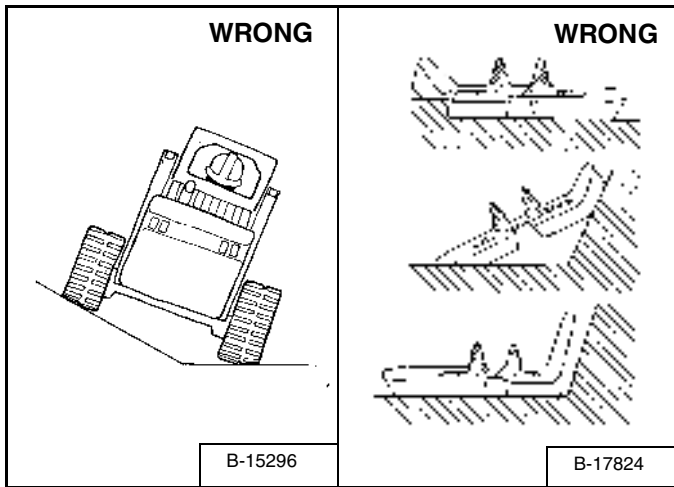

Operating Conditions: Avoid operating the loader with one track on a slope and the other on flat ground or with the end of the track turned up against a curb or mound [Figure 93]. This can cause the tracks to derail, cracks in the edge of the tracks or cracks at the edges of the embedded metal.

Figure 94

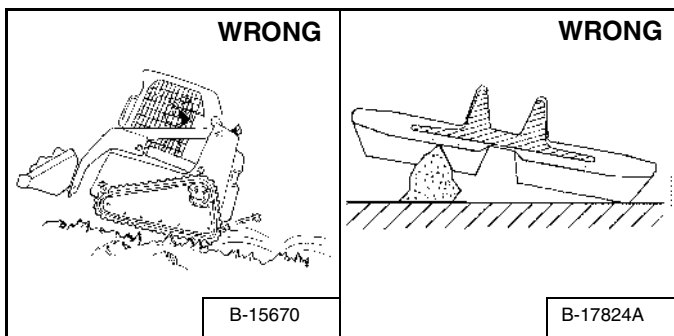

Avoid operating or turning on sharp objects such as jagged rocks, broken concrete, quarry materials or scrap applications. This can cause cuts on the lug surface of the tracks [Figure 94].

Cleaning and Maintenance: Keep the track carriage system as clean as possible. Remove rocks and debris from the tracks and rollers. Use a pressure washer if necessary.

Rotating: The sprockets and rollers can be rotated to the opposite side to increase their service life. See your Bobcat dealer for track and sprocket rotation.

It's All About The Tracks:

- Follow operating and maintenance tips
- Keep rollers and idlers clean
- Know what conditions can cause accelerated wear
- Watch for abnormal wear patterns
- Replace components and tracks as needed.

OPERATING PROCEDURE

Inspect The Work Area

Before beginning operation, inspect the work area for unsafe conditions.

Look for sharp drop-offs or rough terrain. Have underground utility lines (gas, water, sewer, irrigation, etc.) located and marked.

Remove objects or other construction material that could damage the loader or cause personal injury.

Operating With A Full Bucket

When operating on a public road or highway, always follow local regulations. For example: Slow Moving Vehicle Sign or direction signals may be required.

Always warm the engine and hydrostatic system before operating the loader.

IMPORTANT

Machines warmed up with moderate engine speed and light load have longer life.

I-2015-0284

Operate the loader with the engine at full speed for maximum horsepower. Move the steering levers only a small amount to operate the loader slowly.

New operators must operate the loader in an open area without bystanders. Operate the controls until the loader can be handled at an efficient and safe rate for all conditions of the work area.

Figure 95

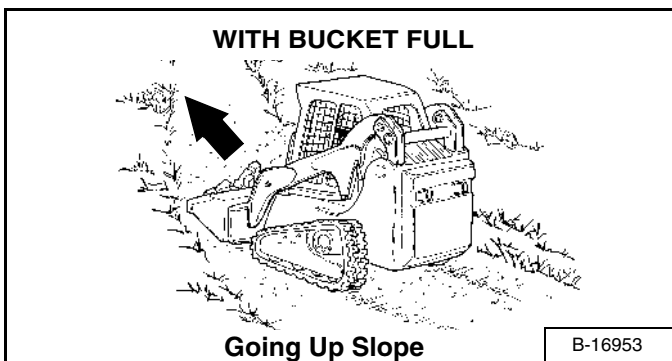

! WARNING

AVOID INJURY OR DEATH

- Keep the lift arms as low as possible.
- Do not travel or turn with the lift arms up.
- Turn on level ground.
- Go up and down slopes, not across them.
- Keep the heavy end of the machine uphill.
- Do not overload the machine.

Failure to obey warnings can cause the machine to tip or roll over and cause injury or death.

W-2018-1187

Figure 96

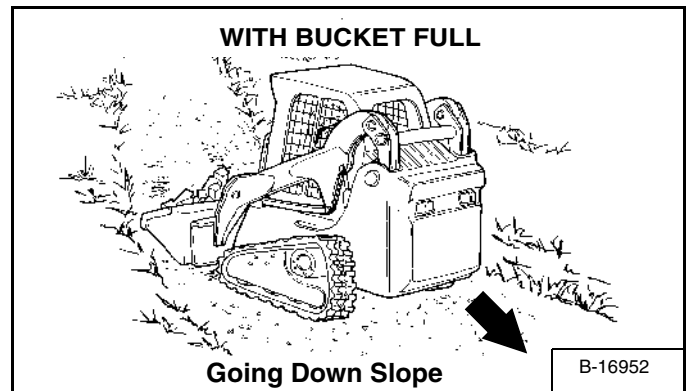

With a full bucket, go up or down the slope with the heavy end toward the top of the slope [Figure 95] and [Figure 96].

OPERATING PROCEDURE (CONT'D)

Operating With An Empty Bucket

Figure 97

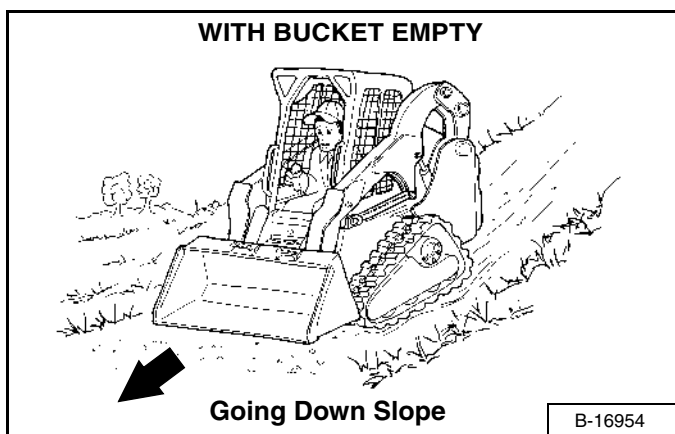
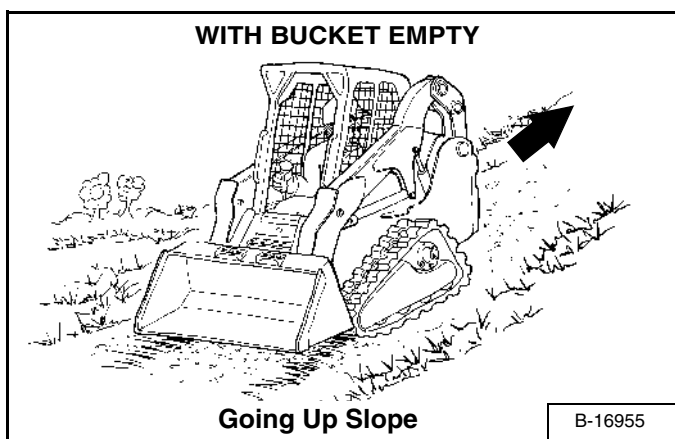

Figure 98



With empty bucket, go down or up the slope with the heavy end toward the top of the slope [Figure 97] and [Figure 98].

Raise the bucket only high enough to avoid obstructions on rough ground.

OPERATING PROCEDURE (CONT'D)

Filling And Emptying The Bucket (Foot Pedals)

Filling

Figure 99

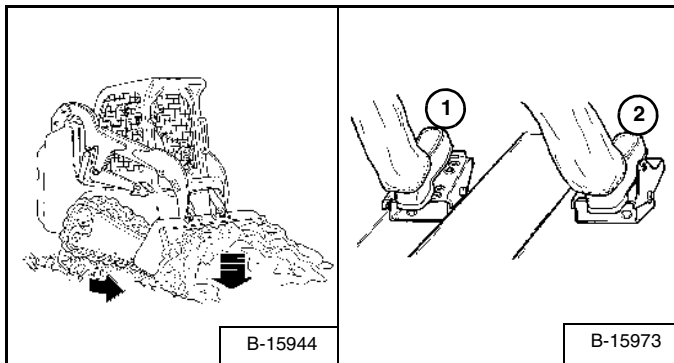
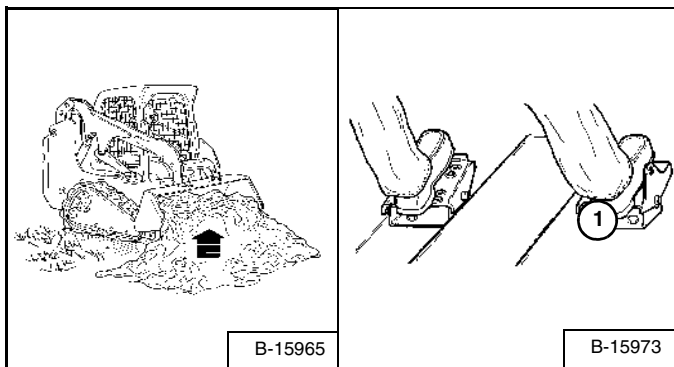

Figure 100



Lower the lift arms all the way (1) [Figure 99].

Tilt the bucket forward (2) [Figure 99] until the cutting edge of the bucket is on the ground.

Drive slowly forward into the material. Tilt the bucket backward (1) [Figure 100] all the way when the bucket is full.

Drive backward away from the material.

! WARNING

Load, unload and turn on flat level ground. Do not exceed Rated Operating Capacity shown on sign (decal) in cab. Failure to obey warnings can cause the machine to tip or roll over and cause injury or death.

W-2056-0903

Emptying

Figure 101

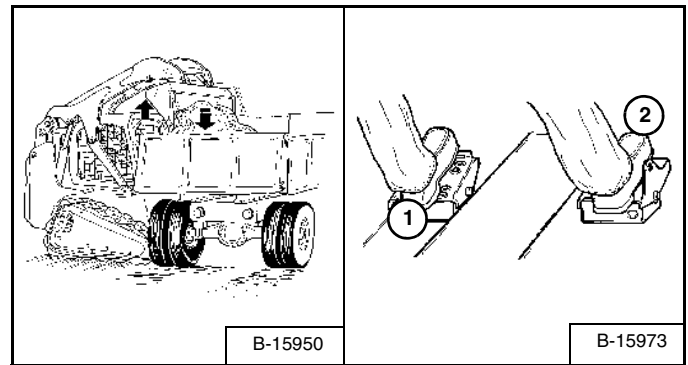

Keep the bucket low when moving to the area where you want to empty the bucket.

Raise the lift arms (1) [Figure 101]. Level the bucket (2) [Figure 101] while raising the lift arms to help prevent material from falling off the back of the bucket.

Drive forward slowly until the bucket is over the top of the truck box or bin.

Empty the bucket (2) [Figure 101]. If all the material is near the side of the truck or bin, use the bucket tilt to move it to the other side.

! WARNING

Never dump over an obstruction, such as a post, that can enter the operator cab. The machine could tip forward and cause injury or death.

W-2057-0694

OPERATING PROCEDURE (CONT'D)

Leveling The Ground Using Float (Foot Pedals)

Figure 102

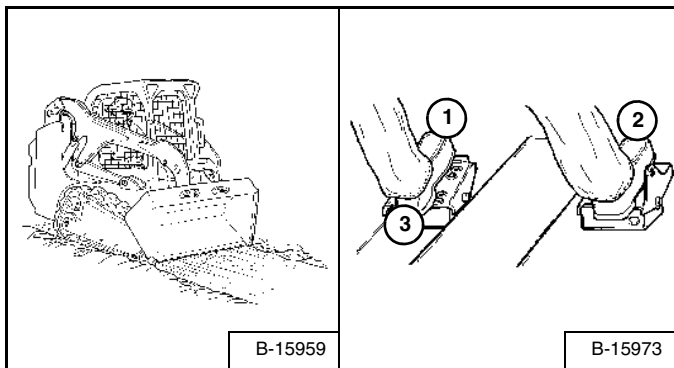

Put the lift arms in *float* position by pushing the pedal all the way forward (1) [Figure 102] until the pedal is locked in the forward position.

Tilt the bucket forward (2) [Figure 102] to change the position of the cutting edge of the bucket.

With the bucket tilted farther forward, there is more force on the cutting edge and more loose material can be moved.

Drive backward to level loose material.

Push the bottom of the lift pedal (3) [Figure 102] to unlock the float position.

IMPORTANT

Never drive forward when the hydraulic control for lift arms is in float position.

I-2005-1285

OPERATING PROCEDURE (CONT'D)

Digging And Filling A Hole (Foot Pedals)

Digging

Figure 103

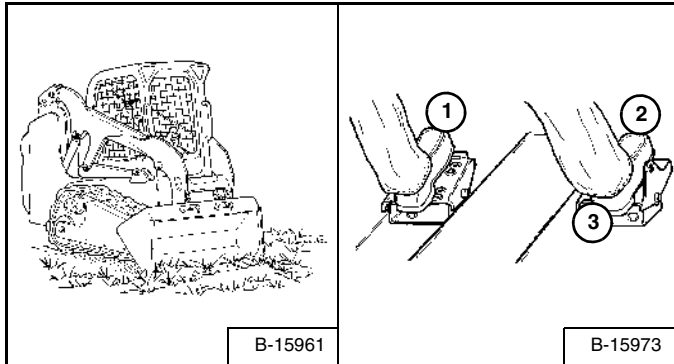

Lower the lift arms all the way (1) [Figure 103]. Put the cutting edge of the bucket on the ground (2) [Figure 103].

Drive forward slowly and continue to tilt the bucket down (2) [Figure 103] until it enters the ground.

Raise the cutting edge a small amount (3) [Figure 103] to increase traction and keep an even digging depth. Continue to drive forward until the bucket is full. When the ground is hard, raise and lower the cutting edge of the bucket (2 and 3) [Figure 103] while driving forward slowly.

Figure 104

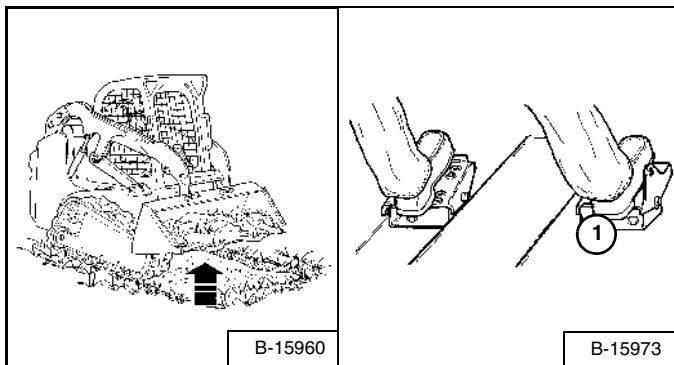

Tilt the bucket backward (1) [Figure 104] as far as it will go when the bucket is full.

Filling

Figure 105

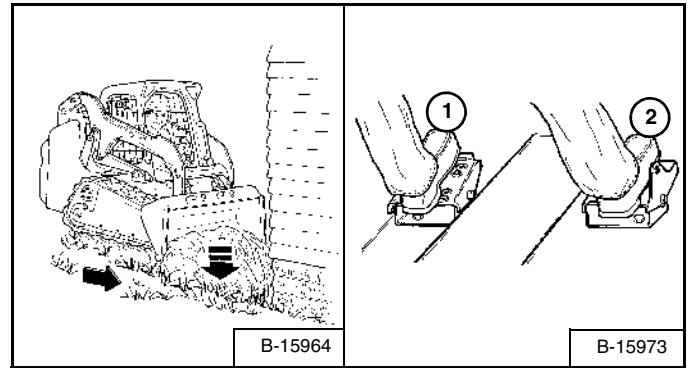

Lower the lift arms (1) [Figure 105] and put the cutting edge of the bucket on the ground (2) [Figure 105]. Drive forward to the edge of the hole to push the material into the hole.

Tilt the bucket forward (2) [Figure 105] as soon as it is past the edge of the hole.

If necessary, raise the lift arms to empty the bucket.

OPERATING PROCEDURE (CONT'D)

Filling And Emptying The Bucket (ACS - Handles, SJC - 'H' Pattern)

Filling

Figure 106

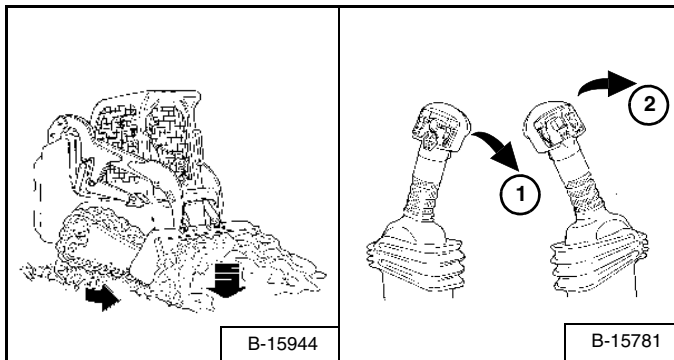
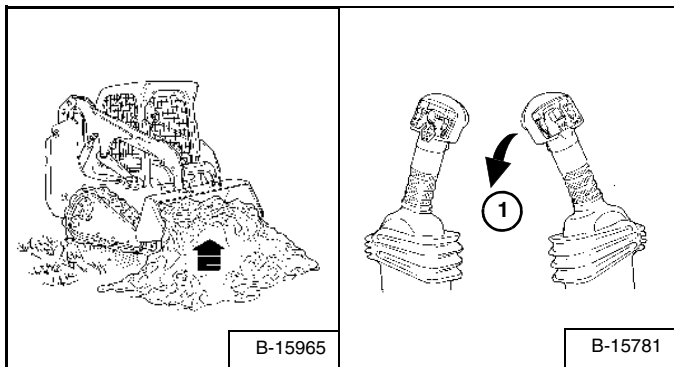

Figure 107



Lower the lift arms all the way (1) [Figure 106].

Tilt the bucket forward (2) [Figure 106] until the cutting edge of the bucket is on the ground.

Drive slowly forward into the material. Tilt the bucket backward (1) [Figure 107] all the way when the bucket is full.

Drive backward away from the material.

! WARNING

Load, unload and turn on flat level ground. Do not exceed Rated Operating Capacity shown on sign (decal) in cab. Failure to obey warnings can cause the machine to tip or roll over and cause injury or death.

W-2056-0903

Emptying The Bucket

Figure 108

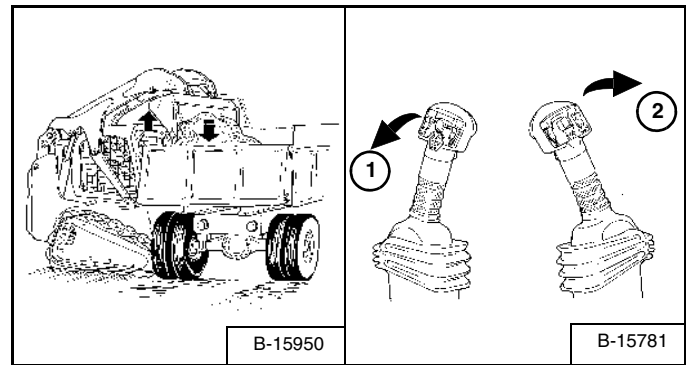

Keep the bucket low when moving to the area where you want to empty the bucket.

Raise the lift arms (1) [Figure 108]. Level the bucket (2) [Figure 108] while raising the lift arms to help prevent material from falling off the back of the bucket.

Drive forward slowly until the bucket is over the top of the truck box or bin.

Empty the bucket (2) [Figure 108]. If all material is near the side of the truck or bin, use the bucket tilt to move it to the other side.

! WARNING

Never dump over an obstruction, such as a post, that can enter the operator cab. The machine could tip forward and cause injury or death.

W-2057-0694

OPERATING PROCEDURE (CONT'D)

Leveling The Ground Using Float (ACS - Handles, SJC - 'H' Pattern)

Figure 109

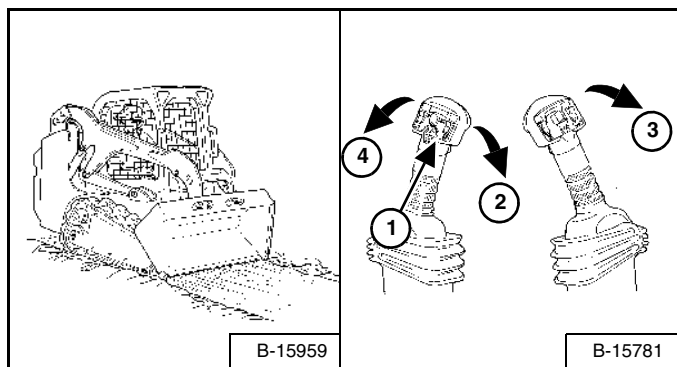

Press and hold the float button (1) [Figure 109] while the lever is in neutral. While lowering the lift arms (2) [Figure 109], release the float button.

Tilt the bucket forward (3) [Figure 109] to change the position of the cutting edge of the bucket.

With the bucket tilted farther forward, there is more force on the cutting edge and more loose material can be moved.

Drive backward to level loose material.

To disengage float, press the float button (1) again or raise the lift arms (4) [Figure 109].

IMPORTANT

Never drive forward when the hydraulic control for lift arms is in float position.

I-2005-1285

OPERATING PROCEDURE (CONT'D)

Digging And Filling A Hole (ACS - Handles, SJC - 'H' Pattern)

Digging

Figure 110

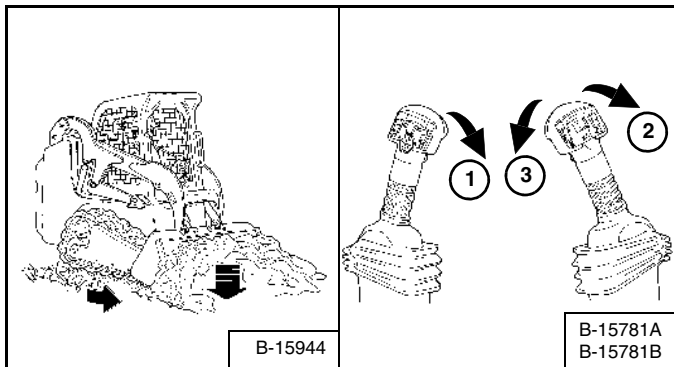

Lower the lift arms all the way (1) [Figure 110]. Tilt the bucket forward (2) [Figure 110] until the cutting edge of the bucket is on the ground.

Drive forward slowly and continue to tilt the bucket down (2) [Figure 110] until it enters the ground.

Tilt the bucket backward a small amount (3) [Figure 110] to increase traction and keep an even digging depth. Continue to drive forward until the bucket is full. When the ground is hard, raise and lower the cutting edge (1 and 2) [Figure 110] while driving forward.

Figure 111

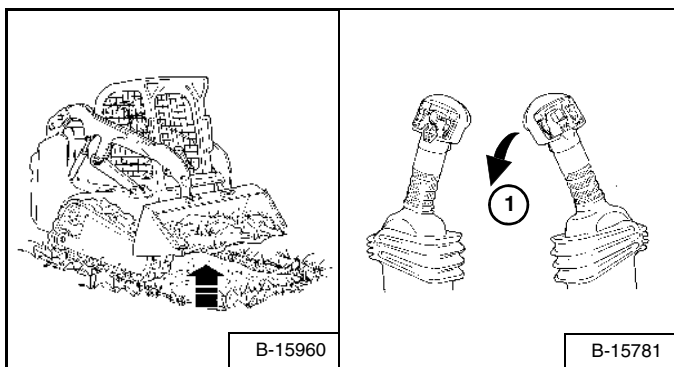

Tilt the bucket backward (1) [Figure 111] as far as it will go when the bucket is full.

Filling The Hole

Figure 112

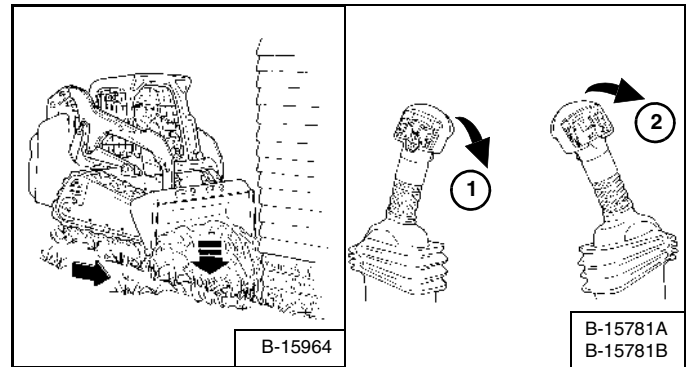

Lower the lift arms (1) [Figure 112] and put the cutting edge of the bucket on the ground (2) [Figure 112]. Drive forward to the edge of the hole to push the material into the hole.

Tilt the bucket forward (2) [Figure 112] as soon as it is past the edge of the hole.

If necessary, raise the lift arms to empty the bucket.

OPERATING PROCEDURE (CONT'D)

Filling And Emptying The Bucket (SJC - 'ISO' Pattern)

Filling

Figure 113

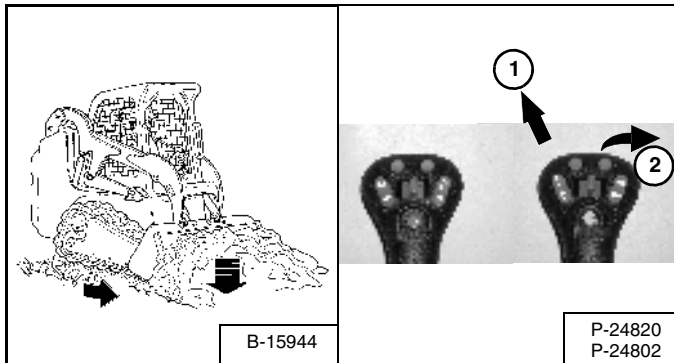
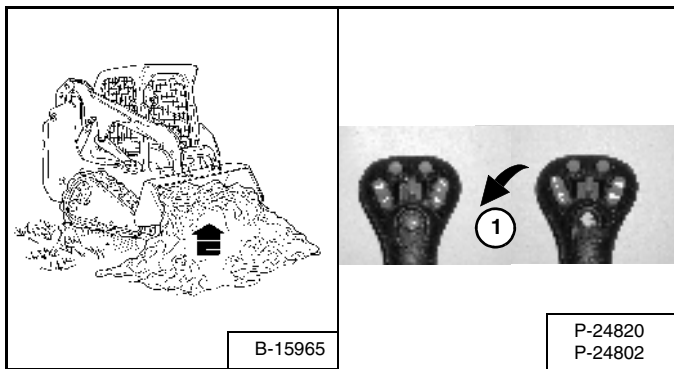

Figure 114



Lower the lift arms all the way (1) [Figure 113].

Tilt the bucket forward (2) [Figure 113] until the cutting edge of the bucket is on the ground.

Drive slowly forward into the material. Tilt the bucket backward (1) [Figure 114] all the way when the bucket is full.

Drive backward away from the material.

WARNING

Load, unload and turn on flat level ground. Do not exceed Rated Operating Capacity shown on sign (decal) in cab. Failure to obey warnings can cause the machine to tip or roll over and cause injury or death.

W-2056-0903

Emptying

Figure 115

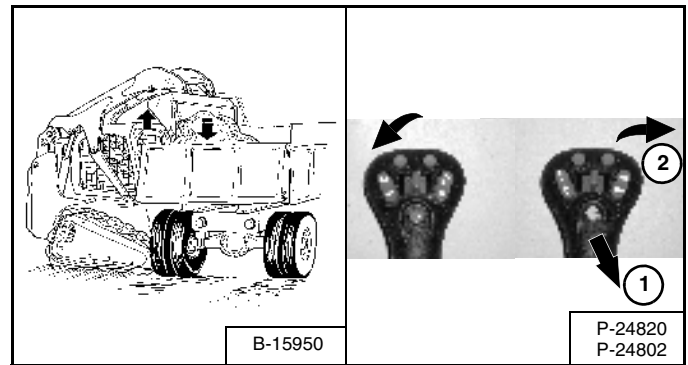

Keep the bucket low when moving to the area where you want to empty the bucket.

Raise the lift arms (1) [Figure 115]. Level the bucket (2) [Figure 115] while raising the lift arms to help prevent material from falling off the back of the bucket.

Drive forward slowly until the bucket is over the top of the truck box or bin.

Empty the bucket (2) [Figure 115]. If all material is near the side of the truck or bin, use the bucket tilt to move it to the other side.

WARNING

Never dump over an obstruction, such as a post, that can enter the operator cab. The machine could tip forward and cause injury or death.

W-2057-0694

OPERATING PROCEDURE (CONT'D)

Leveling The Ground Using Float (SJC - 'ISO' Pattern)

Figure 116

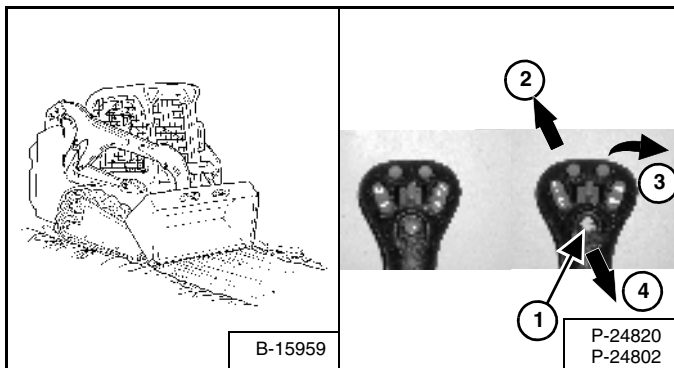

Press and hold the float button (1) [Figure 116] while the joystick is in neutral. While lowering the lift arms (2) [Figure 116], release the float button.

Tilt the bucket forward (3) [Figure 116] to change the position of the cutting edge of the bucket.

With the bucket tilted farther forward, there is more force on the cutting edge and more loose material can be moved.

Drive backward to level loose material.

To disengage, press the float button (1) again or raise the lift arms (4) [Figure 116].

IMPORTANT

Never drive forward when the hydraulic control for lift arms is in float position.

I-2005-1285

OPERATING PROCEDURE (CONT'D)

Digging And Filling A Hole (SJC - 'ISO' Pattern)

Digging

Figure 117

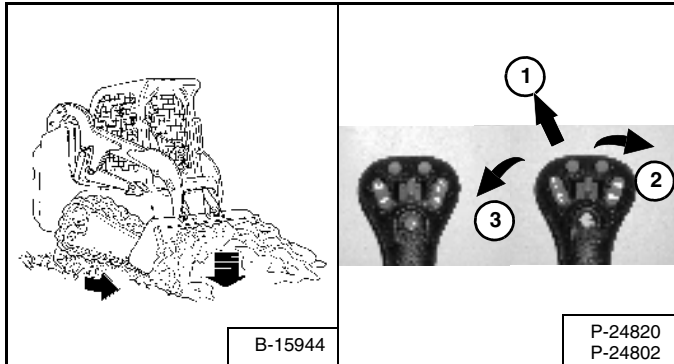

Lower the lift arms all the way (1) [Figure 117]. Put the cutting edge of the bucket on the ground (2) [Figure 117].

Drive forward slowly and continue to tilt the bucket down (2) [Figure 117] until it enters the ground.

Raise the cutting edge a small amount (3) [Figure 117] to increase traction and keep an even digging depth. Continue to drive forward until the bucket is full. When the ground is hard, raise and lower the cutting edge (2 and 3) [Figure 117] while driving forward.

Figure 118

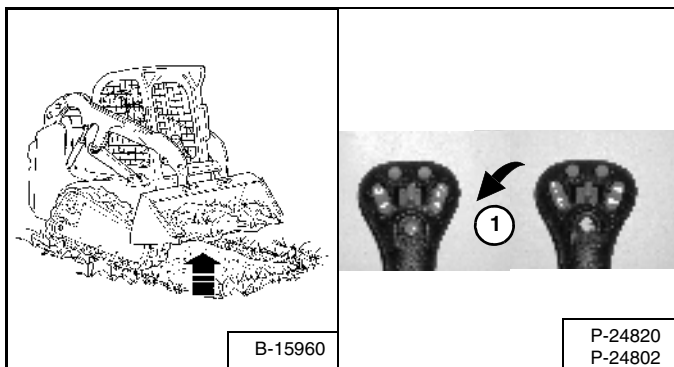

Tilt the bucket backward (1) [Figure 118] as far as it will go when the bucket is full.

Filling

Figure 119

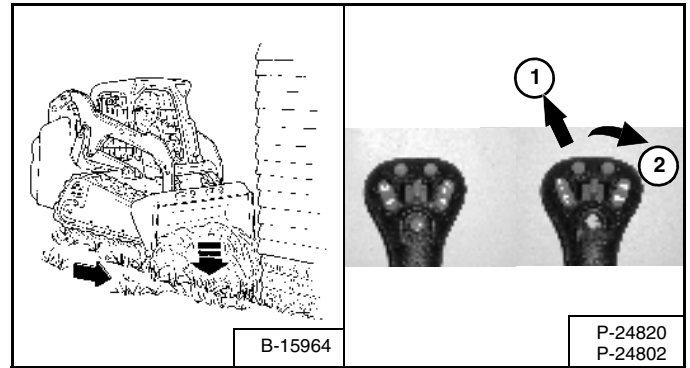

Lower the lift arms (1) [Figure 119] and put the cutting edge of the bucket on the ground (2) [Figure 119]. Drive forward to the edge of the hole to push the material into the hole.

Tilt the bucket forward (2) [Figure 119] as soon as it is past the edge of the hole.

If necessary, raise the lift arms to empty the bucket.

TOWING THE LOADER

Procedure

Because of the design of the loader, there is not a recommended towing procedure.

- The loader can be lifted onto a transport vehicle.
- The loader can be skidded a short distance to move for service (EXAMPLE: Move onto a transport vehicle) without damage to the hydrostatic system. (The tires / tracks will not turn.) There might be slight wear to the tires / tracks when the loader is skidded.

The towing chain (or cable) must be rated at 1 & 1/2 times the weight of the loader (See Machine Rating on Page 122).

LIFTING THE LOADER

Single Point Lift

! WARNING

AVOID INJURY OR DEATH

- Before lifting, check fasteners on single point lift and operator cab.
- Assemble front cab fasteners as shown in this manual.
- Never allow riders in the cab or bystanders within 5 m while lifting the machine.

W-2007-0497

The loader can be lifted with the Single Point Lift which is available as a kit from your Bobcat Loader dealer.

Figure 120

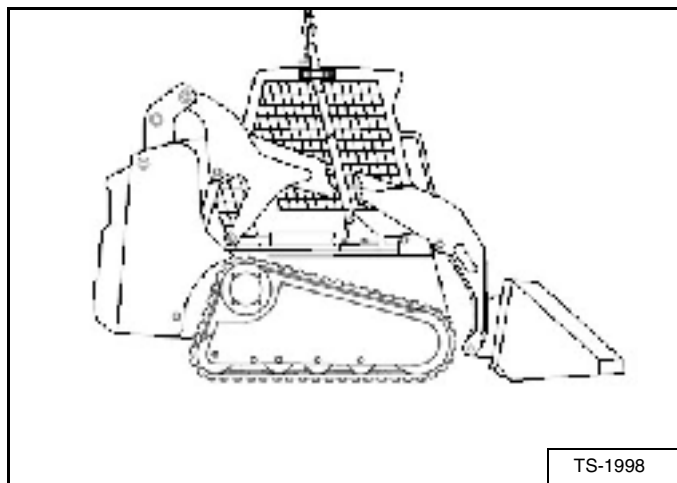

Install the kit as explained in the Instructions with the kit and attach lift as shown [Figure 120].

The Single Point Lift, supplied by Bobcat, is designed to lift and support the Bobcat Loader without affecting roll over and falling object protection features of the operator cab.

Four Point Lift

! WARNING

AVOID INJURY OR DEATH

- Before lifting, check fasteners on four point lift.
- Never allow riders in the cab or bystanders within 5 m while lifting the machine.

W-2160-0694

The loader can be lifted with the Four Point Lift which is available as a kit from your Bobcat Loader dealer. The backhoe mounting kit must also be installed to provide lift points at the front of the loader.

Figure 121

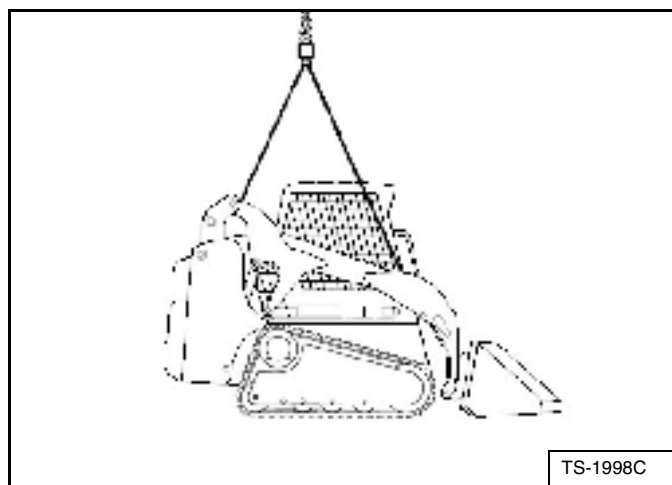

Attach cables or chains to lift eyes [Figure 121].

TRANSPORTING THE LOADER ON A TRAILER

Loading And Unloading

! WARNING

Adequately designed ramps of sufficient strength are needed to support the weight of the machine when loading onto a transport vehicle. Wood ramps can break and cause personal injury.

W-2058-0494

Be sure the transport and towing vehicles are of adequate size and capacity. For weight of loader (See Weights on Page 122.)

Figure 122

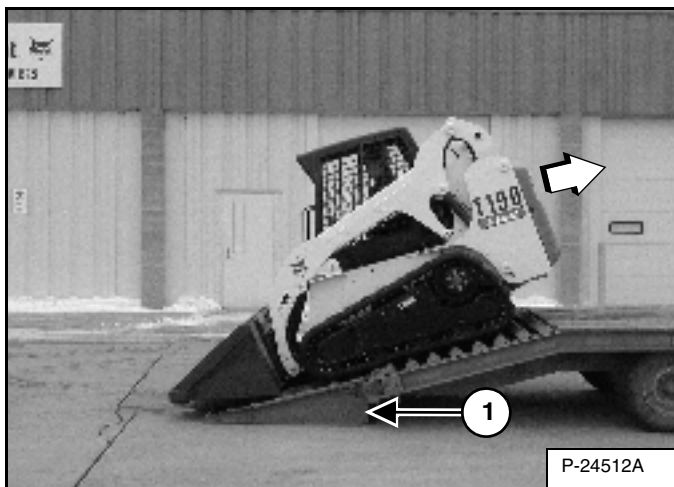

A loader with an empty bucket or no attachment must be loaded backward onto the transport vehicle [Figure 122].

The rear of the trailer must be blocked or supported (1) [Figure 122] when loading or unloading the loader to prevent the front end of the trailer from raising up.

Fastening

Figure 123

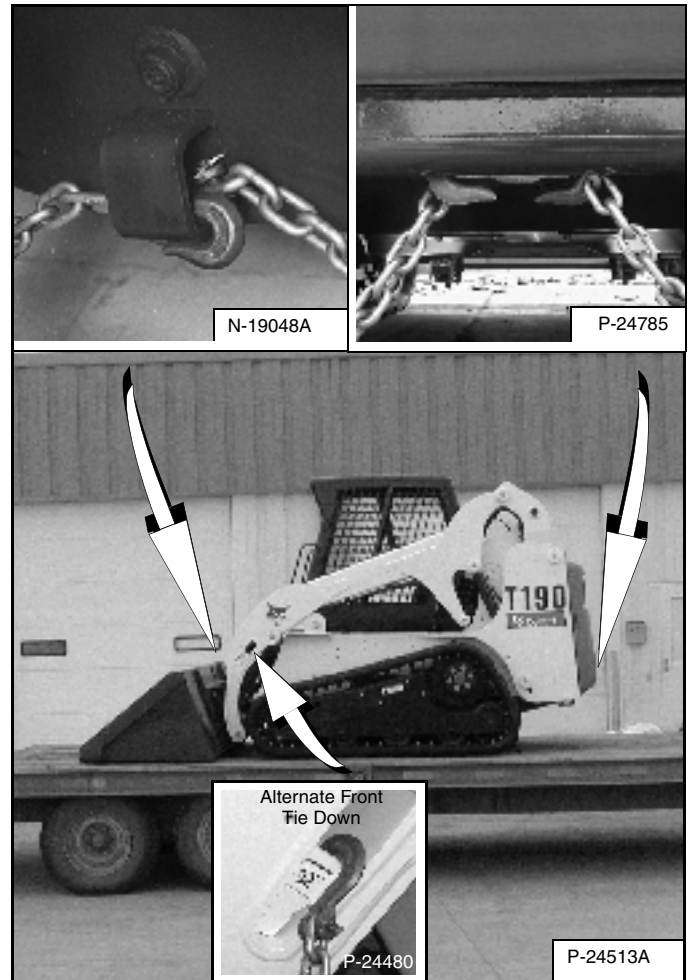

Use the following procedure to fasten the Bobcat Loader to the transport vehicle to prevent the loader from moving during sudden stops or when going up or down slopes [Figure 123].

- Lower the bucket or attachment to the floor.
- Stop the engine.
- Engage the parking brake.
- Install chains at the front and rear loader tie down positions (Inset) [Figure 123].
- Fasten each end of the chain to the transport vehicle.



Bobcat®

PREVENTIVE MAINTENANCE

AIR CLEANER SERVICE	80
Replacing Filter Elements	80
AIR CONDITIONING BELT	99
Belt Adjustment	99
Belt Replacement	99
ALTERNATOR BELT	98
Belt Adjustment	98
Belt Replacement	98
BOB-TACH (HAND LEVER)	104
Inspection and Maintenance	104
BOB-TACH (POWER - OPTION)	105
Inspection and Maintenance	105
BOBCAT INTERLOCK CONTROL SYSTEM (BICS)	68
Inspecting Deactivation Of Lift And Tilt Functions (ACS and SJC)	69
Inspecting Deactivation Of The Auxiliary Hydraulics System (Engine STOPPED - Key ON)	68
Inspecting The BICS Controller (Engine STOPPED - Key ON)	68
Inspecting The Lift Arm By-Pass Control	69
Inspecting The Seat Bar Sensor (Engine RUNNING)	68
Inspecting The Traction Lock (Engine RUNNING)	69
DRIVE BELT	100
Belt Adjustment	100
Belt Replacement	100
ELECTRICAL SYSTEM	87
Battery Maintenance	88
Description	87
Fuse And Relay Location / Identification	87
Removing And Installing The Battery	90
Using A Booster Battery (Jump Starting)	89
ENGINE COOLING SYSTEM	85
Checking Level	85
Cleaning	85
Removing And Replacing Coolant	86
ENGINE LUBRICATION SYSTEM	84
Checking And Adding Engine Oil	84
Engine Oil Chart	84
Removing And Replacing Oil And Filter	84
FUEL SYSTEM	82
Filling the Fuel Tank	82
Fuel Filter	83
Fuel Specifications	82
Removing Air From The Fuel System	83

**PREVENTIVE
MAINTENANCE**

PREVENTIVE MAINTENANCE (CONT'D)

HEATING AND AIR CONDITIONING	79
Air Conditioning Lubrication.....	79
Cleaning and Maintenance.....	79
Evaporator	79
Filters.....	79
Troubleshooting	79
HYDRAULIC / HYDROSTATIC SYSTEM.....	91
Breather Cap	94
Checking And Adding Fluid	91
Hydraulic / Hydrostatic Fluid Chart.....	91
Removing And Replacing Fan Hydraulic Filter	94
Removing And Replacing Hydraulic / Hydrostatic Filter	92
Removing And Replacing Hydraulic Fluid and Case Drain Filters.....	93
HYDROSTATIC MOTOR CARRIER LUBRICATION	98
Removing And Replacing Oil.....	98
LIFT ARM SUPPORT DEVICE	72
Installing	72
Removing	73
LOADER STORAGE AND RETURN TO SERVICE	106
Return to Service.....	106
Storage	106
LUBRICATING THE LOADER	101
Lubrication Locations.....	101
MAINTENANCE SAFETY	65
OPERATOR CAB	74
Cab Door Sensor (If Equipped)	76
Description.....	74
Lowering	75
Raising.....	74
PIVOT PINS	103
Inspection And Maintenance	103
REAR DOOR	77
Adjusting.....	77
Opening And Closing.....	77
REAR GRILL.....	78
Installing	78
Removing	78
SEAT BAR RESTRAINT SYSTEM	70
Description.....	70
Inspecting	70
Maintaining	70

PREVENTIVE MAINTENANCE (CONT'D)

SEAT BELT	71
Inspection and Maintenance	71
SERVICE SCHEDULE	67
Chart	67
SPARK ARRESTOR MUFFLER	95
Cleaning Procedure	95
TRACK ROLLER AND IDLER LUBRICATION	101
Procedure	101
TRACK SPROCKET MAINTENANCE	98
Tightening Procedure.....	98
TRACK TENSION	96
Adjusting	96



Bobcat®

MAINTENANCE SAFETY



Instructions are necessary before operating or servicing machine. Read and understand the Operation & Maintenance Manual, Operator's Handbook and signs (decals) on machine. Follow warnings and instructions in the manuals when making repairs, adjustments or servicing. Check for correct function after adjustments, repairs or service. Untrained operators and failure to follow instructions can cause injury or death.

W-2003-0903



Safety Alert Symbol: This symbol with a warning statement, means: "Warning, be alert! Your safety is involved!" Carefully read the message that follows.

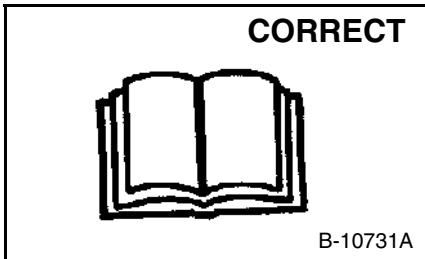

B-10731A

- ⚠ Never service the Bobcat Skid-Steer Loader without instructions.

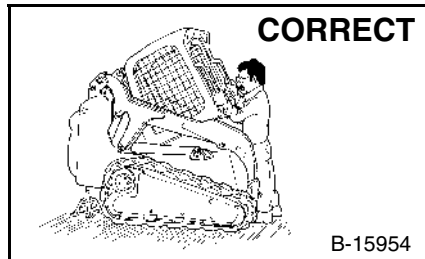

B-15954

- ⚠ Use the correct procedure to lift or lower operator cab.

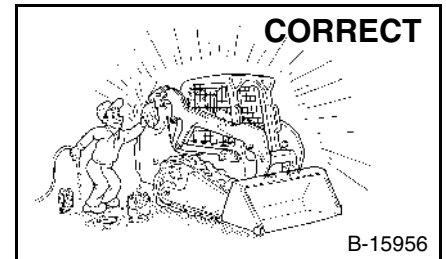

B-15956

- ⚠ Cleaning and maintenance are required daily.

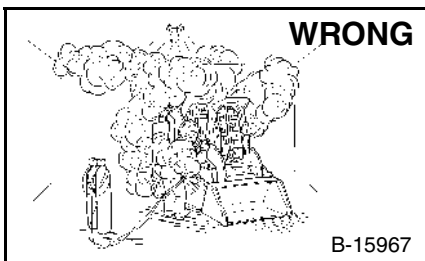

B-15967

- ⚠ Have good ventilation when welding or grinding painted parts.
- ⚠ Wear dust mask when grinding painted parts. Toxic dust and gas can be produced.
- ⚠ Avoid exhaust fume leaks which can kill without warning. Exhaust system must be tightly sealed.

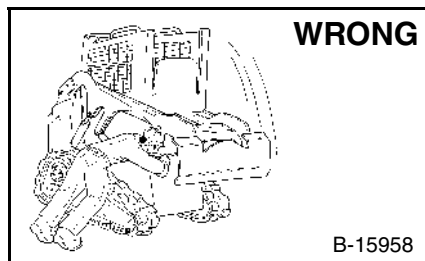

B-15958

- ⚠ Disconnecting or loosening any hydraulic tubeline, hose, fitting, component or a part failure can cause lift arms to drop. Do not go under lift arms when raised unless supported by an approved lift arm support device. Replace it if damaged.

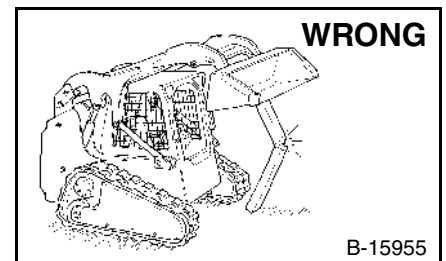

B-15955

- ⚠ Never work on loader with lift arms up unless lift arms are held by an approved lift arm support device. Replace if damaged.
- ⚠ Never modify equipment or add attachments not approved by Bobcat Company.

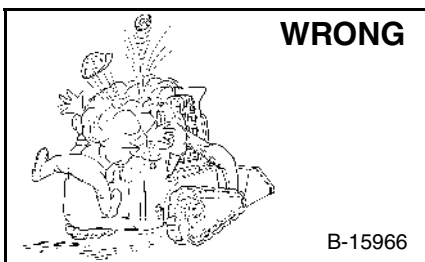

B-15966

- ⚠ Stop, cool and clean engine of flammable materials before checking fluids.
- ⚠ Never service or adjust loader with the engine running unless instructed to do so in the manual.
- ⚠ Avoid contact with leaking hydraulic fluid or diesel fuel under pressure. It can penetrate the skin or eyes.
- ⚠ Never fill fuel tank with engine running, while smoking or when near open flame.

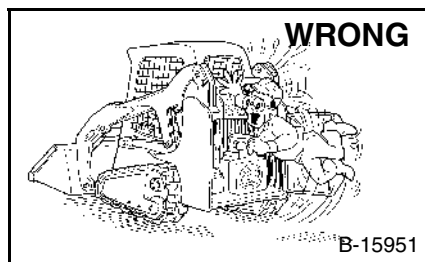

B-15951

- ⚠ Keep body, jewelry and clothing away from moving parts, electrical contact, hot parts and exhaust.
- ⚠ Wear eye protection to guard from battery acid, compressed springs, fluids under pressure and flying debris when engines are running or tools are used. Use eye protection approved for type of welding.
- ⚠ Keep rear door closed except for service. Close and latch door before operating the loader.

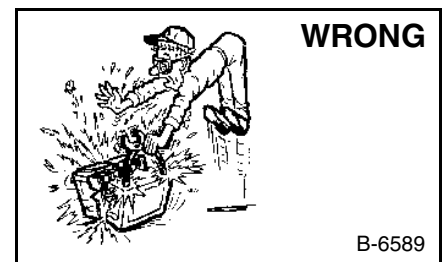

B-6589

- ⚠ Lead-acid batteries produce flammable and explosive gases.
- ⚠ Keep arcs, sparks, flames and lighted tobacco away from batteries.
- ⚠ Batteries contain acid which burns eyes or skin on contact. Wear protective clothing. If acid contacts body, flush well with water. For eye contact flush well and get immediate medical attention.

Maintenance procedures which are given in the Operation & Maintenance Manual can be performed by the owner / operator without any specific technical training. Maintenance procedures which are **not** in the Operation & Maintenance Manual must be performed **ONLY BY QUALIFIED BOBCAT SERVICE PERSONNEL**. Always use **genuine Bobcat replacement parts**. The Service Safety Training Course is available from your Bobcat dealer.

MSW11-0805



Bobcat®

SERVICE SCHEDULE

Chart

Maintenance work must be done at regular intervals. Failure to do so will result in excessive wear and early failures. The service schedule is a guide for correct maintenance of the Bobcat loader.

 <h1 style="margin: 0;">WARNING</h1>	<p>Instructions are necessary before operating or servicing machine. Read and understand the Operation & Maintenance Manual, Operator's Handbook and signs (decals) on machine. Follow warnings and instructions in the manuals when making repairs, adjustments or servicing. Check for correct function after adjustments, repairs or service. Untrained operators and failure to follow instructions can cause injury or death.</p>
---	--

W-2003-0903

SERVICE SCHEDULE		HOURS					
ITEM	SERVICE REQUIRED	8-10	50	100	■ 250	■ 500	■ 1000
Engine Oil	Check the oil level and add as needed. Do not overfill.						
Engine Air Filter and Air System	Check display panel. Service only when required. Check for leaks and damaged components.						
Engine Cooling System	Clean debris from oil cooler, radiator & grill. Check coolant level COLD and add premixed coolant as needed.						
Fuel Filter	Remove the trapped water.						
Lift Arms, Cylinders, Bob-Tach Pivot Pins and Wedges	Lubricate with multi-purpose lithium based grease.						
Seat Bar, Control Interlocks, Seat Belt, Seat Belt Retractors	Check the condition of seat belt. Clean or replace seat belt retractors as needed. Check the seat bar and control interlocks for correct operation. Clean dirt and debris from moving parts.						
Bobcat Interlock Control Systems (BICST™)	Check that four BICST™ indicator lights and functions are activated. See details in this Manual.						
Safety Signs and Safety Treads	Check for damaged signs (decals) and safety treads. Replace any signs or safety treads that are damaged or worn.						
Operator Cab	Check the fastening bolts, washers and nuts. Check the condition of the cab.						
Indicators and Lights	Check for correct operation of all indicators and lights.						
Heater and A/C Filters (If Equipped)	Clean or replace filters as needed.						
Hydraulic Fluid, Hoses and Tubelines	Check fluid level and add as needed. Check for damage and leaks. Repair or replace as needed.						
Tracks	Check for damaged or worn tracks and correct tension.	☐					
Track Sprocket Bolts	Check torque. Tighten as needed. See procedure in this manual.		*				
Foot Pedals or Hand Controls, and Steering Levers	Check for correct operation. Repair or adjust as needed.						
Parking Brake	Check operation.						
Spark Arrestor Muffler	Clean the spark chamber.						
Battery	Check cables, connections and electrolyte level. Add distilled water as needed.						
Steering Lever Pivots	Grease fittings.						
Fuel Filter	Replace filter element.						
Engine / Hydro. Drive Belt	Check for wear or damage.		○				
Alternator Belt & Air Conditioner Belt (If Equipped)	Check condition and tension. Adjust or replace as needed.						
Bobcat Interlock Control System (BICST™)	Check the function of the lift arm by-pass control.						
Engine Oil and Filter	Replace oil and filter. Use CD or better grade oil and Bobcat filter.		*				
Hydraulic / Hydrostatic Filter, Charge Filter, Reservoir Breather	Replace the hydrostatic filter, charge filter and the reservoir breather.		▼				
Engine Valves	Adjust the engine valves.						
Hydraulic Reservoir	Replace the fluid.						
Case Drain Filters	Replace the filters.						
Hydrostatic Motor Carrier	Replace oil with high performance synthetic oil P / N 6682546.						
Coolant	Replace the coolant.						Every 2 years

- Or every 12 months.
- ☐ Check every 8-10 hours for the first 50 hours, then 50 hour intervals thereafter.
- * Check after the first 50 hours of operation only.
- Inspect the new belt after first 50 hours.
- ▼ Replace the hydraulic / hydrostatic filter element after the first 50 hours; and thereafter when the transmission warning light comes ON while operating or at the 500 hour interval.
- * First oil and filter change must occur at 50 hours; 250 hours thereafter.

BOBCAT INTERLOCK CONTROL SYSTEM (BICS)

Inspecting The BICS Controller (Engine STOPPED - Key ON)

Figure 124

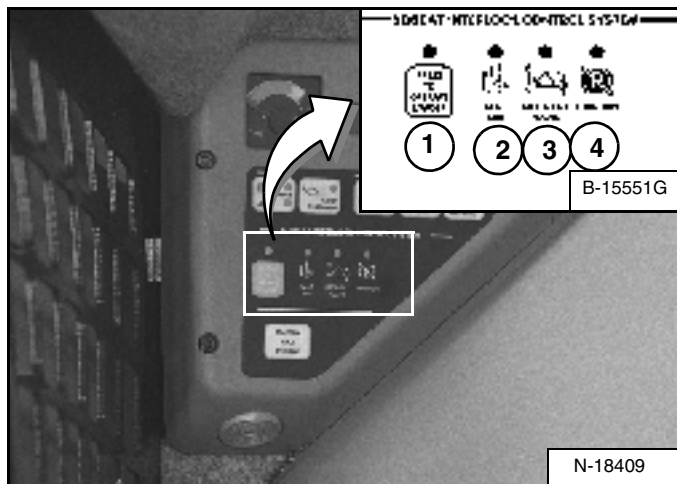

1. Sit in operator's seat. Turn key ON (*Key Switch Panel*), press RUN / ENTER Button (*Keyless Panel*), lower seat bar and disengage parking brake. Press the PRESS TO OPERATE LOADER Button. Three BICS lights (1, 2 and 3) [PRESS TO OPERATE LOADER, SEAT BAR, and LIFT & TILT VALVE] on left instrument panel should be ON [Figure 124].
2. Raise seat bar fully. All four BICS lights (1, 2, 3 and 4) [PRESS TO OPERATE LOADER, SEAT BAR, LIFT & TILT VALVE and TRACTION*] on left instrument panel should be OFF [Figure 124].

NOTE: Record what lights are blinking (if any) and the number of light flashes. (See BOBCAT INTERLOCK CONTROL SYSTEM (BICS) on Page 109.)

Inspecting Deactivation Of The Auxiliary Hydraulics System (Engine STOPPED - Key ON)

3. Sit in operator's seat, lower seat bar, and press the PRESS TO OPERATE LOADER Button. Press the auxiliary hydraulics FLOW Button. The auxiliary FLOW Button light will come ON. Raise the seat bar. The light should be OFF.

Inspecting The Seat Bar Sensor (Engine RUNNING)

4. Sit in operator's seat, lower seat bar, engage parking brake and fasten seat belt.
5. Start engine and operate at low idle. Press the PRESS TO OPERATE LOADER Button. While raising the lift arms, raise the seat bar fully. The lift arms should stop. Repeat using the tilt function.

BOBCAT INTERLOCK CONTROL SYSTEM (BICS) (CONT'D)

Inspecting The Traction Lock (Engine RUNNING)

6. Fasten seat belt, disengage parking brake, press the PRESS TO OPERATE LOADER Button and raise seat bar fully. Move steering levers slowly forward and backward. The TRACTION lock should be engaged. Lower the seat bar. Press the PRESS TO OPERATE LOADER Button.
7. Engage parking brake and move steering levers slowly forward and backward. The TRACTION lock should be engaged.

NOTE: * The TRACTION light on the left instrument panel will remain OFF until the engine is started, the PRESS TO OPERATE LOADER Button is pressed and the parking brake is disengaged.

Inspecting The Lift Arm By-Pass Control

8. Raise the lift arms 2 meters off the ground. Stop engine. Turn lift arm by-pass control knob clockwise 1/4 turn. Pull up and hold lift arm by-pass control knob until lift arms slowly lower.

Inspecting Deactivation Of Lift And Tilt Functions (ACS and SJC)

9. Sit in operator's seat and fasten seat belt. Lower seat bar, start engine and press the PRESS TO OPERATE LOADER Button.
10. Raise lift arms about 2 meters off the ground.
11. Turn key OFF (*Key Switch Panel*), press STOP Button (*Keyless Panel*), and wait for the engine to come to a complete stop.
12. Turn key ON (*Key Switch Panel*), press RUN / ENTER Button (*Keyless Panel*). Press the PRESS TO OPERATE LOADER Button, move hand control or joystick to lower the lift arms. Lift arms should not lower.
13. Move the control (foot pedal, hand control or joystick) to tilt the bucket (or attachment) forward. The bucket (or attachment) should not tilt forward.



WARNING

AVOID INJURY OR DEATH

The Bobcat Interlock Control System (BICS) must deactivate the lift, tilt and traction drive functions. If it does not, contact your dealer for service. DO NOT modify the system.

W-2151-0394

SEAT BAR RESTRAINT SYSTEM

Description

The seat bar restraint system has a pivoting seat bar with arm rests.

The operator controls the use of the seat bar. The seat bar in the down position helps to keep the operator in the seat.

Models with foot pedals have hydraulic valve spool interlocks for the lift and tilt functions. The spool interlocks require the operator to lower the seat bar in order to operate the foot pedal controls.

When the seat bar is down, the PRESS TO OPERATE LOADER Button is activated and the engine is running, the lift, tilt and traction drive functions can be operated.

When the seat bar is up, the lift and tilt control pedals are locked when returned to the NEUTRAL position.

Models with the Advanced Control System (ACS) have mechanical interlocks for the handles and pedals. The interlocks for the handles and pedals require the operator to lower the seat bar in order to operate the selected controls.

When the seat bar is down, the PRESS TO OPERATE LOADER button is activated and the engine is running, the lift, tilt and traction drive functions can be operated using the selected controls (handles, or foot pedals).

When the seat bar is up, the handles and pedals are locked when returned to the NEUTRAL position.

Models with Selectable Joystick Control (SJC) have electrical deactivation of joystick functions. Activation of functions require the operator to lower the seat bar.

When the seat bar is down, the PRESS TO OPERATE LOADER button is activated and the engine is running, the lift, tilt and traction drive functions can be operated.

When the seat bar is up, the joystick functions are deactivated even though the joystick does not mechanically lock.

Inspecting

Sit in the seat and fasten the seat belt. Engage the parking brake. Pull the seat bar all the way down. Start the engine. Press the PRESS TO OPERATE LOADER Button.

Operate the hydraulic controls to check that both the lift and tilt functions operate correctly. Raise the lift arms until the attachment is about 600 mm off the ground.

Raise the seat bar. Move the hydraulic controls. Pedals and handles (if equipped) must be firmly locked in the NEUTRAL position (except joysticks). There must be no motion of the lift arms or tilt (attachment) when the controls are moved.

Lower the seat bar, press the PRESS TO OPERATE LOADER Button, lower the lift arms. Operate the lift control. While the lift arms are going up, raise the seat bar. The lift arms must stop.

Lower the seat bar, press the PRESS TO OPERATE LOADER Button, lower the lift arms and put the attachment flat on the ground. Stop the engine. Raise the seat bar. Operate the foot pedals and handles (if equipped) to be sure they are firmly locked in the NEUTRAL position (except joysticks).

Maintaining

See the SERVICE SCHEDULE for correct service interval. (See SERVICE SCHEDULE on Page 67.)

Figure 125

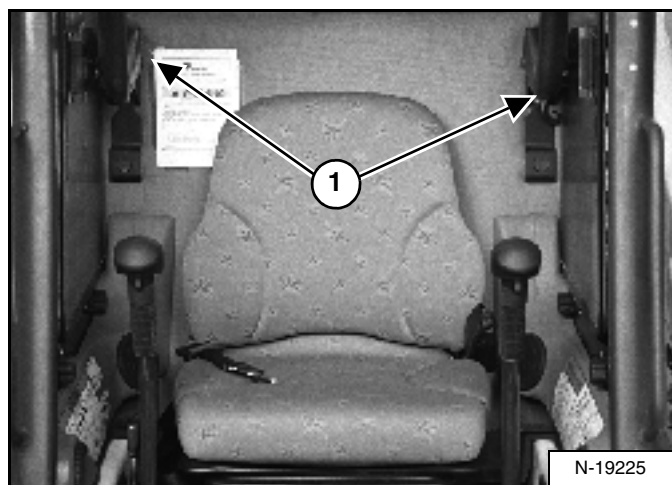

Use compressed air to clean any debris or dirt from the pivot parts (1) [Figure 125]. Do not lubricate. Inspect all mounting hardware. The correct bolt torque is 35 Nm.

If the seat bar system does not function correctly, replace parts that are worn or damaged. Use only genuine Bobcat replacement parts.

WARNING

The seat bar system must deactivate the lift and tilt control functions when the seat bar is up. Service the system if hydraulic controls do not deactivate.

W-2465-0703

SEAT BELT

Inspection and Maintenance

WARNING

Failure to properly inspect and maintain the seat belt can cause lack of operator restraint resulting in serious injury or death.

W-2466-0703

Check the seat belt daily for correct function.

Inspect the seat belt system thoroughly yearly or more often if the machine is exposed to severe environmental conditions or applications.

The seat belt system should be repaired or replaced if it shows cuts, fraying, extreme or unusual wear, significant discolorations due to ultraviolet (UV) rays from the sun, dusty / dirty conditions, abrasion to the seat belt webbing, or damage to the buckle, latch plate, retractor (if equipped), or hardware.

The items below are referenced in **[Figure 126]**.

1. Check the seat belt webbing. If the system is equipped with a retractor, pull the webbing completely out and inspect the full length of the webbing. Look for cuts, wear, fraying, dirt and stiffness.
2. Check the buckle and latch for proper function. Make sure latch plate is not excessively worn, deformed or buckle is not damaged.
3. Check the retractor web storage device (if equipped) by extending the seat belt webbing to determine if it extends and retracts the webbing correctly.
4. Check webbing in areas exposed to ultraviolet (UV) rays from the sun or extreme dust or dirt. If the original color of the webbing in these areas is extremely faded and / or the webbing is packed with dirt, the webbing strength may have weakened.

See your Bobcat dealer for approved seat belt system replacement parts for your machine.

Figure 126

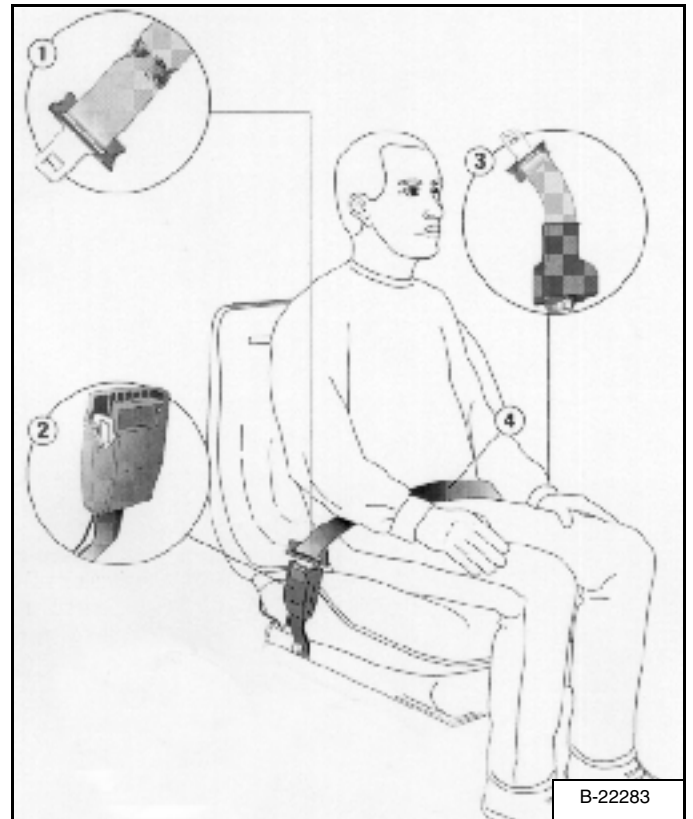

LIFT ARM SUPPORT DEVICE

Installing

⚠ WARNING

Never work on a machine with the lift arms up unless the lift arms are secured by an approved lift arm support device. Failure to use an approved lift arm support device can allow the lift arms or attachment to fall and cause injury or death.

W-2059-0598

⚠ WARNING

Service lift arm support device if damaged or if parts are missing. Using a damaged lift arm support or with missing parts can cause lift arms to drop causing injury or death.

W-2271-1197

The operator must be in the operator's seat, with the seat belt fastened and seat bar lowered, until the lift arm support device is installed.

Start the engine, and raise the lift arms all the way up.

Figure 128

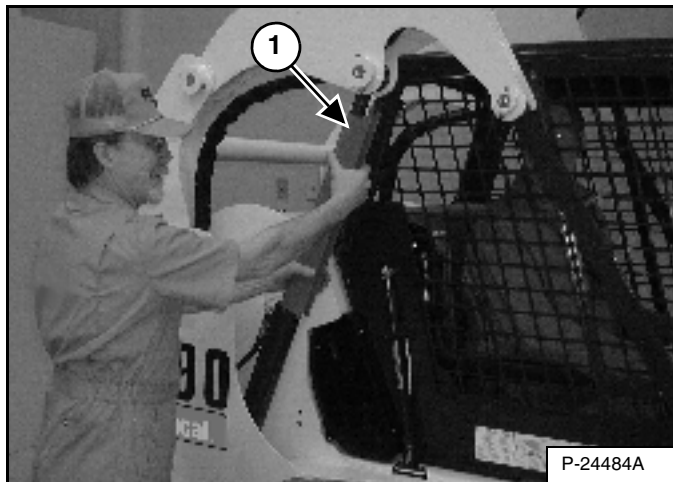

Have a second person install the lift arm support device (1) [Figure 128] over the rod of one of the lift cylinders.

The lift arm support device must be tight against the cylinder rod.

Figure 129

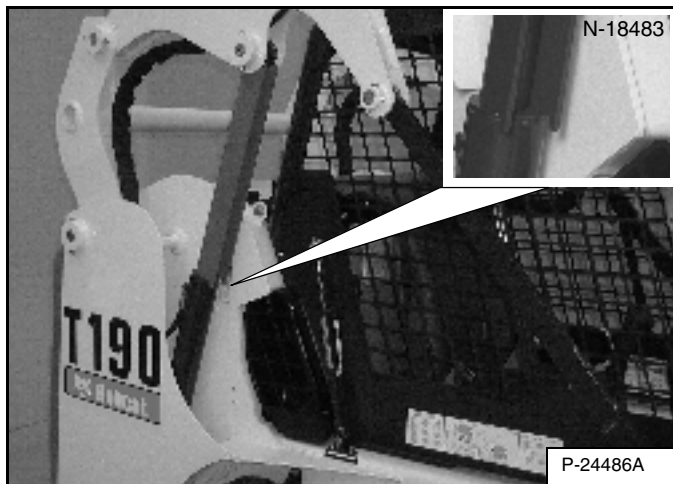

Lower the lift arms slowly until the lift arm support device is held between the lift arms and the lift cylinder [Figure 129]. The tabs of the lift arm support device must go under the cylinder (Inset) [Figure 129].

Figure 127

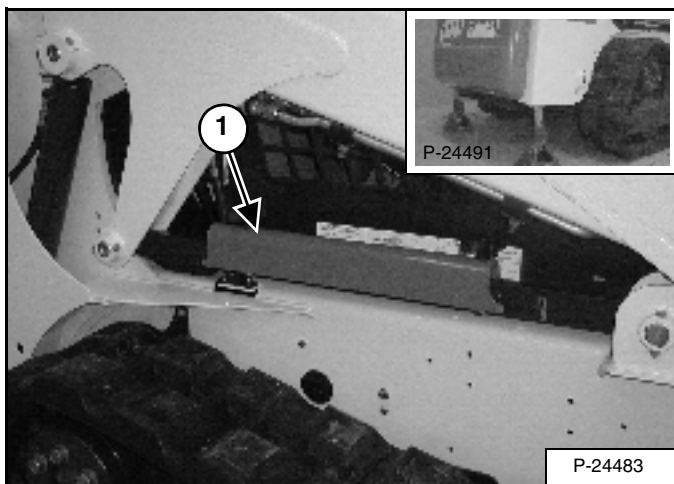

Put jackstands under the rear corners of the loader frame (Inset) [Figure 132].

Remove the lift arm support device (1) [Figure 127] from storage position.

LIFT ARM SUPPORT DEVICE (CONT'D)

Removing

The operator must be in the operator's seat, with the seat belt fastened and seat bar lowered, until the lift arm support device is removed and the lift arms are lowered all the way.

Start the engine, raise the lift arms all the way up.

Have a second person remove the lift arm support device.

Lower the lift arms all the way and stop the engine.

Return the lift arm support device to storage position and secure with clamping knobs.

Remove the jackstands.

OPERATOR CAB

Description

The Bobcat Loader has an operator cab (ROPS and FOPS) as standard equipment to protect the operator from rollover and falling objects. Check with your dealer if the operator cab has been damaged. The seat belt must be worn for rollover protection.

ROPS / FOPS - Roll Over protective Structure per SAE J1040 and ISO 3471, and Falling Object Protective Structure per SAE J1043 and ISO 3449, Level I. Level II is available.

Level I

Protection from falling bricks, small concrete blocks, and hand tools encountered in operations such as highway maintenance, landscaping, and other construction sites.

Level II

Protection from falling trees, rocks: for machines involved in site clearing, overhead demolition or forestry.

Raising

Always stop the engine before raising or lowering the cab.

Stop the loader on a level surface. Lower the lift arms. If the lift arms must be up while raising the operator cab, install the lift arm support device. (See LIFT ARM SUPPORT DEVICE on Page 72.)

Figure 130



Install jackstands under the rear of the loader frame [Figure 130].

Figure 131

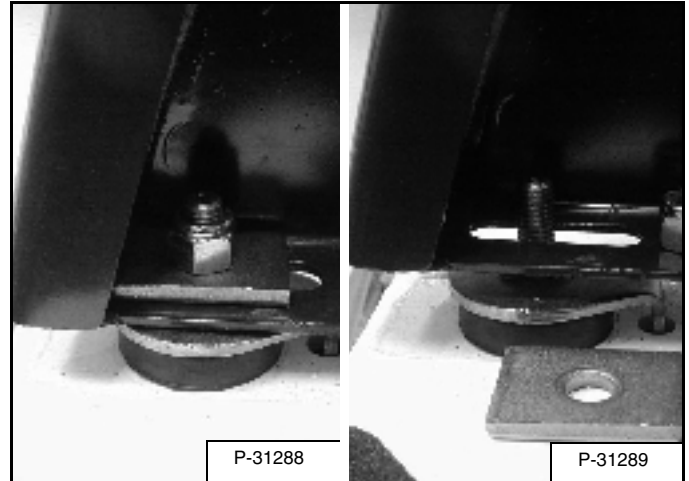

Remove the nuts and plates [Figure 131] (both sides) at the front corners of the cab.

Figure 132

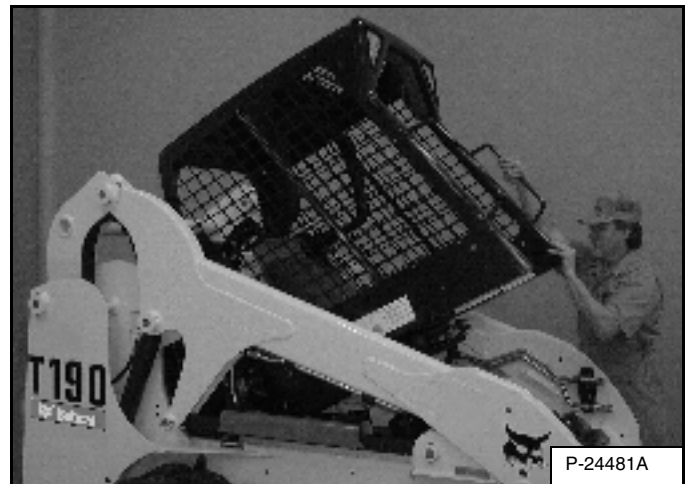

Lift on the grab handles and bottom of the operator cab [Figure 132] slowly until the cab is all the way up and the latching mechanism engages.

Advanced Control System (ACS)



OPERATOR CAB (CONT'D)

Raising (Cont'd)

! WARNING

Never modify operator cab by welding, grinding, drilling holes or adding attachments unless instructed to do so by Bobcat. Changes to the cab can cause loss of operator protection from rollover and falling objects, and result in injury or death.

W-2069-1299

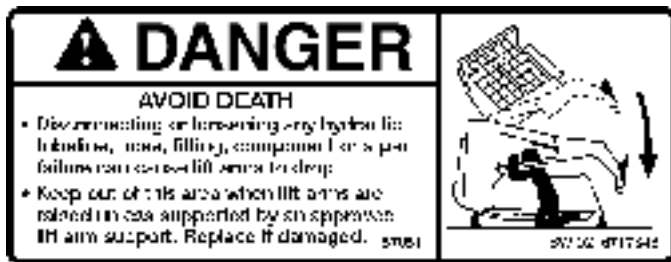

Lowering

Always stop the engine before raising or lowering the cab.

NOTE: Always use the grab handles to lower the cab.

Figure 133

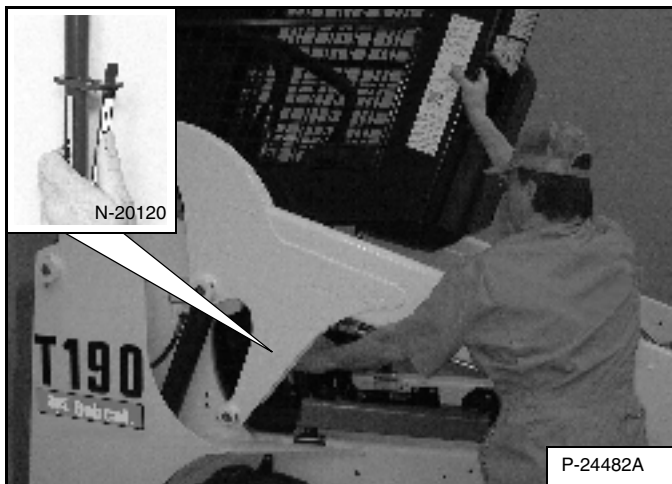

Pull down on the bottom of the operator cab until it stops at the latching mechanism [Figure 133].

NOTE: The weight of the cab increases when equipped with options and accessories such as cab door, heater, air conditioning, etc. In these cases, the cab may need to be raised slightly from the latch to be able to release the latch.

Support the cab and release the latching mechanism (Inset) [Figure 133]. Remove your hand from latching mechanism when the cab is past the latch stop. Use both hands to lower the cab all the way.

! WARNING

PINCH POINT CAN CAUSE INJURY

Remove your hand from the latching mechanism when the cab is past the latch stop.

W-2469-0803

Figure 134

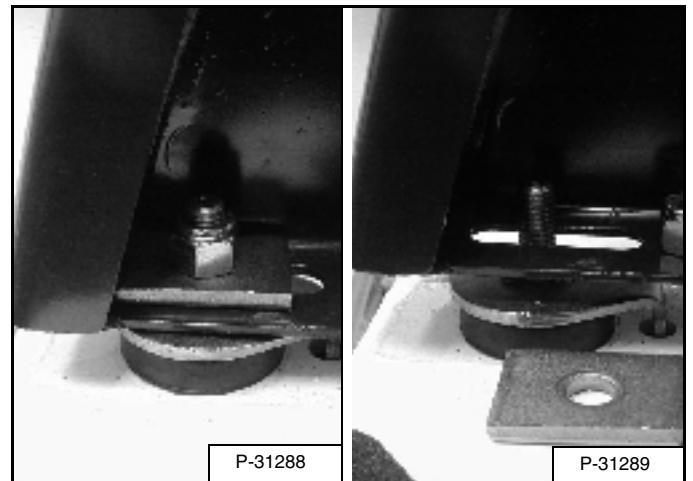

Install the plates and nuts [Figure 134] (both sides).

Tighten the nuts to 54-68 Nm torque.

OPERATOR CAB (CONT'D)

Cab Door Sensor (If Equipped)

Figure 135

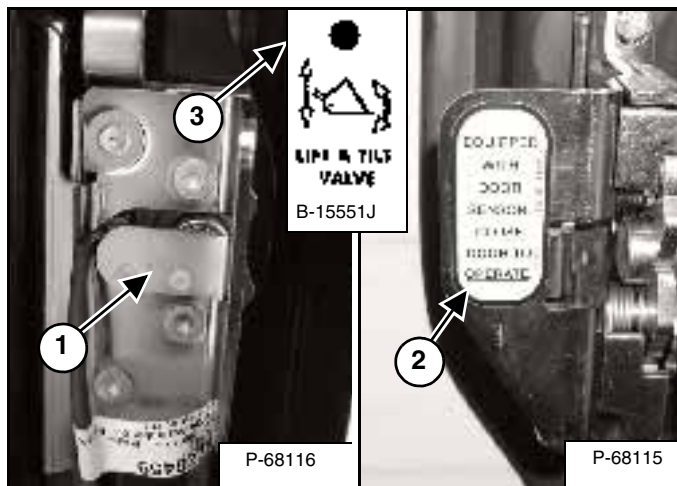

The cab door has a sensor (1) [Figure 135] installed which deactivates the lift and tilt valves when the door is open.

A decal is located on the latch mechanism (2) [Figure 135]. Close door to operate lift and tilt valves

The LIFT & TILT VALVE light (3) [Figure 135] will be ON when the door is closed and the PRESS TO OPERATE LOADER button is pressed.

REAR DOOR

Opening And Closing

! WARNING

AVOID INJURY OR DEATH

Never service or adjust the machine when the engine is running unless instructed to do so in the manual.

W-2012-0497

Figure 136

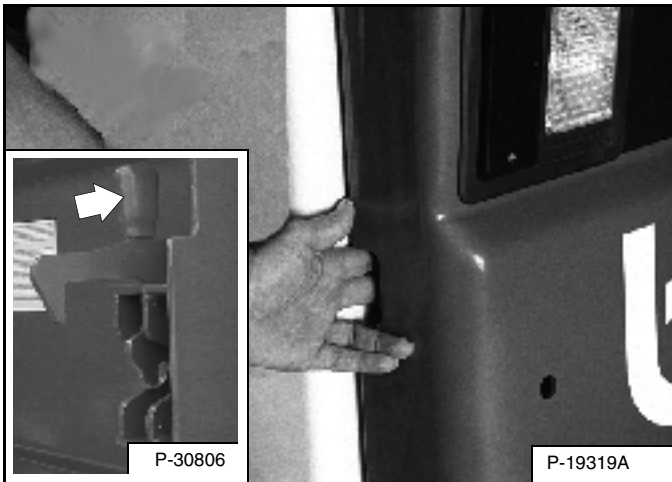

Reach into the slot in the rear door and pull the latch handle [Figure 136].

Pull the rear door open.

Figure 137

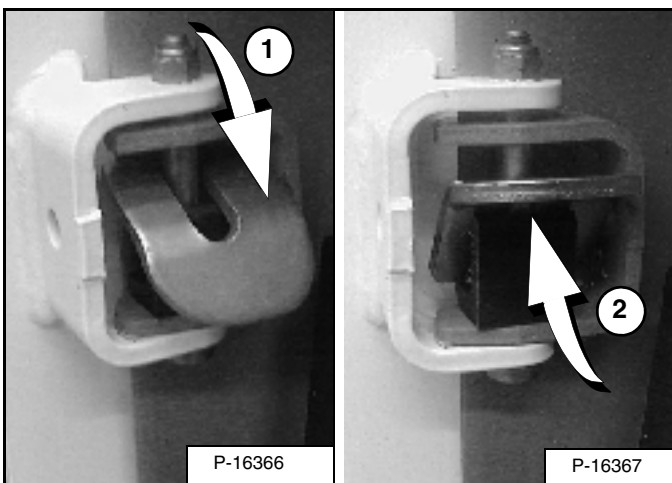

Move the door stop into the engaged position (1) [Figure 137] to hold the door open. Move to disengaged position (2) [Figure 137] allow the door to close.

Close the door.

! WARNING

Keep the rear door closed when operating the machine. Failure to do so could seriously injure a bystander.

W-2020-1285

Adjusting

Figure 138

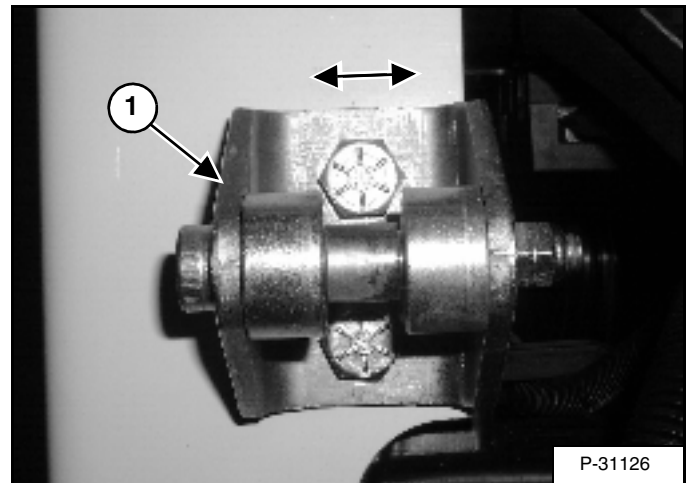

The door latch (1) [Figure 138] can be adjusted side to side for alignment with the door latch mechanism.

REAR GRILL

Removing

Open the rear door.

Figure 139

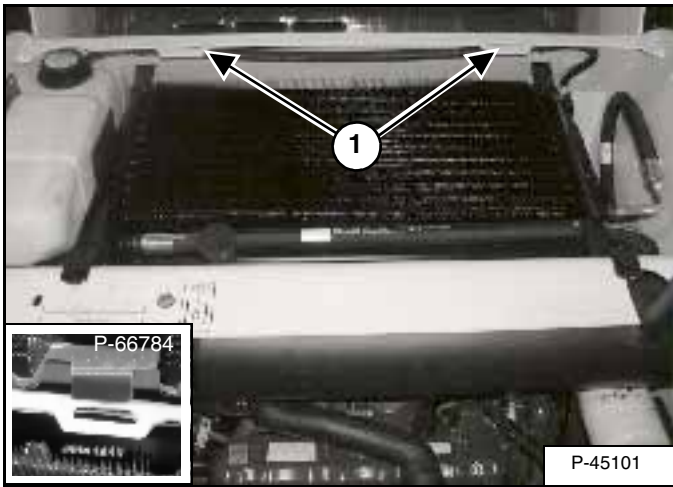

Lift and pull the rear grill and remove it from the loader [Figure 139].

Installing

Align the tabs of the rear grill into the slots in the loader frame (Inset & 1) [Figure 139].

Lower the rear grill.

HEATING AND AIR CONDITIONING

Close the rear door before operating the loader.

Cleaning and Maintenance

The heater and air conditioning system require regular inspection and maintenance. (See SERVICE SCHEDULE on Page 67.)

Filters

Figure 140

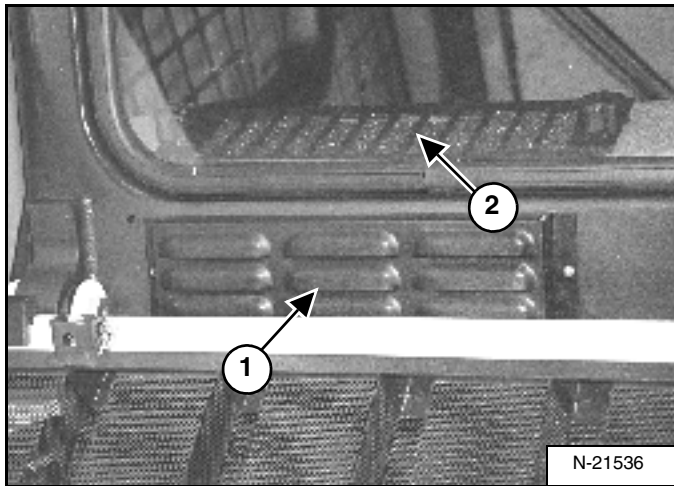

The *Fresh Air Filter* is located below the rear window of the cab (1) [Figure 140].

Remove the bolts, the filter housing, and the filter.

Shake the filter or use low air pressure to remove dirt.

Reinstall the filter, housing and bolts.

The *Recirculation Filter* is located in front of the rear window inside the cab (2) [Figure 140].

Remove the clamping knobs, grill and filter.

Clean the filter with water and mild detergent. Reinstall the filter, grill and clamping knobs.

Evaporator

Figure 141

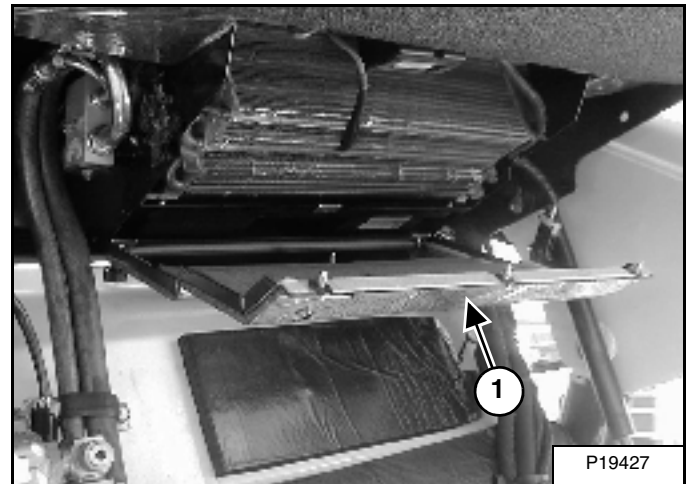

Raise the cab and remove the evaporator cover (1) [Figure 141].

Use low pressure water or air to remove debris from the evaporator fins.

Install the cover.

Lower and secure the cab.

Air Conditioning Lubrication

Run the air conditioner for about 5 minutes every week to lubricate the internal components.

Troubleshooting

If the fan does not run, or the air conditioning does not turn on, check the fuse. (See ELECTRICAL SYSTEM on Page 87.)

If the air conditioning system circulates warm air, the refrigerant may need to be recharged.

AIR CLEANER SERVICE

Replacing Filter Elements

Figure 142

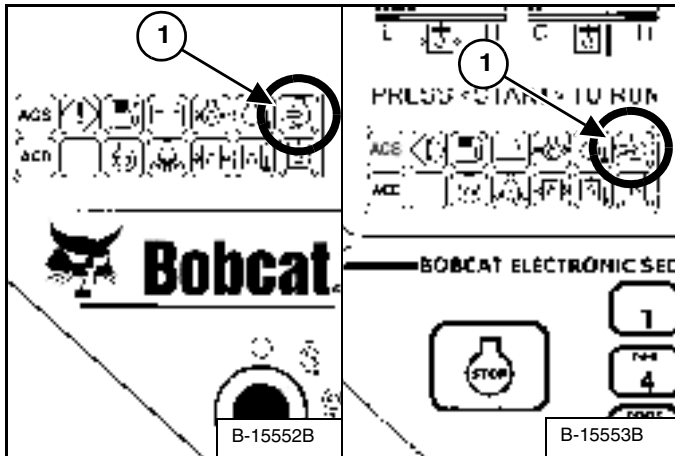

It is important to change the air filter element only when the Air Cleaner Icon in the right panel is ON (1) [Figure 142] and you hear three beeps from the alarm.

Replace the inner filter every third time the outer filter is replaced or as indicated.

Figure 143

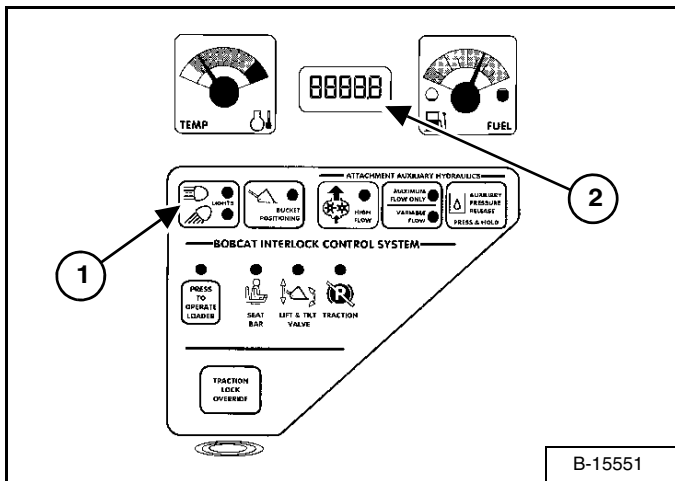

Press and hold the LIGHT Button (1) [Figure 143] for two seconds.

If the filter element needs replacement, the CODE [01-17] (Air Filter Plugged) will show in the HOURMETER / CODE DISPLAY (2) [Figure 143].

Outer Filter

Figure 144

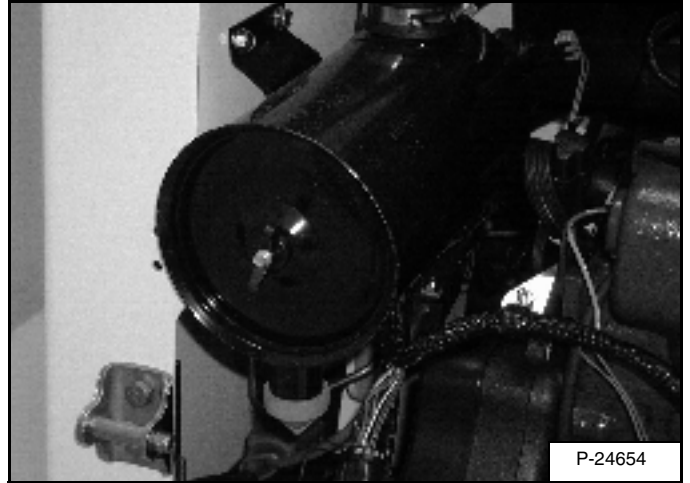

Remove the wing nut and remove the dust cover [Figure 144].

Figure 145

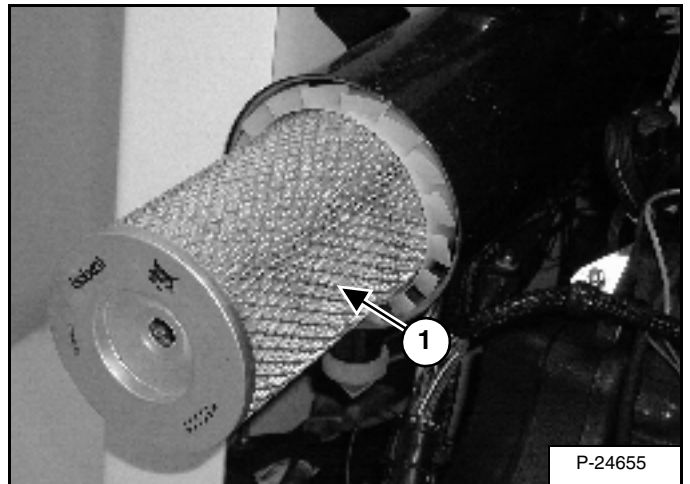

Remove the wing nut and remove the outer filter element (1) [Figure 145].

NOTE: Make sure all sealing surfaces are free of dirt and debris. Do not use air pressure to clean.

Install new filter. Push all the way in until it contacts the base of the housing. Install wing nut.

Install the dust cover and the wing nut [Figure 144].

Check the air intake hose and the air cleaner housing for damage. Make sure all connections are tight.

AIR CLEANER SERVICE (CONT'D)

Replacing Filter Elements (Cont'd)

Inner Filter

Only replace the inner filter element under the following conditions:

- Replace the inner filter element every *third* time the outer filter is replaced.
- After the outer element has been replaced, start the engine and run at full RPM. If the HOURMETER / CODE DISPLAY shows [01-17] (**Air Filter Plugged**), replace the inner filter element.

Figure 146

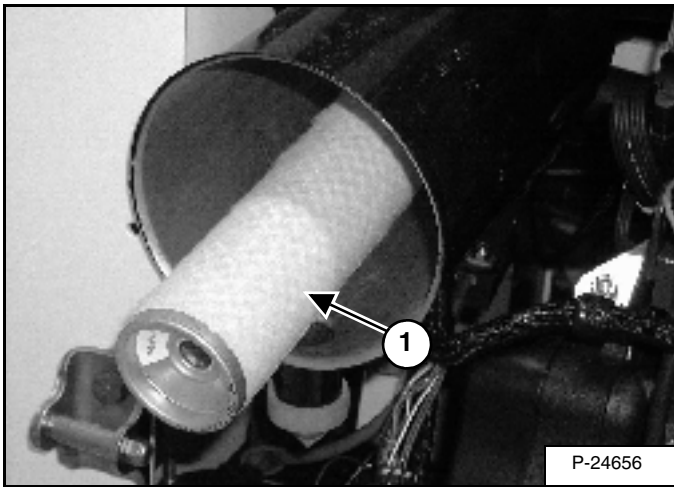

Remove the inner filter element (1) [Figure 146].

NOTE: Make sure all sealing surfaces are free of dirt and debris.

Install the new inner element [Figure 146].

Figure 147

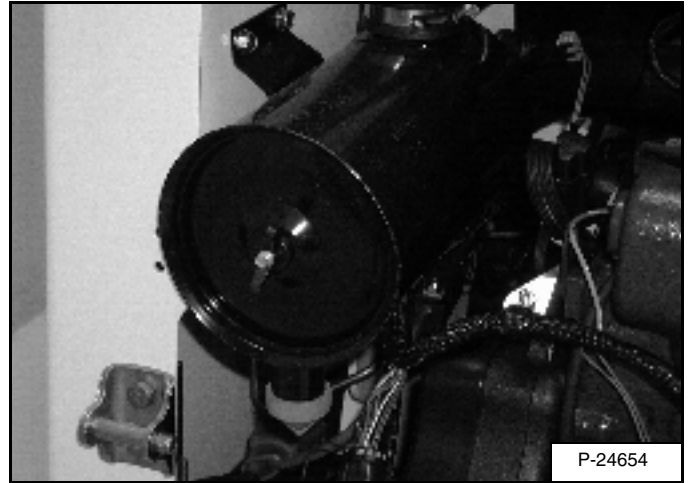

Install the dust cover and the wing nut [Figure 147].

FUEL SYSTEM

Fuel Specifications

Use only clean, high quality diesel fuel, Grade No. 2 or Grade No. 1.

The following is one suggested blending guideline which should prevent fuel gelling during cold temperatures:

TEMPERATURE C° (F°)	NO. 2	NO. 1
-9° (+15°)	100%	0%
Down to -29° (-20°)	50%	50%
Below -29° (-20°)	0%	100%

Contact your fuel supplier for local recommendations.

Filling the Fuel Tank

WARNING

Stop and cool the engine before adding fuel. **NO SMOKING!** Failure to obey warnings can cause an explosion or fire.

W-2063-0887

Open the rear door.

Figure 148

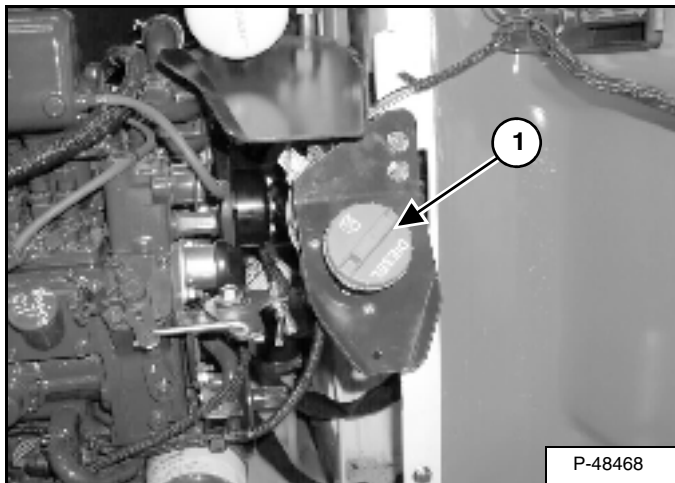

Remove the fuel fill cap (1) [Figure 148].

Figure 149

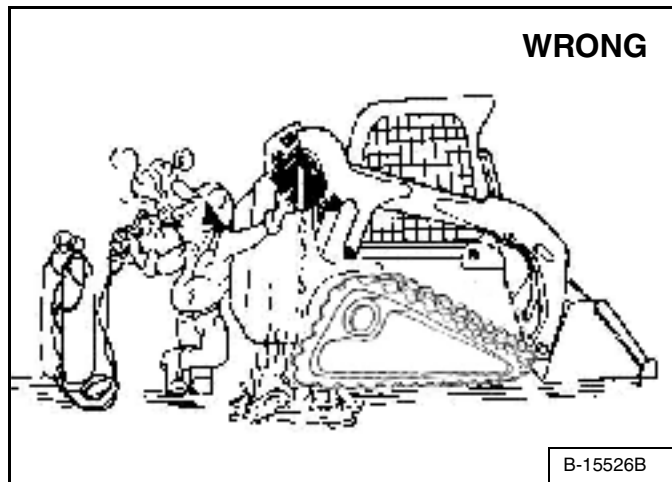

Use a clean, approved safety container to add fuel of the correct specifications. Add fuel only in an area that has free movement of air and no open flames or sparks. **NO SMOKING [Figure 149]!**

Install and tighten the fuel cap (1) [Figure 148].

WARNING

Always clean up spilled fuel or oil. Keep heat, flames, sparks or lighted tobacco away from fuel and oil. Failure to use care around combustibles can cause explosion or fire which can result in injury or death.

W-2103-1285

FUEL SYSTEM (CONT'D)

Fuel Filter

For the service interval for removing water from, or replacing the fuel filter (See SERVICE SCHEDULE on Page 67).

Removing Water

Figure 150

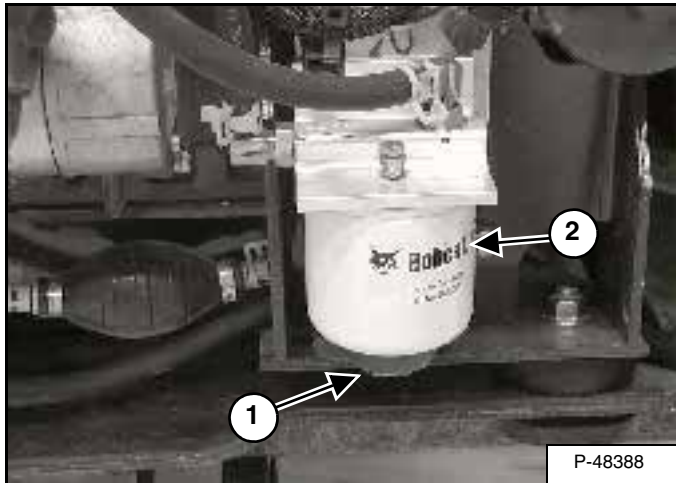

Loosen the drain (1) [Figure 150] at the bottom of the filter element to remove water from the filter.

Replacing Element

Remove the filter element (2) [Figure 150].

Clean the area around the filter housing. Put clean oil on the seal of the new filter element. Install the fuel filter, and hand tighten.

Remove the air from the fuel system. (See Removing Air From The Fuel System on Page 83.)

WARNING

Always clean up spilled fuel or oil. Keep heat, flames, sparks or lighted tobacco away from fuel and oil. Failure to use care around combustibles can cause explosion or fire which can result in injury or death.

W-2103-1285

Removing Air From The Fuel System

After replacing the filter element or when the fuel tank has run out of fuel, the air must be removed from the fuel system before starting the engine.

WARNING

Diesel fuel or hydraulic fluid under pressure can penetrate skin or eyes, causing serious injury or death. Fluid leaks under pressure may not be visible. Use a piece of cardboard or wood to find leaks. Do not use your bare hand. Wear safety goggles. If fluid enters skin or eyes, get immediate medical attention from a physician familiar with this injury.

W-2072-0496

Figure 151

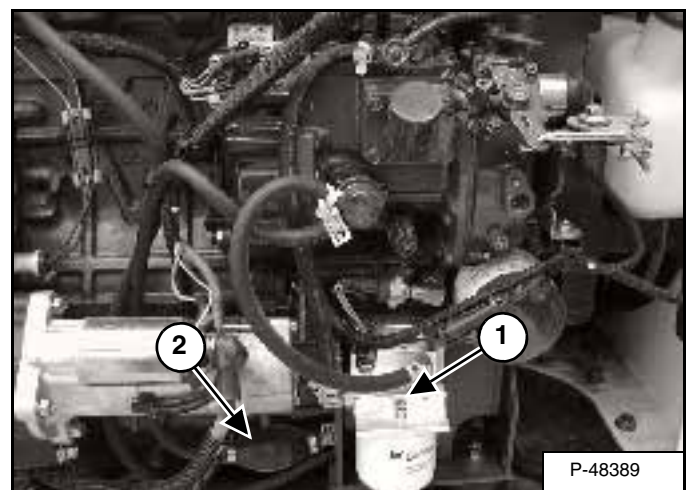

Open the vent (1) [Figure 151] on the fuel filter housing.

Squeeze the hand pump (priming bulb) (2) [Figure 151] until fuel flows from the vent with no air bubbles.

Close the vent (1) [Figure 151].

ENGINE LUBRICATION SYSTEM

Checking And Adding Engine Oil

Check the engine oil level every day before starting the engine for the work shift.

Figure 152

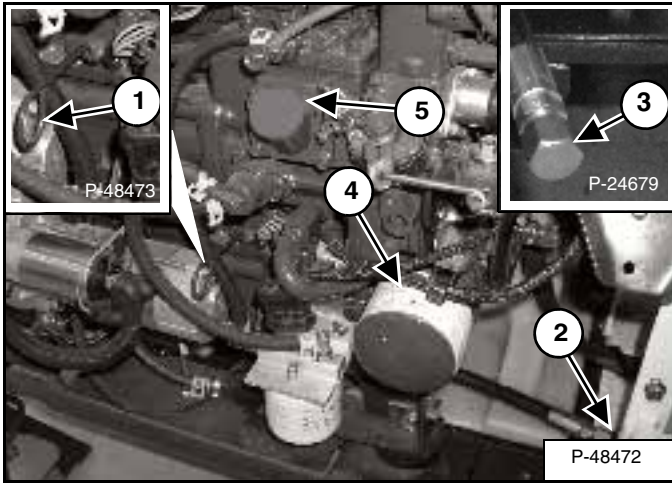

Park the machine on level ground. Open the rear door and remove the dipstick (1) [Figure 152].

Keep the oil level between the marks on the dipstick. Do not overfill.

Engine Oil Chart

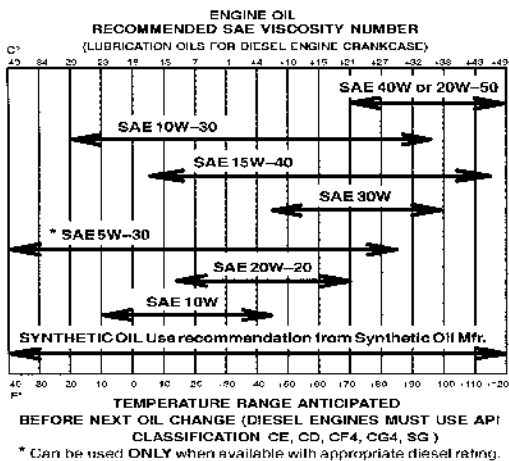

Use good quality motor oil that meets API Service Classification of CD or better.

Install the dipstick and close the rear door.

Removing And Replacing Oil And Filter

For the service interval for replacing the engine oil and filter. (See SERVICE SCHEDULE on Page 67.)

Run the engine until it is at operating temperature. Stop the engine.

Open the rear door and remove the drain hose from its storage position (2) [Figure 152].

Remove the drain plug (3) [Figure 152] and drain the oil into a container and recycle or dispose of used oil in an environmentally safe manner.

Remove the oil filter (4) [Figure 152] and clean the filter housing surface.

Put oil on the new filter gasket, install the filter and hand tighten.

Install and tighten the drain plug.

Remove the fill cap (5) [Figure 152].

Put oil in the engine. For the correct quantity (See Fluid Capacities on Page 124). Do not overfill.

Start the engine and let it run for several minutes. Stop the engine and check for leaks at the filter.

Remove the dipstick (1) [Figure 152] and check the oil level.

Add oil as needed if it is not at the top mark on the dipstick.

Install the dipstick and close the rear door.



Always clean up spilled fuel or oil. Keep heat, flames, sparks or lighted tobacco away from fuel and oil. Failure to use care around combustibles can cause explosion or fire which can result in injury or death.

W-2103-1285

ENGINE COOLING SYSTEM

Cleaning

! WARNING

Wear safety glasses to prevent eye injury when any of the following conditions exist:

- When fluids are under pressure.
- Flying debris or loose material is present.
- Engine is running.
- Tools are being used.

W-2019-1285

Check the cooling system every day to prevent overheating, loss of performance or engine damage.

Remove the rear grill. (See REAR GRILL on Page 78.)

Figure 153

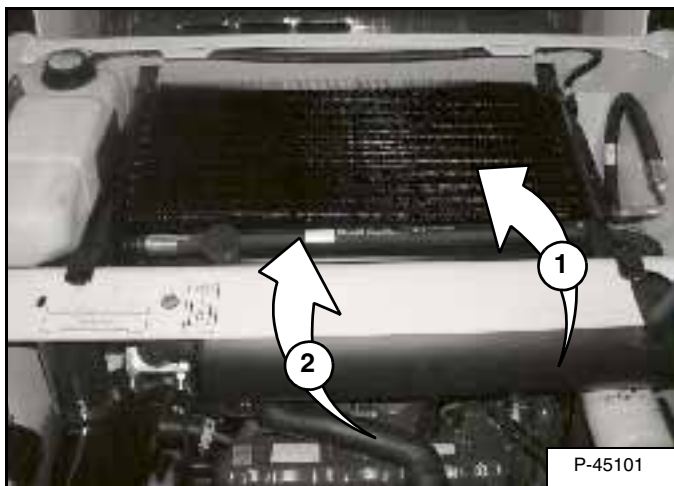

Use low air pressure or water pressure to clean the top of the oil cooler (1) [Figure 153].

NOTE: Be careful when raising and lowering the oil cooler so that the oil cooler does not fall on the radiator and damage the fins.

Raise the oil cooler and use low air pressure or water pressure to clean the top of the radiator (2) [Figure 153].

Lower the oil cooler.

Check the cooling system for leaks.

Install the rear grill. (See REAR GRILL on Page 78.)

Checking Level

Open the rear door and raise the rear grill.

NOTE: The machine uses a pressurized coolant recovery system.

Figure 154

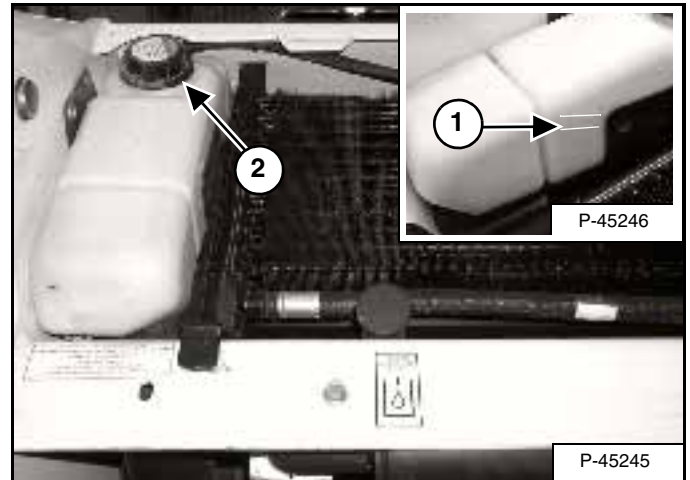

Check the coolant level on the side of the recovery tank (1) [Figure 154]. The level must be between the MIN and MAX marks.

Remove the cover (2) [Figure 154] from the coolant recovery tank.

Add premixed coolant to the recovery tank and install the cover.

IMPORTANT

AVOID ENGINE DAMAGE

Always use the correct ratio of water to antifreeze.

Too much antifreeze reduces cooling system efficiency and may cause serious premature engine damage.

Too little antifreeze reduces the additives which protect the internal engine components; reduces the boiling point and freeze protection of the system.

Always add a premixed solution. Adding full strength concentrated coolant can cause serious premature engine damage.

I-2124-0497

ENGINE COOLING SYSTEM (CONT'D)

Removing And Replacing Coolant

Open the rear door and remove the rear grill.

Figure 155

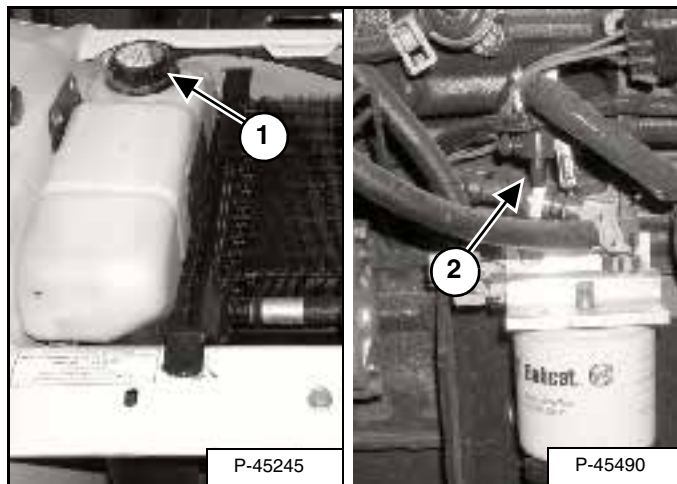

Remove the coolant fill cap (1) [Figure 155].

Connect a hose to the engine block drain (2) [Figure 155]. Drain the coolant into a container. Recycle or dispose of coolant in an environmentally safe manner.

Mix new coolant in a separate container. (See Fluid Capacities on Page 124.)

NOTE: The loader is factory filled with propylene glycol coolant (purple color). DO NOT mix propylene glycol with ethylene glycol.

Add premixed coolant, 47% water and 53% propylene glycol to the recovery tank. (See Checking Level below.)

4,3 L of propylene glycol mixed with 3,8 L of water is the correct mixture of coolant to provide a -37°C (-34°F) freeze protection.

Fill the tank until it is at the lower marker on the tank.

Use a refractometer to check the condition of propylene glycol in your cooling system.

Run the engine until it is at operating temperature. Stop the engine. Check the coolant level when cool. Add coolant as needed.

Install the rear grill and close the rear door.

ELECTRICAL SYSTEM

Description

Figure 156

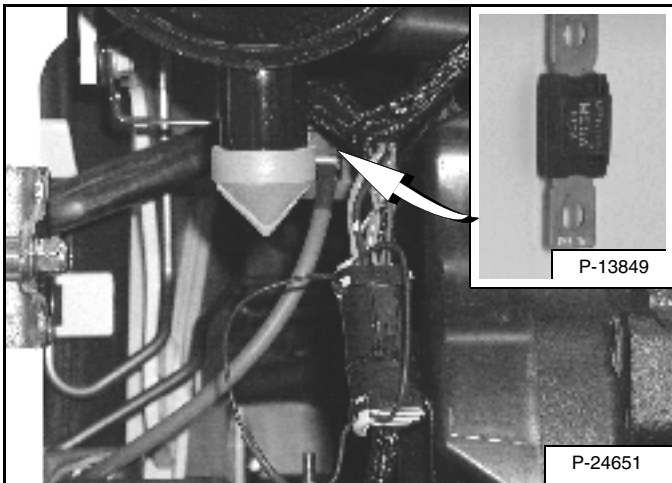

The loader has a 12 volt, negative ground alternator charging system. The electrical system is protected by fuses located in the cab on the steering control panel and a 100 amp. master fuse [Figure 156] in the engine compartment on the left side of the engine, under the air cleaner. The fuses will protect the electrical system when there is an electrical overload. The reason for the overload must be found before starting the engine again.

Fuse And Relay Location / Identification

Figure 157

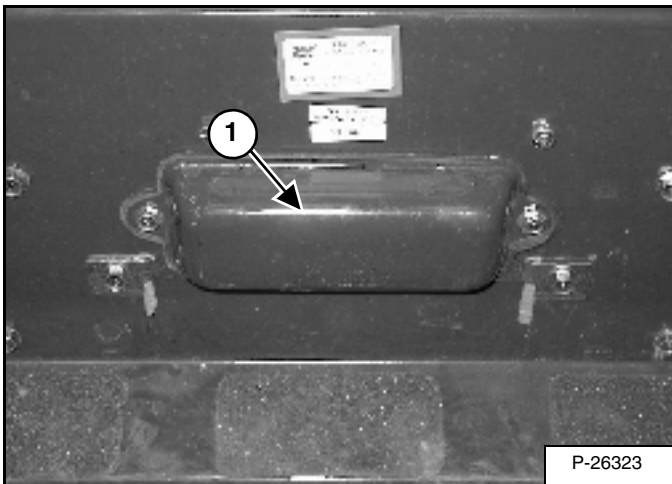

The electrical system is protected from overload by fuses and relays under the fuse panel cover (1) [Figure 157]. A decal is inside the cover to show location and amp ratings.

Remove the cover to check or replace the fuses.

Figure 158

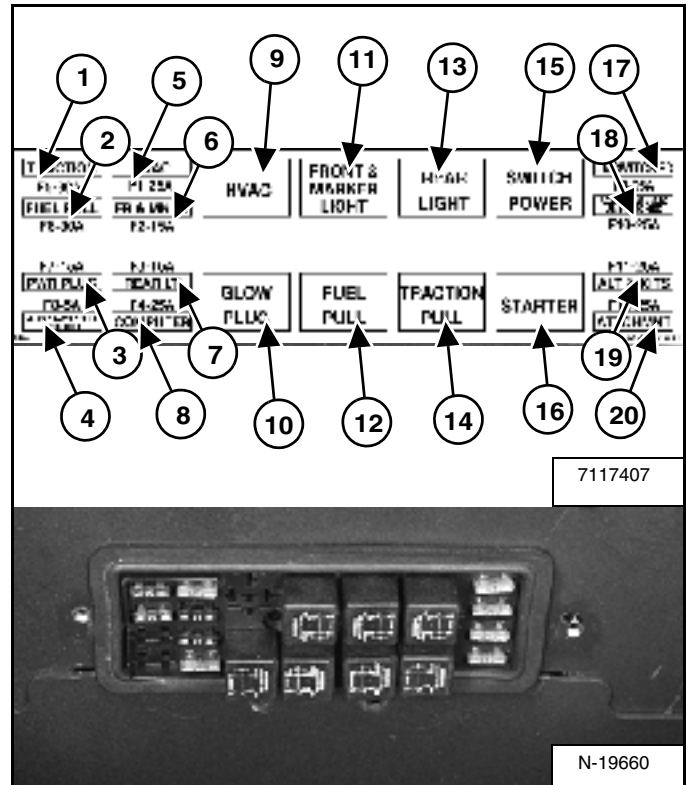

The location and sizes are shown below and in [Figure 154].

REF	DESCRIPTION	AMP	REF	DESCRIPTION	AMP
1	Traction	30	11	Front & Marker Lights	R
2	Fuel Shutoff	30	12	Fuel Shutoff	R
3	Power Plug	--	13	Rear Lights	R
4	ACS / AWS / SJC	--	14	Traction	R
5	Heater	25	15	Switch Power	R
6	Front & Marker Lights	15	16	Starter	R
7	Rear Lights	15	17	Unswitched Attach.	25
8	Bobcat Controller	25	18	Switched Attach.	25
9	Heater & Air Conditioning	--	19	Alternator & Accessories	25
10	Glow Plugs	R	20	Accessory Plug	25

R - Relay

ELECTRICAL SYSTEM (CONT'D)

Battery Maintenance

Figure 159

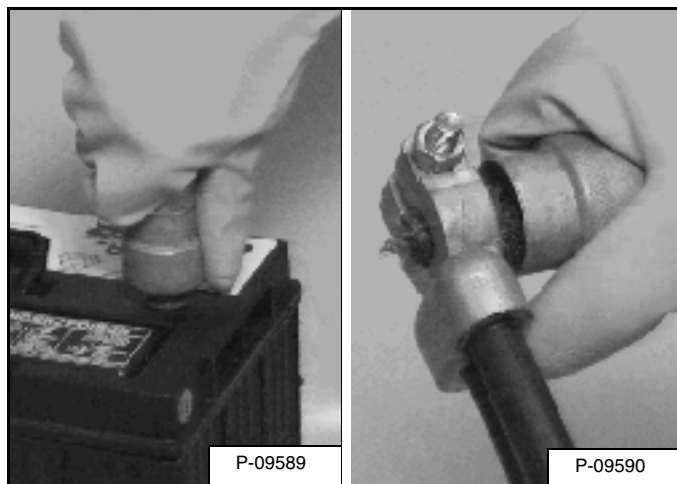

The battery cables must be clean and tight [Figure 159]. Check electrolyte level in the battery. Add distilled water as needed. Remove acid or corrosion from battery and cables with sodium bicarbonate (baking soda) and water solution.

Put Battery Saver (6664458) or grease on the battery terminals and cable ends to prevent corrosion.

WARNING

Batteries contain acid which burns eyes and skin on contact. Wear goggles, protective clothing and rubber gloves to keep acid off body.

In case of acid contact, wash immediately with water. In case of eye contact get prompt medical attention and wash eye with clean, cool water for at least 15 minutes.

If electrolyte is taken internally drink large quantities of water or milk! DO NOT induce vomiting. Get prompt medical attention.

W-2065-1296

ELECTRICAL SYSTEM (CONT'D)

Using A Booster Battery (Jump Starting)

If it is necessary to use a booster battery to start the engine, BE CAREFUL! There must be one person in the operator's seat and one person to connect and disconnect the battery cables.

The key switch must be OFF (*Key Switch Panel*) OR the STOP Button must be pressed (*Keyless Panel*). The booster battery must be 12 volt.

WARNING

Keep arcs, sparks flames and lighted tobacco away from batteries. When *jumping* from booster battery make final connection (negative) at machine frame.

Do not jump start or charge a frozen or damaged battery. Warm battery to 16°C (60°F) before connecting to a charger. Unplug charger before connecting or disconnecting cables to battery. Never lean over battery while boosting, testing or charging.

Battery gas can explode and cause serious injury.

W-2066-0705

Connect the end of the second cable (3) [Figure 160] to the negative terminal of the booster battery. Connect the other end of the same cable (4) [Figure 160] to the engine. Keep cables away from moving parts. Start the engine. (See STARTING THE ENGINE on Page 29.)

After the engine has started, remove the ground (-) cable (4) [Figure 160] first. Remove the cable from the positive terminal (2) [Figure 160].

IMPORTANT

Damage to the alternator can occur if:

- Engine is operated with battery cables disconnected.
- Battery cables are connected when using a fast charger or when welding on the loader. (Remove both cables from the battery.)
- Extra battery cables (booster cables) are connected wrong.

I-2023-1285

Figure 160

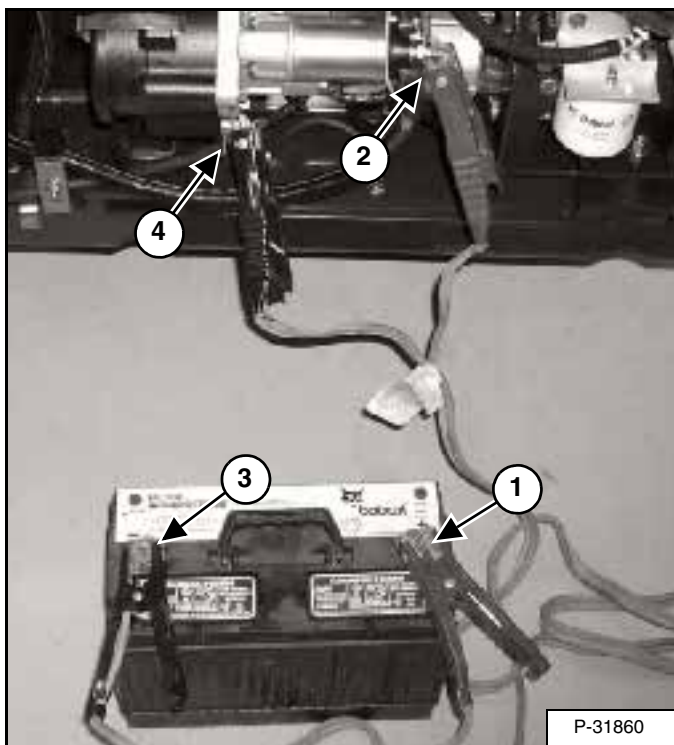

Connect the end of the first cable (1) [Figure 160] to the positive (+) terminal of the booster battery. Connect the other end of the same cable (2) [Figure 160] to the positive terminal on the loader starter.

ELECTRICAL SYSTEM (CONT'D)

Removing And Installing The Battery

! WARNING

Batteries contain acid which burns eyes and skin on contact. Wear goggles, protective clothing and rubber gloves to keep acid off body.

In case of acid contact, wash immediately with water. In case of eye contact get prompt medical attention and wash eye with clean, cool water for at least 15 minutes.

If electrolyte is taken internally drink large quantities of water or milk! DO NOT induce vomiting. Get prompt medical attention.

W-2065-1296

Open the rear door.

Figure 161

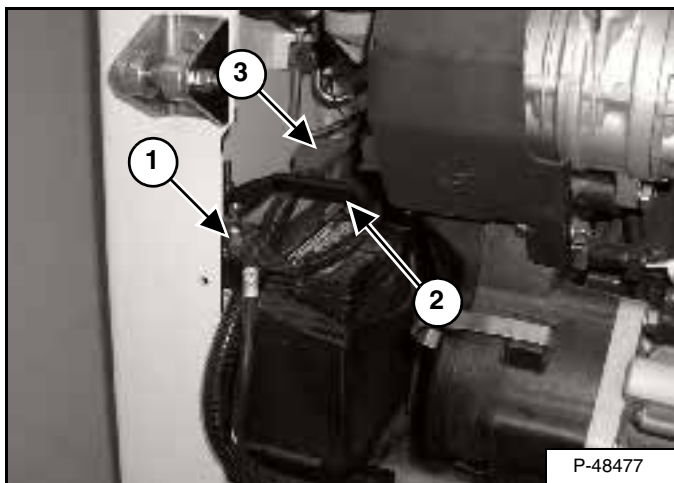

Remove the harness clamp (1) [Figure 161].

Disconnect the negative (-) battery cable (1) [Figure 161].

Remove the battery hold down clamp (2) [Figure 161].

Disconnect the positive (+) cable (3) [Figure 161] from the battery.

Remove the battery from the loader.

Figure 162

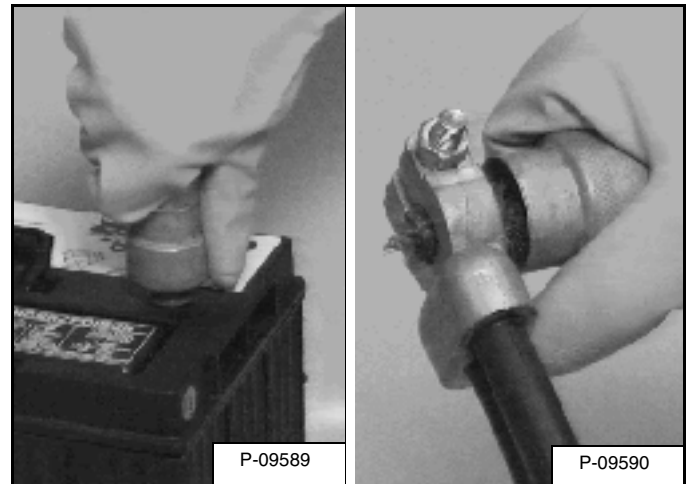

Always clean the battery terminals and cable ends when installing a new or used battery [Figure 162].

When installing the battery in the loader, do not touch any metal parts with the battery terminals.

Connect the negative (-) cable last to prevent sparks.

Connect and tighten the battery cables.

Install and tighten the battery hold down.

! WARNING

Keep arcs, sparks flames and lighted tobacco away from batteries. When *jumping* from booster battery make final connection (negative) at machine frame.

Do not jump start or charge a frozen or damaged battery. Warm battery to 16°C (60°F) before connecting to a charger. Unplug charger before connecting or disconnecting cables to battery. Never lean over battery while boosting, testing or charging.

Battery gas can explode and cause serious injury.

W-2066-0705

HYDRAULIC / HYDROSTATIC SYSTEM

Checking And Adding Fluid

Use only recommended fluid in the hydraulic system. (See Fluid Capacities on Page 124.)

Put the loader on a level surface, lower the lift arms and tilt the Bob-Tach fully back.

Stop the engine.

Figure 163

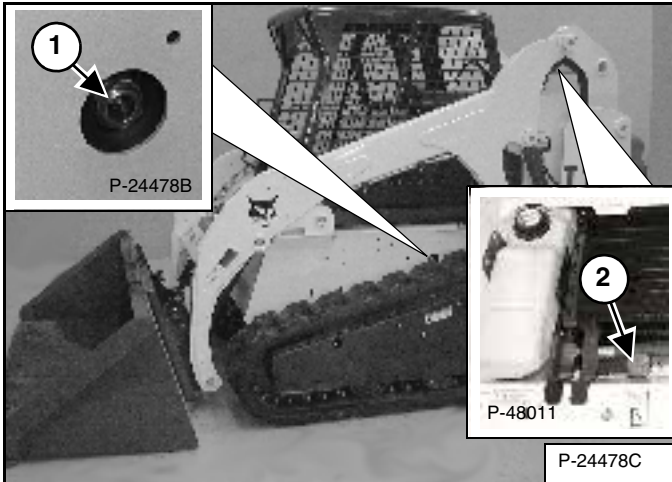

Check the fluid level in the sight gauge (1) [Figure 163].

Open the rear door and raise the rear grill. Remove the fill cap (2) [Figure 163].

Hydraulic / Hydrostatic Fluid Chart

Figure 164

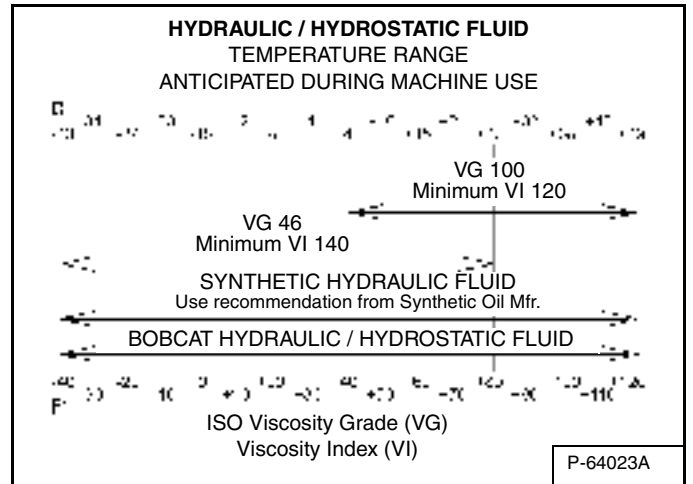

Add fluid as needed to bring the level to the center of the sight gauge (1) [Figure 163].

Install the fill cap (2) [Figure 163].

Lower the rear grill and close the rear door.

HYDRAULIC / HYDROSTATIC SYSTEM (CONT'D)

Removing And Replacing Hydraulic / Hydrostatic Filter

For the correct service interval (See SERVICE SCHEDULE on Page 67).

Open the rear door.

Figure 165

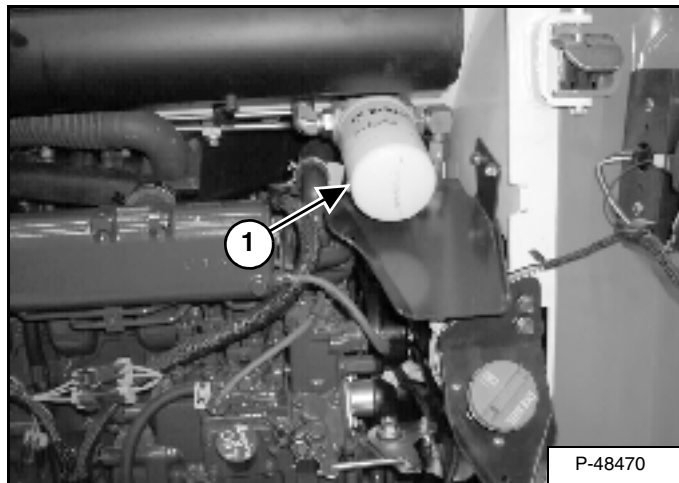

Remove the filter (1) [Figure 165].

Clean the surface of the filter housing where the filter seal contacts the housing.

Put clean oil on the seal of the new filter element. Install and hand tighten the filter element.

WARNING

Diesel fuel or hydraulic fluid under pressure can penetrate skin or eyes, causing serious injury or death. Fluid leaks under pressure may not be visible. Use a piece of cardboard or wood to find leaks. Do not use your bare hand. Wear safety goggles. If fluid enters skin or eyes, get immediate medical attention from a physician familiar with this injury.

W-2072-0496

Start the engine and operate the loader hydraulic controls.

Stop the engine and check for leaks at the filter.

Check the fluid level in the reservoir and add as needed.

WARNING

Always clean up spilled fuel or oil. Keep heat, flames, sparks or lighted tobacco away from fuel and oil. Failure to use care around combustibles can cause explosion or fire which can result in injury or death.

W-2103-1285

HYDRAULIC / HYDROSTATIC SYSTEM (CONT'D)

Removing And Replacing Hydraulic Fluid and Case Drain Filters

For the correct service interval (See SERVICE SCHEDULE on Page 67).

Replace the fluid if it becomes contaminated or after major repair.

Always replace the hydraulic / hydrostatic filter and the case drain filters whenever the hydraulic fluid is replaced. (See Removing And Replacing Oil And Filter on Page 84.)

Open the rear door and raise the rear grill. Remove the fill cap.

Figure 166

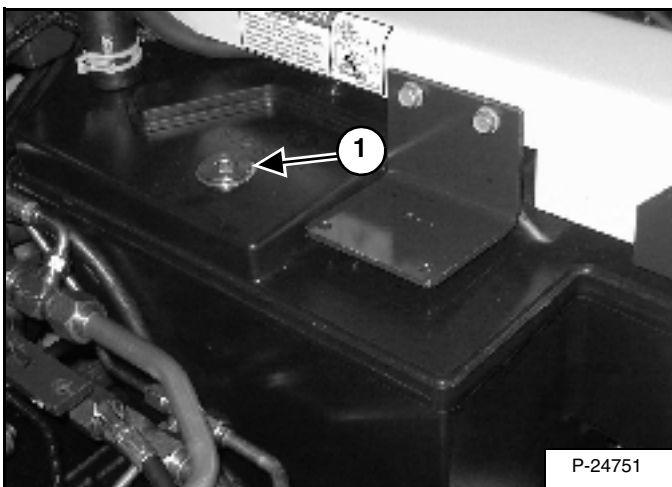

Raise the cab (See Raising on Page 74). Remove the plug from the top of the reservoir (1) [Figure 166] then pump the fluid out of the reservoir and into a container.

Recycle or dispose of used fluid in an environmentally safe manner.

WARNING

Always clean up spilled fuel or oil. Keep heat, flames, sparks or lighted tobacco away from fuel and oil. Failure to use care around combustibles can cause explosion or fire which can result in injury or death.

W-2103-1285

Figure 167

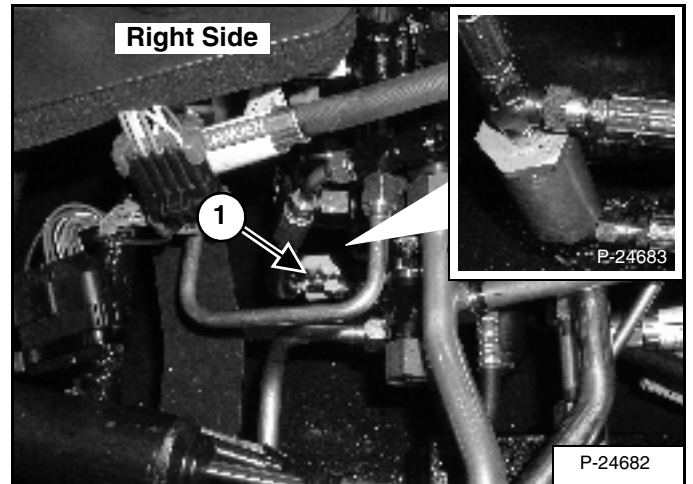
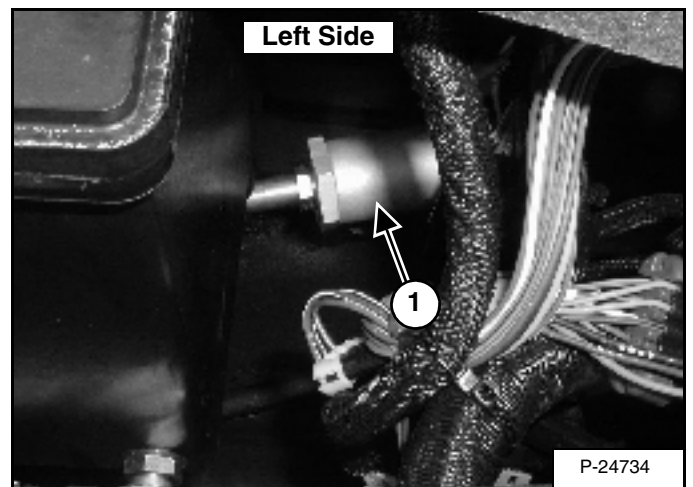

Figure 168



Remove the case drain filters (1) [Figure 167] and [Figure 168]. Disassemble the filter housings, thoroughly clean and install new filters. Reassemble and install the case drain filters. (See Lowering on Page 75.)

Recycle or dispose of used fluid in an environmentally safe manner.

Add the correct fluid to the reservoir until the fluid level is at the center of the sight gauge (Do not overfill).

HYDRAULIC / HYDROSTATIC SYSTEM (CONT'D)

Removing And Replacing Fan Hydraulic Filter

The fan hydraulic filter is located under the cab.

For the correct service interval (See SERVICE SCHEDULE on Page 67).

Figure 169

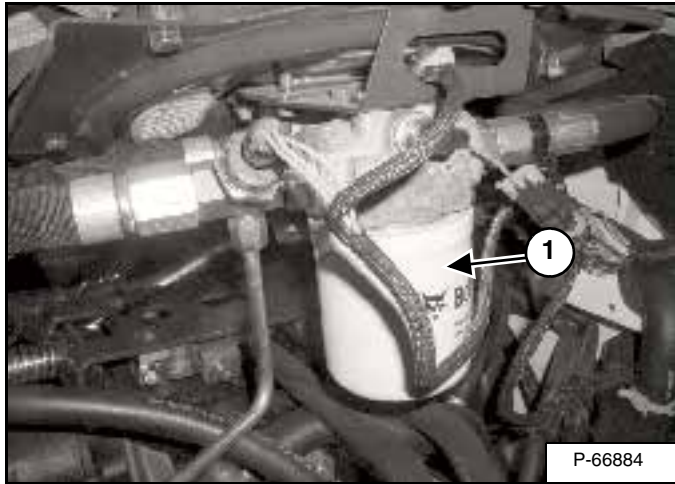

Raise the cab. (See Raising on Page 74.)

Remove the filter (1) [Figure 169] and lean the surface of the filter housing where the filter seal contacts the housing.

Put clean oil on the seal of the new filter element. Install and hand tighten the filter element.

Start the engine and operate the loader hydraulic controls.

Stop the engine and check for leaks at the filter.

Check the fluid level in the reservoir and add as needed.

WARNING

Hydraulic fluid escaping under pressure can have sufficient force to enter a person's body by penetrating the skin. This can cause serious injury and possible death if proper medical treatment by a physician familiar with this injury is not received immediately.

W-2145-0290

Lower the operator cab (See Lowering on Page 75).

Start the engine and operate the loader hydraulic controls. Stop the engine and check for leaks.

Check the fluid level in the reservoir and add as needed.

Breather Cap

Figure 170

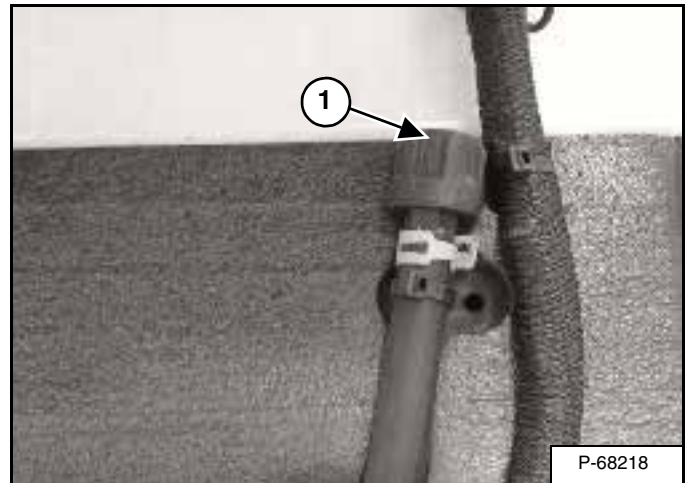

Raise the cab. (See Raising on Page 74.)

Remove and discard the hydraulic breather (1) [Figure 170]. Install new breather for correct interval.

Install new cap.

Lower the cab. (See Lowering on Page 75.)

WARNING

Always clean up spilled fuel or oil. Keep heat, flames, sparks or lighted tobacco away from fuel and oil. Failure to use care around combustibles can cause explosion or fire which can result in injury or death.

W-2103-1285

SPARK ARRESTOR MUFFLER

Cleaning Procedure

Use the correct service interval for cleaning the spark arrestor muffler.

Do not operate the loader with a defective exhaust system.

IMPORTANT

This loader is factory equipped with a spark arrestor muffler. It is necessary to do maintenance on this spark arrestor muffler to keep it in working condition. The spark arrestor muffler must be serviced by dumping the spark chamber every 100 hours of operation.

If this machine is operated on flammable forest, brush or grass covered land, it must be equipped with a spark arrestor attached to the exhaust system and maintained in working order.

Make reference to local laws and regulations for spark arrestor requirements.

I-2022-0595

! WARNING

Stop engine and allow the muffler to cool before cleaning the spark chamber. Wear safety goggles. Failure to obey can cause serious injury.

W-2011-1285

! WARNING

When the engine is running during service, the steering levers must be in neutral and the parking brake engaged. Failure to do so can cause injury or death.

W-2006-0284

Figure 171

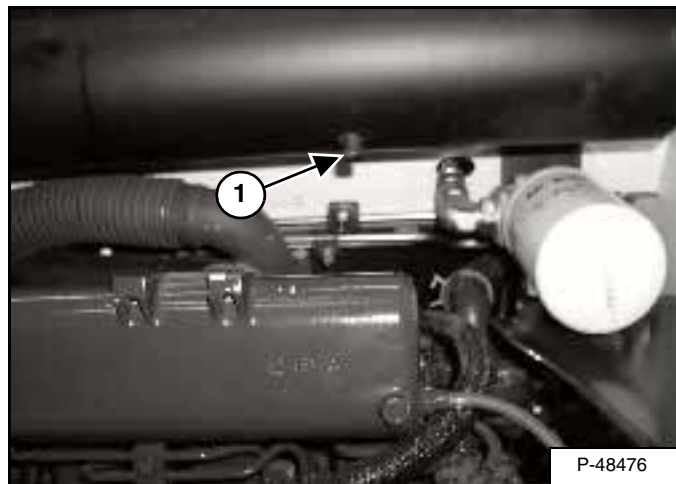

Stop the engine and open the rear door.

Remove the plug (1) [Figure 171] from the bottom of the muffler.

Start the engine and run for about 10 seconds while a second person, wearing safety glasses, holds a piece of wood over the outlet of the muffler.

This will force contaminants out through the cleanout hole.

Stop the engine.

Install and tighten the plug.

Close the rear door.

! WARNING

When an engine is running in an enclosed area, fresh air must be added to avoid concentration of exhaust fumes. If the engine is stationary, vent the exhaust outside. Exhaust fumes contain odorless, invisible gases which can kill without warning.

W-2050-1285

! WARNING

Never use machine in atmosphere with explosive dust or gases or where exhaust can contact flammable material. Failure to obey warnings can cause injury or death.

W-2068-1285

TRACK TENSION

Adjusting

Track tension is important for good performance and to prevent the tracks from derailing.

NOTE: The wear of track rollers vary with the working conditions and different types of soil conditions.

Park the loader on a level surface.

Figure 172

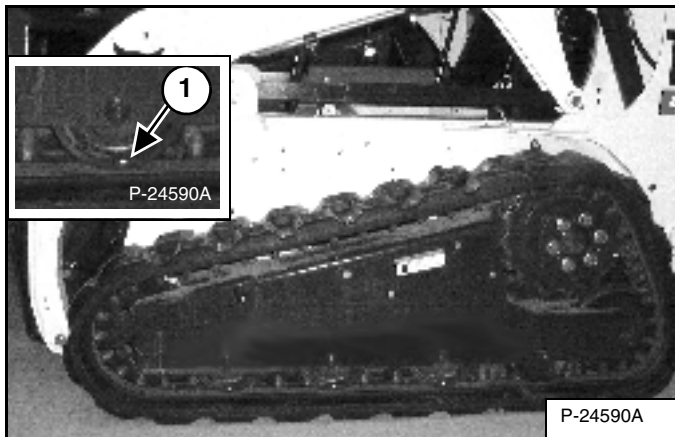

Raise one side of the loader and put jackstands at the front and rear of the loader frame so that the track is about 76 mm off the ground [Figure 172]. Lower the loader to the jackstands. Be sure the jackstands do not touch the tracks.

Figure 173

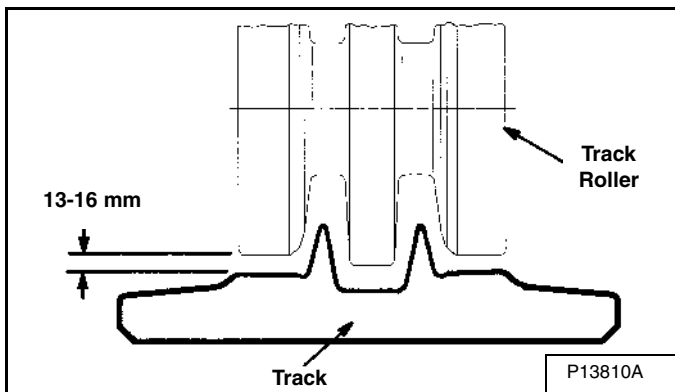

Measure the track sag at the middle track roller [Figure 173].

DO NOT put your fingers into the pinch points between the track and the roller. Use a 1/2 to 5/8 in. bolt, dowel or block to check the gap (1) [Figure 172] and [Figure 173].

! WARNING

AVOID INJURY

Keep fingers and hands out of pinch points when checking the track tension.

W-2142-0903

Figure 174

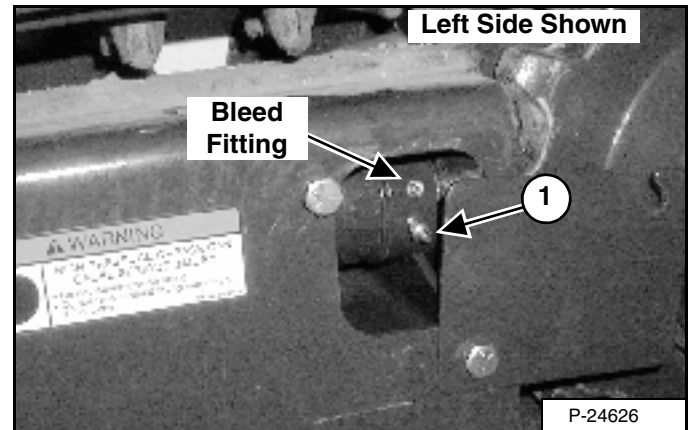

Loosen the cover bolts and turn the cover down [Figure 174].

NOTE: The grease cylinder used on the left side of the loader is identical to the cylinder on the right side. When the cylinder is located on the left side, the adjustment fitting is the lower fitting; on the right side it is the upper fitting.

! WARNING



HIGH PRESSURE GREASE CAN CAUSE SERIOUS INJURY

- Do not loosen grease fitting.
- Do not loosen bleed fitting more than 1-1/2 turns.

39894

SW 98 6804114

Increase Track Tension:

Add grease to the fitting (1) [Figure 174] (lower fitting on the left side, upper fitting on the right side.) until the track adjustment is correct [Figure 172] and [Figure 173].

NOTE: Do not remove grease fitting unless pressure is released using the bleed fitting. (See Adjusting on Page 96.)

NOTE: If replacement is necessary, always replace grease fitting (1) [Figure 174] with genuine Bobcat Parts. The fitting is a special fitting designed for high pressure.

TRACK TENSION (CONT'D)

Adjusting (Cont'd)

Decrease Track Tension:

Figure 175

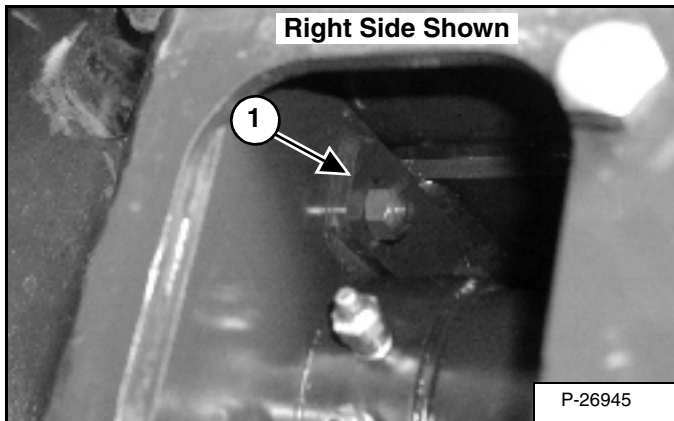

NOTE: There are stop blocks (1) [Figure 175] that keep the cylinders from turning. If the cylinders turn, the fittings will not be accessible. Check the stop block bolts to be sure they are tight.

Pressure must be released from the spring and adjustment cylinder to decrease track tension.

Figure 176

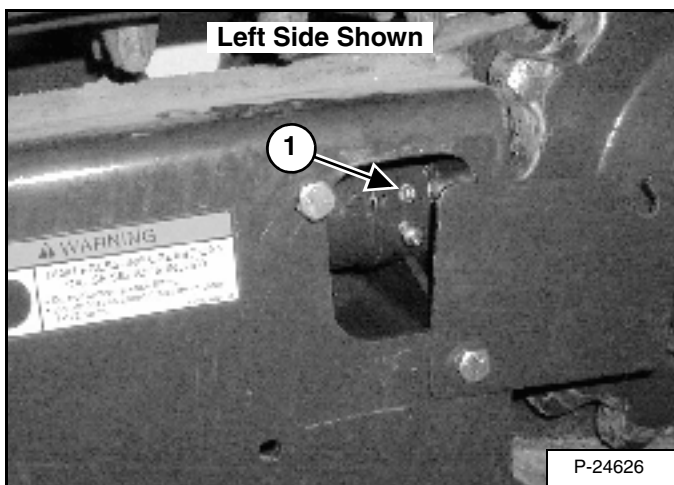
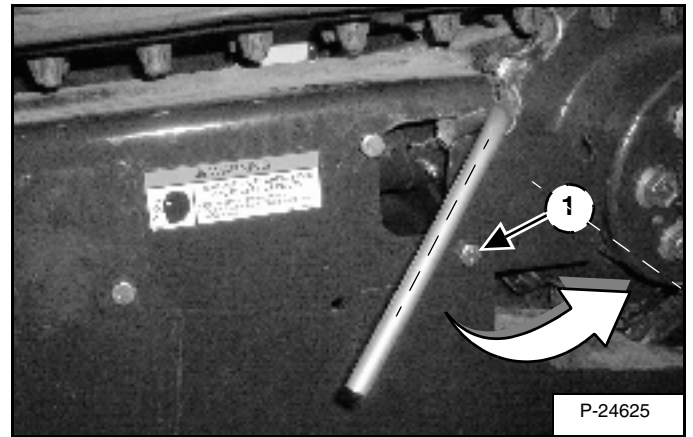

Figure 177



Install the bleed tool (MEL-1560) on the *bleed fitting* (1) [Figure 176] (upper fitting on left side, lower fitting on right side).

Adjust and tighten the collar to fit behind the edge of the access hole and the cover [Figure 177].

Tighten the cover bolt (1) [Figure 177] to secure the tool.

⚠ WARNING	
	HIGH PRESSURE GREASE CAN CAUSE SERIOUS INJURY <ul style="list-style-type: none">• Do not loosen grease fitting.• Do not loosen bleed fitting more than 1-1/2 turns.
39894	SW 98 6804114

Turn the tool 1/4 turn counterclockwise and let the grease flow into a container. Turn the tool one additional turn to continue to release pressure.

Repeat the procedure for the other track.

Dispose of the grease in an environmentally safe manner.

NOTE: Track replacement must be performed by a qualified Bobcat Technician. See your Bobcat dealer.

HYDROSTATIC MOTOR CARRIER LUBRICATION

Removing And Replacing Oil

The motor carriers have a reservoir in which the lubricant must be replaced each time the track is replaced. (Track removal is necessary.)

See your Bobcat dealer for track and motor carrier lubricant replacement.

TRACK SPROCKET MAINTENANCE

Tightening Procedure

Figure 178

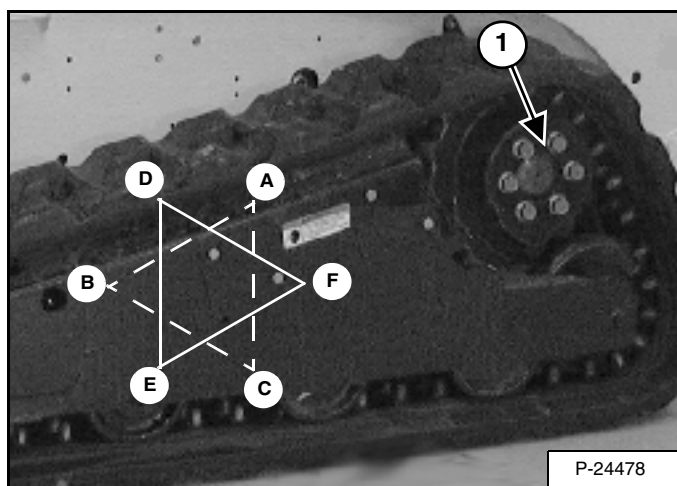

Check the torque of the six (6) track sprocket bolts (1) [Figure 178] for the correct service interval. Use a cross-pattern tightening sequence (A-B-C, D-E-F) [Figure 178] and then repeat to tighten the bolts to 407 Nm torque.

ALTERNATOR BELT

Belt Adjustment

Stop the engine.

Raise the operator cab. (See Raising on Page 74.)

Figure 179

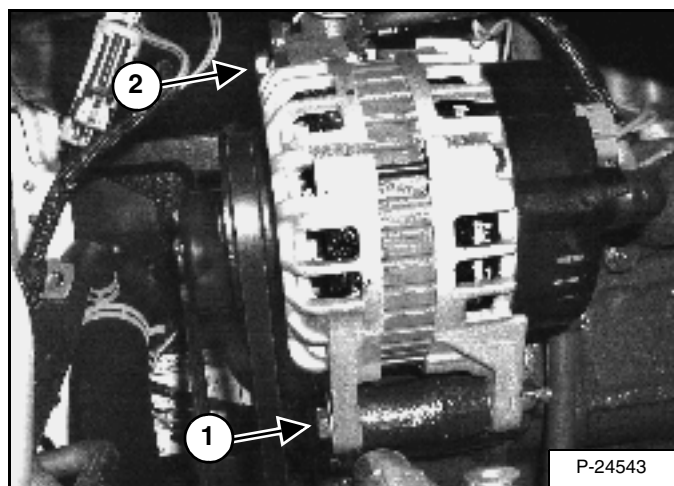

Loosen the alternator mounting bolt (1) and adjustment bolt (2) [Figure 179].

Move the alternator until the belt has 8,0 mm movement at the middle of the belt span with 66 N of force.

Tighten the adjustment bolt and mounting bolt.

Lower the operator cab. (See Lowering on Page 75.)

Belt Replacement

Stop the engine.

Raise the operator cab. (See Raising on Page 74.)

Loosen the alternator mounting bolt (1) and adjustment bolt (2) [Figure 179].

Move the alternator all the way toward the rear of the loader.

Remove the belt and install new belt.

Move the alternator toward the front of the loader until the belt has 8,0 mm movement at the middle of the belt span with 66 N of force.

Tighten the adjustment bolt and mounting bolt.

Lower the operator cab. (See Lowering on Page 75.)

Check the belt tension after several hours of operation and readjust as needed.

AIR CONDITIONING BELT

Belt Adjustment

Stop the engine and open the rear door.

Figure 180

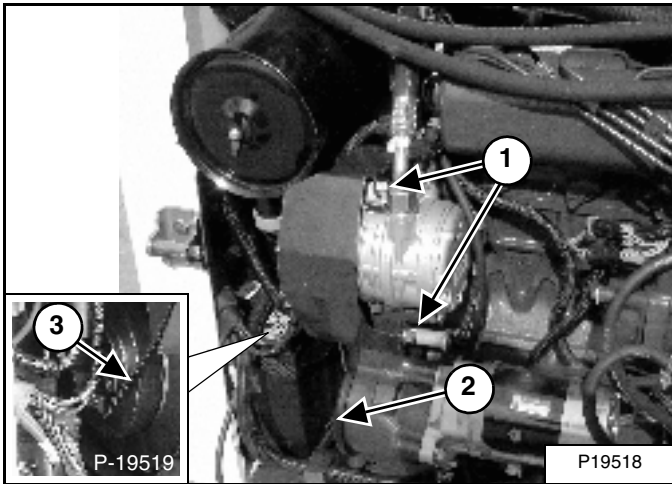

Loosen the mounting and adjustment bolts (1) [Figure 180].

Rotate the compressor toward the back of the machine (2) [Figure 180] to increase tension on the belt.

NOTE: The drive belt cover (2) [Figure 180] must be removed to check the air conditioner belt tension (3).

Tighten the mounting and adjustment bolts. Check regularly for belt wear.

Run the air conditioner for about 5 minutes every week to lubricate the internal components.

Troubleshooting - If the fan does not run, or the air conditioning does not turn on, Check the fuse. (See ELECTRICAL SYSTEM on Page 87.) If the air conditioning system circulates warm air, the refrigerant may need to be recharged.

Belt Replacement

Stop the engine and open the rear door.

Loosen the mounting and adjustment bolts (1) [Figure 180] and move the compressor as far as it will go toward the front of the loader.

Remove old belt and install a new belt.

Perform the belt adjustment procedure above.

Run the machine for several hours and readjust as necessary.

DRIVE BELT

Belt Adjustment

Stop the engine.

Open the rear door and disconnect the negative (-) cable from the battery.

Remove three belt shield fasteners and remove the belt shield.

Figure 181

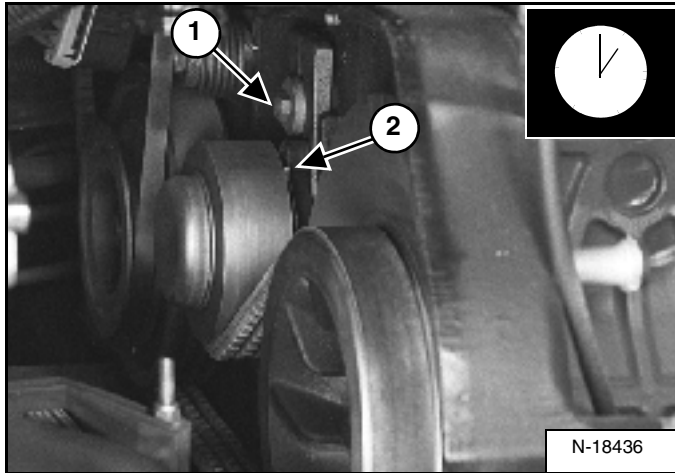

Loosen the bolt (1) [Figure 181] on the spring loaded drive idler.

NOTE: The pointer will be at the 1 o'clock position (2) [Figure 181] when the belt tensioner is not under spring tension.

Figure 182

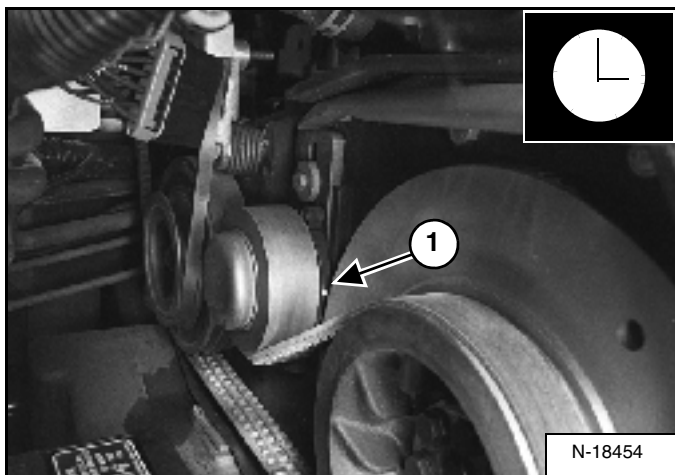

Push the idler pulley against the belt, using a pry bar [Figure 182]. The pointer will be at the 3 o'clock position (1) [Figure 182] when the idler pulley is against the stop (maximum movement).

Raise the idler assembly slightly so that the pulley is operating on spring tension and not against the stop.

NOTE: Do not set the idler against the travel stop in the 3 o'clock position.

Tighten the mounting bolt (1) [Figure 182] to 34-38 Nm torque.

Run the engine for a few minutes. Stop the engine and recheck the pointer position.

Readjust if necessary.

After the idler has been in service, readjust when the pointer reaches the 1 o'clock position.

Install the belt shield and fasteners.

Connect the negative (-) battery cable.

Close the rear door.

Belt Replacement

Follow the steps above to loosen the drive belt tensioner.

Remove the bolt (1) [Figure 182] from the tensioner and remove the tensioner assembly.

Remove the fan drive belt.

Remove the drive belt from the pump pulley and flywheel and remove the belt from the loader.

Install the new drive belt. Install the belt tensioner assembly.

Install the fan drive belt.

Adjust the drive belt, reinstall previously removed components and continue procedure from *Adjusting The Drive Belt* above.

Run the machine for 5 hours and then check belt adjustment again.

Readjust as necessary.

TRACK ROLLER AND IDLER LUBRICATION

Procedure

The track roller and idler lubrication areas are sealed and do not require periodic lubrication.

LUBRICATING THE LOADER

Lubrication Locations

Lubricate the loader as specified for the best performance of the loader. (See SERVICE SCHEDULE on Page 67.)

Record the operating hours each time you lubricate the Bobcat Loader.

Always use a good quality lithium based multi-purpose grease when you lubricate the loader. Apply lubricant until extra grease shows.

Lubricate the following:

Figure 183

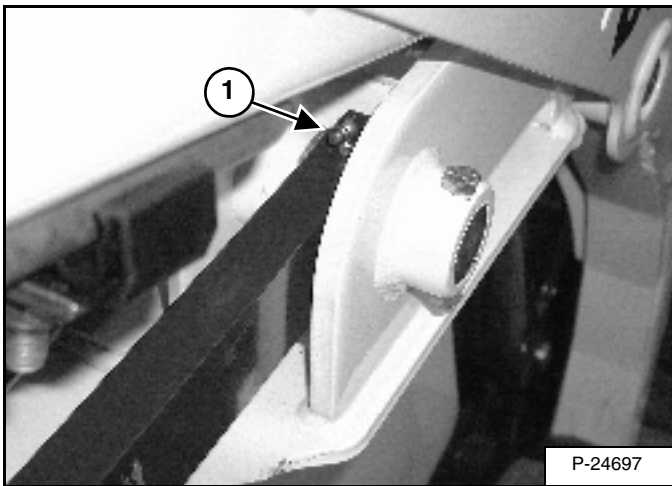

1. Stabilizer Rod - Front (Both Sides) [Figure 183].

Figure 184

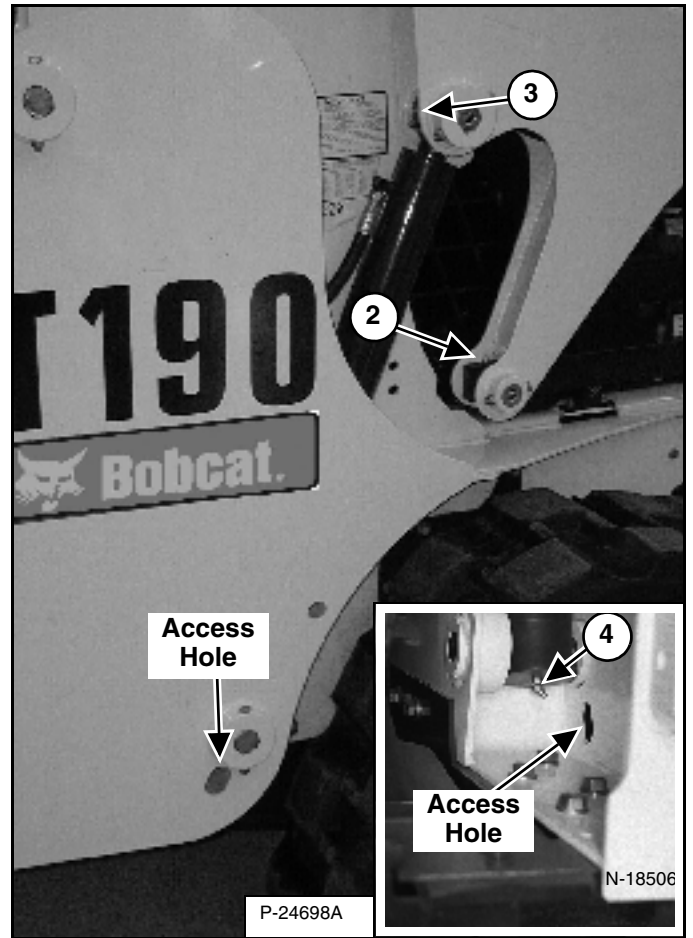

2. Stabilizer Rod - Rear (Both Sides) [Figure 184].
3. Lift Cylinder Rod End (Both Sides) [Figure 184].
4. Lift Cylinder Base End (Both Sides) [Figure 184].

Figure 185

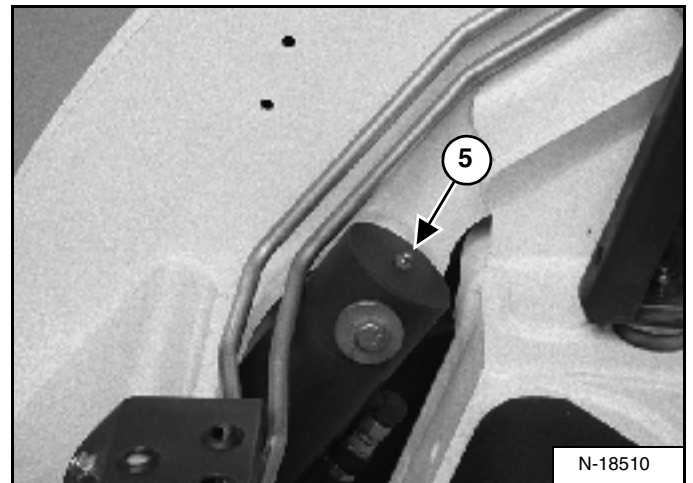

5. Tilt Cylinder Base End (Both Sides) [Figure 185].

LUBRICATING THE LOADER (CONT'D)

Lubrication Locations (Cont'd)

Figure 186

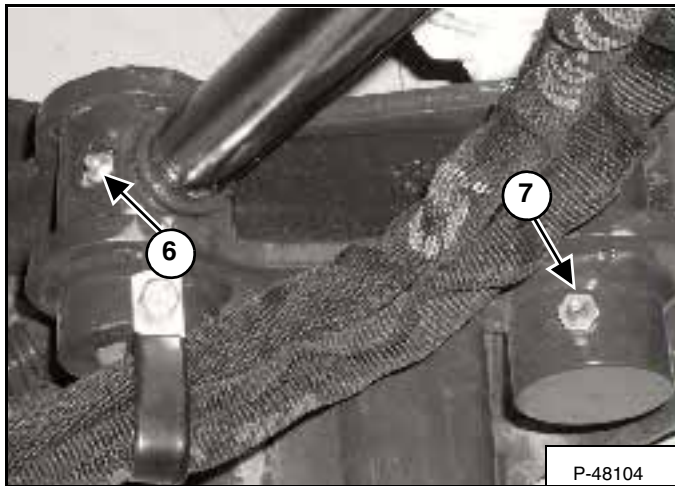

6. Tilt Cylinder Rod End [Figure 186].

7. Bob-Tach Pivot Pin (Both Sides) [Figure 186].

Figure 187

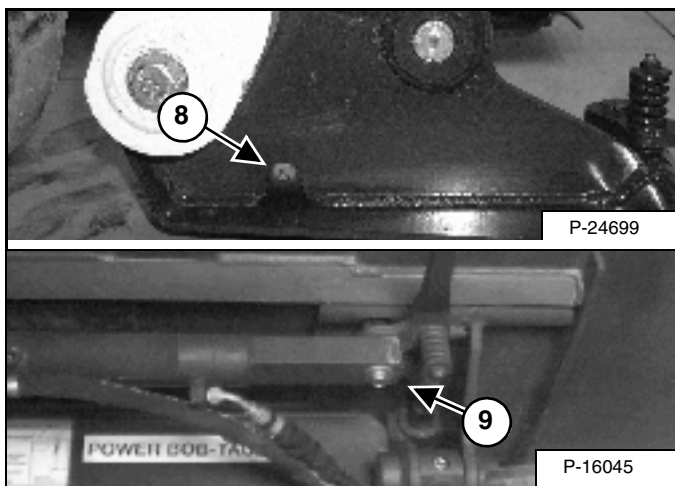

8. Bob-Tach Wedge (Both Sides) [Figure 187].

9. Power Bob-Tach Cylinder (Both Sides) [Figure 187].
(If Equipped)

Figure 188

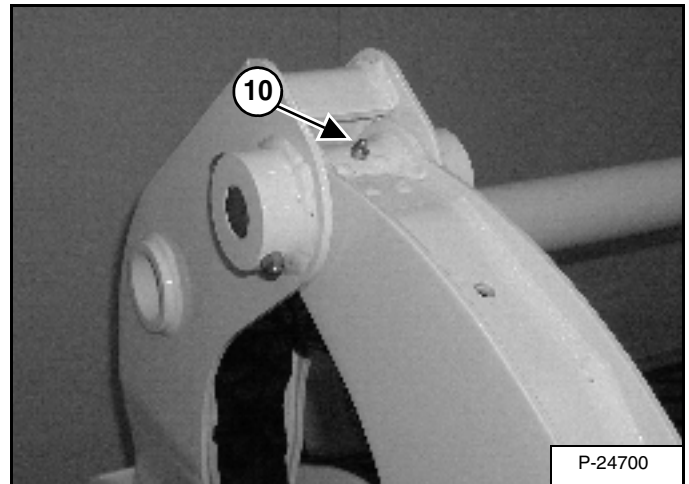

10. Lift Arm Pivot Pin (Both Sides) [Figure 188].

Figure 189

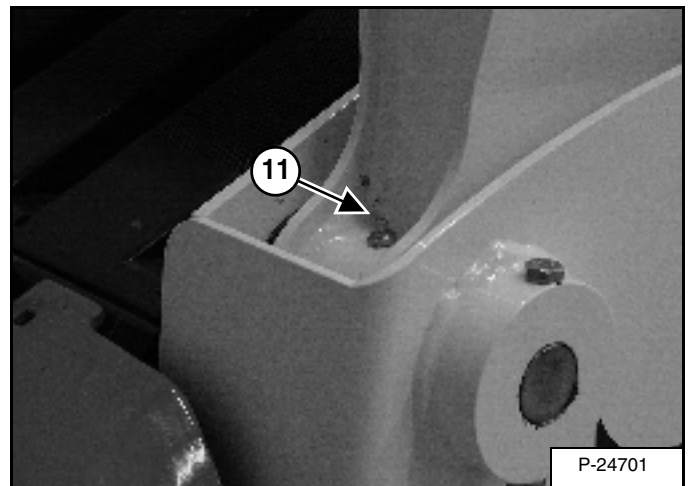

11. Lift Arm Link Pivot Pin (Both Sides) [Figure 189].

Figure 190

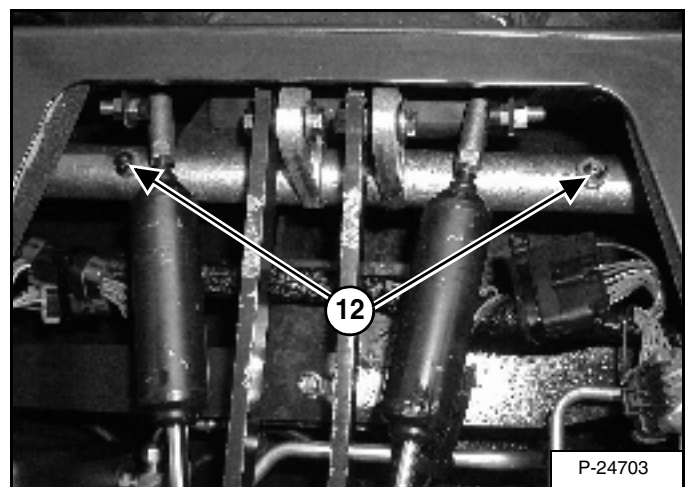

12. 250 Hours: Steering Lever Shaft (2) [Figure 190].

PIVOT PINS

Inspection And Maintenance

Figure 191

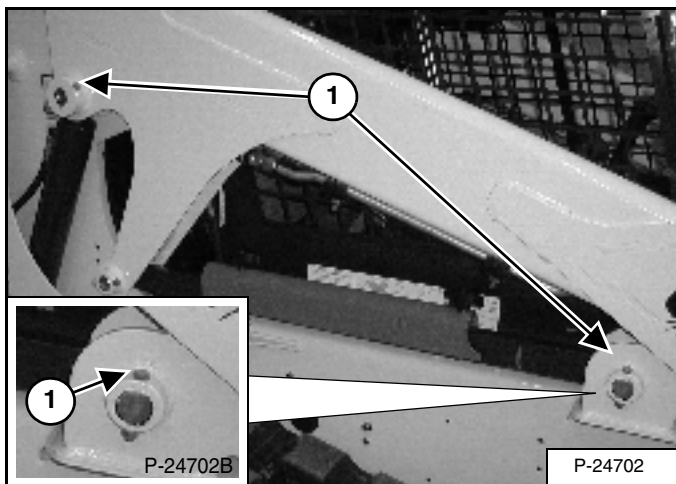

All lift arm and cylinder pivots have a large pin held in position with a retainer bolt and lock nut (1) [Figure 191].

Check that the lock nuts are tightened to 34-38 Nm torque.

BOB-TACH (HAND LEVER)

Inspection and Maintenance

Figure 192

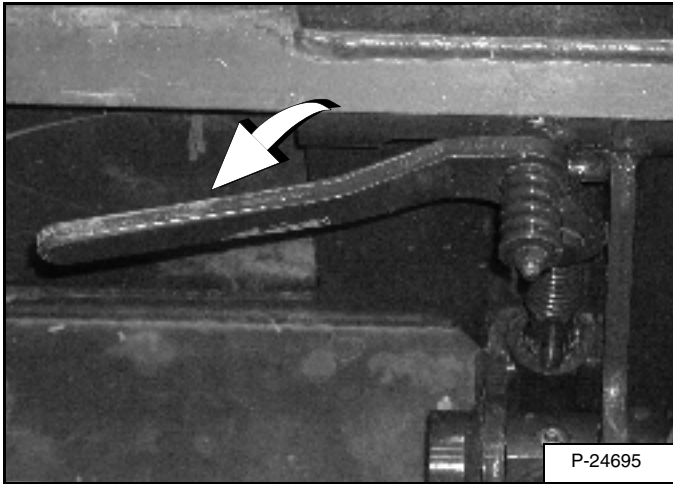

Move the Bob-Tach levers to engage the wedges [Figure 192].

The levers and wedges must move freely.

WARNING

Bob-Tach wedges must extend through the holes in attachment. Levers must be fully down and locked. Failure to secure wedges can allow attachment to come off and cause injury or death.

W-2102-0588

Figure 193

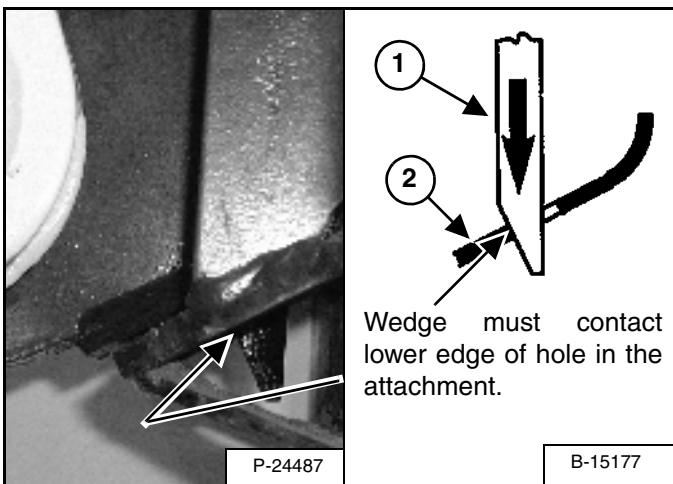

The wedges (1) [Figure 193] must extend through the holes in the attachment mounting frame (2) [Figure 193].

The spring loaded wedge (1) [Figure 193] must contact the lower edge of the hole in the attachment (2) [Figure 193].

If the wedge does not contact the lower edge of the hole [Figure 193], the attachment will be loose and can come off the Bob-Tach.

Figure 194

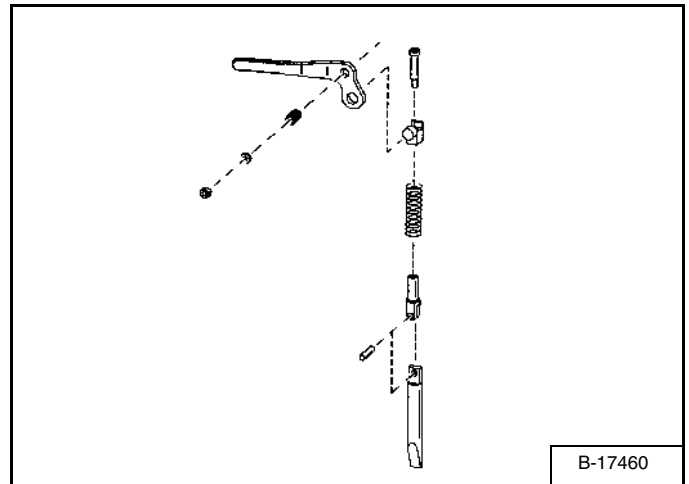

Inspect the mounting frame on the attachment and Bob-Tach, linkages and wedges for excessive wear or damage [Figure 194]. Replace any parts that are damaged, bent or missing. Keep all fasteners tight.

Look for cracked welds. Contact your Bobcat dealer for repair or replacement parts.

Lubricate the wedges. (See LUBRICATING THE LOADER on Page 101.)

BOB-TACH (POWER - OPTION)

Inspection and Maintenance

Figure 195

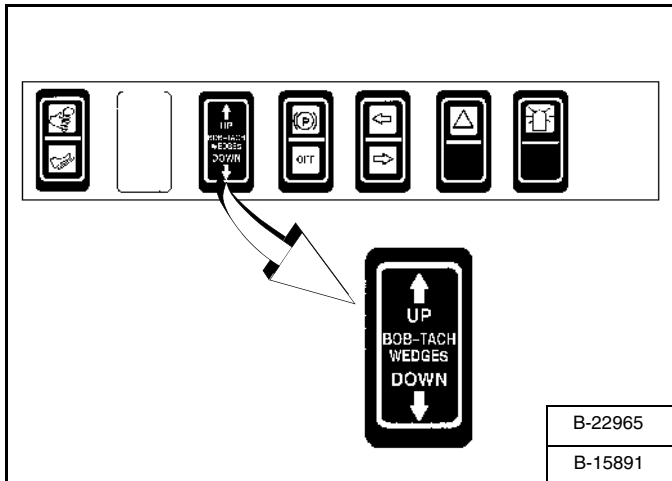

Push and hold the BOB-TACH "WEDGES UP" switch [Figure 196] until wedges are fully raised. Push and hold the BOB-TACH "WEDGES DOWN" switch [Figure 196] until the wedges are fully down.

The wedges must move freely.



Bob-Tach wedges must extend through the holes in attachment. Levers must be fully down and locked. Failure to secure wedges can allow attachment to come off and cause injury or death.

W-2102-0588

Figure 196

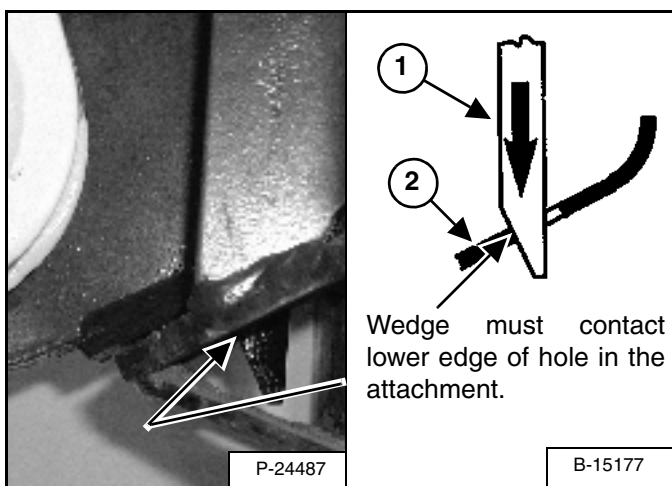

The wedges (1) must extend through the holes in the attachment mounting frame (2) [Figure 196].

The spring loaded wedge (1) [Figure 196] must contact the lower edge of the hole in the attachment [Figure 196].

If the wedge does not contact the lower edge of the hole [Figure 196], the attachment will be loose and can come off the Bob-Tach.

Figure 197

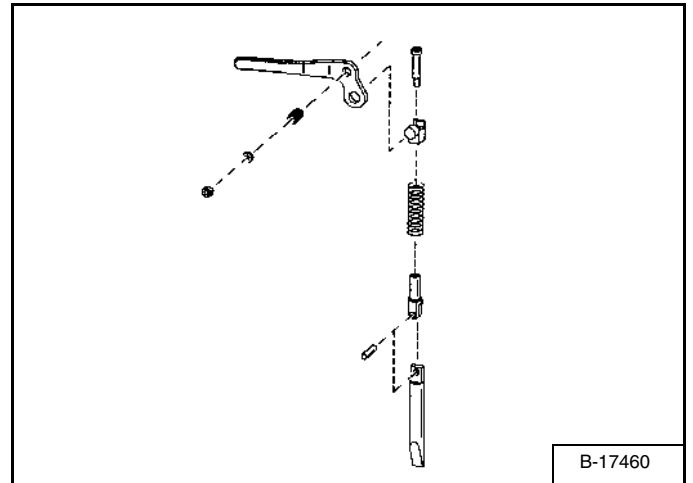

Inspect the mounting frame on the attachment and the Bob-Tach, linkages and wedges for excessive wear or damage [Figure 197]. Replace any parts that are damaged, bent, or missing. Keep all fasteners tight.

Look for cracked welds. Contact your Bobcat dealer for repair or replacement parts.

Lubricate the wedges. (See LUBRICATING THE LOADER on Page 101.)

LOADER STORAGE AND RETURN TO SERVICE

Storage

Sometimes it may be necessary to store your Bobcat Loader for an extend period of time. Below is a list of items to perform before storage.

- Thoroughly clean the loader including the engine compartment.
- Lubricate the loader.
- Replace worn or damaged parts.
- Park the loader in a dry protected shelter.
- Lower the lift arms all the way and put the bucket flat on the ground.
- Put blocks under the frame to remove weight from the tires.
- Put grease on any exposed cylinder rods.
- Put fuel stabilizer in the fuel tank and run the engine a few minutes to circulate the stabilizer to the pump and fuel injectors.
- Drain and flush the cooling system. Refill with premixed coolant.
- Replace all fluids and filters (engine, hyd. / hydro.).
- Replace air cleaner, heater and air conditioning filters.
- Put all controls in neutral position.
- Remove the battery. Be sure the electrolyte level is correct then charge the battery. Store it in a cool dry place above freezing temperatures and charge it periodically during storage.
- Cover the exhaust pipe opening.
- Tag the machine to indicate that it is in storage condition.

Return to Service

After the Bobcat Loader has been in storage, it is necessary to follow a list of items to return the loader to service.

- Check the engine and hydraulic oil levels; check coolant level.
- Install a fully charged battery.
- Remove grease from exposed cylinder rods.
- Check all belt tensions.
- Be sure all shields and guards are in place.
- Lubricate the loader.
- Check tire inflation and remove blocks from under frame.
- Remove cover from exhaust pipe opening.
- Start the engine and let run for a few minutes while observing the instrument panels and systems for correct operation.
- Operate machine, check for correct function.
- Stop the engine and check for leaks. Repair as needed.

SYSTEM SETUP & ANALYSIS

BOBCAT INTERLOCK CONTROL SYSTEM (BICS)	109
Troubleshooting.....	109
DIAGNOSTIC SERVICE CODES	110
Service Codes List.....	111
Viewing Service Codes (Key Switch)	110
Viewing Service Codes (Keyless)	110
DISPLAY CONTROLLER PANEL SETUP.....	115
Panel Setup.....	116
Panel Upgrade	115
Passwords.....	116
SHUTDOWN FEATURE	118
Procedure	118

**SYSTEM SETUP &
ANALYSIS**







Bobcat®

BOBCAT INTERLOCK CONTROL SYSTEM (BICS)

Troubleshooting

The following list shows the effects which can happen to the loader, and the probable causes when the BICS System lights are off or flashing and associated service code.

Indicator Light	Light ON	Light OFF	Effect on Operation of Loader When Light is OFF	SERVICE CODES Means System Error (See Your Bobcat Dealer for Service)		
				No. of Flashes	Service Code	Causes
	PRESS TO OPERATE LOADER Button is pressed.	PRESS TO OPERATE LOADER Button is not pressed.	----	----	----	----
	Seat Bar is down.	Seat Bar is up.	Lift and tilt functions will not operate.	2	11-05	Seat Bar sensor circuit shorted to battery voltage*.
				3	11-06	Seat Bar sensor circuit shorted to ground.
				Continuous Flashing	03-09 03-10	System voltage low System voltage high
	Control valve can be used.	Control valve cannot be used.	Lift, tilt and traction functions will not operate.	1	17-07	Valve output circuit is open.
				2	17-05	Valve output circuit shorted to battery voltage*.
				3	17-06	Valve output circuit shorted to ground.
				3	17-06	Controller not grounded or intermittent ground.
				Continuous Flashing	03-09 03-10	System voltage low System voltage high
	Loader can be moved forward & backward.	Loader cannot be moved forward and backward.	Loader cannot be moved forward and backward.	1	16-07	Traction lock hold solenoid circuit is open.
				2	16-05	Traction lock hold solenoid circuit shorted to battery voltage*.
				3	16-06	Traction lock hold solenoid circuit shorted to ground.
				5	15-02	Traction lock pull solenoid circuit is shorted to battery voltage* - ERROR ON (Should be OFF).
				6	15-03	Traction lock pull solenoid circuit ERROR OFF (Should be ON).
				Continuous Flashing	03-09 03-10	System voltage low System voltage high

* Normal BICS operating voltage is less than electrical system voltage.

DIAGNOSTIC SERVICE CODES

Viewing Service Codes (Key Switch)

Figure 198

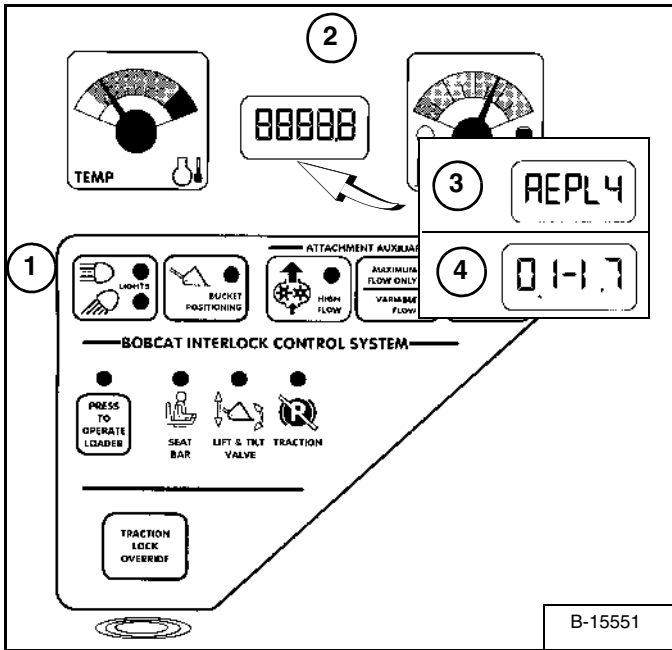

Press and hold the LIGHTS Button (1) [Figure 198] for two seconds to view SERVICE CODES in the HOURMETER / CODE DISPLAY (2). If more than one SERVICE CODE is present, the codes will scroll on the HOURMETER / CODE DISPLAY.

NOTE: Corroded or loose grounds can cause multiple service codes and / or abnormal symptoms. All instrument panel lights flashing, alarm sounding, headlights and taillights flashing, could indicate a bad ground. The same symptoms could apply if the voltage is low, such as loose or corroded battery cables. If you observe these symptoms, check grounds and positive leads first.

SERVICE CODES may be either a word (3) [Figure 198] or a number (4). (See the following pages for the service codes.)

The following word errors may be displayed.

REPLY One or both instrument panel(s) not communicating with the controller.

INPUT The controller not communicating with the left instrument panel.

CODE The controller is asking for a password. (Keyless instrument panel only.)

ERROR The wrong password was entered. (Keyless instrument panel only.)

Viewing Service Codes (Keyless)

The Service Codes will aid your dealer in diagnosing conditions which can damage your machine.

Figure 199

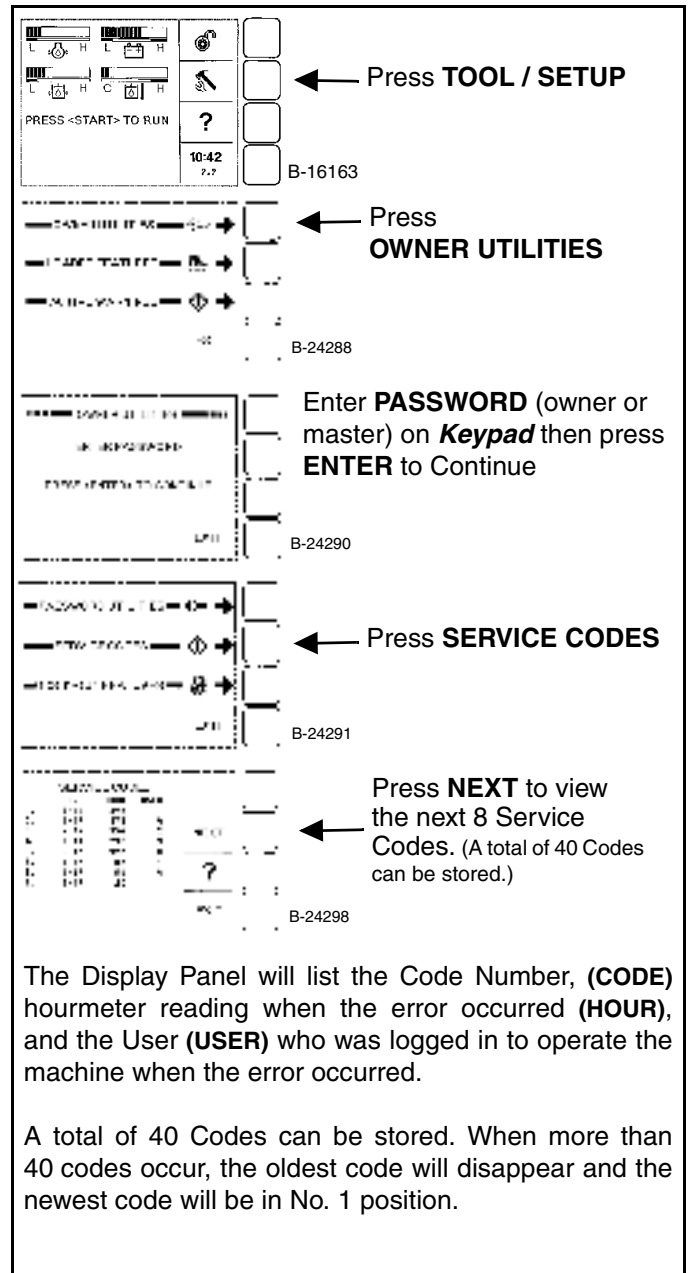

The Display Panel will list the Code Number, (CODE) hourmeter reading when the error occurred (HOUR), and the User (USER) who was logged in to operate the machine when the error occurred.

A total of 40 Codes can be stored. When more than 40 codes occur, the oldest code will disappear and the newest code will be in No. 1 position.

DIAGNOSTIC SERVICE CODES (CONT'D)

Service Codes List

CODE		CODE	
01-16	Air filter not connected	11-05	Seat bar sensor short to battery
01-17	Air filter plugged	11-06	Seat bar sensor short to ground
02-16	Hydraulic charge filter not connected	12-21	Front auxiliary PWM switch out of range high
02-17	Hydraulic charge filter plugged	12-22	Front auxiliary PWM switch out of range low
		12-23	Front auxiliary PWM switch not in neutral
03-09	Battery voltage low		
03-10	Battery voltage high	13-05	Fuel shut-off hold solenoid short to battery
03-11	Battery voltage extremely high	13-06	Fuel shut-off hold solenoid short to ground
03-14	Battery voltage extremely low	13-07	Fuel shut-off solenoid open circuit
03-22	Battery voltage out of range low		
		14-02	Fuel shut-off pull solenoid error ON
04-09	Engine oil pressure low	14-03	Fuel shut-off pull solenoid error OFF
04-14	Engine oil pressure extremely low		
04-15	Engine oil pressure shutdown level	15-02	Traction lock pull solenoid error ON
04-21	Engine oil pressure out of range high	15-03	Traction lock pull solenoid error OFF
04-22	Engine oil pressure out of range low		
		16-05	Traction lock hold solenoid short to battery
05-09	Hydraulic charge pressure low	16-06	Traction lock hold solenoid short to ground
05-14	Hydraulic charge pressure extremely low	16-07	Traction lock hold solenoid open circuit
05-15	Hydraulic charge pressure shutdown level		
05-21	Hydraulic charge pressure out of range high	17-05	Hydraulic lock valve solenoid short to battery
05-22	Hydraulic charge pressure out of range low	17-06	Hydraulic lock valve solenoid short to ground
		17-07	Hydraulic lock valve solenoid open circuit
06-10	Engine speed high		
06-11	Engine speed extremely high	18-05	Spool Lock Solenoid short to battery
06-13	Engine speed no signal	18-06	Spool Lock Solenoid short to ground
06-15	Engine speed shutdown level	18-07	Spool Lock Solenoid open circuit
06-18	Engine speed out of range		
		19-02	Bucket position solenoid error ON
07-10	Hydraulic oil temperature high	19-03	Bucket position solenoid error OFF
07-11	Hydraulic oil temperature extremely high		
07-15	Hydraulic oil temperature shutdown level	20-02	Two-speed solenoid error ON
07-21	Hydraulic oil temperature out of range high	20-03	Two-speed solenoid error OFF
07-22	Hydraulic oil temperature out of range low		
		21-02	Glow plug error ON
08-10	Engine coolant temperature high	21-03	Glow plug error OFF
08-11	Engine coolant temperature extremely high		
08-15	Engine coolant temperature shutdown level	22-02	Starter error ON
08-21	Engine coolant temperature out of range high	22-03	Starter error OFF
08-22	Engine coolant temperature out of range low		
		23-02	Rear base solenoid error ON
09-09	Fuel level low	23-03	Rear base solenoid error OFF
09-21	Fuel level out of range high		
09-22	Fuel level out of range low	24-02	Rear rod solenoid error ON
		24-03	Rear rod solenoid error OFF
10-16	Hydraulic implement filter not connected		
10-17	Hydraulic implement filter plugged		

DIAGNOSTIC SERVICE CODES (CONT'D)

Service Codes List (Cont'd)

CODE		CODE	
25-02	Rear auxiliary relief solenoid error ON	32-61	Handle lock short to ground
25-03	Rear auxiliary relief solenoid error OFF	32-62	Handle lock short to battery
		32-63	Pedal lock short to ground
26-02	Front base solenoid error ON	32-64	Pedal lock short to battery
26-03	Front base solenoid error OFF	32-65	Sensor supply voltage out of range
		32-66	Battery voltage out of range
27-02	Front rod solenoid error ON	32-67	Switch flipped while operating
27-03	Front rod solenoid error OFF	32-68	Lift handle information error
		32-69	Control pattern switch flipped while operating
28-02	Diverter solenoid error ON	32-70	Right drive handle short to ground
28-03	Diverter solenoid error OFF	32-71	Right drive handle short to battery
29-02	High flow solenoid error ON	33-23	Main Controller (Bobcat Controller) not programmed
29-03	High flow solenoid error OFF		
		34-04	Deluxe panel no communication to Bobcat controller
30-28	Controller Memory failure		
		35-02	Two-speed fan error ON
31-28	Interrupted power failure	35-03	Two-speed fan error OFF
32-04	ACS not communicating with Bobcat Controller	36-48	ACD multiple controllers present
32-23	ACS Not calibrated		
32-31	Tilt actuator fault	37-02	Two-speed secondary error ON
32-32	Tilt actuator wiring fault	37-03	Two-speed secondary error OFF
32-33	Tilt handle wiring fault		
32-34	Tilt actuator not in neutral		
32-35	Tilt handle / pedal not in neutral		
32-36	Lift actuator fault		
32-37	Lift actuator wiring fault		
32-38	Lift handle wiring fault		
32-39	Lift actuator not in neutral		
32-40	Lift handle / pedal not in neutral		
32-41	No communication		
32-49	Lift actuator short to ground		
32-50	Tilt actuator short to ground		
32-51	Lift actuator short to battery		
32-52	Tilt actuator short to battery		
32-53	Lift handle / pedal short to ground		
32-54	Tilt handle / pedal short to ground		
32-55	Lift handle / pedal short to battery		
32-56	Tilt handle / pedal short to battery		
32-57	Lift actuator reduced performance		
32-58	Tilt actuator reduced performance		
32-59	Lift actuator wrong direction		
32-60	Tilt actuator wrong direction		

DIAGNOSTIC SERVICE CODES (CONT'D)

Service Codes List (Cont'd)

CODE		CODE	
38-04	No communication from joystick controller	38-53	Left forward drive solenoid error OFF
38-05	Left joystick X axis not in neutral	38-54	Left reverse drive solenoid error OFF
38-06	Right joystick X axis not in neutral	38-55	Right forward drive solenoid error OFF
38-07	Left joystick Y axis not in neutral	38-56	Right reverse drive solenoid error OFF
38-08	Right joystick Y axis not in neutral	38-57	Front right extend steering solenoid error OFF
38-09	Control pattern switch - Short to Battery or Ground	38-58	Front right retract steering solenoid error OFF
38-11	Lift actuator not in neutral	38-59	Front left extend steering solenoid error OFF
38-12	Tilt actuator not in neutral	38-60	Front left retract steering solenoid error OFF
38-13	Lift actuator fault	38-61	Rear right extend steering solenoid error OFF
38-14	Tilt actuator fault	38-62	Rear right retract steering solenoid error OFF
38-15	Right wheel speed fault	38-63	Rear left extend steering solenoid error OFF
38-16	Left wheel speed fault	38-64	Rear left retract steering solenoid error OFF
38-17	Tilt actuator reduced performance	38-65	Steering pressure solenoid error OFF
38-18	Lift actuator reduced performance	38-66	Back-up alarm error OFF
38-19	Left joystick X axis out of range high	38-67	No communication from Bobcat controller
38-20	Right joystick X axis out of range low	38-68	Wheel angles (alignment) not calibrated
38-21	Left joystick Y axis out of range high	38-69	Lift & tilt actuators not calibrated
38-22	Right joystick Y axis out of range high	38-70	Interrupted power
38-23	Front right steering sensor out of range high	38-71	Battery out of range
38-24	Front left steering sensor out of range high	38-72	Drive pump not calibrated
38-25	Rear right steering sensor out of range high	38-73	Steering mode / drive mode switch flipped while operating
38-26	Rear left steering sensor out of range high	38-74	Uncommanded right wheel speed error ON
38-27	Lift actuator out of range high	38-75	Uncommanded left wheel speed error ON
38-28	Tilt actuator out of range high	38-76	Undercurrent steer pressure solenoid
38-29	Left joystick X axis out of range low	38-77	Undercurrent front right extend steer solenoid
38-30	Right joystick X axis out of range low	38-78	Undercurrent front right retract steer solenoid
38-31	Left joystick Y axis out of range low	38-79	Undercurrent front left extend steer solenoid
38-32	Right joystick Y axis out of range low	38-80	Undercurrent front left retract steer solenoid
38-33	Front right steering sensor out of range low	38-81	Undercurrent rear right extend steer solenoid
38-34	Front left steering sensor out of range low	38-82	Undercurrent rear right retract steer solenoid
38-35	Rear right steering sensor out of range low	38-83	Undercurrent rear left extend steer solenoid
38-36	Rear left steering sensor out of range low	38-84	Undercurrent rear left retract steer solenoid
38-37	5 volt sensor supply 1 out of range low	38-85	5 Volt sensor supply 1 out of range high
38-38	5 volt sensor supply 2 out of range low	38-86	5 Volt sensor supply 2 out of range high
38-39	Lift actuator short to ground / out of range low	38-87	Front right wheel blocked (steering mechanical failure)
38-40	Tilt actuator short to ground / out of range low	38-88	Front left wheel blocked (steering mechanical failure)
38-41	Tilt actuator wrong direction	38-89	Rear right wheel blocked (steering mechanical failure)
38-42	Lift actuator wrong direction	38-90	Rear left steering error
38-43	Left forward drive solenoid error ON	38-91	Right speed sensor missing pulses
38-44	Left reverse drive solenoid error ON	38-92	Left speed sensor missing pulses
38-45	Right forward drive solenoid error ON	38-93	Unresponsive right speed sensor
38-46	Right reverse drive solenoid error ON	38-94	Unresponsive left speed sensor
38-47	Front right steering solenoid error ON	38-98	Controller in drive calibration mode
38-48	Front left steering solenoid error ON	38-99	Controller in wheel position calibration mode
38-49	Rear right steering solenoid error ON		
38-50	Rear left steering solenoid error ON		
38-51	Steering pressure solenoid error ON		
38-52	Back-up alarm error ON		

DIAGNOSTIC SERVICE CODES (CONT'D)

Service Codes List (Cont'd)

CODE		CODE	
39-04	Left joystick no communication to Bobcat controller	85-02	ACD output 'F' error ON
		85-03	ACD output 'F' error OFF
40-04	Right joystick no communication to Bobcat controller		
		86-02	ACD output 'G' error ON
44-02	Horn error ON	86-03	ACD output 'G' error OFF
44-03	Horn error OFF		
		87-02	ACD output 'H' error ON
45-02	Right blinker error ON	87-03	ACD output 'H' error OFF
45-03	Right blinker error OFF		
		90-02	Service tool output 'C' error ON
46-02	Left blinker error ON	90-03	Service tool output 'C' error OFF
46-03	Left blinker error OFF		
		91-02	Service tool output 'D' error ON
47-21	8 volt sensor supply out of range high	91-03	Service tool output 'D' error OFF
47-22	8 volt sensor supply out of range low		
		92-02	Service tool output 'E' error ON
48-02	Front light relay error ON	92-03	Service tool output 'E' error OFF
48-03	Front light relay error OFF		
		93-02	Service tool output 'F' error ON
49-02	Rear light relay error ON	93-03	Service tool output 'F' error OFF
49-03	Rear light relay error OFF		
60-21	Rear auxiliary control out of range high		
60-22	Rear auxiliary control out of range low		
60-23	Rear auxiliary control not returning to neutral		
64-02	Switched power relay error ON		
64-03	Switched power relay error OFF		
74-72	Bobcat controller in boot code		
74-73	Left hand panel system RX error		
80-02	ACD output 'A' error ON		
80-03	ACD output 'A' error OFF		
81-02	ACD output 'B' error ON		
81-03	ACD output 'B' error OFF		
82-02	ACD output 'C' error ON		
82-03	ACD output 'C' error OFF		
83-02	ACD output 'D' error ON		
83-03	ACD output 'D' error OFF		
84-02	ACD output 'E' error ON		
84-03	ACD output 'E' error OFF		

DISPLAY CONTROLLER PANEL SETUP

Panel Upgrade

Icon Identification

Figure 200

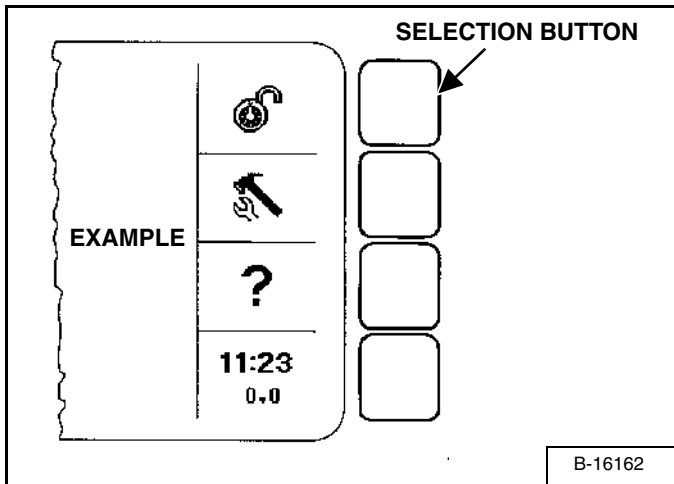

Make selection by pressing SELECTION BUTTON opposite the Icon [Figure 200].

ICON	DESCRIPTION
	LOCK / UNLOCK: Allows machine to be locked / unlocked. You must lock machine to activate security system. When system is unlocked, the user can press RUN / ENTER then press START to begin operation. A valid password will need to be entered at startup to run a locked machine.
	TOOL / SETUP: Access system options. Use to set clock, check system warnings, select language, set passwords, etc.
	HELP: Access help on current menu item.
EXIT	EXIT returns you to previous level menu.
11:23 0.0	CLOCK / JOB CLOCK: Press to clear or lock job clock; TOOL / SETUP to set time.
	UP ARROW: Goes backward one screen.
	DOWN ARROW: Goes forward one screen.
	OUTLINE ARROWS: No screen available (backward / forward).
	SELECTION ARROW: Use to select menu item.
NEXT	Goes to the NEXT screen in series. EXAMPLE: the next Active Warning screen.
INFO	Goes to more information about an attachment.
YES / NO	Answer yes / no to current setup question.
CLEAR	Removes previously installed password.
SET	Set accepts current installed password.

DISPLAY CONTROLLER PANEL SETUP (CONT'D)

Panel Setup

Display Options

Figure 201

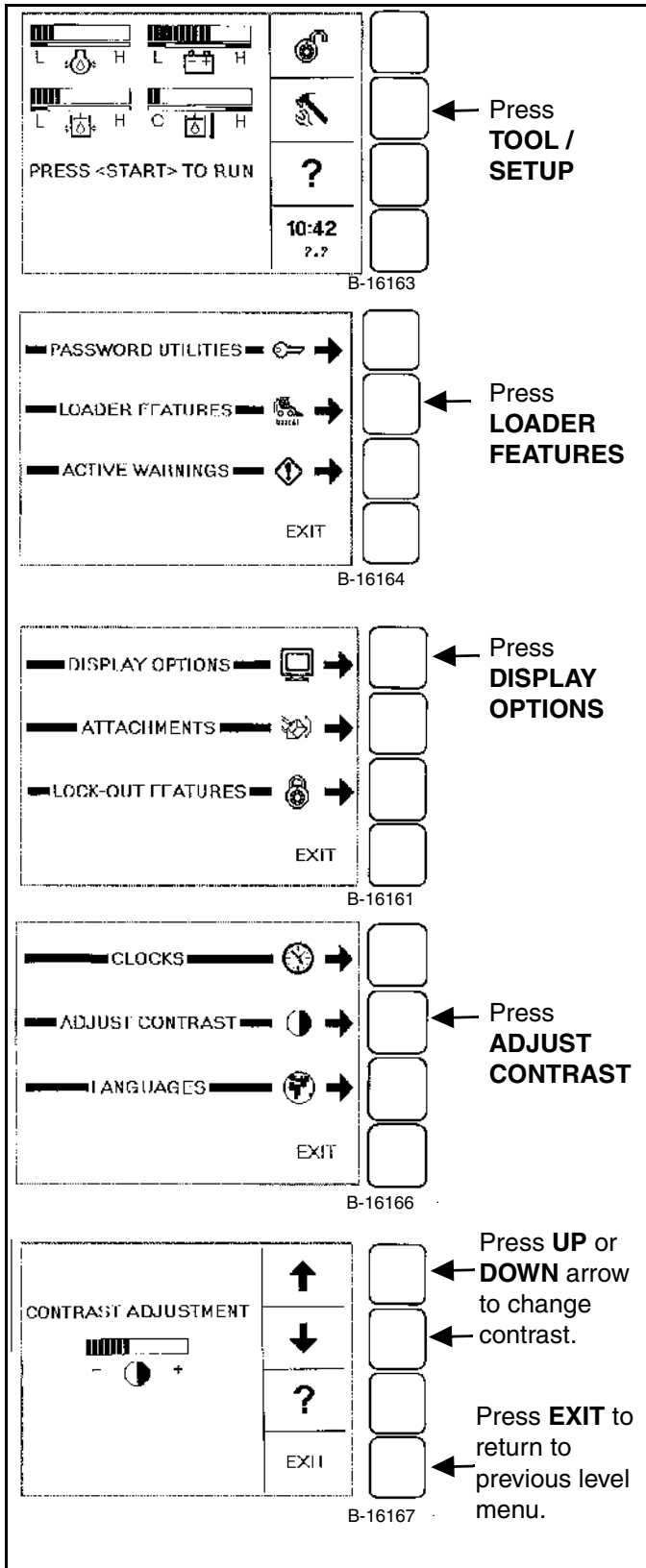

All new machines with Keyless Instrumentation arrive at Bobcat dealerships with the panel in locked mode. This means that a password must be used to start the engine [Figure 201].

Passwords

For security purposes, your dealer may change the password and also set it in the locked mode. Your dealer will provide you with the password.

Owner Password:

Allows for full use of the loader and to setup the Keyless Panel. Owner can select a password to allow starting & operating the loader and modify the setup of the Keyless Panel. Owner should change the password as soon as possible for security of the loader.

User Password:

Allows starting and operating the loader; cannot change password or any of the other setup features.

DISPLAY CONTROLLER PANEL SETUP (CONT'D)

Passwords (Cont'd)

Figure 202

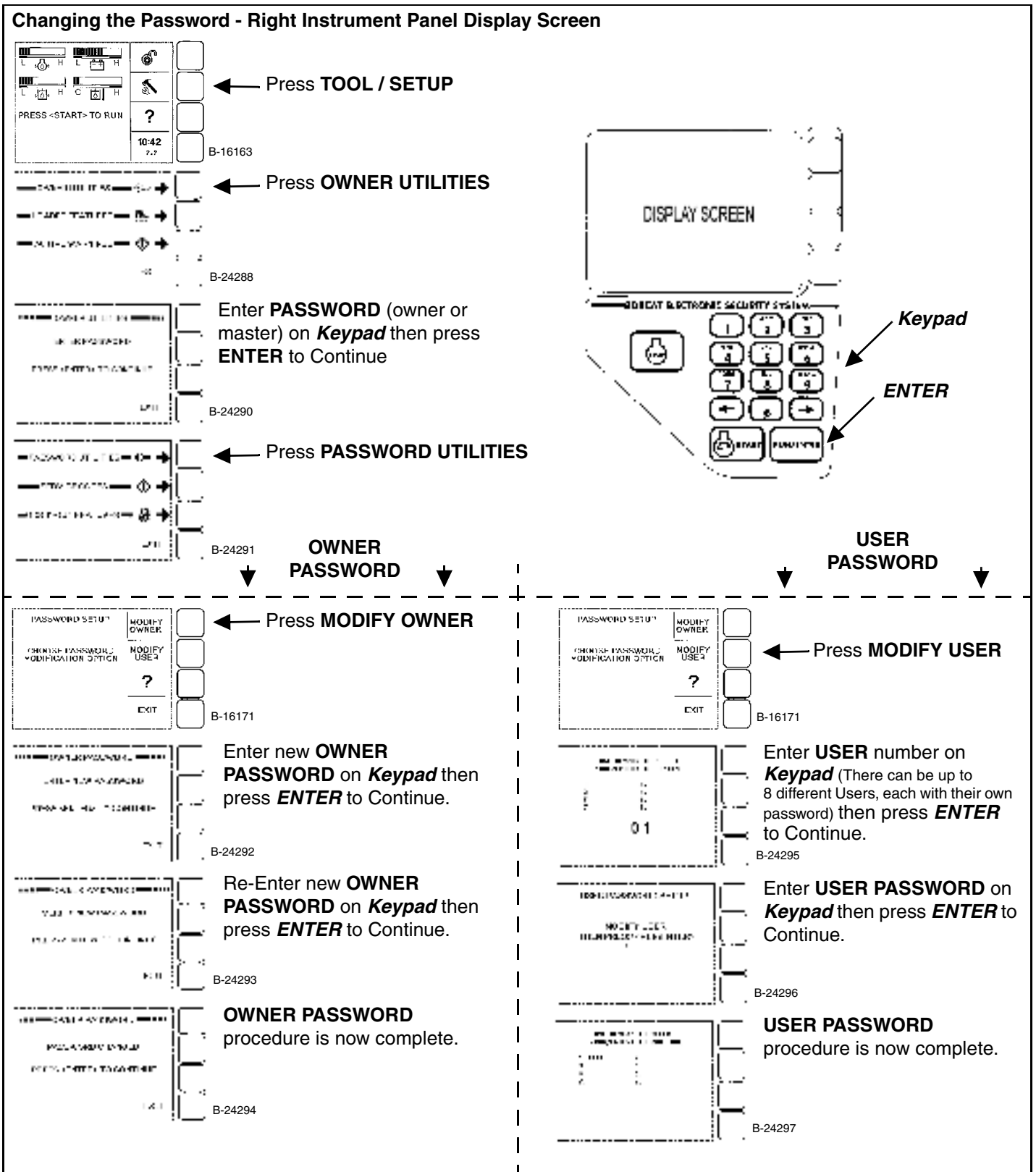

DISPLAY CONTROLLER PANEL SETUP (CONT'D)

More EXAMPLES:

Clocks

TOOL / SETUP LOADER FEATURES DISPLAY OPTIONS CLOCKS SET CLOCK

Use the keypad to set time.
Press **RUN / ENTER** to set clock.
Press **EXIT** to return to previous level menu.

RESET JOB CLOCK (Password required)

Press **CLEAR** to reset job clock to zero.
Press **LOCK / UNLOCK** to unlock.
Enter Password and press **RUN / ENTER**.

Languages

TOOL / SETUP LOADER FEATURES DISPLAY OPTIONS LANGUAGES

Select the language, press **RUN / ENTER**.
Press **EXIT** to return to previous level menu.

Vitals (Monitor the engine, hydraulic / hydrostatic, electrical functions when engine is running.)

TOOL / SETUP LOADER FEATURES VITALS

Press **SELECTION ARROW** to select METRIC or ENGLISH (M/E) readouts

You can monitor real-time readouts of:

- Engine Oil Pressure
- Engine Coolant Temperature
- Hydraulic Charge Pressure
- Hydraulic Oil Temperature
- System Voltage
- Engine Speed

The Display Panel is easy to use. Continue to set your own preferences for running / monitoring your Bobcat Loader.

SHUTDOWN FEATURE

Procedure

Figure 203

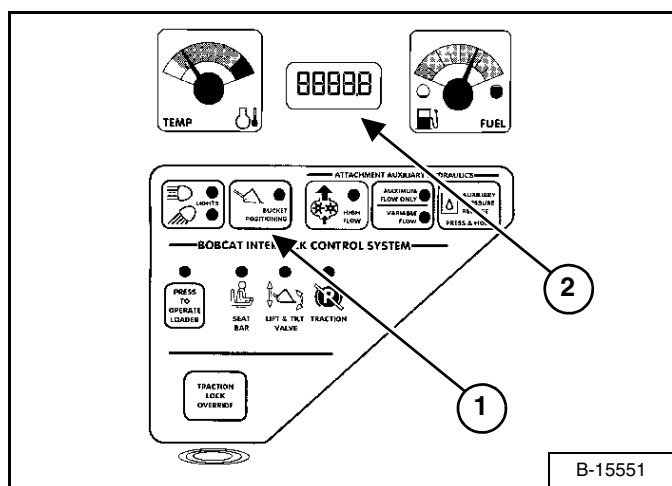

Press and hold the BUCKET POSITIONING Button (1) [Figure 203] for two seconds. If the SHUTDOWN feature is installed, **Shtdn** will appear in the HOURMETER / CODE DISPLAY (2) [Figure 203]. If it is not installed, **BASE** will appear.

The Operational Code (Software version) will also appear.

See your Bobcat dealer about installation of this feature.

SPECIFICATIONS

LOADER SPECIFICATIONS	121
Controls.....	124
Dimensions	121
Drive System.....	123
Electrical	123
Engine	122
Environmental	123
Fluid Capacities	124
Fluid Specifications	124
Function Time	122
Hydraulic Cylinders	123
Hydraulic System	123
Instrumentation	125
Machine Rating	122
Traction.....	123
Weights	122

SPECIFICATIONS



Bobcat®

LOADER SPECIFICATIONS

Dimensions

- Dimensions are given for loader equipped with standard tracks and dirt bucket and may vary with other bucket types. All dimensions are shown in millimeters.
- Where applicable, specifications conform to SAE or ISO standards and are subject to change without notice.

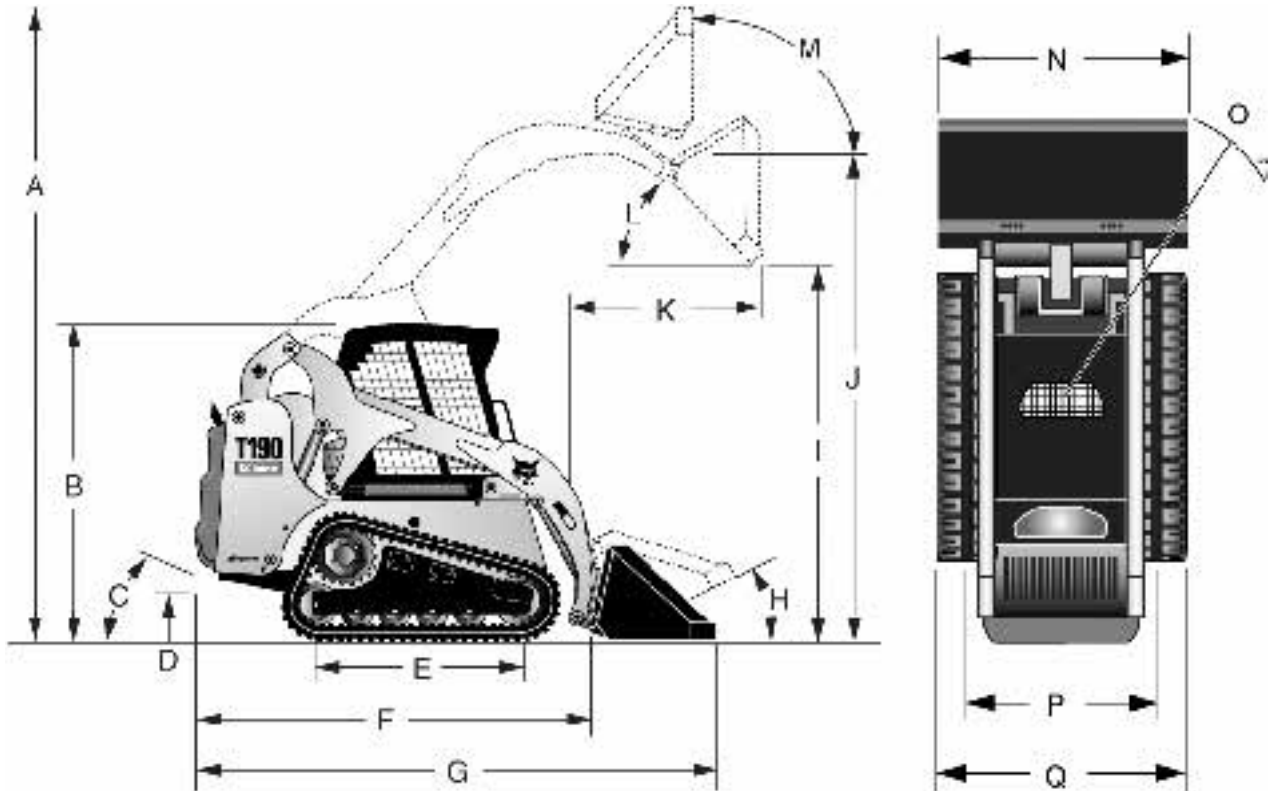

B-22942

(C) Angle of Departure.....	30°
Carry position.....	167 mm
(L) Dump angle at maximum height.....	42°
(I) Dump height with standard bucket	2310 mm
(K) Dump reach at maximum height	784 mm
(D) Ground clearance	205 mm
(J) Height to bucket hinge pin	3002 mm
(B) Height with operator cab	1938 mm
(F) Length without attachment	2588 mm
(G) Length with standard bucket.....	3309 mm
(A) Operating height.....	3862 mm
(H) Rollback at ground position.....	25°
(M) Rollback fully raised at maximum height	95°
(E) Ground contact length.....	1401 mm
(O) Turning radius with standard bucket	2001 mm
(Q) Width over tracks, 320 mm tracks.....	1676 mm
(P) Track, 320 mm tracks	1356 mm
(N) Bucket width, 68-inch.....	1727 mm
Bucket width, 74-inch.....	1880 mm

Changes of structure or weight distribution of the loader can cause changes in control and steering response and can cause failure of the loader parts.

LOADER SPECIFICATIONS (CONT'D)

Machine Rating

Lift breakout force	2090,7 daN
Tilt breakout force	1978,9 daN
Ground pressure	0,033784 MPa
Rated operating capacity (no more than 35% of Tipping Load)	1088 kg
Push force	20907 daN
Tipping load	3108 kg

Function Time

Raise lift arms	3,7 s
Lower lift arms	2,4 s
Bucket rollback	1,9 s
Bucket dump	2,4 s

Weights

Operating weight, T190	3453 kg
Operating weight, T190H	3473 kg
Shipping weight	3081 kg

Engine

Make / Model	Kubota / V2403M-DI-TE2B-BC-I
Fuel	Diesel
Cooling	Liquid
Maximum power at 1475 RPM (EEC 80/1269, ISO 9249)	45,5 kW
Maximum governed speed	2900 RPM
Low idle speed	1075-1225 RPM
High idle speed	2760-2900 RPM
Torque at 1475 RPM (SAE JI 995 Gross)	234,9 Nm
Number of cylinders	4
Displacement	2433 cm ³
Bore	87 mm
Stroke	102 mm
Lubrication	Gear pump pressure
Crankcase ventilation	Open Breathing
Air filter	Dry replaceable cartridge with safety element
Ignition	Diesel-compression
Starting aid	Glow plugs

LOADER SPECIFICATIONS (CONT'D)

Electrical

Alternator	Belt driven - 90 A - open
Battery	12 V - 600 cold cranking A at -18°C - 115 min reserve capacity
Starter	12 V - gear reduction type - 2,7 kW

Hydraulic System

Pump type	Engine driven, gear type
Pump capacity at 3028 RPM - T190	61,6 l/min
Pump capacity at 3028 RPM - T190H	96,4 l/min
System relief at Quick Couplers	22,4-23,1 MPa
Control valve	Three-spool, open-centre type with float detent on lift and electrically controlled auxiliary spool
Hydraulic filter	Full-flow replaceable, 3 µm synthetic media element
Fluid lines	SAE standard tubelines, hoses, and fittings

Hydraulic Cylinders

Lift cylinder (2)	Double-acting
Lift cylinder bore	57,2 mm
Lift cylinder rod	38,1 mm
Lift cylinder stroke	601 mm
Tilt cylinder (2)	Double-acting with cushioning feature on dump
Tilt cylinder bore	69,8 mm
Tilt cylinder rod	34,9 mm
Tilt cylinder stroke	335,0 mm

Drive System

Transmission	Infinitely variable tandem hydrostatic piston pumps, driving two fully reversing hydrostatic motors
Tracks	320 mm width. Tension-grease cylinder and triple-flange spring rollers
Main drive	Fully hydrostatic, rubber track drive

Traction

Tracks	320 mm wide, rubber
Travel speed	11,4 km/h

Environmental

Operator L_{pA} (98/37 & 474-1)	85 dB(A)
Noise level L_{WA} (EU Directive 2000/14/EC)	103 dB(A)
Whole body vibration (ISO 2631-1)	0,92
Hand-arm vibration (ISO 5349-1)	3,46

LOADER SPECIFICATIONS (CONT'D)

Fluid Capacities

Cooling system capacity with heater	11,3 l
Cooling system capacity without heater	10,2 l
Engine oil with filter capacity	8,7 l
Fuel tank capacity	106 l
Hydraulic reservoir capacity	72,4 l
Hydraulic / Hydrostatic system capacity	34,1 l

Fluid Specifications

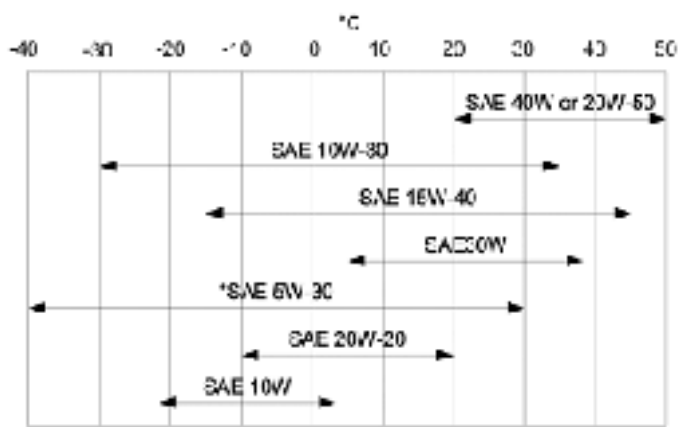
Engine coolant	Polypropylene glycol / water mix (53% - 47%) with freeze protection to -37°C
Engine oil	<p>Oil must meet API Service Classification of CD, CE, CF4, CG4, or better. Recommended SAE viscosity number for anticipated temperature range.</p>  <p>The chart shows the following temperature ranges for SAE grades:</p> <ul style="list-style-type: none"> SAE 10W-30: -30°C to 35°C SAE 15W-40: -20°C to 40°C SAE 20W-20: -10°C to 40°C SAE 30W: -10°C to 40°C SAE 40W or 20W-50: 0°C to 50°C SAE 10W: -30°C to 35°C
Hydraulic fluid	Bobcat Fluid (P/N 6563328).

* Can be used only when available with appropriate diesel rating. For synthetic oil use the recommendation from the oil manufacturer.

Controls

Engine	Hand lever throttle
Starting	Key-type starter switch and shutdown or optional keyless start. Glow plugs automatically activated by Standard or Deluxe instrument panel.
Front auxiliary (standard)	Electrical switch on right-hand steering lever
Rear auxiliary (optional)	Electrical switch on left-hand steering lever
Loader hydraulics tilt and lift	Separate foot pedals or optional Advanced Control System (ACS) or Selectable Joystick Control (SJC)
Service brake	Two independent hydrostatic systems controlled by two hand-operated steering levers
Secondary brake	One of the hydrostatic transmissions
Parking brake	Mechanical disc, hand operated rocker-switch on dash panel
Vehicle steering	Direction and speed controlled by two hand levers or optional joysticks
Auxiliary pressure release	Pressure is relieved through the coupler block. Push in and hold for 5 s.

LOADER SPECIFICATIONS (CONT'D)

Instrumentation

The following loader functions are monitored by a combination of gauges and warning lights in the operator's line of sight. The system alerts the operator of monitored loader malfunctions by way of audible alarm and visual warning lights.

Standard Instrument Panel

- Gauges
 - Engine coolant temperature
 - Fuel
 - Hour-meter
- Indicators
 - Attachment Control Device
 - Bobcat Interlock Control System
 - Glow plugs
- Warning lights
 - Advanced Control System (ACS)
 - Engine air filter
 - Engine coolant temperature
 - Engine oil pressure
 - Fuel level
 - General warning
 - Hydraulic filter
 - Hydraulic oil temperature
 - Hydrostatic charge temperature
 - Seat belt
 - System voltage

Deluxe Instrument Panel (Option)

Same gauges, warning lights and other features as Standard Instrument Panel, plus:

- Bar-type gauges
 - Engine oil pressure
 - System voltage
 - Hydrostatic charge pressure
 - Hydraulic oil temperature
- Additional features
 - Attachments information
 - Diagnostic capability
- Digital clock
- Digital tachometer
- Engine / hydraulic systems shutdown function
- Help screens
- High flow lockouts
- Job clock
- Keyless start with password capability
- Multi-language display



Bobcat®

WARRANTY

BOBCAT LOADERS

INGERSOLL RAND INTERNATIONAL warrants to its authorised dealers who in turn warrant to the end-user/owner that each new Bobcat loader will be free from proven defects in material and workmanship for twelve months from the date of delivery to the end-user/owner or 2000 hours of machine usage, whichever occurs first.

During the warranty period, the authorised selling Bobcat dealer shall repair or replace, at INGERSOLL RAND INTERNATIONAL's option, without charge for parts, labour and travel time of mechanics, any part of the Bobcat product which fails because of defects in material and workmanship. The end-user/owner shall provide the authorised Bobcat dealer with prompt written notice of the defect and allow reasonable time for replacement or repair. INGERSOLL RAND INTERNATIONAL may, at its option, request failed parts to be returned to the factory. Transportation of the Bobcat product to the authorized Bobcat dealer for warranty work is the responsibility of the end-user/owner.

The warranty does not apply to tyres or other trade accessories not manufactured by INGERSOLL RAND INTERNATIONAL. The owner shall rely solely on the warranty, if any, of the respective manufacturers thereof. The warranty does not cover replacement of scheduled service items such as oil, filters, tune-up parts, and other high-wear items. The warranty does not cover damages resulting from abuse, accidents, alterations, use of the Bobcat product with any bucket or attachment not approved by INGERSOLL RAND INTERNATIONAL, air flow obstructions, or failure to maintain or use the Bobcat product according to the instructions applicable to it.

INGERSOLL RAND INTERNATIONAL EXCLUDES OTHER CONDITIONS, WARRANTIES OR REPRESENTATIONS OF ALL KINDS, EXPRESSED OR IMPLIED, STATUTORY OR OTHERWISE (EXCEPT THAT OF TITLE) INCLUDING ALL IMPLIED WARRANTIES AND CONDITIONS RELATING TO MERCHANTABILITY, SATISFACTORY QUALITY AND FITNESS FOR A PARTICULAR PURPOSE.

CORRECTIONS BY INGERSOLL RAND INTERNATIONAL OF NONCONFORMITIES WHETHER PATENT OR LATENT, IN THE MANNER AND FOR THE TIME PERIOD PROVIDED ABOVE, SHALL CONSTITUTE FULFILMENT OF ALL LIABILITIES OF INGERSOLL RAND INTERNATIONAL FOR SUCH NONCONFORMITIES, WHETHER BASED ON CONTRACT, WARRANTY, TORT, NEGLIGENCE, INDEMNITY, STRICT LIABILITY OR OTHERWISE WITH RESPECT TO OR ARISING OUT OF SUCH PRODUCT.

THE REMEDIES OF THE END-USER/OWNER SET FORTH UNDER THE PROVISIONS OF THE WARRANTY OUTLINED ABOVE ARE EXCLUSIVE AND THE TOTAL LIABILITY OF INGERSOLL RAND INTERNATIONAL INCLUDING ANY HOLDING, SUBSIDIARY, ASSOCIATED OR AFFILIATED COMPANY OR DISTRIBUTOR WITH RESPECT TO THIS SALE OR THE PRODUCT AND SERVICE FURNISHED HEREUNDER IN CONNECTION WITH THE PERFORMANCE OR BREACH THEREOF, OR FROM DELIVERY, INSTALLATION, REPAIR OR TECHNICAL DIRECTION COVERED BY OR FURNISHED UNDER THIS SALE, WHETHER BASED ON CONTRACT, WARRANTY, TORT, NEGLIGENCE, INDEMNITY, STRICT LIABILITY OR OTHERWISE SHALL NOT EXCEED THE PURCHASE PRICE OF THE PRODUCT UPON WHICH SUCH LIABILITY IS BASED.

INGERSOLL RAND INTERNATIONAL INCLUDING ANY HOLDING, SUBSIDIARY, ASSOCIATED OR AFFILIATED COMPANY AND DISTRIBUTOR SHALL IN NO EVENT BE LIABLE TO THE END-USER/OWNER, ANY SUCCESSORS IN INTEREST OR ANY BENEFICIARY OR ASSIGNEE RELATING TO THIS SALE FOR ANY CONSEQUENTIAL, INCIDENTAL, INDIRECT, SPECIAL OR PUNITIVE DAMAGES ARISING OUT OF THIS SALE OR BY ANY BREACH THEREOF, OR ANY DEFECT IN, OR FAILURE OF, OR MALFUNCTION OF THE PRODUCT UNDER THIS SALE, WHETHER BASED UPON LOSS OF USE, LOST PROFITS OR REVENUE, INTEREST, LOST GOODWILL, WORK STOPPAGE, IMPAIRMENT OF OTHER GOODS, LOSS BY REASON OF SHUTDOWN OR NON-OPERATION, INCREASED EXPENSES OF OPERATION OR CLAIMS OF USER OR CUSTOMERS OF THE USER FOR SERVICE INTERRUPTION WHETHER OR NOT SUCH LOSS OR DAMAGE IS BASED ON CONTRACT, WARRANTY, TORT, NEGLIGENCE, INDEMNITY, STRICT LIABILITY OR OTHERWISE.



Bobcat®