

705068

705068

**WALTERSCHEID**

**Installation, Service and Safety Instructions for Implement Input Drivelines and Clutches**

Important!

Must be given to the user!

**ENGLISH**

**Notice de montage, d'emploi et de sécurité pour les transmissions et limiteurs**

A respecter strictement!

Cette notice doit être remise à l'utilisateur!

**FRANÇAIS**

**Instrucciones para el montaje, el servicio y la seguridad de transmisiones y embragues**

¡A observar imprescindiblemente!

¡A entregar al usuario!

**ESPAÑOL**

**Attention!**

Please read the following instructions before operating this equipment.

**Attention!**

Lisez les instructions suivantes avant la mise en route de la machine.

**¡Atención!**

Antes de que ponga el apero en marcha, lea con suma atención las siguientes instrucciones.



**WALTERSCHEID**

GKN Walterscheid Inc.  
16 West 030 83rd Street  
Burr Ridge, IL 60521 5802  
Telephone: (708) 887-7022  
Telefax: (708) 887-8386

This Manual is intended to point out some of the basic safety situations which may be encountered during the normal operation and maintenance of your machine and to suggest possible ways of dealing with these conditions. Read the manufacturer's operator manuals before operating the equipment. If there are no manuals with the machine – request them from the manufacturer. Study them before you start work.

If there is something in the manuals you don't understand, ask your supervisor or equipment dealer to explain it to you.



**This Safety Alert Symbol means  
Attention! Become alert!  
Your safety is involved!**

## **Operating the PTO**



When finishing operation of PTO driven equipment, shift PTO control to neutral, shut off the engine and wait until the PTO stops before getting off the tractor.

Do not wear loose fitting clothing or long, free hanging hair when operating the power take-off, or when near rotating equipment.

When operating stationary PTO driven equipment, always apply the tractor parking brake lock and block the rear wheels front and back.

To avoid injury, do not clean, adjust, unplug or service PTO driven equipment when the tractor engine is running.

Never exceed the recommended operating speed for the particular equipment in use (see implement operator's manual).

## **PTO mounted drive shafts must only be used for their intended purpose**

Implement input drivelines, clutches and freewheels are designed for specific machine types and power requirements. They must not be replaced by any shaft other than that recommended by the implement manufacturer. Note the tractor and implement manufacturers' Operating Instructions. Ensure that the implement input driveline is securely connected at both ends.

---

**A) Only use a completely guarded drive system:**

PTO drive systems with complete guarding, include the tractor master shield (7), the implement input driveline guard (4–6) and the implement shielding (8) and must be installed at all times.

If any component of the guarding system has been removed for any reason, it must be replaced or repaired prior to operation of the machine.

- 
- |                                      |   |                           |
|--------------------------------------|---|---------------------------|
| 1. Quick-release end yoke            | } | Implement input driveline |
| 2. Overload and overrunning clutches |   |                           |
| 3. Inner and outer sliding profiles  |   |                           |
- 
- |   |   |  |
|---|---|--|
| 4. Inner and outer guard tubes                | } | Complete implement input driveline guard <b>SC</b> |
| 5. Guard cone                                 |   |  |
| 6. 1 chain, 2 chains<br>(depending on design) |   |  |
- 
- |                            |
|----------------------------|
| 7. Tractor master shield   |
| 8. Implement safety shield |
- 

**B) Note the maximum operating length  $L_B$ !**

In all working positions (utilizing proper tractor attachment methods) the implement input driveline should not be extended by more than half the telescoping member overlap  $P_u$  available when fully compressed  $L_z$ . (See diagram on inside cover.)

**C) Maximum joint angles**

- |                          |     |  |     |
|--------------------------|-----|--|-----|
| 1. Joint (standard type) | }   | Ensure equal joint angles!<br>Switch off PTO if joint angles<br>are too large and unequal! |     |
| Continuous operation     |     |  | 25° |
| Short duration           |     |  | 45° |
| Stationary               | 90° |  |     |
- 
- |                        |        |                       |
|------------------------|--------|-----------------------|
| 2. Wide-angle CV joint |        |                       |
| Continuous operation   | 25°    |                       |
| Short duration         | 70/80° | (depending on design) |
| Stationary             | 70/80° | (depending on design) |

Check shaft articulation and clearance zone! Joint articulation of more than 70/80° leads to damage.

Contact between implement input driveline and tractor or implement (e.g. three point hitch, drawbar, hitch pin, jacks, etc.) leads to damage.

Do not use tractors whose PTO connection point does not allow the implement input driveline to articulate fully without interference.

---

**D) Lubrication (Figs. D1–D6)**

- Lubricate with quality grease before starting work and every 8 operating hours. Clean and grease the implement input driveline before each prolonged period of non-use.

Molded nipples on the guard near each guard bearing are intended as grease fittings and should be lubricated every 8 hours of operation!

Telescoping members must have lubrication to operate successfully regardless of whether a grease fitting is provided for that purpose! Telescoping members without fittings should be pulled apart and grease should be added manually.

- ★ Check and grease the guard tubes in winter to prevent freezing.
- 

**E) Coupling the implement input driveline (Figs. E1–E3)**

Clean and grease the PTO and implement input connection (II C)

**AS-Lock**

1. Pull locking collar and simultaneously push implement input driveline onto PTO shaft until the locking device engages.

**QD Pin-Lock**

2. Press QD pin and simultaneously push implement input driveline onto PTO shaft until pin engages.

**Push-Pull Lock**

3. Pull locking collar and simultaneously push implement input driveline onto PTO shaft until the locking device engages.



**Check to insure all the locks are securely engaged before starting work with the implement input driveline.**

---

**F)**

**Check the length of the telescoping members to insure the driveline will not bottom out or separate when turning and/or going over rough terrain.**

**Length modification of the implement input driveline should only be done at the direction of the implement manufacturer!**

---

**G) Chains (Figs. G1–G3)**

Note: The chain is intended to prevent the guard from rotating against non-moving parts and thereby reducing the likelihood of damage. A properly installed chain will increase the service life of the guard when properly maintained.

1. Chains must be attached to allow sufficient articulation of the shaft in all working positions. Care must be taken to be sure that chain does not become entangled with drawbar hitch or other restrictions during operation or transport of machine.
2. The chain is not designed to carry the weight of the implement input driveline. Damage will occur if suspended by chain.

**H) Overload and overrunning clutches (Figs. H1–H8)**

Avoid extended and frequent slipping of overload clutches.

**1. Radial pin™ clutch**

When overload occurs, the torque is limited and, during the period of slipping, is transmitted in a pulsating manner. Noise acts as a warning.

**2. Cut-out clutches – 3. Cam-type cut-out clutches**

When the torque is exceeded, power flow is interrupted. The torque is re-established by reducing the speed of and disengaging the PTO.

**4. Shear bolt clutches**

When the torque is exceeded, power flow is interrupted due to the bolt shearing. The torque is re-established by replacing the broken shear bolt. Use only the bolt specified in the operator's manual for replacement!

**5. Friction clutches**

When overload occurs, the torque is limited and transmitted constantly during the period of slipping. Short-duration torque peaks are limited.

**⚠ Prior to initial operation and after long periods out of use, release the pressure on the disks to insure proper function.**

a) Tighten nuts until friction disks are released. Rotate clutch fully.

b) Turn nuts fully back.  
Now the clutch is ready for use.

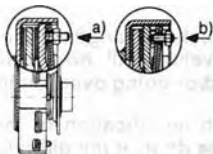

Fig. H5 shown, also applies to other models of friction clutch (see fig. H7)

## **H) Overload and overrunning clutches**

### **6. Overrunning clutches**

protect the drive against heavy rotating masses.

### **7. Friction-type overrunning clutches**

are a combination of friction clutches and overrunning clutches.

### **8. Elastic clutches**

absorb shocks and vibrations.

---

## **J) To disassemble guard: (Figs. J1–J4)**

1. Remove locking screw.
  2. Align bearing tabs with cone pockets.
  3. Remove half-guard.
  4. Remove bearing ring.
- 

## **K) To assemble guard: (Figs. K1–K5)**

1. Grease yoke groove and inner profile tube.
  2. Fit bearing ring in groove with recesses facing profile tube.
  3. Slip on half-guard.
  4. Turn cone until it engages correctly.
  5. Install locking screw.
- 

## **L) To assemble cone:**

1. Disassemble guard (Figs. J1–J3). Remove old cone (e.g. cut open with knife). Take off chain. Place neck of new cone in hot water (approx. 80° C/180° F) and pull onto bearing housing (Fig. L1).
  2. Turn guard cone into assembly position (Fig. L2).  
Further assembly instructions for guard (Figs. K1–K5).
  3. Reconnect chain if required (Fig. L3).
-

**M) Disassembly: Wide-angle implement input driveline guard**  
(Figs. **M1–M7**)

1. Remove locking screws.
  2. Remove double yoke guard cone.
  3. Remove bearing ring.
  4. Remove locking screw.
  5. Turn cone to assembly position.
  6. Remove half-guard.
  7. Remove bearing ring.
- 

**N) Assembly: Wide-angle implement input driveline guard**  
(Figs. **N1–N9**)

1. Grease yoke groove and inner profile tube.
  2. Fit bearing ring in groove with recesses facing profile tube.
  3. Slip on half-guard.
  4. Turn cone until it engages correctly.
  5. Tighten locking screw.
  6. Grease bearing groove in double yoke.
  7. Insert bearing ring.
  8. Slide guard cone for double yoke over cam from the connecting end.  
Make sure that holes for screws are visible in the recesses.
  9. Tighten locking screws.
- 

**P) Spare parts for implement input driveline guard**



**Guards are designed to protect the user.**  
**Defective and damaged guards must be repaired immediately.**  
**Only original Walterscheid agraset spare parts should be used.**

Contact your dealer.

---

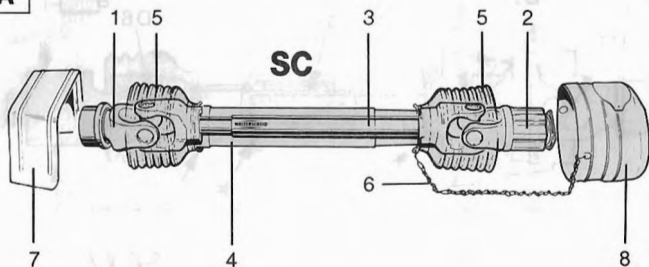
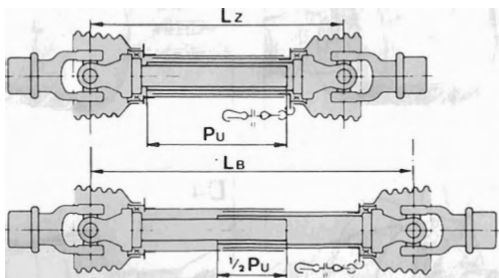
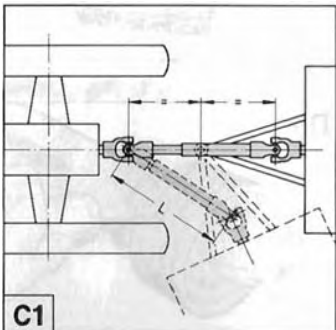
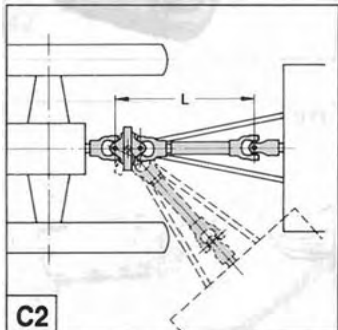
**A****B****C1****C2**



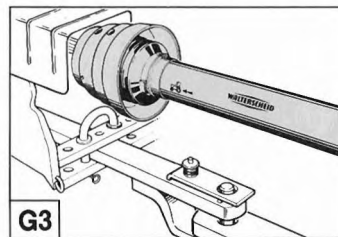
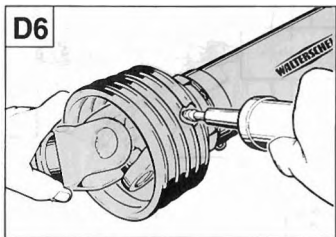
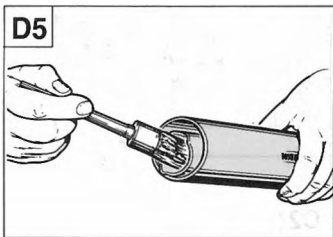
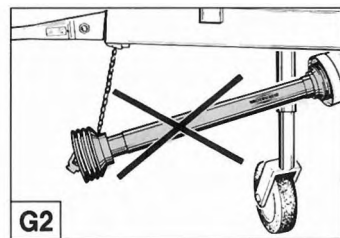
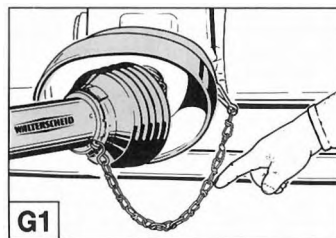
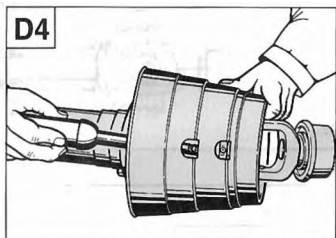
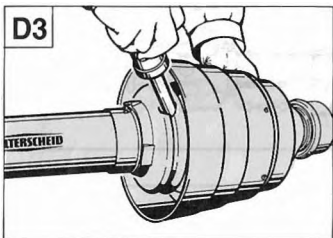
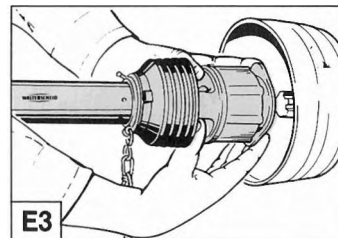
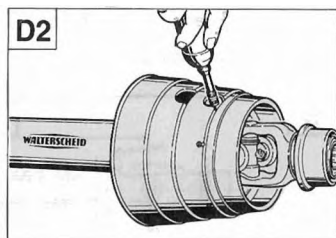
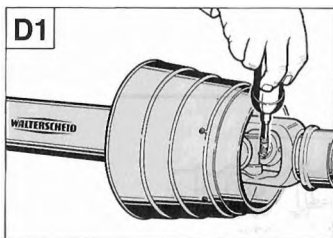
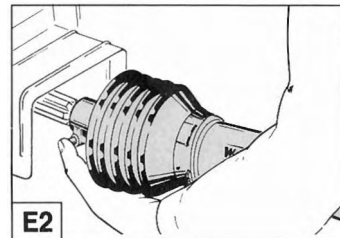
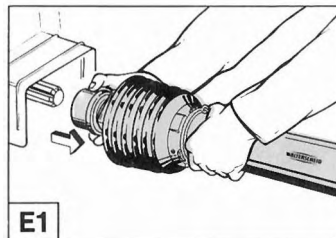
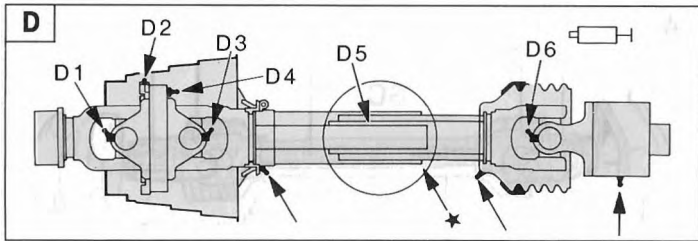

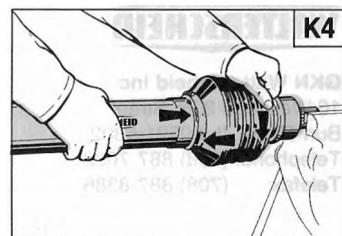
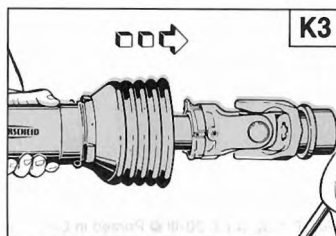
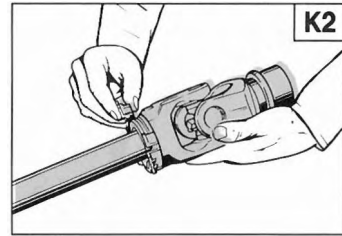
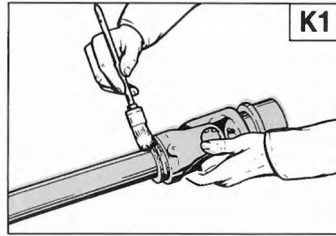
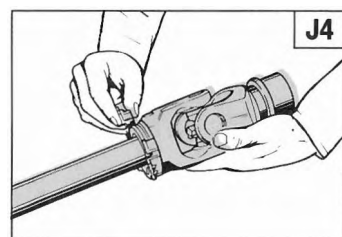
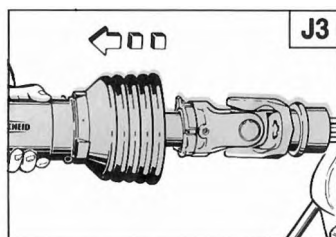
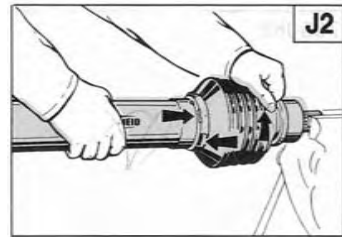
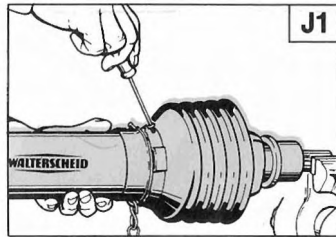
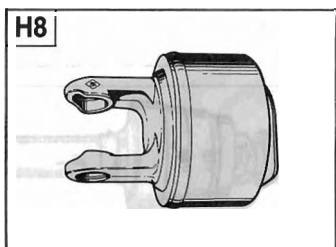
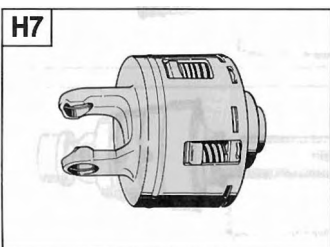
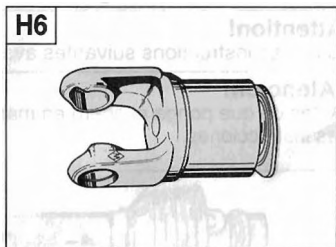
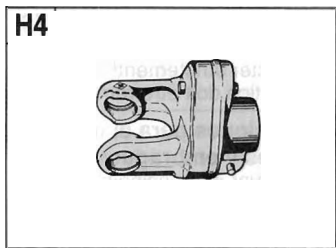
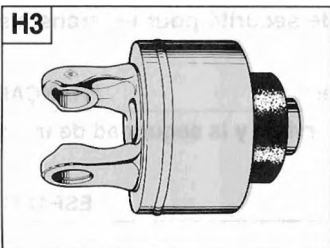
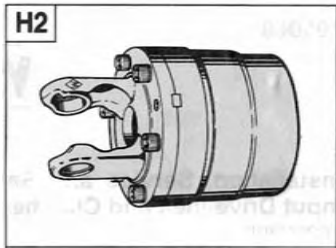
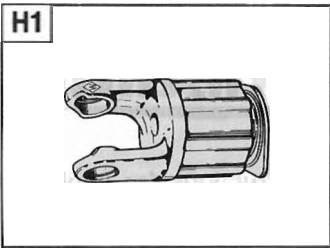

K5

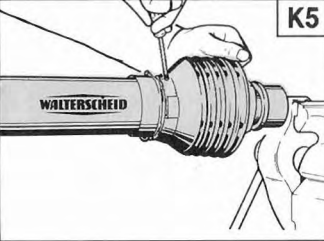

M1

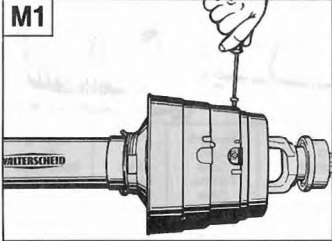

M2

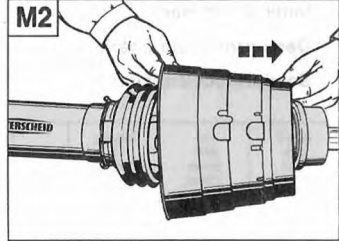

L1



L2

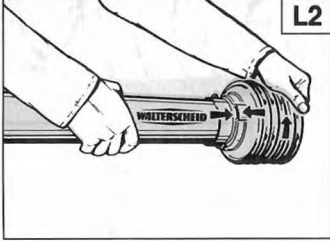

M3

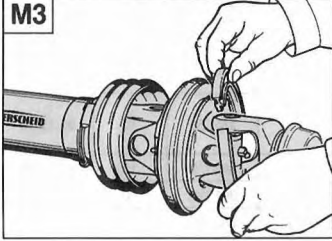

M4

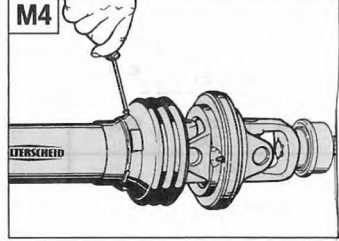

L3

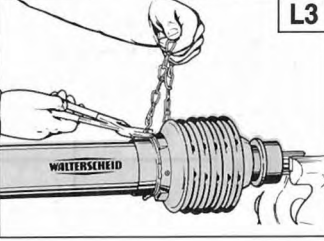

M5

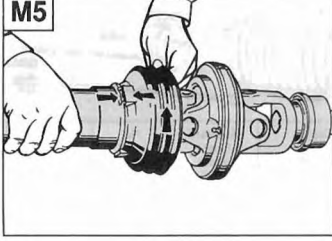

M6

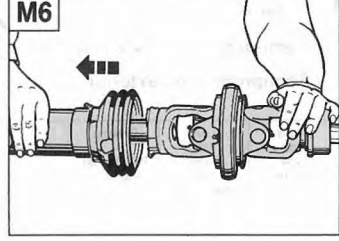

M7

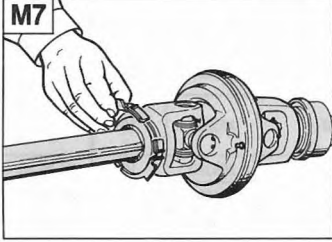

N1

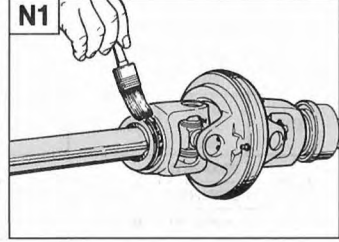

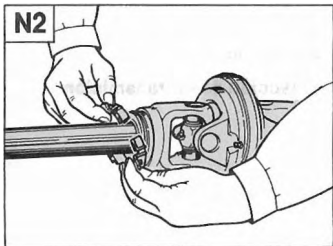
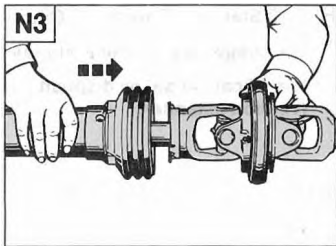
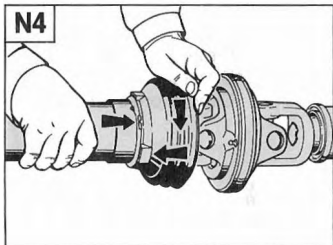
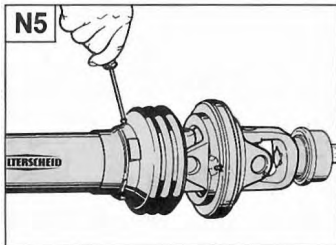
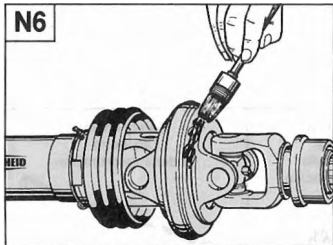
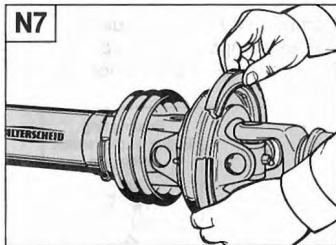
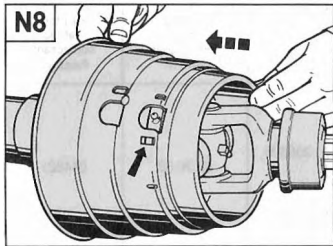
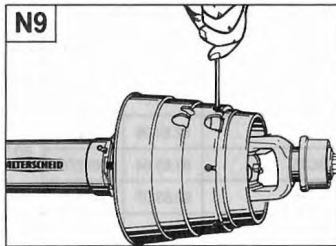
**N2****N3****N4****N5****N6****N7****N8****N9**

## P PTO Standard Drive Shaft Guard Identification

Marquage du protecteur standard pour transmission

Identificación de los dispositivos de protección de la transmisión  
(versión estándar)

SC05

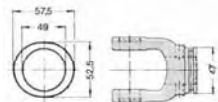

SC15

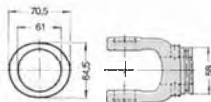

Dimensions in mm  
Dimensions en mm  
Dimensiones en mm

SC25

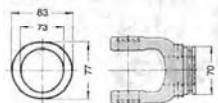

SC35

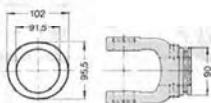

Component Parts for Guard  
Pièces composantes du protecteur  
Elementos de la protección

Guard size Type protecteur Tamaño protección	Bearing ring Bague de glissement Anillo guía		Screw Vis Tornillo de retención		Safety chain Chaînette Cadena de retención	
	Drawing No. Réf. du plan Plano N°	Part No. Réf. du composant Pieza N°	Drawing No. Réf. du plan Plano N°	Part No. Réf. du composant Pieza N°	Drawing No. Réf. du plan Plano N°	Part No. Réf. du composant Pieza N°
SC05	83.09.01	359005	60.15.00	365305	82.36.03	044321
SC15	82.83.06	087279				
SC25	82.83.04	087276				
SC35	82.83.07	342315				

**P Inner Guard Half**  
**Demi-protecteur intérieur**  
**Semiprotección interior**

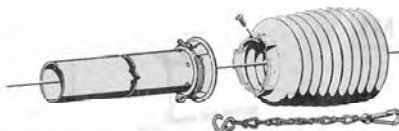

Guard Size Type protecteur Tamaño protección	Use With Series Utiliser avec série A usar con el tamaño	Drawing No. Réf. du plan Plano N°	Tube & Cap 1000 mm Standard Length Part No. Tube et bol 1000 mm Longueur standard Réf. du composant Tubo y tapa 1000 mm Longitud estándar Pieza N°	Standard Guard Cone Part No. Cône protecteur standard Réf. du composant Manguito protecteur estándar Pieza N°	No. Of Ribs Nombre d'ondes Cantidad de nervios	Drawing No. Réf. du plan Plano N°
SC05	2100 2200	80.34.05	161057	365263	10	85.05.10
SC15	2100 2200 2300	80.36.03	057742	365350	10	85.15.10
SC25	2300/2400	80.38.03	096995	365370	10	85.25.10
	2500/2600			365390	10	85.26.10
SC35	2600/2700	80.44.03	310671	365410	10	85.35.10

**Outer Guard Half**  
**Demi-protecteur extérieur**  
**Semiprotección exterior**



Guard Size Type protecteur Tamaño protección	Use With Series Utiliser avec série A usar con el tamaño	Drawing No. Réf. du plan Plano N°	Tube & Cap 1000 mm Standard Length Part No. Tube et bol 1000 mm Longueur standard Réf. du composant Tubo y tapa 1000 mm Longitud estándar Pieza N°	Standard Guard Cone Part No. Cône protecteur standard Réf. du composant Manguito protecteur estándar Pieza N°	No. Of Ribs Nombre d'ondes Cantidad de nervios	Drawing No. Réf. du plan Plano N°
SC05	2100 2200	80.35.05	368018	365263	10	85.05.10
SC15	2100 2200 2300	80.37.03	058247	365350	10	85.15.10
SC25	2300/2400	80.39.03	096997	365370	10	85.25.10
	2500/2600			365390	10	85.26.10
SC35	2600/2700	80.45.03	310674	365410	10	85.35.10

**P WWE/WWZ Outer Guard**  
**Protecteur extérieur WWE/WWZ**  
**WWE/WWZ Protección exterior**

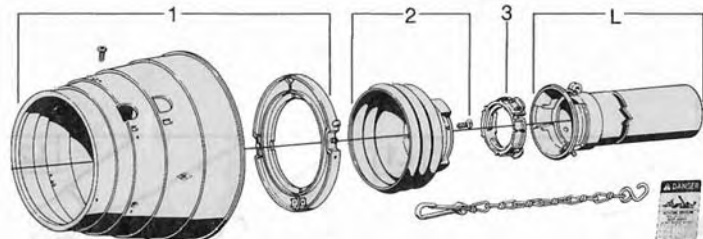

Guard Size Type protecteur Tamaño protección	Use with Series Utiliser avec série A usar con el tamaño	1 Cone and Bearing Assy Cône et roulement complet Manguito y rodamiento completos	2 Rib Cone Cône à ondes Manguito nervado No. of Ribs Nombre d'ondes Cantidad de nervios	Part No. Réf. du composant Pieza N°	3 Bearing Ring Bague de glissement Anillo deslizante	L Tube & Cap 1000 mm Standard Length Part No. Tube et bol 1000 mm Longueur standard Réf. du composant Tubo y tapa 1000 mm Longitud estándar Pieza N°	Drawing No. Réf. du plan Plano N°
SC05	WW2280	386162	3	172752	See component parts Voir pièces composantes Vea las partes componentes	368018	80.35.05
SC15			2	172750		058247	80.37.03
SC15			2				
SC25	WW2380	386158	3	172760		096997	80.39.03
SC25	WW2480	386164	3				
SC25	WW2580	386165	3	160012			

**Note:**  
 Screw included with cone. If parts other than those shown are required contact your dealer for specific part number. To receive parts shown contact your local parts dealer.

**Remarque:**  
 La vis est incluse avec le cône. En cas de besoins en d'autres composants que ceux présentés, veuillez contacter votre distributeur pour obtenir les références correspondantes. Veuillez contacter votre distributeur local pour toute livraison des composants présentés.

**Advt.:**  
 Manguito incluido tornillo. En caso de necesitarse otras piezas no ilustradas, le rogamos se dirija a su distribuidor en lo referente al número de pieza correspondiente. Las piezas arriba mostradas puede adquirirlas de su distribuidor.