

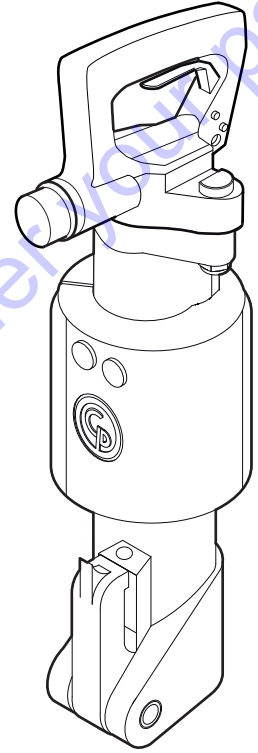

**Chicago
Pneumatic**

CP 0222

Safety and operating instructions
Handheld pneumatic pick hammers



**Discount
Equipment**

www.discount-equipment.com

PARTS FINDER

**Search Website
by Part Number**



**Search Manual
Library For Parts
Manual & Lookup Part
Numbers – Purchase
or Request Quote**

Search Manuals

Enter your information to help us find the right parts manual for your equipment.

* Brand:

* Model:

* Serial:

* Part Number:

SEARCH

**Can't Find Part or
Manual? Request Help
by Manufacturer,
Model & Description**

Parts Order Form

Please fill in the following information to help us find the right part for your equipment.

Manufacturer:	<input type="text"/>
Model:	<input type="text"/>
Description:	<input type="text"/>
Part Number:	<input type="text"/>
Quantity:	<input type="text"/>
Notes:	<input type="text"/>

Submit

Discount-Equipment.com is your online resource for quality parts & equipment.

Florida: **561-964-4949** Outside Florida TOLL FREE: **877-690-3101**

Need parts?

Click on this link: <http://www.discount-equipment.com/category/5443-parts/> and choose one of the options to help get the right parts and equipment you are looking for. Please have the machine model and serial number available in order to help us get you the correct parts. If you don't find the part on the website or on one of the online manuals, please fill out the request form and one of our experienced staff members will get back to you with a quote for the right part that your machine needs.

We sell worldwide for the brands: Genie, Terex, JLG, MultiQuip, Mikasa, Essick, Whiteman, Mayco, Toro Stone, Diamond Products, Generac Magnum, Airman, Haulotte, Barreto, Power Blanket, Nifty Lift, Atlas Copco, Chicago Pneumatic, Allmand, Miller Curber, Skyjack, Lull, Skytrak, Tsurumi, Husquvarna Target, Stow, Wacker, Sakai, Mi-T-M, Sullair, Basic, Dynapac, MBW, Weber, Bartell, Bennar Newman, Haulotte, Ditch Runner, Menegotti, Morrison, Contec, Buddy, Crown, Edco, Wyco, Bomag, Laymor, EZ Trench, Bil-Jax, F.S. Curtis, Gehl Pavers, Heli, Honda, ICS/PowerGrit, IHI, Partner, Imer, Clipper, MMD, Koshin, Rice, CH&E, General Equipment, Amida, Coleman, NAC, Gradall, Square Shooter, Kent, Stanley, Tamco, Toku, Hatz, Kohler, Robin, Wisconsin, Northrock, Oztec, Toker TK, Rol-Air, APT, Wylie, Ingersoll Rand / Doosan, Innovatech, Con X, Ammann, Mecalac, Makinex, Smith Surface Prep, Small Line, Wanco, Yanmar

Go to Discount-Equipment.com to order your parts

ENGLISH

Contents

Introduction 5

About the Safety and operating instructions 5

Safety instructions 6

- Safety signal words 6
- Personal precautions and qualifications 6
- Installation, precautions 6
- Operation, precautions 7
- Maintenance, precautions 11
- Storage, precautions 11

Overview 12

- Design and function 12
- Choosing the correct pneumatic hammer for a task 12
- Main parts 12
- Labels 12

Installation 13

- Hoses and connections 13
- Methods to prevent freezing 13
- Connecting a water separator 14
- Lubrication 14
- Insertion tool 14

Operation 15

- Start and stop 15
- Operating 15
- When taking a break 16

Maintenance 16

- Every day 16
- Periodic maintenance 16
- Tightening torques 16

Troubleshooting 17

Storage 17

Disposal 17

Technical data 18

- Machine data 18
- Noise and vibration declaration statement 18
- Noise and vibration data 18

EC Declaration of Conformity 19

- EC Declaration of Conformity (EC Directive 2006/42/EC) 19

Introduction

Thank you for choosing Chicago Pneumatic brand products. For over a century, the Chicago Pneumatic brand has represented performance and innovation in the pneumatic tool industry.

Today the brand is found around the world on a range of pneumatic and hydraulic tools that includes breakers, rock drills, chipping hammers, clay-diggers, picks and busters, scabblers, pumps and a whole lot more.

The Chicago Pneumatic brand is associated with powerful and reliable products that are easy to maintain and that give good value for the money.

About the Safety and operating instructions

The aim of the instructions is to provide you with knowledge of how to use the pneumatic pick hammer in an efficient, safe way. The instructions also give you advice and tell you how to perform regular maintenance on the pneumatic pick hammer.

Before using the pneumatic pick hammer for the first time you must read these instructions carefully and understand all of them.

Safety instructions

To reduce the risk of serious injury or death to yourself or others, read and understand the Safety and operating instruction before installing, operating, repairing, maintaining, or changing accessories on the machine.

Post this Safety and operating instruction at work locations, provide copies to employees, and make sure that everyone reads the Safety and operating instruction before operating or servicing the machine. For professional use only.

In addition, the operator or the operator's employer must assess the specific risks that may be present as a result of each use of the machine.

Safety signal words

The safety signal words Danger, Warning and Caution have the following meanings:

DANGER	Indicates a hazardous situation which, if not avoided, will result in death or serious injury.
WARNING	Indicates a hazardous situation which, if not avoided, could result in death or serious injury.
CAUTION	Indicates a hazardous situation which, if not avoided, could result in minor or moderate injury.

Personal precautions and qualifications

Only qualified and trained persons may operate or maintain the machine. They must be physically able to handle the bulk, weight, and power of the tool. Always use your common sense and good judgement.

Personal protective equipment

Always use approved protective equipment. Operators and all other persons in the working area must wear protective equipment, including at a minimum:

- > Protective helmet
- > Hearing protection
- > Impact resistant eye protection with side protection
- > Respiratory protection when appropriate
- > Protective gloves
- > Proper protective boots
- > Appropriate work overall or similar clothing (not loose-fitting) that covers your arms and legs.

Drugs, alcohol or medication

▲ **WARNING** Drugs, alcohol or medication

Drugs, alcohol or medication may impair your judgment and powers of concentration. Poor reactions and incorrect assessments can lead to severe accidents or death.

- ▶ Never use the machine when you are tired or under the influence of drugs, alcohol or medication.
- ▶ No person who is under the influence of drugs, alcohol or medication may operate the machine.

Installation, precautions

▲ **DANGER** Whipping air hose

A compressed air hose that comes loose can lash around and cause personal injury or death. To reduce this risk:

- ▶ Check that the compressed air hose and the connections are not damaged, replace if necessary.
- ▶ Check that all compressed air connections are properly attached.
- ▶ Never carry a pneumatic machine by the air hose.
- ▶ Never attempt to disconnect a compressed air hose that is pressurized. First switch off the compressed air at the compressor and then bleed the machine by activating the start and stop device.
- ▶ Do not use quick disconnect couplings at tool inlet. Use hardened steel (or material with comparable shock resistance) threaded hose fittings.
- ▶ Whenever universal twist couplings (claw couplings) are used, we recommend that lock pins are installed and whipcheck safety cables are used to safeguard against possible hose to tool and hose to hose connection failure.
- ▶ Never point a compressed air hose at yourself or anyone else. To avoid the risk of getting injured, never use compressed air to blow for example dust, dirt etc. from your clothes.

▲ WARNING Ejected insertion tool

If the tool retainer on the machine is not in a locked position, the inserted tool can be ejected with force, which can cause personal injury.

- ▶ Never start the machine while changing the insertion tool.
- ▶ Before changing the insertion tool or accessories, stop the machine, switch off the power supply and bleed the machine by activating the start and stop device.
- ▶ Never point the inserted tool at yourself or anyone else.
- ▶ Make sure that the insertion tool is fully inserted and the tool retainer is in a locked position before the machine is started.
- ▶ Check the locking function by pulling the inserted tool outwards forcefully.

▲ WARNING Moving or slipping insertion tool

An incorrect dimension of the inserted tool's shank can result in that the inserted tool is lost or is slipping out during operation. Risk of severe injury or crushed hands and fingers.

- ▶ Check that the insertion tool has the shank length and dimensions that the machine is intended for.
- ▶ Never use an insertion tool without a collar.

Operation, precautions**▲ DANGER Explosion hazard**

If an working tool comes into contact with explosives or explosive gases, an explosion could occur. When working on certain materials and when using certain materials in machine parts, sparks and ignition can occur. Explosions will lead to severe injuries or death.

- ▶ Never operate the machine in any explosive environment.
- ▶ Never use the machine near flammable materials, fumes or dust.
- ▶ Make sure that there are no undetected sources of gas or explosives.

▲ WARNING Unexpected movements

The working tool is exposed to heavy strains when the machine is used. The working tool may break due to fatigue after a certain amount of use. If the working tool breaks or gets stuck, there may be sudden and unexpected movement that can cause injuries. Furthermore, losing your balance or slipping may cause injury.

- ▶ Make sure that you always keep a stable position with your feet as far apart as your shoulder width, and keeping a balanced body weight.
- ▶ Always inspect the equipment prior to use. Never use the equipment if you suspect that it is damaged.
- ▶ Make sure that the handles are clean and free of grease and oil.
- ▶ Keep your feet away from the working tool.
- ▶ Stand firmly and always hold on to the machine with both hands.
- ▶ Never start the machine when it is lying on the ground.
- ▶ Never 'ride' on the machine with one leg over the handle.
- ▶ Never strike or abuse the equipment.
- ▶ Check regularly for wear on the working tool, and check whether there are any signs of damage or visible cracks.
- ▶ Pay attention and look at what you are doing.

▲ WARNING Dust and fume hazard

Dusts and/or fumes generated or dispersed when using the machine may cause serious and permanent respiratory disease, illness, or other bodily injury (for example, silicosis or other irreversible lung disease that can be fatal, cancer, birth defects, and/or skin inflammation).

Some dusts and fumes created by drilling, breaking, hammering, sawing, grinding and other construction activities contain substances known to the State of California and other authorities to cause respiratory disease, cancer, birth defects, or other reproductive harm. Some examples of such substances are:

- > Crystalline silica, cement, and other masonry products.
- > Arsenic and chromium from chemically-treated rubber.
- > Lead from lead-based paints.

Dust and fumes in the air can be invisible to the naked eye, so do not rely on eye sight to determine if there is dust or fumes in the air.

To reduce the risk of exposure to dust and fumes, do all of the following:

- ▶ Perform site-specific risk assessment. The risk assessment should include dust and fumes created by the use of the machine and the potential for disturbing existing dust.
- ▶ Use proper engineering controls to minimize the amount of dust and fumes in the air and to minimize build-up on equipment, surfaces, clothing, and body parts. Examples of controls include: exhaust ventilation and dust collection systems, water sprays, and wet drilling. Control dusts and fumes at the source where possible. Make sure that controls are properly installed, maintained and correctly used.
- ▶ Wear, maintain and correctly use respiratory protection as instructed by your employer and as required by occupational health and safety regulations. The respiratory protection must be effective for the type of substance at issue (and if applicable, approved by relevant governmental authority).
- ▶ Work in a well ventilated area.
- ▶ If the machine has an exhaust, direct the exhaust so as to reduce disturbance of dust in a dust filled environment.
- ▶ Operate and maintain the machine as recommended in the operating and safety instructions
- ▶ Select, maintain and replace consumables/ working tools/ other accessories as recommended in the operating and safety instructions. Incorrect selection or lack of maintenance of consumables/ inserted tools/ other accessories may cause an unnecessary increase in dust or fumes.
- ▶ Wear washable or disposable protective clothes at the worksite, and shower and change into clean clothes before leaving the worksite to reduce exposure of dust and fumes to yourself, other persons, cars, homes, and other areas.
- ▶ Avoid eating, drinking, and using tobacco products in areas where there is dust or fumes.
- ▶ Wash your hands and face thoroughly as soon as possible upon leaving the exposure area, and always before eating, drinking, using tobacco products, or making contact with other persons.
- ▶ Comply with all applicable laws and regulations, including occupational health and safety regulations.
- ▶ Participate in air monitoring, medical examination programs, and health and safety training programs provided by your employer or trade organizations and in accordance with occupational health and safety regulations and recommendations. Consult with physicians experienced with relevant occupational medicine.
- ▶ Work with your employer and trade organization to reduce dust and fume exposure at the worksite and to reduce the risks. Effective health and safety programs, policies and procedures for protecting workers and others against harmful exposure to dust and fumes should be established and implemented based on advice from health and safety experts. Consult with experts.
- ▶ Residues of hazardous substances on the machine can be a risk. Before undertaking any maintenance on the machine, clean it thoroughly.

▲ WARNING Projectiles

Failure of the work piece, of accessories, or even of the machine itself may generate high velocity projectiles. During operating, splinters or other particles from the working material may become projectiles and cause personal injury by striking the operator or other persons. To reduce these risk:

- ▶ Use approved personal protective equipment and safety helmet, including impact resistant eye protection with side protection.
- ▶ Make sure that no unauthorised persons trespass into the working zone.
- ▶ Keep the workplace free from foreign objects.
- ▶ Ensure that the work piece is securely fixed.

▲ WARNING Splinters hazard

Using the insertion tool as a hand struck tool can result in splinters hitting the operator and can cause personal injury.

- ▶ Never use an insertion tool as a hand struck tool. They are specifically designed and heat-treated to be used only in a machine.

▲ WARNING Slipping, tripping and falling hazards

There is a risk of slipping or tripping or falling, for example tripping on the hoses or on other objects. Slipping or tripping or falling can cause injury. To reduce this risk:

- ▶ Always make sure that no hose or other object is in your way or in any other person's way.
- ▶ Always make sure you are in a stable position with your feet as far apart as your shoulders width and keeping a balanced body weight.

▲ WARNING Motion hazards

When using the machine to perform work-related activities, you may experience discomfort in the hands, arms, shoulders, neck, or other parts of the body.

- ▶ Adopt a comfortable posture while maintaining secure footing and avoiding awkward off-balanced postures.
- ▶ Changing posture during extended tasks may help avoid discomfort and fatigue.
- ▶ In case of persistent or recurring symptoms, consult a qualified health professional.

▲ WARNING Vibration hazards

Normal and proper use of the machine exposes the operator to vibration. Regular and frequent exposure to vibration may cause, contribute to, or aggravate injury or disorders to the operator's fingers, hands, wrists, arms, shoulders and/or nerves and blood supply or other body parts, including debilitating and/or permanent injuries or disorders that may develop gradually over periods of weeks, months, or years. Such injuries or disorders may include damage to the blood circulatory system, damage to the nervous system, damage to joints, and possibly damage to other body structures.

If numbness, persistent recurring discomfort, burning sensation, stiffness, throbbing, tingling, pain, clumsiness, weakened grip, whitening of the skin, or other symptoms occur at any time, when operating the machine or when not operating the machine, stop operating the machine, tell your employer and seek medical attention. Continued use of the machine after the occurrence of any such symptom may increase the risk of symptoms becoming more severe and/or permanent.

Operate and maintain the machine as recommended in these instructions, to prevent an unnecessary increase in vibration.

The following may help to reduce exposure to vibration for the operator:

- ▶ Let the tool do the job. Use a minimum hand grip consistent with proper control and safe operation.
- ▶ If the machine has vibration absorbing handles, keep them in a central position, avoid pressing the handles into the end stops.
- ▶ When the percussion mechanism is activated, the only body contact with the machine you should have are your hands on the handle or handles. Avoid any other contact, for example supporting any part of the body against the machine or leaning onto the machine trying to increase the feed force. It is also important not to keep the start and stop device engaged while extracting the tool from the work surface.
- ▶ Make sure that the inserted tool is well-maintained (including sharpness, if a cutting tool), not worn out, and of the proper size. Insertion tools that are not well-maintained, or that are worn out, or that are not of the proper size result in longer time to complete a task (and a longer period of exposure to vibration) and may result in or contribute to higher levels of vibration exposure.
- ▶ Immediately stop working if the machine suddenly starts to vibrate strongly. Before resuming the work, find and remove the cause of the increased vibrations.
- ▶ Never grab, hold or touch the inserted tool when using the machine.

- ▶ Participate in health surveillance or monitoring, medical exams and training programs offered by your employer and when required by law.
- ▶ When working in cold conditions wear warm clothing and keep hands warm and dry.
- ▶ The exhaust air is strongly chilled and shall not make contact with the operator. Always direct the exhaust air away from hands and body.

See the "Noise and vibration declaration statement" for the machine, including the declared vibration values. This information can be found at the end of these Safety and operating instructions.

- ◆ Comply with the recommended air-pressure when operating the machine. Either higher or lower air-pressure has the potential of resulting in higher levels of vibration.

▲ DANGER Electrical hazard

The machine is not electrically insulated. If the machine comes into contact with electricity, serious injuries or death may result.

- ▶ Never operate the machine near any electric wire or other source of electricity.
- ▶ Make sure that there are no concealed wires or other sources of electricity in the working area.

▲ WARNING Concealed object hazard

During operating, concealed wires and pipes constitute a danger that can result in serious injury.

- ▶ Check the composition of the material before operating.
- ▶ Watch out for concealed cables and pipes for example electricity, telephone, water, gas and sewage lines etc.
- ▶ If the inserted tool seems to have hit a concealed object, switch off the machine immediately.
- ▶ Make sure that there is no danger before continuing.

▲ WARNING Involuntary start

Involuntary start of the machine may cause injury.

- ▶ Keep your hands away from the start and stop device until you are ready to start the machine.
- ▶ Learn how the machine is switched off in the event of an emergency.
- ▶ Release the start and stop device immediately in all cases of power supply interruption.
- ▶ Whenever fitting or removing the insertion tool, switch off the air supply, bleed the machine by pressing the start and stop device and disconnect the machine from the power source.

▲ WARNING Noise hazard

High noise levels can cause permanent and disabling hearing loss and other problems such as tinnitus (ringing, buzzing, whistling or humming in the ears). To reduce risk and prevent an unnecessary increase in noise levels:

- ▶ Risk assessment of these hazards and implementation of appropriate controls is essential.
- ▶ Operate and maintain the machine as recommended in these instructions.
- ▶ Select, maintain and replace the insertion tool as recommended in these instructions.
- ▶ If the machine has a muffler, check that it is in place and in good working condition.
- ▶ Always use hearing protection.
- ▶ Use damping material to prevent work pieces from "ringing".

Maintenance, precautions

▲ WARNING Machine modification

Any machine modification may result in bodily injuries to yourself or others.

- ▶ Never modify the machine. Modified machines are not covered by warranty or product liability.
- ▶ Always use original parts, cutting blades/working tools, and accessories.
- ▶ Change damaged parts immediately.
- ▶ Replace worn components in good time.

▲ CAUTION Hot working tool

The tip of the working tool can become hot and sharp when used. Touching it can lead to burns and cuts.

- ▶ Never touch a hot or sharp working tool.
- ▶ Wait until the working tool has cooled down before carrying out maintenance work.

▲ WARNING Working tool hazards

Accidental engagement of the start and stop device during maintenance or installation can cause serious injuries, when the power source is connected.

- ▶ Never inspect, clean, install, or remove the working tool while the power source is connected.

Storage, precautions

- ◆ Keep the machine and tools in a safe place, out of the reach of children and locked up.

Overview

To reduce the risk of serious injury or death to yourself or others, read the Safety instructions section found on the previous pages of this manual before operating the machine.

Design and function

These instructions apply to the CP 0222 model. The CP 0222 is designed for light demolition and construction work. This machine can be used both horizontally and vertically. No other use is permitted. To choose the correct insertion tool, see the spare parts list.

Choosing the correct pneumatic hammer for a task

It is important to choose the correct size of pneumatic hammer for the work to be performed.

A pneumatic hammer that is too small means that the work will take longer.

A hammer that is too big means that there must be frequent repositioning, which is unnecessarily tiring for the operator.

A simple rule for choosing the correct size of pneumatic hammer is that a normal sized piece of broken material should be removed from the workpiece within 5–10 seconds operation.

- > If it takes less than 5 seconds a smaller pneumatic hammer should be selected.
- > If it takes more than 10 seconds a larger pneumatic hammer should be selected.

Main parts

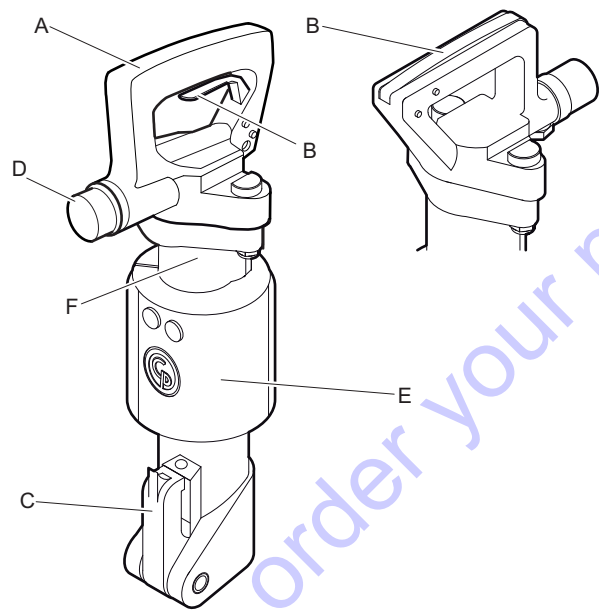

CP 0222 CHIT,
CP 0222 CHITBS

CP 0222 CHOTBS

- A. Handle
- B. Trigger
- C. Tool retainer
- D. Air inlet
- E. Muffler (only BS-versions)
- F. Cylinder

Labels

The machine is fitted with labels containing important information about personal safety and machine maintenance. The labels must be in such condition that they are easy to read. New labels can be ordered from the spare parts list.

Data plate

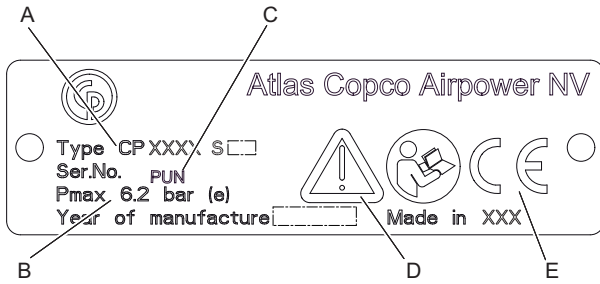

- A. Machine type
- B. Maximum permitted compressed air pressure
- C. Serial number
- D. The warning symbol together with the book symbol means that the user must read the safety and operating instructions before the machine is used for the first time.
- E. The CE symbol means that the machine is EC-approved. See the EC declaration which is delivered with the machine for more information. If the CE symbol is missing, it means that the machine is not EC-approved.

Noise level label

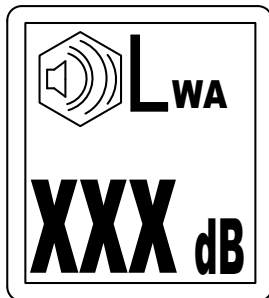

The label indicates the guaranteed noise level corresponding to EC-directive 2000/14/EC. See "Technical data" for accurate noise level.

Safety label

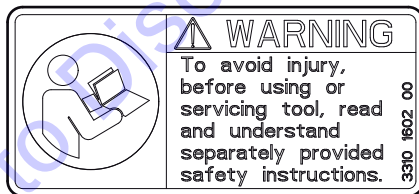

To avoid injury, before using or servicing tool, read and understand separately provided safety instructions.

Eject warning label

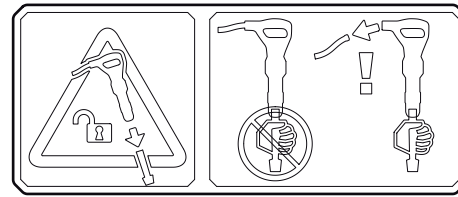

The label indicates that the machine must be disconnected from the power source before removing or changing the inserted tool.

Installation

Hoses and connections

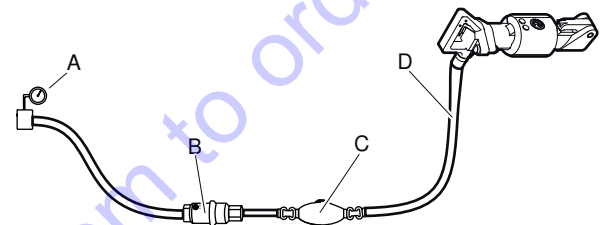

- A. Compressed air source
 - B. Water separator (optional)
 - C. Oiler (optional)
 - D. Max. 10 feet (3 meter) compressed air hose between the oiler and the machine.
- ◆ Check that you are using the correct recommended operating pressure, 87 psig (6 bar (e)).
 - ◆ The maximum permissible air pressure, 90 psig (6.2 bar (e)), must not be exceeded.
 - ◆ Blow any impurities out of the compressed air hose before connecting it to the machine.
 - ◆ Select the correct dimension and length for the compressed air hose. For hose lengths up to 100 feet (30 meters), a hose with a minimum internal diameter of 3/4 in. (19 mm) should be used. If the hose length is between 100 and 330 feet (30 and 100 meters), a hose with a minimum internal diameter of 1 in. (25 mm) should be used.

Methods to prevent freezing

Ice formation in the muffler can occur when the ambient air temperature is 32-50 °F (0-10 °C) and the relative humidity is high.

The machine is designed to avoid the formation of ice in the muffler. Despite this, under extreme conditions ice can form in the muffler.

The following actions can be taken to further counteract the risk of ice formation:

- ◆ Use CP Airolene Plus Tool Oil as a lubricant. CP Airolene Plus Tool Oil counteracts freezing.
- ◆ Use a water separator.

Connecting a water separator

The length of the air hose between the compressor and the water separator must be such that the water vapour is cooled and condenses in the hose before reaching the water separator.

If the ambient temperature is below 32 °F (0 °C) the hose must be short enough to prevent the water from freezing before reaching the water separator.

Lubrication

Lubrication

The lubricant is important for the machine's function and has a great impact on the service life. In order to supply the correct volume of oil, an oiler should be connected to the air hose. The use of a Chicago Pneumatic air line oiler is recommended. To guarantee good lubrication, the length of the air hose between the oiler and the pneumatic tool should not exceed 10 feet (3 m).

Too much lubrication can cause starting problems, low power or uneven performance.

Use a synthetic lubricant such as CP Airolene Plus Tool Oil or mineral oil with the properties recommended in the table below.

Lubricant	Temperature range °F (°C)	Viscosity
CP Airolene Plus Tool Oil	-4 to +120 (-20 to +50)	-
Air tool oil	-4 to +60 (-20 to +15)	100-150 SUS (ISO VG 22-32)
Air tool oil	+60 to +120 (+15 to +50)	225-350 SUS (ISO VG 46-68)

It is recommended that the oil contains a rust-inhibitor.

Insertion tool

▲ CAUTION Hot working tool

The tip of the working tool can become hot and sharp when used. Touching it can lead to burns and cuts.

- ▶ Never touch a hot or sharp working tool.
- ▶ Wait until the working tool has cooled down before carrying out maintenance work.

NOTICE Never cool a hot insertion tool in water, it can result in brittleness and early failure.

Selecting the right insertion tool

Selecting the right insertion tool is a precondition for proper machine function. It is important to select insertion tools of high quality to avoid unnecessary machine damage.

The machine can be destroyed if you use an incorrect insertion tool.

Recommended insertion tools are listed in the machine's spare parts list.

Narrow chisel

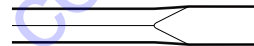

The narrow chisel is used for demolition and cutting work in concrete and other types of hard materials.

Moil point



The moil point is only used for making holes in concrete and other types of hard materials.

Wide bladed chisel

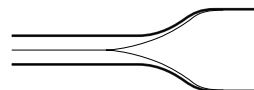

The wide bladed chisel is used in soft materials, such as asphalt and frozen ground.

▲ WARNING Vibration hazard

Using inserted tools that do not fulfil the criterias mentioned below, will result in a longer time to complete a task, and may result in higher levels of vibration exposure. A worn tool will also cause increased working time.

- ▶ Make sure that the inserted tool is well-maintained, not worn out and of the proper size.
- ▶ Always use a sharp tool in order to work efficiently.

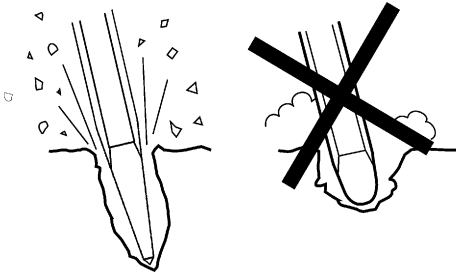

Fitting and removing the insertion tool

Whenever fitting or removing the insertion tool the following instructions must be observed:

1. To prevent an accidental start: switch off the power supply and bleed the machine by pressing the start and stop device. Disconnect the machine from the power source.
2. Before inserting a tool, lubricate the tool shank with grease.
3. Fit or remove the insertion tool.
4. Close the tool retainer (position A) and check the lock function by tugging the inserted tool sharply outwards.

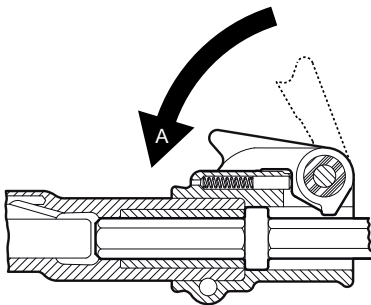

Operation

▲ WARNING Involuntary start

Involuntary start of the machine may cause injury.

- ▶ Keep your hands away from the start and stop device until you are ready to start the machine.
- ▶ Learn how the machine is switched off in the event of an emergency.
- ▶ Stop the machine immediately in all cases of power supply interruption.

Start and stop

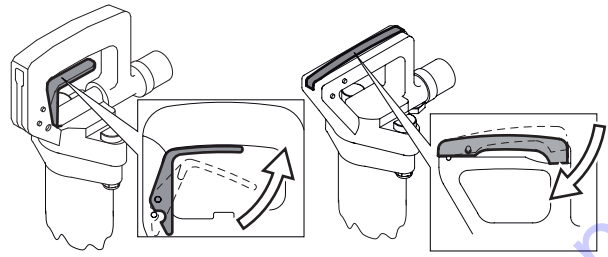

Start the machine by squeezing the trigger while firmly holding the handle.

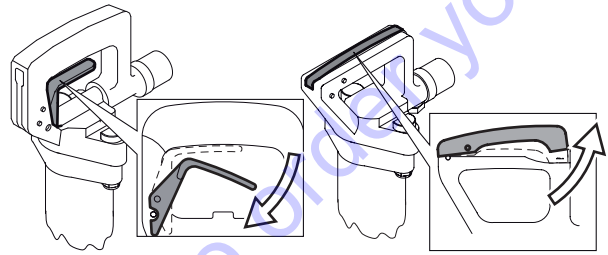

Stop the machine by releasing the trigger. The trigger returns automatically to the stop position.

Operating

Starting a cut

- ◆ Stand in a stable position with your feet well away from the inserted tool.
- ◆ Press the machine against the working surface before you start.
- ◆ Start collaring at such a distance from the edge that the machine is capable of breaking the material without levering.
- ◆ Never try to break off too large pieces. Adjust the breaking distance (A) so that the inserted tool does not get stuck.

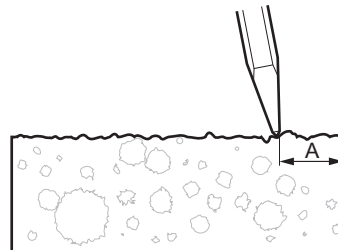

Breaking

- ◆ Let the machine do the work; do not press too hard.
- ◆ Avoid working in extremely hard materials for example granite and reinforcing iron (re-bar) which would cause substantial vibrations.
- ◆ Any form of idling, operating without insertion tool or operating with an uplifted machine must be avoided.
- ◆ When the machine is lifted, the start and stop device must not be activated.
- ◆ Check regularly that the machine is well lubricated.

When taking a break

- ◆ During all breaks you must place the machine in such a way that there is no risk for it to be unintentionally started. Make sure to place the machine on the ground, so that it can not fall.
- ◆ In the event of a longer break or when leaving the workplace: Switch off the power supply and then bleed the machine by activating the start and stop device.

Maintenance

Regular maintenance is a basic requirement for the continued safe and efficient use of the machine. Follow the maintenance instructions carefully.

- ◆ Before starting maintenance on the machine, clean it in order to avoid exposure to hazardous substances. See "Dust and fumé hazard".
- ◆ Use only authorised parts. Any damage or malfunction caused by the use of unauthorised parts is not covered by warranty or product liability.
- ◆ When cleaning mechanical parts with solvent, comply with appropriate health and safety regulations and ensure there is satisfactory ventilation.
- ◆ For major service of the machine, contact the nearest authorised workshop.
- ◆ After each service, check that the machine's vibration level is normal. If not, contact the nearest authorised workshop.

Every day

Before undertaking any maintenance or changing the insertion tool on pneumatic machines, always switch off the air supply and bleed the machine by depressing the start and stop device then disconnect the air hose from the machine.

- ◆ Clean and inspect the machine and its functions each day before the work commences.
- ◆ Check the tool retainer for wear and function.
- ◆ Conduct a general inspection for leaks and damage.
- ◆ Check that the air inlet nipple is tightened and that the claw coupling is free from damage.
- ◆ Check that the backhead bolts are tightened according to section "Tightening torques".
- ◆ For the machine to maintain the specified vibration values, always check the following: Too large a clearance between the insertion tool's shank and the chisel bushing will generate increased vibrations. To avoid getting exposed to excessive vibrations, check the chisel bushing for wear every day.
- ◆ If the machine has a vibration-absorbing handle/handles, check that it moves freely (up and down) and does not jam.
- ◆ Change damaged parts immediately.
- ◆ Replace worn components in good time.
- ◆ Make sure that all the attached and related equipment, such as hoses, water separators and oilers are properly maintained.

Periodic maintenance

After each operating period of approximately 150 impact hours or twice a year the machine must be dismantled and all parts be cleaned and checked. This work must be performed by authorised staff who are trained for this task.

Tightening torques

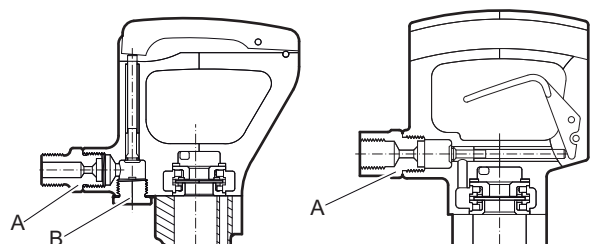

CP 0222 CHOTBS

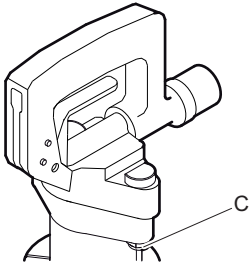
CP 0222 CHIT
CP 0222 CHITBSCP 0222 CHIT
CP 0222 CHITBS
CP 0222 CHOTBS

- A. Air inlet nipple: 80-100 lbf/ft (108-136 Nm), use Loctite® 243™ (Loctite is a registered trademark of Henkel Corporation. 243 is a trademark of Henkel Corporation.)
- B. Plug: 80-100 lbf/ft (108-136 Nm). After tightening bend tab washer up against the plug.
- C. Nut: 75-85 lbf/ft (102-115 Nm).

Troubleshooting

If the pneumatic machine does not start, has low power or uneven performance, check the following points.

- ◆ Check that the insertion tool being used has the correct shank dimension.
- ◆ Check that the pneumatic machine is getting the correct amount of lubricant. Too much lubrication can cause starting problems, low power or uneven performance.
- ◆ Check that the compressed air system supplies the machine with sufficient air pressure to give full power.
- ◆ Check that the dimension and length of the air hose are according to the recommendations. See “Installation”.
- ◆ If there is a risk of freezing, check that the machine's exhaust ports are not blocked.
- ◆ If the machine function is still not satisfactory after this procedure, contact an authorised service workshop.

Storage

- > Clean the machine properly before storage, in order to avoid hazardous substances. See “Dust and fume hazard”
- > Pour approximately 1½ oz (5 cl) of oil directly into the air inlet nipple, connect the machine to the compressed air supply and start it for a few seconds.
- > Always store the machine in a dry place.

Disposal

A used machine must be treated and disposed of in such a way that the greatest possible portion of the material can be recycled and any negative influence on the environment is kept as low as possible, and in respect to local restrictions.

Technical data

Machine data

Type	Shank dimension in. (mm)	Weight lb (kg)	Length in. (mm)	Impact freq. Hz	Air consumption foot ³ /min (l/s)
CP 0222 CHIT	H 7/8 x 3 1/4 (H22 x 82.5)	22 (10.0)	19 1/2 (495)	28	40 (19)
CP 0222 CHITBS	H 7/8 x 3 1/4 (H22 x 82.5)	23 (10.5)	19 1/2 (495)	28	40 (19)
CP 0222 CHOTBS	H 7/8 x 3 1/4 (H22 x 82.5)	23 (10.5)	19 1/2 (495)	28	40 (19)

Noise and vibration declaration statement

Guaranteed sound power level **L_w** according to EN ISO 3744 in accordance with directive 2000/14/EC.

Sound pressure level **L_p** according to EN ISO 11203.

Vibration value **A** and uncertainty **B** determined according to EN ISO 28927-10. See table "Noise and vibration data" for the values of A, B, etc.

These declared values were obtained by laboratory type testing in accordance with the stated directive or standards and are suitable for comparison with the declared values of other tools tested in accordance with the same directive or standards. These declared values are not suitable for use in risk assessments and values measured in individual work places may be higher. The actual exposure values and risk of harm experienced by an individual user are unique and depend upon the way the user works, in what material the machine is used, as well as upon the exposure time and the physical condition of the user, and the condition of the machine.

We, Atlas Copco Airpower NV, cannot be held liable for the consequences of using the declared values, instead of values reflecting the actual exposure, in an individual risk assessment in a work place situation over which we have no control.

This tool may cause hand-arm vibration syndrome if its use is not adequately managed. An EU guide to managing hand-arm vibration can be found at <http://www.humanvibration.com/humanvibration/EU/VIBGUIDE.html>

We recommend a programme of health surveillance to detect early symptoms which may relate to vibration exposure, so that management procedures can be modified to help prevent future impairment.

Noise and vibration data

Type	Noise		Vibration	
	Declared values		Declared values	
	Sound pressure	Sound power	Three axes values	
	EN ISO 11203	2000/14/EC	EN ISO 28927-10	
	L_p r=1m dB(A) rel 20µPa	L_w guaranteed dB(A) rel 1pW	A m/s ² value	B m/s ² spreads
CP 0222 CHITBS	90	105	19.8	2.5
CP 0222 CHOTBS	90	105	19.8	2.5

EC Declaration of Conformity

EC Declaration of Conformity (EC Directive 2006/42/EC)

We, Atlas Copco Airpower NV, hereby declare that the machines listed below conform to the provisions of EC Directive 2006/42/EC (Machinery Directive) and 2000/14/EC (Noise Directive), and the harmonised standards mentioned below.

Handheld pneumatic pick hammers	Guaranteed sound power level [dB(A)]	Measured sound power level [dB(A)]	Pmax (bar)
CP 0222 CHITBS	105	101	6.2
CP 0222 CHOTBS	105	101	6.2

Following harmonised standards were applied:

- ◆ EN ISO 11148-4

Notified body involved for directive:

0044, TÜV NORD CERT GmbH
Langemarckstraße 20,
45141 Essen
Country : Germany

Technical Documentation authorised representative:

Vijay Sharma
Product Company Chakan
Pune

Vice President Design and Development:

Gill Dhooghe

Manufacturer:

Atlas Copco Airpower NV,
Boomssteenweg 957,
2610 Wilrijk - Belgium

Place and date:

Pune, 2021-10



**Chicago
Pneumatic**



www.discount-equipment.com

Go to Discount-Equipment.com to order your parts

PARTS FINDER

**Search Website
by Part Number**



**Search Manual
Library For Parts
Manual & Lookup Part
Numbers – Purchase
or Request Quote**

Search Manuals

Enter your information to help us find the right parts manual for your machine.

* Brand:

* Model:

* Serial:

* Part Number:

SEARCH

**Can't Find Part or
Manual? Request Help
by Manufacturer,
Model & Description**

Parts Order Form

Please fill in the following information to help us find the right part for your machine.

Manufacturer:	<input type="text"/>
Model:	<input type="text"/>
Description:	<input type="text"/>
Part Number:	<input type="text"/>
Quantity:	<input type="text"/>
Notes:	<input type="text"/>

Submit

Discount-Equipment.com is your online resource for quality parts & equipment.

Florida: **561-964-4949** Outside Florida TOLL FREE: **877-690-3101**

Need parts?

Click on this link: <http://www.discount-equipment.com/category/5443-parts/> and choose one of the options to help get the right parts and equipment you are looking for. Please have the machine model and serial number available in order to help us get you the correct parts. If you don't find the part on the website or on one of the online manuals, please fill out the request form and one of our experienced staff members will get back to you with a quote for the right part that your machine needs.

We sell worldwide for the brands: Genie, Terex, JLG, MultiQuip, Mikasa, Essick, Whiteman, Mayco, Toro Stone, Diamond Products, Generac Magnum, Airman, Haulotte, Barreto, Power Blanket, Nifty Lift, Atlas Copco, Chicago Pneumatic, Allmand, Miller Curber, Skyjack, Lull, Skytrak, Tsurumi, Husquvarna Target, Stow, Wacker, Sakai, Mi-T-M, Sullair, Basic, Dynapac, MBW, Weber, Bartell, Bennar Newman, Haulotte, Ditch Runner, Menegotti, Morrison, Contec, Buddy, Crown, Edco, Wyco, Bomag, Laymor, EZ Trench, Bil-Jax, F.S. Curtis, Gehl Pavers, Heli, Honda, ICS/PowerGrit, IHI, Partner, Imer, Clipper, MMD, Koshin, Rice, CH&E, General Equipment, Amida, Coleman, NAC, Gradall, Square Shooter, Kent, Stanley, Tamco, Toku, Hatz, Kohler, Robin, Wisconsin, Northrock, Oztec, Toker TK, Rol-Air, APT, Wylie, Ingersoll Rand / Doosan, Innovatech, Con X, Ammann, Mecalac, Makinex, Smith Surface Prep, Small Line, Wanco, Yanmar