



Spare parts list

**Handheld pneumatic chipping hammers
CP 0012 H19, CP 0012 2R, CP 0012 2H**



**Discount
Equipment**

www.discount-equipment.com

Chicago Pneumatic Construction Tools

PARTS FINDER

**Search Website
by Part Number**



**Search Manual
Library For Parts
Manual & Lookup Part
Numbers – Purchase
or Request Quote**

Search Manuals

Enter your information to search for a manual or parts information for your equipment.

* Brand:

* Model:

* Serial:

* Part Number:

SEARCH

**Can't Find Part or
Manual? Request Help
by Manufacturer,
Model & Description**

Parts Order Form

Please fill in the following information to request help finding a part or manual.

Manufacturer:

Model:

Description:

Quantity:

Part Number:

Part Name:

Part Description:

Part Location:

Part Condition:

Part Status:

Part Material:

Part Color:

Part Weight:

Part Dimensions:

Part Notes:

Submit

Discount-Equipment.com is your online resource for quality parts & equipment.

Florida: **561-964-4949** Outside Florida TOLL FREE: **877-690-3101**

Need parts?

Click on this link: <http://www.discount-equipment.com/category/5443-parts/> and choose one of the options to help get the right parts and equipment you are looking for. Please have the machine model and serial number available in order to help us get you the correct parts. If you don't find the part on the website or on one of the online manuals, please fill out the request form and one of our experienced staff members will get back to you with a quote for the right part that your machine needs.

We sell worldwide for the brands: Genie, Terex, JLG, MultiQuip, Mikasa, Essick, Whiteman, Mayco, Toro Stone, Diamond Products, Generac Magnum, Airman, Haulotte, Barreto, Power Blanket, Nifty Lift, Atlas Copco, Chicago Pneumatic, Allmand, Miller Curber, Skyjack, Lull, Skytrak, Tsurumi, Husquvarna Target, Stow, Wacker, Sakai, Mi-T-M, Sullair, Basic, Dynapac, MBW, Weber, Bartell, Bennar Newman, Haulotte, Ditch Runner, Menegotti, Morrison, Contec, Buddy, Crown, Edco, Wyco, Bomag, Laymor, EZ Trench, Bil-Jax, F.S. Curtis, Gehl Pavers, Heli, Honda, ICS/PowerGrit, IHI, Partner, Imer, Clipper, MMD, Koshin, Rice, CH&E, General Equipment, Amida, Coleman, NAC, Gradall, Square Shooter, Kent, Stanley, Tamco, Toku, Hatz, Kohler, Robin, Wisconsin, Northrock, Oztec, Toker TK, Rol-Air, APT, Wylie, Ingersoll Rand / Doosan, Innovatech, Con X, Ammann, Mecalac, Makinex, Smith Surface Prep, Small Line, Wanco, Yanmar



Go to Discount-Equipment.com to order your parts

2009-06

No.9800 0516 93a

© Copyright Chicago Pneumatic Construction Tools
STOCKHÖLM • SWEDEN



Contents

Spare parts list..... 4

CP 0012 H19 4

CP 0012 2R 6

CP 0012 2H 8

Working tools..... 10

Hexagon 19 x 50 mm (¾" x 2")..... 10

Hexagon, oval collar 14.7 mm (0.580") 10

Hexagon, round collar 14.7 mm (0.580")..... 11

Round, oval collar 17.3 mm (0.680")..... 11

Round, round collar 17.3 mm (0.680")..... 12

Hexagon ¾" x 2" (19 x 50 mm)..... 12

Hexagon, oval collar 0.580" (14.7 mm)..... 12

Hexagon, round collar 0.580" (14.7 mm)..... 13

Round, oval collar 0.680" (17.3 mm)..... 13

Round, round collar 0.680" (17.3 mm)..... 14

Go to Discount-Equipment.com to order your parts



Spare parts list

CP 0012 H19

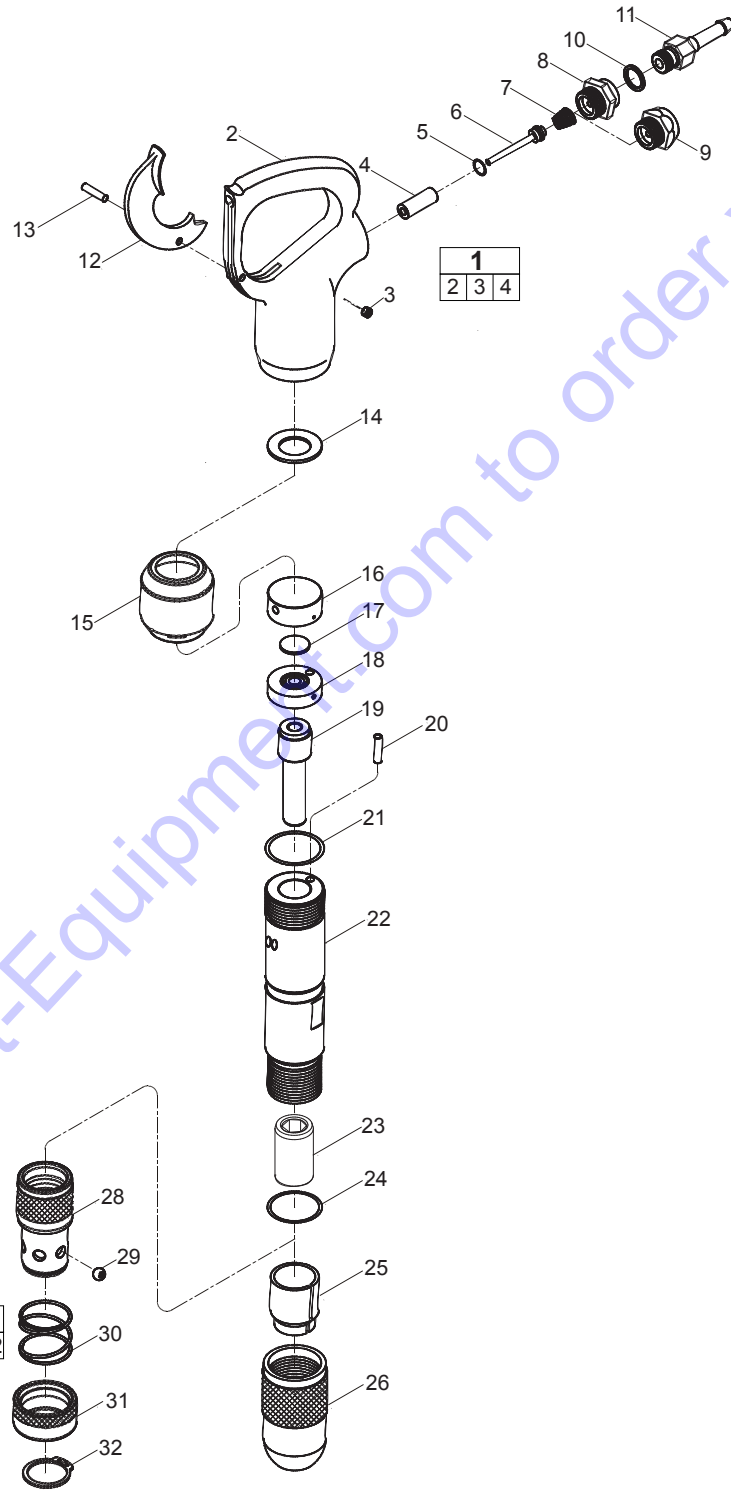

Go to Discount-Equipment.com to order your parts



No.	Description	Remark	Quantity	Part number
1(2-4)	Handle, complete		1	Z8360858
2	Handle		1	-
3	Plug	1/16 x 27 NPTF	1	C102507
4	Bushing - Throttle valve		1	-
5	O-ring - Throttle valve		1	Q0132858
6	Throttle valve		1	D3182858
7	Spring - Throttle valve		1	R085596
8	Air inlet bushing	BSP	1	F064697
9	Air inlet bushing	NPTF (optional)	1	R085893
10	Gasket - Hose tail		1	F064696
11	Hose tail	3/8" BSP	1	F064695
12	Lever - Throttle		1	F027853
13	Pin - Throttle lever		1	A043627
14	Washer	1.0 mm	2	Q4204858
15	Muffler		1	H3740858
16	Valve housing		1	Z3803858
17	Main valve		1	D7368858
18	Lower valve lid		1	D5090858
19	Piston		1	D1579858
20	Pin - Dowel	Pipe	1	D7288858
21	O-ring	Cylinder	1	H0359858
22	Cylinder		1	-
23	Guide bush	Hexagon 19 x 50 mm	1	D8389858
24	Retainer lock ring	39.2 x 3 mm	1	H2228858
25	Buffer		1	H2303858
26	Retainer		1	C8788859
27(28-32)	Retainer, complete	Ball type screw - on (optional)	1	Z8389857
28	Retainer		1	-
29	Chuck retainer ball	6 retainer balls included	1	Z8754857
30	Spring		1	H3437857
31	Retainer sleeve		1	-
32	External circlip		1	H3275857



CP 0012 2R

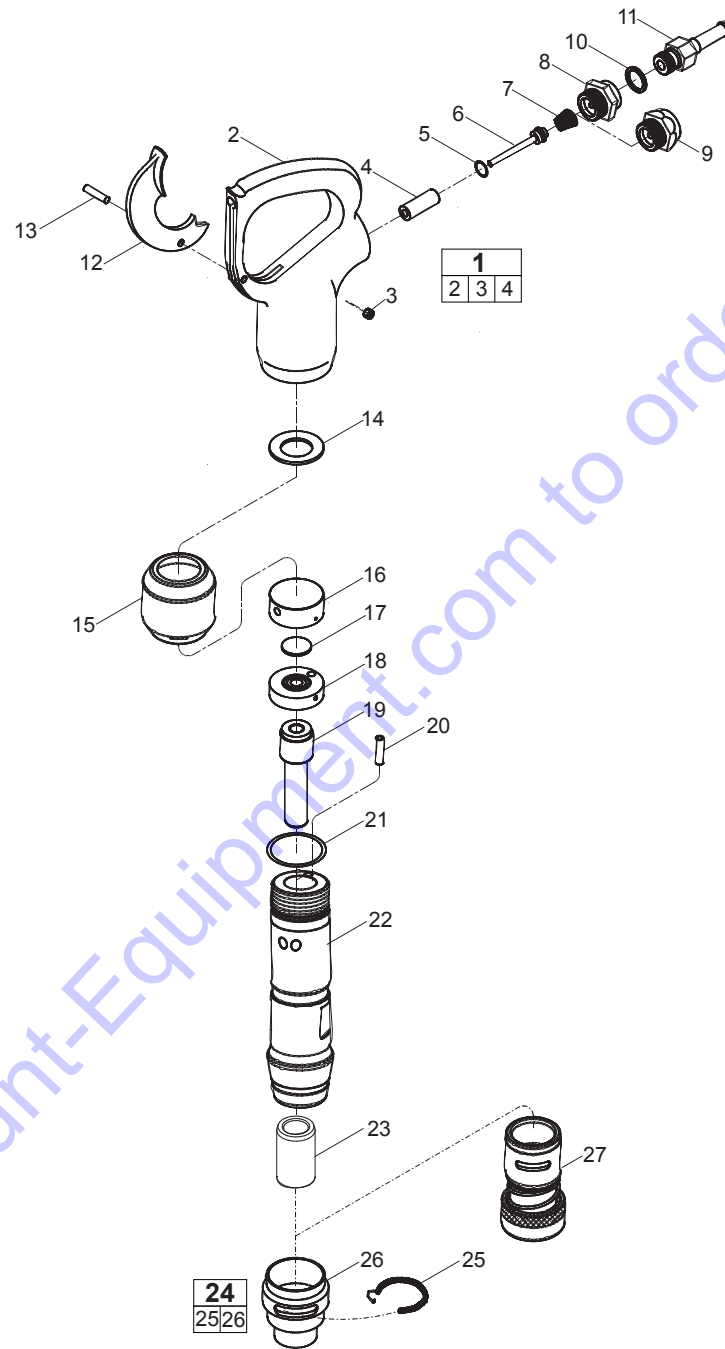

Go to Discount-Equipment.com to order your parts



No.	Description	Remark	Quantity	Part number
1(2-4)	Handle, complete		1	Z8360858
2	Handle		1	-
3	Plug	1/16 x 27 NPTF	1	C102507
4	Bushing - Throttle valve		1	-
5	O-ring - Throttle valve		1	Q0132858
6	Throttle valve		1	D3182858
7	Spring - Throttle valve		1	R085596
8	Air inlet bushing	BSP	1	F064697
9	Air inlet bushing	NPTF (optional)	1	R085893
10	Gasket - Hose tail		1	F064696
11	Hose tail	3/8" BSP	1	F064695
12	Lever - Throttle		1	F027853
13	Pin - Throttle lever		1	A043627
14	Washer	1.0 mm	2	Q4204858
15	Muffler		1	H3740858
16	Valve housing		1	Z3803858
17	Main valve		1	D7368858
18	Lower valve lid		1	D5090858
19	Piston		1	D1579858
20	Pin - Dowel	Pipe	1	D7288858
21	O-ring	Cylinder	1	H0359858
22	Cylinder		1	-
23	Bushing - Round		1	P001550
24(25-26)	Sleeve - Retainer, complete		1	P107243
25	Spring - Lock coil		1	P070994
26	Sleeve - Retainer		1	-
27	Ball type retainer	US standard (optional)	1	P137735

Go to Discount-Equipment.com to order your parts



CP 0012 2H

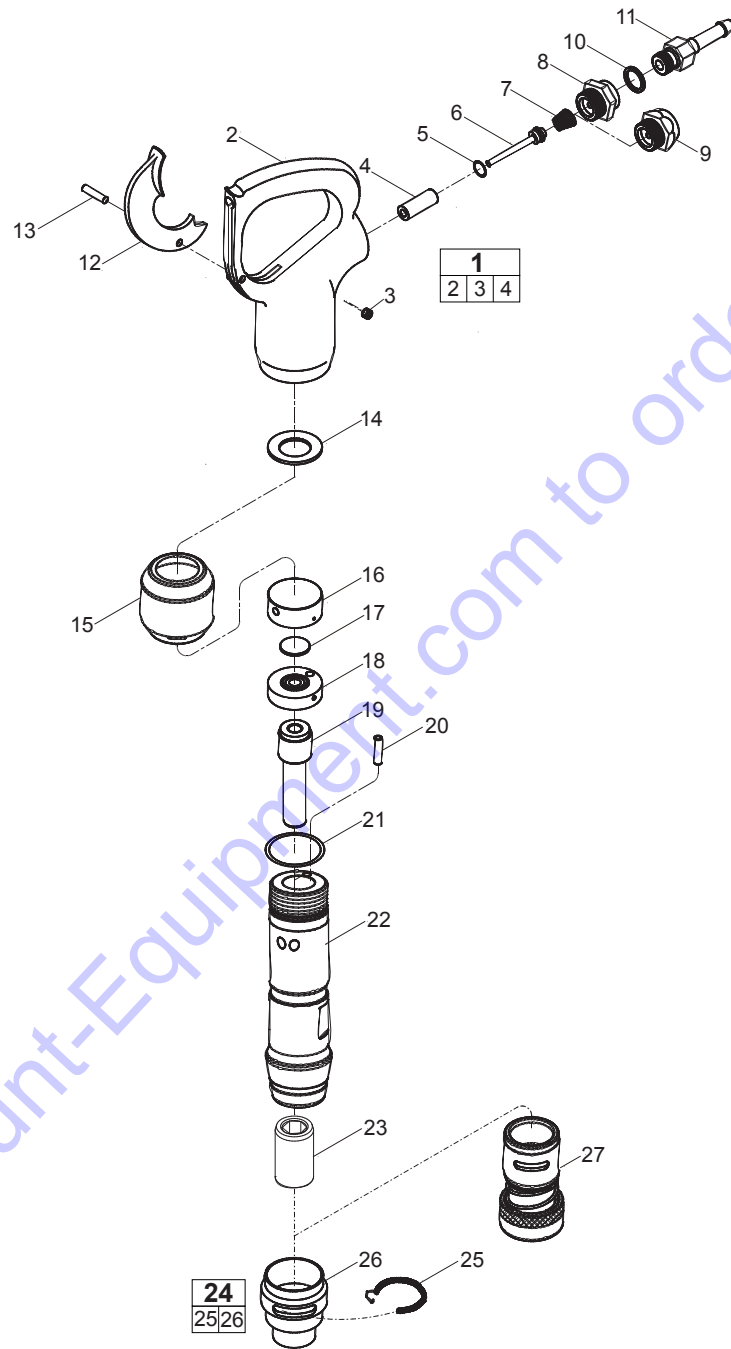

Go to Discount-Equipment.com to order your parts



No.	Description	Remark	Quantity	Part number
1(2-4)	Handle, complete		1	Z8360858
2	Handle		1	-
3	Plug	1/16 x 27 NPTF	1	C102507
4	Bushing - Throttle valve		1	-
5	O-ring - Throttle valve		1	Q0132858
6	Throttle valve		1	D3182858
7	Spring - Throttle valve		1	R085596
8	Air inlet bushing	BSP	1	F064697
9	Air inlet bushing	NPTF (optional)	1	R085893
10	Gasket - Hose tail		1	F064696
11	Hose tail	3/8" BSP	1	F064695
12	Lever - Throttle		1	F027853
13	Pin - Throttle lever		1	A043627
14	Washer	1.0 mm	2	Q4204858
15	Muffler		1	H3740858
16	Valve housing		1	Z3803858
17	Main valve		1	D7368858
18	Lower valve lid		1	D5090858
19	Piston		1	D1579858
20	Pin - Dowel	Pipe	1	D7288858
21	O-ring	Cylinder	1	H0359858
22	Cylinder		1	-
23	Bushing - Hexagon		1	P001551
24(25-26)	Sleeve - Retainer, complete		1	P107243
25	Spring - Lock coil		1	P070994
26	Sleeve - Retainer		1	-
27	Ball type retainer	US standard (optional)	1	P137735

Go to Discount-Equipment.com to order your parts



Working tools

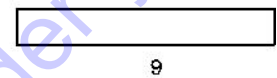
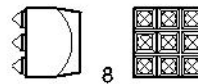
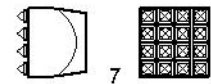
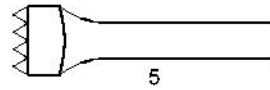
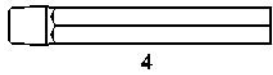
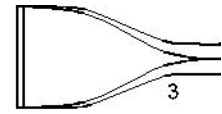
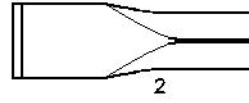
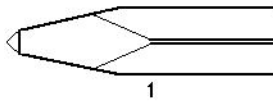

Hexagon 19 x 50 mm (3/4" x 2")

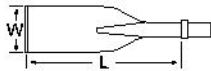

No.	Description	W (mm)	L (mm)	L _T (mm)	Wt (kg)	Part number
1	Moil point	-	240	300	0.8	3083 3220 00
		-	440	500	1.3	3083 3221 00
2	Narrow chisel	-	240	300	0.8	3083 3222 00
		-	440	500	1.3	3083 3223 00
3	Wide chisel	60	190	250	0.7	3083 3224 00
4	Shaft for bush hammer	-	80	140	0.4	3083 3225 00
6	Bush hammer, TC head	40	-	-	0.5	3083 3226 00
7	Bush hammer, TC head	40	-	-	0.5	3083 3227 00
8	Bush hammer, steel head	32	-	-	0.2	3083 4163 00

Hexagon, oval collar 14.7 mm (0.580")

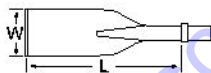

No.	Description	W (mm)	L (mm)	L _T (mm)	Wt (kg)	Part number
1	Moil point	-	160	230	0.6	3083 4120 00
		-	235	305	0.8	3083 4120 10
		-	380	450	1.1	3083 4120 20
2	Narrow chisel	-	160	230	0.6	3083 4121 00
		-	235	305	0.8	3083 4121 10
		-	380	450	1.1	3083 4121 20
3	Wide chisel	38	160	230	0.7	3083 4122 00
		38	235	305	0.9	3083 4122 10
		38	380	450	1.2	3083 4122 20
		65	160	230	0.8	3083 4122 60
		65	235	305	1.0	3083 4122 70



No.	Description	W (mm)	L (mm)	L _T (mm)	Wt (kg)	Part number
		65	380	450	1.4	3083 4122 80
		75	160	230	0.7	3083 4122 90
5	Bushing tool	50	170	240	1.2	3083 4124 00
9	Chisel blank	∅20	130	200	0.5	3083 4125 00
		∅20	235	305	0.7	3083 4125 10

Hexagon, round collar 14.7 mm (0.580")

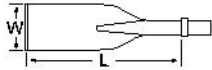

No.	Description	W (mm)	L (mm)	L _T (mm)	Wt (kg)	Part number
1	Moil point	-	160	230	0.6	3083 4130 00
		-	235	305	0.8	3083 4130 10
		-	380	450	1.1	3083 4130 20
2	Narrow chisel	-	160	230	0.6	3083 4131 00
		-	235	305	0.8	3083 4131 10
		-	380	450	1.1	3083 4131 20
5	Bushing tool	50	170	240	1.2	3083 4134 00

Round, oval collar 17.3 mm (0.680")

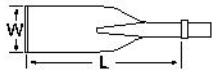

No.	Description	W (mm)	L (mm)	L _T (mm)	Wt (kg)	Part number
1	Moil point	-	160	230	0.6	3083 4100 00
		-	235	305	0.8	3083 4100 10
		-	380	450	1.1	3083 4100 20
2	Narrow chisel	-	160	230	0.6	3083 4101 00
		-	235	305	0.8	3083 4101 10
		-	380	450	1.1	3083 4101 20
3	Wide chisel	38	160	230	0.7	3083 4102 00
		38	235	305	0.9	3083 4102 10
		38	380	450	1.2	3083 4102 20
		65	160	230	0.8	3083 4102 60
		65	235	305	1.0	3083 4102 70
		65	380	450	1.4	3083 4102 80
		75	160	230	0.7	3083 4102 90
5	Bushing tool	50	170	240	1.2	3083 4104 00
9	Chisel blank	∅20	130	200	0.5	3083 4105 00
		∅20	235	305	0.7	3083 4105 10



Round, round collar 17.3 mm (0.680")

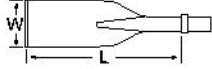

No.	Description	W (mm)	L (mm)	L _T (mm)	Wt (kg)	Part number
1	Moil point	-	160	230	0.6	3083 4110 00
		-	235	305	0.8	3083 4110 10
		-	380	450	1.1	3083 4110 20
2	Narrow chisel	-	160	230	0.6	3083 4111 00
		-	235	305	0.8	3083 4111 10
		-	380	450	1.1	3083 4111 20
5	Bushing tool	50	170	240	1.2	3083 4114 00

Hexagon 3/4" x 2" (19 x 50 mm)

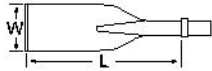

No.	Description	W (in.)	L (in.)	L _T (in.)	Wt (lb)	Part number
1	Moil point	-	9½	12	1¼	3083 3220 00
		-	17	20	2⅞	3083 3221 00
2	Narrow chisel	-	9½	12	1¼	3083 3222 00
		-	17	20	2⅞	3083 3223 00
3	Wide chisel	2⅞	7½	10	1½	3083 3224 00
4	Shaft for bush hammer	-	3⅞	5½	⅞	3083 3225 00
6	Bush hammer, TC head	1½	-	-	1⅞	3083 3226 00
7	Bush hammer, TC head	1½	-	-	1⅞	3083 3227 00
8	Bush hammer, steel head	1¼	-	-	½	3083 4163 00

Hexagon, oval collar 0.580" (14.7 mm)

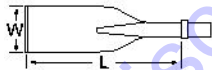

No.	Description	W (in.)	L (in.)	L _T (in.)	Wt (lb)	Part number
1	Moil point	-	6¼	9	1⅓	3083 4120 00
		-	9¼	12	1¾	3083 4120 10
		-	15	18	2⅞	3083 4120 20
2	Narrow chisel	-	6¼	9	1⅓	3083 4121 00
		-	9¼	12	1¾	3083 4121 10
		-	15	18	2⅞	3083 4121 20
3	Wide chisel	1½	6¼	9	1½	3083 4122 00
		1½	9¼	12	2	3083 4122 10
		-	15	18	2⅞	3083 4122 20



No.	Description	W (in.)	L (in.)	L _T (in.)	Wt (lb)	Part number
		1½	6¼	12	1¾	3083 4122 60
		2½	9¼	18	2½	3083 4122 70
		2½	15	9	3½	3083 4122 80
		2½	6¼		1½	3083 4122 90
		3				
5	Bushing tool	2	6¾	9½	2⅝	3083 4124 00
9	Chisel blank	∅¾	5	8	1⅞	3083 4125 00
		∅¾	9¼	12	1½	3083 4125 10

Hexagon, round collar 0.580" (14.7 mm)

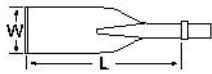

No.	Description	W (in.)	L (in.)	L _T (in.)	Wt (lb)	Part number
1	Moil point	-	6¼	9	1⅓	3083 4130 00
		-	9¼	12	1¾	3083 4130 10
		-	15	18	2⅝	3083 4130 20
2	Narrow chisel	-	6¼	9	1⅓	3083 4131 00
		-	9¼	12	1¾	3083 4131 10
		-	15	18	2⅝	3083 4131 20
5	Bushing tool	2	6¾	9½	2⅝	3083 4134 00

Round, oval collar 0.680" (17.3 mm)

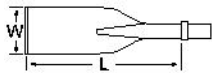

No.	Description	W (in.)	L (in.)	L _T (in.)	Wt (lb)	Part number
1	Moil point	-	6¼	9	1⅓	3083 4100 00
		-	9¼	12	1¾	3083 4100 10
		-	15	18	2⅝	3083 4100 20
2	Narrow chisel	-	6¼	9	1⅓	3083 4101 00
		-	9¼	12	1¾	3083 4101 10
		-	15	18	2⅝	3083 4101 20
3	Wide chisel	1½	6¼	9	1½	3083 4102 00
		1½	9¼	12	2	3083 4102 10
		1½	15	18	2⅝	3083 4102 20
		2½	6¼	9	1¾	3083 4102 60
		2½	9¼	12	2⅝	3083 4102 70
		2½	15	18	3⅞	3083 4102 80
		3	6¼	9	1½	3083 4102 90
5	Bushing tool	2	6¾	9½	2⅝	3083 4104 00
9	Chisel blank	∅¾	5	8	1⅞	3083 4105 00
		∅¾	9¼	12	1½	3083 4105 10



Round, round collar 0.680" (17.3 mm)

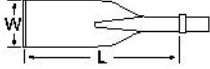

No.	Description	W (in.)	L (in.)	L _T (in.)	Wt (lb)	Part number
1	Moil point	-	6¼	9	1⅓	3083 4110 00
		-	9¼	12	1¾	3083 4110 10
		-	15	18	2⅝	3083 4110 20
2	Narrow chisel	-	6¼	9	1⅓	3083 4111 00
		-	9¼	12	1¾	3083 4111 10
		-	15	18	2⅝	3083 4111 20
5	Bushing tool	2	6¾	9½	2⅝	3083 4114 00

Go to Discount-Equipment.com to order your parts



www.discount-equipment.com

2009-06

No.9800 0516 93a

© Copyright Chicago Pneumatic Construction Tools
STOCKHÖLM • SWEDEN

Chicago Pneumatic Construction Tools

Go to Discount-Equipment.com to order your parts

PARTS FINDER

**Search Website
by Part Number**



**Search Manual
Library For Parts
Manual & Lookup Part
Numbers – Purchase
or Request Quote**

Search Manuals

Enter your information to help us find the right parts manual for your machine.

* Brand:

* Model:

* Serial:

* Part Number:

SEARCH

**Can't Find Part or
Manual? Request Help
by Manufacturer,
Model & Description**

Parts Order Form

Please fill in the following information to help us find the right part for your machine.

Manufacturer:	<input type="text"/>
Model:	<input type="text"/>
Description:	<input type="text"/>
Part Number:	<input type="text"/>
Quantity:	<input type="text"/>
Notes:	<input type="text"/>

Submit

Discount-Equipment.com is your online resource for quality parts & equipment.

Florida: **561-964-4949** Outside Florida TOLL FREE: **877-690-3101**

Need parts?

Click on this link: <http://www.discount-equipment.com/category/5443-parts/> and choose one of the options to help get the right parts and equipment you are looking for. Please have the machine model and serial number available in order to help us get you the correct parts. If you don't find the part on the website or on one of the online manuals, please fill out the request form and one of our experienced staff members will get back to you with a quote for the right part that your machine needs.

We sell worldwide for the brands: Genie, Terex, JLG, MultiQuip, Mikasa, Essick, Whiteman, Mayco, Toro Stone, Diamond Products, Generac Magnum, Airman, Haulotte, Barreto, Power Blanket, Nifty Lift, Atlas Copco, Chicago Pneumatic, Allmand, Miller Curber, Skyjack, Lull, Skytrak, Tsurumi, Husquvarna Target, Stow, Wacker, Sakai, Mi-T-M, Sullair, Basic, Dynapac, MBW, Weber, Bartell, Bennar Newman, Haulotte, Ditch Runner, Menegotti, Morrison, Contec, Buddy, Crown, Edco, Wyco, Bomag, Laymor, EZ Trench, Bil-Jax, F.S. Curtis, Gehl Pavers, Heli, Honda, ICS/PowerGrit, IHI, Partner, Imer, Clipper, MMD, Koshin, Rice, CH&E, General Equipment, Amida, Coleman, NAC, Gradall, Square Shooter, Kent, Stanley, Tamco, Toku, Hatz, Kohler, Robin, Wisconsin, Northrock, Oztec, Toker TK, Rol-Air, APT, Wylie, Ingersoll Rand / Doosan, Innovatech, Con X, Ammann, Mecalac, Makinex, Smith Surface Prep, Small Line, Wanco, Yanmar