

# OPERATION MANUAL



**SmartStick**<sup>™</sup>

**MODEL DLW400ESA4  
WELDER/GENERATOR**

**(KUBOTA D902E4BWDDE2 DIESEL ENGINE)**

Revision #0 (03/14/18)



THIS MANUAL MUST ACCOMPANY THE EQUIPMENT AT ALL TIMES.

**TO PURCHASE THIS PRODUCT PLEASE CONTACT US**



**Equipment Financing and  
Extended Warranties Available**



**Discount-Equipment.com is your online resource for  
commercial and industrial quality parts and equipment sales.**

**561-964-4949**

**visit us on line @ [www.discount-equipment.com](http://www.discount-equipment.com)**

Select an option below to find your Equipment

**Search by Manufacturer**



**Search by Product Type**

**Request a Quote**

We sell worldwide for the brands: Genie, Terex, JLG, MultiQuip, Mikasa, Essick, Whiteman, Mayco, Toro Stone, Diamond Products, Generac Magnum, Airman, Haulotte, Barreto, Power Blanket, Nifty Lift, Atlas Copco, Chicago Pneumatic, Allmand, Miller Curber, Skyjack, Lull, Skytrak, Tsurumi, Husquvarna Target, Stow, Wacker, Sakai, Mi-T-M, Sullair, Basic, Dynapac, MBW, Weber, Bartell, Bennar Newman, Haulotte, Ditch Runner, Menegotti, Morrison, Contec, Buddy, Crown, Edco, Wyco, Bomag, Laymor, EZ Trench, Bil-Jax, F.S. Curtis, Gehl Pavers, Heli, Honda, ICS/PowerGrit, IHI, Partner, Imer, Clipper, MMD, Koshin, Rice, CH&E, General Equipment, Amida, Coleman, NAC, Gradall, Square Shooter, Kent, Stanley, Tamco, Toku, Hatz, Kohler, Robin, Wisconsin, Northrock, Oztec, Toker TK, Rol-Air, APT, Wylie, Ingersoll Rand / Doosan, Innovatech, Con X, Ammann, Mecalac, Makinex, Smith Surface Prep, Small Line, Wanco, Yanmar

## PROPOSITION 65 WARNING

---

 <b>WARNING</b> 
<b>CALIFORNIA — Proposition 65 Warning</b>
Diesel engine exhaust and some of its constituents are known to the State of California to cause cancer, birth defects and other reproductive harm.

# TABLE OF CONTENTS

## **DLW400ESA4 Welder-Generator**

Proposition 65 Warning .....	2
Reporting Safety Defects.....	3
Table Of Contents.....	4
Parts Ordering Procedures.....	5
Safety Information .....	6-13
Specifications .....	14
Specifications (Fuel Consumption).....	15
Dimensions.....	16
Installation .....	18-19
General Information.....	20
Welding Polarity And Duty Cycle .....	21
Welding Terms.....	22
Components (Welder/Generator) .....	23-24
Components (Engine).....	25
Power Receptacles.....	26
Control Panel.....	27-28
Inspection .....	29-30
Inspection/Setup.....	31
Setup .....	32-33
Operation.....	34-41
Maintenance .....	42-51
Generator Wiring Diagram.....	52
Generator Wiring Diagram (Reference Designators) ..	53
Engine Wiring Diagram.....	54
Error Codes .....	55
Troubleshooting .....	56-58

### **NOTICE**

Specifications are subject to change without notice.

# SAFETY INFORMATION

**DO NOT** operate or service the equipment before reading the entire manual. Safety precautions should be followed at all times when operating this equipment. Failure to read and understand the safety messages and operating instructions could result in injury to yourself and others.



## SAFETY MESSAGES

The four safety messages shown below will inform you about potential hazards that could injure you or others. The safety messages specifically address the level of exposure to the operator and are preceded by one of four words: **DANGER**, **WARNING**, **CAUTION** or **NOTICE**.

## SAFETY SYMBOLS

<b>DANGER</b>
Indicates a hazardous situation which, if not avoided, <b>WILL</b> result in <b>DEATH</b> or <b>SERIOUS INJURY</b> .
<b>WARNING</b>
Indicates a hazardous situation which, if not avoided, <b>COULD</b> result in <b>DEATH</b> or <b>SERIOUS INJURY</b> .
<b>CAUTION</b>
Indicates a hazardous situation which, if not avoided, <b>COULD</b> result in <b>MINOR</b> or <b>MODERATE INJURY</b> .
<b>NOTICE</b>
Addresses practices not related to personal injury.

Potential hazards associated with the operation of this equipment will be referenced with hazard symbols which may appear throughout this manual in conjunction with safety messages.

Symbol	Safety Hazard
	Lethal Exhaust Gas Hazards
	Explosive Fuel Hazards
	Burn Hazards
	Welding Hazards
	EMF Hazards
	Pacemaker Hazards
	Implant Hazards
	Flying Sparks Hazards
	Fire Hazards
	Electric Shock Hazards

# SAFETY INFORMATION

## GENERAL SAFETY

### CAUTION

- **NEVER** operate this equipment without proper protective clothing, shatterproof glasses, respiratory protection, hearing protection, steel-toed boots and other protective devices required by the job or city and state regulations.



- **NEVER** operate this equipment when not feeling well due to fatigue, illness or when under medication.



- **NEVER** operate this equipment under the influence of drugs or alcohol.



### NOTICE

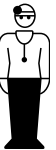

- This equipment should only be operated by trained and qualified personnel 18 years of age and older.
- Whenever necessary, replace nameplate, operation and safety decals when they become difficult read.
- Manufacturer does not assume responsibility for any accident due to equipment modifications. Unauthorized equipment modification will void all warranties.
- **NEVER** use accessories or attachments that are not recommended by Multiquip for this equipment. Damage to the equipment and/or injury to user may result.
- **ALWAYS** know the location of the nearest fire extinguisher.
- **ALWAYS** know the location of the nearest first aid kit.
- **ALWAYS** know the location of the nearest phone or **keep a phone on the job site**. Also, know the phone numbers of the nearest **ambulance, doctor and fire department**. This information will be invaluable in the case of an emergency.



# SAFETY INFORMATION

## WELDER SAFETY

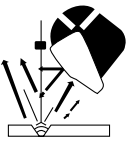
### DANGER

- **NEVER** install or operate the welder-generator in an explosive atmosphere or near combustible materials. An explosion or fire could result causing severe **bodily harm or even death**. 
- Flying sparks can cause injury. Wear a face shield to protect eyes and face. 
- Remove all flammables within 35 ft (10.7 m) of welding arc. If this is not possible, tightly cover them with approved covers.
- Do not weld where flying sparks can strike flammable material.
- Hot metal from air arc cutting and gouging can cause fire or explosion. **DO NOT** cut or gouge near flammables. 
- Welding on closed containers, like tanks, drums or pipes, can cause them to blow up. **DO NOT** weld on closed containers unless they are properly prepared according to AWS F4.1 (see *Recommended Safe Practices for the Preparation for Welding and Cutting of Containers and Piping* from American Welding Society Standards). Check and be sure area is safe before doing any welding.
- Protect yourself and others from flying sparks and hot metal. Wear oil-free protective garments like leather gloves, heavy shirt, cuffless trousers, high shoes and a cap.
- Be alert that welding sparks and hot materials from welding can go through small cracks and openings to adjacent areas.
- Be aware that welding on a ceiling, floor, bulkhead or partition can cause fire on hidden side.
- Connect welding cable to the work as close to welding area as practical to prevent welding current from traveling long, possibly unknown paths and causing electric shock, sparks and fire hazards.
- **DO NOT** use welder-generator to thaw frozen pipes.
- Remove stick electrode from holder or cut off welding wire at contact tip when not in use.



- **DO NOT** touch output terminals during operation. Contact with output terminals during operation can cause **electrocution, electrical shock or burn**.
- Remove any combustibles, such as a butane lighter or matches, from your person before doing any welding.
- After completion of work, inspect area to ensure it is free of sparks, glowing embers and flames.
- Follow requirements in OSHA 1910.252 (a) (2) (iv) and NFPA 51B for hot work and have a fire watcher and extinguisher nearby.

### WARNING

- Keep your head out of the fumes. Use enough ventilation or exhaust at the arc, or both, to keep the fumes and gases from your breathing zone and the general area. In a large room or outdoors, natural ventilation may be adequate if you keep your head out of the fumes.
- **DO NOT** get too close to the arc. Use corrective lenses if necessary to stay a reasonable distance away from the arc.
- Use natural drafts or fans to keep the fumes away from your face.
- Welding wire can cause injury. Do not press gun trigger until instructed to do so. Do not point gun toward any part of the body, other people or any metal when threading welding wire. 
- Have only qualified people remove doors, panels, covers or guards for maintenance and troubleshooting if necessary.
- Reinstall doors, panels, covers or guards when servicing is finished and before starting engine.
- **NEVER** disconnect any **emergency or safety devices**. These devices are intended for operator safety. Disconnection of these devices can cause severe injury, bodily harm or even death. Disconnection of any of these devices will void all warranties.

## SAFETY INFORMATION

### CAUTION

- Electric current flowing through any conductor causes localized Electro Magnetic Fields (EMF). Welding current creates EMF fields around welding cables and welding machines. 
- Wearers of **pacemakers** and other implanted medical devices should keep away from welding equipment when in use. 
- Implanted medical device wearers should consult their doctor and the device manufacturer before going near arc welding, spot welding, gouging, plasma arc cutting or induction heating operations. 
- Exposure to EMF fields in welding may have other health effects which are now not known.
- All welders should use the following procedures in order to minimize exposure to EMF fields from the welding circuit:
  - Route the electrode and work cables together. Secure them with tape when possible.
  - **NEVER** coil the electrode lead around your body.
  - **DO NOT** place your body between the electrode and work cables. If the electrode cable is on your right side, the work cable should also be on your right side.
  - Connect the work cable to the workpiece as close as possible to the area being welded.
  - **DO NOT** work next to the welder-generator.

### NOTICE

- Electromagnetic energy can interfere with sensitive electronic equipment such as microprocessors, computers and computer-driven equipment such as robots. Be sure all equipment in the welding area is electromagnetically compatible. 
- To reduce possible interference, keep weld cables as short as possible, close together and down low, such as on the floor. Locate welding operation 100 meters from any sensitive electronic equipment. Be sure welder-generator is installed and grounded according to this manual.
- If interference still occurs, the operator must take extra measures, like moving the welder-generator, using shielded cables, using line filters or shielding the work area.
- **NEVER** lubricate components or attempt service on a running machine.
- Overheating can damage equipment. Turn off or unplug equipment before starting or stopping engine. Low voltage and frequency caused by low engine speed can damage electric devices. Ensure engine speed is correct during operation.
- Overloading shortens the life of the welder-generator. Use the machine with appropriate AC and DC current and appropriate duty cycle.
- **ALWAYS** ensure welder-generator is on level ground before use.
- **ALWAYS** keep the welder-generator in proper running condition.
- Fix damage to welder-generator and replace any broken parts immediately.
- **ALWAYS** store welder-generator properly when it is not being used. Equipment should be stored in a clean, dry location out of the reach of children and unauthorized personnel.



# SAFETY INFORMATION

## ENGINE SAFETY

### DANGER

- The engine fuel exhaust gases contain poisonous carbon monoxide. This gas is colorless and odorless, and can cause death if inhaled.
- The engine of this equipment requires an adequate free flow of cooling air. **NEVER** operate this equipment in any enclosed or narrow area where free flow of the air is restricted. If the air flow is restricted it will cause injury to people and property and serious damage to the equipment or engine.

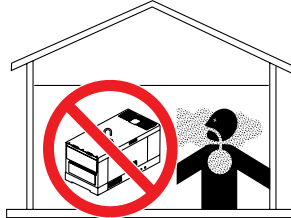

### WARNING

- **DO NOT** place hands or fingers inside engine compartment when engine is running.
- **NEVER** operate the engine with heat shields or guards removed.
- Keep fingers, hands, hair and clothing away from all moving parts to prevent injury.
- **DO NOT** remove the radiator cap or coolant drain plug while the engine is hot. High pressure boiling water or coolant will gush out and severely scald any persons in the general area of the welder-generator.
- **DO NOT** remove the engine oil drain plug while the engine is hot. Hot oil will gush out of the engine crankcase and severely scald any persons in the general area of the welder-generator.



### CAUTION

- **NEVER** touch the hot exhaust manifold, muffler or cylinder. Allow these parts to cool before servicing equipment.



### NOTICE

- **NEVER** run engine without an air filter or with a dirty air filter. Severe engine damage may occur. Service air filter frequently to prevent engine malfunction.
- **NEVER** tamper with the factory settings of the engine or engine governor. Damage to the engine or equipment can result if operating in speed ranges above the maximum allowable.
- State Health Safety Codes and Public Resources Codes specify that in certain locations, spark arresters must be used on internal combustion engines that use hydrocarbon fuels. A spark arrester is a device designed to prevent accidental discharge of sparks or flames from the engine exhaust. Spark arresters are qualified and rated by the United States Forest Service for this purpose. In order to comply with local laws regarding spark arresters, consult the engine distributor or the local Health and Safety Administrator.
- Wet stacking is a common problem with diesel engines which are operated for extended periods with light or no load applied. When a diesel engine operates without sufficient load (less than 40% of the rated output), it will not operate at its optimum temperature. This will allow unburned fuel to accumulate in the exhaust system, which can foul the fuel injectors, engine valves and exhaust system, including turbochargers, and reduce the operating performance.



In order for a diesel engine to operate at peak efficiency, it must be able to provide fuel and air in the proper ratio and at a high enough engine temperature for the engine to completely burn all of the fuel.

Wet stacking does not usually cause any permanent damage and can be alleviated if additional load is applied to relieve the condition. It can reduce the system performance and increase maintenance. Applying an increasing load over a period of time until the excess fuel is burned off and the system capacity is reached usually can repair the condition. This can take several hours to burn off the accumulated unburned fuel.

# SAFETY INFORMATION

## FUEL SAFETY

### DANGER

- **DO NOT** add fuel to equipment if it is placed inside truck bed with plastic liner. Possibility exists of explosion or fire due to static electricity.

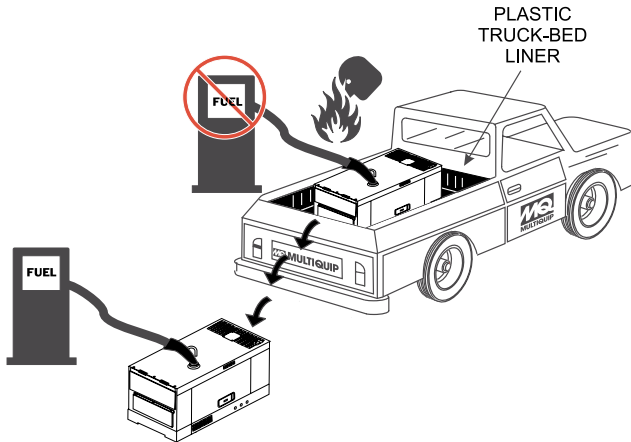

- **DO NOT** start the engine near spilled fuel or combustible fluids. Gasoline fuel is extremely flammable and its vapors can cause an explosion if ignited.
- **ALWAYS** refuel in a well-ventilated area, away from sparks and open flames.
- **ALWAYS** use extreme caution when working with flammable liquids.
- **DO NOT** fill the fuel tank while the engine is running or hot.
- **DO NOT** overfill tank, since spilled fuel could ignite if it comes into contact with hot engine parts or sparks from the ignition system.
- Store fuel in appropriate containers, in well-ventilated areas and away from sparks and flames.
- **NEVER** use fuel as a cleaning agent.
- **DO NOT** smoke around or near the equipment. Fire or explosion could result from fuel vapors or if fuel is spilled on a hot engine



## ELECTRICAL SAFETY

### DANGER

- Turn welder-generator and all circuit breakers **OFF** before performing maintenance on the generator or making contact with output receptacles.
- **NEVER** insert any objects into the output receptacles during operation. This is extremely dangerous. The possibility exists of **electrical shock, electrocution or death.**
- Backfeed to a utility system can cause **electrocution** and/or property damage. **NEVER** connect the welder-generator to a building's electrical system without a transfer switch or other approved device. All installations should be performed by a **licensed electrician** in accordance with all applicable laws and electrical codes. Failure to do so could result in electrical shock or burn, causing **serious injury or even death.**



## Power Cord/Cable Safety

### DANGER

- **NEVER** let power cords or cables **lay in water.**
- **NEVER stand in water** while AC or DC power from the generator is being transferred to a load.
- **NEVER** use **damaged** or **worn** cables or cords when connecting equipment to generator. Inspect for cuts in the insulation.
- **NEVER** grab or touch a live power cord or cable with wet hands. The possibility exists of **electrical shock, electrocution or death.**
- Make sure power cables are securely connected to the generator's output receptacles. Incorrect connections may cause electrical shock and damage to the generator.



## NOTICE

- **ALWAYS** make certain that proper power or extension cord has been selected for the job. See Cable Selection Chart in this manual.

# SAFETY INFORMATION

## Grounding Safety

### DANGER

- These welder-generators are equipped with a grounding terminal at the base of the pipe frame. Electrical grounding requirements can differ by State, Province, District, Municipality, and unique application settings.
- For portable and vehicle-mounted welder-generators, Multiquip recognizes the guidance provided in NEC Handbook Article 250.34 Parts A and B, and 29 CFR 1926.404 (f) (3) (i). If a more definitive earth-to-ground safeguard is required, please consult a qualified electrician and reference appropriate National Electrical Code (NEC) guidelines in establishing an exterior grounding point
- **NEVER** use gas piping as an electrical ground.

## BATTERY SAFETY

### DANGER

- **DO NOT** drop the battery. There is a possibility that the battery will explode.
- **DO NOT** expose the battery to open flames, sparks, cigarettes, etc. The battery contains combustible gases and liquids. If these gases and liquids come into contact with a flame or spark, an explosion could occur.
- **DO NOT** charge battery if frozen. Battery can explode. When frozen, warm the battery to at least 61°F (16°C)



### WARNING

- **ALWAYS** wear safety glasses when handling the battery to avoid eye irritation. The battery contains acids that can cause injury to the eyes and skin.
- Use well-insulated gloves when picking up the battery.
- **ALWAYS** keep the battery charged. If the battery is not charged, combustible gas will build up.
- **ALWAYS** recharge the battery in a well-ventilated environment to avoid the risk of a dangerous concentration of combustible gasses.



- If the battery liquid (dilute sulfuric acid) comes into contact with **clothing or skin**, rinse skin or clothing immediately with plenty of water.
- If the battery liquid (dilute sulfuric acid) comes into contact with **eyes**, rinse eyes immediately with plenty of water and contact the nearest doctor or hospital to seek medical attention.

### CAUTION

- **ALWAYS** disconnect the **NEGATIVE battery terminal** before performing service on the generator.
- **ALWAYS** keep battery cables in good working condition. Repair or replace all worn cables.

## TRANSPORTING SAFETY

### CAUTION

- **NEVER** allow any person or animal to stand underneath the equipment while lifting.

### NOTICE

- Before lifting, make sure that the equipment parts (lifting bail) is not damaged and screws are not loose or missing.
- **ALWAYS** make sure crane or lifting device has been properly secured to the lifting bail (hook) of the equipment.
- **ALWAYS** shutdown engine before transporting.
- **NEVER** lift the equipment while the engine is running.
- Tighten fuel tank cap securely and close fuel cock to prevent fuel from spilling.
- Use adequate lifting cable (wire or rope) of sufficient strength.

## SAFETY INFORMATION

- Use one point suspension hook and lift straight upwards.

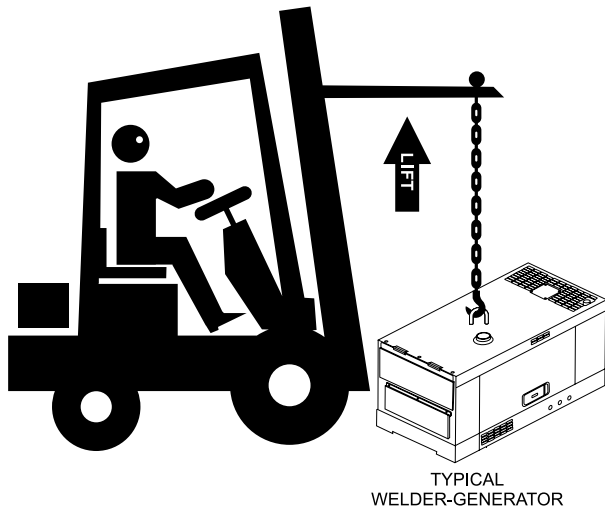

- **DO NOT** lift machine to unnecessary heights.
- **ALWAYS** tie down equipment during transport by securing the equipment with rope.

### ENVIRONMENTAL SAFETY/DECOMMISSIONING

#### NOTICE

Decommissioning is a controlled process used to safely retire a piece of equipment that is no longer serviceable. If the equipment poses an unacceptable and unreparable safety risk due to wear or damage or is no longer cost effective to maintain (beyond life-cycle reliability) and is to be decommissioned (demolition and dismantlement), be sure to follow rules below.

- **DO NOT** pour waste or oil directly onto the ground, down a drain or into any water source.
- Contact your country's Department of Public Works or recycling agency in your area and arrange for proper disposal of any electrical components, waste or oil associated with this equipment.
- When the life cycle of this equipment is over, remove battery (if equipped) and bring to appropriate facility for lead reclamation. Use safety precautions when handling batteries that contain sulfuric acid.



- When the life cycle of this equipment is over, it is recommended that the unit frame and all other metal parts be sent to a recycling center.

Metal recycling involves the collection of metal from discarded products and its transformation into raw materials to use in manufacturing a new product.

Recyclers and manufacturers alike promote the process of recycling metal. Using a metal recycling center promotes energy cost savings.

### EMISSIONS INFORMATION

#### NOTICE

The gasoline engine used in this equipment has been designed to reduce harmful levels of carbon monoxide (CO), hydrocarbons (HC) and nitrogen oxides (NOx) contained in gasoline exhaust emissions.

This engine has been certified to meet US EPA Evaporative emissions requirements in the installed configuration.

Attempting to modify or make adjustments to the engine emission system by unauthorized personnel without proper training could damage the equipment or create an unsafe condition.

Additionally, modifying the fuel system may adversely affect evaporative emissions, resulting in fines or other penalties.

#### Emission Control Label

The emission control label is an integral part of the emission system and is strictly controlled by regulation(s).

The label must remain with the engine for its entire life.

If a replacement emission label is needed, please contact Discount-equipment.

# SPECIFICATIONS

**Table 1. Welding Generator Specifications**

	CC Mode				CV Mode			
	High Speed		Variable Speed		High Speed		Low Speed	
	Single	Dual	Single	Dual	Single	Dual	Single	Dual
Rated Output	11.9 kW	4.73 kW	11.9 kW	4.73 kW	11.0 kW	3.99 kW	11.0 kW	3.99 kW
Rated Current	350 A	175 A	350 A	175 A	350 A	175 A	350 A	175 A
Rated Voltage	34.0 V	27.0 V	34.0 V	27.0 V	31.5 V	22.8 V	31.5 V	22.8 V
Duty Cycle	100%		100%		100%		100%	
Rated Speed	3600 rpm		2300 ~ 3600 rpm		3600 rpm		2300 ~ 3600 rpm	
Current Range	30~400 A	30~200 A	30~400 A	30~200 A	—	—	—	—
Voltage Range	—	—	—	—	14~35 V	14~28 V	14~35 V	14~28 V

**Table 2. AC Generator Specifications**

No. of Phases	1
Wires	3-Wires (Neutral Grounded)
Max. Output	14 kW (14 kVA)
Rated Output	12 kW (12kVA)
Rated Voltage	120/240 VAC
Amperage	116/58
Frequency	60 Hz
Power Factor	1
Rating	Continuous
Receptacles (4)	GFCI, 30 Amp Twist Lock (2) 50 Amp Twist Lock

**Table 3. AC/DC Simultaneous Use**

Electrode Size (Dia. in.)	Welding Amps	AC Output (kW)	AC Output (Amps) 120/240V
—	—	14	116.6/58.3
3/32	80	10	83.3/41.6
1/8	130	8	66.6/33.3
5/32	170	6	50.0/25.0
3/16	220	4	33.3/16.6
7/32	270	2	16.6/8.3
1/4	340	0	—

**Table 4. Engine Specifications**

Model	KUBOTA D902-E4B
Type	Vertical, 4-Cycle Liquid Cooled Diesel Eng.
Rated Output	24.0 HP/3600 rpm
Displacement	54.8 cu. in. (.898 L)
Cooling System	Water-Cooled
Starting System	Electric Starting
Fuel Tank Capacity	11.1 gal. (42 L)
Fuel Type	No. 2 Diesel Fuel Low Sulfur/Ultra Low Sulfur Diesel fuel
Cooling Water Capacity	1.12 gal. 4.25 L)
Lube Oil Capacity	0.95 gal. (3.6 L)
Lubricating Type Oil	API Service Class See Table 24 and Table 25
Battery	12 V 45Ah x 1
Fuel	No. 2 Diesel Fuel
Dry Weight	893 lbs. (405 kg)

## NOTICE

This unit is a two function device, welder and AC generator. The single-phase AC power source (14 kW) can be used in conjunction with DC welding operations. Refer to Table 3 for simultaneous use of AC power and DC welding. **DO NOT** overload unit when AC and DC voltages are used simultaneous. Main circuit breaker will trip when overload condition exist.

# SPECIFICATIONS (FUEL CONSUMPTION)

<b>Table 5. Fuel Consumption</b>				
No Load	High (3600 rpm)		Low (2200 rpm)	
Fuel Consumption gal/hr. (liters/hr.)	0.518 (1.96)		0.272 (1.02)	
<b>High (3600 rpm)</b>				
Amperes <sup>1</sup>	87.5	175	262.5	350
Fuel Consumption gal/hr. (liters/hr.)	0.63 (2.38)	0.78 (2.95)	1.01 (3.82)	1.32 (5.00)
<b>Variable (2300-3600 rpm)</b>				
Amperes	87.5	175	262.5	350
Fuel Consumption gal/hr. (liters/hr.)	0.39 (1.47)	0.54 (2.04)	0.89 (3.36)	1.32 (5.00)
<sup>1</sup> DC welding current at 100%				

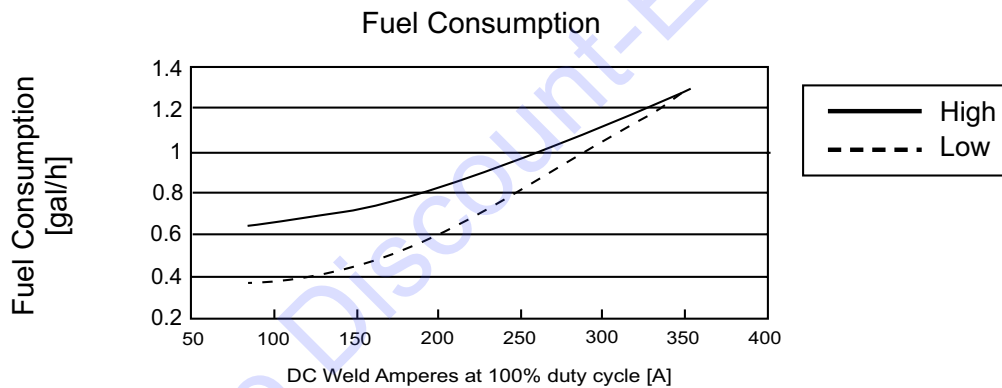

**Figure 1. Fuel Consumption Chart**

# DIMENSIONS

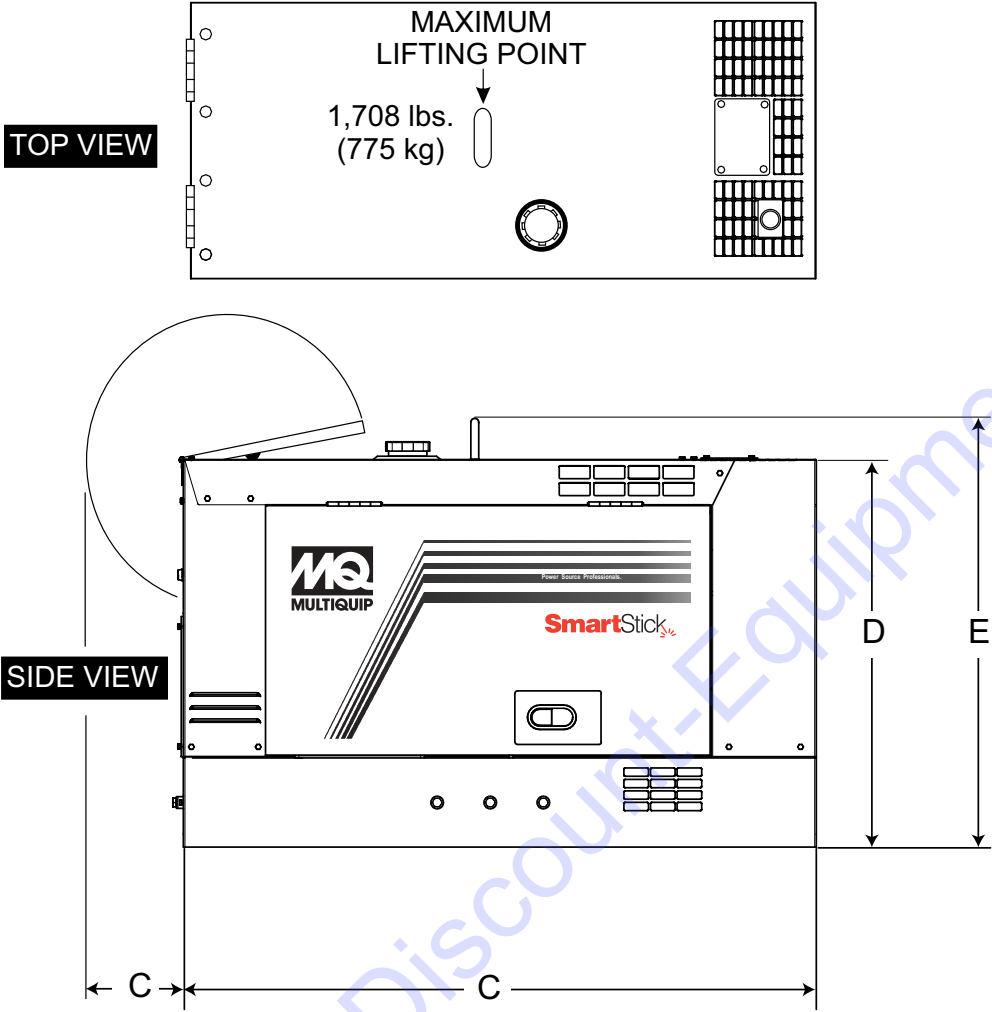

Figure 2. Dimensions

Table 6. Dimensions	
Reference Letter	Dimension in. (mm)
A	28.35 (720)
B	21.06 (535)
C	13.42 (341)
D	60.6 (1,539)
E	31.50 (800)
F	34.84 (885)

# INSTALLATION

## CONNECTING THE GROUND

Consult with local Electrical and Safety Codes for proper connection based on condition of use.

### EXAMPLE of how to ground the unit if the condition of use requires such a device:

The ground terminal on the generator should always be used to connect the generator to a suitable ground when required.

The ground cable should be #8 size wire (aluminum) minimum. If copper wire is used, #10 size wire minimum should be used.

Connect one end of the ground cable terminal to the welder-generator ground point (Figure 3). Connect the other end of the ground cable to a suitable earth ground (ground rod).

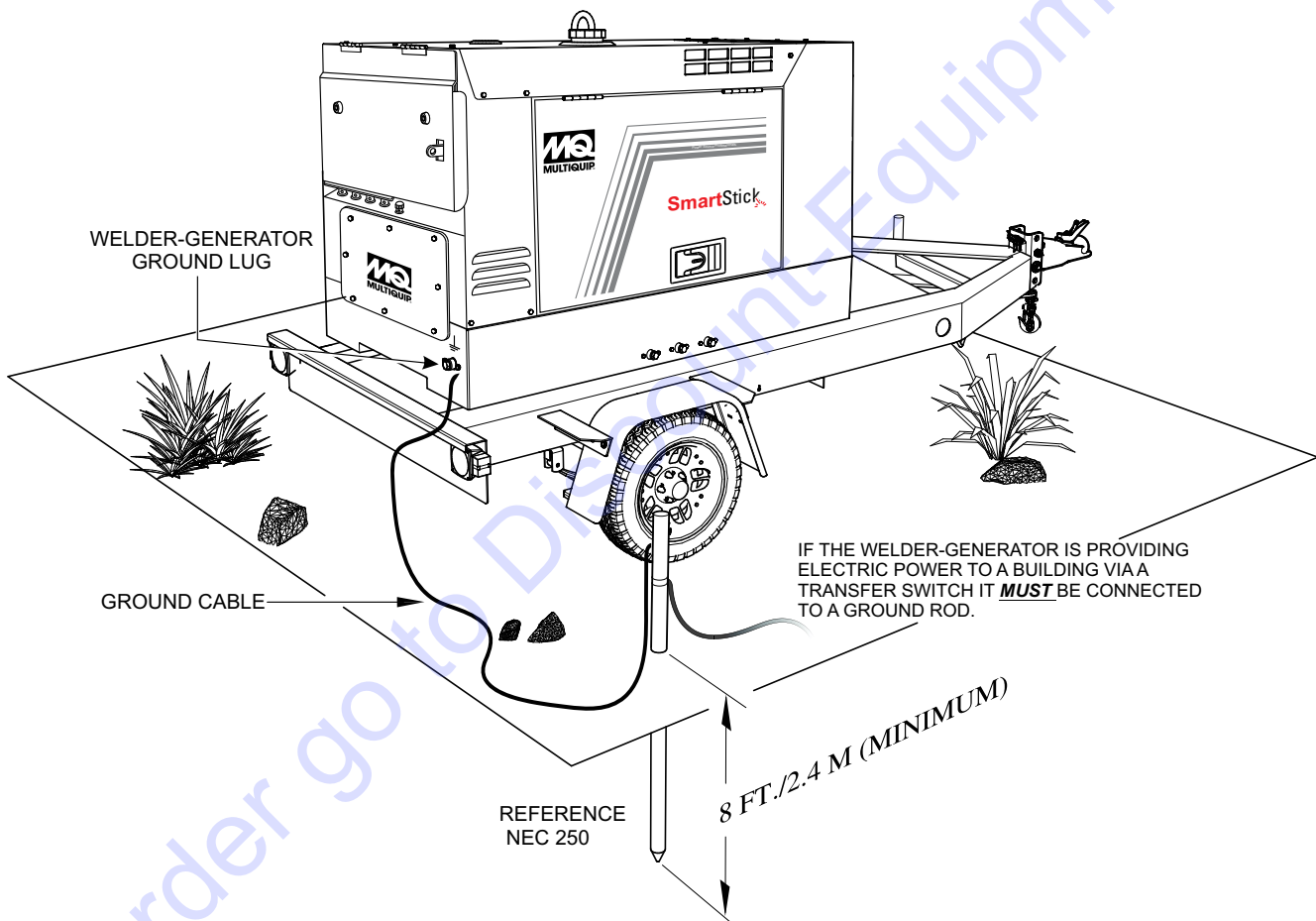

Figure 3. Welder-Generator Grounding Application





## OUTDOOR INSTALLATION

If possible install the welder-generator in a area that is free of debris, bystanders, and overhead obstructions. Make sure the welder-generator is on secure level ground so that it cannot slide or shift around.

The installation site must be relatively free from moisture and dust. All electrical equipment should be protected from excessive moisture. Failure to do so will result in deterioration of the insulation and will result in short circuits and grounding.

Foreign materials such as dust, sand, lint and abrasive materials have a tendency to cause excessive wear to engine and alternator parts.

 **WARNING**

 Pay close attention to ventilation when operating the generator inside tunnels and caves. The engine exhaust contains noxious elements. Engine exhaust must be routed to a ventilated area

## INDOOR INSTALLATION

Exhaust gases from gas engines are extremely poisonous. Whenever an engine is installed indoors the exhaust fumes must be vented to the outside. The engine should be installed at least two feet from any outside wall. Using an exhaust pipe which is too long or too small can cause excessive back pressure which will cause the engine to heat excessively and possibly burn the valves.

## PLACEMENT

This welder-generator should always be placed on a flat level surface when it is running. **DO NOT** place the welder-generator on slopes, the possibility exists that the unit could slide.

 **DANGER**

 Electric shock can occur when vibrators are used. Pay close attention to handling when operating vibrators and always use rubber boots and gloves to insulate the body from a short circuit.

## WELDER-GENERATOR GROUNDING

### NOTICE

The Occupational Safety and Health Administration (OSHA) and the National Electrical Code (NEC) recommend that if the welder-generator is providing electrical power to a structure (home, office shop, trailer or similar) it **must** be connected to a grounding electrode system, such as driven ground rod (Figure 3).

If applicable, to guard against electrical shock and possible damage to the generator, it is important to provide a good **EARTH** ground, (Figure 3).

### NOTICE

**ALWAYS** check with State, Province, District and Municipalities for electrical grounding requirements before using generator.

Article 250 (Grounding) of the NEC handbook provides guidelines for proper grounding. It specifies that the cable ground shall be connected to the grounding system of the building as close to the point of cable entry as practical.

NEC article 250 specifies the following grounding requirements:

1. Use one of the following wire types to connect the generator to earth ground.
  - a. Copper 10 AWG (5.3 mm<sup>2</sup>) or larger.
  - b. Aluminum 8 AWG (8.4 mm<sup>2</sup>) or larger.
2. When grounding of the generator (Figure 3) is required, connect one end of the ground cable to the ground lug on the generator. Connect the other end of the ground cable to the ground rod (earth ground).
3. NEC article 250 specifies that the earth ground rod should be buried a minimum of 8 ft. into the ground.

### NOTICE

When connecting the generator to any buildings electrical system **ALWAYS** consult with a licensed electrician.

# GENERAL INFORMATION

When used in **single** mode applications, Multiquip's Model DLW400ESA4 Whisper Weld™ is a 400 amp DC welder. **Dual** mode applications provide 200 amps at each of the A and B welding terminals.

This unit incorporates a brushless revolving field simultaneous power generator, featuring stable arc characteristics, excellent vibration resistance and durability.

The unit also incorporates an AC power source (14 kW) which provides power for tools, submersible water pumps and other industrial and construction machinery.

In addition, this unit features incredibly quiet operation and can be operated at night or in restricted noise level locations.

This instruction manual provides information necessary for proper handling and operation of the welder/generator.

Please read the manual to ensure maximum operation and long service life.

## CONTROL PANEL

The control panel is provided with the following components:

- DC Weld Meter
- Hour Meter
- Display Change Button
- Idle Stop Monitor
- Fuel Guage
- Warning Lamp/Hour Display Button
- Welding Regulation Control A/B
- Current Voltage Regulator Control A/B
- Single-Dual Selector Switch
- Welding Mode Selector Switch CC/CV
- E-Mode Selector Switch
- Operation Lamp
- Start Button
- Starter Switch
- 40 Amp Main Circuit Breaker
- AC Voltmeter
- Idle Stop Time Regulator Control
- Idle Stop Select Switch
- GFCI Sensing Module

## OUTPUT TERMINAL PANEL

- 120 VAC GFCI Receptacle (5-20R)
- 120V Twist-Lock Output Receptacle (L5-30R)
- 240V Twist-Lock Output Receptacle (L6-30R)
- 120/240V Output Twist-Lock Receptacle (CS6369)
- 20 Amp 2P Circuit Breaker
- 30 Amp 1P Circuit Breaker
- 30 Amp 2P Circuit Breaker
- Ground Terminal

## OPTIONS

The welder-generator has the following options:

- TRLRMP/TRLRMPXF Trailers
- Trailer Tool Box
- Cable Carrier
- Wired Remote Control
- Block Heater
- Fuel Heater
- Battery Tender

This welder-generator is powered by a 4 cylinder, 4-cycle liquid-cooled Kubota D902E4B diesel engine. This engine is designed to meet every performance requirement for the generator. Reference Table 4 for engine specifications.

In keeping with MQ Power's policy of constantly improving its products, the specifications quoted herein are subject to change without prior notice.

## EXTENSION CABLES

When electric power is to be provided to various tools or loads at some distance from the generator, extension cords are normally used. Cables should be sized to allow for distance in length and amperage so that the voltage drop between the generator and point of use (load) is held to a minimum. Use the cable selection chart (Table 9) as a guide for selecting proper extension cable size.

# WELDING POLARITY AND DUTY CYCLE

## WELDING POLARITY

Polarity indicates the direction of the current flow in that circuit. Since DC current moves in only one direction, polarity is important because the flow of current must be changed depending on the application.

By changing the **polarity**, the greatest amount of heat can be concentrated where it is most needed. With straight polarity (electrode negative), more heat is directed to the **workplace**. When using reverse polarity (electrode positive), more of the heat generated is directed to the **electrode**. Reference Figure 16.

### NOTICE

When high quality welding is required **DO NOT** use AC power side of unit.

## DUTY CYCLE

### NOTICE

The **American Welding Society** sets all regulations and procedures for the welding industry. All welders are subject to the same regulations.

**Duty cycle** is based on a 10-minute welding period. Exceeding the duty cycle will have an affect on the welding process. The amperage will start dropping off and the welding process will not have the proper amperage required to proceed. If the duty cycle is exceeded, damage can occur to the welding machine.

The 10-minute duty cycle period means 100% welding. If the duty cycle is 60%, then you can only **weld for six minutes** and the machine must **cool down for four minutes** (Reference Table 7 below).

**Table 7. 10-Minute Duty Cycle**

Duty Cycle %	Welding ON Time (Min.)	Cool Down Time (Min.)	Welding Current (Amps)
<b>Single Mode</b>			
100 <sup>1</sup>	Continuous	N/A	30 ~ 350
90	8	2	320
80	7	3	380
75	6	4	400
<b>Dual Mode</b>			
100 <sup>1</sup>	Continuous	N/A	30 ~ 175
90	9	2	180
80	8	3	190
75	7.5	4	200

<sup>1</sup>The DLW400ESA4 welder has a 100% duty cycle @ 350 amps (single mode) or 175 amps (dual mode).

## DEFINITIONS OF WELDING TERMS

1. **Weld** – The unification of metallic parts by heating and allowing the metals to flow together or by hammering or compressing with or without previous heating.
2. **Straight Polarity** – A term for direct current electrode negative.
3. **Reverse Polarity** – A term for direct current electrode positive.
4. **Manual Welding** – A welding operation performed and controlled completely by hand.
5. **AC or Alternating Current** – AC is the kind of electricity, which reverses its direction periodically. For 60 cycle current, the current goes in one direction and then in the other direction 60 times in the same second, so that the current changes its direction 120 times in one second.
6. **DC or Direct Current** – DC is the kind of electricity, which only flows in one direction. The flow of electricity is from the power source to the application. In welding, an arc welding process wherein the power supply is at the arc is direct current.
7. **ARC Force** – An adjustment that allows the operator to fine tune the arc characteristics according to job requirements.
8. **ARC Length** – The distance from the end of the electrode to the point where the arc makes contact with the work surface.
9. **ARC Voltage** – The voltage across the welding arc.
10. **ARC Blow** – The deflection of an electric arc from its normal path because of magnetic forces.
11. **Base Metal (Material)** – The metal (material) to be welded, brazed, soldered, or cut.
12. **E-Mode** – Improves fuel efficiency by allowing the operator to weld with engine at idle speed at up to 240 amps (single mode). Reduces operating costs and noise levels.
13. **Covered Electrode** – A composite fill metal electrode consisting of a core of a bare electrode or metal-cored electrode to which a covering sufficient to provide a slag layer on the weld metal has been applied.

The covering may contain materials providing such functions as shielding from the atmosphere, deoxidization, and arc stabilization and can serve as a source of metallic additions to the weld.
14. **Fillet Weld** – A weld of triangular cross section joining two surfaces approximately at right angles to each other in a lap joint, T-joint or corner joint.
15. **Tack Weld** – A weld made to hold parts of a weldment for proper alignment until the final welds are made.
16. **Shade Number** – This number pertains to the lightness or darkness of the lens in the welding helmet. Lens number range from 2 to 14 where 2 would be the lightest lens and 14 would be the darkest lens.
17. **CC or Constant Current** – In this mode the amperage or current stays constant, but the direct current voltage will change depending on the arc length. This mode is applied to SMAW, FCAW and GTAW processes.
18. **CV or Constant Voltage** – In this mode the direct current voltage stays constant, but direct current amperage will change slightly. This mode is applied to GMAW, FCAW and GTAW.
19. **Parallel Connection** – Simply connect the positive terminals together, then connect the negative terminals together. Make sure that the machines are located as close together as possible.

Welding cables should be sized appropriately to handle the additional amperage. Rheostats must be set at the same amperage or as close as possible. (Note: Unlike competitive models, no parallel box is needed with Multiquip's welder-generators.)

## WELDING PROCESSES

- SMAW – Shielded-Metal Arc Welding
- FCAW – Flux-Cored Arc Welding
- GMAW – Gas-Metal Arc Welding
- GTAW – Gas-Tungsten Arc Welding
- ACAC – Air Carbon Arc Cutting

# COMPONENTS (WELDER/GENERATOR)

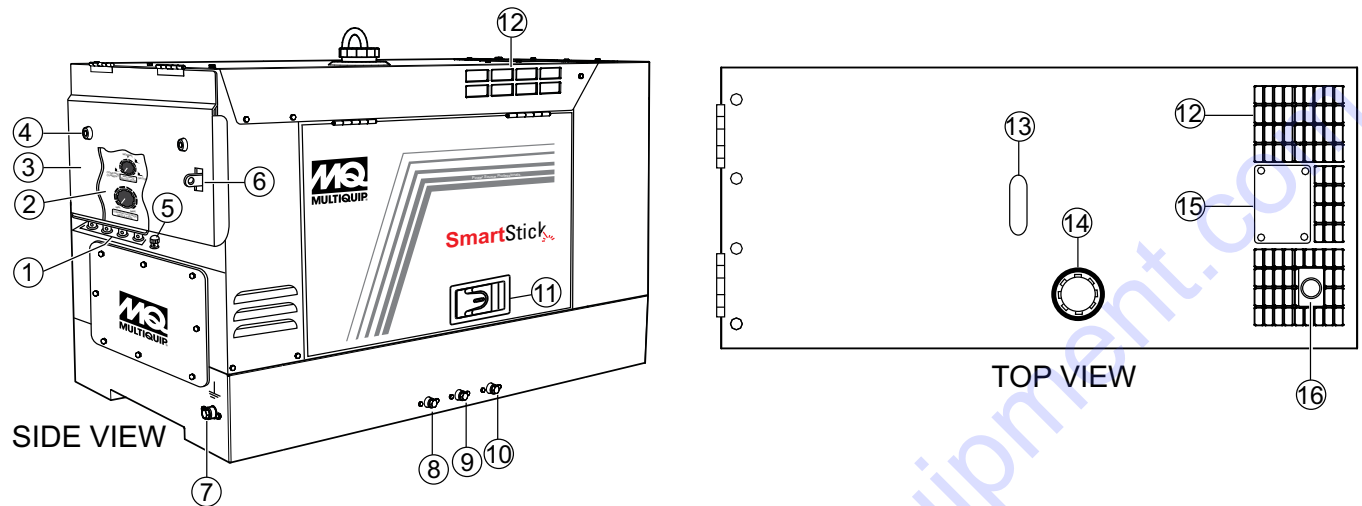
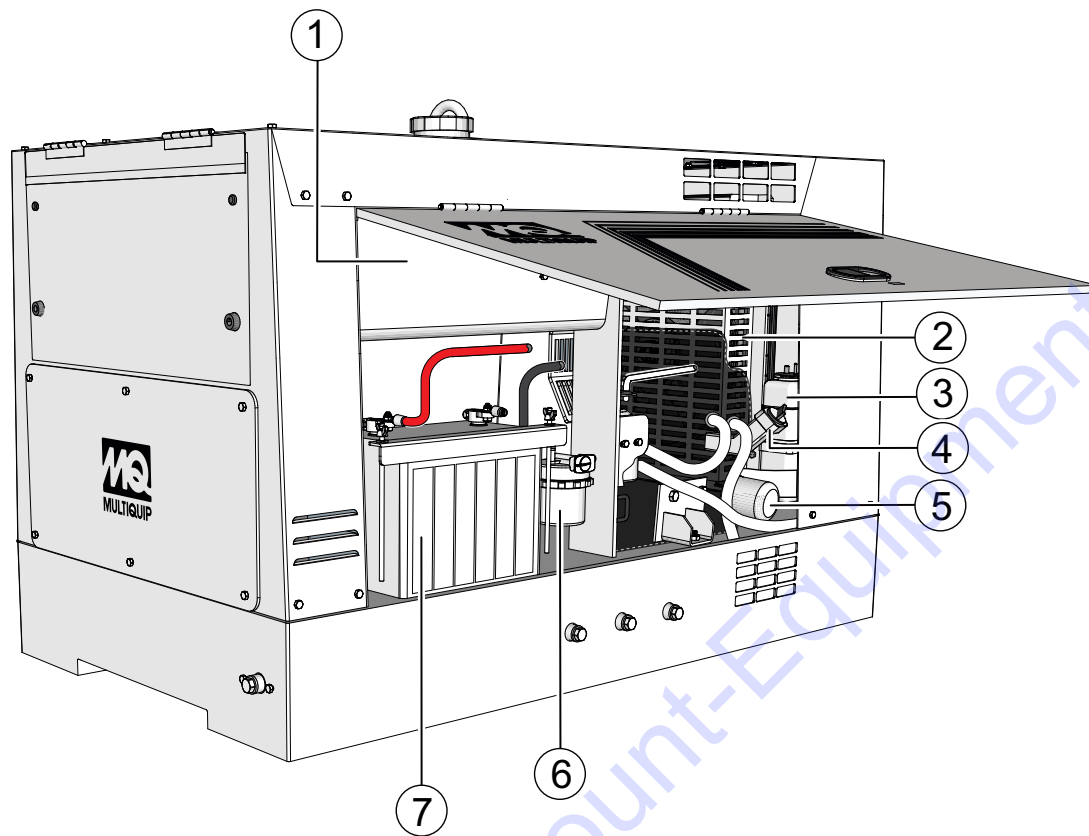

Figure 4. Welder-Generator Components

1. **A/B DC Welding Output Terminals** – Connect the DC welding cables to these terminals. Note the polarity marked on the welder-generator terminals. Select the appropriate polarities according to the application as specified in Table 15.
2. **Control Panel** – Contains controls and indicators necessary to operate the welder-generator.
3. **Front Panel** – Lift upwards to gain access to the welder-generator control panel.
4. **Rubber Stopper** – Prevents scratching of front cover when front cover is folded back.
5. **GFCI Ground Terminal** — Used to connect external equipment ground so that the GFCI receptacle will have a ground path.
6. **Door Lock** – To prevent unauthorized use, place a padlock through the locking eye.
7. **Frame Ground Lug** — Connect a ground strap between this lug and a ground rod. Make sure that the ground rod is inserted deep into the ground to provide a good earth ground. Consult with local Electrical and Safety Codes for proper connection based on condition of use.
8. **Fuel Drain Plug** – Remove this plug to drain fuel from fuel tank Reference Table 4 for fuel tank capacity.
9. **Coolant Drain Plug** – Remove this plug to drain coolant from the radiator. Reference Table 4 for coolant capacity.
10. **Oil Drain Plug** – Remove this plug to drain engine oil. Reference Table 4 for engine oil capacity and oil type.
11. **Door Release Latch** – Pull outward to release cabinet door.
12. **Air Inlet Vent** — Allows outside air to enter the generator. **NEVER** block this opening.
13. **Lifting Hook** – Attach a strap or chain of adequate lifting capacity to this lifting point when the welder-generator must be lifted. Lifting device capacity must be able to lift 2000 lbs. ( 907 kg).
14. **Fuel Cap** – Remove this cap to add diesel fuel to the fuel tank. Reference Table 4 for engine fuel tank capacity and type fuel. Make sure cap is tightened securely. **DO NOT** over fill.
15. **Radiator Inlet** – Remove this cover to gain access to the radiator cap. Always allow engine to cool before removing radiator cap.
16. **Engine Exhaust Outlet** — Allows engine exhaust to exit the generator into the open air. **NEVER** block this opening.

## COMPONENTS (WELDER/GENERATOR)



**Figure 5. Control Panel Components**

1. **Fuel Tank** — Holds 11.1 gallons (42 liters). Fill with diesel fuel as specified in Table 4.
2. **Radiator** — Holds coolant/water necessary to keep the engine at a safe operating temperature. Remove this cap to add water/antifreeze when cool.
3. **Expansion Bottle** — Supplies coolant to the radiator when radiator coolant level is low. Fill to indicated level as shown on expansion bottle.
4. **Engine Oil Filler Port** — Remove this cap to add engine oil. Use only the recommended oil type. See Table 4 for engine oil capacity.
5. **Oil Filter** — Spin-on type, filters oil contaminants. Replace filter as recommended in the maintenance section of this manual.
6. **Fuel Filter** — Prevents dirt and other debris from entering the fuel system. Change fuel filter as recommended in the maintenance section of this manual.
7. **Battery** — Provides +12 VDC power for the welder-generator. When replacing battery (12V 45 AH) use only recommended type battery.

## COMPONENTS (ENGINE)

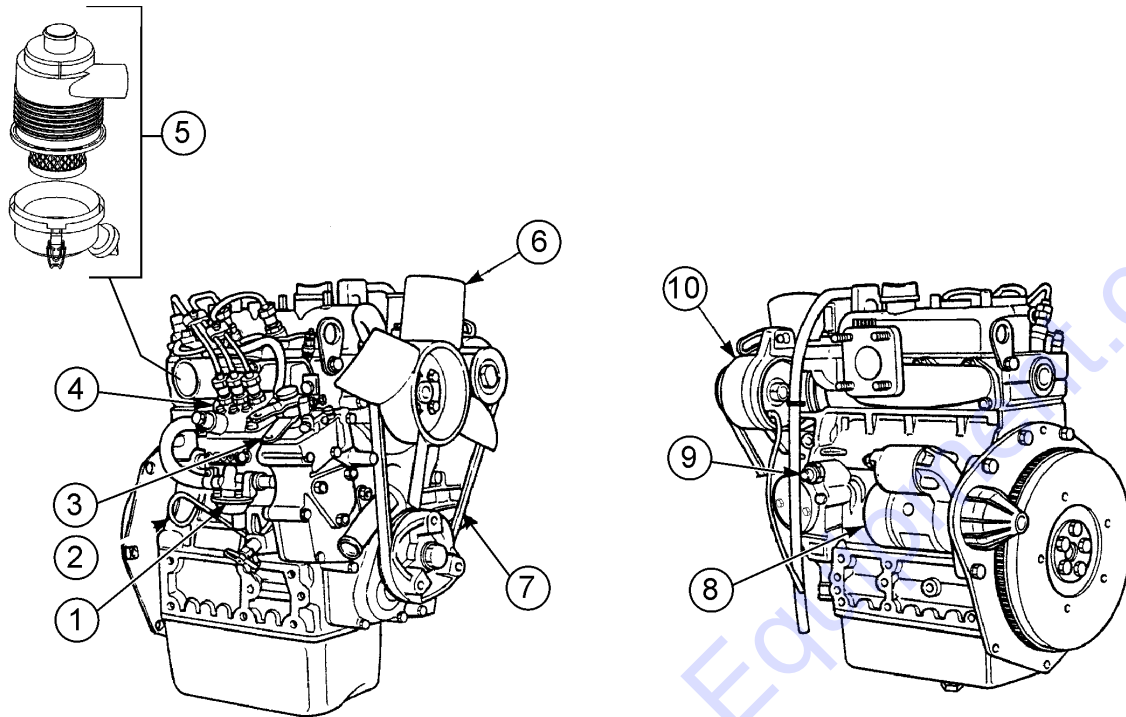

Figure 6. Kubota 902E4B Diesel Engine

### INITIAL SERVICING

The engine (Figure 6) must be checked for proper lubrication and filled with fuel prior to operation. Refer to the manufacturer's engine manual for instructions and details of operation and servicing.

1. **Fuel Feed Pump** — Pumps fuel to the injection system.
2. **Oil Dip Stick/Gauge** — Remove to check amount and condition of oil in crankcase. Refill or replace with recommended type oil as listed in Table 4 and Table 10.
3. **Speed Control Lever** — Controls engine speed. This lever is factory set at 3600 rpm to maintain proper voltage and frequency. **DO NOT** adjust this lever out of factory range.
4. **Injector Pump** — Provides fuel under pressure to the injector nozzles.
5. **Air Filter** — Prevents dirt and other debris from entering the air intake system. Loosen clips on side of air filter canister to gain access to filter element. Replace with manufacturer's recommended type air cleaner only.
6. **Cooling Fan Blades** — Make sure cooling fan blades are not bent or broken. A damaged fan blade can cause the engine to run hot and overheat.
7. **V-Belt** — **ALWAYS** make sure V-belt is properly tensioned. A loose or defective V-belt can adversely affect the performance of the generator.
8. **Starter** — Starts engine when ignition key is rotated clockwise to the "ON" position.
9. **Oil Pressure Switch** — Monitors engine oil pressure. In the event of low oil pressure, engine will shutdown.
10. **Alternator** — Provides power to the +12VDC electrical system. Replace with only manufacturer's recommended type alternator.

# POWER RECEPTACLES

## POWER RECEPTACLES

Located just to the right of the welding terminals are the auxiliary power receptacles. These power receptacles are described below.

### 120 VAC GFCI RECEPTACLE

The 120 VAC, 20 amp GFCI (Duplex Nema 5-20R) receptacle is protected by a 20 amp circuit breaker (CB4). The breaker is located above and to the right of GFCI receptacle. The **green** LED should be **ON**, indicating that the receptacle is working properly. If the **red** LED is **flashing**, **DO NOT** use the receptacle. Replace it immediately.

Pressing the **reset** button resets the GFCI receptacle after being tripped. Reference the maintenance section of this manual for proper testing of the GFCI receptacle.

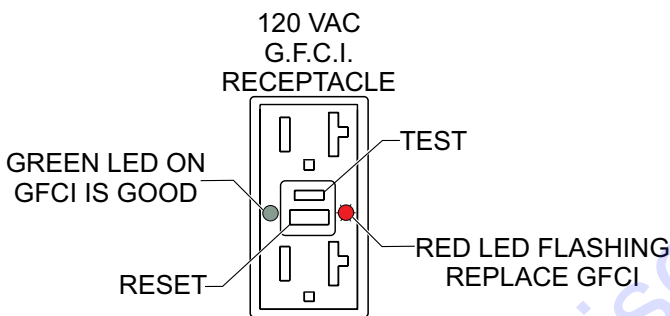

Figure 7. G.F.C.I. Receptacle

### Twist Lock Receptacles

There are three auxiliary twist-lock receptacles. These power receptacles (Figure 8) are described below.

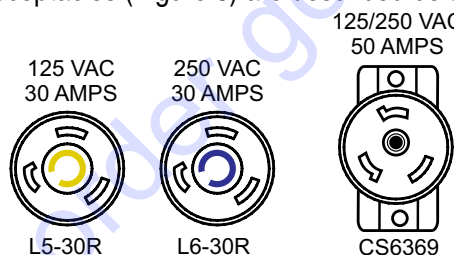

Figure 8. Auxiliary Twist-Lock Receptacles

- **L5-30R** — Provides 125 VAC @ 30 amps
- **L6-30R** — Provides 250 VAC @ 30 amps
- **CS6369** — Provides 125/250 VAC @ 50 amps (Dual Voltage receptacle).

## SINGLE PHASE LOAD

Always be sure to check the nameplate on the generator and equipment to insure the wattage, amperage, frequency, and voltage requirements are satisfactorily supplied by the generator for operating the equipment.

Generally, the wattage listed on the nameplate of the equipment is its rated output. Equipment may require 130—150% more wattage than the rating on the nameplate, as the wattage is influenced by the efficiency, power factor and starting system of the equipment.

### NOTICE

If wattage is not given on the equipment's name plate, approximate wattage may be determined by multiplying nameplate voltage by the nameplate amperage.

$$\text{WATTS} = \text{VOLTAGE} \times \text{AMPERAGE}$$

The power factor of this welder-generator is 1.0. See Table 8 below when connecting loads.

Table 8. Power Factor By Load

Type of Load	Power Factor
Single-phase induction motors	0.4-0.75
Electric heaters, incandescent lamps	1.0
Fluorescent lamps, mercury lamps	0.4-0.9
Electronic devices, communication equipment	1.0
Common power tools	0.8

Table 9. Cable Selection (60 Hz, Single Phase Operation)

Current in Amperes	Load in Watts		Maximum Allowable Cable Length			
	At 100 Volts	At 200 Volts	#10 Wire	#12 Wire	#14 Wire	#16 Wire
2.5	300	600	1000 ft.	600 ft.	375 ft.	250 ft.
5	600	1200	500 ft.	300 ft.	200 ft.	125 ft.
7.5	900	1800	350 ft.	200 ft.	125 ft.	100 ft.
10	1200	2400	250 ft.	150 ft.	100 ft.	
15	1800	3600	150 ft.	100 ft.	65 ft.	
20	2400	4800	125 ft.	75 ft.	50 ft.	

CAUTION: Equipment damage can result from low voltage



# CONTROL PANEL

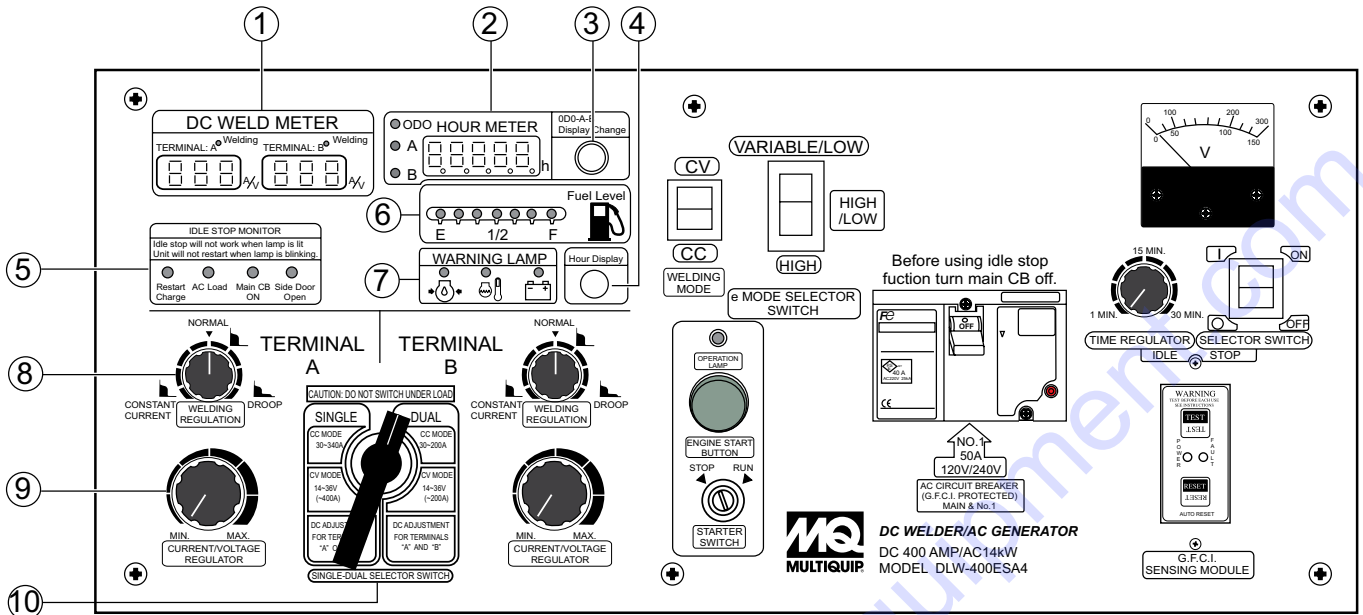

Figure 9. Control Panel

- DC Weld Meter** – A digital display that indicates the amperage and voltage at the A and B welding terminals. In addition, this display is also used to display engine error codes and other welder-generator diagnostic information. Reference Table 27 for engine error code definitions.
- Hour Meter** – A digital display that indicates the welding hours on terminals A and B. The ODO indicates total machine hours of use.
- ODO-A-B Display Change Button** – When pressed allows hour meter display to cycle between ODO (run time) and welding output terminals A and B.
- Hour Display Button** – Only used when engine is off. When pressed and held, ODO, loaded and unloaded hours of operation will be displayed on hour meter display.  
Press display change button while holding down hour display button to toggle between ODO and A and B welding output terminals.
- Idle Stop Monitor** – Consists of four status LEDs, if any of the LEDs are lit or blinking, idle stop function will not work.
- Fuel Tank LED Indicators** – Consists of seven status LEDs indicating the amount of fuel in the fuel tank.
- Engine Warning Lamp Indicators** – Consists of three status LEDs, oil pressure, high coolant temperature and battery charge. If any of the LEDs are lit, the engine will shutdown automatically.  
Press display change button while holding down hour display button to toggle between ODO and A and B welding output terminals.
- Terminals A/B ARC Force Regulator Control** – An adjustment that allows the operator to fine tune the arc characteristics according to job requirements. This control allows the user to adjust the arc from a soft smooth arc to a more aggressive digging arc.  
Placing the voltage selector switch in the **single** mode position will access terminal **A**. Placing the voltage selector switch in the **dual** mode will access both terminals **A** and **B**.
- Terminals A/B Current/Voltage Reg. Control** – Place this knob in the desired setting when welding is required. Current range is from 30 to 400 amps (CC single mode), 30 to 200 amps (CC dual mode).  
Placing the voltage selector switch in the **single** mode position will access terminal **A**. Placing the voltage selector switch in the **dual** mode will access both terminals **A** and **B**.
- Single/Dual Selector Switch** – Place this switch in the desired welding mode. **DO NOT** switch under load.

# CONTROL PANEL (CONTINUED)

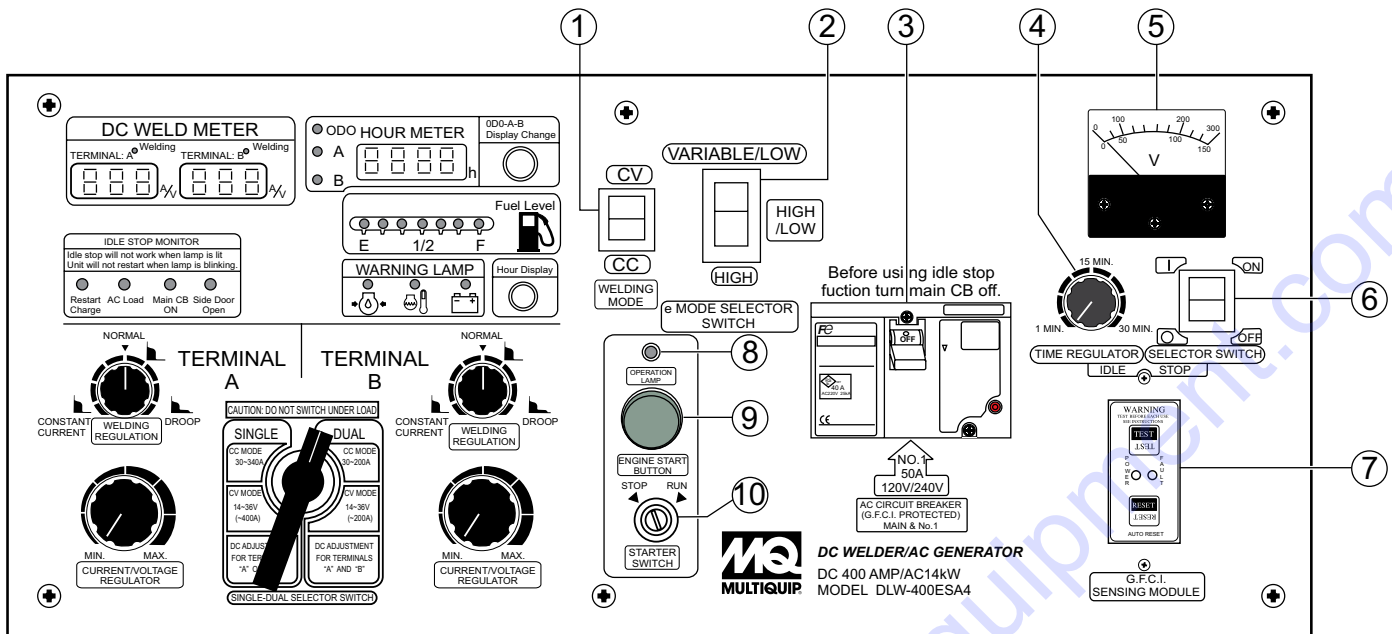

Figure 10. Control Panel (Continued)

1. **Welding Mode** – Place this rocker switch in the desired welding mode, **up** for constant voltage (CV), **down** for constant current (CC).
2. **E-Mode Selector Switch** – This 3-position rocker switch allows the engine to operate at low speed with no load or low welding load. The three switch positions are defined as follows:
  - **Variable/Low** – When the welding power and AC power are not in use, engine will run at lowest speed (2300 rpm). During welding operations engine speed is automatically controlled depending on welding output. However if an AC load of 100 watts or more is detected, the engine will be operated at high speed.
  - **High/Low** – With an AC load of 100 watts or more or while welding, the engine will be operated at high speed (3600 rpm) to respond to the preset AC frequency regardless of the welding work.
  - **High Position** – Engine is always operated at high speed (3600 rpm) with or without load.
3. **Main Breaker** – Place this 40 amp breaker (CB1) in the **ON** position (up) to provide AC voltage to auxiliary circuit breakers CB2, CB3 and CB4. This breaker is not required when welding.
4. **Time Regulator Control** – Indicates the amount of time (1~30 min.) the unit will run before automatic shutdown will occur. This control is only active in the **idle stop** mode.
5. **AC-Voltmeter** – This voltmeter indicates the rated 60 Hz (single-phase) output voltage. In addition, the voltmeter can also be used as a diagnostic tool.
 

If the voltmeter indicator (needle) is below the rated voltage, engine problems may exist (low/high RPM's). To prevent damage to the generator or power tools, turn the generator OFF and consult Discount-equipment.
6. **Selector Switch** – Place this switch in the **ON** position to enable the idle stop function.
7. **GFCI Sensing Module** – Interrupts power when a ground fault exists.
8. **Operation Lamp** – When lit, indicates unit is **ON** and in use.
9. **Engine Start Button** – After the ignition key has been placed in the **RUN** position, press this button **once** to start the engine. Continuous pushing of the button is not required to start the engine.
10. **Starter Switch** – Place ignition key in **RUN** position, then press engine start button to start engine.

## LUBRICATION OIL

Fill the engine crankcase with lubricating oil through the filler hole, but **DO NOT** overfill. Make sure the generator is level and verify that the oil level is maintained between the two notches (Figure 11) on the dipstick. See Table 10 for proper selection of engine oil.

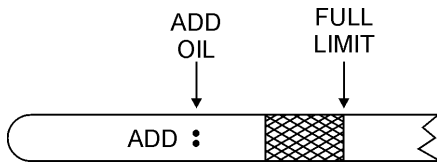

**Figure 11. Engine Oil Dipstick**

When checking the engine oil, be sure to check if the oil is clean. If the oil is not clean, drain the oil by removing the oil drain plug, and refill with the specified amount of oil as outlined in the **Kubota Engine Owner's Manual**. Oil should be warm before draining.

When low sulfur or ultra low diesel fuel is used, it is recommended that CF-4 or CG-4 (classification) engine oil be used. Reference Table 10 when replacing engine oil.

Table 10. Recommended Motor Oil		OIL: SAE	
°F	°C		
122	50	10W/40	30
104	40	10W/40	30
86	30	10W/40	30
68	20	10W/40	30
50	10	10W/40	30
32	0	10W/40	30
-14	-10	ARCTIC OIL	5W/30
-4	-20	ARCTIC OIL	5W/30
-22	-30	ARCTIC OIL	5W/30
-40	-40	ARCTIC OIL	5W/30
		15W/30	10W/30
		10W	20W/40

## FUEL CHECK

**DANGER**

Fuel spillage on a **hot** engine can cause a **fire** or **explosion**. If fuel spillage occurs, wipe up the spilled fuel completely to prevent fire hazards. **NEVER** smoke around or near the generator.

## REFILLING THE FUEL SYSTEM

**CAUTION**

**ONLY properly trained personnel** who have read and understand this section should refill the fuel tank system.

1. Lift the control panel lid and fold backwards.
2. Next, insert the ignition key into the starter switch and place in the **RUN** position.
3. Read the fuel gauge status LEDs (Figure 12) on the control panel and determine if the fuel level is low. Reference Table 11 for LED fuel gauge level indication.
4. Place ignition key in **STOP** position and remove ignition key from starter switch.

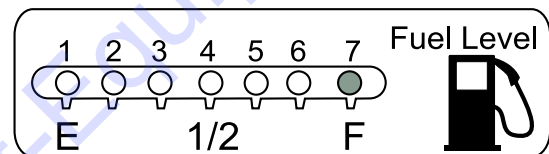

**Figure 12. Fuel Gauge**

Table 11. Fuel Gauge LEDs		
LED #	LED Color	Fuel Tank Level gal. (liters)
1	Red (Empty)	0~ 2.4 (0 ~ 9)
	Green	2.4~ 3.4 (9 ~ 12.8)
2	Green	3.4~4.8 (9.0 ~ 18.1)
3	Green	4.8~5.8 (18.1 ~ 22)
4	Green	5.8~6.9 (22 ~ 26.1)
5	Green	6.9~7.9 (26.1 ~ 29.9)
6	Green	7.9~9.2 (29.9 ~ 34.8)
7	Green (Full)	9.2~11.1 (34.8 ~ 42.0)

If fuel level is low, **ALWAYS** fill the fuel tank with clean fresh **low sulfur** or **ultra low sulfur** diesel fuel. No. 2 diesel fuel can be used as an alternative. **DO NOT** fill the fuel tank beyond its capacity.

Pay attention to the fuel tank capacity when replenishing fuel. The fuel tank cap must be closed tightly after filling. Handle fuel in a safety container. If the container does not have a spout, use a funnel. Wipe up any spilled fuel immediately.

## COOLANT (ANTIFREEZE/SUMMER COOLANT/WATER)

Kubota recommends antifreeze/summer coolant for use in their engines, which can be purchased in concentrate (and mixed with 50% demineralized water) or pre-diluted. See the **Kubota Engine Owner's Manual** for further details.

**WARNING**



If adding coolant/antifreeze mix to the radiator, **DO NOT** remove the radiator cap until the unit has completely cooled. The possibility of **hot!** coolant exists which can cause severe burns.

Day-to-day addition of coolant is done from the recovery tank. When adding coolant to the radiator, **DO NOT** remove the radiator cap until the unit has completely cooled. See Table 12 for engine, radiator, and recovery tank coolant capacities. Make sure the coolant level in the recovery tank is always between the "H" and the "L" markings.

Table 12. Coolant Capacity	
Engine and Radiator	.69 gal (2.6 liters)
Reserve Tank	.22 gal (.832 liters)

### Operation in Freezing Weather

When operating in freezing weather, be certain the proper amount of antifreeze (Table 13) has been added.

Table 13. Anti-Freeze Operating Temperatures		
Vol % Anti-Freeze	Freezing Point	
	°C	°F
50	-37	-34

**NOTICE**

When the antifreeze is mixed with water, the antifreeze mixing ratio **must be** less than 50%.

## CLEANING THE RADIATOR

The engine may overheat if the radiator fins become overloaded with dust or debris. Periodically clean the radiator fins with compressed air. Cleaning inside the machine is dangerous, so clean only with the engine turned off and the **negative** battery terminal disconnected.

## AIR CLEANER

Periodic cleaning/replacement is necessary. Inspect air cleaner as referenced in the maintenance section of this manual.

## FAN BELT TENSION

A slack fan belt may contribute to overheating or to insufficient charging of the battery. Inspect the fan belt for damage, wear and adjust it in accordance with the **Kubota Engine Owner's Manual**.

The fan belt tension (Figure 13) is proper if the fan belt bends 0.4~0.6 inches (10~15 mm) when depressed with the thumb as shown below.

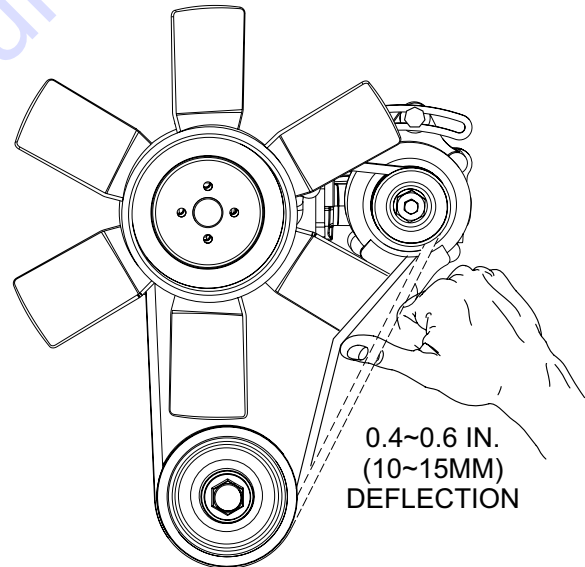



Figure 13. Fan Belt Tension

**CAUTION**



**NEVER** place hands near the belts or fan while the welder-generator set is running.

## BATTERY

This unit is of negative ground **DO NOT** connect in reverse. Always maintain battery fluid level between the specified marks. Battery life will be shortened, if the fluid levels are not properly maintained. Add only distilled water when replenishment is necessary.

**DO NOT** over fill. Check to see whether the battery cables are loose. Poor contact may result in poor starting or malfunctions. **Always** keep the terminals firmly tightened. Coat the terminals with an approved battery terminal treatment compound. Replace battery with only recommended type battery. The battery type used in this generator is BCI Group 22F (CCA:410).

The battery is sufficiently charged if the specific gravity of the battery fluid is 1.28 (at 68° F). If the specific gravity should fall to 1.245 or lower, it indicates that the battery is dead and needs to be recharged or replaced.

Before charging the battery with an external electric source, be sure to disconnect the battery cables.

## BATTERY CABLE INSTALLATION

**ALWAYS** be sure the battery cables (Figure 14) are properly connected to the battery terminals as shown below. **RED** cable is connected to the positive terminal of the battery, and the **BLACK** cable is connected to the negative terminal of the battery.

**CAUTION**

**ALWAYS** disconnect the negative terminal **FIRST** and reconnect negative terminal **LAST**.

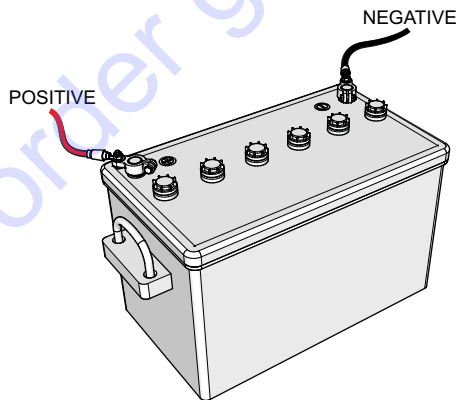

Figure 14. Battery

## SELECTING THE WELDING CABLE

The welding cable should be larger in size as it becomes longer or its current becomes higher. Prepare a cable with suitable size by referring to Table 14.

Length (ft) / Current (A)	50	100	125	150	200	250	300
100	#4	#4	#4	#4	#3	#2	#1
150	#3	#3	#3	#2	#1	#1/0	#2/0
200	#2	#2	#2	#1	#1/0	#2/0	#3/0
250	#1	#1	#1	#1/0	#2/0	#3/0	#4/0
300	#1/0	#1/0	#1/0	#2/0	#3/0	#4/0	#2-2/0
400	#2/0	#2/0	#2/0	#3/0	#4/0	#2-2/0	#2-3/0

Cable size values are based on a voltage drop of maximum 4 volts.

## WELDING CABLE AND POLARITIES

- ALWAYS** attach terminal ring connectors (Figure 15) to the end of the welding cable that will be connected to the welder output terminals.
- NEVER** connect exposed wires (Figure 15) directly to the welder output terminals. Exposed wiring may cause shocks or di-electric breakdown from poor contact.

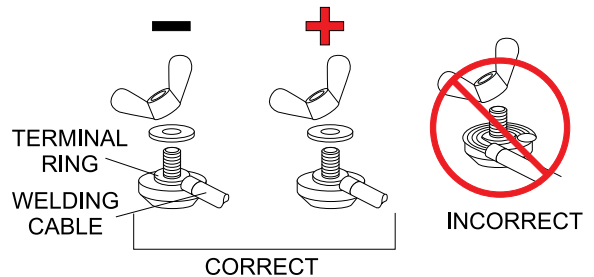

Figure 15. Welder Output Terminals

- Connect the welding cables to the welder output terminals located just below the control panel. The output terminals are marked (+) and (-) polarities. Select the appropriate polarities according to the application. Reference Table 15.

**DANGER**

**NEVER** allow the welding cable terminal to come in contact with the adjacent welding terminal or the welder-generator frame when the machine is in use. The possibility exists of electrical shock or short circuit which could cause a fire resulting in severe bodily harm and damage to the equipment.

**Table 15. Polarities and Applications**

Polarity	Welding Method	Typical Applications
Straight Polarity	(+)...Grounding (base metal) (-)...Welding holder	Arc welding for steel material of general structures, and for thick plates Arc welding for copper alloy
Reverse Polarity	(+)...Welding holder (-)...Grounding (base metal)	Build-up welding Air gouging Arc welding of thin plates Arc welding of stainless steel

**WARNING**

When operating the welder in dual mode, **NEVER** connect the positive and negative terminals (Figure 17) from the **A** and **B** sides together.

This condition may cause the voltage between the welding terminals to double under no load, causing damage to the equipment and **electrical shock** to personnel.

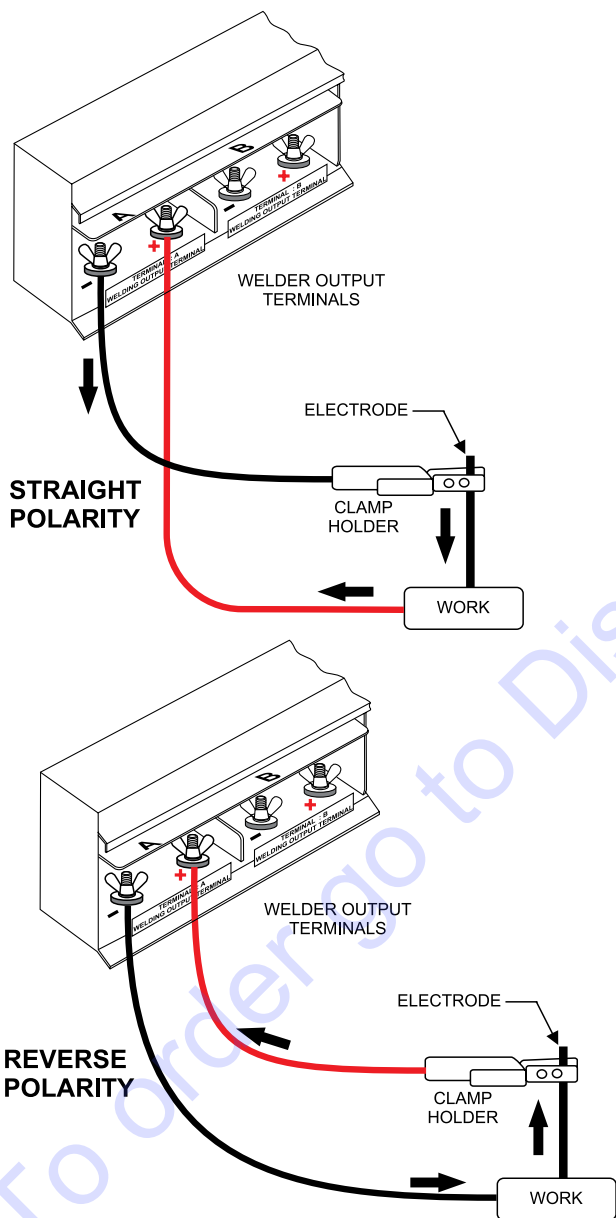

**Figure 16. Welding Cable Connections (Electrode Type Correct)**

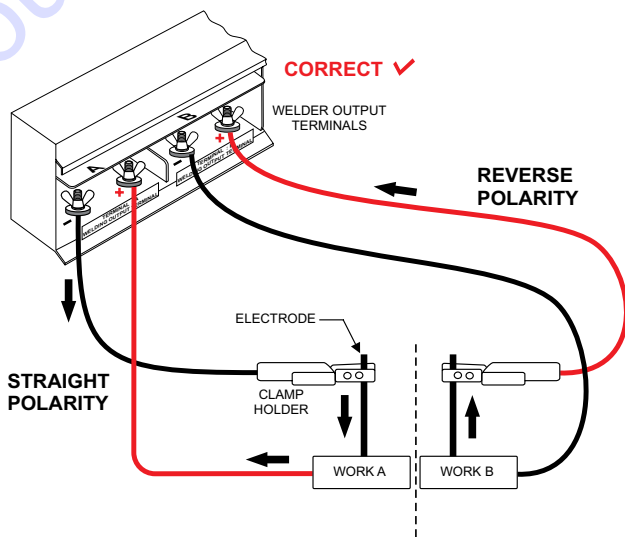
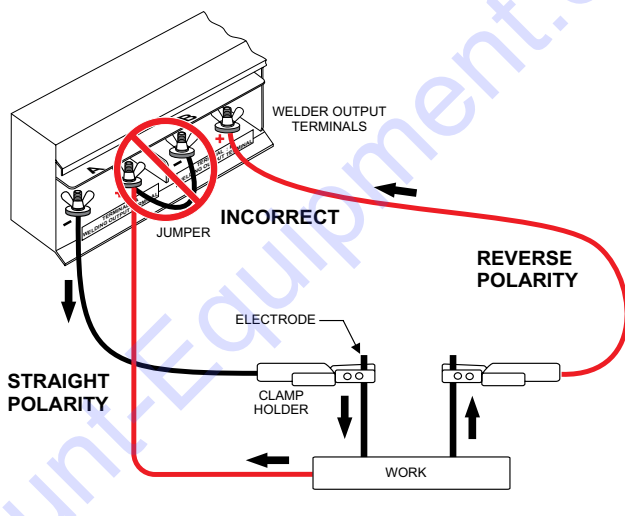

**Figure 17. Welding Cable Connections (Electrode Type Incorrect)**

4. For CC mode welding, select the appropriate electrode size in accordance with Table 16 (Single Mode Operation) or Table 17 (Dual Mode Operation).
5. Attach the clamp holder to the electrode as shown in Figure 16 and Figure 17.

**Table 16. Current Range/Electrode Size (Single Mode Operation)**

	Low 2300 rpm	Variable 2300~3600 rpm	High 3600 rpm
Current/ Range Amps	30~200A	30~400A	30~400A
Electrode Size Diameter	3/32" ~ 3/16"	3/32" ~ 5/16"	3/32" ~ 5/16"

**Table 17. Current Range/Electrode Size (Dual Mode Operation)**

	Low 2300 rpm	Variable 2300~3600 rpm	High 3600 rpm
Current/ Range Amps	30~200A	30~200A	30~200A
Electrode Size Diameter	3/32" ~ 3/16"	3/32" ~ 3/16"	3/32" ~ 3/16"

## CV Mode Welding

### NOTICE

A wire feeder (Figure 18) can be used when in the CV mode. The wire feeder utilizes the power output from the DC welding terminals. Consult the manufacturer's instructions when connecting the wire feeder to the welder-generator.

1. Connect the welding cables from the welder-generator to the wire feeder as shown in Figure 18.

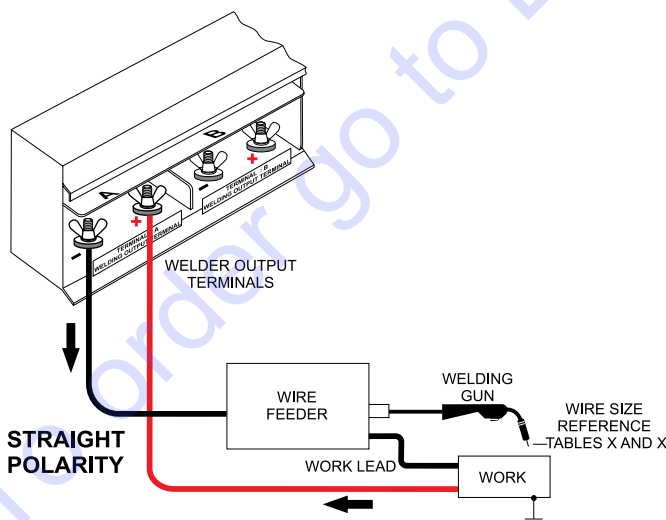

**Figure 18. CV Setup (Wire Feeder)**

2. Select the appropriate welding wire size depending on the application as referenced in the wire feeder instruction manual.
3. After the correct wire size has been determined, install wire spool onto wire feeder.
4. Adjust the CV voltage regulator for the desired DC voltage to the wire feeder.
5. Reference Table 18 when using flux-cored wires commonly known as Flux Cored Arc Welding (FCAW) process. This process has two types of flux-cored wires. One is self-shielded (FCAW-S), the other is gas-shielded (FCAW-G).

**Table 18. Flux-Cored Wires (Self/Gas Shielded)**

Weld Process/ WireType	Welder Output Terminal
Gas-Shielded	Connect to positive (+) terminal
Self-Shielded	Connect polarity as defined by the wire manufacturer instructions
NR-211MP Wire	Connect to negative (-) terminal
NR-311MP Wire	Connect to negative (-) terminal
NR-232MP Wire	Connect to negative (-) terminal

# OPERATION

Before starting the welder-generator, the pre-inspection safety checks must be completed. In addition, do a general survey of the area surrounding the machine making sure the area is safe, air vents of the machine are not blocked and the exhaust can be freely discharged.

The machine can be started, once the people surrounding the machine have been notified that the machine is going to be used.

## STARTING THE ENGINE

1. To protect the welder-generator from an overload, a 3-pole, 40 amp, **main** circuit breaker (Figure 19) is provided. In addition, there are three circuit breakers provided to protect the GFCI and auxiliary receptacles from overload. Make sure to switch **all** circuit breakers to the **OFF** position prior to starting the welder-generators.

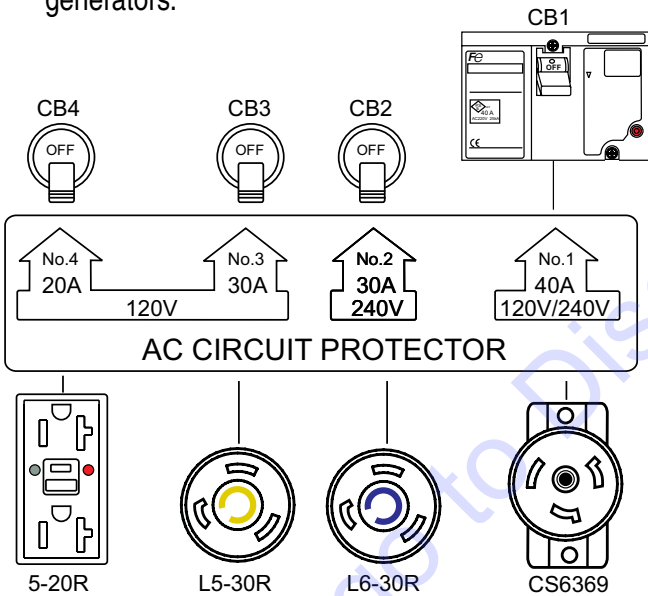

**Figure 19. Circuit Breakers**

2. Place the fuel valve lever (Figure 20) in the **ON** position.

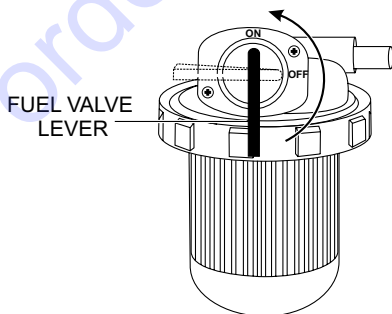

**Figure 20. Fuel Valve Lever (ON)**

3. Close all enclosure doors (Figure 21).

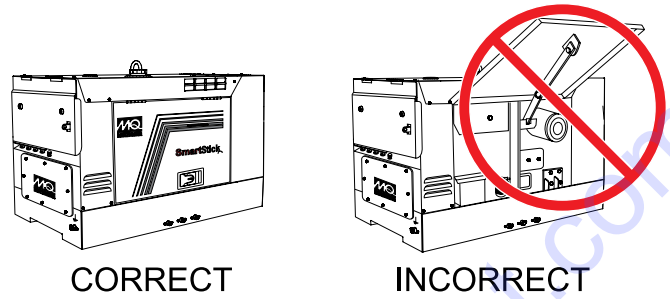
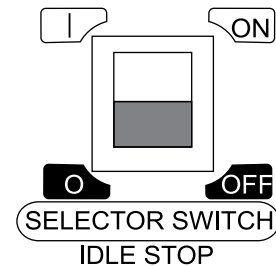

**Figure 21. Enclosure Doors (Closed)**

### NOTICE

**DO NOT** operate this equipment with the enclosure doors open. Operating the unit with the doors open during operation will effect the internal cooling air-flow of the machine and will allow foreign substances (e.g. dust and dirt) to be drawn into the unit.

4. Place the idle stop selector switch (Figure 22) in the **OFF** position.



**Figure 22. Idle Stop Selector Switch (OFF)**

5. Insert the ignition key (Figure 23) into the “Starter Switch” and turn the key clockwise to the **RUN** position.

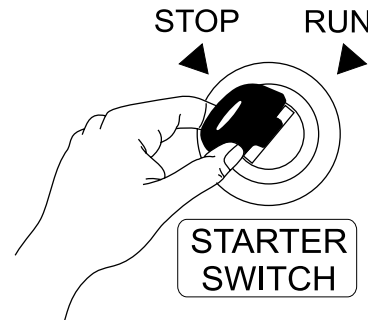

**Figure 23. Ignition Key (RUN Position)**



6. Verify operation lamp is lit (**ON**). Reference Figure 24.

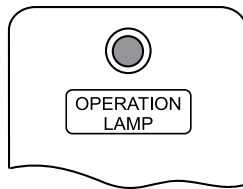

**Figure 24. Operation Lamp**

7. Next, verify that the ODO LED indicator is lit (**ON**) and the hour meter display (Figure 25) shows total machine hour used.

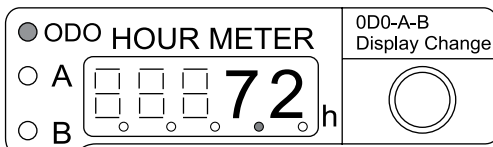

**Figure 25. Hour Meter (Run Position)**

8. Next, press the **GREEN** engine start button (Figure 26) only once. Continuous pressing of the button is not necessary. The engine will automatically start once the count down sequence has been completed.

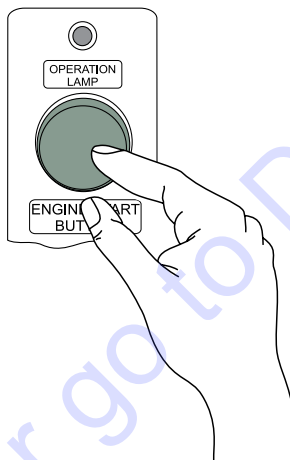

**Figure 26. Engine Start Button**

9. Verify that right-most decimal (Figure 27) on the hour meter display is **flashing**.

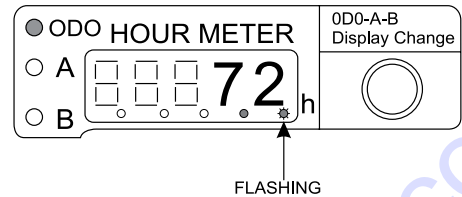

**Figure 27. Hour Meter (Engine Start)**

10. The DC welding meter will display the pre-heating countdown time value. The example shown in Figure 28 indicates 10 seconds before engine cranking can begin.

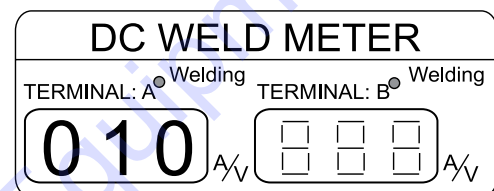

**Figure 28. DC Weld Meter (Countdown)**

11. When the pre-heating time has been completed, engine cranking will begin and the engine will be started.

## NOTICE

All pre-heating and cranking are automatic. The pre-heating time and cranking times are automatically controlled by the temperature sensor located on the unit. The lower the temperature, the longer the pre-heating and cranking time.

Three sets of pre-heating and cranking times are repeated until the engine is started. If the engine is not started with 3 sets of repetition, the DC Weld Meter will indicate E06 (starting failure), E01 (low oil pressure) and E03 (insufficient system charging).

12. After the engine starts, let the machine idle for 5~10 minutes to warm-up.
13. Carefully check the engine for abnormal vibration (noise), oil leakage, fuel leakage, cooling water leakage and air leakage. Also, verify if any alarm lights are lit. If any abnormal conditions exists, turn the engine **OFF** and correct the problem.

## SINGLE MODE WELDING (CC)

- Place the welding mode selector switch (Figure 29) in the *single* mode position.

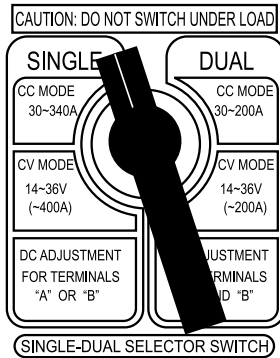

**Figure 29. Single-Dual Selector Switch (Single Position)**

- For **CC welding**, place the welding mode rocker switch in the CC position (down).

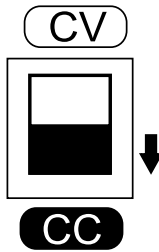

**Figure 30. Welding Mode Switch (CC Mode)**

- Place e-Mode selector switch (Figure 31) in the desired position as defined by Table 19. This switch is a 3-position rocker switch.

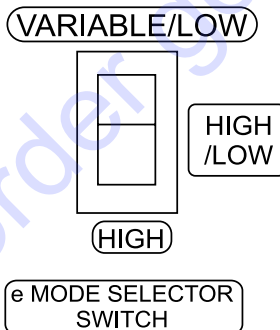

**Figure 31. E-Mode Selector Switch (CC Mode)**

**Table 19. Current Range/Engine Speed (Single Mode Operation)**

e Mode Selector Switch	Low 2300 rpm	Variable 2300~3600 rpm	High 3600 rpm
Variable/Low	30~200A See Notes	200~400A See Notes	—
High/Low	See Notes	—	30~400A
High	—	—	30~400A See Notes

Note 1: If using two welders connected with different polarities to weld the same work, the voltage between the holders may cause electric shock to the operator.

Note 2: If using two welders connected with different polarities to weld the same work, use separate grounds for each welder.

Note 3: **NEVER** switch the Single-Dual Selector Switch during welding operations. Switch contacting failure may occur.

### NOTICE

If the welding work requires a current of 240 amps or less for single mode applications, place the e-mode selector switch in the high/low or high position if bead appearance or welding faults are a concern.

In addition, place the e-mode selector switch in the high position if an AC load of 100 watts or an AC load with a magnet switch is used.

- If welding is started with the **e-mode selector switch** in the variable/low position, the standard welding load voltage is automatically calculated based on the preset welding current (Figure 32) and the engine speed will be controlled by the available kW capacity of the unit for either single or dual mode operation.

The engine will then be placed into low-speed operation about 9~10 seconds after a pause of welding work.

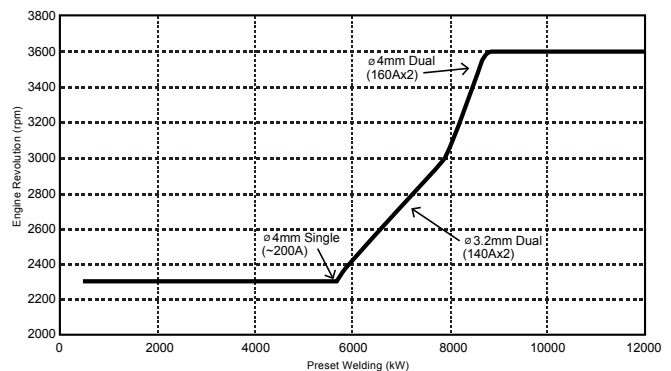

**Figure 32. E-Mode Engine Variable Control**

- Next, set the current/voltage regulator control knob (Figure 33) in accordance with the selected electrode size as referenced in Table 16.

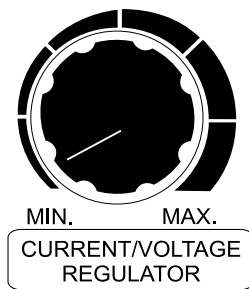

**Figure 33. Current/Voltage Regulator Control Knob (Current Adjust)**

- The selected current (amps) will be displayed on the DC weld meter. The example shown in Figure 34 is for a constant current value of 135 amps.

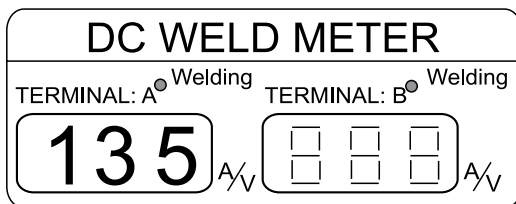

**Figure 34. DC Weld Meter (135 Amps)**

- Set the welding regulation control knob (Figure 35) to the desired setting.

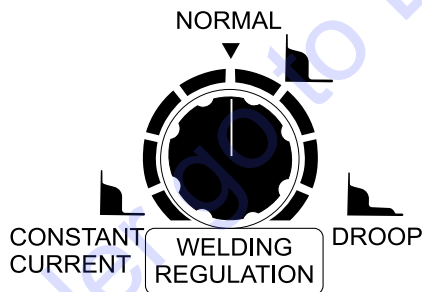

**Figure 35. Welding Regulation Control Knob**

### NOTICE

The welding regulation control knob is an adjustment used to control the **length** and **strength** of the welding arc. In addition this control can be used to **fine tune** the arc based on the specific application being used.

## DUAL MODE WELDING (CC)

### NOTICE

**NEVER** switch the **single dual selector switch** when welding. The possibility exists of contact failure which could cause arcing thus causing a fire and damage to the equipment.

- Place the welding mode selector switch (Figure 36) in the **dual** mode position.

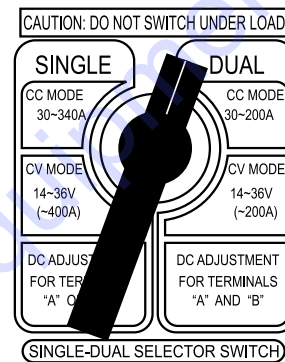

**Figure 36. Single-Dual Selector Switch (Dual Position)**

- Follow steps 2 through 6 as outlined in the Single Mode Welding (CC) section and reference Table 20 instead of Table 19.

**Table 20. Current Range/Engine Speed (Dual Mode Operation)**

e Mode Selector Switch	Low 2300 rpm	Variable 2300-3600 rpm	High 3600 rpm
Variable/ Low	A+B Total 30~200A See Note	A+B Total 200~400A No Load	—
High/Low	See Note	—	A+B Total 30~400A
High	—	—	A+B Total 30~400A See Note

Note: Reference notes 1, 2 and 3 as specified in Table 19.

## CV Welding

- For **CV welding**, place the welding mode rocker switch in the CV position (up).

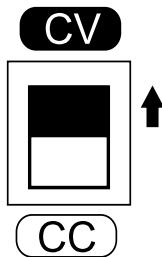
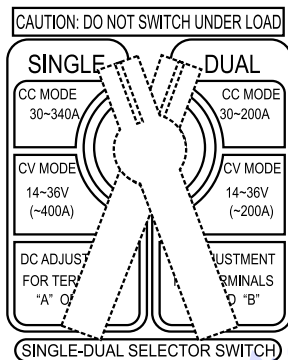

**Figure 37. Welding Mode Switch (CV Mode)**

- Place the welding mode selector switch (Figure 38) in either the **single** or **dual** mode position.

### NOTICE

If the single-dual selector switch has been placed in the **single position**, B-side welding terminals cannot be used.



**Figure 38. Single-Dual Selector Switch**

- Place e-Mode selector switch (Figure 39) in the desired position as defined by Table 21 or Table 22. This switch is a 3-position rocker switch.

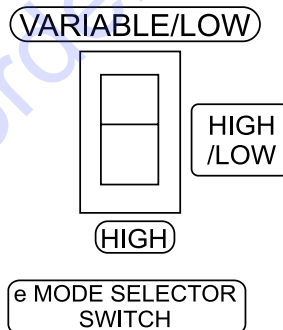

**Figure 39. E-Mode Selector Switch (CV Mode)**

**Table 21. Voltage Range/Engine Speed (Single Mode Operation)**

e Mode Selector Switch	Low 2300 rpm	Variable 2300~3600 rpm	High 3600 rpm
Variable/Low	14~17 VDC See Notes	18~35 VDC	—
High/Low	See Notes	—	14~35 VDC
High	—	—	14~35 VDC See Notes

Note 1: If using two welders connected with different polarities to weld the same work, the voltage between the holders may cause electric shock to the operator.

Note 2: If using two welders connected with different polarities to weld the same work, use separate grounds for each welder.

Note 3: **NEVER** switch the Single-Dual Selector Switch during welding operations. Switch contacting failure may occur.

**Table 22. Voltage Range/Engine Speed (Dual Mode Operation)**

e Mode Selector Switch	Low 2300 rpm	Variable 2300~3600 rpm	High 3600 rpm
Variable/Low	A+B Total 14~25V See Note	A+B Total 14~56V See Note	—
High/Low	See Note	—	A+B Total 14~56V
High	—	—	A+B Total 14~56V See Note

Note: Reference notes 1, 2 and 3 as specified in Table 21.

- Using the welding voltage control knob (Figure 40) adjust the voltage to the desired setting as referenced in Table 21 (Single Mode) or Table 22 (Dual Mode).

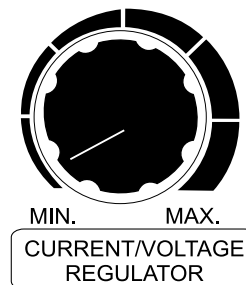

**Figure 40. Current/Voltage Regulator Control Knob (Voltage Adjust)**

- The selected voltage will be displayed on the DC weld meter (Figure 41).

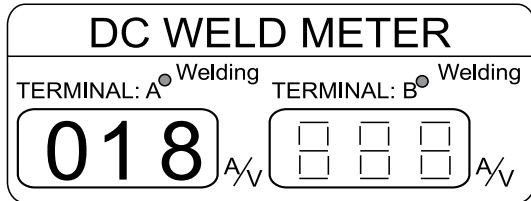

**Figure 41. DC Weld Meter (18 VDC)**

- Adjust welding current with the current regulator control on the wire feeder.

## Idle Stop Function

### NOTICE

The idle stop function when selected allows the welder-generator to be started or stopped remotely. Warning signs should be posted around the equipment indicating that the equipment can start without warning. All children and unauthorized personnel should be kept away when the equipment is operating in this mode.

- Place **all** circuit breakers in the **OFF** position.
- The idle stop function **will not work** if the following lamps are **ON** or **BLINKING** as referenced in Figure 42 and below:

- **Restart Charge Lamp** – If this lamp is **ON** or blinking the engine cannot be started.

### NOTICE

Whenever the unit is started either via pushbutton control or the Smart Stick™ function, battery voltage will be consumed. The restart charge lamp will turn on during engine cranking.

The lamp will remain on until the battery has received sufficient charge. Once a sufficient charge has been achieved, the lamp will turn off. This concept is in place to prevent the operator from shutting down and restarting the unit multiple times in a shorten time frame.

Multiple starts in a shorten time frame will deplete the battery charge, and cause battery replacement.

- **AC Load Lamp** – If lamp is **blinking**, indicates that the ON/OFF power switch of a power tool connected to the GFCI receptacle has been left in the **ON** position.

- **Main Circuit Breaker On Lamp** – If this lamp is **blinking** or **ON**, indicates that the main circuit breaker is in the **ON** position.
- **Side Door Open** – If lamp is **blinking**, indicates side door is open.

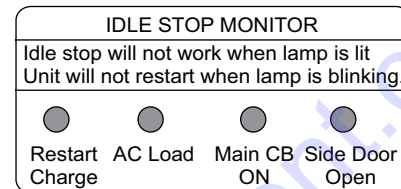

**Figure 42. Idle Stop Monitor**

- If any of the status lamps as referenced in Figure 42 are **ON**, correct the problem before using the idle stop function.

### WARNING

When using the idle stop function, be careful not to come in contact (**bare hands**) with the welding holder, welding terminals and the load connected to the GFCI receptacle. The possibility of electrical shock exist.

- Place the idle stop selector switch (Figure 43) in the **ON** position.

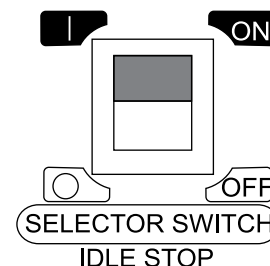

**Figure 43. Idle Stop Selector Switch (ON)**

- Next, set the time regulator to the desired setting. The example shown in (Figure 44) indicates 15 minutes.

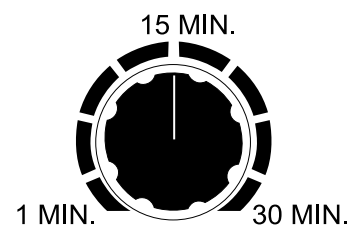

**Figure 44. Time Regulator**

- The welding process will be stopped once the preset time (1-30 minutes) has been reached. The engine will shutdown and the "1d5" message will be displayed on the DC Weld Meter (Figure 45).

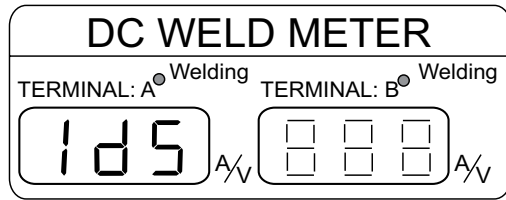
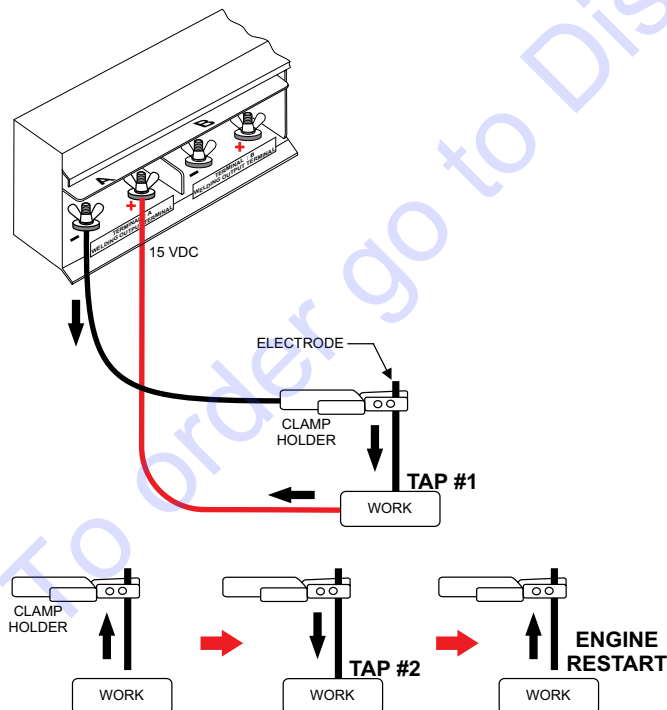

**Figure 45. DC Weld Meter (Idle Stop)**

## RESTARTING FROM IDLE STOP (WELDING SIDE)

This section will describe how the welder detects the restart signal when idle stop selector switch has been placed in the **ON** position (welder side).

- The stopping of the engine creates a restart signal, a voltage of about 15 VDC at the welding terminals.
- To decrease the voltage at the welding terminals, tap the welding electrode tip to the welding material.
- If the detecting circuit detects the varying signal twice or more (tap, tap, tap), the engine will be restarted automatically.

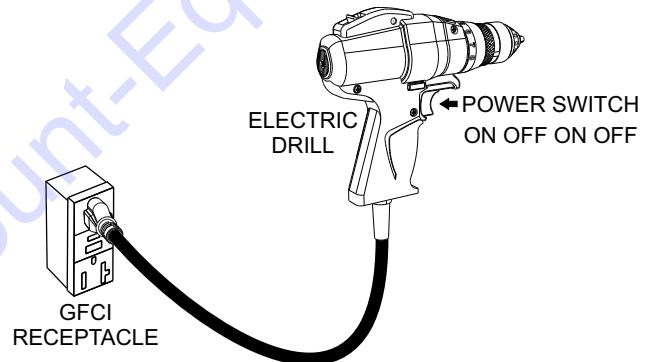

**Figure 46. Restart Signal (Welder Side)**

## RESTARTING FROM IDLE STOP (GENERATOR SIDE)

This section will describe how the welder detects the restart signal when idle stop selector switch has been placed in the **ON** position (generator side).

- To detect the restart signal, a voltage of about 15 VDC will be generated at the GFCI receptacle during the stopping of the engine.
- Insert the plug from a power tool such as a electric drill or saw into the GFCI receptacle on the welder/generator.
- Make sure the ON/OFF switch on the power tool is in the **OFF** position.
- Next, toggle the ON/OFF switch twice with the switch ending up in the **OFF** position.



**Figure 47. Restart Signal (Generator Side)**

- If the detecting circuit detects the varying signal twice or more (on, off, on and off) the engine will be restarted automatically.

### NOTICE

Make sure that the welding electrode tip (Figure 46) is free of any residue from the welding work and also make sure that the welding surface is not corroded. Both of these conditions could affect the restart signal.

Excessive residue on the electrode tip and corrosion on the welding surface may cause the engine not to start even after repeated tapping of the electrode on the work surface.

## NORMAL SHUTDOWN PROCEDURE

To shutdown the generator, use the following procedure:

1. Place the **main** (CB1), **duplex** (CB4), and **auxiliary** (CB2/CB3) circuit breakers as shown in Figure 48 to the **OFF** position.

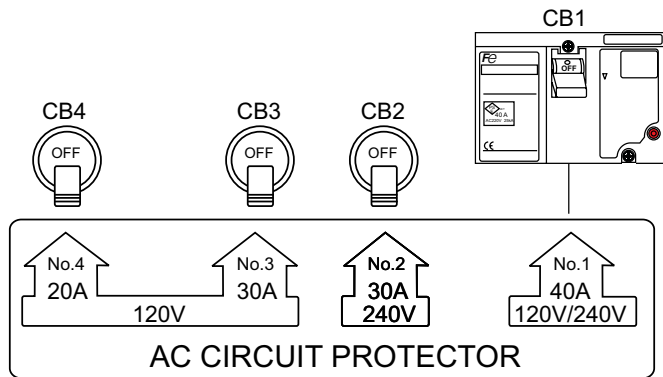

**Figure 48. Circuit Breakers OFF**

2. Place the e-Mode selector switch (Figure 49) in the variable/low position.

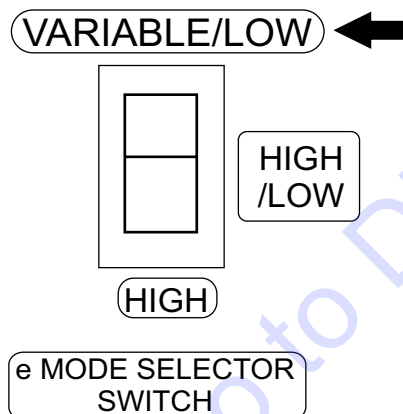

**Figure 49. E-Mode Selector Switch (Variable/Low Position)**

3. Let the engine run at idle speed for 5 minutes.

4. Place the ignition key (Figure 50) in the **STOP** position.

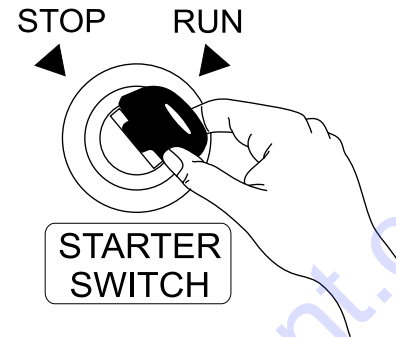

**Figure 50. Ignition Key (STOP Position)**

5. Remove all loads from the generator receptacles.
6. Remove any welding cables attached to the welding terminals.
7. Place the fuel valve lever (Figure 51) in the **OFF** position.

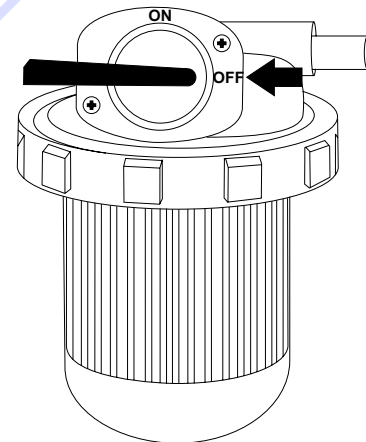

**Figure 51. Fuel Valve Lever (OFF)**

## EMERGENCY SHUTDOWN PROCEDURE

Place the ignition key (Figure 50) in the **STOP** position.

# MAINTENANCE

Table 23. Inspection/Maintenance		10 Hrs DAILY	250 Hrs	500 Hrs or Every 12 Months	3000 Hrs or Every 36 Months	OTHER
<b>Engine</b>	Check Engine Oil and Coolant Levels	X				
	Check Fuel Filter	X				
	Check Air Cleaner/Element	X				
	Clean or Replace Air Cleaner/Element <sup>*4</sup>		X			As Required
	Check for Leaks/Hoses/Clamps	X				
	Check for Loosening of Parts	X				
	Change Engine Oil and Oil Filter * 1		X			
	Clean Unit, Inside and Outside		X			
	Replace Fuel Filter Elements			X		
	Check Engine Mounts			X		
	Service Battery			X		
	Check Air Intake Hoses			X		
	Check Fan Belt Condition			X		
	Check Automatic Belt Tensioner			X		
	Check Electrical Ground Connection			X		
	Clean Radiator, Check Cooling System			X		
	Coolant Solution Analysis, Add SCA's As Required			X		
	Pressure Test Cooling System			X		
	Check Engine Speed			X		
	Test Thermostats				X	
Check and Adjust Engine Valve Clearance					1000 hrs.	
Test Glow Plugs				X		
Flush and Refill Cooling System <sup>*3</sup>					1 yr. or 2000 hrs.	
Clean Inside of Fuel Tank					1000 hrs.	
<b>Generator</b>	Measure Insulation Resistance Over 3M ohms		X			
	Check Rotor Rear Support Bearing			X		

\*1 During initial operation of a new engine, change oil and filter between a minimum of 100 hrs. and a maximum of 250 hrs. Service interval depends on type of oil.

\*2 Perform inspection and maintenance of Urea SCR system every 4500 hours. The system does not need to replace/exchange if no problem is found. Do not make any modification, changes or remove the emission control system and related parts.

\*3 Use fully formulated antifreeze/coolant.

\*4 Replace primary air filter element when restriction indicator shows a vacuum of 625 mm (25 in. H<sub>2</sub>O).



## AIR CLEANER

### NOTICE

If the engine is operating in very **dusty** or **dry** grass conditions, a clogged air cleaner will result. This can lead to a loss of power, excessive carbon buildup in the combustion chamber and high fuel consumption. Change air cleaner more **frequently** if these conditions exist.

Every 250 hours: Remove air cleaner element (Figure 52) and clean the heavy duty paper element with light spray of compressed air. Replace the air cleaner as needed.

This Kubota diesel engine is equipped with a replaceable, high-density paper air cleaner element.

### Primary Air Cleaner Elements

#### CAUTION



Wear protective equipment such as approved safety glasses or face shields and dust masks or respirators when cleaning air filters with compressed air.

1. Release the latches (Figure 52) that secures the cover to the air cleaner body.
2. Remove the air cleaner cover and set aside.
3. Remove both the primary air cleaner element.
4. Check the air cleaner daily or before starting the engine
5. Check for and correct heavy buildup of dirt and debris along with loose or damaged components.

### NOTICE

Operating the engine with loose or damaged air cleaner components could allow unfiltered air into the engine causing premature wear and failure.

6. To clean the primary element (paper air filter) as referenced in (Figure 52), tap the filter element several times on a hard surface to remove dirt, or blow compressed air (not to exceed 30 psi (207 kPa, 2.1 kgf/cm<sup>2</sup>) through the filter element from the inside out.

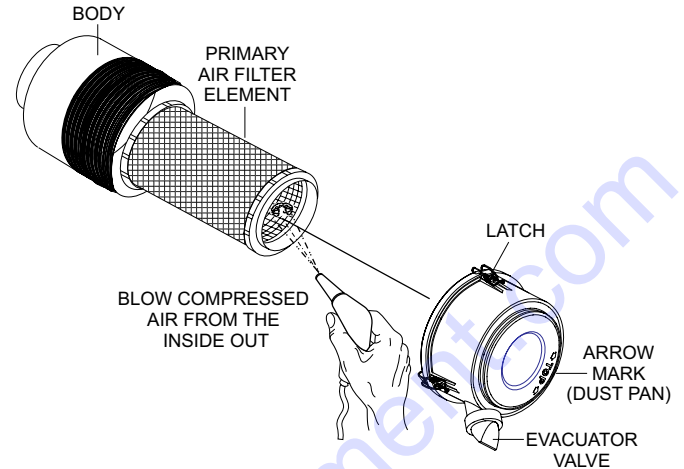

**Figure 52. Air Cleaner**

7. Replace primary air filter elements if it is damaged or excessively dirty.
8. Clean the inside of the air cleaner body.
9. Reinstall the primary air filter element back into air cleaner body.
10. Reinstall the air cleaner cover, and secure with latches.

### NOTICE

**DO NOT** run the engine with the air cleaner removed or without an element.

## ENGINE OIL (CHECK DAILY)

### NOTICE

Contact your country's Department of Public Works or recycling agency in your area and arrange for proper disposal of any electrical components, fuel, oil or waste associated with this equipment.



1. When checking or adding oil, place the welder-generator on a level surface.
2. Pull the engine oil dipstick from its holder.
3. Determine if engine oil is low. Oil level should be between the upper and lower limit (Figure 53) on the dipstick.

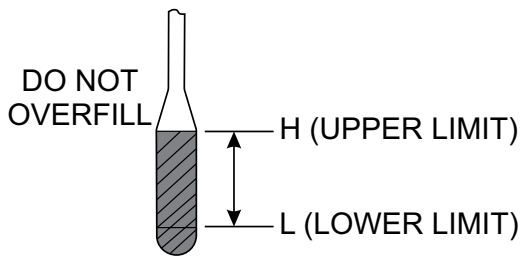

**Figure 53. Dipstick Engine Oil Level**

4. If oil level is low, add correct amount of engine oil to bring oil level to a normal safe level (See Recommended Viscosity Grades, Table 24 and Table 25).

### NOTICE

Refer to Table 25 for the suitable American Petroleum Institute (API) classification of engine oil according to the fuel type used (Low Sulfur, Ultra Low Sulfur or High Sulfur).

**Table 24. Recommended Oil Classification**

Fuel Type	API Classification (Engine Oil)
High Sulfur Fuel 0.05% (500 PPM) ≤ Sulfur Content < 0.50% (5000 PPM)	<b>CF</b> If the <b>CF-4</b> , <b>CG-4</b> , <b>CG-4</b> or <b>CI-4</b> engine oil is used with high sulfur fuel, change the engine oil at shorter intervals (approximately half).
Low Sulfur Fuel Sulfur Content < 0.05% (500 PPM) or Ultra Low Sulfur Fuel Sulfur Content < 0.0015% (15 PPM)	<b>CF, CF-4, CG-4, CH-4 or CI-4</b>

5. Allow enough time for any added oil to make its way to the oil pan before rechecking.

**Table 25. Oil Selection Chart**

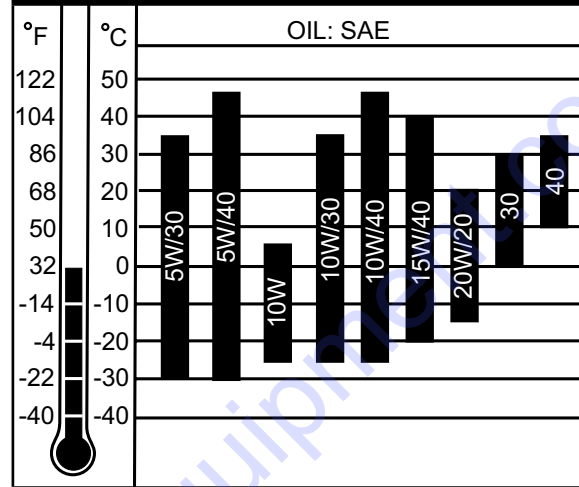

## DRAINING ENGINE OIL

1. Run the engine until the engine coolant reaches a temperature of 140° (60°C) Turn the engine off.
2. Remove the oil dipstick from its holder.
3. Next, remove oil drain bolt and o-ring (Figure 54), then allow the oil to drain into a suitable container.

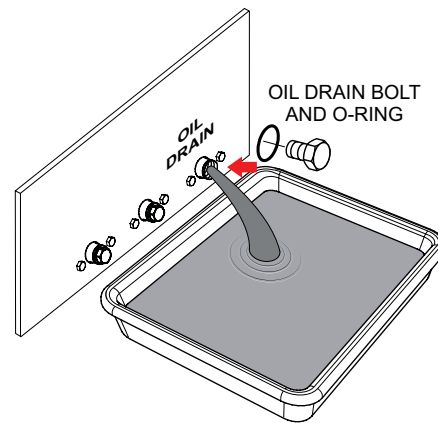

**Figure 54. Draining Engine Oil**

4. After engine oil has been completely drained, reinstall drain bolt with o-ring and tighten securely.

### NOTICE

For composite oil pans always install a **new** o-ring.

## ENGINE OIL FILTER REPLACEMENT

1. Clean the area around the lubricating oil filter head.
2. Using an oil filter wrench (Figure 55), remove engine oil filter.

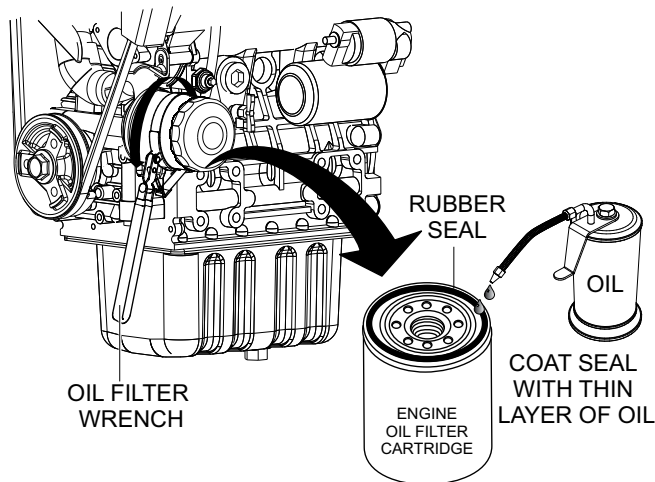

**Figure 55. Engine Oil Filter Removal**

3. Coat the rubber seal (gasket) surface of oil filter (Figure 55) with clean 15W-40 engine oil.
4. Install new oil filter first by hand until it makes contact with the filter head surface. Tighten it another 3/4 turn using the filter wrench.
5. Fill engine crankcase with high quality detergent oil as referenced in Table 25. Fill to the upper limit of dipstick. **DO NOT** overfill. Reference Table 4 for engine crankcase oil capacity.
6. Run the engine for several minutes. Watch for oil leakage. Shut the engine down and allow it to sit for several minutes. Top off the oil to the upper limit on the dipstick.

## DRAINING ENGINE COOLANT

### **WARNING**

**DO NOT** remove the pressure cap from the radiator when the engine is hot! Wait until the coolant temperature is below 120°F (50°C) before removing pressure cap.

Heated coolant spray or steam can cause severe scalding and personal injury.

1. Remove the radiator pressure cap (Figure 56) only if the coolant temperature is below 120°F (50°C).

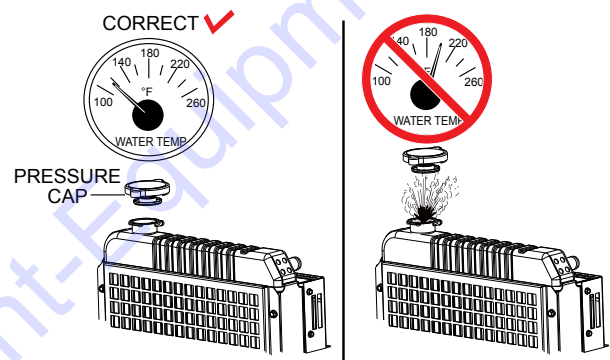

**Figure 56. Radiator Pressure Cap Removal**

2. Remove the coolant drain bolt and o-ring (Figure 57), then allow the coolant to drain into a suitable container.

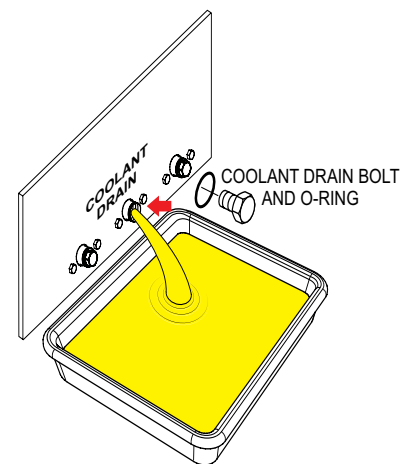

**Figure 57. Draining Radiator Coolant**

3. Check hoses for softening and kinks. Check clamps for signs of leakage.
4. Remove and inspect radiator cap.

## FLUSHING OUT RADIATOR AND REPLACING COOLANT

### WARNING



**DO NOT** remove the pressure cap from the radiator when the engine is hot! Wait until the coolant temperature is below 120°F (50°C) before removing pressure cap.

Heated coolant spray or steam can cause severe scalding and personal injury.

1. Remove radiator cap.
2. Remove the coolant drain bolt and o-ring (Figure 57), then allow the coolant to drain into a suitable container
3. If equipped, remove the overflow tank. Drain and clean overflow tank.
4. Replace the overflow tank if necessary.
5. Check hoses for softening and kinks. Check clamps for signs of leakage.
6. Flush the radiator by running clean tap water through radiator until signs of rust and dirt are removed. **DO NOT** clean radiator core with any objects, such as a screwdriver.
7. Replace with coolant as recommended by the engine manufacturer. Reference Table 4 for coolant capacity.
8. Reinstall coolant drain bolt with o-ring and tighten securely.

## COOLANT (ANTIFREEZE/SUMMER COOLANT/WATER)

Kubota recommends antifreeze/summer coolant for use in their engines, which can be purchased in concentrate (and mixed with 50% demineralized water) or pre-diluted. See the **Kubota Operation and Maintenance Manual** for further details.

### WARNING



If adding coolant/antifreeze mix to the radiator, **DO NOT** remove the radiator cap until the unit has completely cooled. The possibility of **hot!** coolant exists which can cause severe burns.

Day-to-day addition of coolant is done via the radiator. When adding coolant to the radiator, **DO NOT** remove the radiator pressure cap until the unit has completely cooled. Reference Table 4 for coolant capacity.

## OPERATION IN FREEZING WEATHER

When operating in freezing weather, be certain the proper amount of antifreeze has been added as referenced in Table 26.

**Table 26. Anti-Freeze Operating Temperatures**

Vol % Anti-Freeze	Freezing Point		Boiling Point	
	°C	°F	°C	°F
50	-37	-34	108	226

## RADIATOR CLEANING

The radiator (Figure 58) should be sprayed (cleaned) with a high pressure washer when excessive amounts of dirt and debris have accumulated on the cooling fins or tube. When using a high pressure washer, stand at least 5 feet (1.5 meters) away from the radiator to prevent damage to the fins and tube.

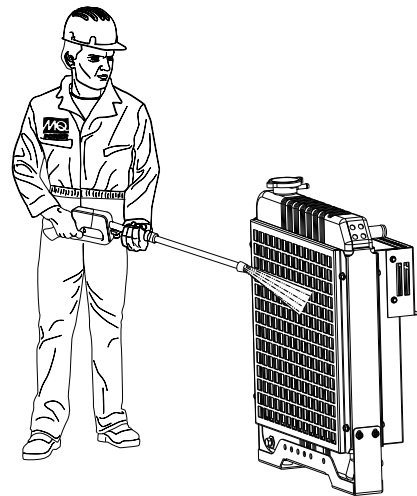

**Figure 58. Radiator Cleaning**

## Removing Water from the Fuel Tank

1. After prolonged use, water and other impurities accumulate in the bottom of the tank. Occasionally inspect the fuel tank for water contamination.
2. If water contamination is present within the fuel tank, remove the fuel tank drain bolt and o-ring (Figure 59), then allow the fuel to drain into a suitable container.

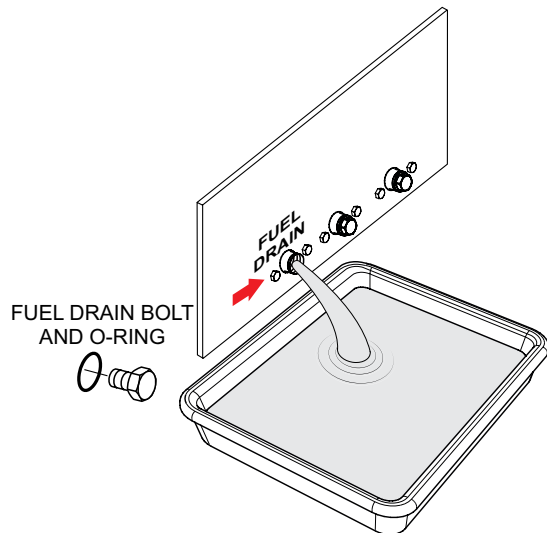
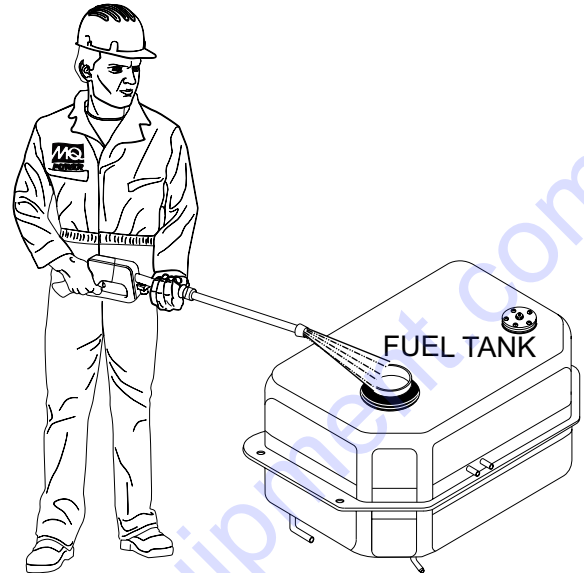

**Figure 59. Draining Fuel Tank**

3. During cold weather, the more empty volume inside the tank, the easier it is for water to condense. This can be reduced by keeping the tank full with diesel fuel.

## CLEANING INSIDE THE FUEL TANK

1. If necessary, drain the fuel inside the fuel tank completely. Using a spray washer (Figure 60) wash out any deposits or debris that have accumulated inside the fuel tank.



**Figure 60. Fuel Tank Cleaning**

2. Reinstall fuel tank drain bolt with o-ring and tighten securely.

## FUEL TANK INSPECTION

In addition to cleaning the fuel tank, the following components should be inspected for wear:

- **Fuel Hoses** — inspect nylon and rubber hoses for signs of wear, deterioration and hardening.
- **Fuel Tank Lining** — inspect the fuel tank lining for signs of excessive amounts of oil or other foreign matter.

## CLEANING FUEL FILTER BOWL

**Every 100 hours:** Clean fuel filter every 100 hours of operation or once a month to remove dust or water.

1. Place fuel valve lever (Figure 61) in the **CLOSED** position.

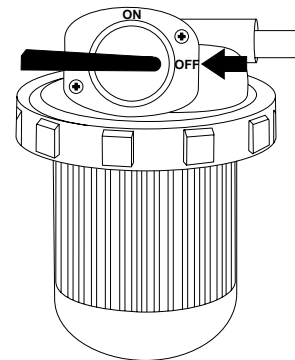

**Figure 61. Fuel Valve Lever (CLOSED)**

2. Unscrew the filter bowl (Figure 62) from the fuel filter head.

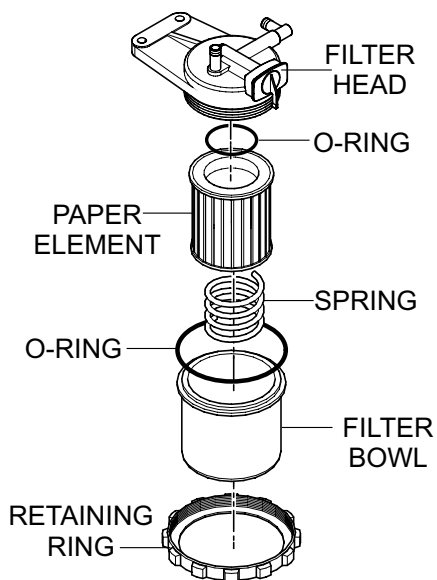

**Figure 62. Fuel Filter Disassembly**

3. Wipe the inside of the fuel filter bowl with a clean cloth to remove any foreign matter or debris that may have accumulated. Rinse with diesel fuel.
4. Remove fuel filter paper element, and rinse with diesel fuel.
5. Reinstall filter bowl and paper element back onto the filter head. Hand-tighten retaining ring.

## REPLACING FUEL FILTER ELEMENT

**First 50 And Then Every 200 hours:** Replace fuel filter element.

1. Unscrew the filter bowl from the fuel filter head (Figure 62).
2. Remove fuel filter paper element and replace with a new one.
3. Replace o-ring and coat with a small amount of clean 15W-40 engine oil.
4. Insert the new fuel filter element into the filter bowl.
5. Reinstall filter bowl first by hand until it makes contact with the fuel filter head surface. Hand-tighten only.
6. Remove the air from the fuel system. Reference the Kubota Operation and Maintenance Manual, "Bleeding the Fuel System".

## AUTOMATIC AIR BLEEDING DEVICE

When the engine stops due to running out of fuel, take off the fuel filter or fuel piping and re-start the machine in accordance with the following instructions.

1. Refuel the fuel tank and place the fuel valve in the **OPEN** position.
2. Place the starter switch key in the **START** position. When the engine starter engages, the automatic air vent device will expel the air inside the fuel system.
3. After 10 to 20 seconds of turning the engine over, the automatic air vent device would have expelled all the air out of the fuel system. At this point, the engine will be able to start.

### NOTICE

If air enters the fuel injection system of a diesel engine, starting becomes impossible. After running out of fuel, or after disassembling the fuel system, bleed the system. Reference the **Kubota Operation and Maintenance Manual** for details.

## STOPPING ENGINE (STARTER SWITCH FAILURE)

In the event the engine continues to run even after the starter switch has been placed in the **STOP** position, following the procedure on the next column to turn off the engine.

1. Place fuel valve lever (Figure 61) in the **CLOSED** position.
2. Place engine stop lever (Figure 63) in the **STOP** position. Continue pushing stop lever until the engine has completely stopped.

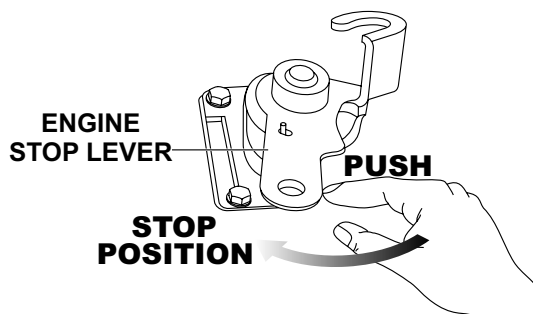

**Figure 63. Engine Stop Lever**

## V-BELT

Visually examine the V-belt (Figure 64) and determine if it is full of tiny cracks, frayed, has pieces of rubber missing, is peeling or otherwise damaged.

Also, examine the belt and determine if it is **oil soaked** or "**glazed**" (hard shiny appearance on the sides of the belt). Either of these two conditions can cause the belt to run hot, which can weaken it and increase the danger of it breaking.

If the V-belt exhibits any of the above wear conditions replace the V-belt immediately.

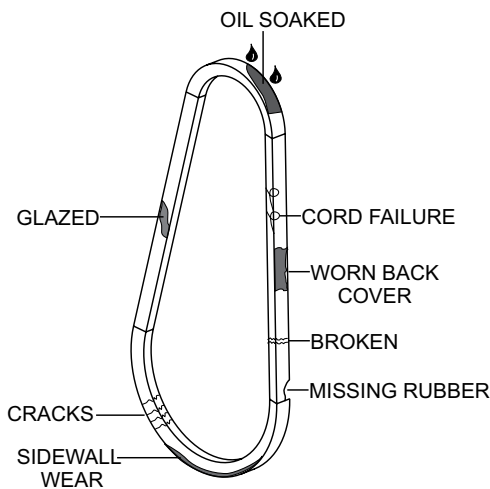
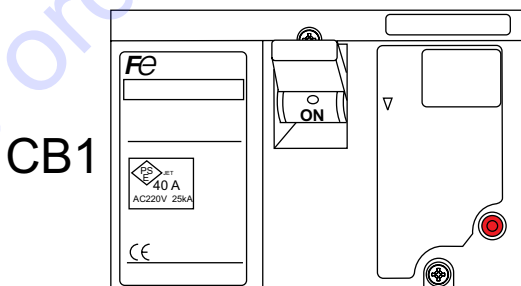

**Figure 64. V-Belt Inspection**

## TESTING THE GFCI SENSING MODULE

If tripping of the **main** circuit breaker persists after a load is replaced with a known good one (no short circuit), perform this test with no load.

1. Start the welder-generator as outlined in the start up procedure in this manual.
2. Place the main circuit breaker, CB1 (Figure 65) in the **ON** position.



**Figure 65. Main Circuit Breaker ON (GFCI Test)**

3. On the GFCI sensing module (Figure 66), verify that the **green** POWER LED is **ON**.

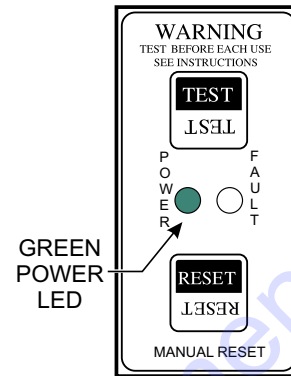

**Figure 66. GFCI Sensing Module (Green LED ON)**

4. Also verify that the AC voltmeter is registering a voltage reading as indicated by Figure 71.
5. Next, press the **TEST** button on the GFCI module (Figure 67) and verify that the **green** POWER LED turns **OFF** and the **red** FAULT LED turns **ON**.

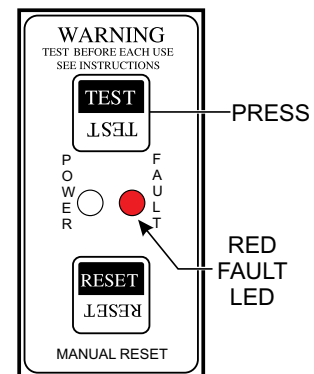

**Figure 67. GFCI Sensing Module (Red/Fault LED ON)**

6. Also verify that the main circuit breaker (Figure 68) switch trips to the **OFF** position.

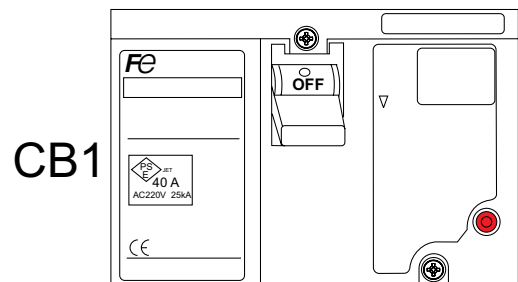

**Figure 68. Circuit Breaker OFF (GFCI Test)**

- Verify that the AC voltmeter (Figure 69) on the welder-generator reads zero volts.

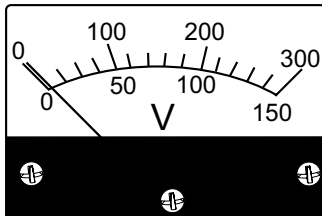

**Figure 69. AC Voltmeter (Zero Volts)**

- To restore power, press the RESET button (Figure 70) on the GFCI module and verify that the **red** FAULT LED turns **OFF** and the green POWER LED should turn **ON**.

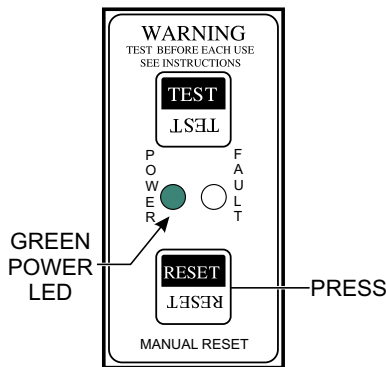

**Figure 70. GFCI Sensing Module (Green LED ON Reset)**

- Verify that the AC voltmeter is registering a voltage reading as indicated by Figure 71.

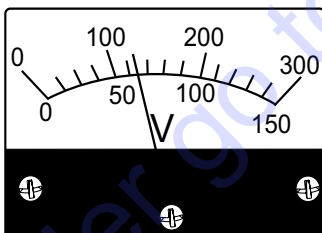

**Figure 71. AC Voltmeter (120/240V)**

## NOTICE

It is recommended that the GFCI sensing module be tested when the welder-generator is initially uncrated. Then, the module should be tested daily at startup.

## CAUTION

The GFCI module is designed to interrupt power when a ground fault exists to prevent injuries and shock hazards. **DO NOT** operate the welder-generator if this test fails. Consult a qualified electrician for repair or replacement of the GFCI module.

## TESTING THE GFCI RECEPTACLE

If tripping of the **GFCI** receptacle persists after a load is replaced with a known good one (no short circuit), perform this test at least once a month.

- Start the welder-generator as outlined in the start up procedure in this manual.
- Place the GFCI circuit breaker, CB4 (Figure 72) in the **ON** position.

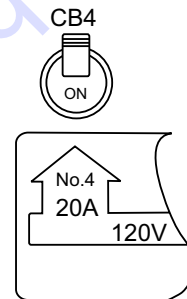

**Figure 72. GFCI Circuit Breaker ON**

- Verify green LED on the GFCI receptacle (Figure 73) is **ON**.
- Plug a power tool into the GFCI receptacle such as an electric drill. Squeeze the ON/OFF switch on the drill and verify that the drill turns on.

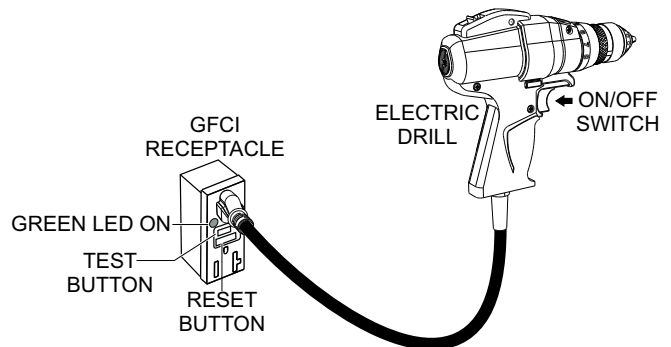

**Figure 73. GFCI Receptacle Test**



5. Continue holding down the ON/OFF switch on the drill and at the same time press the **TEST** button on the GFCI receptacle.
  6. Verify that the drill turns off when the **TEST** button was pressed.
  7. If the drill motor continues to run after the **TEST** button was pressed then it can be determined that the GFCI receptacle is not working properly and should be replaced.
  8. Press the **RESET** button to restore power to the GFCI receptacle.
2. In addition, the battery charge, oil pressure and water temperature alarms will be displayed on the engine warning display (Figure 75).

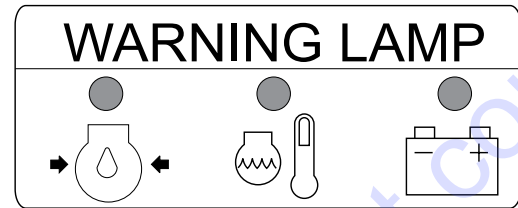

**Figure 75. Engine Warning Lamps**

3. Reference Table 27 for protection device error codes.

## PROTECTION DEVICES

### NOTICE

Low oil pressure, high coolant temperature, high engine speed and battery charge are considered major protection parameters and will cause the engine to shutdown.

1. This unit is equipped with **protection** devices. When any of the **major** protection devices are activated, the engine will **automatically stop** and the error code message will be displayed on the DC welding current meter (Figure 74).

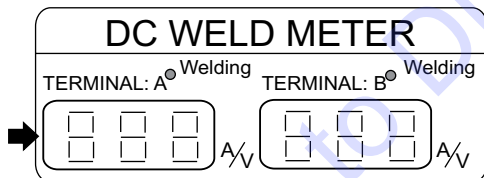

**Figure 74. DC Weld Meter Error Codes**

## GENERATOR SIDE

If the power transistor (PTR), insulated-gate bipolar transistor (IGBT) on the welding side become abnormally hot, a protective error code will be displayed on the DC welding current meter. This condition will cause the welding to stop, but will not shutdown the engine.

An error code of E10 will be displayed on the terminal A side, while an error code of E20 will be displayed on the terminal B side.

The cause of these two error codes (E10/E20) is due to an overload condition on the welding side (duty cycle over the limit) or insufficient cooling due to an open cabinet door or blocked air intake. Take corrective action on these conditions and welding will resume when the PTR (IGBT) cools down.

## FUSES

The engine wiring system has its own fuses (F2 and F5). If either of these fuses are blown, check the wiring to determine if an electrical short circuit exists. Correct the problem before installing new fuses.

# GENERATOR WIRING DIAGRAM (S/N573486 AND BELOW)

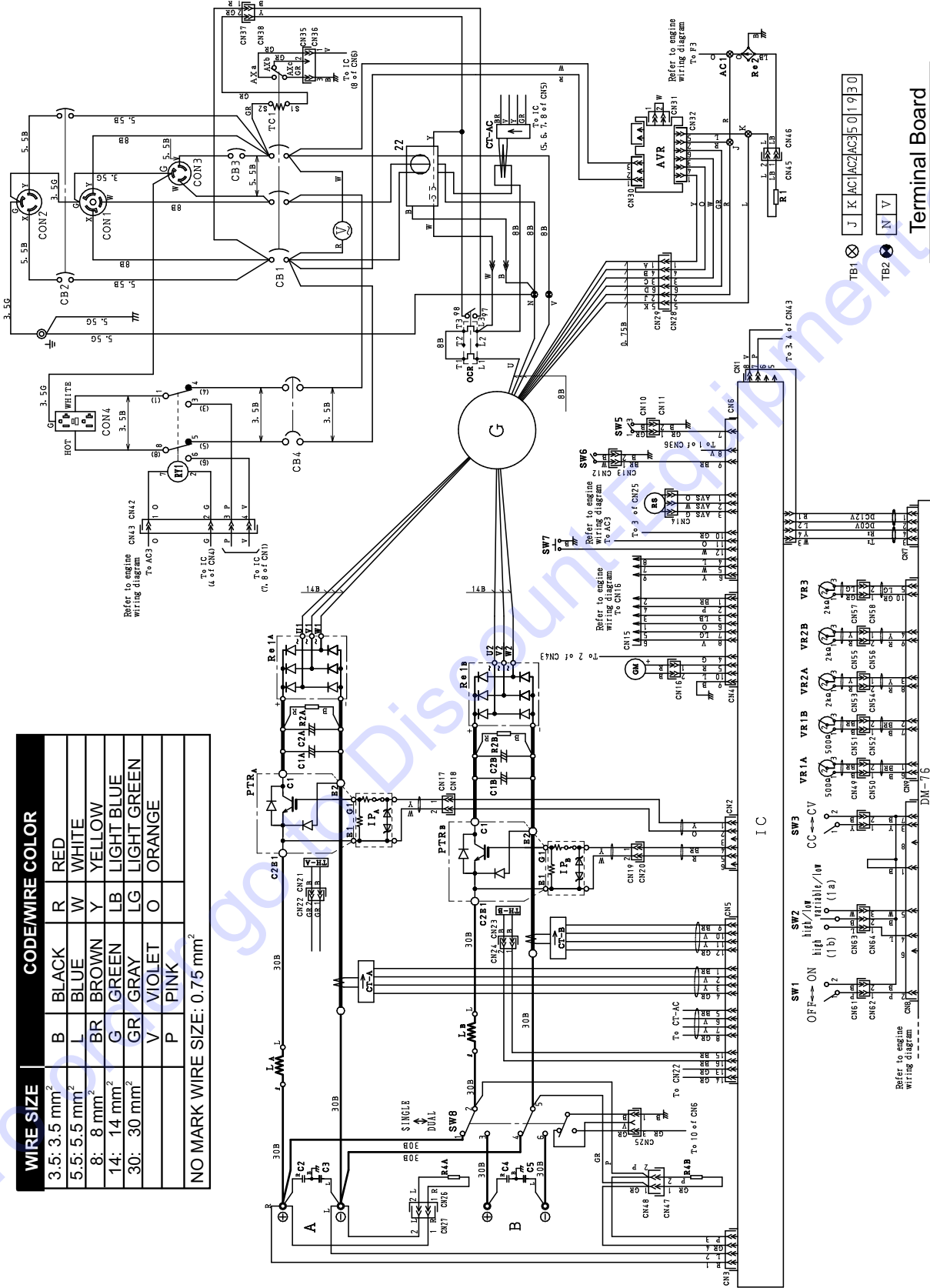

WIRE SIZE	CODE	WIRE COLOR
3.5: 3.5 mm <sup>2</sup>	B	BLACK
3.5: 3.5 mm <sup>2</sup>	R	RED
5.5: 5.5 mm <sup>2</sup>	L	BLUE
5.5: 5.5 mm <sup>2</sup>	W	WHITE
8: 8 mm <sup>2</sup>	BR	BROWN
8: 8 mm <sup>2</sup>	Y	YELLOW
14: 14 mm <sup>2</sup>	G	GREEN
14: 14 mm <sup>2</sup>	LB	LIGHT BLUE
30: 30 mm <sup>2</sup>	GR	GRAY
30: 30 mm <sup>2</sup>	LG	LIGHT GREEN
30: 30 mm <sup>2</sup>	V	VIOLET
30: 30 mm <sup>2</sup>	O	ORANGE
30: 30 mm <sup>2</sup>	P	PINK

NO MARK WIRE SIZE: 0.75 mm<sup>2</sup>

Terminal Board  
(With Engine Side)

J K AC AC AC AC 5 0 1 9 3 0

N V

TB1 TB2

# GENERATOR WIRING DIAGRAM (S/N573486 AND BELOW)

## CONNECTOR REFERENCE DESIGNATORS

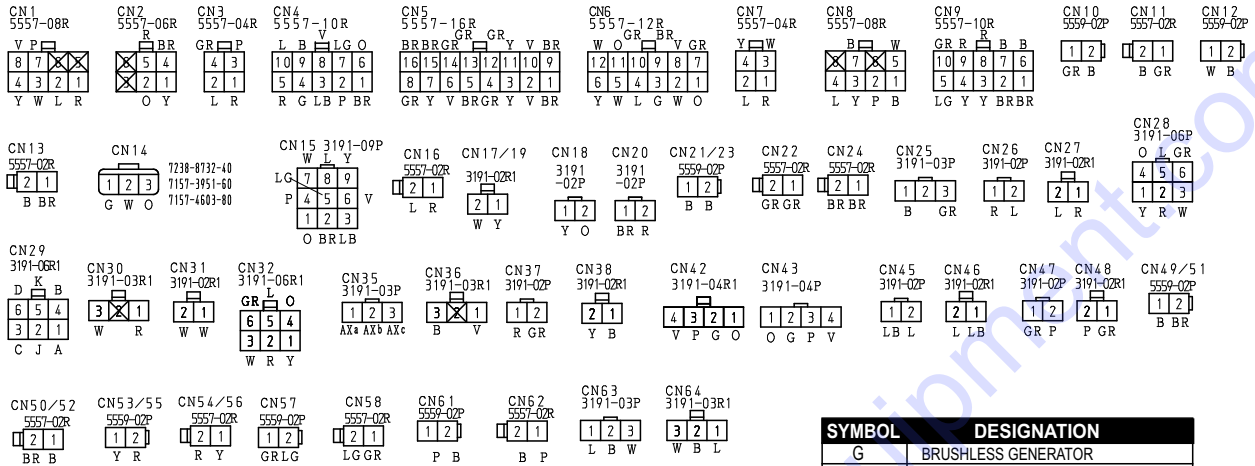

### CONNECTOR ARRANGEMENT (VIEW FROM WIRING SIDE)

SYMBOL	DESIGNATION
G	BRUSHLESS GENERATOR
CB1	CIRCUIT BREAKER, 3P 40A
CB2	CIRCUIT BREAKER, 2P 30A
CB3	CIRCUIT BREAKER, 1P 30A
CB4	CIRCUIT BREAKER, 2P 20A
CON 1	RECEPTACLE, CS6369, 250 VAC@ 50 AMPS
CON 2	RECEPTACLE, L6-30R, 250 VAC@ 30 AMPS
CON 3	RECEPTACLE, L5-30R, 125 VAC@ 30 AMPS
CON 4	RECEPTACLE, GFCI 5-20R, 125 VAC @ 20 AMPS
V	AC. VOLTMETER
TB1 ⊗	TERMINAL BOARD
⊕ ⊖	DC WELDING TERMINAL
L, A, B	DC REACTOR
IC	CONTROL UNIT, TRANSISTOR (IGBT)
IP, A, B	PROTECTOR TRANSISTOR (IGBT)
CT-A, B	CURRENT TRANSFORMER
CT-AC	CURRENT TRANSFORMER
PTR, A, B	IGBT
Re1, A, B	RECTIFIER
C1, 2, A, B	CONDENSER
THA, B	THERMOSTAT
Re2	RECTIFIER
DM-76	DIGITAL PANEL
AVR	AUTOMATIC VOLTAGE REGULATOR
C2-5	CONDENSER
VR1, A, B	CURRENT/VOLTAGE REGULATOR
VR2, A, B	WELDING REGULATION
VR3	TIME REGULATOR
SW1	IDLE STOP SELECTOR SWITCH
SW2	E-MODE SELECTOR SWITCH
SW3	WELDING MODE SELECTOR SWITCH
SW5	DOOR SWITCH
SW6	LIMIT SWITCH
SW7	ENGINE START PUSHBUTTON SWITCH
SW8	SINGLE-DUAL SELECTOR SWITCH
RS	ROTATION SENSOR
GM	GEARED MOTOR
R1	RESISTOR
R2, A, B	RESISTOR
R4, A, B	RESISTOR
RY1	RELAY
	SOCKET
OCR	OVER CURRENT RELAY
⊥	TERMINAL BOARD
TB2 ⊕	GROUND TERMINAL FOR GFCI
22	GFCI SENSING MODULE

# GENERATOR WIRING DIAGRAM (S/N573487 AND ABOVE)

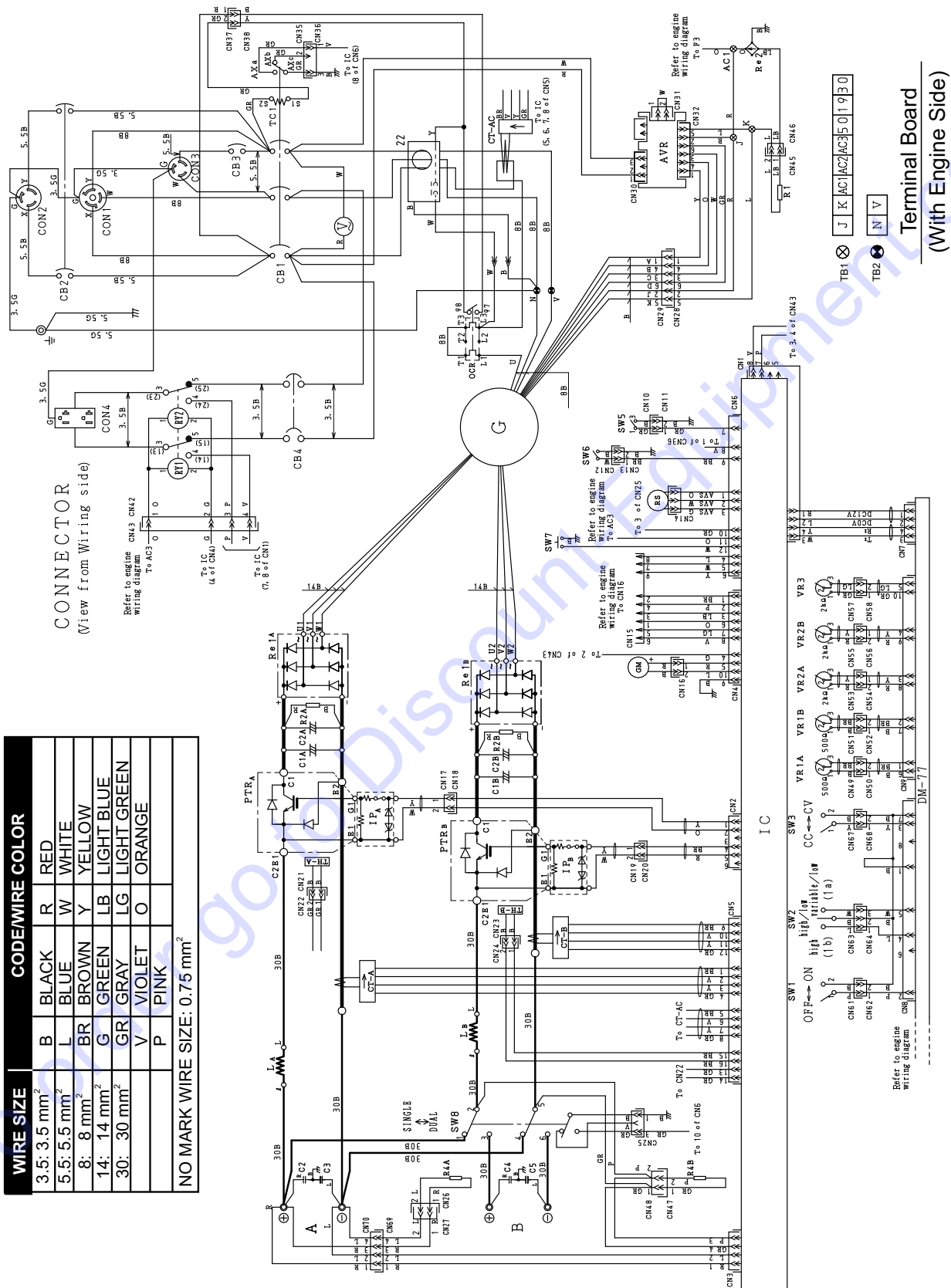

WIRE SIZE	CODE/WIRE COLOR			
3.5: 3.5 mm <sup>2</sup>	B	BLACK	R	RED
5.5: 5.5 mm <sup>2</sup>	L	BLUE	W	WHITE
8: 8 mm <sup>2</sup>	BR	BROWN	Y	YELLOW
14: 14 mm <sup>2</sup>	G	GREEN	LB	LIGHT BLUE
30: 30 mm <sup>2</sup>	GR	GRAY	LG	LIGHT GREEN
	V	VIOLET	O	ORANGE
	P	PINK		

NO MARK WIRE SIZE: 0.75 mm<sup>2</sup>

# GENERATOR WIRING DIAGRAM (S/N573487 AND ABOVE)

## CONNECTOR REFERENCE DESIGNATORS

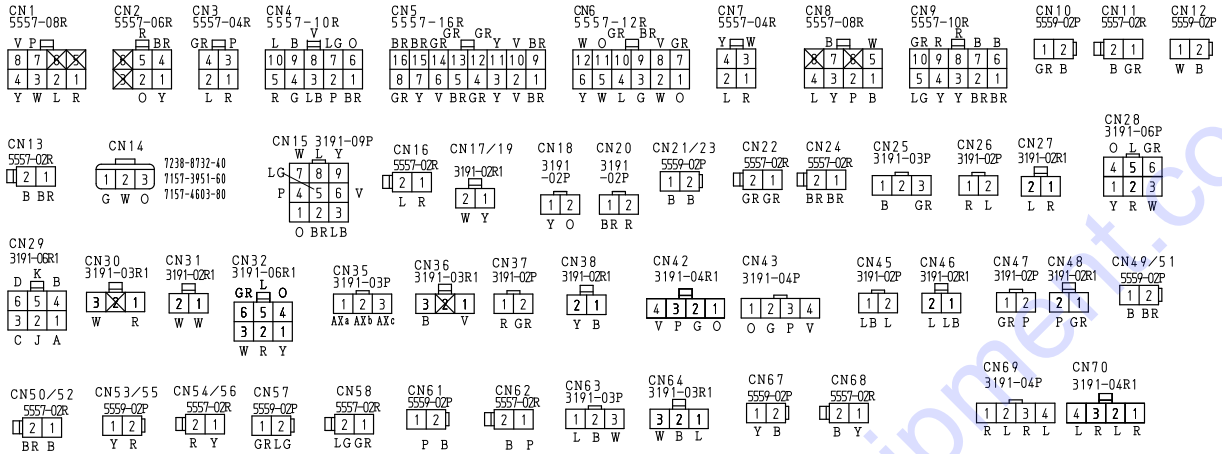

### CONNECTOR ARRANGEMENT (VIEW FROM WIRING SIDE)

SYMBOL	DESIGNATION
G	BRUSHLESS GENERATOR
CB1	CIRCUIT BREAKER, 3P 40A
CB2	CIRCUIT BREAKER, 2P 30A
CB3	CIRCUIT BREAKER, 1P 30A
CB4	CIRCUIT BREAKER, 2P 20A
CON 1	RECEPTACLE, CS6369, 250 VAC@ 50 AMPS
CON 2	RECEPTACLE, L6-30R, 250 VAC@ 30 AMPS
CON 3	RECEPTACLE, L5-30R, 125 VAC@ 30 AMPS
CON 4	RECEPTACLE, GFCI 5-20R, 125 VAC @ 20 AMPS
V	AC VOLTMETER
TB1	TERMINAL BOARD
⊕ ⊖	DC WELDING TERMINAL
L, A, B	DC REACTOR
IC	CONTROL UNIT, TRANSISTOR (IGBT)
IP, A, B	PROTECTOR TRANSISTOR (IGBT)
CT-A, B	CURRENT TRANSFORMER
CT-AC	CURRENT TRANSFORMER
PTR A, B	IGBT
Re1 A, B	RECTIFIER
C1, 2 A, B	CONDENSER
THA, B	THERMOSTAT
Re2	RECTIFIER
DM-77	DIGITAL PANEL
AVR	AUTOMATIC VOLTAGE REGULATOR
C2-5	CONDENSER
VR1 A, B	CURRENT/VOLTAGE REGULATOR
VR2 A, B	WELDING REGULATION
VR3	TIME REGULATOR
SW1	IDLE STOP SELECTOR SWITCH
SW2	E-MODE SELECTOR SWITCH
SW3	WELDING MODE SELECTOR SWITCH
SW5	DOOR SWITCH
SW6	LIMIT SWITCH
SW7	ENGINE START PUSHBUTTON SWITCH
SW8	SINGLE-DUAL SELECTOR SWITCH
RS	ROTATION SENSOR
GM	GEARED MOTOR
R1	RESISTOR
R2 A, B	RESISTOR
R4 A, B	RESISTOR
RY1, 2	RELAY SOCKET
OCR	OVER CURRENT RELAY
⊥	TERMINAL BOARD
TB2	GROUND TERMINAL FOR GFCI
22	GFCI SENSING MODULE

# ENGINE WIRING DIAGRAM

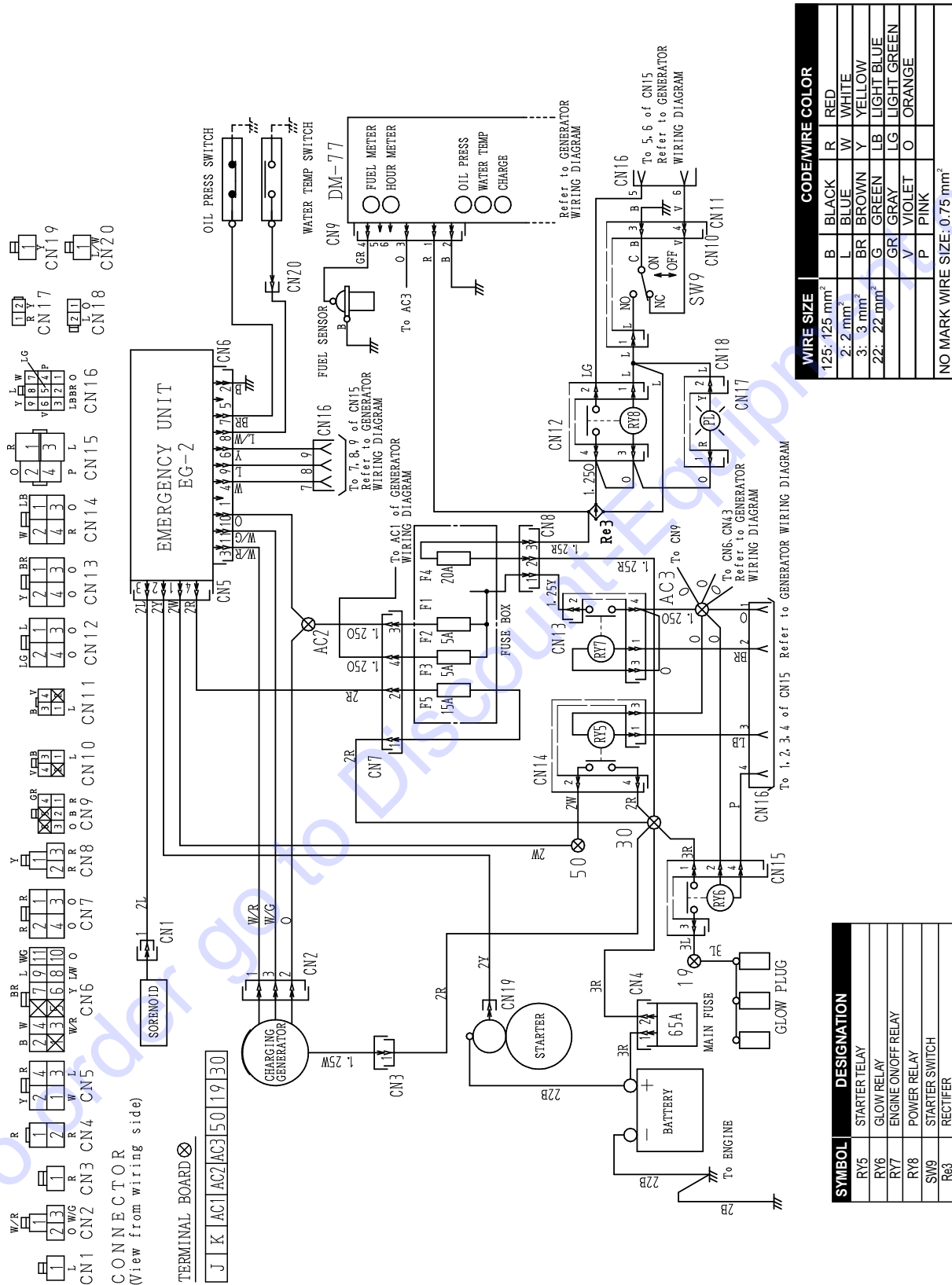

# WELDER-GENERATOR — ERROR CODES

**Table 27. Error Codes**

Error Code <sup>[1]</sup>	Error Details	Corrective Action
E01	Low Lubricating Oil Pressure, below 0.98 MPa (Engine Shutdown/Warning Lamp ON)	<ul style="list-style-type: none"> <li>• Check oil level.</li> <li>• Check oil pressure.</li> </ul>
E02	High Jacket Water Temp., > (239 °F) 115° C (Engine Shutdown/Warning Lamp ON)	<ul style="list-style-type: none"> <li>• Check coolant level (after machine has cooled down).</li> <li>• Check air breathing and exhaust vents are not clogged.</li> <li>• Check for thermal effect of any other machines.</li> </ul>
E03	Insufficient Charge (Engine Shutdown/Warning Lamp ON)	<ul style="list-style-type: none"> <li>• If engine is stopped due to lack of fuel or clogged filters, error code E03 will be indicated, although no insufficient charge condition exists. (E01 may be indicated due to decision timing of engine emergency circuit).</li> <li>• Battery not charged, loose battery connections.</li> <li>• Fan belt loose or broken.</li> </ul>
E04	Engine Over-Speed (Engine Shutdown)	<ul style="list-style-type: none"> <li>• Engine speed too high, &gt; 4140 rpm's. Reduce speed.</li> </ul>
E06	Starting Failure Engine Shutdown	<ul style="list-style-type: none"> <li>• Add fuel to engine. Set fuel cock to <b>ON</b></li> <li>• Inspect fuel tank and fuel filter for water or deposits.</li> <li>• Check battery liquid level and charging level.</li> <li>• Inspect fan belt for looseness.</li> <li>• Check fuses F2 and F5.</li> </ul>
E10	A-Side PTR (IGBT) Overheat (Welding Shutdown/Self Recovery)	<ul style="list-style-type: none"> <li>• Check air breathing and exhaust vents are not clogged.</li> <li>• Check for thermal effect of any other machines.</li> <li>• Make sure side door is closed before operation.</li> </ul>
E13	A-Side Welding Overcurrent	<ul style="list-style-type: none"> <li>• Allow for proper duty cycle. Reference Table 7.</li> </ul>
E16	A-Side Current/Voltage Regulator Error	<ul style="list-style-type: none"> <li>• Inspect regulator movement and connections.</li> </ul>
E17	A-Side Welding Regulator Error	<ul style="list-style-type: none"> <li>• Inspect, remove and test regulator for proper resistance.</li> </ul>
E20	B-Side PTR (IGBT) Overheat (Welding Shutdown/Self Recovery)	<ul style="list-style-type: none"> <li>• Check air and exhaust vents are not clogged.</li> <li>• Check for thermal effect of any other machines.</li> <li>• Make sure side door is closed before operation.</li> </ul>
E23	B-Side Welding Overcurrent	<ul style="list-style-type: none"> <li>• Allow for proper duty cycle. Reference Table 7.</li> </ul>
E26	B-Side Current/Voltage Regulator	<ul style="list-style-type: none"> <li>• Inspect regulator movement and connections.</li> </ul>
E27	B-Side Welding Regulator Error	<ul style="list-style-type: none"> <li>• Inspect, remove and test regulator for proper resistance.</li> </ul>
E30	Idling Stop Regulator Error	<ul style="list-style-type: none"> <li>• Inspect regulator movement and connections.</li> </ul>
E33	Communication Error (Receiving Error At Display Board)	<ul style="list-style-type: none"> <li>• Inspect intergrated circuit (IC) and digital meter (DM) board connections.</li> </ul>
E34	Communication Error (Receiving Error At Control Board)	<ul style="list-style-type: none"> <li>• Inspect intergrated circuit (IC) and control board (CB) connections.</li> </ul>
IdS (blinking)	Idling Stop Function Disabled	<ul style="list-style-type: none"> <li>• Check idle stop monitor status LED's</li> </ul>
<p>[1] : An error condition displayed with an asterisk (*) cannot always be corrected via simple inspection. Please contact Discount-equipment for assistance.</p>		

# WELDER-GENERATOR — TROUBLESHOOTING

**Table 28. Troubleshooting (Welder-Generator)**

Symptom	Possible Problem	Solution
Starter switch is set to <b>RUN</b> but engine does not start.	Engine Start button has not been pushed?	Push Engine Start button.
" <b>IdS</b> " is indicated on welding current meter display.	Welding preset time (1–30 minutes) has been reached when using the idle stop function?	Restart engine from idle stop in any of the restarting methods, or set the starter switch to <b>STOP</b> once, then to <b>RUN</b> again and push the Engine Start button to start the engine.
No indication appears on welding current meter display though Starter switch is set to <b>RUN</b> . (Restart from idle stop is not possible.)	As engine has not been operated for 3 hours, automatic control power cut function is working?	If Engine Start button is not pushed while Starter switch remains at <b>RUN</b> position, or if idle stop state continues 2 hours or more, control power will automatically be cut off. (Operation lamp lights to remind operator to set to <b>OFF</b> .)  When restarting engine, set the Starter switch to <b>STOP</b> once, then to <b>RUN</b> again and push the Engine Start button.
Idle stop function does not operate. (Main CB indicator lamp on idle stop monitor is <b>ON</b> .)	Idle Stop switch is set to <b>OFF</b> ?	Set Idle Stop switch to the <b>ON</b> position to enable the idle stop function.
	Idle stop preset time has not elapsed?	Idle stop is made after preset time elapses following a pause in work with welding power or output receptacle power (120V GFCI).  Welding indicator lamp on welding current meter lights while welding work is performed. AC Load lamp on idle stop monitor lights when AC power is used.
	Charging time for battery is secured?	Just after engine start, idle stop is not made to charge battery. During charging time, Restart Charge lamp on idle stop monitor lights to indicate automatic stop is limited. Stop limit time varies with time idle stop is operated.
	Main AC circuit breaker (CB1) is set to the <b>ON</b> position?	Place Main AC circuit breaker (CB1) to the <b>OFF</b> position.



# WELDER-GENERATOR — TROUBLESHOOTING (CONT.)

**Table 29. Troubleshooting (Welder-Generator)**

Symptom	Possible Problem	Solution
Engine cannot be restarted from idle stop.	Idle Stop switch is set to <b>OFF</b> ?	Make sure Idle Stop switch is in the <b>ON</b> position, then push the Engine Start button to start engine.
	Short-circuit and release between welding material and welding electrode cannot be detected twice or more?	If welding electrode and surface of welding material conduct current poorly due to rust or coating, or if welding electrode is continuously short-circuited by pressing it onto welding material, or if tapping intervals are too short or too long, voltage varying signal for restart may not be detected.  “ <b>IdS</b> ” indication blinks on the welding current meter while welding electrode is being short-circuited.)
Engine cannot be restarted from idle stop. (“ <b>IdS</b> ” and preset current value are indicated alternately on welding current meter and indicator lamp on idle stop monitor is blinking.)	Main circuit breaker (CB1) and auxiliary AC circuit breakers (CB2, CB3 and CB4) are set to the <b>ON</b> position?	Place all circuit breakers to <b>OFF</b> position. AC Load lamp on idle stop monitor blinks if AC auxiliary circuit breakers are <b>ON</b> .
	Side door open?	Close side door. Side Door Open lamp on idle stop monitor blinks if side door is open.
	ON/OFF power switch from load (power tool) connected to 120V GFCI receptacle cannot be detected twice or more?	If power switch of the load connected to output receptacle remains <b>ON</b> , AC Load lamp on idle stop monitor blinks to prevent restart for safety. Set switch to <b>ON</b> then <b>OFF</b> twice or more and wait with switch in <b>OFF</b> position until engine restarts.
Engine RPM fluctuates higher or lower during welding.	Automatic control of engine revolutions responding to welding output and preset frequency of AC power in use is functioning?	If E-mode switch is set to Variable/Low position, engine revolutions are controlled based on preset value of welding current. Engine revolutions are adjusted up or down to meet total output for 2 operators.  If AC power is used by 2 persons simultaneously, engine will operate at high speed because preset AC frequency is outputted.
	Semiconductor is overheated?	If the side-door is open or exhaust vents are clogged, causing insufficient cooling; if semiconductors are heated at an over-duty rate, output is limited to prevent such overheating.
AC power is not available.	AC circuit breakers are not set to <b>ON</b> ?	Place all circuit breakers CB1, CB2, CB3, and CB4 to the <b>ON</b> position.

# WELDER-GENERATOR — TROUBLESHOOTING (CONT.)

**Table 27. Troubleshooting (Welder-Generator)**

Symptom	Possible Problem	Solution
Welding current does not match preset value.	Welding regulator is turned clockwise from constant current position for welding?	<p>Adjust welding regulator to position at which customer's welding work is easy. Constant current position is adjusted to preset current value, but if welding regulator is set to any other position, drooping characteristic appears.</p> <p>Welding current may drop depending upon diameter and length of welding cable and may also vary depending upon type, thickness, and arc length of welding electrode. (Current variation is larger as welding regulator is turned further clockwise.)</p> <p>Consider indicated preset current value as standard at any position other than constant current position.</p>
	Rotation speed of engine is low due to overload or being out of condition?	<p>When welding at maximum output, output may be limited by overload if welding cable diameter is too thin or welding cable length is too long. Use cable within recommended range for welding work.</p> <p>If total output is overloaded when using AC power and welding simultaneously, output will be limited. Be careful not to cause an overload.</p>
	Semiconductor is overheated?	<p>If the side-door is open or exhaust vents are clogged, causing insufficient cooling; if semiconductors are heated at an over-duty rate, output is limited to prevent such overheating.</p>

**TO PURCHASE THIS PRODUCT PLEASE CONTACT US**



**Equipment Financing and  
Extended Warranties Available**



**Discount-Equipment.com is your online resource for  
commercial and industrial quality parts and equipment sales.**

**561-964-4949**

**visit us on line @ [www.discount-equipment.com](http://www.discount-equipment.com)**

Select an option below to find your Equipment

**Search by Manufacturer**

**Search by Product Type**

**Request a Quote**

We sell worldwide for the brands: Genie, Terex, JLG, MultiQuip, Mikasa, Essick, Whiteman, Mayco, Toro Stone, Diamond Products, Generac Magnum, Airman, Haulotte, Barreto, Power Blanket, Nifty Lift, Atlas Copco, Chicago Pneumatic, Allmand, Miller Curber, Skyjack, Lull, Skytrak, Tsurumi, Husquvarna Target, Stow, Wacker, Sakai, Mi-T-M, Sullair, Basic, Dynapac, MBW, Weber, Bartell, Bennar Newman, Haulotte, Ditch Runner, Menegotti, Morrison, Contec, Buddy, Crown, Edco, Wyco, Bomag, Laymor, EZ Trench, Bil-Jax, F.S. Curtis, Gehl Pavers, Heli, Honda, ICS/PowerGrit, IHI, Partner, Imer, Clipper, MMD, Koshin, Rice, CH&E, General Equipment, Amida, Coleman, NAC, Gradall, Square Shooter, Kent, Stanley, Tamco, Toku, Hatz, Kohler, Robin, Wisconsin, Northrock, Oztec, Toker TK, Rol-Air, APT, Wylie, Ingersoll Rand / Doosan, Innovatech, Con X, Ammann, Mecalac, Makinex, Smith Surface Prep, Small Line, Wanco, Yanmar