

OPERATION MANUAL



WHISPERWATT™ SERIES
MODEL DCA36SPXU4F
60Hz GENERATOR
(ISUZU 4LE2X DIESEL ENGINE)
INSTRUCTION MANUAL NO. M1844300304

Revision #6 (04/18/22)



THIS MANUAL MUST ACCOMPANY THE EQUIPMENT AT ALL TIMES.

TO PURCHASE THIS PRODUCT PLEASE CONTACT US



**Equipment Financing and
Extended Warranties Available**



**Discount-Equipment.com is your online resource for
commercial and industrial quality parts and equipment sales.**

561-964-4949

visit us on line @ www.discount-equipment.com

Select an option below to find your Equipment

Search by Manufacturer

Search by Product Type

Request a Quote

We sell worldwide for the brands: Genie, Terex, JLG, MultiQuip, Mikasa, Essick, Whiteman, Mayco, Toro Stone, Diamond Products, Generac Magnum, Airman, Haulotte, Barreto, Power Blanket, Nifty Lift, Atlas Copco, Chicago Pneumatic, Allmand, Miller Curber, Skyjack, Lull, Skytrak, Tsurumi, Husquvarna Target, Stow, Wacker, Sakai, Mi-T-M, Sullair, Basic, Dynapac, MBW, Weber, Bartell, Bennar Newman, Haulotte, Ditch Runner, Menegotti, Morrison, Contec, Buddy, Crown, Edco, Wyco, Bomag, Laymor, EZ Trench, Bil-Jax, F.S. Curtis, Gehl Pavers, Heli, Honda, ICS/PowerGrit, IHI, Partner, Imer, Clipper, MMD, Koshin, Rice, CH&E, General Equipment, Amida, Coleman, NAC, Gradall, Square Shooter, Kent, Stanley, Tamco, Toku, Hatz, Kohler, Robin, Wisconsin, Northrock, Oztec, Toker TK, Rol-Air, APT, Wylie, Ingersoll Rand / Doosan, Innovatech, Con X, Ammann, Mecalac, Makinex, Smith Surface Prep, Small Line, Wanco, Yanmar

PROPOSITION 65 WARNING

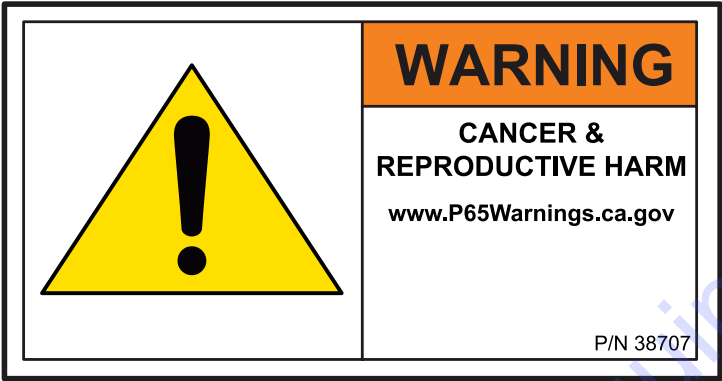

To order go to Discount-Equipment.com

DCA36SPXU4F 60 Hz Generator

Proposition 65 Warning	2
Safety Decals	4
Safety Information	5–10
Specifications	11
Dimensions.....	12
Installation	14–15
General Information.....	16
Major Components	17
Engine/Generator Control Panel.....	18–19
Output Terminal Panel Familiarization	20–22
Load Application	23
AC Ammeter Gauge Reading.....	24
Output Terminal Panel Connections	25–26
Inspection/Setup.....	27–30
Generator Start-Up Procedure (Manual Mode)....	31–33
Generator Start-Up Procedure (Auto Mode).....	34
Generator Shut-Down Procedures	35
Maintenance	36–40
Troubleshooting Diagnostics	41
Troubleshooting Generator	42
Troubleshooting Engine	43–44
Generator Wiring Diagram (M184000503A)	45
Engine Wiring Diagram (M1814100523)	46
Controller Wiring Diagram (M1814100603C)	47
Battery Charger Wiring Diagram (Option)	48
Engine Block Heater Wiring Diagram (Option)	49

NOTICE

Specifications are subject to change without notice.

SAFETY DECALS

Safety decals are attached to the generator as shown in Figure 1. Keep these safety decals clean at all times. When the safety decals become worn or damaged, contact Discount-equipment.

NOTICE
For safety decals part numbers, reference parts manual.

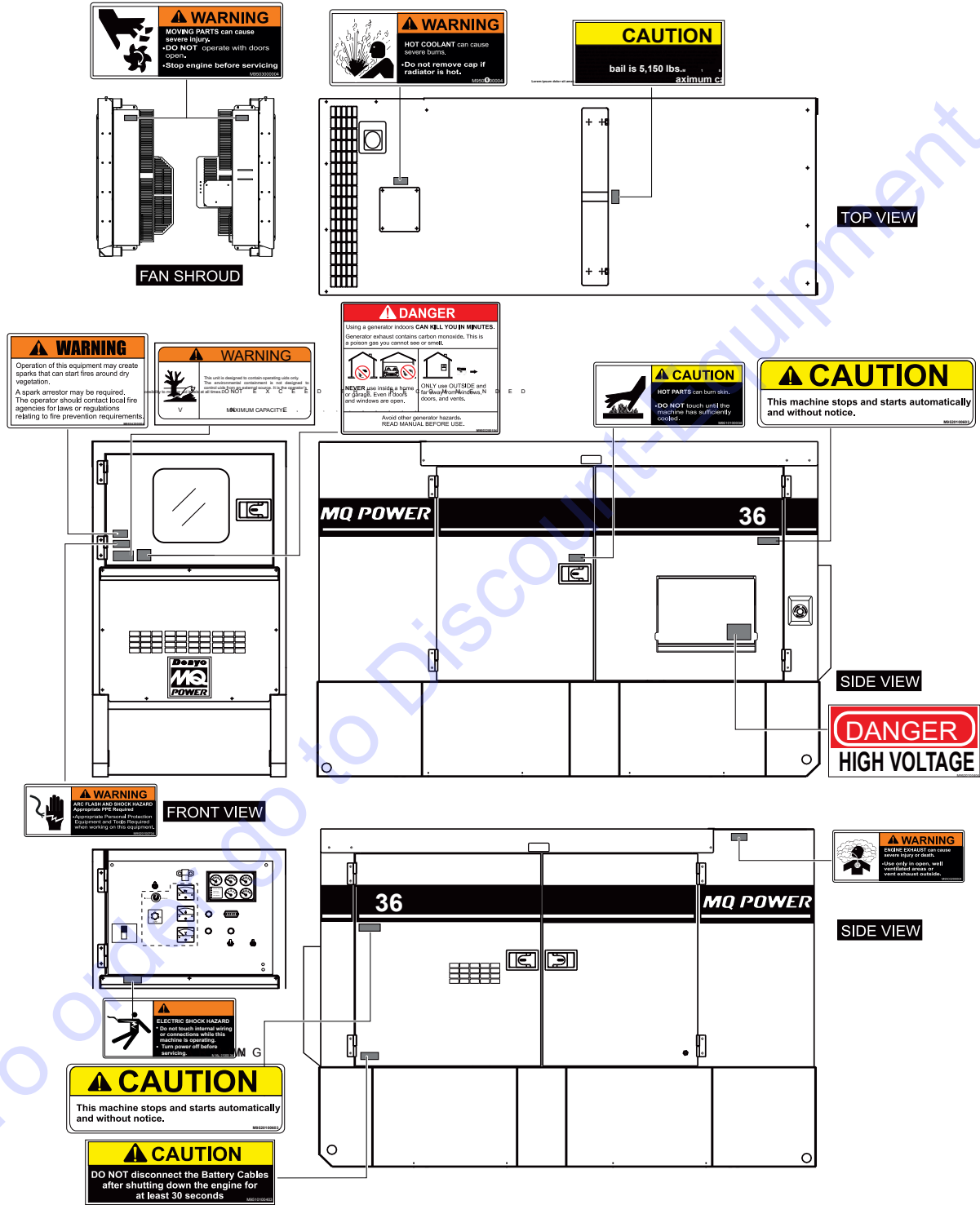

Figure 1. Safety Decals

SAFETY INFORMATION

Do not operate or service the equipment before reading the entire manual. Safety precautions should be followed at all times when operating this equipment. Failure to read and understand the safety messages and operating instructions could result in injury to yourself and others.

SAFETY MESSAGES

The four safety messages shown below will inform you about potential hazards that could injure you or others. The safety messages specifically address the level of exposure to the operator and are preceded by one of four words: **DANGER**, **WARNING**, **CAUTION** or **NOTICE**.

SAFETY SYMBOLS

 **DANGER**

Indicates a hazardous situation which, if not avoided, **WILL** result in **DEATH** or **SERIOUS INJURY**.

 **WARNING**

Indicates a hazardous situation which, if not avoided, **COULD** result in **DEATH** or **SERIOUS INJURY**.







 **CAUTION**

Indicates a hazardous situation which, if not avoided, **COULD** result in **MINOR** or **MODERATE INJURY**.

NOTICE

Addresses practices not related to personal injury.

Potential hazards associated with the operation of this equipment will be referenced with hazard symbols which may appear throughout this manual in conjunction with safety messages.

Symbol	Safety Hazard
	Lethal exhaust gas hazards
	Explosive fuel hazards
	Burn hazards
	Overspeed hazards
	Rotating parts hazards
	Pressurized fluid hazards
	Electric shock hazards

SAFETY INFORMATION

GENERAL SAFETY

CAUTION

- **NEVER** operate this equipment without proper protective clothing, shatterproof glasses, respiratory protection, hearing protection, steel-toed boots and other protective devices required by the job or city and state regulations.



- **NEVER** operate this equipment when not feeling well due to fatigue, illness or when under medication. 
- **NEVER** operate this equipment under the influence of drugs or alcohol.



- **ALWAYS** check the equipment for loosened threads or bolts before starting.
- **DO NOT** use the equipment for any purpose other than its intended purposes or applications.

NOTICE

- This equipment should only be operated by trained and qualified personnel 18 years of age and older.
- Whenever necessary, replace nameplate, operation and safety decals when they become difficult read.
- Manufacturer does not assume responsibility for any accident due to equipment modifications. Unauthorized equipment modification will void all warranties.

- **NEVER** use accessories or attachments that are not recommended by MQ Power for this equipment. Damage to the equipment and/or injury to user may result.

- **ALWAYS** know the location of the nearest fire extinguisher.



- **ALWAYS** know the location of the nearest first aid kit.



- **ALWAYS** know the location of the nearest phone or **keep a phone on the job site**. Also, know the phone numbers of the nearest **ambulance, doctor** and **fire department**. This information will be invaluable in the case of an emergency.



GENERATOR SAFETY

DANGER

- **NEVER** operate the equipment in an explosive atmosphere or near combustible materials. An explosion or fire could result causing severe **bodily harm or even death**.



WARNING

- **NEVER** disconnect any **emergency or safety devices**. These devices are intended for operator safety. Disconnection of these devices can cause severe injury, bodily harm or even death. Disconnection of any of these devices will void all warranties.

CAUTION

- **NEVER** lubricate components or attempt service on a running machine.

NOTICE

- **ALWAYS** ensure generator is on level ground before use.
- **ALWAYS** keep the machine in proper running condition.
- Fix damage to machine and replace any broken parts immediately.
- **ALWAYS** store equipment properly when it is not being used. Equipment should be stored in a clean, dry location out of the reach of children and unauthorized personnel

SAFETY INFORMATION

ENGINE SAFETY

DANGER

- The engine fuel exhaust gases contain poisonous carbon monoxide. This gas is colorless and odorless, and can cause death if inhaled.
- The engine of this equipment requires an adequate free flow of cooling air. **NEVER** operate this equipment in any enclosed or narrow area where free flow of the air is restricted. If the air flow is restricted it will cause injury to people and property and serious damage to the equipment or engine.



WARNING

- **DO NOT** place hands or fingers inside engine compartment when engine is running.
- **NEVER** operate the engine with heat shields or guards removed.
- Keep fingers, hands hair and clothing away from all moving parts to prevent injury.
- **DO NOT** remove the radiator cap while the engine is hot. High pressure boiling water will gush out of the radiator and severely scald any persons in the general area of the generator.
- **DO NOT** remove the coolant drain plug while the engine is hot. Hot coolant will gush out of the coolant tank and severely scald any persons in the general area of the generator.
- **DO NOT** remove the engine oil drain plug while the engine is hot. Hot oil will gush out of the oil tank and severely scald any persons in the general area of the generator.



CAUTION

- **NEVER** touch the hot exhaust manifold, muffler or cylinder. Allow these parts to cool before servicing equipment.



NOTICE

- **NEVER** run engine without an air filter or with a dirty air filter. Severe engine damage may occur. Service air filter frequently to prevent engine malfunction.
- **NEVER** tamper with the factory settings of the engine or engine governor. Damage to the engine or equipment can result if operating in speed ranges above the maximum allowable.
- Wet stacking is a common problem with diesel engines which are operated for extended periods with light or no load applied. When a diesel engine operates without sufficient load (less than 40% of the rated output), it will not operate at its optimum temperature. This will allow unburned fuel to accumulate in the exhaust system, which can foul the fuel injectors, engine valves and exhaust system, including turbochargers, and reduce the operating performance.



In order for a diesel engine to operate at peak efficiency, it must be able to provide fuel and air in the proper ratio and at a high enough engine temperature for the engine to completely burn all of the fuel.

Wet stacking does not usually cause any permanent damage and can be alleviated if additional load is applied to relieve the condition. It can reduce the system performance and increase maintenance. Applying an increasing load over a period of time until the excess fuel is burned off and the system capacity is reached usually can repair the condition. This can take several hours to burn off the accumulated unburned fuel.

- State Health Safety Codes and Public Resources Codes specify that in certain locations, spark arresters must be used on internal combustion engines that use hydrocarbon fuels. A spark arrester is a device designed to prevent accidental discharge of sparks or flames from the engine exhaust. Spark arresters are qualified and rated by the United States Forest Service for this purpose. In order to comply with local laws regarding spark arresters, consult the engine distributor or the local Health and Safety Administrator.

SAFETY INFORMATION

FUEL SAFETY

DANGER

- **DO NOT** start the engine near spilled fuel or combustible fluids. Diesel fuel is extremely flammable and its vapors can cause an explosion if ignited.
- **ALWAYS** refuel in a well-ventilated area, away from sparks and open flames.
- **ALWAYS** use extreme caution when working with **flammable** liquids.
- **DO NOT** fill the fuel tank while the engine is running or hot.
- **DO NOT** overfill tank, since spilled fuel could ignite if it comes into contact with hot engine parts or sparks from the ignition system.
- Store fuel in appropriate containers, in well-ventilated areas and away from sparks and flames.
- **NEVER** use fuel as a cleaning agent.
- **DO NOT** smoke around or near the equipment. Fire or explosion could result from fuel vapors or if fuel is spilled on a hot engine.



TOWING SAFETY

CAUTION

- Check with your local county or state safety towing regulations, in addition to meeting **Department of Transportation (DOT) Safety Towing Regulations**, before towing your generator.
- Refer to MQ Power trailer manual for additional safety information.
- In order to reduce the possibility of an accident while transporting the generator on public roads, **ALWAYS** make sure the trailer that supports the generator and the towing vehicle are mechanically sound and in good operating condition.
- **ALWAYS** shutdown engine before transporting



- Make sure the hitch and coupling of the towing vehicle are rated equal to, or greater than the trailer “gross vehicle weight rating.”
- **ALWAYS** inspect the hitch and coupling for wear. **NEVER** tow a trailer with defective hitches, couplings, chains, etc.
- Check the tire air pressure on both towing vehicle and trailer. **Trailer tires should be inflated to 50 psi cold.** Also check the tire tread wear on both vehicles.
- **ALWAYS** make sure the trailer is equipped with a **safety chain**.
- **ALWAYS** properly attach trailer’s safety chains to towing vehicle.
- **ALWAYS** make sure the vehicle and trailer directional, backup, brake and trailer lights are connected and working properly.
- DOT Requirements include the following:
 - Connect and test electric brake operation.
 - Secure portable power cables in cable tray with tie wraps.
- The maximum speed for highway towing is **55 MPH** unless posted otherwise. Recommended off-road towing is not to exceed **15 MPH** or less depending on type of terrain.
- Avoid sudden stops and starts. This can cause skidding, or jack-knifing. Smooth, gradual starts and stops will improve towing.
- Avoid sharp turns to prevent rolling.
- Trailer should be adjusted to a level position at all times when towing.
- Raise and lock trailer wheel stand in up position when towing.
- Place **chock blocks** underneath wheel to prevent **rolling** while parked.
- Place **support blocks** underneath the trailer’s bumper to prevent **tipping** while parked.
- Use the trailer’s swivel jack to adjust the trailer height to a level position while parked.

SAFETY INFORMATION

ELECTRICAL SAFETY

DANGER

- **DO NOT** touch output terminals during operation. Contact with output terminals during operation can cause **electrocution, electrical shock or burn.**



- The electrical voltage required to operate the generator can cause severe injury or even death through physical contact with live circuits. Turn generator and all circuit breakers **OFF** before performing maintenance on the generator or making contact with output terminals.

- **NEVER** insert any objects into the output receptacles during operation. This is extremely dangerous. The possibility exists of **electrical shock, electrocution or death.**



- Backfeed to a utility system can cause **electrocution** and/or property damage. **NEVER** connect the generator to a building's electrical system without a transfer switch or other approved device. All installations should be performed by a **licensed electrician** in accordance with all applicable laws and electrical codes. Failure to do so could result in electrical shock or burn, causing **serious injury or even death.**



Power Cord/Cable Safety

DANGER

- **NEVER** let power cords or cables **lay in water.**
- **NEVER stand in water** while AC power from the generator is being transferred to a load.
- **NEVER** use **damaged** or **worn** cables or cords when connecting equipment to generator. Inspect for cuts in the insulation.
- **NEVER** grab or touch a live power cord or cable with wet hands. The possibility exists of **electrical shock, electrocution or death.**

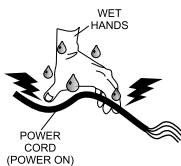

- Make sure power cables are securely connected to the generator's output receptacles. Incorrect connections may cause electrical shock and damage to the generator.

NOTICE

- **ALWAYS** make certain that proper power or extension cord has been selected for the job. See Cable Selection Chart in this manual.

Grounding Safety

DANGER

- **ALWAYS** make sure that electrical circuits are properly grounded to a suitable earth ground (ground rod) per the National Electrical Code (NEC) and local codes before operating generator. **Severe injury or death by electrocution** can result from operating an ungrounded generator.

- **NEVER** use gas piping as an electrical ground.

BATTERY SAFETY

DANGER

- **DO NOT** drop the battery. There is a possibility that the battery will explode.
- **DO NOT** expose the battery to open flames, sparks, cigarettes, etc. The battery contains combustible gases and liquids. If these gases and liquids come into contact with a flame or spark, an explosion could occur.

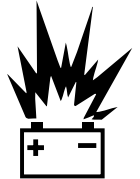

WARNING

- **ALWAYS** wear safety glasses when handling the battery to avoid eye irritation. The battery contains acids that can cause injury to the eyes and skin.
- Use well-insulated gloves when picking up the battery.
- **ALWAYS** keep the battery charged. If the battery is not charged, combustible gas will build up.
- **ALWAYS** recharge the battery in a well-ventilated environment to avoid the risk of a dangerous concentration of combustible gasses.



SAFETY INFORMATION

- If the battery liquid (dilute sulfuric acid) comes into contact with **clothing or skin**, rinse skin or clothing immediately with plenty of water.
- If the battery liquid (dilute sulfuric acid) comes into contact with **eyes**, rinse eyes immediately with plenty of water and contact the nearest doctor or hospital to seek medical attention.

CAUTION

- **ALWAYS** disconnect the **NEGATIVE** battery terminal before performing service on the generator.
- **ALWAYS** keep battery cables in good working condition. Repair or replace all worn cables.

ENVIRONMENTAL SAFETY/DECOMMISSIONING

NOTICE

Decommissioning is a controlled process used to safely retire a piece of equipment that is no longer serviceable. If the equipment poses an unacceptable and unrepairable safety risk due to wear or damage or is no longer cost effective to maintain (beyond life-cycle reliability) and is to be decommissioned (demolition and dismantlement), be sure to follow rules below.

- **DO NOT** pour waste or oil directly onto the ground, down a drain or into any water source.
- Contact your country's Department of Public Works or recycling agency in your area and arrange for proper disposal of any electrical components, waste or oil associated with this equipment.
- When the life cycle of this equipment is over, remove battery and bring to appropriate facility for lead reclamation. Use safety precautions when handling batteries that contain sulfuric acid.
- When the life cycle of this equipment is over, it is recommended that the trowel frame and all other metal parts be sent to a recycling center.



Metal recycling involves the collection of metal from discarded products and its transformation into raw materials to use in manufacturing a new product.

Recyclers and manufacturers alike promote the process of recycling metal. Using a metal recycling center promotes energy cost savings.

EMISSIONS INFORMATION

NOTICE

The diesel engine used in this equipment has been designed to reduce harmful levels of carbon monoxide (CO), hydrocarbons (HC) and nitrogen oxides (NOx) contained in diesel exhaust emissions.

This engine has been certified to meet US EPA Evaporative emissions requirements in the installed configuration.

Attempting to modify or make adjustments to the engine emission system by unauthorized personnel without proper training could damage the equipment or create an unsafe condition.

Additionally, modifying the fuel system may adversely affect evaporative emissions, resulting in fines or other penalties.

Emission Control Label

The emission control label is an integral part of the emission system and is strictly controlled by regulations.

The label must remain with the engine for its entire life.

If a replacement emission label is needed, please contact Discount-equipment.

SPECIFICATIONS

Table 1. Generator Specifications

Model	DCA36SPXU4F
Type	Revolving field, self ventilated, Drip-proof, single bearing
Armature Connection	Series
Phase	1Ø
Standby Output	40 kW (40 kVA)
Prime Output	36 kW (36 kVA)
1Ø Voltage (L-L/L-N) Voltage Selector Switch at 1Ø 240/120	120/240
Power Factor	1.0
Frequency	60 Hz
Speed	1800 rpm
Aux. AC Power	Single Phase, 60 Hz
Aux. Voltage/Output	4.8 Kw (2.4 kW x 2)
Dry Weight	2,448 lbs. (1,110 kg))
Wet Weight	3,087 lbs. (1,400 kg)

Table 2. Engine Specifications

Model	Isuzu/4LE2X EPA Tier 4 Final Certified	
Type	4-Cycle, water-cooled, direct injection, turbocharged, charge air cooled, EGR and DOC	
No. of Cylinders	4 cylinders	
Bore x Stroke	3.35 in. x 3.78 in. (85 mm x 96 mm)	
Displacement	133 cu. in. (2.179 liter)	
Rated Output	59.0 HP at 1800 rpm	
Starting	Electric	
Coolant Capacity	4.4 gal. (16.8 liters) ¹	
Lube Oil Capacity	3.2 gal. (12.2 liters) ²	
Lubricating Type Oil	API service class CJ-4 SAE or JASO DH-2	
Fuel Type	#2 Diesel Fuel (Ultra low sulfur diesel fuel only)	
Fuel Leak Warning Capacity	21.1 gal. (80 liters)	
Fuel Tank Capacity	79.2 gal. (300 liters)	
Fuel Consumption	2.93 gal. (11.1 L)/hr at full load	2.20 gal. (8.31 L)/hr at 3/4 load
	1.60 gal. (6.04 L)/hr at 1/2 load	1.04 gal. (3.92 L)/hr at 1/4 load
Exhaust Gas After-Treatment System	DOC	
Battery	12V 72Ah X 1	

¹ Includes engine and radiator hoses

² Includes filters

DIMENSIONS

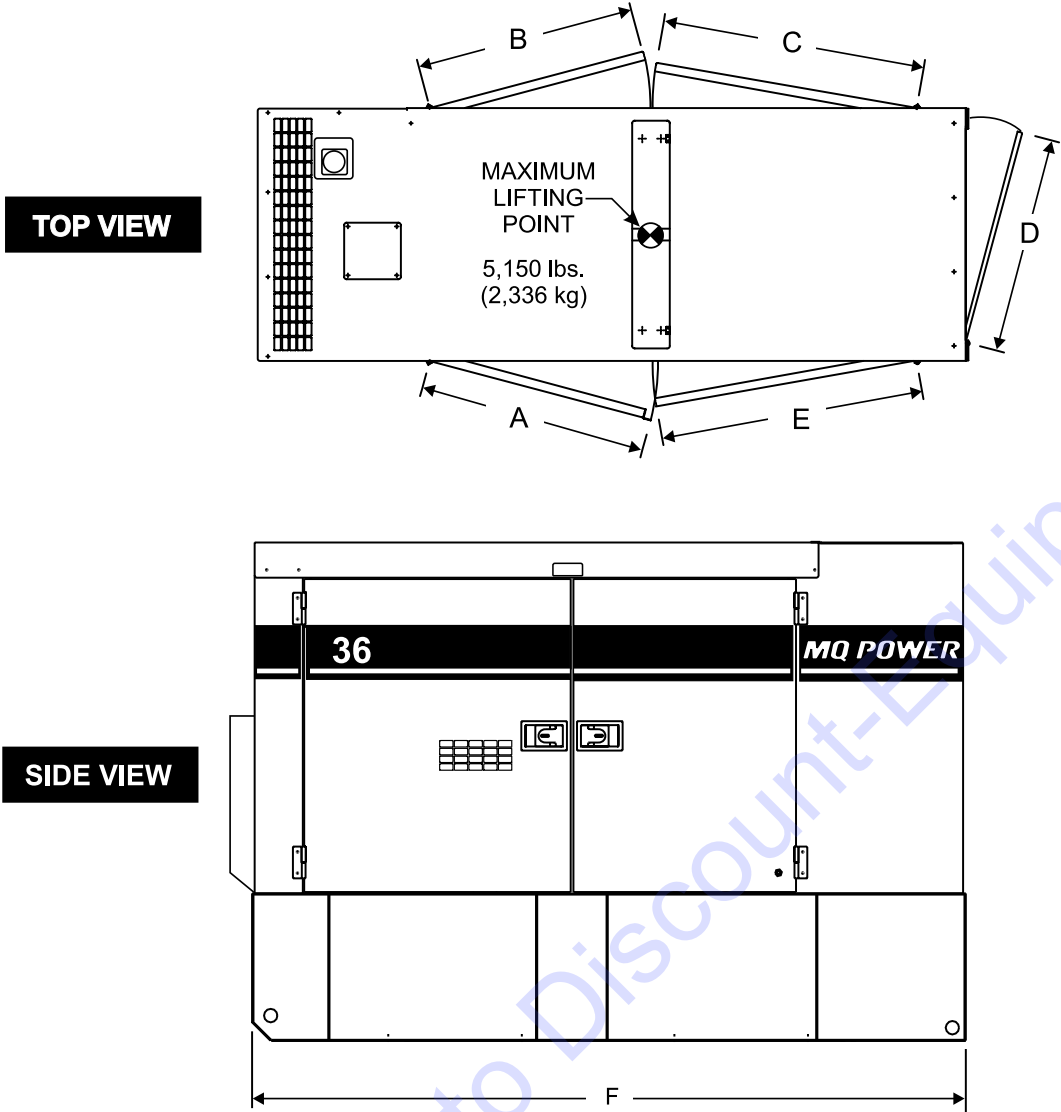

Figure 2. Dimensions

Table 3. Dimensions			
Reference Letter	Dimension in. (mm)	Reference Letter	Dimension in. (mm)
A	28.35 (720)	E	26.18 (665)
B	28.35 (720)	F	87.00 (2,210)
C	26.18 (665)	G	61.00 (1,550)
D	32.28 (820)	H	37.40 (950)

INSTALLATION

CONNECTING THE GROUND

Consult with local Electrical and Safety Codes for proper connection based on condition of use.

EXAMPLE of how to ground the unit if the condition of use requires such a device.

The ground terminal on the generator should always be used to connect the generator to a suitable ground when required.

The ground cable should be #8 size wire (aluminum) minimum. If copper wire is used, #10 size wire minimum should be used.

Connect one end of the ground cable terminal to the generator ground point (Figure 3). Connect the other end of the ground cable to a suitable earth ground (ground rod).

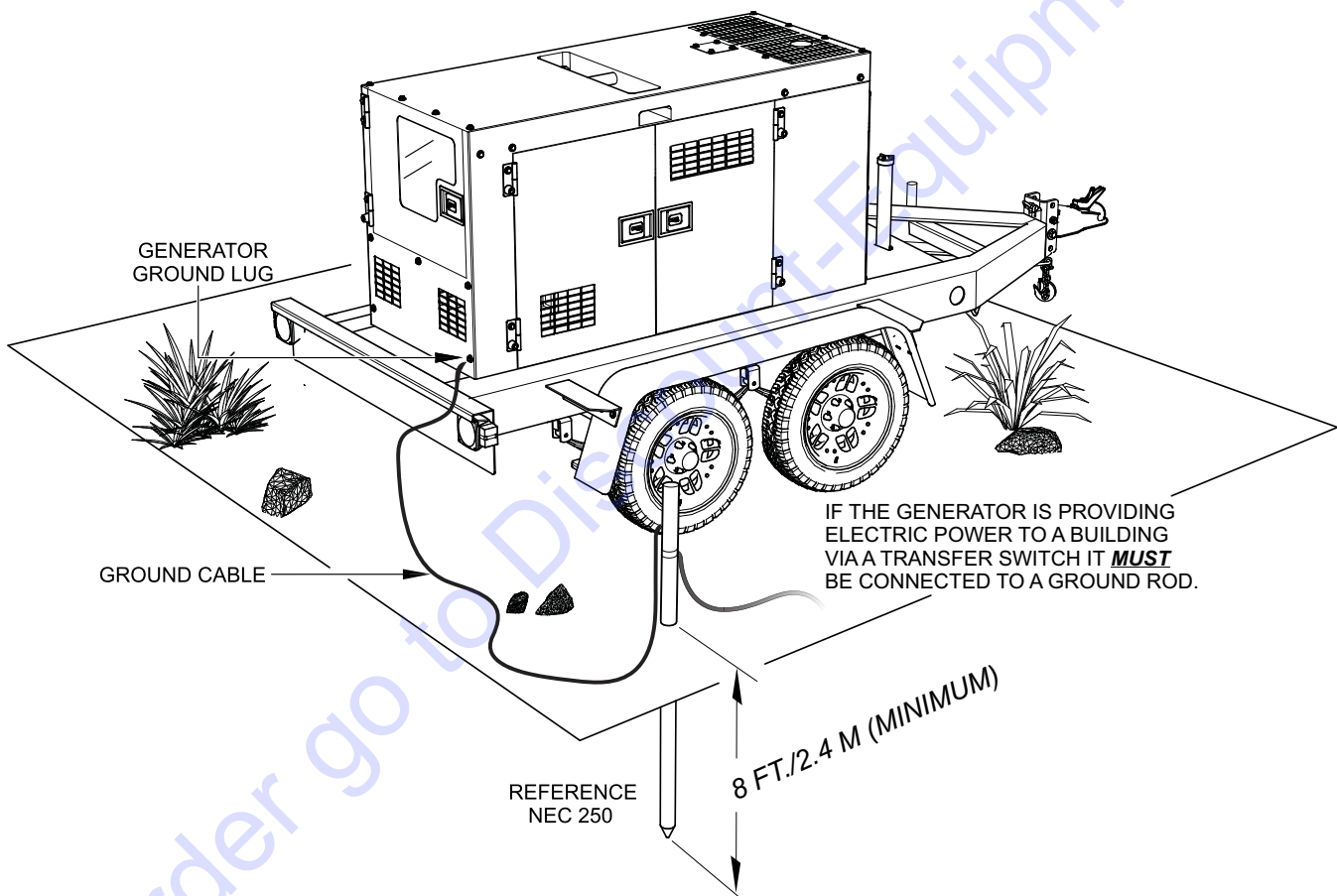

Figure 3. Typical Generator Grounding Application

NOTICE

Trailer-mounted generators are the sole responsibility of MQ Power.

OUTDOOR INSTALLATION

Install the generator in a area that is free of debris, bystanders, and overhead obstructions. Make sure the generator is on secure level ground so that it cannot slide or shift around. Also install the generator in a manner so that the exhaust will not be discharged in the direction of nearby homes.

The installation site must be relatively free from moisture and dust. All electrical equipment should be protected from excessive moisture. Failure to do will result in deterioration of the insulation and will result in short circuits and grounding.

Foreign materials such as dust, sand, lint and abrasive materials have a tendency to cause excessive wear to engine and alternator parts.

CAUTION

Pay close attention to ventilation when operating the generator inside tunnels and caves. The engine exhaust contains noxious elements. Engine exhaust must be routed to a ventilated area.

INDOOR INSTALLATION

Exhaust gases from diesel engines are extremely poisonous. Whenever an engine is installed indoors the exhaust fumes must be vented to the outside. The engine should be installed at least two feet from any outside wall. Using an exhaust pipe which is too long or too small can cause excessive back pressure which will cause the engine to heat excessively and possibly burn the valves.

MOUNTING

The generator must be mounted on a solid foundation such as concrete) and set firmly on the foundation to isolate vibration of the generator when it is running. The generator must set at least 6 inches above the floor or grade level (in accordance to NFPA 110, Chapter 54.1). **DO NOT** remove the metal skids on the bottom of the generator. They are to resist damage to the bottom of the generator and to maintain alignment.

GENERATOR GROUNDING

NOTICE

The Occupational Safety and Health Administration (OSHA) and the National Electrical Code (NEC) recommend that if the generator is providing electrical power to a structure (home, office, shop, trailer, or similar) it **must** be connected to a grounding electrode system, such as a driven ground rod (Figure 3).

If applicable, to guard against electrical shock and possible damage to the equipment, it is important to provide a good **EARTH** ground (Figure 3).

NOTICE

ALWAYS check with State, Province, District and Municipalities for electrical grounding requirements before using the generator.

Article 250 (Grounding) of the NEC handbook provides guidelines for proper grounding and specifies that the cable ground shall be connected to the grounding system of the building as close to the point of cable entry as practical.

1. Use one of the following wire types to connect the generator to earth ground.
 - a. Copper
 - b. Aluminum

NOTICE

Reference Conductor Grounding Table, Article 250 of the NEC handbook for proper conductor wire size. Wire size is determined by the maximum amperage of the generator.

2. When grounding of the generator (Figure 3) is required, connect one end the ground cable to the ground lug on the generator. Connect the other end of the ground cable to the ground rod (earth ground).
3. NEC Article 250 specifies that the earth ground rod should be buried a minimum of 8 feet into the ground.

NOTICE

When connecting the generator to any building's electrical system, **ALWAYS** consult with a licensed electrician.

GENERAL INFORMATION

GENERATOR

This generator (Figure 4) is designed as a high quality portable (requires a trailer for transport) power source for telecom sites, lighting facilities, power tools, submersible pumps and other industrial and construction machinery.

OPERATING PANEL

The “Operating Panel” is provided with the following:

- ECU 750 Controller
- Gauge Unit Assembly
 - Oil Pressure Gauge
 - Water Temperature Gauge
 - Charging Voltmeter
 - Fuel Gauge
 - Tachometer
- Panel Light/Panel Light Switch
- Pre Heat Lamp
- Warning lamp (Diagnostic)
- Hour Meter
- Engine Speed Switch
- Auto Start/Stop Switch
- Fuel Leak Detected Alarm Lamp

CONTROL PANEL

The “Control Panel” is provided with the following:

- Frequency Meter (Hz)
- AC Ammeter (Amps)
- AC Voltmeter (Volts)
- Ammeter Change-Over Switch
- Voltage Regulator
- 3-Pole, 150 amp Main Circuit Breaker
- “Control Box” (located behind Control Panel)
 - Automatic Voltage Regulator
 - Current Transformer
 - Over-Current Relay
 - Starter Relay

OUTPUT TERMINAL PANEL

The “Output Terminal Panel” is provided with the following:

- Three 120/240V output receptacles (CS-6369), 50A
- Three auxiliary circuit breakers, 50A
- Two 120V output receptacles (GFCI), 20A
- Two GFCI circuit breakers, 20A
- Four output terminal lugs (1Ø power)
- Battery Charger (Option)
- Engine Block Heater (Option)
- Low Coolant Switch (Option)

OPEN DELTA EXCITATION SYSTEM

Each generator is equipped with the state of the art “Open-Delta” excitation system. The open delta system consist of an electrically independent winding wound among stationary windings of the AC output section.

There are four connections of the open delta A, B, C and D. During steady state loads, the power from the voltage regulator is supplied from the parallel connections of A to B, A to D, and C to D. These three phases of the voltage input to the voltage regulator are then rectified and are the excitation current for the exciter section.

When a heavy load, such as a motor starting or a short circuit occurs, the automatic voltage regulator (AVR) switches the configuration of the open delta to the series connection of B to C. This has the effect of adding the voltages of each phase to provide higher excitation to the exciter section and thus better voltage response during the application of heavy loads.

The connections of the AVR to the AC output windings are for sensing only. No power is required from these windings. The open-delta design provides virtually unlimited excitation current, offering maximum motor starting capabilities. The excitation does not have a “fixed ceiling” and responds according to the demands of the required load.

ENGINE

This generator is powered by a 4 cylinder, 4-cycle, water cooled, direct injection, turbocharged, charge air cooled and EGR Isuzu 4LE2X diesel engine. This engine is designed to meet every performance requirement for the generator. Reference Table 2 for engine specifications.

In keeping with MQ Power’s policy of constantly improving its products, the specifications quoted herein are subject to change without prior notice.

ELECTRIC GOVERNOR SYSTEM

The electric governor system controls the RPMs of the engine. When the engine demand increases or decreases, the governor system regulates the frequency variation to $\pm 0.25\%$.

EXTENSION CABLES

When electric power is to be provided to various tools or loads at some distance from the generator, extension cords are normally used. Cables should be sized to allow for distance in length and amperage so that the voltage drop between the generator and point of use (load) is held to a minimum. Use the cable selection chart (Table 6) as a guide for selecting proper extension cable size.

MAJOR COMPONENTS

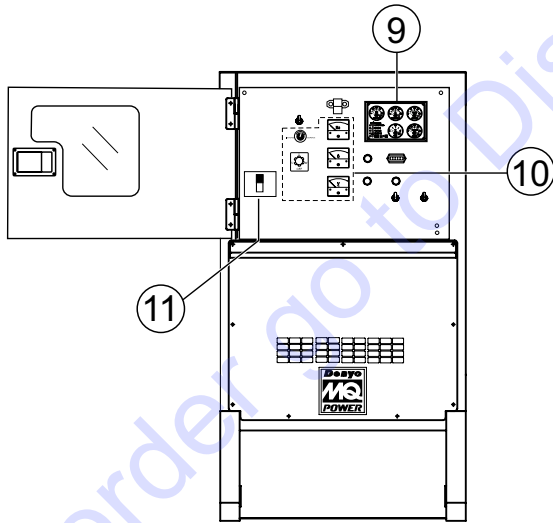
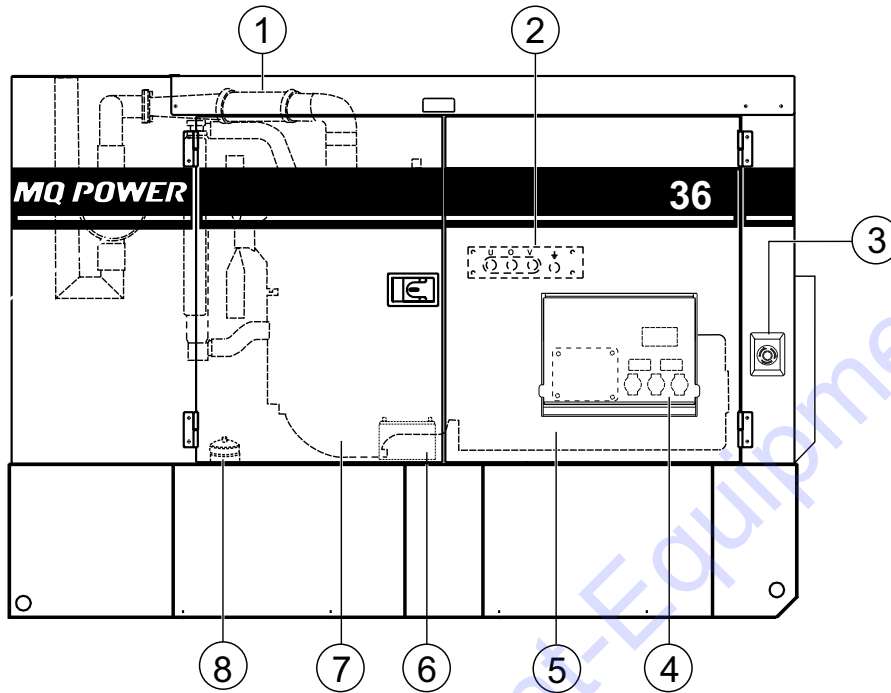

Table 4. Generator Major Components	
ITEM NO.	DESCRIPTION
1	Muffler Assembly
2	Output Terminal Board Assembly
3	Emergency Stop Switch Assy. S/N 8730269 ~ Above
4	Output Terminal Panel Assembly
5	Generator Assembly
6	Battery Assembly
7	Engine Assembly
8	Fuel Tank Assembly
9	Gauge Unit Assembly
10	Generator Control Panel Assembly
11	Circuit Breaker Assembly

Figure 4. Major Components

ENGINE/GENERATOR CONTROL PANEL

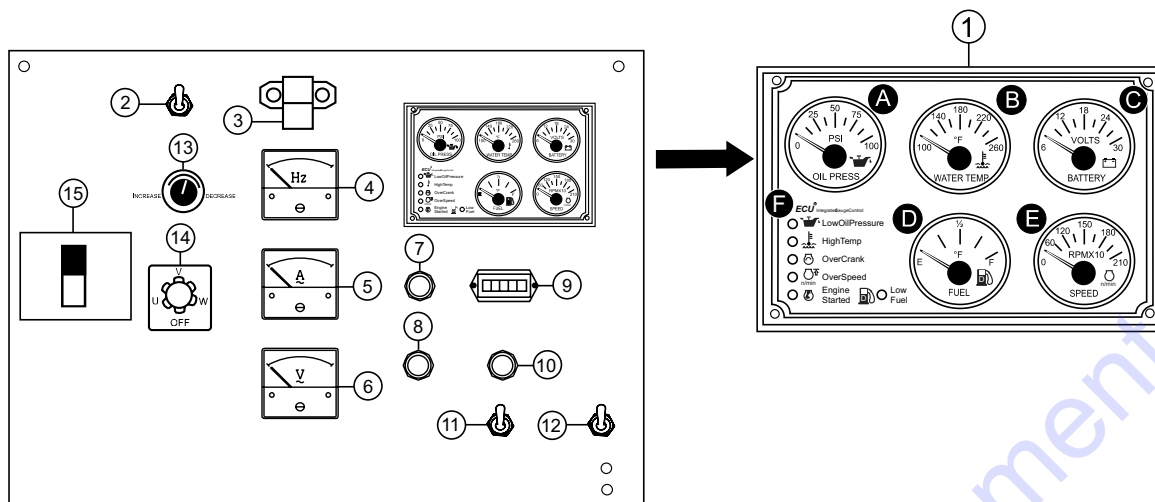

Figure 5. Engine/Generator Control Panel

The definitions below describe the controls and functions of the Engine/Generator Control Panel (Figure 5).

1. **ECU Controller with Gauge Unit Assembly** — This assembly houses the various engine monitoring gauges. These gauges indicate: oil pressure, water temperature, charging voltmeter, fuel and engine speed RPM (tachometer).

- A. **Oil Pressure Gauge** — During normal operation this gauge should read approximately 50 psi. (345 kPa). When starting the generator, the oil pressure may read a little higher, but after the engine warms up the oil pressure should return to the correct pressure range.
- B. **Water Temperature Gauge** — During normal operation this gauge should read approximately 180°F (82°C).
- C. **Charging Voltmeter Gauge** — During normal operation this gauge indicate minimum 14 VDC.
- D. **Fuel Gauge** — Indicates amount of diesel fuel available.
- E. **Tachometer** — Indicates engine speed in RPM's for 60 Hz operation. This meter should indicate 1800 RPM's when the rated load is applied.

F. Warning LEDs

- **Low Oil Pressure LED** — This LED will light when the engine oil pressure drops to 14.2 psi (98 kPa). This condition will cause the engine to shut down.
 - **High Temperature LED** — This LED will light when the coolant temperature has reached 212°F (100°C). This condition will cause the engine to shut down.
 - **Over Crank LED** — This LED will light when the engine has attempted to start 3 times and failed. The intervals between the 3 start cycles is approximately 10 seconds.
 - **Over Speed LED** — This LED will light when the engine is running at an unsafe speed. This condition will cause the engine to shut down.
 - **Low Fuel LED** — This LED will light when the fuel level falls below 20%. Shutdown will activate at 5%.
 - **Engine Started LED** — This LED will light when the engine has started and is operating correctly.
2. **Panel Light Switch** — When activated, will turn on control panel light.
3. **Panel Light** — For operation at night, panel light illuminates control panel for ease of reading meters and gauges. Make sure panel light switch is in the **OFF** position when light is not in use.

ENGINE/GENERATOR CONTROL PANEL

4. **Frequency Meter** — Indicates the output frequency in hertz (Hz). Normally 60 Hz.
5. **AC Ammeter** — Indicates the amount of current the load is drawing from the generator per leg selected by the ammeter phase-selector switch.
6. **AC Voltmeter** — Indicates the output voltage present at the **U, O and V Output Terminal Lugs**.
7. **Fuel Leak Detected Alarm Lamp** — This lamp when ON, indicates that fluids in the containment area have reached a high level.
8. **Warning Lamp** — This lamp turns **ON** when an engine fault/failure has occurred. Reference troubleshooting diagnostic section in this manual.
9. **Hour Meter** — Indicates the operational hours of the generator.
10. **Pre-Heat Lamp** — When the Auto Start/Stop Switch is placed in the manual position, this lamp will illuminate to indicate preheating of the engine glow plugs. When the lamp turns off, this indicates that the preheat cycle is complete and the engine can be started.
11. **Auto Start-Stop Switch** — This switch selects either manual or automatic operation. Center position is **OFF** (reset).
12. **Engine Speed Switch** — This switch controls the speed of the engine low or high.
13. **Voltage Regulator Control** — Allows $\pm 15\%$ manual adjustment of the generator's output voltage.
14. **Ammeter Change-Over Switch** — This switch allows the AC ammeter to indicate the current flowing to the load connected to any phase of the output terminals, or to be switched off. This switch does not effect the generator output in any fashion, it is for current reading only.
15. **Main Circuit Breaker** — This three-pole, 150 amp main breaker is provided to protect the **U, O, and V** output terminal lugs from overload.

OUTPUT TERMINAL PANEL FAMILIARIZATION

OUTPUT TERMINAL PANEL

The Output Terminal Panel (Figure 6) shown below is located on the right-hand side (left from control panel) of the generator. Lift up on the cover to gain access to receptacles and terminal lugs.

NOTICE

Terminal legs "O" and "Ground" are considered bonded grounds.

OUTPUT TERMINAL FAMILIARIZATION

The "Output Terminal Panel" (Figure 6) is provided with the following:

- Three 120/240 output receptacles @ 50 amps
- Three Aux. Circuit Breakers @ 50 amps
- Two 120V GFCI receptacles @ 20 amps
- Two GFCI Circuit Breakers @ 20 amps
- Four Output Terminal Lugs (U, O, V, and Ground)

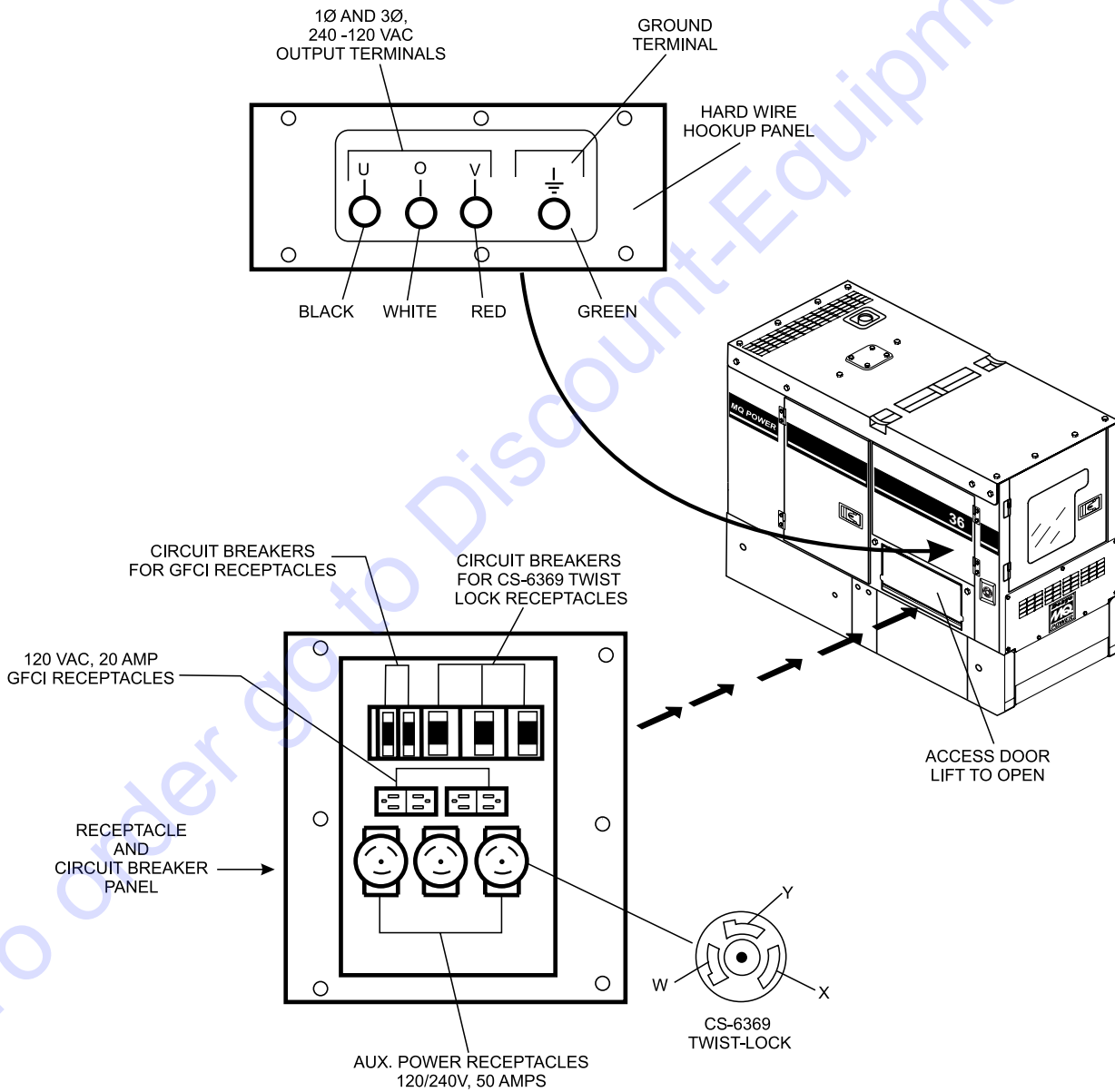

Figure 6. Output Terminal Panel

OUTPUT TERMINAL PANEL FAMILIARIZATION

120 VAC GFCI Receptacles

NOTICE

It is recommended that the GFCI receptacles be tested when the generator is initially uncrated. The receptacles should then be tested daily at startup.

There are two 120 VAC, 20-amp GFCI (Duplex NEMA 5-20R) receptacles provided on the output terminal panel. These receptacles can be accessed in any **voltage selector switch** position. Each receptacle is protected by a 20-amp circuit breaker. These breakers are located directly above the GFCI receptacles. Remember the load output (current) of both GFCI receptacles is dependent on the load requirements of the U, V, and W output terminal lugs.

Pressing the **reset** button resets the GFCI receptacle after being tripped. Pressing the **test button** (See Figure 7) in the center of the receptacle will check the GFCI function. Both receptacles should be tested at least once a month. Reference the maintenance section in this manual for further testing of the GFCI receptacle.

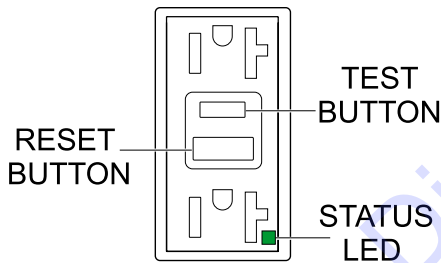

Figure 7. G.F.C.I. Receptacle

Twist Lock Dual Voltage 120/240 VAC Receptacles

There are three 120/240V, 50 amp auxiliary twist-lock (CS-6369) receptacles (Figure 8) provided on the output terminal panel. These receptacles can **only** be accessed when the main and auxiliary circuit breakers are in the ON position.

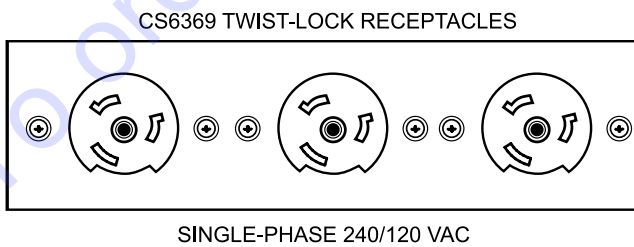

Figure 8. 120/240V Twist-Lock Auxiliary Receptacles

Each auxiliary receptacle is protected by a 50 amp circuit breaker. These breakers are located directly above the GFCI receptacles. Remember the load output (current) on all three receptacles is dependent on the load requirements of the **output terminal lugs**.

Turn the **voltage regulator control knob** (Figure 9) on the control panel to obtain the desired voltage. Turning the knob clockwise will **increase** the voltage, turning the knob counter-clockwise will **decrease** the voltage.



Figure 9. Voltage Regulator Control Knob

Removing the Plastic Face Plate (Hard Wire Hookup Panel)

The **Output Terminal Lugs** are protected by a plastic face plate cover (Figure 10). Un-screw the securing bolts and lift the plastic terminal cover to gain access to the terminal enclosure.

After the load wires have been securely attached to the terminal lugs, reinstall the plastic face plate.

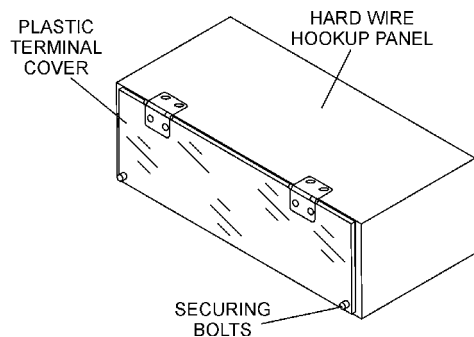

Figure 10. Plastic Face Plate (Output Terminal Lugs)

OUTPUT TERMINAL PANEL FAMILIARIZATION

Connecting Loads

Loads can be connected to the generator by various methods, output terminal lugs, camlocks or the convenience receptacles (Figure 11). Make sure to read the operation manual before attempting to connect a load to the generator.

To protect the output terminals from overload, a 3-pole, 150A **main** circuit breaker is provided. Make sure to switch **ALL** circuit breakers to the **OFF** position prior to starting the engine.

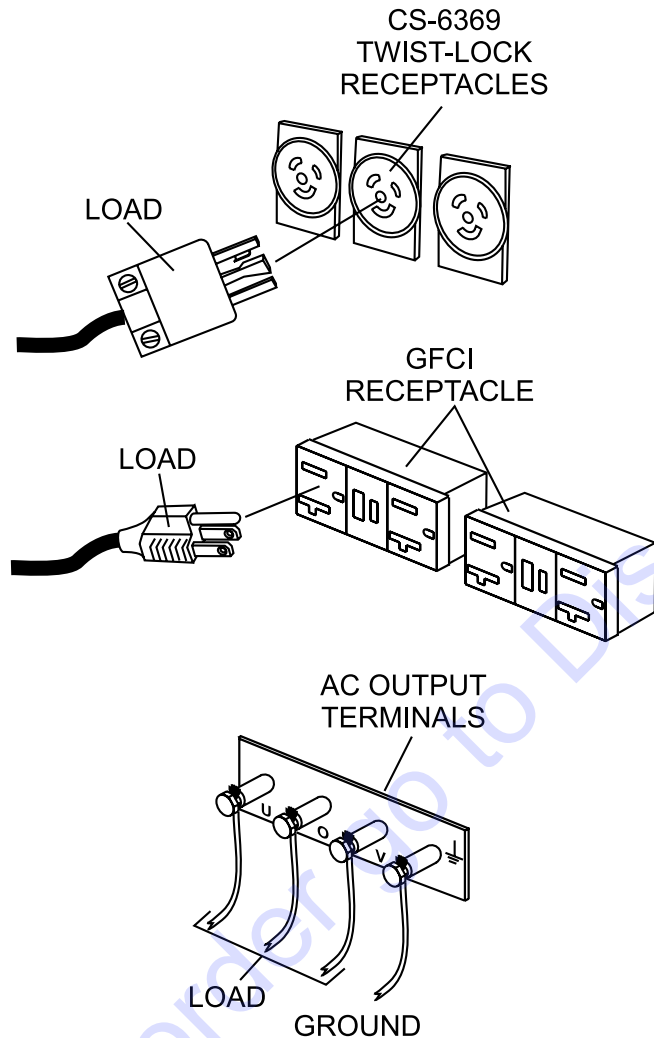

Figure 11. Connecting Loads

Over Current Relay

An **over current relay** (Figure 12) is connected to the main circuit breaker. In the event of an overload, both the circuit breaker and the over current relay may trip. If the circuit breaker can not be reset, the **reset button** on the over current relay must be pressed. The over current relay is located in the control box.

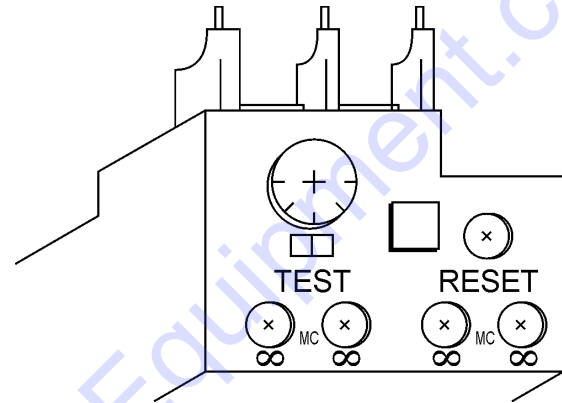

Figure 12. Over Current Relay

NOTICE

Remember the **overcurrent relay** monitors the current flowing from the **U, O and V Output Terminal Lugs** to the load.

In the event of a short circuit or over current condition, it will automatically trip the 150 amp main breaker.

To restore power to the **Output Terminal Panel**, press the reset button on the overcurrent relay and place the **main** circuit breaker in the **closed** position (**ON**).

SINGLE PHASE LOAD

Always be sure to check the nameplate on the generator and equipment to insure the wattage, amperage, frequency, and voltage requirements are satisfactorily supplied by the generator for operating the equipment.

Generally, the wattage listed on the nameplate of the equipment is its rated output. Equipment may require 130—150% more wattage than the rating on the nameplate, as the wattage is influenced by the efficiency, power factor and starting system of the equipment.

NOTICE

If wattage is not given on the equipment's nameplate, approximate wattage may be determined by multiplying nameplate voltage by the nameplate amperage.

$$\text{WATTS} = \text{VOLTAGE} \times \text{AMPERAGE}$$

The power factor of this generator is 0.8. See Table 5 below when connecting loads.

Table 5. Power Factor By Load

Type of Load	Power Factor
Single-phase induction motors	0.4-0.75
Electric heaters, incandescent lamps	1.0
Fluorescent lamps, mercury lamps	0.4-0.9
Electronic devices, communication equipment	1.0
Common power tools	0.8

Table 6. Cable Selection (60 Hz, Single Phase Operation)

Current in Amperes	Load in Watts		Maximum Allowable Cable Length			
	At 100 Volts	At 200 Volts	#10 Wire	#12 Wire	#14 Wire	#16 Wire
2.5	300	600	1000 ft.	600 ft.	375 ft.	250 ft.
5	600	1200	500 ft.	300 ft.	200 ft.	125 ft.
7.5	900	1800	350 ft.	200 ft.	125 ft.	100 ft.
10	1200	2400	250 ft.	150 ft.	100 ft.	
15	1800	3600	150 ft.	100 ft.	65 ft.	
20	2400	4800	125 ft.	75 ft.	50 ft.	

CAUTION: Equipment damage can result from low voltage

NOTICE

Motors and motor-driven equipment draw much greater current for starting than during operation.

An inadequate size connecting cable which cannot carry the required load can cause a voltage drop which can burn out the appliance or tool and overheat the cable. See Table 6.

- When connecting a resistance load such as an incandescent lamp or electric heater, a capacity of up to the generating set's rated output (kW) can be used.
- When connecting a fluorescent or mercury lamp, a capacity of up to the generating set's rated output (kW) multiplied by 0.6 can be used.
- When connecting an electric drill or other power tools, pay close attention to the required starting current capacity.

When connecting ordinary power tools, a capacity of up to the generating set's rated output (kW) multiplied by 0.8 can be used.

DANGER

Before connecting this generator to any building's electrical system, a **licensed electrician** must install an **isolation (transfer) switch**. Serious damage to the building's electrical system may occur without this transfer switch.

AC AMMETER GAUGE READING

HOW TO READ THE AC AMMETER GAUGE

The AC ammeter gauge is controlled by the AC ammeter change-over switch.

This switch is located on the control panel and **does not** effect the generator output. It is provided to help observe how much power is being supplied, produced at the UOV terminal lugs.

AC Ammeter Gauge Reading

Place the **AC Ammeter Change-Over Switch** (Figure 13) in the U position and observe the current reading (load drain) on the U terminal as indicated on the **AC Ammeter Gauge**. This process can be repeated for terminal V.

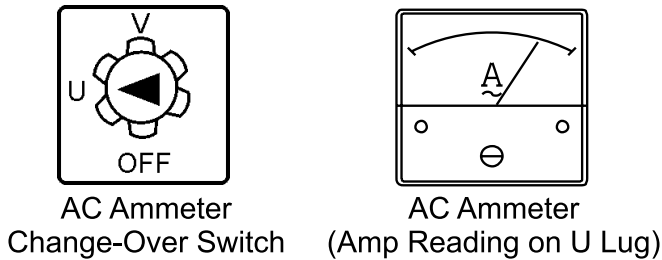

Figure 13. Current Reading (Load Drain)

NOTICE

The **ammeter** gauge will only show a reading when the **Output Terminal Lugs** are connected to a load and is in use.

OUTPUT TERMINAL PANEL CONNECTIONS

UOV TERMINAL OUTPUT VOLTAGES

240/120V output voltages can be obtained using the **output terminal lugs**.

The voltage regulator (VR), Figure 15 allows the user to increase or decrease the selected voltage.

1Ø-240 Output Terminal Voltage

1. Connect the load wires to the output terminal lugs as shown in Figure 14.

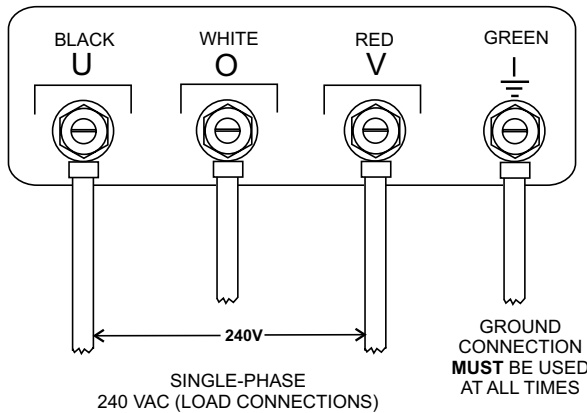

**Figure 14. Output Terminal Lugs
1Ø-240V Connections**

2. Turn the voltage regulator knob (Figure 15) clockwise to increase voltage output, turn counterclockwise to decrease voltage output. Use voltage regulator adjustment knob whenever fine tuning of the output voltage is required.



Figure 15. Voltage Regulator Knob

1Ø-120 Output Terminal Voltage

1. Connect the load wires to the output terminal lugs as shown in Figure 16.

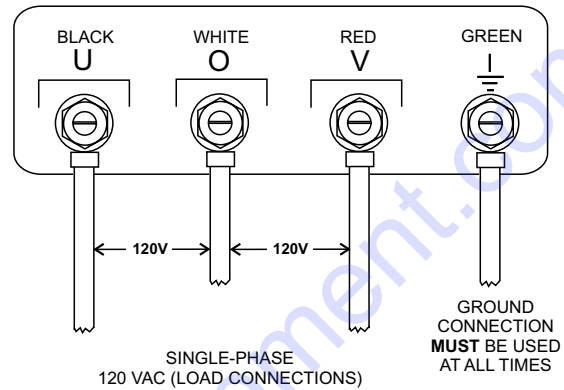

**Figure 16. Output Terminal Lugs
1Ø-120V Connections**

NOTICE

ALWAYS make sure that the connections to the UOV terminals are **secure** and **tight**. The possibility of arcing exists, that could cause a fire.

2. Turn the voltage regulator knob (Figure 15) clockwise to increase voltage output, turn counterclockwise to decrease voltage output.

OUTPUT TERMINAL PANEL CONNECTIONS

CIRCUIT BREAKERS

To protect the generator from an overload, a 3-pole, 150 amp, main circuit breaker is provided to protect the **U, O, and V Output Terminals** from overload. In addition, two single-pole, 20 amp **GFCI** circuit breakers are provided to protect the GFCI receptacles from overload. Two 50 amp **load** circuit breakers have also been provided to protect the auxiliary receptacles from overload. Make sure to switch **ALL** circuit breakers to the **OFF** position prior to starting the engine.

LUBRICATION OIL

Fill the engine crankcase with lubricating oil through the filler hole, but **DO NOT** overfill. Make sure the generator is level and verify that the oil level is maintained between the two notches (Figure 17) on the dipstick. See Table 7 for proper selection of engine oil.

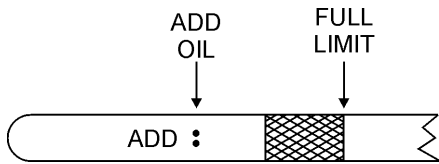

Figure 17. Engine Oil Dipstick

When checking the engine oil, be sure to check if the oil is clean. If the oil is not clean, drain the oil by removing the oil drain plug, and refill with the specified amount of oil as outlined in the **Isuzu Engine Owner's Manual**. Oil should be warm before draining.

Delo® engine oil is the recommended engine oil for this generator. When replacing engine oil please refill using Delo® 400 LE SAE 15W-40 (API CJ-4) engine oil.

Table 7. Recommended Motor Oil		OIL: SAE	
°F	°C	Oil Grade	Oil Grade
122	50	10W/40	30
104	40	10W/40	30
86	30	10W/40	30
68	20	10W/40	30
50	10	10W/40	30
32	0	10W/40	30
-14	-10	ARCTIC OIL	5W/30
-4	-20	ARCTIC OIL	5W/30
-22	-30	ARCTIC OIL	5W/30
-40	-40	ARCTIC OIL	5W/30
			10W/40
			15W/30
			10W/30
			10W
			20W/40

FUEL CHECK

! DANGER

Fuel spillage on a **hot** engine can cause a **fire** or **explosion**. If fuel spillage occurs, wipe up the spilled fuel completely to prevent fire hazards. **NEVER** smoke around or near the generator.

Refilling the Fuel System

! CAUTION

ONLY properly trained personnel who have read and understand this section should refill the fuel tank system.

This generator has an internal fuel tank (Figure 18) located inside the enclosure and may also be equipped with a trailer mounted fuel tank. **ALWAYS** fill the fuel tank with clean fresh **#2 diesel fuel**. **DO NOT** fill the fuel tank beyond its capacity.

Pay attention to the fuel tank capacity when replenishing fuel. The fuel tank cap must be closed tightly after filling. Handle fuel in a safety container. If the container does not have a spout, use a funnel. Wipe up any spilled fuel immediately.

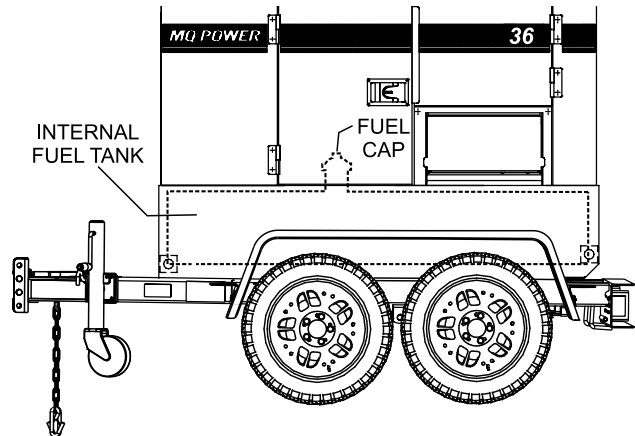

Figure 18. Fuel Tank

INSPECTION/SETUP

Refueling Procedure:

WARNING



Diesel fuel and its vapors are dangerous to your health and the surrounding environment. Avoid skin contact and/or inhaling fumes.

- Level Tanks** — Make sure fuel cells are level with the ground. Failure to do so will cause fuel to spill from the tank before reaching full capacity (Figure 19).

CAUTION

ALWAYS place trailer on firm level ground before refueling to prevent spilling and maximize the amount of fuel that can be pumped into the tank.

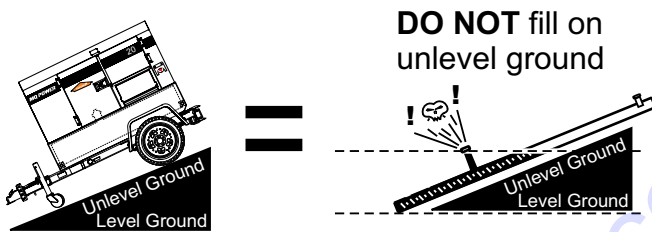

Figure 19. Only Fill on Level Ground

NOTICE

ONLY use #2 diesel fuel when refueling.

- Open cabinet doors on the “right side” of the generator (from generator control panel position). Remove fuel cap and fill tank (Figure 20).

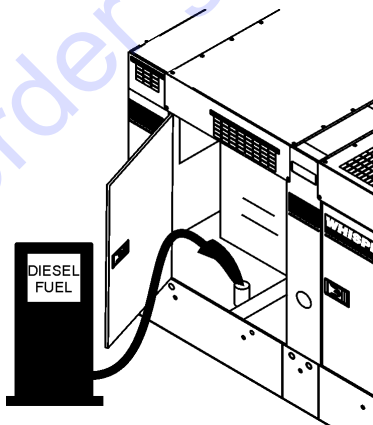

Figure 20. Fueling the Generator

- NEVER overfill fuel tank** — It is important to read the fuel gauge when filling trailer fuel tank. **DO NOT** wait for fuel to rise in filler neck (Figure 21).

FUEL GAUGE LOCATED ON CONTROL PANEL

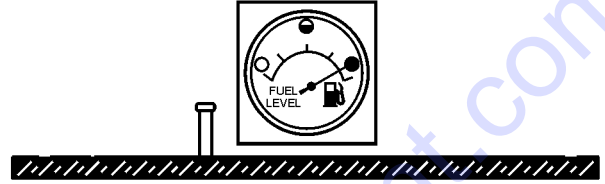

Figure 21. Full Fuel Tank

CAUTION

DO NOT OVERFILL fuel system. Leave room for fuel expansion. Fuel expands when heated (Figure 22).

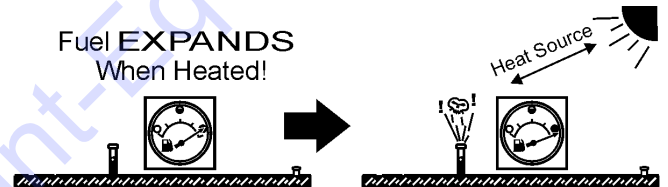



Figure 22. Fuel Expansion

COOLANT (ANTIFREEZE/SUMMER COOLANT/WATER)

Isuzu recommends antifreeze/summer coolant for use in their engines, which can be purchased in concentrate (and mixed with 50% demineralized water) or pre-diluted. See the **Isuzu Engine Owner's Manual** for further details.

WARNING



If adding coolant/antifreeze mix to the radiator, **DO NOT** remove the radiator cap until the unit has completely cooled. The possibility of **hot!** coolant exists which can cause severe burns.

Day-to-day addition of coolant is done from the recovery tank. When adding coolant to the radiator, **DO NOT** remove the radiator cap until the unit has completely cooled. See Table 8 for engine, radiator, and recovery tank coolant capacities.

NOTICE

Normally, only the coolant level in the recovery tank needs to be checked. However, the radiator cap should be opened once a week to verify that coolant is visible (full) inside the radiator.

1. Verify that the coolant level in the coolant recovery tank is between the **FULL** and **LOW** markings as shown in Figure 23.

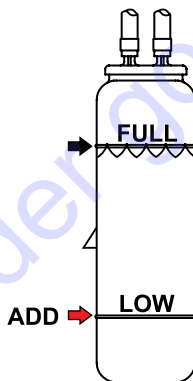

Figure 23. Coolant Recovery Tank

Table 8. Coolant Capacity	
Engine and Radiator	4.5 gal (16.8 liters)
Reserve Tank	0.24 gal (0.9 liters)

Operation in Freezing Weather

When operating in freezing weather, be certain the proper amount of antifreeze (Table 9) has been added.

Table 9. Anti-Freeze Operating Temperatures		
Vol % Anti-Freeze	Freezing Point	
	°C	°F
50	-37	-34

Cleaning the Radiator

The engine may overheat if the radiator fins become overloaded with dust or debris. Periodically clean the radiator fins with compressed air. Cleaning inside the machine is dangerous, so clean only with the engine turned off and the **negative** battery terminal disconnected.

NOTICE

When the antifreeze is mixed with water, the antifreeze mixing ratio **must be** less than 50%.

AIR CLEANER

Periodic cleaning/replacement is necessary. Inspect air cleaner in accordance with the **Isuzu Engine Owner's Manual**.

FAN BELT TENSION

A slack fan belt may contribute to overheating, or to insufficient charging of the battery. Inspect the fan belt for damage and wear and adjust it in accordance with the **Isuzu Engine Owner's Manual**.

The fan belt tension is proper if the fan belt bends 10 to 15 mm (Figure 24) when depressed with the thumb as shown below.

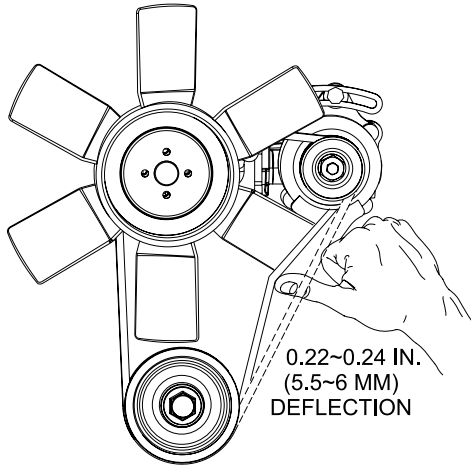



Figure 24. Fan Belt Tension

CAUTION

NEVER place hands near the belts or fan while the generator set is running.



BATTERY

This unit is of negative ground **DO NOT** connect in reverse. Always maintain battery fluid level between the specified marks. Battery life will be shortened, if the fluid level is not properly maintained. Add only distilled water when replenishment is necessary.

DO NOT over fill. Check to see whether the battery cables are loose. Poor contact may result in poor starting or malfunctions. **Always** keep the terminals firmly tightened. Coating the terminals with an approved battery terminal treatment compound. Replace battery with only recommended type battery. The battery type used in this generator is BCI Group 27.

The battery is sufficiently charged if the specific gravity of the battery fluid is 1.28 (at 68° F). If the specific gravity should fall to 1.245 or lower, it indicates that the battery is dead and needs to be recharged or replaced.

Before charging the battery with an external electric source, be sure to disconnect the battery cables.

Battery Cable Installation

ALWAYS be sure the battery cables (Figure 25) are properly connected to the battery terminals as shown below. The **red cable** is connected to the positive terminal of the battery, and the **black cable** is connected to the negative terminal of the battery.

CAUTION

ALWAYS disconnect the negative terminal **FIRST** and reconnect negative terminal **LAST**.

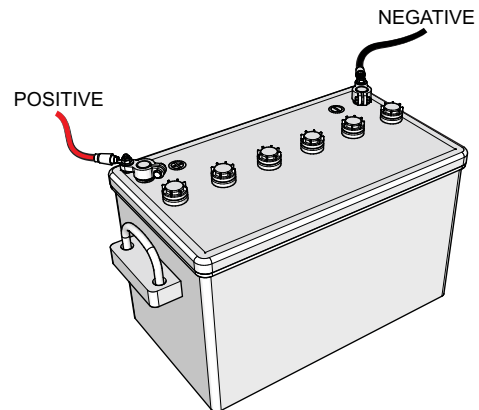

Figure 25. Battery Connections

GENERATOR START-UP PROCEDURE (MANUAL MODE)

When connecting battery do the following:

1. **NEVER** connect the battery cables to the battery terminals when the **Auto-Off/Reset-Manual Switch** is in either the **AUTO** or **MANUAL** position. **ALWAYS** make sure that this switch is in the **OFF/RESET** position when connecting the battery.
2. Place a small amount of battery terminal treatment compound around both battery terminals. This will ensure a good connection and will help prevent corrosion around the battery terminals.

NOTICE

If the battery cable is connected incorrectly, electrical damage to the generator will occur. Pay close attention to the polarity of the battery when connecting the battery.

CAUTION

Inadequate battery connections may cause poor starting of the generator, and create other malfunctions.

ALTERNATOR

The polarity of the alternator is negative grounding type. When an inverted circuit connection takes place, the circuit will be in short circuit instantaneously resulting the alternator failure.

DO NOT put water directly on the alternator. Entry of water into the alternator can cause corrosion and damage the alternator.

WIRING

Inspect the entire generator for bad or worn electrical wiring or connections. If any wiring or connections are exposed (insulation missing) replace wiring immediately.

PIPING AND HOSE CONNECTION

Inspect all piping, oil hose, and fuel hose connections for wear and tightness. Tighten all hose clamps and check hoses for leaks.

If any hose (**fuel or oil**) lines are defective, replace them immediately.

GENERATOR START-UP PROCEDURE (MANUAL MODE)

BEFORE STARTING

CAUTION

The engine's exhaust contains harmful emissions. **ALWAYS** have adequate ventilation when operating. Direct exhaust away from nearby personnel.

WARNING

NEVER manually start the engine with the **main, GFCI or auxiliary** circuit breakers in the **ON** (closed) position.

1. Place the **main, G.F.C.I., and aux.** circuit breakers (Figure 26) in the **OFF** position prior to starting the engine.

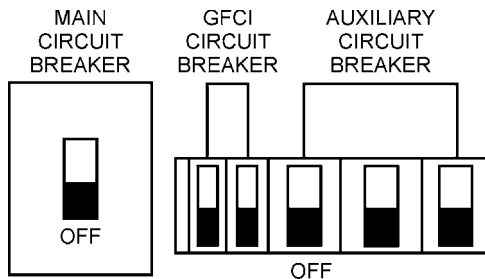

Figure 26. Main, Aux. and GFCI Circuit Breakers (OFF)

2. Connect the load to the **receptacles** or the **output terminal lugs** as shown in Figure 11. Tighten terminal nuts securely to prevent load wires from slipping out.
3. Close all engine enclosure doors (Figure 27).

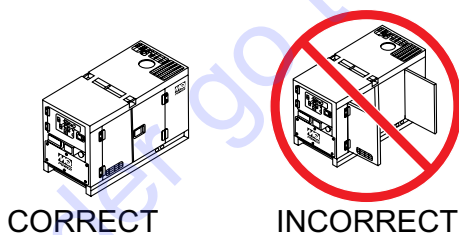

Figure 27. Engine Enclosure Doors

STARTING (MANUAL)

1. On the control box, place the diagnostic switch (Figure 29) in the **OFF** (down) position.



Figure 28. Diagnostic Switch (High)

2. Place the engine speed switch (Figure 29) in the **LOW** (down) position.



Figure 29. Engine Speed Switch (Low)

3. Place the **Auto-Off/Reset Manual Switch** in the **MANUAL** position to start the engine (Figure 30).



Figure 30. Auto-Off/Reset Manual Switch (Manual Position)

4. Depending on the temperature of the coolant (cold weather conditions), the pre-heat lamp (Figure 31) will light (**ON**) and remain on until the pre-heating cycle has been completed. After completion of the pre-heating cycle, the light will go **OFF** and the engine will start up automatically.

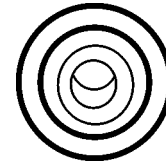

Figure 31. Pre-Heat Lamp

5. Once the engine starts, let the engine run for 1-2 minutes (let engine idle longer in cold weather conditions). Listen for any abnormal noises. If any abnormalities exist, shut down the engine and correct the problem.

NOTICE

In cold weather conditions warm up the engine 5-7 minutes before placing into operation.

GENERATOR START-UP PROCEDURE (MANUAL MODE)

- Verify that the engine started status LED on the ECU controller is on.

NOTICE

If the engine fails to start after 3 attempts, the over-crank LED on the ECU controller will turn on and the Auto-Off/Reset Switch must be placed in the Off/Reset position before the engine can be restarted.

- If the engine is running smoothly, place the engine speed switch (Figure 32) in the **HIGH** (up) position.



Figure 32. Engine Speed Switch (High)

- The generator's frequency meter (Figure 33) should be displaying the 60 cycle output frequency in **HERTZ**.

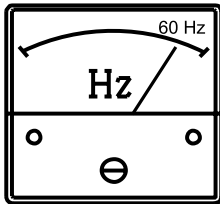

Figure 33. Frequency Meter

- The generator's AC-voltmeter (Figure 34) will display the generator's output in **VOLTS**.

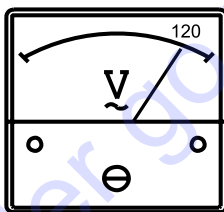

Figure 34. Voltmeter

- If the voltage is not within the specified tolerance, use the voltage adjustment control knob (Figure 35) to increase or decrease the desired voltage.

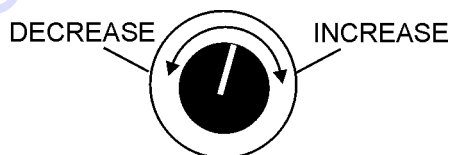

Figure 35. Voltage Adjust Control Knob

- The ammeter (Figure 36) will indicate **zero amps** with no load applied. When a load is applied, the ammeter will indicate the amount of current that the load is drawing from the generator.

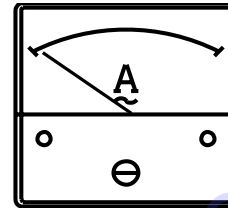

Figure 36. Ammeter (No Load)

- The engine oil pressure gauge (Figure 37) will indicate the oil pressure of the engine. Under normal operating conditions the oil pressure is approximately 50 psi. (345 kPa).

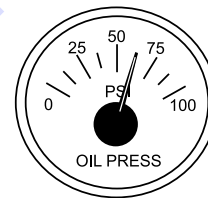

Figure 37. Oil Pressure Gauge

- The **coolant temperature gauge** (Figure 38) will indicate the coolant temperature. Under normal operating conditions, the coolant temperature should be approximately 180°F (82°C).

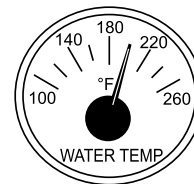

Figure 38. Coolant Temperature Gauge

GENERATOR START-UP PROCEDURE (MANUAL MODE)

14. The **tachometer gauge** (Figure 39) will indicate the speed of the engine when the generator is operating. Under normal operating conditions, this speed is approximately 1800 RPM's.

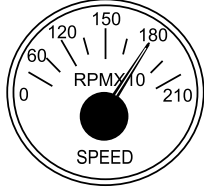

Figure 39. Engine Tachometer Gauge

15. Place the **main, GFCI, and aux.** circuit breakers in the **ON** position (Figure 40).

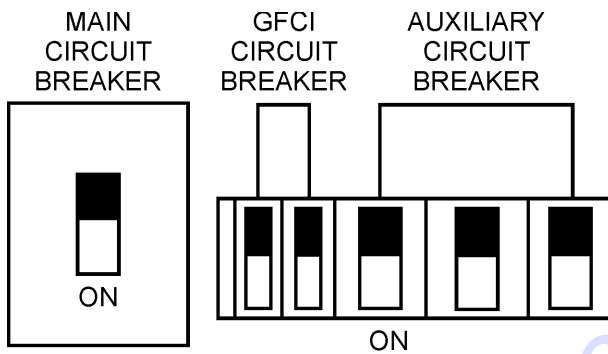

Figure 40. Main, Aux. and GFCI Circuit Breakers (ON)

16. Observe the generator's ammeter (Figure 41) and verify it reads the anticipated amount of current with respect to the load. The ammeter will only display a current reading if a load is in use.

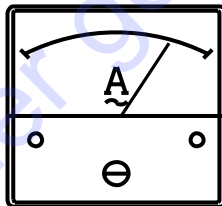

Figure 41. Ammeter (Load)

17. The generator will run until manually stopped or an abnormal condition occurs.

GENERATOR START-UP PROCEDURE (AUTO MODE)

DANGER



Before connecting this generator to any building's electrical system, a **licensed electrician** must install an **isolation (transfer) switch**. Serious damage to the building's electrical system may occur without this transfer switch.

NOTICE

When connecting the generator to a isolation (transfer) switch, **ALWAYS** have power applied to the generator's internal battery charger. This will ensure that the engine will not fail due to a dead battery.

NOTICE

When the **Auto Off/Reset Manual** switch is placed in the **AUTO** mode, the generator will **automatically start** in the event of commercial power falling below a prescribed level by means of a contact closure that is generated automatically by a transfer switch.

In this position (**AUTO**), should an outage occur, the automatic transfer switch (ATS) will start the generator automatically via the generator's auto-start contacts connected to the ATS's start contacts.

Please refer to your ATS installation manual for further instructions for the correct installation of the auto-start contacts of the generator to the ATS.

WARNING

When running the generator in the **AUTO** mode, remember the generator can start up at any time without warning. **NEVER** attempt to perform any maintenance when the generator is in the auto mode.

NOTICE

When the **Auto Off/Reset Manual** switch is placed in the **AUTO** position, the engine glow plugs will be warmed and the engine will start automatically.

NOTICE

The engine speed switch **must** be set to the "High" position when running in the **auto-start** mode. Failing to set the switch in the proper position can result in damage to your generator when it turns on.

STARTING (AUTO MODE)

When starting generator in **AUTO** mode use the "Manual Start-up" procedure except where noted (see below).

1. Perform steps 1 through 5 in the Before Starting section as outlined in the Manual Starting Procedure.
2. Place the **Auto Off/Reset Manual Switch** (Figure 42) in the **AUTO** position.



Figure 42. Auto Off/Reset Manual Switch (AUTO)

3. Continue operating the generator as outlined in the Manual Start-up procedure (start at step 7).

GENERATOR SHUT-DOWN PROCEDURES

WARNING

NEVER stop the engine suddenly except in an emergency.

NORMAL SHUTDOWN PROCEDURE

To shutdown the generator, use the following procedure:

1. Place both the **MAIN, GFCI and LOAD** circuit breakers as shown in Figure 43 to the **OFF** position.

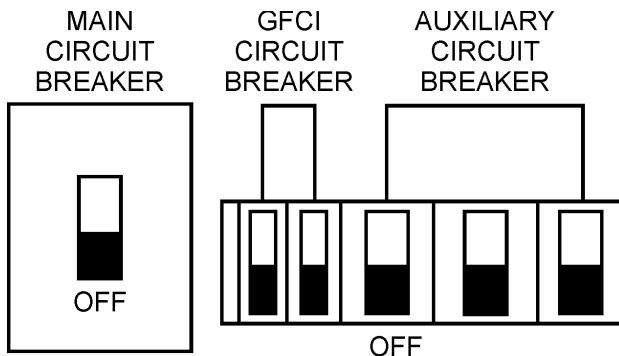

Figure 43. Main, Aux. and GFCI Circuit Breakers (OFF)

2. Let the engine cool by running it at low speed for 3-5 minutes with no load applied.
3. Place the **Auto Off/Reset Manual Switch** (Figure 44) in the **OFF/RESET** position.



Figure 44. Auto Off/Reset Manual Switch (Off/Reset)

4. Verify that all status LEDs on the ECU control panel are **OFF** (not lit).
5. Remove all loads from the generator.
6. Inspect entire generator for any damage or loosening of components that may have occurred during operation.

EMERGENCY SHUTDOWN PROCEDURE

NOTICE

The Emergency Stop Pushbutton Switch should only be used to stop the engine in case of an emergency or to lock out operation during service. The emergency stop switch should **NEVER** be used for routine stopping of the engine.

1. To stop the engine in the event of an emergency, push the **Emergency Stop Pushbutton Switch** (Figure 45).

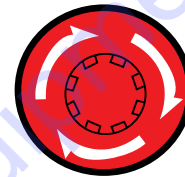

Figure 45. Emergency Stop Button

2. The emergency stop switch is a push-locked type switch. The switch contact can only be released by rotating the button in the clockwise direction. The engine can not be restarted until the contact is released (**closed**).
3. Place the **MAIN, GFCI and LOAD** circuit breakers as shown in Figure 43 to the **OFF** position.

AUTOMATIC SHUTDOWN SYSTEM

This unit is equipped with safety devices to automatically stop the engine in the event of low oil pressure, approximately 14 psi (97 kPa), high water temperature, approximately 212°F (100°C), or overspeed approximately +15%. The alarm lamps on the ECU illuminate to signify the reason for the shutdown.

NOTICE

Before inspecting the generator, check that the Auto/Manual switch is in the **OFF/RESET** position, and place all circuit breakers in the **OFF** position. Allow sufficient time for adequate cooling. When ready to restart, complete all steps in the Generator Startup Procedure section of this manual.

MAINTENANCE

Table 10. Inspection/Maintenance		10 Hrs DAILY	250 Hrs	500 Hrs or Every 12 Months	3000 Hrs or Every 36 Months	OTHER
Engine	Check Engine Oil and Coolant Levels	X				
	Check Fuel Filter/Water Separator Bowl	X				
	Check Air Cleaner/Element	X				
	Exhaust System* ⁵		X			
	Check for Leaks/Hoses/Clamps* ⁴	X				
	Check for Loosening of Parts	X				
	Change Engine Oil and Oil Filter * ¹		X			
	Clean Unit, Inside and Outside		X			
	Replace Fuel Filter Elements			X		
	Check Engine Mounts			X		
	Service Battery			X		
	Check Air Intake Hoses			X		
	Check Fan Belt Condition			X		
	Check Automatic Belt Tensioner			X		
	Check Electrical Ground Connection			X		
	Clean Radiator, Check Cooling System			X		
	Coolant Solution Analysis, Add SCA's As Required			X		
	Pressure Test Cooling System			X		
	Check Engine Speed			X		
	Test Thermostats				X	
	Check and Adjust Engine Valve Clearance				X	
	Test Glow Plugs				X	
	Flush and Refill Cooling System* ²					2 yrs. or 2000 hrs.
	Clean Inside of Fuel Tank					1000 hrs.
Check Crankcase Ventilation Filter					1500 hrs.	
Replace Air Cleaner Elements * ³					As Required	
Generator	Measure Insulation Resistance Over 3M ohms		X			
	Check Rotor Rear Support Bearing			X		

*¹ During initial operation of a new engine, change oil and filter between a minimum of 100 hrs. and a maximum of 250 hrs. Service interval depends on type of oil.

*² Add "Supplemental Coolant Additives (SCA'S)" to recharge the engine coolant.

*³ Replace primary air filter element when restriction indicator shows a vacuum of 625 mm (25 in. H₂O).

*⁴ If blowby hose needs to be replaced, ensure that the slope of the blowby hose is at least a 1/2 inch per foot, with no sags or dips that could collect moisture and/or oil.

*⁵ Accumulation of carbon (soot, unburned fuel) in the exhaust pipe line and muffler could cause not only system derates but also could lead to fire incident. To destroy the soot and unburned fuel, run the unit at rated power for some period of time until the exhaust gas become mostly colorless every 250 hours operation time. The carbon will be easier to be generated when the unit operates at less then 30% of rated power. In this case, perform the above procedures at shorter interval time.

NOTICE

Before inspecting generator, check that the Auto/Manual switch is in the **OFF/RESET** position, and place all circuit breakers in the **OFF** position. Allow sufficient time for adequate cooling. When ready to restart, complete all steps in the Generator Startup Procedure section of this manual.

GENERAL INSPECTION

Prior to each use, the generator should be cleaned and inspected for deficiencies. Check for loose, missing or damaged nuts, bolts or other fasteners. Also check for fuel, oil, and coolant leaks. Use Table 10 as a general maintenance guideline **Engine Side** (Refer to the Engine Instruction Manual).

AIR CLEANER

Every 250 hours: Remove air cleaner element (Figure 46) and clean the heavy duty paper element with light spray of compressed air. Replace the air cleaner as needed.

Air Cleaner with Dust Indicator

This indicator (Figure 46) is attached to the air cleaner. When the air cleaner element is clogged, air intake restriction becomes greater and the dust indicator signal shows **RED** meaning the element needs changing or service. After changing the air element, press the dust indicator button to reset the indicator.

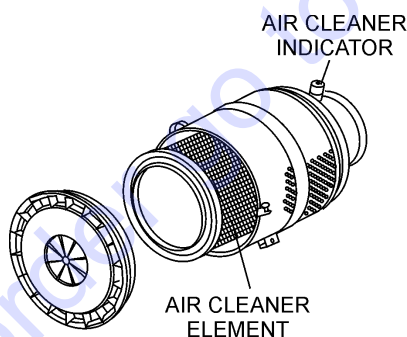

Figure 46. Air Cleaner/Indicator

NOTICE

The air filter should not be changed until the indicator reads "**RED**". Dispose of old air filter. It may not be cleaned or reused.

If the engine is operating in very **dusty** or **dry grass** conditions, a clogged air cleaner will result. This can lead to a loss of power, excessive carbon buildup in the combustion chamber and high fuel consumption. Change air cleaner more **frequently** if these conditions exist.

FUEL ADDITION

Add diesel fuel (the grade may vary according to season and locations).

Removing Water from the Fuel Tank

After prolonged use, water and other impurities accumulate in the bottom of the tank. Occasionally inspect the fuel tank for water contamination and drain the contents if required.

During cold weather, the more empty volume inside the tank, the easier it is for water to condense. This can be reduced by keeping the tank full with diesel fuel.

Cleaning Inside the Fuel Tank

Drain the fuel inside the fuel tank completely. Using a spray washer (Figure 47) wash out any deposits or debris that have accumulated inside the fuel tank.

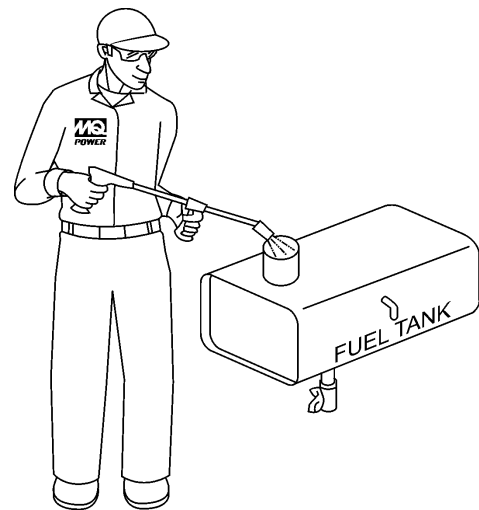

Figure 47. Fuel Tank Cleaning

FUEL TANK INSPECTION

In addition to cleaning the fuel tank, the following components should be inspected for wear:

- **Rubber Suspension** — look for signs of wear or deformity due to contact with oil. Replace the rubber suspension if necessary.
- **Fuel Hoses** — inspect nylon and rubber hoses for signs of wear, deterioration and hardening.
- **Fuel Tank Lining** — inspect the fuel tank lining for signs of excessive amounts of oil or other foreign matter.

Replacing Fuel Filter

- Replace the fuel filter cartridge with new one every 500 hours or so.
- Loosen the drain plug at the lower top of the fuel filter. Drain the fuel in the fuel body together with the mixed water. **DO NOT** spill the fuel during disassembly.
- Vent any air.

AIR REMOVAL

If air enters the fuel injection system of a diesel engine, starting becomes impossible. After running out of fuel, or after disassembling the fuel system, bleed the system according to the following procedure. See the **Isuzu Engine Manual** for details.

To restart after running out of fuel, turn the switch to the “**ON**” position for 15-30 seconds. Try again, if needed. This unit is equipped with an automatic air bleeding system.

EMISSION CONTROL

Diesel Oxidation Catalyst (DOC)

The DOC does not filter particles it oxidizes them. This catalyst (honeycomb like structure) uses a chemical process to break down pollutants in the exhaust stream into less harmful components. In general, this catalyst collects/burns accumulated particulates. The DOC contains palladium and platinum which serve as a catalysts to oxidize hydrocarbons and carbon monoxide. Replace DOC as required.

CHECK OIL LEVEL

Check the crankcase oil level prior to each use, or when the fuel tank is filled. Insufficient oil may cause severe damage to the engine. Make sure the generator is level. The oil level must be between the two notches on the dipstick as shown in Figure 17.

Replacing Oil Filter

- Remove the old oil filter.
- Apply a film of oil to the gasket on the new oil filter.
- Install the new oil filter.
- After the oil cartridge has been replaced, the engine oil will drop slightly. Run the engine for a while and check for leaks before adding more oil if needed. Clean excessive oil from engine.

FLUSHING OUT RADIATOR AND REPLACING COOLANT

- Open both cocks located at the crankcase side and at the lower part of the radiator and drain coolant. Open the radiator cap while draining. Remove the overflow tank and drain.
- Check hoses for softening and kinks. Check clamps for signs of leakage.
- Tighten both cocks and replace the overflow tank.
- Replace with coolant as recommended by the engine manufacturer.
- Close radiator cap tightly.
- Flush the radiator by running clean tap water through radiator until signs of rust and dirt are removed. **DO NOT** clean radiator core with any objects, such as a screwdriver.

WARNING



Allow engine to **cool** when flushing out radiator. Flushing the radiator while hot could cause serious burns from water or steam.

RADIATOR CLEANING

The radiator (Figure 48) should be sprayed (cleaned) with a high pressure washer when excessive amounts of dirt and debris have accumulated on the cooling fins or tube. When using a high pressure washer, stand at least 5 feet (1.5 meters) away from the radiator to prevent damage to the fins and tube.

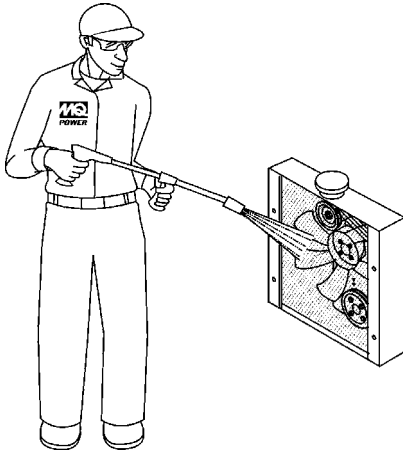

Figure 48. Radiator Cleaning

TESTING THE GFCI RECEPTACLE

NOTICE

The GFCI receptacle is designed to interrupt power when a ground fault exists to prevent injuries and shock hazards. **DO NOT** use the GFCI receptacle if the test below fails. Consult a qualified electrician for repair or replacement of the GFCI receptacle. Test the GFCI receptacle **at least once a month**.

1. Start the generator as outlined in the start-up procedure in this manual.
2. Place a GFCI circuit breaker (Figure 49) in the **ON** position.

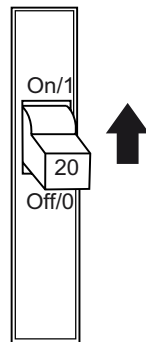

Figure 49. GFCI Circuit Breaker

3. Verify that the status LED on the corresponding GFCI receptacle (Figure 50) is **ON (GREEN)**.

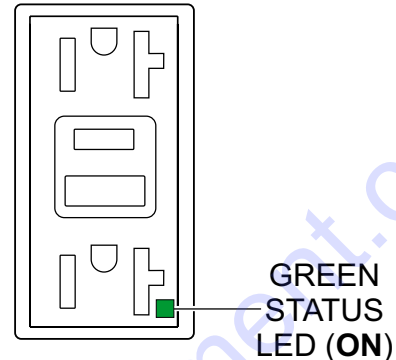

Figure 50. GFCI Receptacle (ON)

4. Press the **TEST** button (Figure 51) on the GFCI receptacle and verify that the status LED turns **OFF**.

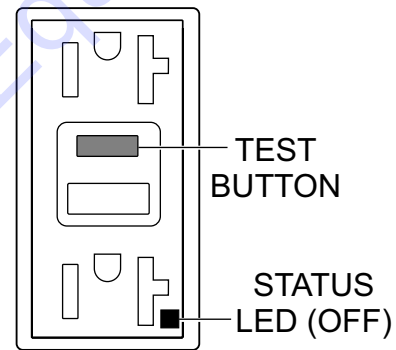

Figure 51. GFCI Receptacle (OFF)

5. Press the **RESET** button (Figure 52) to restore power to the GFCI receptacle and verify that the status LED is **ON (GREEN)**.

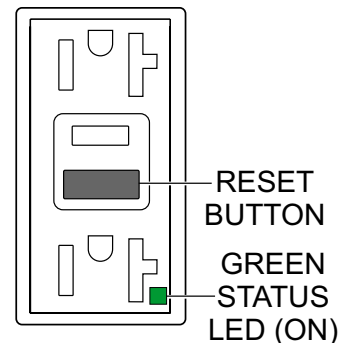

Figure 52. GFCI Receptacle (ON/Restore)

- If the status LED (Figure 53) is **flashing (RED)**, **DO NOT** use the GFCI receptacle and replace it immediately.

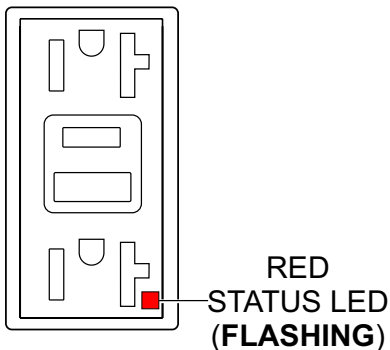

Figure 53. GFCI Receptacle (Red Flashing LED)

- Repeat the above procedure for any other GFCI receptacles.

GENERATOR STORAGE

For long term storage of the generator the following is recommended:

- Drain the fuel tank completely. Treat with a fuel stabilizer if necessary.
- Completely drain the oil from the crankcase and refill if necessary with fresh oil.
- Clean the entire generator, internal and external.
- Cover the generating set and store in a clean, dry place.
- Disconnect the battery.
- Make sure engine coolant is at proper level.
- If generator is mounted on a trailer, jack trailer up and place on blocks so tires do not touch the ground or block and completely remove the tires.

ENGINE BLOCK HEATER AND INTERNAL BATTERY CHARGER 120 VAC INPUT RECEPTACLES (OPTIONAL)

This generator can be optionally equipped with a 120 VAC, 20 amp input receptacle located on the output terminal panel.

The purpose of this receptacle is to provide power via commercial power to the internal battery charger and engine block heater.

This receptacle will **ONLY** function when commercial power has been supplied to it (Figure 54). To apply commercial power to this receptacle, a power cord of adequate size will be required (See Table 6).

When using the generator in **hot** climates there is no reason to apply power to engine block heater. However, if the generator will be used in **cold** climates, it is always a good idea to apply power to the heating element at all times.

To apply power to the engine engine block heater, simply apply power to the engine block heater receptacle via commercial power using a power cord of adequate size.

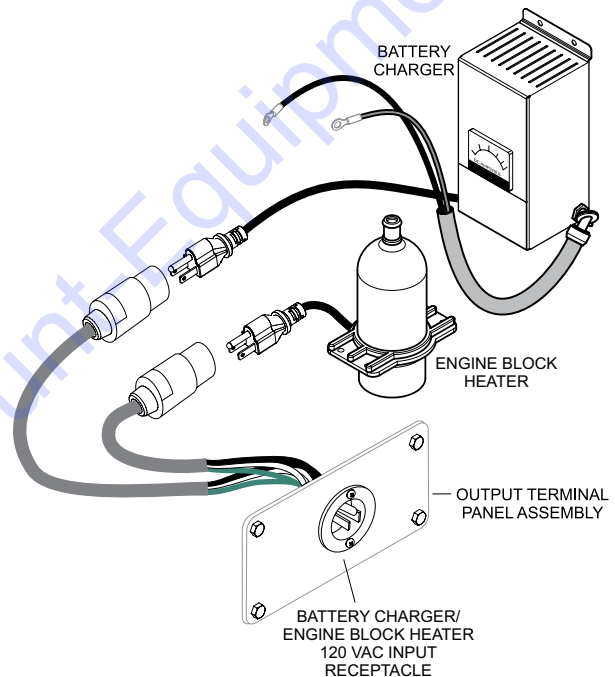

Figure 54. Battery Charger and Engine Block Heater Power Connections

If the generator will be used daily, the battery should normally not require charging. If the generator will be idle (not used) for long periods of time, apply power to the battery charger receptacle via commercial power using a power cord of adequate size.

NOTICE

If the generator will be idle (not used) for long periods of time and to ensure adequate starting capability, always have power applied to the generator's internal battery charger.

TROUBLESHOOTING DIAGNOSTICS

The engine controller of this generator diagnoses problems that arise from the engine control system and the engine itself. Press the diagnostic button on the diagnostic panel (Figure 55) to determine if an engine malfunction has occurred.

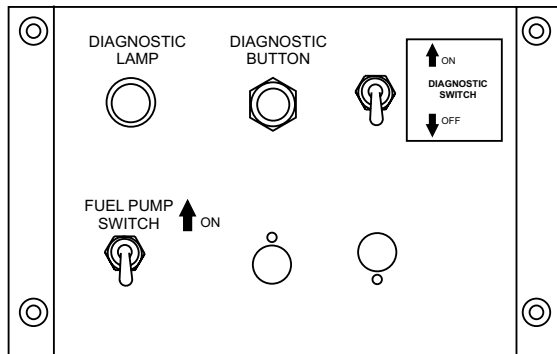

Figure 55. Diagnostic Panel

ENGINE DAULT CODE DIAGNOSTIC PROCEDURES

1. Remove all loads from the generator and place all circuit breakers in the **OFF** position.
2. Shutdown the engine and open the control panel.
3. On the control panel, place the **diagnostic switch** in the **ON** (up) position to start the diagnostic process.
4. The diagnostic lamp will light continuously indicating that there is a fault error in the engine or the engine control system.
5. Push and hold the diagnostic button (Figure 56) to identify the fault.

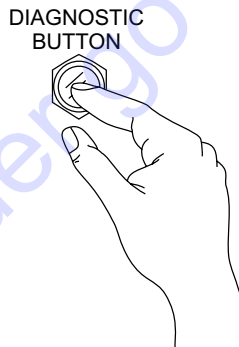

Figure 56. Diagnostic Button

6. The following will occur:

- The diagnostic lamp will start blinking with a pattern associated with the fault 3 times at an interval of 2.4 seconds.
- If there are more than 2 fault codes are detected, the diagnostic lamp will repeat the detected fault codes blinking patterns in ascending order. After all the detected fault codes are shown, it will repeat the same sequence from the beginning.
- If no fault code is detected, the diagnostic lamp will blink repeatedly at an interval of 2.4 seconds.

NOTICE

- When a fault has been detected, the fault code will automatically be saved as a previous code in the **ECM** even after the fault has been repaired.
- The diagnostic lamp indicates the current fault code with the previous fault code in ascending order.
- When a fault occurs while the engine is running, the diagnostic lamp will turn on indicating only the **current fault** has occurred. Please note that the blinking fault code pattern cannot be displayed while the engine is running.

NOTICE

For a complete understanding of error codes and troubleshooting procedures, refer to the enclosed engine instruction manual.

TROUBLESHOOTING GENERATOR

Practically all breakdowns can be prevented by proper handling and maintenance inspections, but in the event of a breakdown, use Table 11 shown below for diagnosis of the Generator. If the problem cannot be remedied, consult Discount-equipment.

Table 11. Generator Troubleshooting		
Symptom	Possible Problem	Solution
No Voltage Output	AC Voltmeter defective?	Check output voltage using a voltmeter.
	Is wiring connection loose?	Check wiring and repair.
	Is AVR defective?	Replace if necessary.
	Defective Rotating Rectifier?	Check and replace.
	Defective Exciter Field?	Check for approximately 19.6 ohms across J & K on CN1
Low Voltage Output	Is engine speed correct?	Turn engine throttle lever to "High".
	Is wiring connections loose?	Check wiring and repair.
	Defective AVR?	Replace if necessary.
High Voltage Output	Is wiring connections loose?	Check wiring and repair.
	Defective AVR?	Replace if necessary.
Circuit Breaker Tripped	Short Circuit in load?	Check load and repair.
	Over current?	Confirm load requirements and reduce.
	Defective circuit breaker?	Check and replace.
	Over current Relay actuated?	Confirm load requirement and replace.

TROUBLESHOOTING ENGINE

Troubleshooting (Engine)		
Symptom	Possible Problem	Solution
Engine will not start or start is delayed, although engine can be turned over.	No Fuel reaching injection pump?	Add fuel. Check entire fuel system.
	Defective fuel pump?	Replace fuel pump.
	Fuel filter clogged?	Replace fuel filter and clean tank.
	Faulty fuel supply line?	Replace or repair fuel line.
	Compression too low?	Check piston, cylinder and valves. Adjust or repair per engine repair manual.
	Fuel pump not working correctly?	Repair or replace fuel pump.
	Oil pressure too low?	Check engine oil pressure.
	Low starting temperature limit exceeded?	Comply with cold starting instructions and proper oil viscosity.
	Defective battery?	Charge or replace battery.
	Air or water mixed in fuel system?	Check carefully for loosened fuel line coupling, loose cap nut, etc.
At low temperatures engine will not start.	Engine oil too thick?	Refill engine crankcase with correct type of oil for winter environment.
	Defective battery?	Replace battery.
Engine fires but stops soon as starter is switched off.	Fuel filter blocked?	Replace fuel filter.
	Fuel supply blocked?	Check the entire fuel system.
	Defective fuel pump?	Replace fuel pump.
Engine stops by itself during normal operation.	Fuel tank empty?	Add fuel.
	Fuel filter blocked?	Replace fuel filter.
	Defective fuel pump?	Replace fuel pump.
	Mechanical oil pressure shutdown sensor stops the engine due to low oil?	Add oil. Replace low oil shutdown sensor if necessary.
Low engine power, output and speed.	Fuel tank empty?	Replace fuel filter.
	Fuel filter clogged?	Replace fuel filter.
	Fuel tank venting is inadequate?	Ensure that tank is adequately vented.
	Leaks at pipe unions?	Check threaded pipe unions tape and tighten unions as required.
	Speed control lever does not remain in selected position?	See engine manual for corrective action.
	Engine oil level too full?	Correct engine oil level.
	Injection pump wear?	Use No. 2-D diesel fuel only. Check the fuel injection pump element and delivery valve assembly and replace as necessary.

TROUBLESHOOTING ENGINE (CONTINUED)

Troubleshooting (Engine) - continued		
Symptom	Possible Problem	Solution
Low engine power output and low speed, black exhaust smoke.	Air filter blocked?	Clean or replace air filter.
	Incorrect valve clearances?	Adjust valves per engine specification.
	Malfunction at injector?	See engine manual.
Engine overheats.	Too much oil in engine crankcase?	Drain off engine oil down to uppermark on dipstick.
	Entire cooling air system contaminated/ blocked?	Clean cooling air system and cooling fin areas.
	Fan belt broken or elongated?	Change belt or adjust belt tension.
	Coolant insufficient?	Replenish coolant.
	Radiator net or radiator fin clogged with dust?	Clean net or fin carefully.
	Fan, radiator, or radiator cap defective?	Replace defective part.
	Thermostat defective?	Check thermostat and replace if necessary.
	Head gasket defective or water leakage?	Replace parts.

GENERATOR WIRING DIAGRAM (M184000503A)

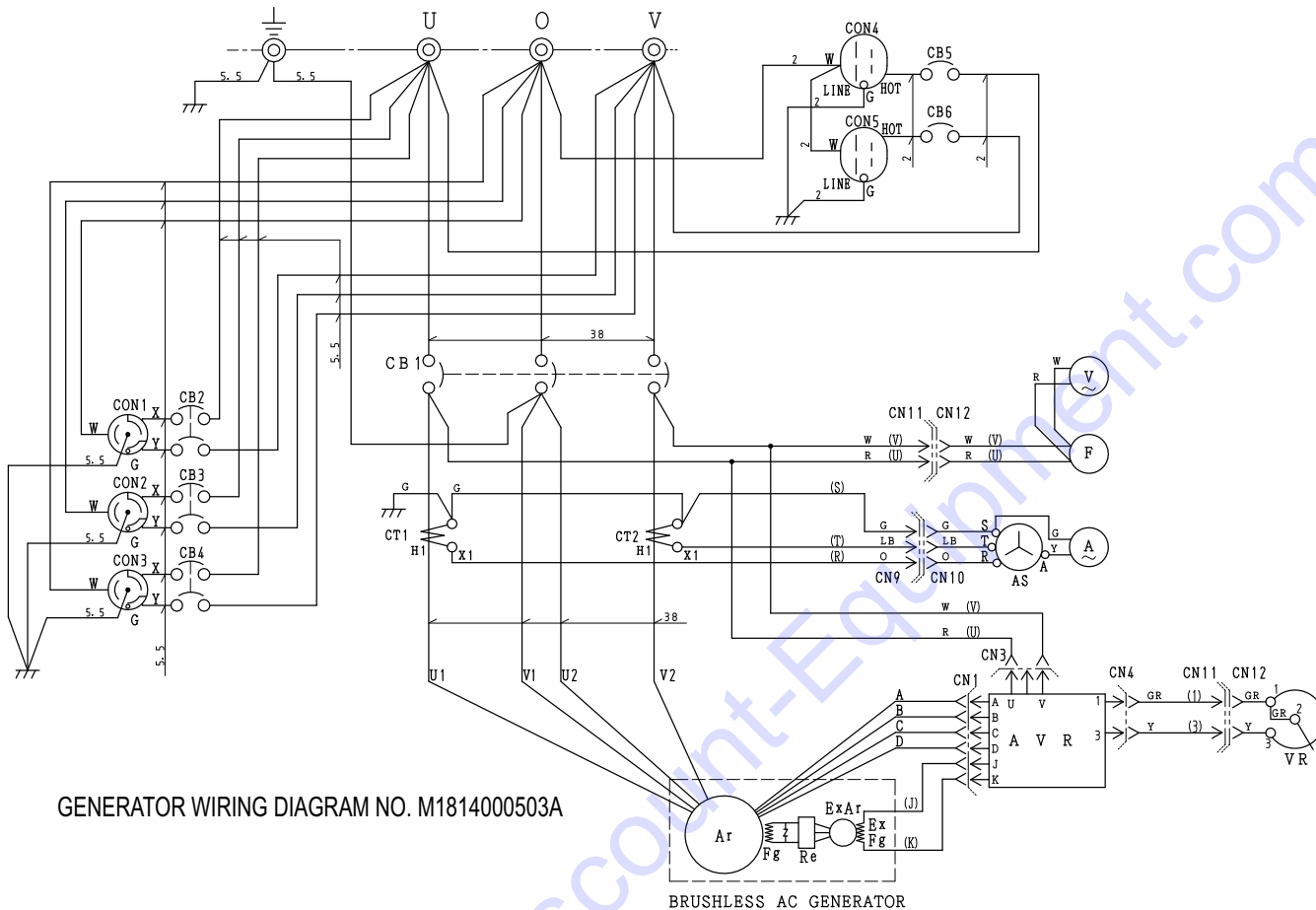

COLOR CODE			
WIRE COLOR	WIRE COLOR	WIRE COLOR	
B	BLACK	R	RED
L	BLUE	W	WHITE
BR	BROWN	Y	YELLOW
G	GREEN	LB	LIGHT BLUE
GR	GRAY	LG	LIGHT GREEN
V	VIOLET	O	ORANGE
P	PINK		

SYMBOL	DESIGNATION
Ar	MAIN GENERATOR ARMATURE WINDING
Fg	MAIN GENERATOR FIELD WINDING
ExAr	EXCITER ARMATURE WINDING
ExFg	EXCITER FIELD WINDING
Re	RECTIFIER
AVR	AUTOMATIC VOLTAGE REGULATOR
VR	VOLTAGE REGULATOR (RHEOSTAT)
CT 1,2	CURRENT TRANSFORMER
AS	CHANGE-OVER SWITCH, AMMETER
A	AC. AMMETER
V	AC. VOLTMETER
F	FREQUENCY METER
CB1	CIRCUIT BREAKER 3P 150A
CB2,3,4	CIRCUIT BREAKER 2P 50A
CB5,6	CIRCUIT BREAKER 1P 20A
CON1,2,3	RECEPTACLE, 250V @50A
CON4,5	RECEPTACLE, 125 @ 20A X 2, GFCI

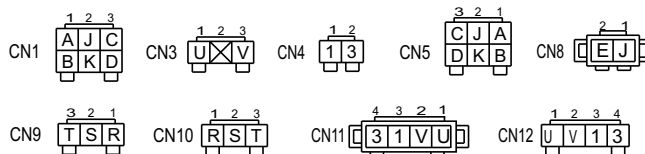

CONNECTER ARRANGEMENT (WIRING VIEW)

WIRE SIZE

38 : 38.0 MM²

5.5 : 5.5 MM²

2 : 2.0 MM²

WITH NO DESIGNATION USE LEAD 1.25 MM²

ENGINE WIRING DIAGRAM (M1814100523)

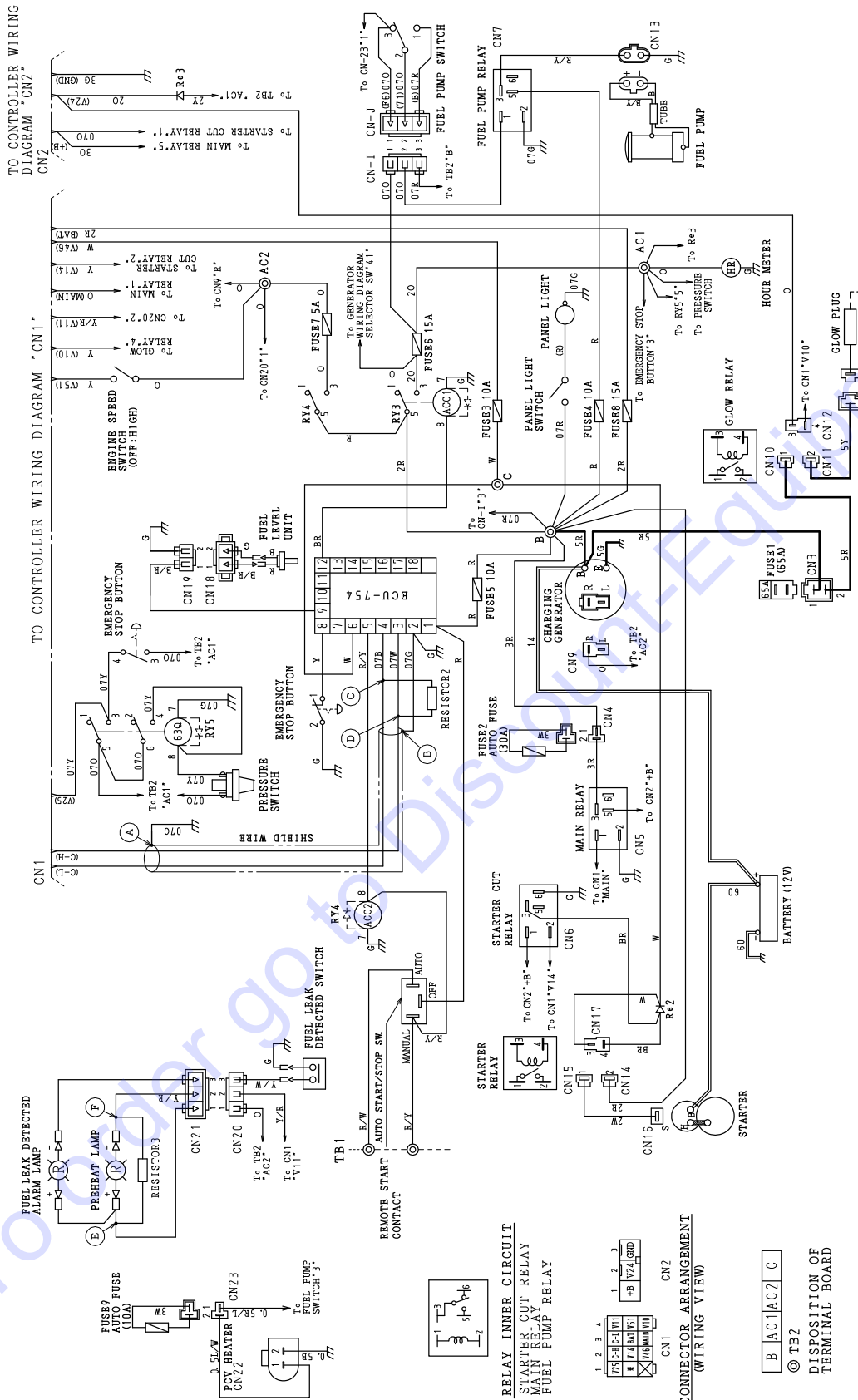

COLOR CODE

SYM	WIRE COLOR	SYM	WIRE COLOR
B	BLACK	R	RED
BL	BLUE	W	WHITE
BR	BROWN	Y	YELLOW
G	GREEN	LB	LIGHT BLUE
GR	GRAY	LG	LIGHT GREEN
V	VIOLET	O	ORANGE
P	PINK		

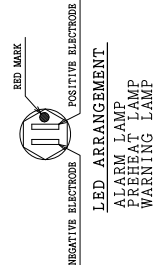

RELAY INNER CIRCUIT
STARTER CUT RELAY
MAIN RELAY
FUEL PUMP RELAY

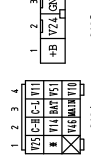

DISPOSITION OF TERMINAL BOARD

① TB2

ENGINE WIRING DIAGRAM NO. M1814100523

BATTERY CHARGER WIRING DIAGRAM (OPTION)

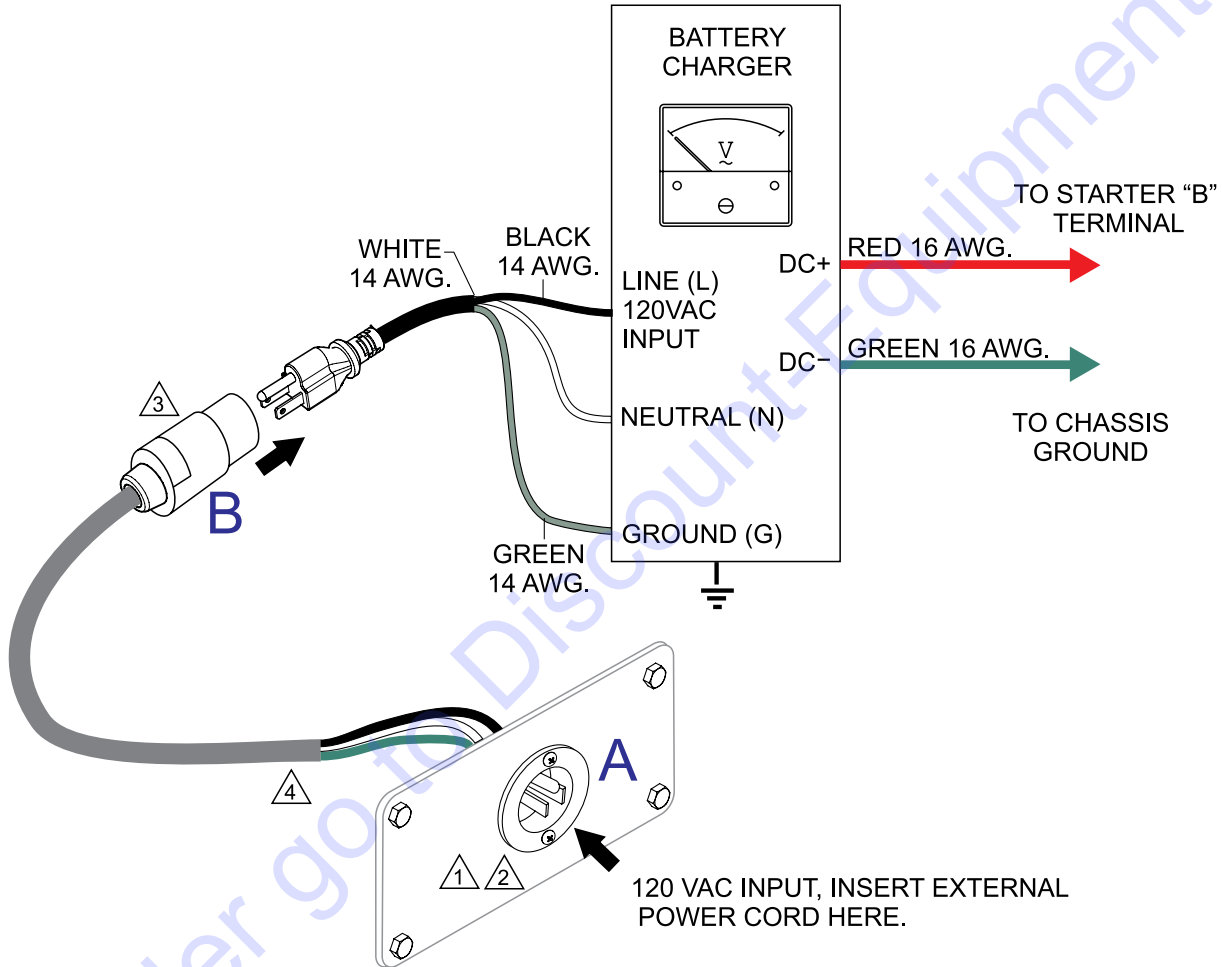
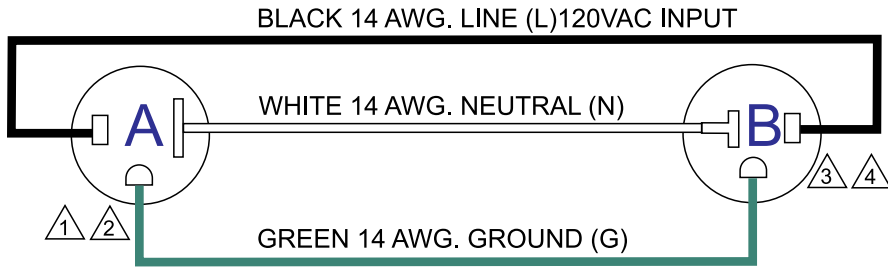

NOTES:

- ① NEMA 5-15, 15A, 120 VAC, P/N EE6176 (HBL5278C/HUBBLE RECEPTACLE).
- ② RECEPTACLE IS MOUNTED ON OUTPUT TERMINAL PANEL ASSY.
- ③ 20 AMP, 5-20R RECEPTACLE, P/N EE6131 (HBL5369C/HUBBLE RECEPTACLE).
- ④ CORD, CAROL 3/C 14 AWG., P/N EE56557.

ENGINE BLOCK HEATER WIRING DIAGRAM (OPTION)

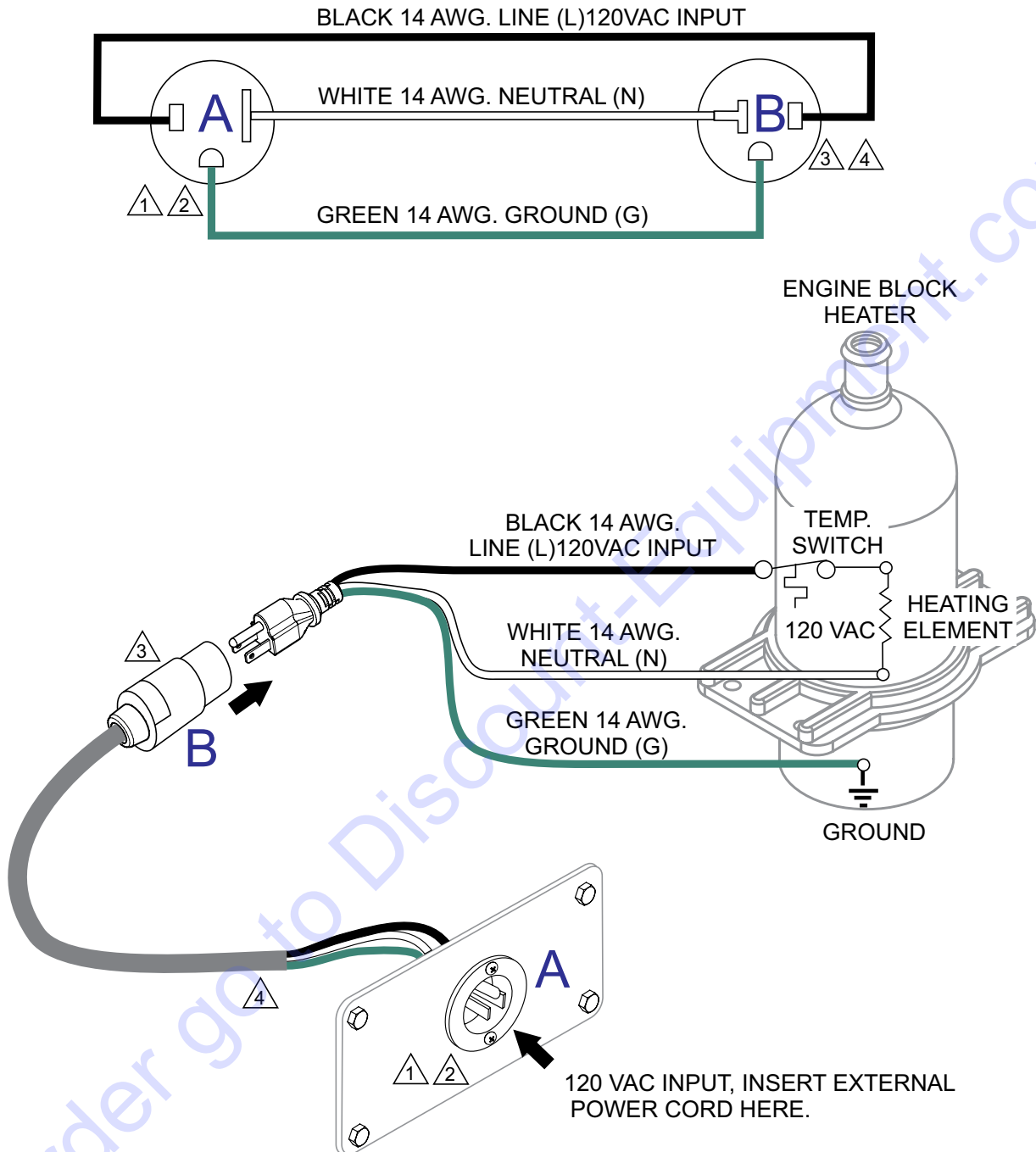

NOTES:

- ① NEMA 5-15, 15A, 120 VAC, P/N EE6176 (HBL5278C/HUBBLE RECEPTACLE).
- ② RECEPTACLE IS MOUNTED ON OUTPUT TERMINAL PANEL ASSY.
- ③ 20 AMP, 5-20R RECEPTACLE, P/N EE6131 (HBL5369C/HUBBLE RECEPTACLE).
- ④ CORD, CAROL 3/C 14 AWG., P/N EE56557.

TO PURCHASE THIS PRODUCT PLEASE CONTACT US



**Equipment Financing and
Extended Warranties Available**



**Discount-Equipment.com is your online resource for
commercial and industrial quality parts and equipment sales.**

561-964-4949

visit us on line @ www.discount-equipment.com

Select an option below to find your Equipment

Search by Manufacturer

Search by Product Type

Request a Quote

We sell worldwide for the brands: Genie, Terex, JLG, MultiQuip, Mikasa, Essick, Whiteman, Mayco, Toro Stone, Diamond Products, Generac Magnum, Airman, Haulotte, Barreto, Power Blanket, Nifty Lift, Atlas Copco, Chicago Pneumatic, Allmand, Miller Curber, Skyjack, Lull, Skytrak, Tsurumi, Husquvarna Target, Stow, Wacker, Sakai, Mi-T-M, Sullair, Basic, Dynapac, MBW, Weber, Bartell, Bennar Newman, Haulotte, Ditch Runner, Menegotti, Morrison, Contec, Buddy, Crown, Edco, Wyco, Bomag, Laymor, EZ Trench, Bil-Jax, F.S. Curtis, Gehl Pavers, Heli, Honda, ICS/PowerGrit, IHI, Partner, Imer, Clipper, MMD, Koshin, Rice, CH&E, General Equipment, Amida, Coleman, NAC, Gradall, Square Shooter, Kent, Stanley, Tamco, Toku, Hatz, Kohler, Robin, Wisconsin, Northrock, Oztec, Toker TK, Rol-Air, APT, Wylie, Ingersoll Rand / Doosan, Innovatech, Con X, Ammann, Mecalac, Makinex, Smith Surface Prep, Small Line, Wanco, Yanmar