

# 8274-4 PLANETARY GRINDER OPERATING & SERVICE MANUAL



Read Manual Before Operating or  
Servicing Machine

402902 Rev D



**TO PURCHASE THIS PRODUCT PLEASE CONTACT US**



**Equipment Financing and  
Extended Warranties Available**



**Discount-Equipment.com is your online resource for  
commercial and industrial quality parts and equipment sales.**

**561-964-4949**

**visit us on line @ [www.discount-equipment.com](http://www.discount-equipment.com)**

Select an option below to find your Equipment

**Search by Manufacturer**

**Search by Product Type**

**Request a Quote**

We sell worldwide for the brands: Genie, Terex, JLG, MultiQuip, Mikasa, Essick, Whiteman, Mayco, Toro Stone, Diamond Products, Generac Magnum, Airman, Haulotte, Barreto, Power Blanket, Nifty Lift, Atlas Copco, Chicago Pneumatic, Allmand, Miller Curber, Skyjack, Lull, Skytrak, Tsurumi, Husquvarna Target, Stow, Wacker, Sakai, Mi-T-M, Sullair, Basic, Dynapac, MBW, Weber, Bartell, Bennar Newman, Haulotte, Ditch Runner, Menegotti, Morrison, Contec, Buddy, Crown, Edco, Wyco, Bomag, Laymor, EZ Trench, Bil-Jax, F.S. Curtis, Gehl Pavers, Heli, Honda, ICS/PowerGrit, IHI, Partner, Imer, Clipper, MMD, Koshin, Rice, CH&E, General Equipment, Amida, Coleman, NAC, Gradall, Square Shooter, Kent, Stanley, Tamco, Toku, Hatz, Kohler, Robin, Wisconsin, Northrock, Oztec, Toker TK, Rol-Air, APT, Wylie, Ingersoll Rand / Doosan, Innovatech, Con X, Ammann, Mecalac, Makinex, Smith Surface Prep, Small Line, Wanco, Yanmar

# Table of Contents

---

<b>Table of Contents</b> .....	3
<b>Features and Specifications</b> .....	4
<b>Safety</b> .....	5
<b>Components and Assembly</b> .....	9
Loading and Unloading .....	9
Handle Assembly .....	9
Vacuum Port .....	9
Rubber Dust Guard .....	9
Weights .....	10
Pre-Production Safety Checks .....	10
<b>Operation</b> .....	11
Start-Up Procedure .....	11
Shut-Down Procedure .....	11
Accessory Set-Up .....	11
Accessory Attachment .....	12
<b>Troubleshooting Guide</b> .....	13
<b>Maintenance</b> .....	14
General Maintenance .....	14
Belt Procedures .....	15
Idle Bearing Replacement .....	17
Pulley Replacement .....	17
Satellite Shaft Replacement .....	17
Satellite Bearing Replacement .....	18
Removing Top Gear Plate .....	19
<b>Complete Parts List</b> .....	20
<b>Parts List and Diagrams</b> .....	21

# Features and Specifications



## FEATURES

**Adjustable Handle** - Adjusts in three separate locations for operator comfort.

**Dust Collector Port** - Located in the back of the machine to ensure hose will not disrupt production.

**Flip Style Weights** - Allows operator to easily add down pressure when required.

**90° Rotating Grinder Deck** - Grants easy access to the quick-change magnetic tooling.

**Control Box** - Self-diagnoses and minimizes blown circuit breakers with a variable speed feature.

**Adjustable Rubber Dust Guard** - Provides a dustless operation.

**15A/20A Switch** - This machine normally runs on 20A; however, the switch on the side of the control box allows the operator to run the machine on 15A when there is a limited power supply.

## Product Specifications

Width	Height (Min.-Max.)	Length (Min.-Max.)	Weight	Disc Size	Power / Frequency	HP	Motor
20" (51 cm)	27.5-52" (70-132 cm)	38.5-75" (98-190.5 cm)	388 lbs (176 kg)	18.5" (47 cm)	120 V / 60 Hz, single phase input	3	3-Phase operation

## GENERAL RULES FOR SAFE OPERATION

Before use, anyone operating or performing maintenance on this equipment must read and understand this manual, as well as any labels packaged with or attached to the machine and its components. Read the manual carefully to learn equipment applications and limitations, as well as potential hazards associated with this type of equipment. Keep manual near machine at all times. If your manual is lost or damaged, contact Discount-equipment for a replacement.

### Personal

#### **Dress properly and use safety gear.**

Do not wear loose clothing; it may be caught in moving parts. Anyone in the work area must wear safety goggles or glasses and hearing protection. Wear a dust mask for dusty operations. Hard hats, face shields, safety shoes, etc. should be worn when specified or necessary.

#### **Maintain control; stay alert.**

Keep proper footing and balance, and maintain a firm grip. Observe surroundings at all times. Do not use when tired, distracted, or under the influence of drugs, alcohol, or any medication that may cause decreased control.

#### **Keep hands away from all moving parts and tooling.**

Wear gloves when changing tooling. Remove tooling when machine is not in use and/or lower cutting head to the floor.

#### **Do not force equipment.**

Equipment will perform best at the rate for which it was designed. Excessive force only causes operator fatigue, increased wear, and reduced control.

### Environment

#### **Avoid use in dangerous environments.**

Do not use in rain, damp or wet locations, or in the presence of explosive atmospheres (gaseous fumes, dust, or flammable materials). Remove materials or debris that may be ignited by sparks. Keep work area tidy and well-lit - a cluttered or dark work area may lead to accidents. Extreme heat or cold may affect performance.

#### **Protect others in the work area and be aware of surroundings.**

Provide barriers or shields as needed to protect others from debris and machine operation. Children and other bystanders should be kept at a safe distance from the work area to avoid distracting the operator and/or coming into contact with the machine. Operator should be aware of who is around them and their proximity. Support personnel should never stand next to, in front of, or behind the machine while the machine is running. Operator should look behind them before backing up.

#### **Guard against electric shock.**

Ensure that machine is connected to a properly grounded outlet. Prevent bodily contact with grounded surfaces, e.g. pipes, radiators, ranges, and refrigerators. When scoring or making cuts, always check the work area for hidden wires or pipes.

### Maintenance & Repairs

#### **Begin maintenance work only when the machine is shut down, unplugged, and cooled down.**

#### **Use proper cleaning agents.**

Ensure that all cleaning rags are fiber-free; do not use any aggressive cleaning products.

#### **Schedule regular maintenance check-ups.**

Ensure machine is properly cleaned and serviced. Remove all traces of oil, combustible fuel, or cleaning fluids from the machine and its connections and fittings. Retighten all loose fittings found during maintenance and repair work. Loose or damaged parts should be replaced immediately; use only NFE parts.

#### **Do not weld or flame-cut on the machine during repairs, or make changes to machine without authorization from NFE.**

### Equipment

#### **Use proper parts and accessories.**

Only use NFE-approved or recommended parts and accessories. Using any that are not recommended may be hazardous.

#### **Ensure accessories are properly installed and maintained.**

Do not permanently remove a guard or other safety device when installing an accessory or attachment.

#### **Inspect for damaged parts.**

Check for misalignment, binding of moving parts, loose fasteners, improper mounting, broken parts, and any other conditions that may affect operation. If abnormal noise or vibration occurs, turn the machine off immediately. Do not use damaged equipment until repaired. Do not use if power switch does not turn machine on and off. For all repairs, insist on only identical NFE replacement parts.

#### **Maintain equipment and labels.**

Keep handles dry, clean, and free from oil and grease. Keep cutting edges sharp and clean. Follow instructions for lubricating and changing accessories. Motor and switches should be completely enclosed at all times with no exposed wiring. Inspect cord regularly. Labels carry important information; if unreadable or missing, contact Discount-equipment for a free replacement.

#### **Avoid accidental starting; store idle equipment.**

When not in use, ensure that the machine is unplugged; do not turn on before plugging in. Store in a dry, secured place. Remove tooling when storing, and keep away from children.

# Safety

## GRINDER SAFETY GUIDELINES

Before use, anyone operating this equipment must read and understand these safety instructions.

### Grinding

#### Beware of hidden obtrusions.

Watch out for hidden dangers and protrusions in flooring. Do not use on largely uneven surfaces.

#### Avoid contact with hot tooling and shroud.

Do not touch the tooling or shroud without proper hand protection. Both become hot during operation and remain hot after stopping the machine.

#### Use correct tooling and accessories.

Provide barriers or shields as needed to protect others from debris.

#### Use for correct applications.

Do not force equipment to do heavier duty work than it was made for.

#### Do not block the machine's air flow.

Blocking ventilation slots or air flow will result in damage to the machine. Leave space for air to flow freely during operation.

#### Use dead man cable during operation.

Loss of control of the grinder could cause damage, injury, or death.

### Dust Collection

#### Use with appropriate dust collecting system.

Do not operate machine designed for use with a dust collector without the dust collector. Ensure dust collector is on and operating properly while grinding.

#### Use with appropriate dust collection hose.

Do not operate the machine without the hose securely attached to the inlet of the dust collector and the outlet of the grinder. In order to maintain system efficiency, do not use a damaged hose.

#### Dispose of collected waste.

Do not leave the dust collector bag full of waste. Handle and dispose of bag and waste in accordance with all applicable local, state, and federal regulations. Dispose of waste prior to transport.

### Battery (Propane Machines Only)

#### Remove personal metal items when working with battery.

A battery can produce a short circuit current sufficient enough to weld metal objects, causing severe burns. Be careful to not drop metal tools on the battery, as a spark or short circuit could cause an explosion.

#### Never smoke or allow a spark or flame near the battery.



**WARNING:** BE CAUTIOUS WHEN WORKING WITH BATTERY. IF ELECTROLYTIC ACID GETS IN THE EYES, IMMEDIATELY FLUSH OUT WITH COLD, FRESH WATER FOR AT LEAST 10 MINUTES AND GET MEDICAL HELP.

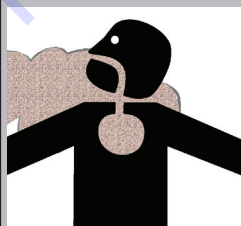

**WARNING:** GRINDING/CUTTING/DRILLING OF MASONRY, CONCRETE, METAL AND OTHER MATERIALS CAN GENERATE DUST, MISTS AND FUMES CONTAINING CHEMICALS KNOWN TO CAUSE SERIOUS FATAL INJURY OR ILLNESS, SUCH AS RESPIRATORY DISEASE, CANCER, BIRTH DEFECTS OR OTHER REPRODUCTIVE HARM. IF YOU ARE UNFAMILIAR WITH THE RISKS ASSOCIATED WITH THE PARTICULAR MATERIAL BEING CUT, REVIEW THE MATERIAL SAFETY DATA SHEET AND/OR CONSULT YOU EMPLOYER, THE MATERIAL MANUFACTURER/SUPPLIER, GOVERNMENTAL AGENCIES SUCH AS OSHA AND NIOSH AND OTHER AUTHORITIES ON HAZARDOUS MATERIALS. CALIFORNIA AND SOME OTHER AUTHORITIES, FOR INSTANCE, HAVE PUBLISHED LISTS OF SUBSTANCES KNOWN TO CAUSE CANCER, REPRODUCTIVE TOXICITY, OR OTHER HARMFUL EFFECTS. CONTROL DUST, MIST AND FUMES AT THE SOURCE WHERE POSSIBLE. IN THIS REGARD USE GOOD WORK PRACTICES AND FOLLOW THE RECOMMENDATIONS OF THE MANUFACTURER/SUPPLIER, OSHA/NIOSH, AND OCCUPATIONAL AND TRADE ASSOCIATIONS. WHEN THE HAZARDS FROM INHALATION OF DUST, MISTS AND FUMES CANNOT BE ELIMINATED, THE OPERATOR AND ANY BYSTANDERS SHOULD ALWAYS WEAR A RESPIRATOR APPROVED BY OSHA/MSHA FOR THE MATERIAL BEING CUT.



## ELECTRICAL PRACTICES



**WARNING:** ELECTRICAL CORDS CAN BE HAZARDOUS. MISUSE CAN RESULT IN FIRE OR DEATH BY ELECTRICAL SHOCK. READ CAREFULLY AND FOLLOW ALL DIRECTIONS.



**CAUTION:** ALWAYS FOLLOW APPLICABLE ELECTRICAL CODES, STANDARDS AND/OR REGULATIONS. CONSULT YOUR LOCAL ELECTRICAL AUTHORITY OR A LICENSED ELECTRICIAN BEFORE ATTEMPTING TO MODIFY AN ELECTRICAL INSTALLATION. ENSURE THAT CIRCUIT AND GROUND FAULT PROTECTION DEVICES AND ALL OTHER ELECTRICAL SAFETY EQUIPMENT ARE FUNCTIONING PROPERLY.

### Extension Cord Requirements

- Ensure the cord type is suitable for the application and location. If you are unsure about your cord type, consult a qualified electrical professional or electrician.
- Ground your equipment. The equipment must be plugged into an appropriate outlet, one which is properly installed and grounded in accordance with all codes and ordinances. Do NOT modify the plug provided with the equipment. Never remove the grounding prong from the plug.
- Do not remove, bend or modify any metal prongs or pins of the plug. Modifications to power cords and/or plugs may result injury and/or equipment damage.
- FULLY INSERT plug into outlet.
- Do not use excessive force to make connections.
- Never unplug by pulling the cord from the outlet. Pull plug rather than cord to reduce the risk of damage.
- Regularly examine your extension cord and ensure it is in good electrical condition. Never use a damaged cord—either replace it or have it repaired by a qualified person.
- Protect your extension cords from sharp objects, excessive heat and damp or wet areas. Keep the cord away from oil, cutting edges and moving parts.
- Do not drive, drag or place objects over cord.
- Avoid overheating. Uncoil cord and do not cover it with any material.
- Avoid accidental starting. Be sure equipment is turned off before plugging in. Do not use equipment if the power switch does not turn the equipment on and off.
- Make sure equipment is not running before disconnecting cord.
- Unplug equipment. When not in use and before changing accessories or performing maintenance, unplug the machine.

### Extension Cord Selection

All cords should be sized appropriately to reduce the risk of damage, fire or reduced performance. Reference the table in this section for cord sizes.

# Safety

## ELECTRICAL PRACTICES—CONTINUED

### How to Use This Table

1. Determine your supply voltage.
2. Determine the total length of your cord including all extension cords.
3. Determine the maximum amp draw for your machine.
4. Trace your voltage across the top of the table to the first length that is greater than or equal to your cord length.
5. Follow the column down to the first row that contains a maximum amp draw greater than or equal to yours.
6. This cell contains the minimum wire size for your application.

### Example

**Application:** Max Amps = 11A, Length = 40ft, Voltage = 120V

**Solution:** 40ft is between the 25ft and 50ft columns, so the larger of the two columns is chosen. Likewise, 11A is between the 10A and 12A rows, so the larger of the two rows is chosen. 14 AWG (2.5mm<sup>2</sup>) is the minimum wire size for this example.

		Single Phase Equipment			
Max Length	120V Supply	25ft (7.5m)	50ft (15m)	75ft (22.5m)	100ft (30m)
	230V Supply	50ft (15m)	100ft (30m)	150ft (45m)	200ft (60m)
Max Amps		Minimum Wire Size			
8		16 AWG (1.5mm <sup>2</sup> )	16 AWG (1.5mm <sup>2</sup> )	16 AWG (1.5mm <sup>2</sup> )	16 AWG (1.5mm <sup>2</sup> )
10		16 AWG (1.5mm <sup>2</sup> )	16 AWG (1.5mm <sup>2</sup> )	16 AWG (1.5mm <sup>2</sup> )	16 AWG (1.5mm <sup>2</sup> )
12		14 AWG (2.5mm <sup>2</sup> )	14 AWG (2.5mm <sup>2</sup> )	14 AWG (2.5mm <sup>2</sup> )	14 AWG (2.5mm <sup>2</sup> )
14		14 AWG (2.5mm <sup>2</sup> )	14 AWG (2.5mm <sup>2</sup> )	14 AWG (2.5mm <sup>2</sup> )	14 AWG (2.5mm <sup>2</sup> )

### Extension Cord Sizes

Single Phase Equipment							
Max Length	120V Supply	25ft (7.5m)	50ft (15m)	75ft (25m)	100ft (30m)	150ft (45m)	200ft (60m)
	230V Supply	50ft (15m)	100ft (30m)	150ft (45m)	200ft (60m)	300ft (90m)	400ft (120m)
Max Amps		Minimum Wire Size					
8		16 AWG (1.5mm <sup>2</sup> )	16 AWG (1.5mm <sup>2</sup> )	16 AWG (1.5mm <sup>2</sup> )	16 AWG (1.5mm <sup>2</sup> )	14 AWG (2.5mm <sup>2</sup> )	14 AWG (2.5mm <sup>2</sup> )
10		16 AWG (1.5mm <sup>2</sup> )	16 AWG (1.5mm <sup>2</sup> )	16 AWG (1.5mm <sup>2</sup> )	16 AWG (1.5mm <sup>2</sup> )	14 AWG (2.5mm <sup>2</sup> )	12 AWG (4mm <sup>2</sup> )
12		14 AWG (2.5mm <sup>2</sup> )	14 AWG (2.5mm <sup>2</sup> )	14 AWG (2.5mm <sup>2</sup> )	14 AWG (2.5mm <sup>2</sup> )	12 AWG (4mm <sup>2</sup> )	12 AWG (4mm <sup>2</sup> )
14		14 AWG (2.5mm <sup>2</sup> )	14 AWG (2.5mm <sup>2</sup> )	14 AWG (2.5mm <sup>2</sup> )	14 AWG (2.5mm <sup>2</sup> )	12 AWG (4mm <sup>2</sup> )	10 AWG (6mm <sup>2</sup> )
16		14 AWG (2.5mm <sup>2</sup> )	14 AWG (2.5mm <sup>2</sup> )	14 AWG (2.5mm <sup>2</sup> )	14 AWG (2.5mm <sup>2</sup> )	12 AWG (4mm <sup>2</sup> )	10 AWG (6mm <sup>2</sup> )
18		14 AWG (2.5mm <sup>2</sup> )	14 AWG (2.5mm <sup>2</sup> )	14 AWG (2.5mm <sup>2</sup> )	12 AWG (4mm <sup>2</sup> )	12 AWG (4mm <sup>2</sup> )	10 AWG (6mm <sup>2</sup> )
20		12 AWG (4mm <sup>2</sup> )	12 AWG (4mm <sup>2</sup> )	12 AWG (4mm <sup>2</sup> )	12 AWG (4mm <sup>2</sup> )	10 AWG (6mm <sup>2</sup> )	10 AWG (6mm <sup>2</sup> )
25		12 AWG (4mm <sup>2</sup> )	12 AWG (4mm <sup>2</sup> )	12 AWG (4mm <sup>2</sup> )	12 AWG (4mm <sup>2</sup> )	10 AWG (6mm <sup>2</sup> )	8 AWG (10mm <sup>2</sup> )
30		10 AWG (6mm <sup>2</sup> )	10 AWG (6mm <sup>2</sup> )	10 AWG (6mm <sup>2</sup> )	10 AWG (6mm <sup>2</sup> )	8 AWG (10mm <sup>2</sup> )	8 AWG (10mm <sup>2</sup> )

**Note:** The table is based on a <10% voltage loss, data from the U.S. National Electrical Code Tables 400.5(A) & 400.5(B) and typical resistances for copper wire.



# Components and Assembly

## LOADING AND UNLOADING

- Always disconnect from power source before transporting.
- Ensure blanks are installed in magnetic tooling pockets during transport.
- Loosen handle securing bolt to slide handle down for loading/unloading. Re-tighten the bolts when handle is at the desired height.



**CAUTION:** HANDLE MUST BE SECURED WITH BOTH BOLTS; BE AWARE OF ROTATING WEIGHTS. FAILURE TO DO SO COULD CAUSE SERIOUS INJURY.



FIG. 1

## HANDLE ASSEMBLY

Handle adjusts in both height and angle. To make adjustments, complete the following:

1. Loosen the handle bolt and adjust the handle to the desired length (Figure 1); re-tighten bolt.
2. Adjust handle grip to desired angle and firmly secure (Figure 1.1).
3. Adjust handle to desired angle and secure with clip and support pin (Figure 1.2).



FIG. 1.1

## VACUUM PORT

The machine has a dust collection port located at the rear (Figure 2A). Use a dust collection hose that snugly fits either on the outside or the inside of the port. The dual short hose connection runs from the grinder deck to the 'Y' splitter (Figure 2B).



**WARNING:** MAKE SURE TO USE THE PROPER INDUSTRIAL HEPA DUST COLLECTOR BASED ON THE TYPE OF SURFACE APPLICATION. FAILURE TO DO SO COULD RESULT IN EMISSIONS OF HAZARDOUS PARTICULATES. ENSURE THE SYSTEM BEING USED COMPLIES WITH OR EXCEEDS OSHA RECOMMENDED STANDARDS. THE RUBBER DUST GUARD MUST BE SECURE AND COVER ALL THE WAY TO THE FLOOR SURFACE.



FIG. 1.2

## RUBBER DUST GUARD



**WARNING:** NEVER OPERATE THE MACHINE WITHOUT THE RUBBER DUST GUARD PROPERLY IN PLACE. ENSURE DUST GUARD FORMS A SEAL FROM THE GRINDER DECK TO THE FLOOR. FAILURE TO DO SO COULD CAUSE SERIOUS HARM TO THE OPERATOR AND/OR THOSE IN PROXIMITY OF THE GRINDER. NEVER MOUNT OR RE-ADJUST THE RUBBER DUST GUARD WITH THE MACHINE PLUGGED IN. DISCONNECT MACHINE FROM POWER SOURCE BEFORE MAKING ADJUSTMENTS.

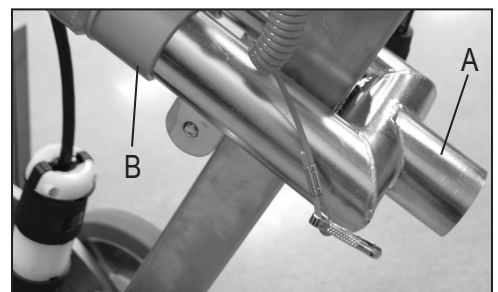

FIG. 2

## Attaching

1. Ensure machine is in upright position.
2. Attach dust guard (Figure 3), keeping as close to the floor as possible.  
**Note:** If dust is exposed when operating machine, stop machine and readjust dust guard.

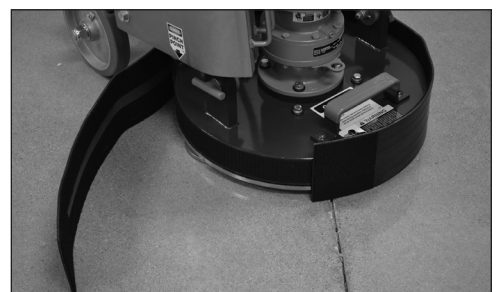

FIG. 3

# Components and Assembly



FIG. 4



FIG. 4.1

## Positioning

1. Unplug machine from power source.
2. With machine sitting in the operating position, remove rubber dust guard held on by Velcro.
3. Starting at one end of the shroud, place guard to rest on floor surface.
4. Firmly press rubber guard into securing Velcro on shroud.
5. Wrap rubber guard all the way around the shroud, making sure the guard rests on the floor surface and is secure (Figure 3).
6. Inspect for air gaps between dust guard and floor.

**Note:** If guard-securing Velcro becomes loaded up with debris, wash out with mild soap or blow out with an air hose. If Velcro on the machine is damaged or worn out, replace before using the machine. If the rubber guard is cut, damaged or worn out, replace before using the machine.

## WEIGHTS

Weights rotate front to back.

- To apply added weight, one or both weights can be rotated forward (Figure 4).
- To take load off machine, pull weights to the back (Figure 4.1).
- If circuit breakers trips at the power source, pull weight(s) to the back to reduce head pressure.

## PRE-PRODUCTION SAFETY CHECKS

Prior to starting the grinder, complete the following safety checks:

- Ensure all morflex coupler assemblies and magnetic tooling plates are securely fastened.
- Clean any dust or debris from the magnetic tooling holders prior to installing tooling or Velcro adapter plates.
- Ensure the dust guard is properly in place by forming a seal from the grinder deck to the surface of the floor being prepared.
- Attach the tether cord to both the machine and the operator.

## START-UP PROCEDURE

1. Plug the controller into a properly sized extension cord (see Safety).
2. Plug the extension cord into an adequate power supply.
3. Attach the control box safety tether to the operator's wrist.
4. Move the FWD/REV toggle switch to the desired "forward" or "reverse" position. (Figure 5A)
5. The operator should apply a light amount of pressure to the grinder handle to relieve the initial torque created when starting the machine.
6. Move the power toggle switch to the "ON" position (Figure 5B).

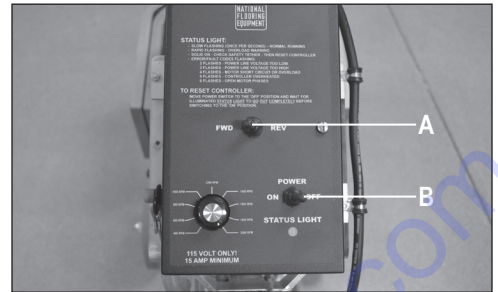

FIG. 5

## SHUT-DOWN PROCEDURE

To turn the grinder off move the toggle switch to the "OFF" position.

## ACCESSORY SET-UP

When grinding, down pressure relates to two aspects: (1) the amount of weight on the machine, and (2) the surface area the weight is being distributed across.

- If tooling with a smaller segment is used, the amount of down pressure applied at the point of contact is increased.
- Larger segments of tooling will decrease the amount of down pressure.

Down pressure will directly affect production rates and of profile achieved. If more down pressure is desired, insert the tooling segments into two of the four magnetic pockets. Be sure to insert the tooling into the magnetic pockets directly across from one another.

The machine is designed to run in forward or reverse for most applications:

- With the grinder switch in "forward," the tooling should turn counterclockwise and the drum should turn opposite (Figure 6).
- With the grinder switch in "reverse," the tooling should turn clockwise and the drum should turn opposite (Figure 7).

**Note:** PCDs and carbides can only be used in forward motion.

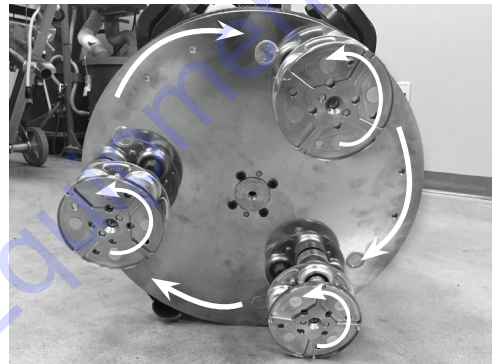

FIG. 6

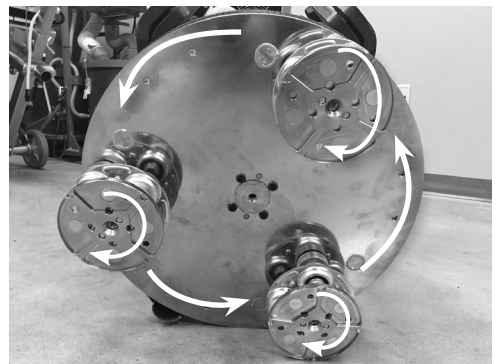

FIG. 7

# Operation



FIG. 8

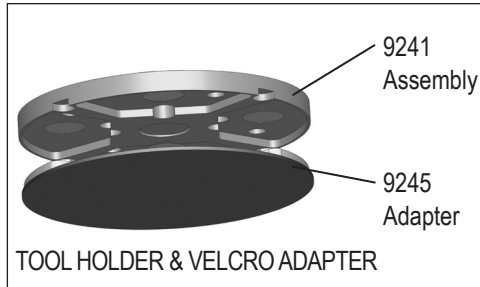

FIG. 9

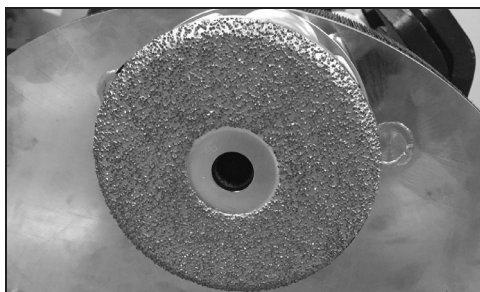

FIG. 10

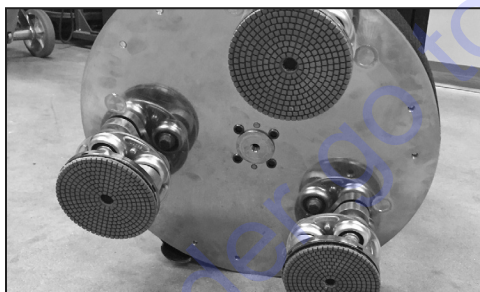

FIG. 11

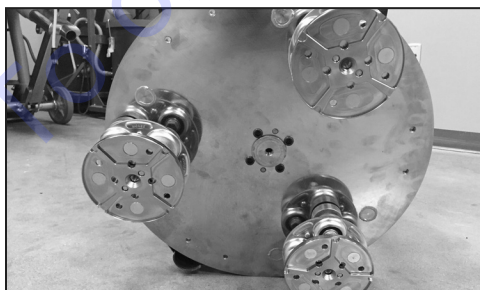

FIG. 12

## ACCESSORY ATTACHMENT

1. Tilt motor back to expose the underside of the machine.
2. Clean foreign material from magnet prior to tooling installation.
3. Place the individual tooling segments into two or four of the magnetic pockets. Be careful around pinch points, as the tooling segments will snap into place as the magnetic connection is made (Figure 8).
4. For safety, depending on the condition of the surface being prepared, the individual tooling segments should be attached to the magnetic tooling holders using a single mounting screw for each segment.

**Note:** Use blanks in unused magnetic tooling pockets.

### Attaching The Velcro Plate Adapter

The Velcro plate adapter attaches magnetically to the Magnetic tooling plate and snaps into place (Figure 9).

### Mounting Brazed Diamond and Polishing Pads

The brazed diamond and polishing pads are attached to the Velcro adapter plates (Figures 10; 11).

### Mounting PCD's

PCD's are mounted to the holder (Figure 12) with tooling screws. The holder and PCD's are not magnetic, but are attached to the magnetic plates.

**Note:** When setting the machine down into the operating position, hold the machine firmly and set it down gently.



**CAUTION:** DAMAGE TO ACCESSORIES AND MACHINE COULD OCCUR IF DROPPED.



**WARNING:** WHEN ACCESSORIES ARE EXPOSED, NEVER OPERATE MACHINE. SERIOUS INJURY AND POSSIBLE PLATE DISENGAGEMENT COULD OCCUR.



# Troubleshooting Guide

Fault Code Status Light	Fault Description	Problem	Solution
SOLID ON	Check safety tether	Safety tether is disconnected from controller or faulty connection internally with tether switch.	Attach safety tether to control box. If necessary, check connections inside controller. Ensure control box is disconnected from power source prior to opening control box.
2 FLASHES	Power line voltage too low	Not enough power coming into controller to start or run grinder.	Be sure to use the appropriate extension cord (see Safety) and/or generator (10 kW, 115V if applicable).
3 FLASHES	Power line voltage too high	Excessive power coming into controller.	Ensure grinder is plugged into an outlet and/or generator (if applicable) with the appropriate voltage.
4 FLASHES	Motor short circuit or overload	Motor may be overheating due to using too long of an extension cord or because the outlet/generator is the wrong voltage.	Allow motor to cool before resetting fault code. Reduce amp draw by removing weights from grinder deck and/or reducing motor's RPM. Ensure use of proper extension cord, outlet, and/or generator.
5 FLASHES	Controller overheating	Internal components of controller are too hot.	Ensure external fan is plugged into controller and is working properly. Reduce amp draw by removing weights from grinder deck and/or reducing motor's RPM.
6 FLASHES	Open motor phases	No power from controller motor.	Ensure motor is properly connected to control box.
NO FLASHING LIGHTS or ANY LIGHTS AT ALL	No illuminated status lights or fault codes	Reset power supply circuit breaker if necessary; if the power source is working, it is likely the fuse inside the control box is blown.	Prior to opening control box, ensure it is disconnected from power source. Wait 30 seconds for power to discharge from capacitors after disconnecting. Replace fuse.

# Maintenance

---

## GENERAL MAINTENANCE

A well-maintained machine is a productive machine. If not properly maintained, it could be unsafe or break down. Schedule regular maintenance check-ups to ensure efficient performance and a long life. The following maintenance should be performed by a service center:

- Mechanical inspection and cleaning (pulleys, belts, bearings, nuts, bolts, housing, labels, etc.).
- Replacing worn or damaged parts (switches, guards, belts, etc.).
- Electrical inspection (switch, cord, plugs, etc.).
- Testing to assure proper mechanical and electrical operation.
- Replacing labeling.



**WARNING:** BEFORE PERFORMING ANY MAINTENANCE WORK, DISCONNECT THE TOOL FROM THE POWER SOURCE.



**WARNING:** NEVER DISASSEMBLE THE MACHINE OR TRY TO DO ANY REWIRING ON THE MACHINE'S ELECTRICAL SYSTEM. CONTACT NATIONAL FLOORING EQUIPMENT FOR ALL ELECTRICAL REPAIRS.



**WARNING:** TO REDUCE THE RISK OF INJURY, ELECTRIC SHOCK AND DAMAGE TO THE MACHINE, NEVER IMMERSE YOUR MACHINE IN LIQUID OR ALLOW A LIQUID TO FLOW INSIDE THE MACHINE.

Keep machine in good repair by adopting a regular maintenance program. Before use, examine the general condition. If abnormal noise or vibration occurs, turn the grinder off immediately and have the problem corrected before further use.

## Cleaning

- Clean dust and debris from wheels and housing.
- Keep the grinder handle clean, dry, and free of oil or grease.
- Use only mild soap and a damp cloth to clean machine, as some cleaning agents and solvents are harmful to plastics and other insulated parts. Some of these include: gasoline, turpentine, lacquer thinner, paint thinner, chlorinated cleaning solvents, ammonia and household detergents containing ammonia. Never use flammable or combustible solvents around machinery.
- Do not pressure-wash grinder. Getting motor or control box wet could cause electric shock or damage the grinders electrical components.



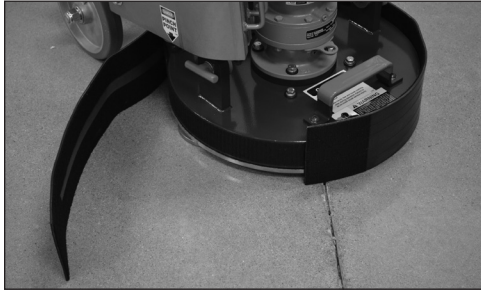

FIG. 1



FIG. 1.1

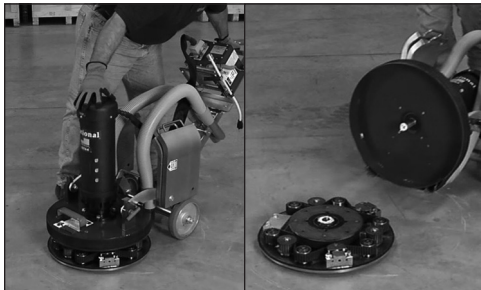

FIG. 1.2

FIG. 1.3

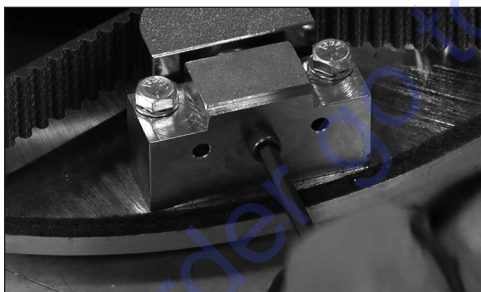

FIG. 2

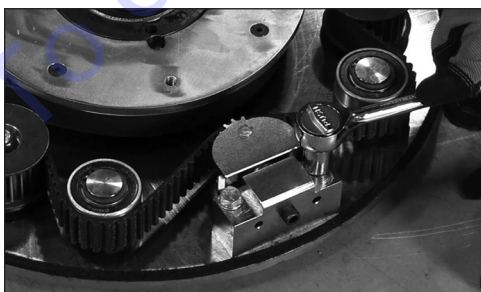

FIG. 3

## BELT PROCEDURES



**CAUTION:** BEFORE ANY MAINTENANCE, MAKE SURE MACHINE IS DISCONNECTED FROM POWER SOURCE

**Note:** Blue Loctite should be used on tensioner bolts. Torque on 3/8" bolts should not exceed 25 lbs.

### To Access Belt

1. Remove dust guard (Figure 1).
2. Remove the four bolts on top of the shroud cover (Figure 1.1).
3. Push down on the handle. The shroud should lift up and away from the grinding deck. If not, with the four bolts on top of the shroud cover removed, tip the grinder deck back to the tool changing position. Insert a 1/2"-13x4" threaded bolt into the center of the underside of the deck plate. Turn bolt in clockwise until deck is free of grinder shroud. Remove bolt and the shroud should now lift up and away from the grinding deck (Figure 1.2).
4. Move machine back and off the plate (Figure 1.3).

### Removing Belt

1. Remove any dust or debris from inside the deck.
2. Using an Allen wrench, install the 5/16-18x1 1/4" socket head cap screws into each tensioner and compress the block spring by turning the screw clockwise. The belt should be loose enough to slide off.
3. Leave approximately 1/8" gap when compressing the block spring to allow clearance for removing the tensioner mounting bolts (Figure 2).
4. Remove one mounting bolt completely; loosen the other (Figure 3).

# Maintenance

## Replacing Belt

1. Deck should now be in the orientation shown (Figure 4) before installing new belt, clean any debris from the deck before moving on.
2. Install belt around the center gear; pull the excess through the gap by the counter weight (Figure 4.1).
3. Keep the smooth side of the belt against the idlers and flip the belt over the deck. The teeth on the belt will face outward.
4. A properly installed belt should appear as shown (Figure 4.2).
5. Turn one tensioner into place and install the bolt (Figure 4.3).
6. Push the second tensioner into the belt until the mounting hole lines up with the block; install the second bolt.
7. Once both tension blocks are installed, remove the collapsing bolts.
8. Use pliers to rotate the shaft on the bottom of the machine so the key is in the 12 o'clock position (Figure 4.4).
9. Turn the deck so the keyway in the hub is also in the 12 o'clock position (Figure 4.5). **Note:** Use anti-seize on the shaft and in the center of the deck to protect against corrosion.
10. Hold the motor straight while lining up the shaft with the hub in the deck.
11. Press evenly on the top of the motor or deck until the shroud is seated on the deck.
12. Re-install the four bolts around the base of the reducer. The shroud may need to be rotated to line up with the holes. Do not crosstread bolts when installing.
13. Test machine thoroughly to ensure correct operation.



FIG. 4

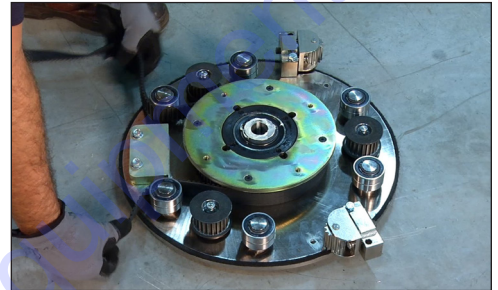

FIG. 4.1



FIG. 4.2

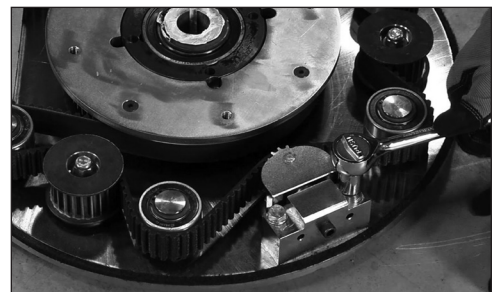

FIG. 4.3

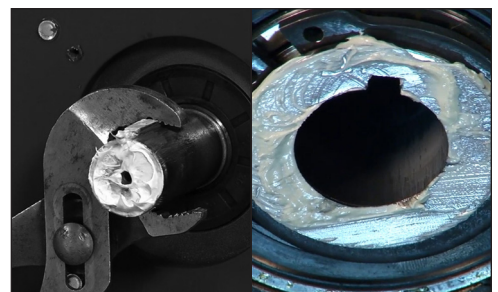

FIG. 4.4

FIG. 4.5



FIG. 5

## IDLE BEARING REPLACEMENT

1. Remove belt.
2. Remove snap ring (Figure 5).
3. Remove idler bearings (Figure 5.1) .
4. Replace bearing.
5. Replace snap ring; ensure ring is seated in the groove (Figure 5).
6. Re-install belt.



FIG. 5.1

## PULLEY REPLACEMENT

1. Remove belt.
2. Remove nut from top of pulley.
3. Slide pulley up and off. Key will fall out (Figure 6).
4. Place and line up key in new pulley.
5. Install pulley.
6. Re-insert nut.
7. Re-install belt.

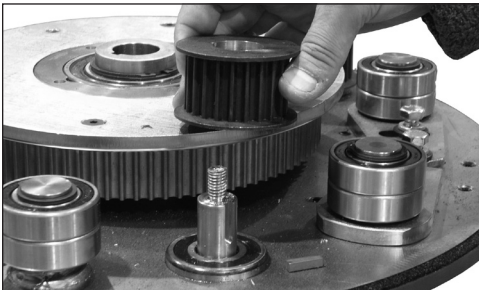

FIG. 6

## SATELLITE SHAFT REPLACEMENT

1. Remove belt.
2. Remove nut from top of pulley.
3. Slide pulley up and off. Key will fall out (Figure 6).
4. Push down on shaft (Figure 6.1).
5. Lift up on plate and pull out shaft (Figure 6.2).
6. Replace shaft (Figure 6.3).
7. Place and line up key in new pulley.
8. Install pulley.
9. Replace nut.
10. Re-install belt.

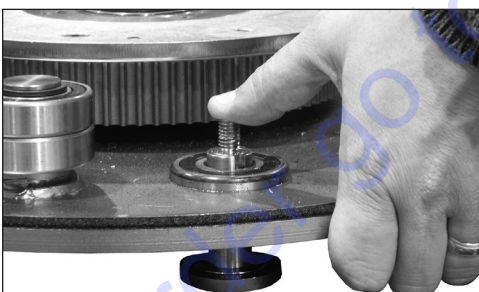

FIG. 6.1



FIG. 6.2



# Maintenance

## SATELLITE BEARING REPLACEMENT

1. Remove belt.
2. Remove nut from top of pulley.
3. Slide pulley up and off. Key will fall out (Figure 6).
4. Remove satellite shaft (Figure 6.3).
5. Block up plate (Figure 7).
6. Knock out bearing (Figure 7.1) .
7. Turn plate over on blocks (Figure 7.2).
8. With the retainer ring turned upwards, replace the bearing (Figure 7.2), keeping the bearing as straight as possible (Figure 7.3). **Note:** Bearing can be difficult to insert.
9. Replace shaft.
10. Place and line up key in new pulley.
11. Install pulley.
12. Replace nut.
13. Re-install belt.

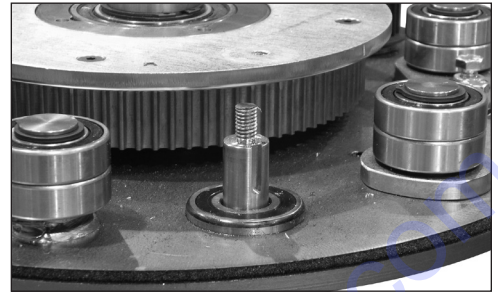

FIG. 6.3

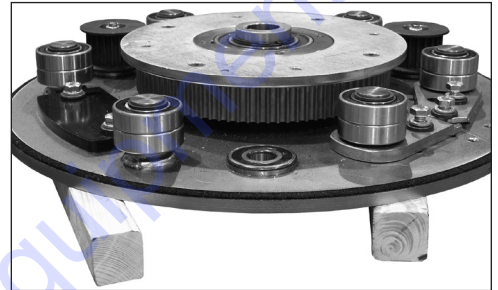

FIG. 7

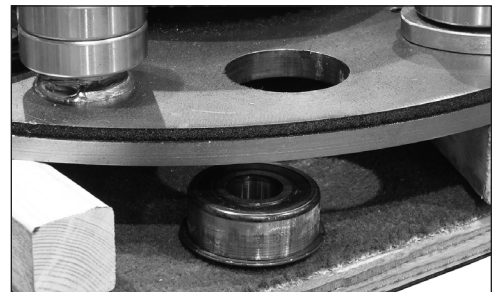

FIG. 7.1

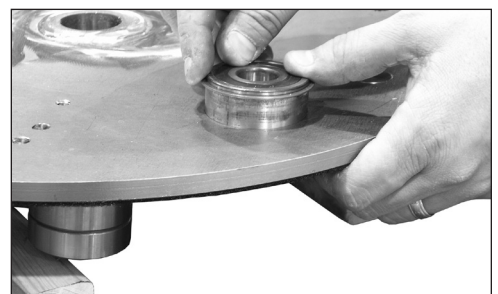

FIG. 7.2



FIG. 7.3



FIG. 8



FIG. 8.1

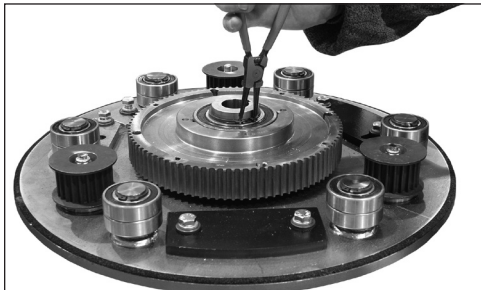

FIG. 8.2

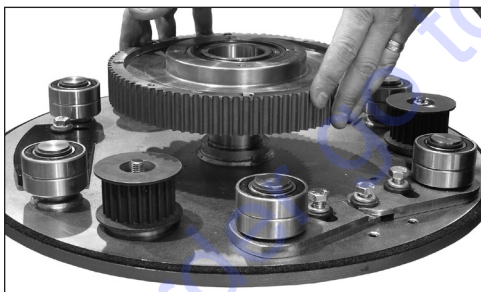

FIG. 8.3

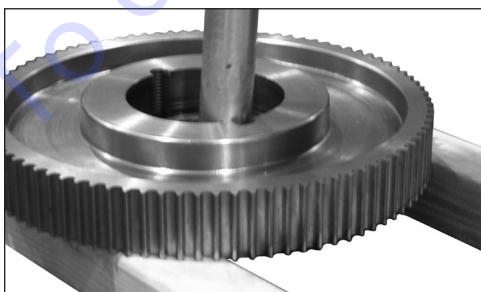

FIG. 8.4

## REMOVING TOP GEAR PLATE

1. Remove belt.
2. With an Allen wrench, remove the four gear plate cover screws (Figure 8).
3. Remove gear plate (Figure 8.1).
4. Remove both snap rings (Figure 8.2).
5. Remove gear (Figure 8.3).
6. Block up gear (Figure 8.4).
7. Knock out bearings.
8. Re-install bearings one at a time. **Note:** When hitting around outside perimeter of the bearing, keep bearing as straight as possible.
9. Place gear back onto plate, keeping fingers clear (Figure 8.3).
10. Wiggle bearing until it drops into place. Do not force; be aware of the pinch points.
11. Re-insert snap rings; ensure they are seated in the groove.
12. Re-insert gear plate.
13. Re-insert the four screws.
14. Re-install belt.

# Complete Parts List

PART#	DESCRIPTION	QTY	PART#	DESCRIPTION	QTY		
1	80024	BLOCK, PLANETARY HANDLE	1	29	401640	REDUCER, GRINDER, GROVE	1
2	80026	TUBE, OVAL, PLANETARY HANDLE	1	30	73201	SCREW, HEX HEAD CAP, 3/8-16X1	4
3	80035	TUBE, INNER WELDMENT	1	31	L106	PINCH POINT LABEL	2
4	80036	TUBE, OUTER WELDMENT	1	32	73604	NUT, NYLON LOCK 3/4-10	2
5	80037	FRAME, PLANETARY HANDLE	1	33	80047	PIN, 3/8"X3-5/8, QUICK RELEASE	1
6	80039	SPLITTER, VAC	1	34	73410	BOLT, HEX HEAD CAP, 1/2-13X3-1/2	2
7	8274-46	BRACKET, CONTROLLER 8274	1	35	73417	BOLT, HEX HEAD CAP 1/2-13X4	1
8	400390	PLATE, MOUNTING, CONTROLLER	2	36	73424	WASHER, FLAT, ZINC SAE 1/2	11
9	400124	HOSE, VACUUM 2" DIA, 3' CUT, W/CUFFS	2	37	8274-29	BELT	1
10	7274-200	WHEEL	2	38	400204	SCREW, SET, NYLON 1/2-13X3/4	1
11	401431	WEIGHT, CAST, GRINDER	4	39	73202	WASHER, INTERNAL LOCK 3/8	8
12	401549	CONTROLLER 115V, 1 PH, VFD	1	40	73204	WASHER, LOCK 3/8	11
13	402339	GUARD, RUBBER DUST, VELCRO, 6.5 X 65.00	1	41	73207	NUT, NYLOCK 3/8-16	3
14	8274-53	PLATE, BASE, GEAR BOX	1	42	73216	BOLT, HEX HEAD CAP SCREW 3/8-16X1-3/4	4
15	8274-27	PULLEY, 90 TOOTH	1	43	73223	BOLT, FLANGE 3/8016X1-1/4	2
16	8274-33	PLATE, PULLEY	1	44	73252	BOLT, HEX HEAD CAP 3/8-16X4 1/2	1
17	8274-64	PLANETARY, 18"	1	45	73263	WASHER, FLAT SAE ZINC 3/8	4
18	8274-68	TENSIONER, PLANETARY BELT	2	46	73309	SCREW, SOCKET HEAD CAP 5/16-18X3/4	2
19	8274-69	WEIGHT, COUNTER	1	47	73401	NUT, STRAIN RELIEF, STEEL 1/2"	2
20	71222	BEARING, 20MM ID	3	48	73402	NUT, NYLOCK 1/2-13	3
21	71232	BEARING, 20MM ID 1DC	12	49	L189	LABEL ASBESTOS HD	1
22	73037	BOLT, FLAT HEAD SOCKET CAP 1/4-20X1	4	50	L193	LABEL, 8274-4	1
23	73208	BOLT, HEX HEAD CAP 3/8-16X1-1/2	4	51	L223	LABEL, PATENT NUMBER	1
24	73237	WASHER, HARDENED DIE 3/8	3	52	L265	LABEL, SILICA DUST	1
25	73904	KEY, 3/16X3/16X3/4	3	53	L33B	LABEL, CAUTION MOVING PART	1
26	80043	PULLEY, 22 TOOTH	3	54	L49	LABEL, CORD CAUTION	1
27	80049	SHAFT, SCRUBBER, WELDMENT	3				
28	400388	MOTOR, 3 HP, 230/480	1				



# Parts List and Diagrams

PART#	DESCRIPTION	QTY	
1	80024	BLOCK, PLANETARY HANDLE	1
2	80026	TUBE, OVAL, PLANETARY HANDLE	1
3	80035	TUBE, INNER WELDMENT	1
4	80036	TUBE, OUTER WELDMENT	1
5	80037	FRAME, PLANETARY HANDLE	1
6			
7	80039	SPLITTER, VAC	1
8	8274-46	BRACKET, CONTROLLER 8274	1
9	400390	PLATE, MOUNTING, CONTROLLER	2

## HANDLE PARTS

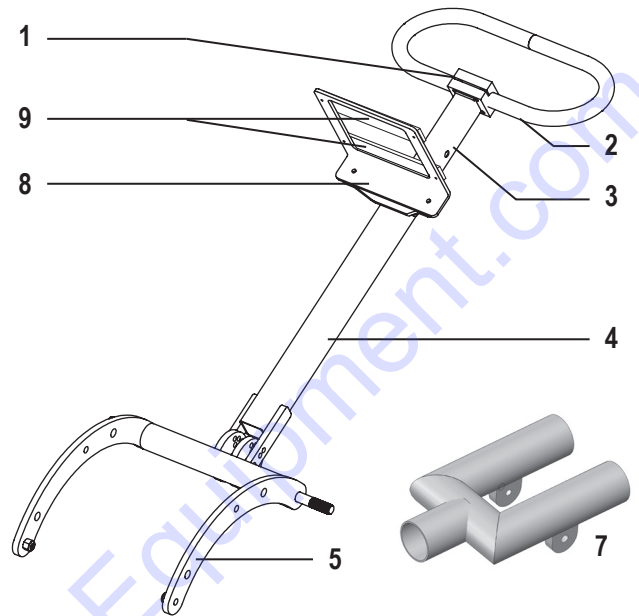

PART#	DESCRIPTION	QTY	
1	400124	HOSE, VACUUM 2" DIA, 3' CUT, W/CUFFS	2
2	7274-200	WHEEL	2
3	401431	WEIGHT, CAST, GRINDER	4
4	401549	CONTROLLER 115V, 1 PH, VFD	1
5	402339	GUARD, RUBBER DUST, VELCRO, 6.5 X 65.00	1
6	8274-53	PLATE, BASE, GEAR BOX	1

## EXTERNAL PARTS



# Parts List and Diagrams

## 18" DECK ASSEMBLY

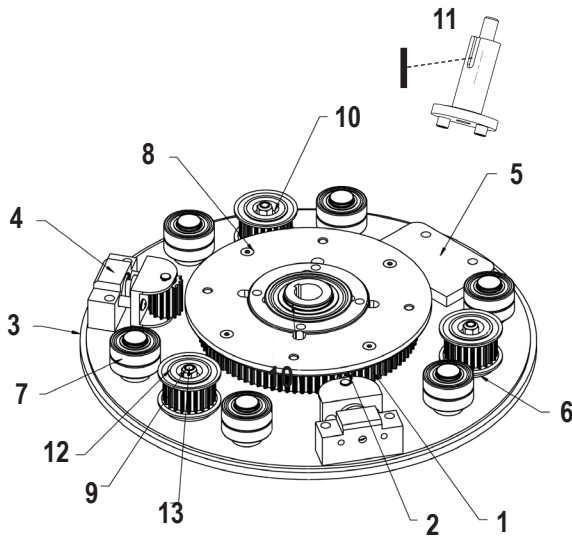

	PART#	DESCRIPTION	QTY
1	8274-27	PULLEY, 90 TOOTH	1
2	8274-33	PLATE, PULLEY	1
3	8274-64	PLANETARY, 18"	1
4	8274-68	TENSIONER, PLANETARY BELT	2
5	8274-69	WEIGHT, COUNTER	1
6	71222	BEARING, 20MM ID	3
7	71232	BEARING, 20MM ID 1DC	12
8	73037	BOLT, FLAT HEAD SOCKET CAP 1/4-20X1	4
9	73208	BOLT, HEX HEAD CAP 3/8-16X1-1/2	4
10	73237	WASHER, HARDENED DIE 3/8	3
11	73904	KEY, 3/16X3/16X3/4	3
12	80043	PULLEY, 22 TOOTH	3
13	80049	SHAFT, SCRUBBER, WELDMENT	3

## MOTOR

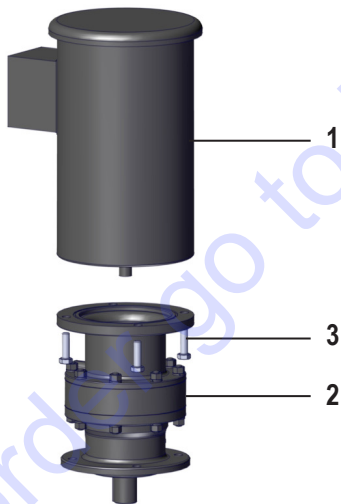

	PART#	DESCRIPTION	QTY
1	400388	MOTOR, 3 HP, 230/480	1
2	401640	REDUCER, GRINDER, GROVE	1
3	73201	SCREW, HEX HEAD CAP, 3/8-16X1	4

# Parts List and Diagrams

## PARTS NOT SHOWN

PART#	DESCRIPTION	QTY	PART#	DESCRIPTION	QTY
1	L106	2	14	73252	1
2	73604	2	15	73263	4
3	80047	1	16	73309	2
4	73410	2	17	73401	2
5	73417	1	18	73402	3
6	73424	11	19	L189	1
7	8274-29	1	20	L193	1
8	400204	1	21	L223	1
9	73202	8	22	L265	1
10	73204	11	23	L33B	1
11	73207	3	24	L49	1
12	73216	4			
13	73223	2			

**TO PURCHASE THIS PRODUCT PLEASE CONTACT US**



**Equipment Financing and  
Extended Warranties Available**



**Discount-Equipment.com is your online resource for  
commercial and industrial quality parts and equipment sales.**

**561-964-4949**

**visit us on line @ [www.discount-equipment.com](http://www.discount-equipment.com)**

Select an option below to find your Equipment

**Search by Manufacturer**

**Search by Product Type**

**Request a Quote**

We sell worldwide for the brands: Genie, Terex, JLG, MultiQuip, Mikasa, Essick, Whiteman, Mayco, Toro Stone, Diamond Products, Generac Magnum, Airman, Haulotte, Barreto, Power Blanket, Nifty Lift, Atlas Copco, Chicago Pneumatic, Allmand, Miller Curber, Skyjack, Lull, Skytrak, Tsurumi, Husquvarna Target, Stow, Wacker, Sakai, Mi-T-M, Sullair, Basic, Dynapac, MBW, Weber, Bartell, Bennar Newman, Haulotte, Ditch Runner, Menegotti, Morrison, Contec, Buddy, Crown, Edco, Wyco, Bomag, Laymor, EZ Trench, Bil-Jax, F.S. Curtis, Gehl Pavers, Heli, Honda, ICS/PowerGrit, IHI, Partner, Imer, Clipper, MMD, Koshin, Rice, CH&E, General Equipment, Amida, Coleman, NAC, Gradall, Square Shooter, Kent, Stanley, Tamco, Toku, Hatz, Kohler, Robin, Wisconsin, Northrock, Oztec, Toker TK, Rol-Air, APT, Wylie, Ingersoll Rand / Doosan, Innovatech, Con X, Ammann, Mecalac, Makinex, Smith Surface Prep, Small Line, Wanco, Yanmar