

110-8 SCARIFIER OPERATING & SERVICE MANUAL



Read Manual Before Operating or
Servicing Machine

405974 Rev B

**Discount
Equipment**

TO PURCHASE THIS PRODUCT PLEASE CONTACT US



**Equipment Financing and
Extended Warranties Available**



**Discount-Equipment.com is your online resource for
commercial and industrial quality parts and equipment sales.**

561-964-4949

visit us on line @ www.discount-equipment.com

Select an option below to find your Equipment

Search by Manufacturer

Search by Product Type

Request a Quote

We sell worldwide for the brands: Genie, Terex, JLG, MultiQuip, Mikasa, Essick, Whiteman, Mayco, Toro Stone, Diamond Products, Generac Magnum, Airman, Haulotte, Barreto, Power Blanket, Nifty Lift, Atlas Copco, Chicago Pneumatic, Allmand, Miller Curber, Skyjack, Lull, Skytrak, Tsurumi, Husquvarna Target, Stow, Wacker, Sakai, Mi-T-M, Sullair, Basic, Dynapac, MBW, Weber, Bartell, Bennar Newman, Haulotte, Ditch Runner, Menegotti, Morrison, Contec, Buddy, Crown, Edco, Wyco, Bomag, Laymor, EZ Trench, Bil-Jax, F.S. Curtis, Gehl Pavers, Heli, Honda, ICS/PowerGrit, IHI, Partner, Imer, Clipper, MMD, Koshin, Rice, CH&E, General Equipment, Amida, Coleman, NAC, Gradall, Square Shooter, Kent, Stanley, Tamco, Toku, Hatz, Kohler, Robin, Wisconsin, Northrock, Oztec, Toker TK, Rol-Air, APT, Wylie, Ingersoll Rand / Doosan, Innovatech, Con X, Ammann, Mecalac, Makinex, Smith Surface Prep, Small Line, Wanco, Yanmar

Table of Contents

Table of Contents	3
Specifications	4
Safety	5
General Rules	5
Warnings	6
Organizational Measures and Safety	6
Selecting Personnel and Their Qualifications	6
Safety Instructions for Normal Operations	7
Maintenance and Troubleshooting During Work	7
Safety OFF Position	8
Electrical Engineering Regulations	8
General Information	9
Description of Machine	9
Switchbox	9
Operating Elements	9
Scarifier Drum	10
Cutting Tools	10
Transport	11
Transporting with a Vehicle	11
Transporting by Hand	11
Transporting with Lifting Gear	11
Preparation and Starting	12
Preparation	12
Starting the Machine	12
Operation	13
Operations	13
Feed Rate	13
Recommended Scarifying Directions	13
Turning the Machine Off	13
Safety Switch	13
Fault Diagnosis Guide	14
Maintenance	15
Maintenance Information	15
Maintenance and Inspection List	15
Repairs	15
Scarifier Drum	15
Gear Belt	16
Motor	16
Spare Parts and Diagrams	17
Standard	17
Optional Upgrades	18
Service Parts	19

Specifications

Product Specifications					
Length	Width	Working Width	Height	Weight	Noise Level
35.4" (900 mm)	14.2" (360 mm)	7.9" (200 mm)	39.4" (1000 mm)	131 lbs (59.4 kg)	89.4 dB(A)

 **WARNING:** THE MAX PERMITTED NOISE LEVEL OF 89 DB(A) MAY BE EXCEEDED. NOISE LEVEL OF 100 DB(A) IS POSSIBLE! OPERATORS MUST WEAR NOISE-PROTECTIVE GEAR.

Product Specifications				
Power	Connected Loads	Feed	Recommended Dust Collector	Vibrations
120V	120V 60 Hz 18.8A; for 125VAC, 20A, 5-20P plug	Manual	DL2000	2.99 m/s ²

 **WARNING:** THIS MACHINE IS DESIGNED FOR WORKING HORIZONTAL SURFACES, SPECIFICALLY CHISELING AND DEMOLITION. ALL OTHER APPLICATIONS ARE DEEMED TO BE INCORRECT USE. THE MANUFACTURERS WILL NOT BE LIABLE FOR ANY DAMAGE RESULTING FROM INCORRECT USE. THE USER IS SOLELY RESPONSIBLE FOR ANY RISK.

GENERAL RULES FOR SAFE OPERATION

Before use, anyone operating or performing maintenance on this equipment must read and understand this manual, as well as any labels packaged with or attached to the machine and its components. Read the manual carefully to learn equipment applications and limitations, as well as potential hazards associated with this type of equipment. Keep manual near machine at all times. If your manual is lost or damaged, contact Discount-equipment for a replacement.

Personal

Dress properly and use safety gear.

Do not wear loose clothing; it may be caught in moving parts. Anyone in the work area must wear safety goggles or glasses and hearing protection. Wear a dust mask for dusty operations. Hard hats, face shields, safety shoes, etc. should be worn when specified or necessary.

Maintain control; stay alert.

Keep proper footing and balance, and maintain a firm grip. Observe surroundings at all times. Do not use when tired, distracted, or under the influence of drugs, alcohol, or any medication that may cause decreased control.

Keep hands away from all moving parts and tooling.

Wear gloves when changing tooling. Remove tooling when machine is not in use and/or lower cutting head to the floor.

Do not force equipment.

Equipment will perform best at the rate for which it was designed. Excessive force only causes operator fatigue, increased wear, and reduced control.

Environment

Avoid use in dangerous environments.

Do not use in rain, damp or wet locations, or in the presence of explosive atmospheres (gaseous fumes, dust, or flammable materials). Remove materials or debris that may be ignited by sparks. Keep work area tidy and well-lit - a cluttered or dark work area may lead to accidents. Extreme heat or cold may affect performance.

Protect others in the work area and be aware of surroundings.

Provide barriers or shields as needed to protect others from debris and machine operation. Children and other bystanders should be kept at a safe distance from the work area to avoid distracting the operator and/or coming into contact with the machine. Operator should be aware of who is around them and their proximity. Support personnel should never stand next to, in front of, or behind the machine while the machine is running. Operator should look behind them before backing up.

Do not come within 3 ft. of the machine's perimeter during operation.

Guard against electric shock.

Ensure that machine is connected to a properly grounded outlet. Prevent bodily contact with grounded surfaces, e.g. pipes, radiators, ranges, and refrigerators. When scoring or making cuts, always check the work area for hidden wires or pipes.

Maintenance & Repairs

Begin maintenance work only when the machine is shut down, unplugged, and cooled down.

Use proper cleaning agents.

Ensure that all cleaning rags are fiber-free; do not use any aggressive cleaning products.

Schedule regular maintenance check-ups.

Ensure machine is properly cleaned and serviced. Remove all traces of oil, combustible fuel, or cleaning fluids from the machine and its connections and fittings. Retighten all loose fittings found during maintenance and repair work. Loose or damaged parts should be replaced immediately; use only NFE parts.

Do not weld or flame-cut on the machine during repairs, or make changes to machine without authorization from NFE.

Equipment

Use proper parts and accessories.

Only use NFE-approved or recommended parts and accessories. Using any that are not recommended may be hazardous.

Ensure accessories are properly installed and maintained.

Do not permanently remove a guard or other safety device when installing an accessory or attachment.

Inspect for damaged parts.

Check for misalignment, binding of moving parts, loose fasteners, improper mounting, broken parts, and any other conditions that may affect operation. If abnormal noise or vibration occurs, turn the machine off immediately. Do not use damaged equipment until repaired. Do not use if power switch does not turn machine on and off. For all repairs, insist on only identical NFE replacement parts.

Maintain equipment and labels.

Keep handles dry, clean, and free from oil and grease. Keep cutting edges sharp and clean. Follow instructions for lubricating and changing accessories. Motor and switches should be completely enclosed at all times with no exposed wiring. Inspect cord regularly. Labels carry important information; if unreadable or missing, contact Discount-equipment for a free replacement.

Avoid accidental starting; store idle equipment.

When not in use, ensure that the machine is unplugged; do not turn on before plugging in. Store in a dry, secured place. Remove tooling when storing, and keep away from children.

Safety

WARNINGS

Be aware of warning and cautionary information, designated by a gray text box. These areas will contain information regarding dangers to the operator and/or the machine and instruction to prevent injury.

ORGANIZATIONAL MEASURES AND SAFETY

General statutory and other binding accident prevention regulations must be complied with and indicated in addition to the instruction manual. This type of obligation may govern, e.g. handling hazardous materials or supplying/wearing personal safety equipment and compliance with road traffic regulations.

The instruction manual must be supplemented by rules, including supervisory and notifying duties, taking special operational features into account, e.g. work organization, operational sequences, and personnel used.

Before starting any work with or on the machine, all personnel must read the instruction manual and, in particular, the section regarding safety instructions. This applies to everyone, but in particular those who only work on the machine occasionally, e.g. setting up, maintenance fitters, etc.

At regular intervals, inspections must be carried out so that personnel are safety-conscious and aware of all the risks and work in compliance with the instruction manual.

Personnel must not have unprotected long hair, loose clothing, or jewelry. There is a risk of injury through hair or clothing getting stuck or being pulled into the machine.

Where necessary or required by regulations, personal safety equipment must be used. All safety and warning information on the machine must be complied with.

All information concerning safety and risks on the machine must be kept in a complete and legible condition.

If changes affecting safety occur to the machine or its operational behavior, shut the machine off immediately. The reason for fault must be found immediately!

Alterations, extensions, and conversions that might affect safety require the approval of the manufacturer. This applies in particular to the installation of safety devices and to welding work on any supporting parts.

Schedules in the instruction manual for periodic inspections must be complied with. An adequately equipped workshop is essential for repair and maintenance work.

The location and instructions for using fire extinguishers must be shown on all sites.



CAUTION: SPARE PARTS MUST CONFORM TO THE MANUFACTURER'S SPECIFICATIONS. THIS IS ALWAYS GUARANTEED WITH NFE ORIGINAL PARTS.

SELECTING PERSONNEL AND THEIR QUALIFICATIONS

Only reliable personnel may carry out work on the machine.

The statutory minimum age must be complied with. Clear fields of responsibility must be stipulated for operating, maintaining, and repairing.

Stipulate machine operators' responsibility with regard to road traffic regulations and authorize them to refuse instructions from third parties that contravene safety regulations.

Personnel in training or under instruction may only operate the machine under the supervision of an experienced person



WARNING: WORK ON ELECTRICAL PARTS OF THE MACHINE MUST BE CARRIED OUT BY A QUALIFIED ELECTRICIAN OR BY EXPERIENCED PERSONS UNDER THE SUPERVISION OF A QUALIFIED ELECTRICIAN IN COMPLIANCE WITH REGULATIONS GOVERNING ELECTRICAL ENGINEERING.

SAFETY INSTRUCTIONS FOR NORMAL OPERATIONS

Never work in a way that might impair safety.

Measures must be taken to ensure that the machine can only be operated in a safe and reliable condition. Never use the machine unless all safety devices and equipment affecting safety, e.g. detachable safety equipment, emergency switches, and dust collectors, are in place and working.

Check the machine at least once every day for external damage and defects.

If function faults occur, switch the machine off immediately and secure it. Disconnect from any electrical connections right away.

When working in the open, guard the machine's working area with a clearance on all sides of at least 6.6 ft (2 m).

Faults must be eliminated immediately.

Switch the machine ON and OFF as shown in this manual. Before switching the machine on, make sure that no one can be endangered when the machine starts up. Never switch off or remove dust collectors when the machine is running.

When extending the main cord, use only extension cords that are dimensioned in accordance with the machine's total output and with current regulations.



WARNING: ALL PERSONS IN THE VICINITY OF THE MACHINE WHEN IT IS RUNNING MUST WEAR SAFETY GOGGLES WITH SIDE PROTECTORS, HEARING PROTECTION, AND SAFETY SHOES. OPERATORS MUST WEAR CLOSE-FITTING CLOTHES.



WARNING: DURING THE FLOOR PREPARATION, UPCOMING DUST IS A HEALTH RISK. YOU MUST USE A PROFESSIONAL DUST COLLECTOR AND HIGH QUALITY RESPIRATORY PROTECTION WHILE USING THE MACHINE.

MAINTENANCE AND TROUBLESHOOTING DURING WORK

Always switch machine to the OFF position before starting any maintenance work.

Read through the entire manual to ensure that all safety instructions are followed.

Maintenance and inspection work and schedules in this manual must be complied with.

This machine must only be operated by skilled and authorized personnel.

Always inform the operating personnel before starting any special or maintenance work.

Whenever work is carried out that affects the machine's operations, safety devices, inspection, etc., the procedures within this instruction manual must be complied with.

Ensure dust collector usage complies with all safety instructions in this manual.

When the machine is switched off completely for maintenance and repairs, secure it against unintended startup by unplugging it.

Always empty the dust collector's container or bag before shipping. Comply with current waste disposal regulations; if necessary, contact your local authority. Never use aggressive cleaners! Use non-fiber cloths. Always tighten screwed connections that were loosened for maintenance work.

If safety equipment has to be dismantled for part replacement, maintenance, or repairs, always install and check the safety devices immediately after completing the work.

Always dispose of materials and supplies safely and protect the environment.



WARNING: ALL MACHINERY CAN BE DANGEROUS FOR OPERATING, MAINTENANCE, AND REPAIR PERSONNEL IF USED INCORRECTLY. OWNERS ARE RESPONSIBLE FOR COMPLIANCE WITH SAFETY REGULATIONS DURING OPERATIONS AND MAINTENANCE OF THE SAFETY DEVICES SUPPLIED WITH THE MACHINE, AND FOR PROVIDING SUITABLE SAFETY DEVICES. IT IS STRICTLY PROHIBITED TO REMOVE OR CHANGE THE SECURITY SYSTEM OF THE MACHINE!

Safety

SAFETY OFF POSITION

The machine is in safety OFF position when the machine is unable to endanger anyone.

In order to put the machine into the safety OFF position, first turn off the machine and wait until the drives come to a complete stop. Once the drives have stopped, turn off the dust collector and unplug both the machine and dust collector.

ELECTRICAL ENGINEERING REGULATIONS

Electrical equipment must be checked regularly. Defects such as loose connections or scorched cables must be corrected immediately. Contact Discount-equipment.

Do not start work until you are familiar with the electrical engineering regulations that apply to your area, and until the responsible electrician has given the necessary authorization.

DESCRIPTION OF MACHINE

Features:

- Switch box
- Quick lifter
- Connection to dust collector
- Depth setting
- Machine housing

NFE's 110-8 scarifiers are supplied with a 120V electric motor. Scarifiers with a working width of 7.9" (200 mm) are sturdy and powerful machines that can be used on any surface. The fine settings of the working depth guarantee that the subsurface is protected. Fitted with the appropriate tools, the 110-8 scarifiers can be used for various applications:

- Scarifying concrete
- Cleaning any type of surface
- Removing coatings and adhesives
- Scoring concrete surfaces
- De-rusting metal surfaces, e.g. ship decks and tanks
- Grinding-away and de-scaling
- Preparing surfaces for new toppings

The depth settings enable the appropriate cutting tools to be used at the highest level of efficiency

SWITCHBOX

The switchbox is fitted with ON, emergency stop, and security switches.

1. ON switch
2. Emergency stop button

ON SWITCH

The ON switch is located on the switchbox. Before turning the machine on, use the quick lifter to lift the scarifier drum in order to prevent the motor from starting or coasting under a full load.

EMERGENCY STOP SWITCH AND RESTART

The large red button is the emergency stop switch; pressing this button will cut off the current to the drive immediately. In order to restart the machine, push the ON switch.

UNDER-VOLTAGE RELEASE

An integrated under-voltage release cuts off the current supply immediately if, e.g. the fuse falls out, current fluctuations occur, or a cable is damaged.

OPERATING ELEMENTS

QUICK LIFTER

The 110-8 scarifier has a quick lifter for the scarifier drum. The quick lifter can be used to lift the scarifier drum, without altering the cutting depth, in order to move the machine.



General Information

STEPLESS DEPTH ADJUSTMENT

Turn the setting wheel or hand wheel to set the cutting depth so that the individual cutting wheels bite correctly (scratch) and the desired surface quality and structure is obtained. The stepless depth setting enables the milling tool to be set as deep as required on the surface to be treated and no deeper.

The cutting depth should only be set on the surface to be treated "deep" enough so that the cutting tools are thrown up without obstruction through centrifugal force and can turn freely on the lateral axes. If the depth setting has been set correctly, the machine will run quietly and evenly.

WHEEL STOPPER

The machine is equipped with a wheel stopper on the left back side to ensure its absolute fixation.



SCARIFIER DRUM

The scarifier drum is the heart of the machine. The scarifier drum has a very simple structure. The individual cutting tools are slid onto the lateral axes with spacers as shown in the enclosed assembly plan. The spacers ensure that there is sufficient clearance between the cutting tools.

The enclosed component diagram takes into account a required lateral play of approximately .12"-.2" (3-5 mm) for the cutting tools.

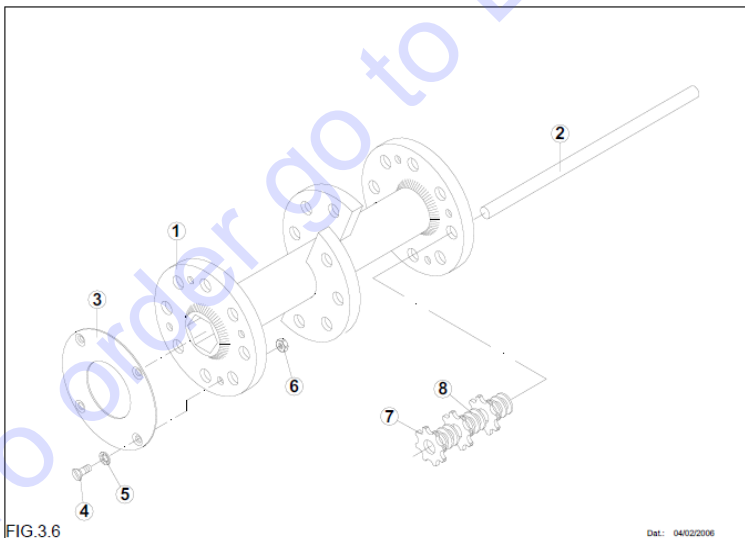

- 1) Scarifier drum
- 2) Axle
- 3) Safety panel
- 4) Safety screw
- 5) Belleville washer
- 6) Security nut
- 7) Cutting tool
- 8) Spacer

CUTTING TOOLS

A variety of different cutting tools enable the 110-8 scarifier to be refitted with ease for each application or to match each surface. All these machines work on the principle of loose cutting tools on an axle. The rotation of the scarifier drum generates a centrifugal force at the lateral axle which "throws up" the cutting tools so that they come into contact with the surface to be treated.

TRANSPORTING WITH A VEHICLE

When transporting the machine, make sure that impact damage is avoided. Use straps to secure the machine on the vehicle. Use at least two straps and secure the machine firmly.

TRANSPORTING BY HAND

Before you can move the machine, you must actuate the quick lifter (see Section 3). The machine can be moved easily by hand.

The machine is transported in parts: (1) machine, and (2) general accessories.

TRANSPORT WITH LIFTING GEAR

If you want to move the machine with lifting gear such as a crane or elevator, note the maximum permitted weights. Use only approved and tested slings. See Section 1 for the machine weight or check the serial number plate.

To order go to Discount-Equipment.com

Preparation and Starting

PREPARATION

Before starting, make sure that all safety housings are in place and that the dust collector has been correctly connected. Handle all plugs, cables, tubes, and operating elements with care. Avoid contact with live conductors.

If you have problems with the power supply during assembly and starting, contact a qualified electrician. Work on electrical parts may be carried out by qualified personnel only.

Regular inspections are important to prevent breakdowns. Before starting:

- Check that all machine components have been correctly assembled.
- Check that all screws and other fasteners are tight.
- Check the scarifier drums for foreign bodies and remove them.
- Check the scarifier drum, housing, and fastening screws for damage and wear.
- Check the tube connections for leaks.
- Empty the bag or container of the dust collector.
- Check the electrical connections for dirt and foreign body deposits.
- Check the electric motors for dirt and other impurities.
- Check the main cable and dust hose for damage.

Replace and repair all damaged parts before starting the machine. Then,

1. Bring the machine and the dust collector to the surface you want to work. To move the machine by hand, actuate the quick lift handle as shown in the Transport Section.
2. Connect the machine and the dust collector to the dust hose. Use hose clamps at the connections.
3. Connect the electricity cable for the dust collector to the site terminal.
4. Connect the scarifier cable to terminal.

STARTING THE MACHINE

Before starting the machine, ensure all safety regulations are adhered to!

The gear belt must run parallel on both driving discs. The belt must be tight, but not too tight. Never operate the machine without the belt guard.

To start the machine, take the following steps:

1. Switch the dust collector on.
2. Ensure that the brake/wheel stopper on the machine is clamped tight.
3. Check that the scarifier drum is in the OFF position (i.e. lifted by means of the quick lift handle).
4. Using the hand wheel, turn the depth setting completely back (counterclockwise) so that the scarifier drum cannot touch the ground when the machine is lowered.
5. Press the black ON switch.
6. Release the brake/wheel stopper.
7. Lower the scarifier drum slowly with the quick lift handle.
8. Depending on the surface you want to work, you can now use the hand wheel to set the cutting depth until you obtain the surface profile you want. Grasp the handle securely while setting the cutting depth.

If the cutting depth is too deep, this will have a negative effect on the machine. Instead of cleaning or cutting, the cutters will block; causing the machine to run unevenly and “jump.”

By pushing the machine you can now work the surface without any effort at all. The feed rate depends on the characteristics of the surface and the surface structure you want to obtain. A push/pull operation may work best while moving the machine forward.

OPERATIONS

Normally, starting and operating machine is the same procedure as described in Section 5. Work should be carried out in parallel tracks and in such a way that the dust hose and the electric cable do not become twisted.

Make sure that vehicles, such as forklift trucks, and other appliances do not drive over the electric cable and the dust hose.

FEED RATE

Choosing the right feed rate is important for good results. If the surface is uneven, you can vary the feed rate during the process to obtain uniform results.

The feed rate depends on the material of the surface being worked and required profile. To select the correct feed rate, inspect the surface and vary the rate in dependence on the desired penetration depth.

RECOMMENDED SCARIFYING DIRECTIONS

Place the dust collector near a mains connection. Place the scarifier near the dust collector and unroll the hose. Work with the scarifier when the hose is unrolled in the other direction by repeating the working process away from the dust collector.

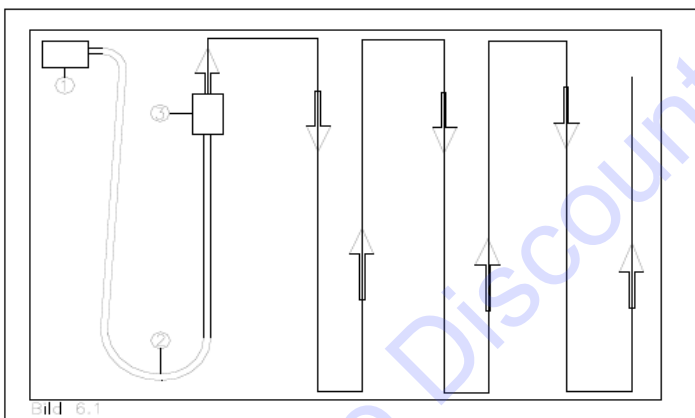

- 1) Dust collector
- 2) Dust hose
- 3) Machine

TURNING THE MACHINE OFF

1. Lift the scarifier drum from the surface with the quick lift handle.
2. Press the emergency OFF switch.
3. Set the main switch of the dust collector to OFF.
4. If the machine will be turned off for a long period of time, pull the plug out. Protect electric motors against moisture, heat, dust, and impact; cover the machine with a plastic sheet.



CAUTION: MAKE SURE THAT ALL ROTATING PARTS HAVE COME TO A COMPLETE STANDSTILL BEFORE YOU START ANY INSPECTION OR MAINTENANCE WORK. MAKE SURE THE MACHINE IS SET TO THE PRESCRIBED SAFETY OFF POSITION.

SAFETY SWITCH

Before carrying out any repairs, set the machine to the safety OFF position and cut off the power supply (pull the plug out).

Troubleshooting Guide

Problem	Possible Cause	Solution
Excessive vibration	Imbalance as result of worn or broken cutting tools	Replace all worn or broken tools
Unusual noise	Defective bearing	Check drive shaft bearing and replace if necessary
	Incorrect tension of gear belt	Check gear belt tension and alter if necessary
	Defective motor	Replace motor
Reduced or no milling performance	The cutters have reached limit of wear	Replace worn components
	Use of cutting tools that are not suitable for that task	Replace tools and use suitable cutter types for the surface being treated
Controller cannot be switched on	Motor protective switch triggered	Check the main connection and switch on again
Motor does not start	Defective fuses or circuit breakers in site power supply (by others)	Contact Discount-equipment
	Break in extension cable.	
	Refer to Discount-equipment	



WARNING: BEFORE BEGINNING ANY REPAIR WORK ON THE MACHINE, MAKE SURE THAT IT IS TURNED OFF AND DISCONNECTED FROM THE POWER SOURCE.

MAINTENANCE INFORMATION

Breakdowns caused by insufficient and unprofessional maintenance can lead to very high repair costs and long downtimes. Regular maintenance is essential. Operational safety and the service life of the machine depend on several factors, including proper maintenance.

The following table contains information on schedules, inspections, and maintenance for normal working. The times are based on daily use. If the number of working hours shown here is not reached in the corresponding period, the period may be extended. However, a complete inspection must take place every year.

Because operation conditions can vary considerably, it is not possible to state in advance how often checks for wear, inspections, maintenance, and repairs are necessary. A practical inspection schedule should be drawn up taking the operating conditions into account. Contact Discount-equipment if you require further assistance.

MAINTENANCE AND INSPECTION LIST

12 hours after repairs	Daily and before starting work	Yearly
<ul style="list-style-type: none"> • Check all safety devices are functioning as designed. • Check all accessible screw connections for correct fit. 	<ul style="list-style-type: none"> • Check main pipe for damage. • Check the hose to the dust collector for damage. • Check whether there are any foreign bodies in the scarifier drum. • Check that the bag or container of the dust collector is empty. • Check the scarifier drum, lateral axle, cutting tools, and housing for wear. • Check the tension of the gear belt; tighten if needed. 	<ul style="list-style-type: none"> • Full overhaul and cleaning of the complete machine.

REPAIRS

We recommend that the repairs of the machine are carried out by NFE or our authorized dealers. This manual only describes repairs that occur during maintenance work or when replacing worn parts.

Always keep stocks of spare parts that cannot be supplied at short notice. Production losses are usually more expensive than the costs of the spare part. Any screw you remove must be replaced in the same quality and design.

Only use NFE original parts.

SCARIFIER DRUM

The scarifier drum is a highly stressed component of the machine and special attention should be paid to it during maintenance and repairs. If the scarifier drum is replaced, always clean and lubricate the drive shaft, so that the next time the drum is replaced rust or deposits of dirt do not make work more difficult.

If the scarifier drum has to be dismantled during maintenance or repair, ensure that cutting tools and spacers are placed properly during reassembly. Ensure that holes in the cover plate for the lateral axle are not worn out and that the screws are tight.

To obtain an even, clean pattern on the surface you want to work, make sure to set the right cutting depth and the right components for the scarifier drum, as well as the right cutting tools for the surface.

Maintenance

If the scarifier drum is incorrectly fitted, this will lead to the machine being unbalanced and to excessive wear. NFE does not provide warranty for defective parts of any kind that point to being damaged by incorrect assembly.

The following two factors influence the pattern:

- The feed speed must be adapted to the surface structure.
- The right cutting tools must be selected for each application.

Warranty claims also lapse if non-original NFE parts and cutting tools are used.

EQUIPMENT

The component examples enclosed with the manual have been tested and display an even milling pattern.

The selection of tool types and the component arrangement are among the most important factors for optimum efficiency.

Incorrect component arrangement for the scarifier drum leads to extreme wear and reduces the performance.

REPLACING THE DRUM

Before beginning any repair work on the machine and its drives, make sure that it cannot be switched on accidentally. Set the machine to the safety OFF position (Section 2).

Dismantling:

1. Unscrew the fastening screw for the side panel and remove the panel by pulling it away from the machine housing.
2. Pull the scarifier drum off the drive shaft.

Installation:

1. Clean the drive shaft and grease it evenly.
2. Slide the scarifier drum onto the drive shaft up to the stop.
3. When fitting the side panel, make sure that the bearing unit is correctly fitted. Never use the machine without the side panel, or if the panel has been incorrectly fitted.

GEAR BELT

Before beginning any repair work on the machine and its drives, make sure that it cannot be switched on accidentally. Set the machine to the safety OFF position (Section 2).

Removing:

1. Remove the screws for the gear belt guard.
2. If necessary, slacken the belt tension* and remove it.
*The gear belt is tensed by means of the motor plate. The motor can be “raised” or “lowered” by means of the hexagonal nuts above and below the motor plate. Raising or lowering the motor tenses the gear belt or slackens it.

Installation:

1. Place the gear belt on the toothed disk and tense it.
2. Make sure that the gear belt is parallel and has the correct initial stress. Depth of impression: approx. 5 mm.



MOTOR

The motor is designed for a long service life. Unusual noises, functional faults, or breakdowns indicate damage to the motor.

In the event of functional faults, refer to the manufacturer's instructions. If a functional fault cannot be eliminated, notify the NFE customer service.

Spare Parts and Diagrams

STANDARD - INCLUDED WITH UNIT



405302 - COMPLETE DRUM ASSEMBLY W/ MILLING CUTTERS (KR-8) AND WASHERS

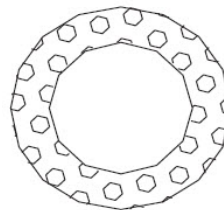
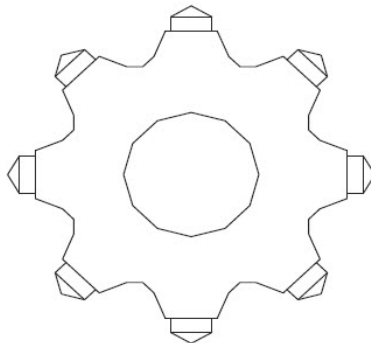

Spare Parts and Diagrams

OPTIONAL UPGRADES

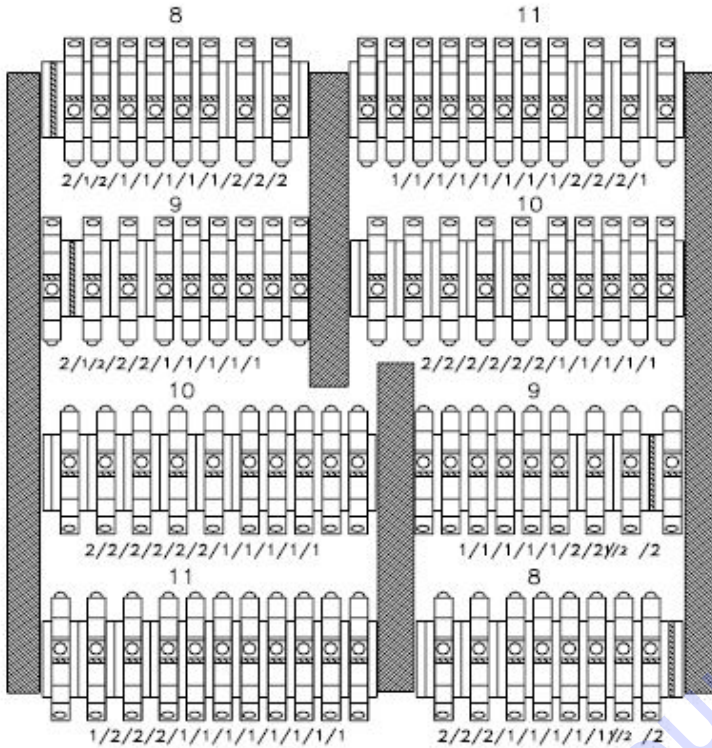

402165

DRUM COMPLETE W/ CUTTERS (HMT-5-40)

CUTTER W/ TUNGSTEN POINTS (76)

WASHER (112)

WASHER (4)

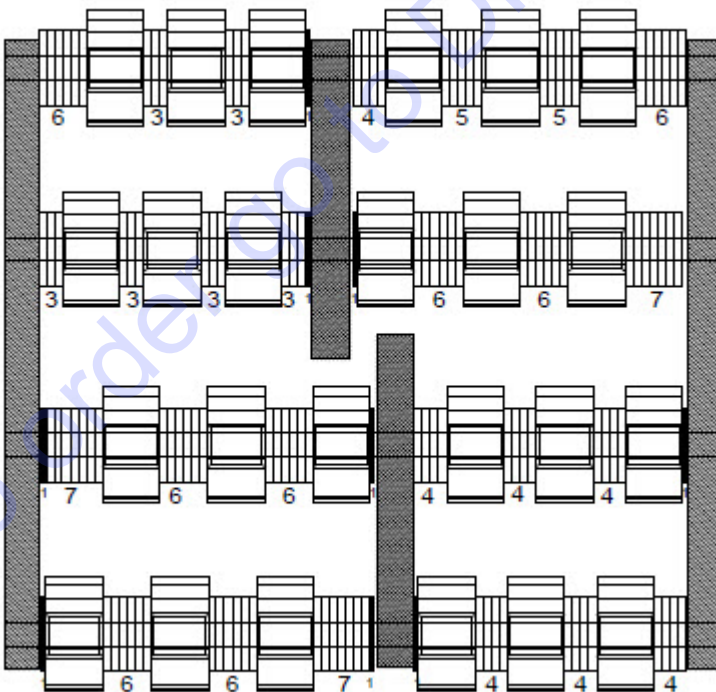
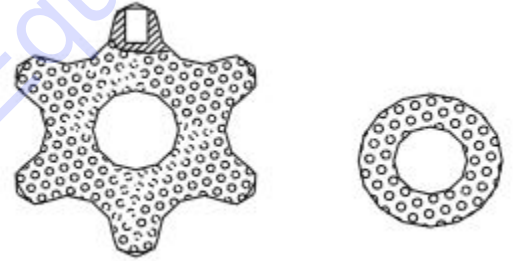

402168

DRUM COMPLETE W/ CUTTERS (TMO-7-15)

CUTTER W/ TUNGSTEN POINTS (24)

WASHER (126)

WASHER (8)

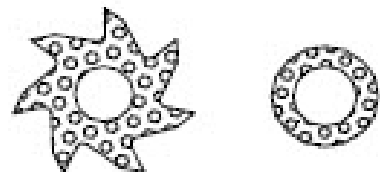

Spare Parts and Diagrams

SERVICE PARTS

Part Number	Description
402164	Belt, Gear
402165	Drum, HMT-5-40 Cutters, Complete
402166	Cutters HMT-5-40, Set of 76
402167	Washers, HMT-5-40, Set
402168	Drum, TMO-7-15 Cutters, Complete
402169	Shaft, Drum, HMT & TMO
402170	Cutters, TMO-7-15, Set
402171	Washers, TMO-7-15, Set
402173	Drum, 5 Shafts
402191	Drum, Scoring, 5 Blades
402192	Drum, Scoring, 3 Blades
402194	Cutters, TSR-7.5, Set
402195	Washers, TSR-5.5 & TSR 7.5, Set
402211	Drum, TSR-5.5 Cutters, Complete
402212	Cutters, TSR-5.5, Set
402213	Shaft, Drum, TSR
405302	Drum, KR-8 Cutters, Complete
405976	Cutters, with Washers, KR-8 with ZS, Set

TO PURCHASE THIS PRODUCT PLEASE CONTACT US



**Equipment Financing and
Extended Warranties Available**



**Discount-Equipment.com is your online resource for
commercial and industrial quality parts and equipment sales.**

561-964-4949

visit us on line @ www.discount-equipment.com

Select an option below to find your Equipment

Search by Manufacturer

Search by Product Type

Request a Quote

We sell worldwide for the brands: Genie, Terex, JLG, MultiQuip, Mikasa, Essick, Whiteman, Mayco, Toro Stone, Diamond Products, Generac Magnum, Airman, Haulotte, Barreto, Power Blanket, Nifty Lift, Atlas Copco, Chicago Pneumatic, Allmand, Miller Curber, Skyjack, Lull, Skytrak, Tsurumi, Husquvarna Target, Stow, Wacker, Sakai, Mi-T-M, Sullair, Basic, Dynapac, MBW, Weber, Bartell, Bennar Newman, Haulotte, Ditch Runner, Menegotti, Morrison, Contec, Buddy, Crown, Edco, Wyco, Bomag, Laymor, EZ Trench, Bil-Jax, F.S. Curtis, Gehl Pavers, Heli, Honda, ICS/PowerGrit, IHI, Partner, Imer, Clipper, MMD, Koshin, Rice, CH&E, General Equipment, Amida, Coleman, NAC, Gradall, Square Shooter, Kent, Stanley, Tamco, Toku, Hatz, Kohler, Robin, Wisconsin, Northrock, Oztec, Toker TK, Rol-Air, APT, Wylie, Ingersoll Rand / Doosan, Innovatech, Con X, Ammann, Mecalac, Makinex, Smith Surface Prep, Small Line, Wanco, Yanmar