

To order go to [Discount-Equipment.com](http://Discount-Equipment.com)

**Operator's manual**  
**操作手册**

**DM 230**

Please read the operator's manual carefully and make sure you understand the instructions before using the machine.

请认真阅读本操作手册，确保在充分理解各项说明之后再使用机器。



**EN CN**

**TO PURCHASE THIS PRODUCT PLEASE CONTACT US**



**Equipment Financing and  
Extended Warranties Available**



**Discount-Equipment.com is your online resource for  
commercial and industrial quality parts and equipment sales.**

**561-964-4949**

**visit us on line @ [www.discount-equipment.com](http://www.discount-equipment.com)**

Select an option below to find your Equipment

**Search by Manufacturer**

**Search by Product Type**

**Request a Quote**

We sell worldwide for the brands: Genie, Terex, JLG, MultiQuip, Mikasa, Essick, Whiteman, Mayco, Toro Stone, Diamond Products, Generac Magnum, Airman, Haulotte, Barreto, Power Blanket, Nifty Lift, Atlas Copco, Chicago Pneumatic, Allmand, Miller Curber, Skyjack, Lull, Skytrak, Tsurumi, Husquvarna Target, Stow, Wacker, Sakai, Mi-T-M, Sullair, Basic, Dynapac, MBW, Weber, Bartell, Bennar Newman, Haulotte, Ditch Runner, Menegotti, Morrison, Contec, Buddy, Crown, Edco, Wyco, Bomag, Laymor, EZ Trench, Bil-Jax, F.S. Curtis, Gehl Pavers, Heli, Honda, ICS/PowerGrit, IHI, Partner, Imer, Clipper, MMD, Koshin, Rice, CH&E, General Equipment, Amida, Coleman, NAC, Gradall, Square Shooter, Kent, Stanley, Tamco, Toku, Hatz, Kohler, Robin, Wisconsin, Northrock, Oztec, Toker TK, Rol-Air, APT, Wylie, Ingersoll Rand / Doosan, Innovatech, Con X, Ammann, Mecalac, Makinex, Smith Surface Prep, Small Line, Wanco, Yanmar

# KEY TO SYMBOLS

## Symbols on the machine:

WARNING! The machine can be a dangerous tool if used incorrectly or carelessly, which can cause serious or fatal injury to the operator or others.



Please read the operator's manual carefully and make sure you understand the instructions before using the machine.



Always wear:

- Approved protective helmet
- Approved hearing protection
- Protective goggles or a visor
- Breathing mask



This product is in accordance with applicable EC directives.



### Environmental marking.

Symbols on the product or its packaging indicate that this product cannot be handled as domestic waste. It must instead be submitted to an appropriate recycling station for the recovery of electrical and electronic equipment.



By ensuring that this product is taken care of correctly, you can help to counteract the potential negative impact on the environment and people that can otherwise result through the incorrect waste management of this product.

For more detailed information about recycling this product, contact your municipality, your domestic waste service or the shop from where you purchased the product.

Ensure that water cannot leak into the machine when drilling in the ceiling. Use an appropriate water collector and cover the machine in plastic, but do not cover the air intakes and air outlets.



**Other symbols/decals on the machine refer to special certification requirements for certain markets.**

---

# CONTENTS

---

## Contents

### KEY TO SYMBOLS

Symbols on the machine: ..... 2

### CONTENTS

Contents ..... 3

### PRESENTATION

DM 230 ..... 4

### WHAT IS WHAT?

What is what on the drilling machine? ..... 5

### SAFETY INSTRUCTIONS

Steps before using a new drilling machine ..... 6

Personal protective equipment ..... 6

### SAFETY INSTRUCTIONS

General safety precautions ..... 7

General working instructions ..... 8

Machine's safety equipment ..... 10

Checking, maintaining and servicing the machine's safety equipment ..... 11

### STARTING AND STOPPING

Before starting ..... 12

Starting ..... 12

Stopping ..... 12

### MAINTENANCE

General ..... 13

Changing the drill bit ..... 13

Cleaning ..... 13

Water tap ..... 13

Electrical Feed ..... 13

Repairs ..... 13

Changing the gearbox oil ..... 14

Replacing the carbon brushes ..... 14

Daily maintenance ..... 14

### TECHNICAL DATA

EC Declaration of Conformity ..... 16

### WIRING DIAGRAM

# PRESENTATION

## DM 230

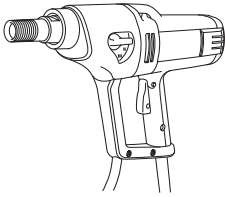

It is our wish that you will be satisfied with your product and that it will be your companion for a long time. Think of this operator's manual as a valuable document. By following its content (usage, service, maintenance, etc), the life span and the second-hand value of the machine can be extended. If you sell this machine, make sure that the operator's manual is passed on to the buyer.

A purchase of one of our products gives you access to professional help with repairs and services. If the retailer who sells your machine is not one of our authorized dealers, ask him for the address of your nearest service workshop.

Husqvarna Construction Products has a policy of continuous product development. Husqvarna reserves the right to modify the design and appearance of products without prior notice and without further obligation introduce design modifications.

- The DM 230 is an electric handheld drill, intended for drilling concrete, brick and various stone materials.
- The drilling machine has a modular design and is easy to assemble.
- The machine is equipped with spirit levels to facilitate drilling and a swivel handle with an integrated adapter for support pins to make the work more comfortable.
- DM 230 has three speed ranges for drill bit sizes up to 150 mm.
- The machine has a water cooled gearbox with a pipe that runs through the spindle.
- DM 230 can also be connected to a vacuum cleaner with the help of an adapter, used for dry drilling, which is attached to the spindle.
- The drilling machine is equipped with Softstart™, Smartstart™, Elgard™ and speed control.

### Softstart™

Softstart™ is an electronic power limitation, making it easier to start the drill. Maximum speed is reached in about three seconds after the power switch is pressed in.

### Smartstart™

If the Smartstart™ button is pressed in directly after the power switch is pressed in, the speed is reduced by 50%. In Smartstart™ mode the machine has less power until the button is pressed in again. These functions are of great use for creating a pilot hole for drilling.

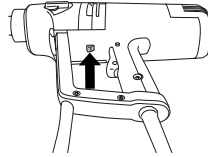

### Elgard™

Elgard™ is an electronic overload protection.

If the motor is overloaded, the overload protection pulses the motor. Reduce the load and the motor returns to its normal speed. The overload protection disconnects the power, if the machine is subjected to heavy loads or if the drill bit jams. The machine is reset by first releasing the power switch and then pressing it in again. If the drill bit jams, the mechanical slip clutch protects the gearbox before the overload protection disconnects the power.

### Speed control

Speed control always gives maximum output power from the machine. The speed control function provides the machine with a limited idling speed.

### Ergonomics

The soft rear section on the DM 230 has a large contact area so that the machine sits better against the body. The rounded handle makes the machine comfortable to hold while drilling. The protective loop forms a practical carry handle when transporting.

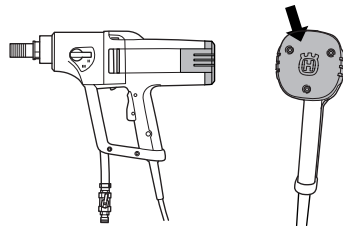

## WHAT IS WHAT?

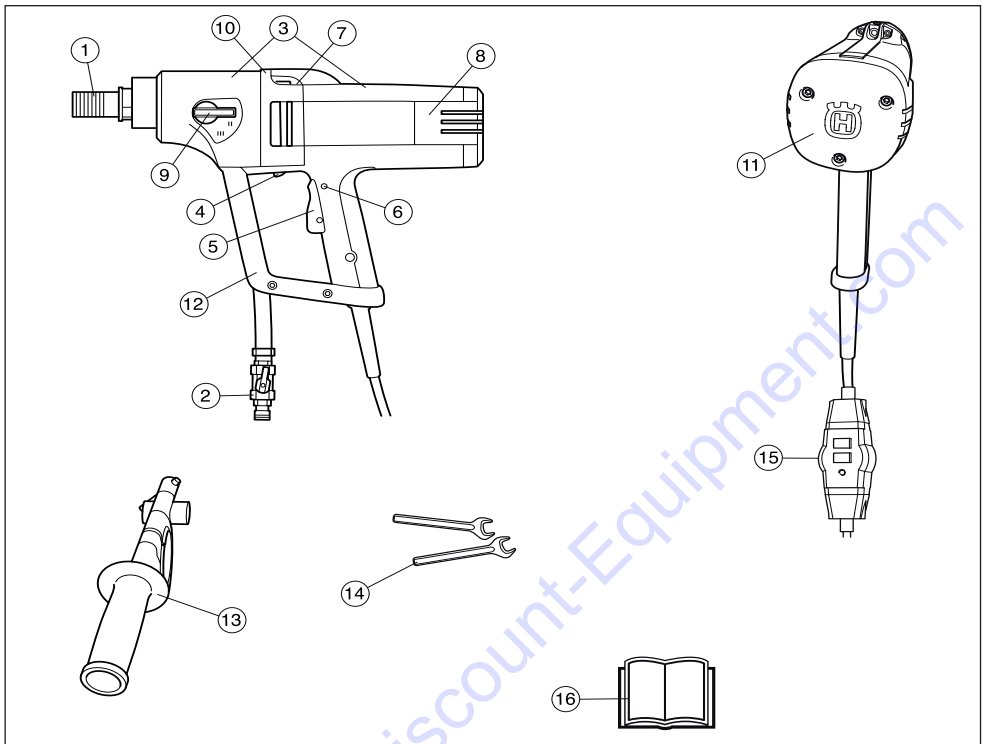

### What is what on the drilling machine?

- |                            |                                                                                                                      |
|----------------------------|----------------------------------------------------------------------------------------------------------------------|
| 1 Drill spindle            | 9 Gear knob                                                                                                          |
| 2 Water connector          | 10 Leakage hole (if water or oil trickles out from the leakage hole contact Discount-equipment to replace the seals) |
| 3 Gearbox and motor module | 11 Stiffener                                                                                                         |
| 4 Smart Start®             | 12 Protecting brace and carrying handle                                                                              |
| 5 Power switch             | 13 Handle and adapter                                                                                                |
| 6 Power switch lock        | 14 Spanners                                                                                                          |
| 7 Spirit level             | 15 Residual-current device                                                                                           |
| 8 Inspection cover         | 16 Operator's manual                                                                                                 |

# SAFETY INSTRUCTIONS

## Steps before using a new drilling machine

- Do not use the drilling machine without first reading and understanding the contents of this Operator's Manual.
- This machine is designed for and intended for drilling concrete, brick and different stone materials. All other use is improper.
- The machine is intended for use in industrial applications by experienced operators.

## Always use common sense

It is not possible to cover every conceivable situation you can face when using a drilling machine. Always exercise care and use your common sense. Avoid all situations which you consider to be beyond your capability. If you still feel uncertain about operating procedures after reading these instructions, you should consult an expert before continuing. Do not hesitate to contact Discount-equipment if you have any more questions about the use of the drilling machine. We will willingly be of service and provide you with advice as well as help you to use your drilling machine both efficiently and safely.

Do not hesitate to contact Discount-equipment if you have any more questions about the use of the machine. We will willingly be of service and provide you with advice as well as help you to use your machine both efficiently and safely.

Let Discount-equipment check the drilling machine regularly and make essential adjustments and repairs.

Husqvarna Construction Products has a policy of continuous product development. Husqvarna reserves the right to modify the design and appearance of products without prior notice and without further obligation introduce design modifications.

All information and all data in the Operator's Manual were applicable at the time the Operator's Manual was sent to print.

## Personal protective equipment



**WARNING!** You must use approved personal protective equipment whenever you use the machine. Personal protective equipment cannot eliminate the risk of injury but it will reduce the degree of injury if an accident does happen. Ask your dealer for help in choosing the right equipment.



**WARNING!** Long-term exposure to noise can result in permanent hearing impairment. Always use approved hearing protection. Listen out for warning signals or shouts when you are wearing hearing protection. Always remove your hearing protection as soon as the engine stops.

- Protective helmet
- Hearing protection
- Protective goggles or a visor
- Breathing mask
- Heavy-duty, firm grip gloves.
- Tight-fitting, heavy-duty and comfortable clothing that permits full freedom of movement.
- Boots with steel toe-caps and non-slip sole.
- Always have a first aid kit nearby.



**WARNING!** Under no circumstances should you modify the original design of the machine without approval from the manufacturer. Always use original spare parts. Unauthorized modifications and/or accessories may lead to serious injury or death to the user or others.



**WARNING!** The use of products such as cutters, grinders, drills, that sand or form material can generate dust and vapours which may contain hazardous chemicals. Check the nature of the material you intend to process and use an appropriate breathing mask.

# SAFETY INSTRUCTIONS

## General safety precautions



**WARNING! Read all safety warnings and all instructions. Failure to follow the warnings and instructions may result in electric shock, fire and/or serious injury.**

Save all warnings and instructions for future reference.

The term "power tool" in the warnings refers to your mains-operated (corded) power tool or battery-operated (cordless) power tool.

### Work area safety

- **Keep work area clean and well lit.** Cluttered or dark areas invite accidents.
- **Do not operate power tools in explosive atmospheres, such as in the presence of flammable liquids, gases or dust.** Power tools create sparks which may ignite the dust or fumes.
- **Keep children and bystanders away while operating a power tool.** Distractions can cause you to lose control.
- Do not use the machine in bad weather, such as dense fog, rain, strong wind, intense cold, etc. Working in bad weather is tiring and can lead to dangerous conditions, e.g. slippery surfaces.
- Ensure when cutting that no material can become loose and fall, causing operating injury. Take great care when working on sloping ground.
- Always check the rear side of the surface where the drill bit will emerge when drilling right through. Secure and cordon off the area and make sure that no one can be injured or material damaged.

### Electrical safety

- **Power tool plugs must match the outlet. Never modify the plug in any way. Do not use any adapter plugs with earthed (grounded) power tools.** Unmodified plugs and matching outlets will reduce the risk of electric shock.
- **Avoid body contact with earthed or grounded surfaces, such as pipes, radiators, ranges and refrigerators.** There is an increased risk of electric shock if your body is earthed or grounded.
- **Do not expose power tools to rain or wet conditions.** Water entering a power tool will increase the risk of electric shock.
- **Do not abuse the cord. Never use the cord for carrying, pulling or unplugging the power tool. Keep cord away from heat, oil, sharp edges or moving parts.** Damaged or entangled cords increase the risk of electric shock.
- **When operating a power tool outdoors, use an extension cord suitable for outdoor use.** Use of a cord suitable for outdoor use reduces the risk of electric shock.

- Check that the cord and extension cord are intact and in good condition. Never use the machine if the cord is damaged, hand it in to an authorized service workshop for repair.
- **If operating a power tool in a damp location is unavoidable, use a residual current device (RCD) protected supply.** Use of an RCD reduces the risk of electric shock.
- To avoid overheating do not use the extension cord while it is rolled up.
- The machine should be connected to an earthed outlet socket. Check that the mains voltage corresponds with that stated on the rating plate on the machine.
- Ensure the cord is behind you when you start to use the machine so that the cord will not be damaged.



**WARNING! Do not wash the machine with water, as water can enter the electrical system or the engine and cause damage to the machine or short circuit.**

### Personal safety

- **Stay alert, watch what you are doing and use common sense when operating a power tool. Do not use a power tool while you are tired or under the influence of drugs, alcohol or medication.** A moment of inattention while operating power tools may result in serious personal injury.
- **Use personal protective equipment. Always wear eye protection.** Protective equipment such as dust mask, non-skid safety shoes, hard hat, or hearing protection used for appropriate conditions will reduce personal injuries.
- **Prevent unintentional starting. Ensure the switch is in the OFF-position before connecting to power source and/or battery pack, picking up or carrying the tool.** Carrying power tools with your finger on the switch or energising power tools that have the switch on invites accidents.
- **Remove any adjusting key or wrench before turning the power tool on.** A wrench or a key left attached to a rotating part of the power tool may result in personal injury.
- **Do not overreach. Keep proper footing and balance at all times.** This enables better control of the power tool in unexpected situations.
- **Dress properly. Do not wear loose clothing or jewellery. Keep your hair, clothing and gloves away from moving parts.** Loose clothes, jewellery or long hair can be caught in moving parts.
- **If devices are provided for the connection of dust extraction and collection facilities, ensure these are connected and properly used.** Use of dust collection can reduce dust-related hazards.



# SAFETY INSTRUCTIONS

- Make sure that no pipes or electrical cables are routed in the area to be drilled.
- Ensure the cord is behind you when you start to use the machine so that the cord will not be damaged.
- Never leave the machine unsupervised with the motor running. A rotating drill bit can entail a risk of serious injury.
- Remain at a distance from the drill bit when the motor is running.
- Always unplug the machine during longer work breaks.
- Never work alone, always ensure there is another person close at hand. Apart from being able to receive help to assemble the machine, you can also get help if an accident should occur.



**WARNING!** Use auxiliary handles supplied with the tool. Loss of control can cause personal injury.



**WARNING!** Overexposure to vibration can lead to circulatory damage or nerve damage in people who have impaired circulation. Contact your doctor if you experience symptoms of overexposure to vibration. These symptoms include numbness, loss of feeling, tingling, pricking, pain, loss of strength, changes in skin colour or condition. These symptoms normally appear in the fingers, hands or wrists.



**CAUTION!** Wear ear protectors with impact drills. Exposure to noise can cause hearing loss.

## Power tool use and care

- **Do not force the power tool. Use the correct power tool for your application.** The correct power tool will do the job better and safer at the rate for which it was designed.
- **Do not use the power tool if the switch does not turn it on and off.** Any power tool that cannot be controlled with the switch is dangerous and must be repaired.
- **Disconnect the plug from the power source and/ or the battery pack from the power tool before making any adjustments, changing accessories, or storing power tools.** Such preventive safety measures reduce the risk of starting the power tool accidentally.
- **Store idle power tools out of the reach of children and do not allow persons unfamiliar with the power tool or these instructions to operate the power tool.** Power tools are dangerous in the hands of untrained users.

- **Maintain power tools. Check for misalignment or binding of moving parts, breakage of parts and any other condition that may affect the power tool's operation. If damaged, have the power tool repaired before use.** Many accidents are caused by poorly maintained power tools.
- **Keep cutting tools sharp and clean.** Properly maintained cutting tools with sharp cutting edges are less likely to bind and are easier to control.
- **Use the power tool, accessories and tool bits etc. in accordance with these instructions, taking into account the working conditions and the work to be performed.** Use of the power tool for operations different from those intended could result in a hazardous situation.
- Never use a machine that has been modified in any way from its original specification.
- Do not store or transport the drilling machine with the drill bit fitted in order to protect your drilling machine and drill bits from damage.
- Do not overload the machine. Overloading can damage the machine.
- Keep all parts in good working order and ensure that all fixtures are properly tightened.

## Service

- **Have your power tool serviced by a qualified repair person using only identical replacement parts.** This will ensure that the safety of the power tool is maintained.

## General working instructions



**WARNING!** This section takes up the basic safety precautions for working with the drilling machine. This information is never a substitute for professional skills and experience. If you encounter a situation where you are uncertain how to proceed you should ask an expert. Contact Discount-equipment. Do not attempt any task that you feel unsure of!

- The machine has a very high torque. This demands good concentration during work, as serious personal injuries can occur if the drill bit suddenly jams.
- Keep your hands at a safe distance from the drill spindle and drill bit when the machine is running.
- Keep an eye open for oil or water leakage. If water or oil trickles out from the leakage hole on the top of the pinion neck, the seals must be replaced.

# SAFETY INSTRUCTIONS

## Handheld drilling



**WARNING! Do not perform handheld drilling in first gear as the machine has a powerful torque that can result in personal injuries should the drill bit jam.**

- Always use a drill bit with a max. diameter of 75 mm with handheld drilling. The larger the drill bit the greater the reaction if the drill jams.
- Hold the power tool by insulated gripping surfaces, when performing an operation where the cutting accessory may contact hidden wiring or its own cord. Cutting accessory contacting a "live" wire may make exposed metal parts of the power tool live and could give the operator an electric shock.
- Always make sure you are standing firmly when carrying out handheld drilling.

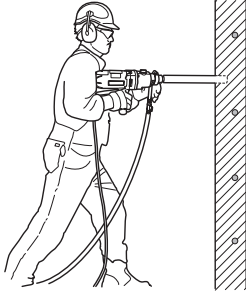

## Stand drilling

- Always use a drilling stand if drilling is to be performed from a ladder or scaffold.

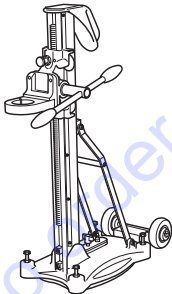

- Handheld drilling in these situations is full of risks, as the risk of falling is very high if the drill bit jams.



- Make sure that the stand is secured correctly.
- Make sure that the drilling machine is secured correctly in the stand.

## Drilling outdoors

- Always use extension cables that are approved for outdoor use.

## Drilling in ceilings and the like

- Use a water collector to avoid water penetrating into the machine. The machine must be covered with plastic or the like in order to prevent water penetrating into the machine, but do not cover the air intakes and air outlets.

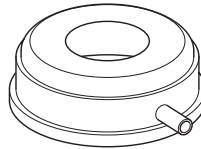

**IMPORTANT! The air intake must not be covered.**

# SAFETY INSTRUCTIONS

## Machine's safety equipment

This section describes the machine's safety equipment, its purpose, and how checks and maintenance should be carried out to ensure that it operates correctly. See the "What is what?" section to locate where this equipment is positioned on your machine.



**WARNING! Never use a machine that has faulty safety equipment! Safety equipment must be inspected and maintained. See instructions under the heading Checking, maintaining and servicing the machine's safety equipment. If your machine does not pass all the checks, take it to a service workshop for repair.**

## Power switch

The power switch should be used to start and stop the machine.

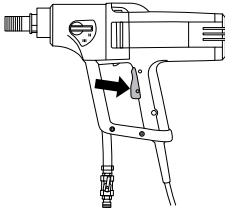

## Power switch lock

The power switch lock is designed to prevent accidental operation of the switch. When the lock (A) is pressed in the power switch (B) is released.

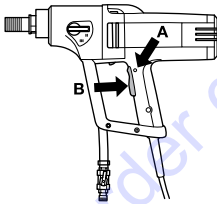

The power switch lock remains depressed as long as the power switch is depressed. When the grip on the handle is released both the power switch and power switch lock are reset. This movement is controlled by two independent return springs. This position results in the machine stopping and the power switch being locked.

## Residual-current device

Ground fault circuit interrupters are for protection in case an electrical fault should occur.

The LED indicates that the ground fault circuit interrupter is on and that the machine can be switched on. If the LED is not on, push the RESET button (green).



# SAFETY INSTRUCTIONS

## Checking, maintaining and servicing the machine's safety equipment

**IMPORTANT!** All servicing and repair work on the machine requires special training. This is especially true of the machine's safety equipment. If your machine fails any of the checks described below you must contact Discount-equipment. When you buy any of our products we guarantee the availability of professional repairs and service. If the retailer who sells your machine is not a servicing dealer, ask him for the address of your nearest service agent.

### Checking the power switch

Start the machine, release the power switch and check that the motor and the drill bit stop.

A defective power switch should be replaced by an authorized service workshop.

### Checking the power switch lock

Press the power switch and check that the power switch is locked when the power switch lock is pressed in.

Press in the power switch and make sure the switch returns to its original position when you release it.

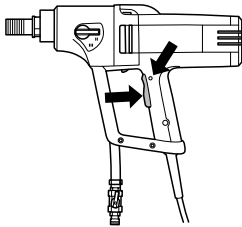

Check that the power switch and the power switch lock move easily.

### Check the residual-current device

Connect the machine to the socket. Push the RESET button (green) and the red LED lights up.



Push the TEST button (blue).



The ground fault circuit interrupter should trip and the machine switch off instantly. If not, contact Discount-equipment.

Reset with the RESET button (green).

# STARTING AND STOPPING

## Before starting



**WARNING! Note the following before starting:**

The machine should be connected to an earthed outlet socket.

Check that the mains voltage corresponds with that stated on the rating plate on the machine.

Ensure you stand firmly. Keep people and animals well away from the working area.

Make sure that:

- The switch is undamaged. If not, the switch must be replaced by an authorised repairman.
- The switch is not sticking.
- The machine and its equipment are correctly installed:
  - The drill is secured properly.
  - If a stand is used, it must be attached to the machine by the fastening neck on the gearbox.
- Wear personal protective equipment. See instructions under the "Personal protective equipment" heading.
- The water cooling or vacuum cleaner (with the help of adapter) are attached to the machine. Use suitable drill bits depending on whether water or dry drilling is being performed. In the event of uncertainty contact Discount-equipment.

## Starting

**IMPORTANT!** Changing gear may only be done when the machine is switched off. Otherwise there is a risk of damaging the gearbox.

- 1 Set the working speed by turning the drill spindle and at the same time move the gear knob to the required position.

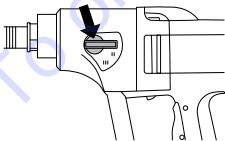

- 2 Turn on the water cooling (wet drilling) or switch on the vacuum cleaner (dry drilling).

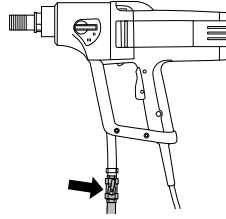

- 3 Hold the machine steadily.
- 4 Press in the switch fully. Also press, if desired, the Smartstart™ button.

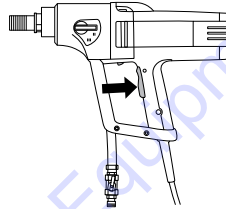

## Stopping



**WARNING! The drill bit continues to rotate for a while after the motor has been switched off. Do not stop the drill bit with your hands. Personal injuries can occur.**

Stop the motor by releasing the power switch.

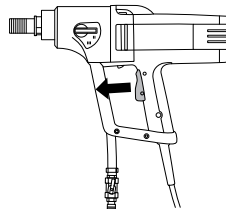

## Cooling

Run the machine unloaded for a minute or two to cool the motor.

# MAINTENANCE

## General



**WARNING! Inspection and/or maintenance should be carried out with the motor switched off and the plug disconnected.**

The lifetime of your machine can be extended considerably if it is used, cared for and maintained in the proper manner.

## Changing the drill bit

- 1 Pull out the plug.
- 2 Get:
  - The new drill bit.
  - The supplied open-ended spanners, size 24 mm and 32 mm.
  - Water-resistant grease.
- 3 Remove the old drill bit using the open-ended spanners.
- 4 Apply water-resistant grease to the thread of the new drill bit.
- 5 Attach the drill bit using the open-ended spanners.

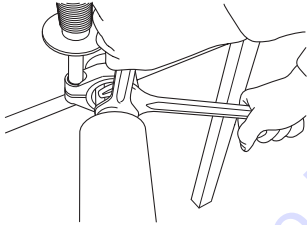

Before the machine is started, carefully check that the new bit is firmly attached.

## Cleaning

- Keep the machine and drill bit clean in order for drilling to be carried out safely.

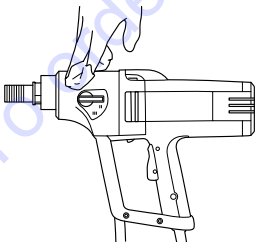

- Keep the handle dry and free of grease and oil.

- In order for the machine to always be cooled sufficiently the cooling air openings must be kept clear and clean. Blow down the machine regularly with compressed air.

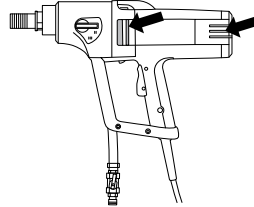

- Use compressed air to periodically clean the motor. Remove the inspection cover and clean the cover.

## Water tap

Check that the water tap functions. Do not use hoses that are distorted, worn or damaged.

## Electrical Feed



**WARNING! Never use damaged cables. They can cause serious, even fatal, personal injuries.**

Check that the cord and extension cord are intact and in good condition. Never use the machine if the cord is damaged, hand it in to an authorized service workshop for repair.

## Repairs

**Important** All types of repairs may only be carried out by authorised repairmen. This is so that the operators are not exposed to great risks.

# MAINTENANCE

## Changing the gearbox oil

Contact Discount-equipment to get the right oil.

The oil in the gearbox must be changed after every 400 hours of operation. Do as follows:

- 1 Get:
  - New oil, Mobile Lube1 SHC 75W90 or other similar transmission oil.
  - A container for the old oil.
- 2 Secure the machine with drill spindle downwards in a vice or the like.
- 3 Unscrew the six screws holding the motor - gearbox modules together.

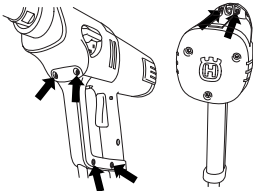

- 4 Carefully disassemble the machine.
- 5 Empty the gearbox oil into the container.
- 6 If necessary contact Discount-equipment to clean the gearbox.
- 7 Pour the new oil into the gearbox, about 0.25

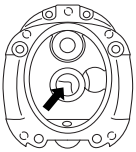

- 8 Fit a new O-ring between the motor cover and the gearbox cover. Contact Discount-equipment to receive the correct O-ring.

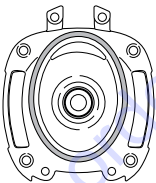

- 9 Reassemble the machine and screw in the six screws.

## Replacing the carbon brushes

The carbon brushes must be removed and checked regularly. Weekly if the machine is used daily or at longer intervals if the machine is used more seldom. The area of wear should be even and undamaged.

Both carbon brushes must always be replaced as a pair, but one at a time. Do as follows:

- 1 Remove the inspection cover's screws, 3.



- 2 Lift the carbon brush holder spring to one side.
- 3 Loosen the screw.
- 4 Pull out the carbon brush connector.
- 5 Pull the carbon brush out from the holder.

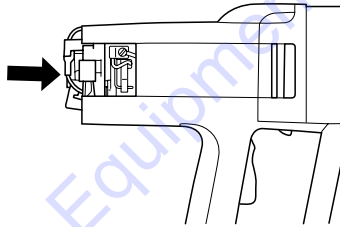

- 6 Clean the brush holder with compressed air or a brush. Replace the brush if worn.
- 7 Fit the new carbon brushes and, at the same time, check that they slide easily in the brush retainers.
- 8 Put the brush holder spring back into place.
- 9 Insert the carbon brush connection under the screw.
- 10 Repeat the procedure with the other carbon brush.
- 11 Refit the inspection cover screws, 3. Press together the rear section to make it easier to secure the screws. Make sure that the inspection cover enters its slots.

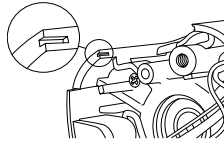

- 12 Let the machine idle for 10 minutes to run in the new carbon brushes.

## Daily maintenance

- 1 Check that nuts and screws are tight.
- 2 Check that the power switch unit works smoothly.
- 3 Check the ground fault circuit interrupter.
- 4 Clean the outside of the machine.
- 5 Check and clean the cooling air openings.
- 6 Check that the cord and extension cord are intact and in good condition.

# TECHNICAL DATA

## DM 230

Electric motor	1-phase
Rated voltage, V	220-240/100-120
Rated output, W	1850

### Rated current, A

220-240 V	8 A
100-120 V	15 A

Weight, kg	7
------------	---

### Diameter drill bit, mm

Max. diameter of the drill bit, with stand	150 mm (5,9")
Max. diameter for the drill bit, handheld	75 mm (3")

Spindle thread	G 1/2"		G 1 1/4"
Water connector	G 1/4"		
Water pressure - max, bar	8		

Stand, mm	Ø 60 mm
-----------	---------

### Noise emissions (see note 1)

Sound power level, measured dB(A)	107
Sound power level, guaranteed dB(A)	108

### Sound levels (see note 2)

Sound pressure level at the operators ear, dB(A)	93
--------------------------------------------------	----

### Vibration levels, $a_{hv}$ (see note 3)

Front handle, $m/s^2$	2,8
Rear handle, $m/s^2$	2,6

Note 1: Noise emissions in the environment measured as sound power ( $L_{WA}$ ) conforming to EN 12348.

Note 2: Noise pressure level according to EN 12348. Reported data for noise pressure level has a typical statistical dispersion (standard deviation) of 1.0 dB(A).

Note 3: Vibration level according to EN 12348. Reported data for vibration level has a typical statistical dispersion (standard deviation) of 1  $m/s^2$ .

			Handheld drilling	Stand drilling
Gear	Drill bit speed with load, rpm	Drill bit load without load, rpm	Recommended drill bit size, mm	Recommended drill bit size, mm
1	580	730	Not recommended	100-150
2	1400	1700	40-80	40-80
3	2900	3600	0-40	0-40



# WIRING DIAGRAM

DM 230

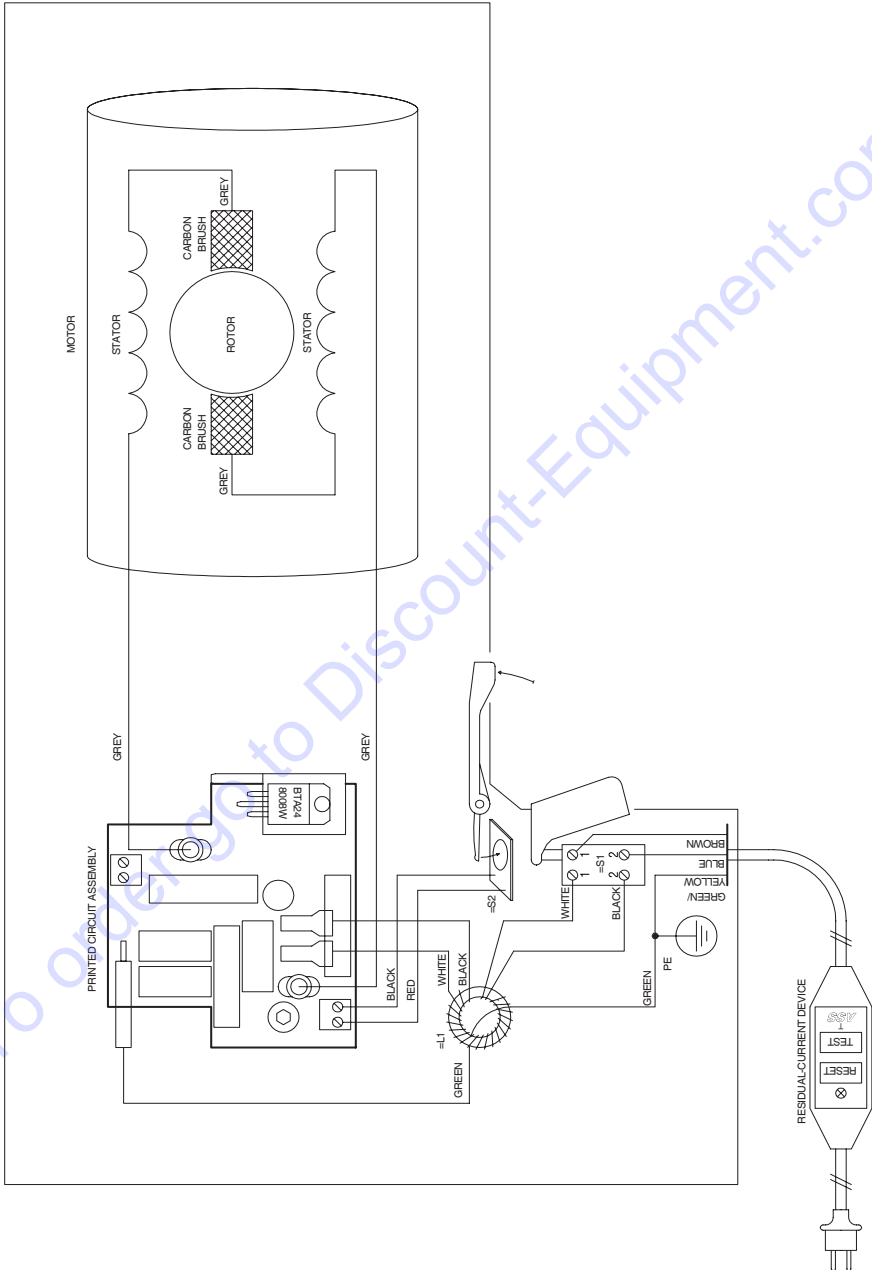

## 符号说明

### 本机上的符号：

警告！如果使用不当或粗心大意，机器可能就会成为危险的工具，对操作者或他人造成严重或致命伤害。



请认真阅读本操作手册，确保在充分理解各项说明之后再使用机器。



请务必配戴：

- 经认可的保护头盔
- 经检验合格的听觉保护设备
- 护目镜或防护面罩
- 通气口罩



本产品符合适用的欧盟指令的要求。



#### 环境标记。

本产品或其包装上的符号表示本产品不能作为生活垃圾处理。必须将其送交相应的回收站以回收利用电气和电子设备。



对本产品进行不当的废物管理可能会对环境和人身造成负面影响，请确保正确处理本产品，避免发生此类问题。



有关回收本产品的详细信息，请与当地相关管理部门、生活垃圾服务机构或销售本产品的商店联系。

确保在天花板上钻孔时水不会漏进机器。使用适当的集水器，并用塑料盖住机器，但不要盖住进气口和出气口。



有关机器上的其他符号/标识，请参考适用于特定市场的特殊认证要求。

## 目录

### 符号说明

本机上的符号: ..... 18

### 目录

目录 ..... 19

### 介绍

DM 230 ..... 20

### 构造图示说明

钻孔机零件组图示说明 ..... 21

### 安全须知

使用新钻机前应采取的步骤 ..... 22

个人防护装备 ..... 22

### 安全须知

一般安全须知 ..... 23

一般工作须知 ..... 24

机器安全设备 ..... 26

机器安全设备的检查、维修和保养 ..... 27

### 启动与停止

启动机器之前 ..... 28

启动 ..... 28

停止 ..... 28

### 维护

概述 ..... 29

更换钻头 ..... 29

清洁 ..... 29

水阀 ..... 29

电源 ..... 29

维修 ..... 29

更换齿轮箱油 ..... 30

更换碳刷 ..... 30

日常保养 ..... 30

### 技术参数

欧盟一致性声明 ..... 32

### 接线图

## 介绍

### DM 230

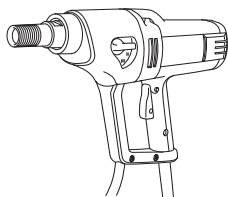

希望我们的产品让您称心如意并与您长期相伴。请将本操作手册视为重要文档。遵照其中的内容（使用、维修、维护等），机器的使用寿命及转让时的价值都将大大提高。出售本机时，请确保将操作手册转交买家。

购买我们的任意产品都将获得专业的保养维修帮助。如果出售本机的零售商不是我们的授权经销商，请向他咨询离您最近的维修车间的地址。

连续开发产品是 Husqvarna Construction Products 的政策。Husqvarna 保留修改产品设计和外观的权利，而无须事先通知，并且没有义务另行通知所修改的设计。

- DM 230 是一款手持式电钻，可用于对混凝土、砖砌物及各类石材进行钻孔。
- 钻机采用模块化设计且易于装配。
- 本机配备便于钻孔的水平仪，并配备带有集成式适配器（用于安装支撑杆）的旋转手柄，让您使用起来更加舒适。
- DM 230 具有三个速度档，最大可使用直径为 150 毫米的钻头。
- 本机具有一个水冷式齿轮箱和一条通过主轴的水管。
- 也可借助与心轴相连接的适配器，将 DM 230 与真空吸尘器相连，以进行干钻。
- 本钻机配有 Softstart™、Smartstart™、Elgard™ 和速度控制器。

### Softstart™

Softstart™ 是电子功率限制装置，使钻头更容易启动。按下电源开关后约三秒即可达到最高速度。

### Smartstart™

如果在按下电源开关后直接按 Smartstart™ 按钮，则速度会降低 50%。在 Smartstart™ 模式下，本机的功率较低，直到再次按下此按钮为止。这些功能非常适用于建立一个导孔进行钻孔。

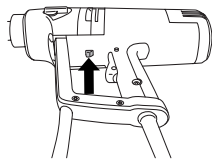

### Elgard™

Elgard™ 是一个电子过载保护装置。

如果电机过载，过载保护装置将对电机进行脉冲。减少负荷量，发动机将返回到正常速度。如果机器承受重载或钻头卡住，则过载保护装置会断开电源。可通过先松开电源开关然后再将其按下的方式重置钻机。如果钻头卡住，机械式滑动离合器将对齿轮箱进行保护，然后过载保护装置才会断开电源。

### 速度控制功能

速度控制功能始终能为机器提供最大输出功率。速度控制功能可为机器提供有限的怠速。

### 符合人体工学

DM 230 柔软的后部带有宽大的接触面，使机器能更好地抵住身体。圆形手柄使机器在钻孔时舒适易握。保护环可在搬运钻机时用作实用的提手。

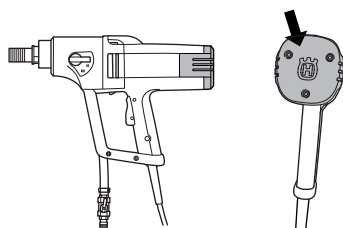

# 构造图示说明

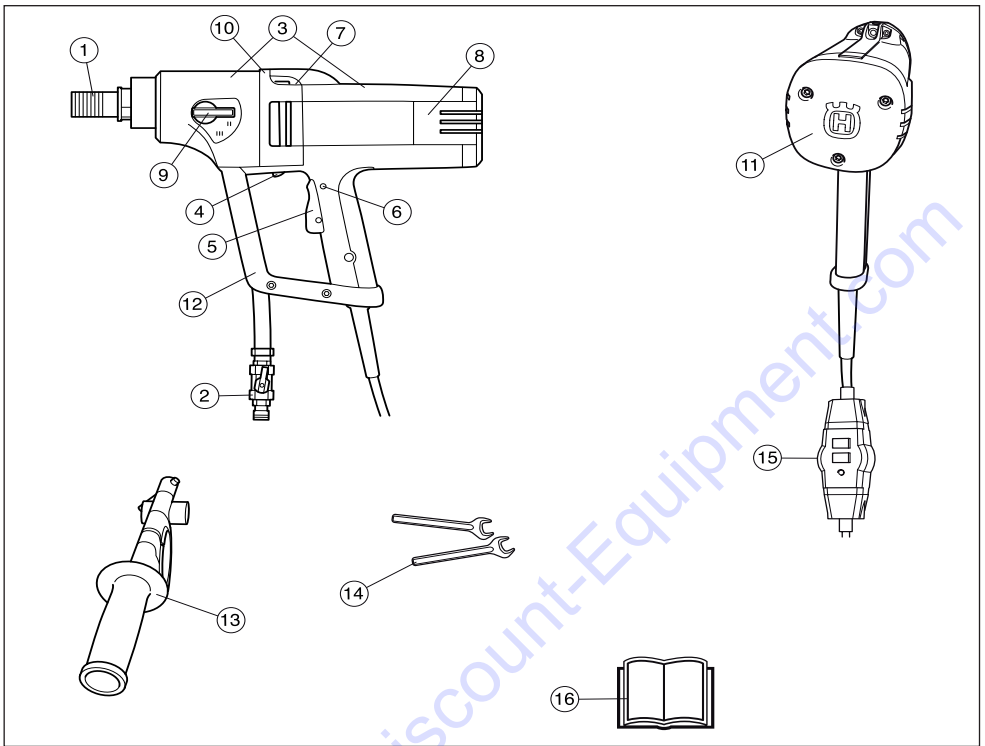

钻孔机零件组图示说明

- |                |                                  |
|----------------|----------------------------------|
| 1 钻轴           | 9 齿轮传动钮                          |
| 2 水接头          | 10 泄漏孔（如果水或油从泄漏孔中流出，请联系经销商更换密封件） |
| 3 齿轮箱和马达模组     | 11 加固件                           |
| 4 Smart Start® | 12 保护支架和携带提手                     |
| 5 动力开关         | 13 手柄和适配器                        |
| 6 电源开关锁        | 14 扳手                            |
| 7 水平仪          | 15 漏电保护器                         |
| 8 检查罩          | 16 操作手册                          |

# 安全须知

## 使用新钻机前应采取的步骤

- 在未阅读和理解本操作手册的内容之前，请勿使用本钻机。
- 本机仅可用于对混凝土、砖块和各类不同石材进行钻孔。切勿用于其他用途。
- 本机专为工业应用而设计，由经验丰富的操作人员使用。

## 记住运用常识

不可能对您在使用钻机时可能遇到的情况一一点到。务必多加小心，并运用常识来应对。在任何超出您能力范围的情况下，请不要使用。如果您在阅读本手册说明之后对于操作流程依然不确定，应在咨询专家之后再继续操作。如果您对于钻机的使用方法还有任何疑问，请随时与我们或您的经销商联系。我们将竭诚为您服务，并提供忠告与帮助，确保您高效安全地使用您的钻机。

如果您对于本机的使用还有任何疑问，请立即与您的经销商联系。我们将竭诚为您服务，并提供建议与帮助，确保您高效安全地使用机器。

请您的 Husqvarna 经销商定期检查钻机，并进行必要的调整及修理。

连续开发产品是 Husqvarna Construction Products 的政策。Husqvarna 保留修改产品设计和外观的权利，而无须事先通知，并且没有义务另行通知所修改的设计。

《操作手册》中的所有信息和数据在付印时皆适用。



**警告！**在任何情况下，未经制造商批准，都不得修改本机的原有设计。请始终使用原厂零件。未经许可擅自修改和/或使用未经认可的零件，可能导致严重伤害或死亡。



**警告！**使用切割机、砂轮、电钻等产品时，磨砂或成形材料产生的灰尘和蒸汽可能含有有害的化学物质。请检查加工材料的性质，然后使用合适的通气口罩。

## 个人防护装备



**警告！**使用本机时，一定要使用经过批准的个人防护装备。个人防护装备不能避免受伤，但当意外发生时，可降低伤害程度。选择防护装备时，请向经销商查询。



**警告！**长期接触噪音会导致永久性听力损伤。请务必使用检验合格的听觉保护设备。戴有听觉保护设备时，请留意警告信号或呼喊声。一旦引擎停机，便取下听觉保护设备。

- 保护头盔
- 听觉保护设备
- 护目镜或防护面罩
- 通气口罩
- 耐用可抓紧的保护手套。
- 可让您活动自如、贴身耐穿且舒适的衣物。
- 带有钢制脚趾防护的防滑靴子。
- 附近应备有急救箱。

# 安全须知

## 一般安全须知



**警告！**请阅读所有安全警告和所有说明。如不遵循警告和说明，可能会导致电击、火灾和/或严重伤害。

保存所有警告和说明供以后参考。

警告中的术语“电动工具”指的是电力驱动（有线）的动力工具或电池供电（无线）的动力工具。

### 工作区安全

- 保持工作区域干净明亮。混乱或黑暗的区域可能会导致事故。
- 请勿在诸如存在易燃液体、气体或粉尘等易爆炸的环境中操作电动工具。电动工具会生成火花，可能会点燃粉尘或气体。
- 操作电动工具时请远离儿童和旁观者。操作时分心将会无法控制工具。
- 避免在恶劣天气情况下使用本机。例如：浓雾、大雨、强风或是严寒等。在天气状况不佳的情况下工作容易令人感到疲倦，甚至可能造成危险状况，例如湿滑的地面。
- 开始切割时，确定没有东西松动或掉落，以致造成伤害。在倾斜地面上工作时，要特别小心。
- 当从头钻到尾时，请务必检查表面的后侧，钻头会从此处钻出。固定并隔离此区域，确保不会伤害到任何人或损坏基材。

### 电气安全

- 电动工具的插头必须与电源插座匹配。切勿以任何方式改造插头。请勿将任何转接插头与接地的电动工具一起使用。未经改造的插头和匹配的电源插座将减少电击风险。
- 避免将身体与接地表面接触，如管道、水箱、炉具和冰箱。如果身体接地，则会增加遭受电击的风险。
- 请勿将电动工具暴露在雨水或潮湿环境下。电动工具中进水将会增加电击风险。
- 请勿滥用电线。切勿使用电线来携带、拖拉或断开电动工具。请将电线远离热、油脂、尖锐边缘或移动的部件。损坏或缠绕的电线会增加电击风险。
- 在室外操作电动工具时，请使用室外专用的延长线。使用室外专用的电线会降低电击风险。
- 检查电线和延长线是否完好并处于良好状态。如果电线受损，切勿使用本机，请将其送到授权的保养厂修理。
- 如果无法避免在潮湿的地点操作电动工具，请使用电流式漏电断路器(RCD)保护电源。使用RCD会降低电击风险。
- 为避免过热，使用延长线时请勿令其盘绕。
- 本机应连接至带地线的插座。检查电源电压是否与机器标牌上的电压一致。
- 开始使用本机时，确保电线位于身后，以防其受损。



**警告！**请勿用水清洗本机，水进入电气系统或引擎将会导致机器损坏或短路。

### 人身安全

- 操作电动工具时，保持警觉并密切注意正在执行的操作并根据常识做出合理判断。请勿在疲倦或服用药剂、酒精或药物后使用电动工具。操作电动工具时的一时疏忽可能会导致严重的人身伤害。
- 使用个人防护装备。始终佩戴眼部保护设备。适用于相应条件的诸如防尘面罩、防滑安全鞋、安全帽或听觉保护设备等保护装备可减少人身伤害。
- 防止意外启动。在连接至电源和/或电池组、提起或携带工具之前，确保开关处于关闭位置。携带电动工具时将手指放在开关上或为已打开开关的电动工具加电会引发事故。
- 打开电动工具开关前，请取下任何调整扳手。保持扳手与电动工具的旋转部件相连接可能会导致人身伤害。
- 请勿距离过远。请始终维持适当的位置和平衡。这样在出现意外时可以更好地控制电动工具。
- 穿戴合适的服装。请勿穿宽松的服装或佩戴珠宝。保持头发、衣服和手套远离移动部件。宽松的服装、珠宝或长头发可能会绞入移动部件中。
- 如果提供了用于连接吸尘和集尘装置的设备，请确保正确连接和使用这些设备。使用吸尘装置可减少因灰尘引起的相关危险。

# 安全须知

- 检查钻孔区是否有埋藏电缆或电线。
- 开始使用本机时，确保电线位于身后，以防其受损。
- 禁止在运行马达时无人看管机器。钻头旋转时可能会造成严重的人身伤害。
- 电机在运转时，操作者须与钻头保持一定距离。
- 如果长时间停止工作，务必拔出本机插头。
- 切勿单独工作，务必确保有另一个人在身旁。另一人除了能够帮助您装配机器外，一旦发生任何事故，他还能向您提供帮助。



**警告！使用工具随附的辅助手柄。失控会导致人身伤害。**



**警告！血液循环不佳的人受到过度振动时，可能会导致循环系统或神经伤害。如果您因过度振动而引起以下症状，请自行就医。这些症状包括：麻木、失去知觉、麻刺、刺痛、疼痛、虚弱、肤色或皮肤状况发生变化。这些症状通常出现在手指、双手或手腕上。**



**小心！进行冲击钻孔时需佩戴听觉保护设备。接触噪音可导致听力受损。**

## 电动工具的使用和养护

- 请勿强行操作电动工具。请针对具体用途使用正确的电动工具。使用正确的电动工具可更好更安全地按照设计用途完成工作。
- 请勿使用通过开关无法打开和关闭的电动工具。无法使用开关进行控制的任何电动工具都是危险的，必须进行维修。
- 在对电动工具进行任何调整、附件更改或存放前，请将电动工具的插头从电源和/或电池组上断开。此类预防性安全措施可降低不小心启动电动工具的风险。
- 请将闲置的电动工具存放在远离儿童的位置，不得允许不熟悉电动工具或这些说明的人操作电动工具。未经培训的用户使用电动工具将非常危险。
- 维护电动工具。检查是否存在未对齐或移动部件纠缠、零件破损以及任何其他可能会影响电动工具操作的情况。如果工具已损坏，请在使用前维修电动工具。许多事故都是因电动工具未得到良好维修造成的。
- 保持切割工具锋利洁净。使用具有锋利切割边缘且经过适当维修的切割工具，较少出现纠结的情况且更易于控制。
- 请按照这些说明使用电动工具、附件和刀头等，同时考虑工作环境以及要执行的作业。如果电动工具用于非设计用途会导致危险。
- 绝不能使用曾对原规格进行任何改动的机器。
- 存放或搬运钻机时，请将钻头卸下，以防钻机和钻头受损。
- 切勿使机器过载。这样做会损坏机器。
- 保持所有部件处于正常状态，并确保正确上紧所有夹具。

## 保养

- 保养电动工具时，请联系具备相应资质的维修人员并仅使用相同的更换零件。这将确保电动工具的安全。

## 一般工作须知



**警告！本节专门介绍使用钻机的基本安全事项。这些资料不能取代专业技能和经验。当您遇到任何情况，不知如何继续时，请咨询专家。联络您的经销商、保养厂或有经验的钻机使用者。不要尝试任何没有把握的任务！**

- 本机具有极高的扭矩。工作期间必须高度集中注意力，因为一旦钻头突然间卡住，则可能会造成严重的人身伤害。
- 当机器运转时，您的双手须与钻轴和钻头保持安全距离。
- 密切观察油或水是否泄漏。如果水或油从小齿轮颈部上方的漏孔流出，则必须更换密封件。



# 安全须知

## 手持式钻孔



**警告！请勿用第一档执行手持钻孔，因为钻机具有强劲扭矩，钻头卡住时会导致人身伤害。**

- 手持钻孔时，所用钻头的直径不得超过 75 mm。钻头卡住时，钻头越大，反作用力就越大。
- 执行作业时，只能通过绝缘抓握面握持电动工具，因为切割附件可能会触及隐藏的电线或工具自身的电源线。切割附件接触“带电”电线可能会使电动工具的裸露金属部分带电，导致操作人员遭受电击。
- 执行手持钻孔时，请务必确保站稳。

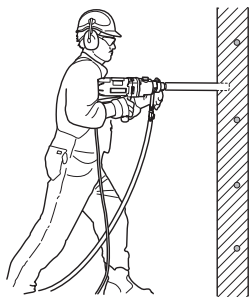

## 钻台式钻孔

- 在梯子或脚手架上进行钻孔作业时，请务必使用钻架。

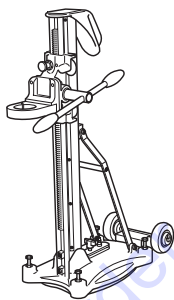

- 在这些情况下进行手持钻孔充满风险，如果钻头卡住，则发生跌落的风险极高。



- 确保正确固定好钻台。
- 确保钻孔机正确固定在钻台上。

## 户外钻孔

- 务必使用已获批户外使用的延伸电线。

## 在天花板及类似位置钻孔

- 使用集水器以避免机器进水。必须在机器上覆盖一层塑料或类似物，以防止机器进水，但切勿盖住进气口和出气口。

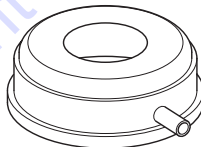

**重要事项！不得覆盖进气口。**

# 安全须知

## 机器安全设备

本节介绍机器的安全装备及其用途，并说明如何进行检查和维修，以确保机器正常运转。请参阅《构造图示说明》部分，可找到此种安全设备的正确位置。



**警告！切勿使用安全装备存在故障的机器！必须检验与维护安全装备。请参阅《如何检查、维修和保养机器的安全装备》篇的说明。如果您的机器未通过各项检查，请将其送至维修车间进行维修。**

## 动力开关

应使用电源开关启动和停止机器。

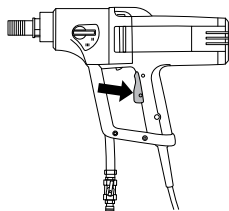

## 电源开关锁

电源开关锁设计用于防止开关意外操作。按下电源开关锁 (A) 后，会释放电源开关 (B)。

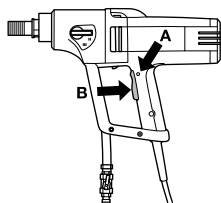

只要按下电源开关，电源开关锁便会保持按下状态。松开把手后，电源开关和电源开关锁都会复位。这一动作由两个独立的回位弹簧控制。该位置会使机器停止且电源开关被锁定。

## 漏电保护器

漏电保护器用于防止漏电。

指示灯表示漏电保护器已打开且可开机。如果 LED 变亮，按下“复位”按钮（绿色）。



# 安全须知

## 机器安全设备的检查、维修和保养

**重要事项！**本机的保养和维修必须经过专门培训。对于本机的安全设备来说尤其如此。如果在检修过程中出现下述的故障，应与保养厂联络。如果您购买我们的产品，我们承诺提供专业的修理和保养。如果出售本机的零售商不是保养商，应向他咨询离您最近的保养厂的地址。

### 检查动力开关

启动机器，松开电源开关，检查电机和钻头是否停止。应当由经过授权的保养厂替换有缺陷的电源开关。

### 检查电源开关锁

按下电源开关，检查按下电源开关锁时电源开关是否锁定。

按下电源开关，确保松开手后开关返回原位。

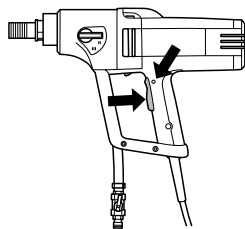

检查电源开关和电源开关锁能否顺畅移动。

### 检查漏电保护器

将机器连接至电源插座。按下 RESET 按钮（绿色），红色指示灯将亮起。



按下“TEST”（测试）按钮（蓝色）。



漏电保护器应被触发，机器立即关闭。如果情况与此不同，请与您的经销商联系。

使用 RESET 按钮（绿色）进行重置。

# 启动与停止

## 启动机器之前



**警告！启动前应注意以下事项：**

本机应连接至带地线的插座。

检查电源电压是否与机器牌上的电压一致。

确定您站稳。让人和动物远离工作区。

确保：

- 开关完好受损。否则，必须由经授权的维修人员更换开关。
- 开关未卡住。
- 本机及其设备已正确安装：
  - 钻机已正确固定。
  - 如果使用钻架，则必须通过齿轮箱上的固定颈将其与机器相连。
- 请使用个人防护装备。请参阅“个人防护装备”一节的说明。
- 水冷却装置或真空吸尘器（借助适配器）已与机器相连。根据所执行是水钻还是干钻来使用适当的钻头。如有任何疑问，请联系经销商、保养厂或经验丰富的操作员。

## 启动

**重要事项！只有在关闭机器后才能更换齿轮。否则可能会损坏齿轮箱。**

- 1 选择钻轴的同时将齿轮传动钮移到所需的位置上，即可设置工作速度。

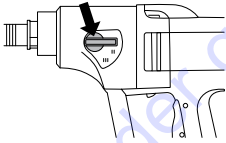

- 2 打开水冷却开关（湿式钻孔）或开启吸尘器（干式钻孔）。

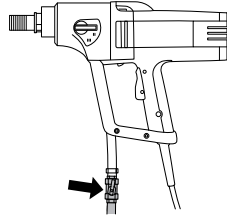

- 3 稳固握持机器。
- 4 将开关按到底。如果需要，还要按下 Smartstart™ 按钮。

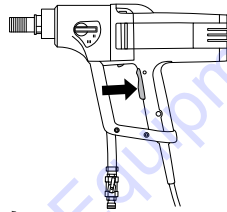

## 停止



**警告！关闭电机后，钻头会继续旋转一会儿。不要用手使钻头停止。否则可能会造成人身伤害。**

松开电源开关，让电机停下来。

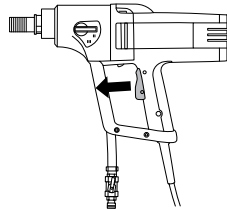

## 冷却

让机器空转一两分钟，以冷却电机。

# 维护

## 概述



**警告！**进行检查和/或维护时，应当关掉马达并且把插头从电源拔出。

如果正确保养和维护，能够大大延长机器的使用寿命。

## 更换钻头

- 1 拔出插头。
- 2 获取：
  - 新的钻头。
  - 随附的开口扳手，尺寸为 24 毫米和 32 毫米。
  - 防水的润滑脂。
- 3 使用开口扳手来拆除旧钻头。
- 4 将防水润滑脂涂抹到新钻头的螺纹上。
- 5 使用开口扳手来连接钻头。

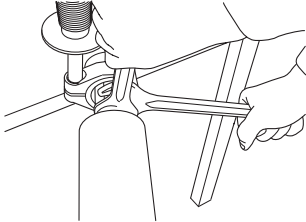

启动机器之前，请仔细检查新钻头是否牢牢固定。

## 清洁

- 保持机器和钻头清洁，这样才能确保安全钻孔。

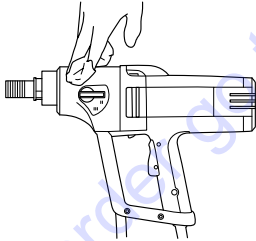

- 保持把手干燥、清洁，不沾润滑脂或油污。

- 为了使机器有效冷却，冷却空气口必须保持畅通、清洁。定期用压缩空气吹扫机器。

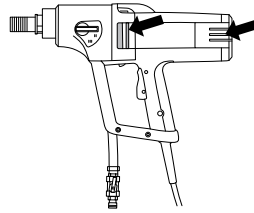

- 使用压缩空气定期清洁电机。拆除检查罩并清洁罩子。

## 水阀

检查水阀是否功能正常。请勿使用变形、磨损或损坏的软管。

## 电源



**警告！**切勿使用已损坏的电缆。这可能会导致严重甚至致命性人身伤害。

检查电线和延长线是否完好并处于良好状态。如果电线受损，切勿使用本机，请将其送到授权的保养厂修理。

## 维修

**切记，**只有经授权的维修人员才能进行各种类型的维修。以免操作员承受巨大风险。

## 更换齿轮箱油

联系您的经销商获取正确的油。

每工作 400 个小时后必须更换齿轮箱油。执行以下操作：

1 获取：

- 新油、Mobile Lube1 SHC 75W90 或其他类似的传动油。
- 收集旧油的容器。

2 使用钻轴或类似物向下固定住机器。

3 拧开将电机和齿轮箱模块固定在一起的六颗螺钉。

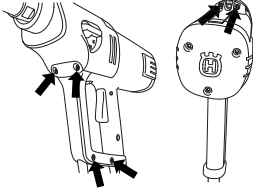

4 仔细拆卸机器。

5 将齿轮箱油倒空至容器内。

6 必要时，请联系您的经销商来清洗齿轮箱。

7 将大约 0.25 升新油倒入齿轮箱内。

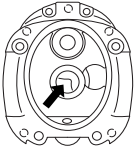

8 在电机盖和齿轮箱盖之间安装新 O 型圈。要获得正确的 O 型圈，请联系经销商。

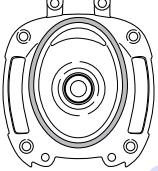

9 重新装配机器并拧入六颗螺钉。

## 更换碳刷

必须定期取下并检查碳刷。如果每天使用机器，则每周检查一次，或者如果机器使用较少，则间隔时间变长。磨面应当平滑且完好如初。

务必成对更换碳刷，但一次只能更换一个。执行以下操作：

1 卸下检查盖的螺钉（3 个）。



2 将碳刷架弹簧提至一侧。

3 拧松螺钉。

4 拉出碳刷接头。

5 从刷架中拉出碳刷。

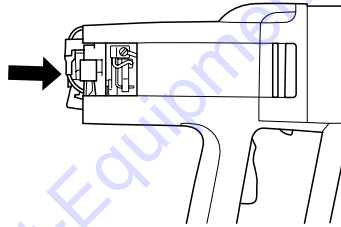

6 使用压缩空气或刷子清洁刷架。如果有磨损，请更换碳刷。

7 安装新碳刷，同时检查其是否能在固定架中顺畅滑动。

8 将刷架弹簧归位。

9 在螺钉下方插入碳刷接头。

10 使用其他的碳刷重复执行此程序。

11 重新安装检查盖的螺钉（3 个）。将后面部分压在一起，以便于固定螺钉。确保检查盖进入插槽中。

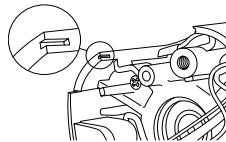

12 让机器闲置 10 分钟后才转动新的碳刷。

## 日常保养

1 检查螺母和螺丝是否上紧。

2 检查电源开关装置是否工作顺畅。

3 检查接地故障断路器。

4 清洁机器的外部。

5 检查并清洁冷却空气口。

6 检查电线和延长线是否完好并处于良好状态。

# 技术参数

## DM 230

电动马达	单相	
额定电压, V	220-240/100-120	
额定功率, W	1850	
<b>额定电流, A</b>		
220-240 V	8 A	
100-120 V	15 A	
重量 (kg)	7	
<b>钻头直径 (mm)</b>		
钻头最大直径 (使用钻架时)	150 mm (5.9")	
钻头最大直径 (手持钻孔时)	75 mm (3")	
心轴螺纹	G 1/2"	G 1 1/4"
水接头	G 1/4"	
水压 - 最大值 (bar)	8	

钻架 (mm) Ø 60 mm

### 噪音排放 (请参阅注释 1)

声能级, 测量值 dB(A)	107
声功率级, 保证值 dB(A)	108

### 音量 (请参阅注释 2)

操作员听到的声压级, dB(A) 93

### 振级, $a_{nv}$ (请参阅注释 3)

前手柄, $m/s^2$	2.8
后手柄, $m/s^2$	2.6

注释 1: 环境噪音释放以声能 ( $L_{WA}$ ) 量测, 符合 EN 12348 标准。

注释 2: 噪音声压级按照 EN 12348 进行测量。噪音声压级的上报数据中具有一个 1.0 dB(A) 的典型统计离差 (标准偏差)。

注释 3: 振级符合 EN 12348 标准。等效振级的报告数据中具有一个  $1 m/s^2$  的典型统计离差 (标准偏差)。

			手持式钻孔	钻台式钻孔
齿轮	钻头的负载速度, rpm	钻头空载速度, rpm	推荐的钻头尺寸, mm	推荐的钻头尺寸, mm
1	580	730	不推荐	100-150
2	1400	1700	40-80	40-80
3	2900	3600	0-40	0-40

# 接线图

DM 230

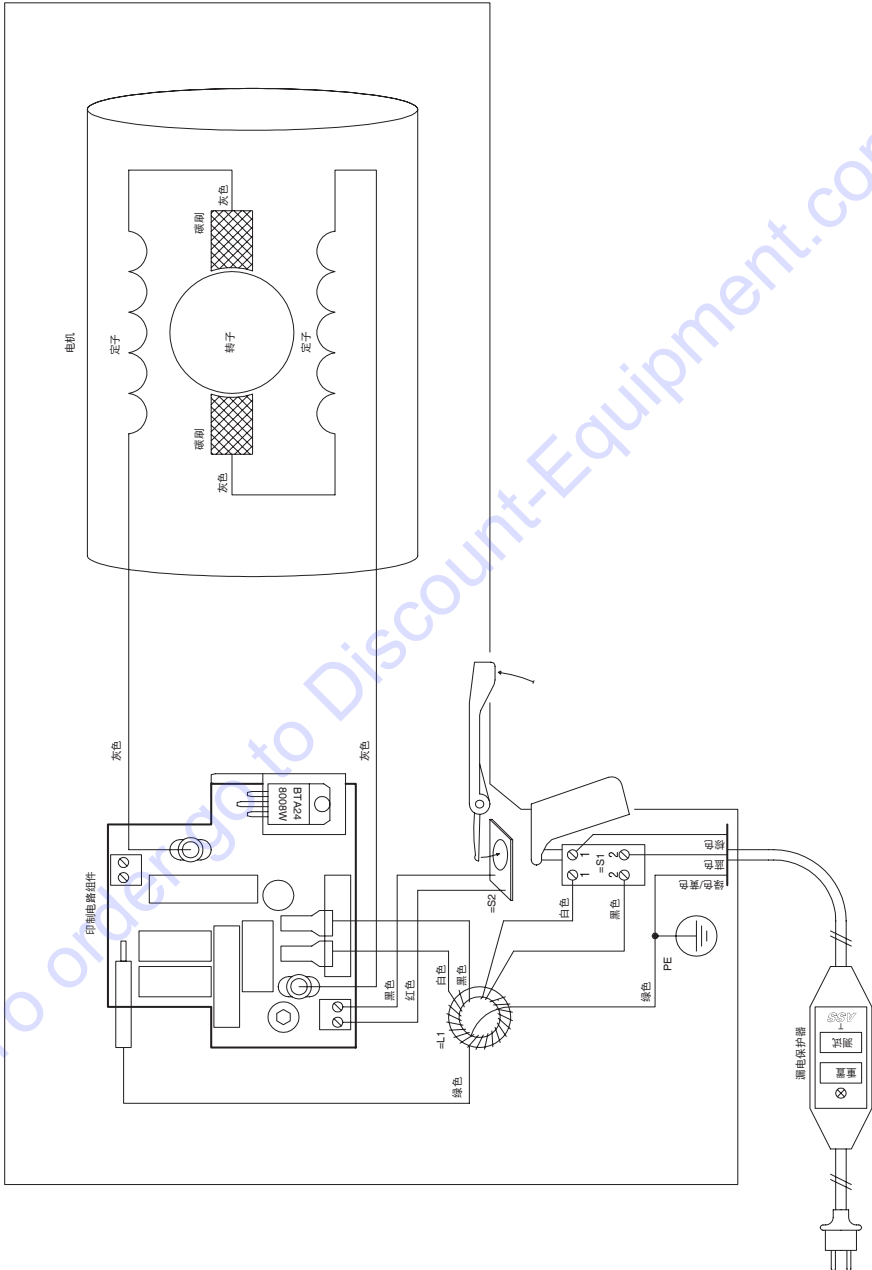



To order go to [Discount-Equipment.com](http://Discount-Equipment.com)

EN - Original instructions, CN - 原始说明

1154251-38



2017-03-28 rev.2

**TO PURCHASE THIS PRODUCT PLEASE CONTACT US**



**Equipment Financing and  
Extended Warranties Available**



**Discount-Equipment.com is your online resource for  
commercial and industrial quality parts and equipment sales.**

**561-964-4949**

**visit us on line @ [www.discount-equipment.com](http://www.discount-equipment.com)**

Select an option below to find your Equipment

**Search by Manufacturer**

**Search by Product Type**

**Request a Quote**

We sell worldwide for the brands: Genie, Terex, JLG, MultiQuip, Mikasa, Essick, Whiteman, Mayco, Toro Stone, Diamond Products, Generac Magnum, Airman, Haulotte, Barreto, Power Blanket, Nifty Lift, Atlas Copco, Chicago Pneumatic, Allmand, Miller Curber, Skyjack, Lull, Skytrak, Tsurumi, Husquvarna Target, Stow, Wacker, Sakai, Mi-T-M, Sullair, Basic, Dynapac, MBW, Weber, Bartell, Bennar Newman, Haulotte, Ditch Runner, Menegotti, Morrison, Contec, Buddy, Crown, Edco, Wyco, Bomag, Laymor, EZ Trench, Bil-Jax, F.S. Curtis, Gehl Pavers, Heli, Honda, ICS/PowerGrit, IHI, Partner, Imer, Clipper, MMD, Koshin, Rice, CH&E, General Equipment, Amida, Coleman, NAC, Gradall, Square Shooter, Kent, Stanley, Tamco, Toku, Hatz, Kohler, Robin, Wisconsin, Northrock, Oztec, Toker TK, Rol-Air, APT, Wylie, Ingersoll Rand / Doosan, Innovatech, Con X, Ammann, Mecalac, Makinex, Smith Surface Prep, Small Line, Wanco, Yanmar