

**GB**

## **Operator's manual**

Please read the operator's manual carefully and make sure you understand the instructions before using the machine.

**ES**

## **Manual de instrucciones**

Lea detenidamente el manual de instrucciones y asegúrese de entender su contenido antes de utilizar la máquina.

**DE**

## **Bedienungsanweisung**

Lesen Sie die Bedienungsanweisung sorgfältig durch und machen Sie sich mit dem Inhalt vertraut, bevor Sie das Gerät benutzen.

**FR**

## **Manuel d'utilisation**

Lire attentivement et bien assimiler le manuel d'utilisation avant d'utiliser la machine.

# DM230



**GB ES DE FR**

**TO PURCHASE THIS PRODUCT PLEASE CONTACT US**



**Equipment Financing and  
Extended Warranties Available**



**Discount-Equipment.com is your online resource for  
commercial and industrial quality parts and equipment sales.**

**561-964-4949**

**visit us on line @ [www.discount-equipment.com](http://www.discount-equipment.com)**

Select an option below to find your Equipment

**Search by Manufacturer**

**Search by Product Type**

**Request a Quote**

We sell worldwide for the brands: Genie, Terex, JLG, MultiQuip, Mikasa, Essick, Whiteman, Mayco, Toro Stone, Diamond Products, Generac Magnum, Airman, Haulotte, Barreto, Power Blanket, Nifty Lift, Atlas Copco, Chicago Pneumatic, Allmand, Miller Curber, Skyjack, Lull, Skytrak, Tsurumi, Husquvarna Target, Stow, Wacker, Sakai, Mi-T-M, Sullair, Basic, Dynapac, MBW, Weber, Bartell, Bennar Newman, Haulotte, Ditch Runner, Menegotti, Morrison, Contec, Buddy, Crown, Edco, Wyco, Bomag, Laymor, EZ Trench, Bil-Jax, F.S. Curtis, Gehl Pavers, Heli, Honda, ICS/PowerGrit, IHI, Partner, Imer, Clipper, MMD, Koshin, Rice, CH&E, General Equipment, Amida, Coleman, NAC, Gradall, Square Shooter, Kent, Stanley, Tamco, Toku, Hatz, Kohler, Robin, Wisconsin, Northrock, Oztec, Toker TK, Rol-Air, APT, Wylie, Ingersoll Rand / Doosan, Innovatech, Con X, Ammann, Mecalac, Makinex, Smith Surface Prep, Small Line, Wanco, Yanmar

# KEY TO SYMBOLS

## Symbols on the machine:

**WARNING!** The machine can be a dangerous tool if used incorrectly or carelessly, which can cause serious or fatal injury to the operator or others.



Please read the operator's manual carefully and make sure you understand the instructions before using the machine.



Always wear:

- Approved protective helmet
- Approved hearing protection
- Protective goggles or a visor
- Breathing mask



This product is in accordance with applicable EC directives.



**Environmental marking.** Symbols on the product or its packaging indicate that this product cannot be handled as domestic waste. It must instead be submitted to an appropriate recycling station for the recovery of electrical and electronic equipment.



By ensuring that this product is taken care of correctly, you can help to counteract the potential negative impact on the environment and people that can otherwise result through the incorrect waste management of this product.

For more detailed information about recycling this product, contact your municipality, your domestic waste service or the shop from where you purchased the product.

Ensure that water cannot leak into the machine when drilling in the ceiling. Use an appropriate water collector and cover the machine in plastic, but do not cover the air intakes and air outlets.



**Other symbols/decals on the machine refer to special certification requirements for certain markets.**

## Symbols in the operator's manual:

Inspection and/or maintenance should be carried out with the motor switched off and the plug disconnected.

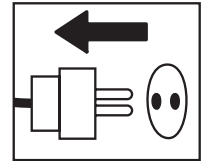

Always wear approved protective gloves.

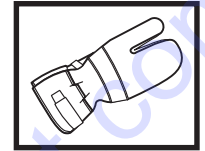

Regular cleaning is required.

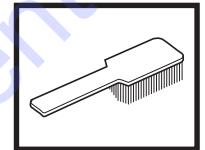

Visual check.

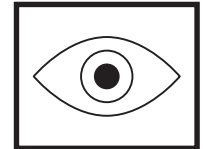

Protective goggles or a visor must be worn.



---

# CONTENTS

---

## Contents

### KEY TO SYMBOLS

Symbols on the machine: ..... 2

Symbols in the operator's manual: ..... 2

### CONTENTS

Contents ..... 3

### WHAT IS WHAT?

What is what on the drilling machine? ..... 4

### SAFETY INSTRUCTIONS

Steps before using a new drilling machine ..... 5

Personal protective equipment ..... 5

Machine's safety equipment ..... 6

Checking, maintaining and servicing the machine's  
safety equipment ..... 6

General safety precautions ..... 6

### PRESENTATION

DM 230 ..... 7

### STARTING AND STOPPING

Before starting ..... 8

Starting ..... 8

Stopping ..... 8

### WORKING TECHNIQUES

General working instructions ..... 9

Using the machine ..... 10

### MAINTENANCE

General ..... 11

Cleaning ..... 11

Electrical Feed ..... 11

Repairs ..... 11

Changing the gearbox oil ..... 11

Replacing the carbon brushes ..... 12

Daily maintenance ..... 12

### TECHNICAL DATA

EC-declaration of conformity ..... 14

# WHAT IS WHAT?

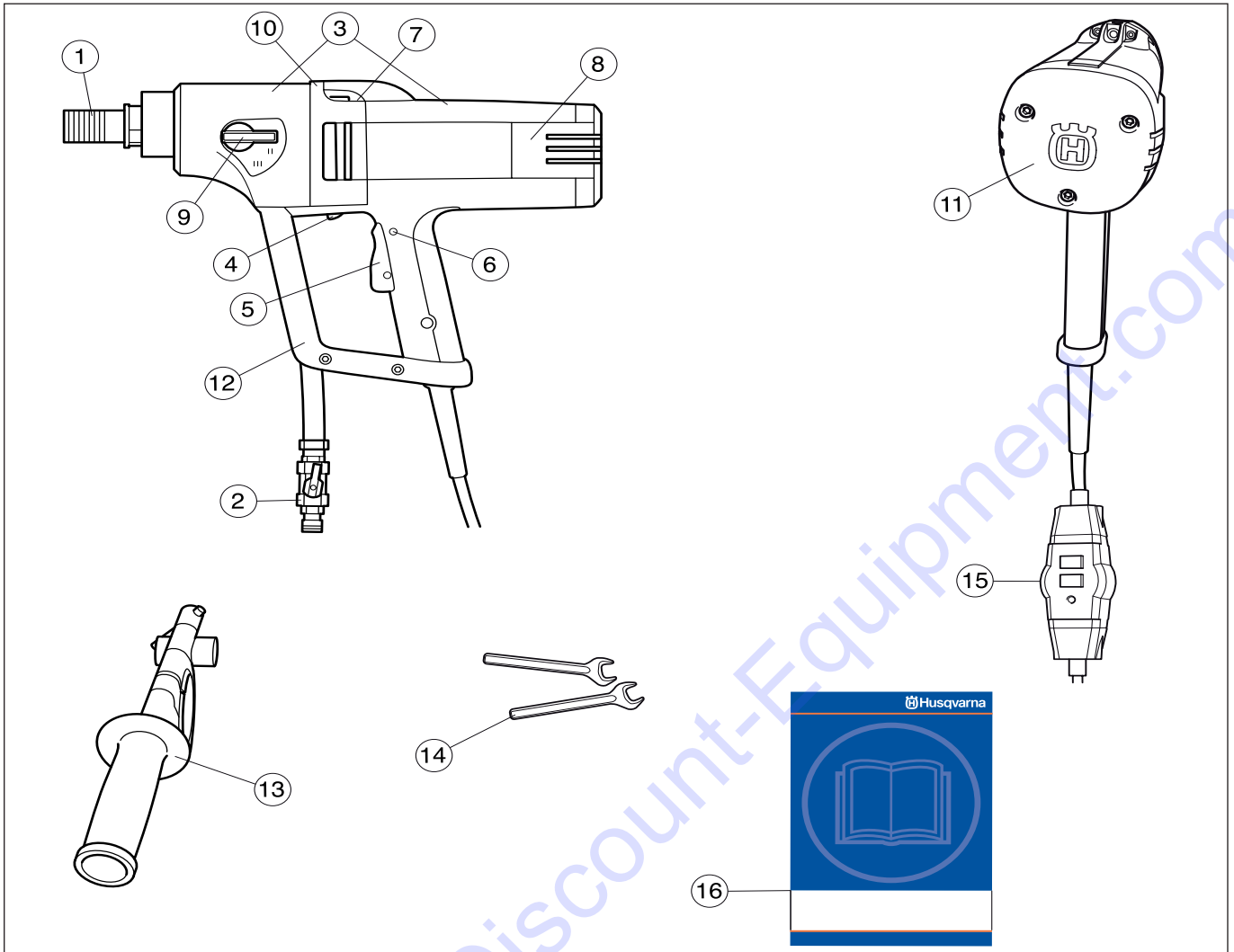

## What is what on the drilling machine?

- |                            |   |
|----------------------------|---|
| 1 Drill spindle            | 9 Gear knob   |
| 2 Water connector          | 10 Leakage hole (if water or oil trickles out from the leakage hole contact your dealer to replace the seals) |
| 3 Gearbox and motor module | 11 Stiffener  |
| 4 Smartstart™              | 12 Protecting brace and carrying handle   |
| 5 Switch                   | 13 Handle and adapter   |
| 6 Power switch lock        | 14 Spanners   |
| 7 Spirit level             | 15 Earth-fault breaker  |
| 8 Inspection cover         | 16 Operator's manual  |

# SAFETY INSTRUCTIONS

## Steps before using a new drilling machine

- Read through the operating instructions carefully before you begin using the machine.
- This machine is designed for and intended for drilling concrete, brick and different stone materials. All other use is improper.
- The machine is intended for use in industrial applications by experienced operators.
- Check the assembly of the drill, see the section changing the drill bit.
- Check that the cord and extension cord are intact and in good condition.
- Keep the workplace tidy. Disorder leads to accident risks.

## Always use common sense

It is not possible to cover every conceivable situation you can face when using a drilling machine. Always exercise care and use your common sense. Avoid all situations which you consider to be beyond your capability. If you still feel uncertain about operating procedures after reading these instructions, you should consult an expert before continuing. Do not hesitate to contact your dealer or us if you have any more questions about the use of the drilling machine. We will willingly be of service and provide you with advice as well as help you to use your drilling machine both efficiently and safely.

Let Discount-equipment check the drilling machine regularly and make essential adjustments and repairs.

All information and all data in the Operator's Manual were applicable at the time the Operator's Manual was sent to print.



**WARNING! Under no circumstances may the design of the machine be modified without the permission of the manufacturer. Always use genuine accessories. Non-authorized modifications and/or accessories can result in serious personal injury or the death of the operator or others.**



**WARNING! The use of products such as cutters, grinders, drills, that sand or form material can generate dust and vapours which may contain hazardous chemicals. Check the nature of the material you intend to process and use an appropriate breathing mask.**

## Personal protective equipment



**WARNING! You must use approved personal protective equipment whenever you use the machine. Personal protective equipment cannot eliminate the risk of injury but it will reduce the degree of injury if an accident does happen. Ask your dealer for help in choosing the right equipment.**

- Protective helmet
- Hearing protection
- Protective goggles or a visor



- Breathing mask

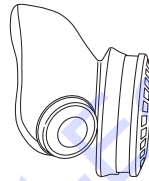

- Heavy-duty, firm grip gloves.



- Tight-fitting, heavy-duty and comfortable clothing that permits full freedom of movement.



- Boots with steel toe-caps and non-slip sole.



- Always have a first aid kit nearby.



# SAFETY INSTRUCTIONS

## Machine's safety equipment

This section describes the machine's safety equipment, its purpose, and how checks and maintenance should be carried out to ensure that it operates correctly. See the "What is what?" section to locate where this equipment is positioned on your machine.



**WARNING!** Never use a machine that has faulty safety equipment! Safety equipment must be inspected and maintained. See instructions under the heading **Checking, maintaining and servicing the machine's safety equipment**. If your machine does not pass all the checks, take it to a service workshop for repair.

## Checking, maintaining and servicing the machine's safety equipment



**IMPORTANT!** All servicing and repair work on the machine requires special training. This is especially true of the machine's safety equipment. If your machine fails any of the checks described below you must contact your service agent. When you buy any of our products we guarantee the availability of professional repairs and service. If the retailer who sells your machine is not a servicing dealer, ask him for the address of your nearest service agent.

### Switch

The power switch should be used to start and stop the machine.

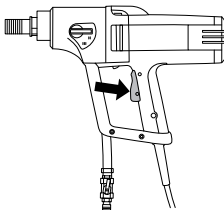

### Checking the power switch

Start the machine, release the power switch and check that the motor and the drill bit stop.

A defective power switch should be replaced by an authorized service workshop.

### Checking the power switch lock

Press the power switch and check that the power switch is locked when the power switch lock is pressed in.

Press in the power switch and make sure the switch returns to its original position when you release it.

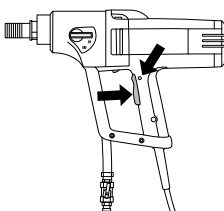

Check that the power switch and the power switch lock move easily.

## General safety precautions

- Do not use the drilling machine without first reading and understanding the contents of this Operator's Manual.



**WARNING!** There is always a risk of shocks from electrically powered machines. Avoid unfavourable weather conditions and body contact with lightning conductors and metal objects. Always follow the instructions in the Operator's manual to avoid damage.

- Never use the machine if you are tired, if you have drunk alcohol, or if you are taking medication that could affect your vision, your judgement or your co-ordination.
- Wear personal protective equipment. See instructions under the heading Personal protective equipment.
- Never carry the machine by means of the cord and never pull out the plug by pulling the cord. Keep all cords and extension cords away from water, oil and sharp edges. Make sure the cord is not pinched in doors, fences or the like. Otherwise it can cause the object to become live.
- Check that the cord and extension cord are intact and in good condition. Use an extension cord intended for outdoor use. Never use the machine if the cord is damaged, hand it in to an authorized service workshop for repair.
- Do not use an extension cord while it is rolled up to avoid overheating.



- The machine should be connected to an earthed outlet socket.
- Check that the mains voltage corresponds with that stated on the rating plate on the machine.
- Never use a machine that is faulty. Carry out the checks, maintenance and service instructions described in this manual. Some maintenance and service measures must be carried out by trained and qualified specialists. See instructions under the heading Maintenance.
- Never allow anyone else to use the machine without first ensuring that they have understood the contents of the operator's manual.
- People and animals can distract you causing you to lose control of the machine. For this reason, always remain concentrated and focused on the task.
- Be careful as clothing, long hair, and jewellery can get caught in moving parts.

## Transport and storage

Do not store or transport the drilling machine with the drill bit fitted in order to protect your drilling machine and drill bits from damage.

Store the drilling machine in a lockable area so that it is out of reach of children and unauthorised persons.

Store the drilling machine and stand in dry and frost free conditions.

# PRESENTATION

## DM 230

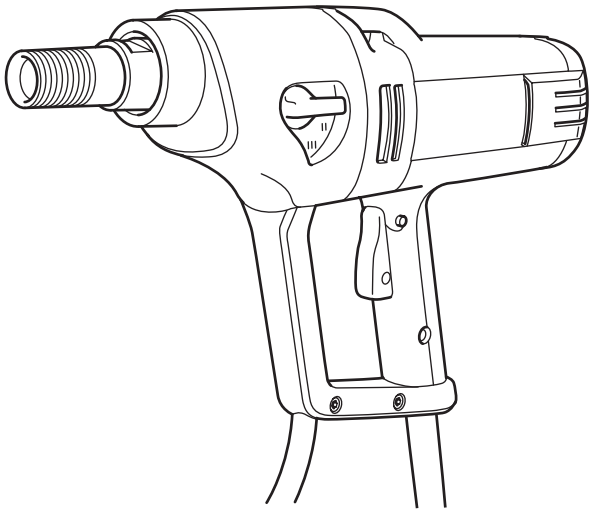

It is our wish that you will be satisfied with your product and that it will be your companion for a long time. Think of this operator's manual as a valuable document. By following its' content (using, service, maintenance etc) the life span and the second-hand value of the machine can be extended. If you will sell this machine, make sure that the buyer will get the operator's manual.

A purchase of one of our products gives you access to professional help with repairs and services whenever this may be necessary. If the retailer who sells your machine is not one of our authorised dealers, ask him for the address of your nearest service workshop. Use only genuine parts for repairs. The warranty is not valid if non genuine parts are used.

Husqvarna Construction Products has a policy of continuous product development. Husqvarna reserves the right to modify the design and appearance of products without prior notice and without further obligation introduce design modifications.

- The DM 230 is an electric handheld drill, intended for drilling concrete, brick and various stone materials.
- The drilling machine has a modular design and is easy to assemble.
- The machine is equipped with spirit levels to facilitate drilling and a swivel handle with an integrated adapter for support pins to make the work more comfortable.
- DM 230 has three speed ranges for drill bit sizes up to 150 mm.
- The machine has a water cooled gearbox with a pipe that runs through the spindle.
- DM 230 can also be connected to a vacuum cleaner with the help of an adapter, used for dry drilling, which is attached to the spindle.
- The drilling machine is equipped with Softstart™, Smartstart™, Elgard™ and speed control.

### Softstart™

Softstart™ is an electronic power limitation, making it easier to start the drill. Maximum speed is reached in about three seconds after the power switch is pressed in.

### Smartstart™

If the Smartstart™ button is pressed in directly after the power switch is pressed in, the speed is reduced by 50%. In Smartstart™ mode the machine has less power until the button is pressed in again. These functions are of great use for creating a pilot hole for drilling.

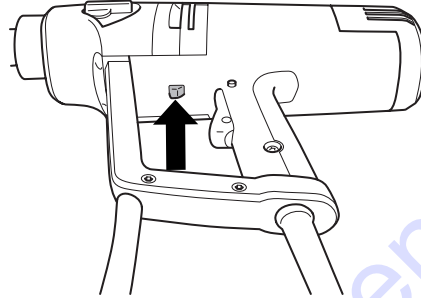

### Elgard™

Elgard™ is an electronic overload protection.

If the motor is overloaded, the overload protection pulses the motor. Reduce the load and the motor returns to its normal speed. The overload protection disconnects the power, if the machine is subjected to heavy loads or if the drill bit jams. The machine is reset by first releasing the power switch and then pressing it in again. If the drill bit jams, the mechanical slip clutch protects the gearbox before the overload protection disconnects the power.

### Speed control

Speed control always gives maximum output power from the machine. The speed control function provides the machine with a limited idling speed.

### Ergonomics

The soft rear section on the DM 230 has a large contact area so that the machine sits better against the body. The rounded handle makes the machine comfortable to hold while drilling. The protective loop forms a practical carry handle when transporting.

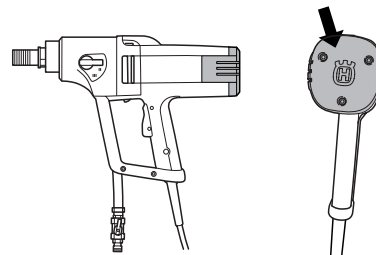



# STARTING AND STOPPING

## Before starting



**WARNING! Note the following before starting:**

The machine should be connected to an earthed outlet socket.

Check that the mains voltage corresponds with that stated on the rating plate on the machine.

Ensure you stand firmly. Keep people and animals well away from the working area.

Make sure that:

- The switch is undamaged. If not, the switch must be replaced by an authorised repairman.
- The switch is not sticking.
- The drill and its equipment are correctly installed:
  - The drill is secured properly.
  - If a stand is used, it must be attached to the machine by the fastening neck on the gearbox.
- Wear personal protective equipment. See instructions under the heading Personal protective equipment.
- The water cooling or vacuum cleaner (with the help of adapter) are attached to the machine. Use suitable drill bits depending on whether water or dry drilling is being performed. In the event of uncertainty contact your dealer, your service workshop or an experienced operator.

## Starting

**IMPORTANT!** Changing gear may only be done when the machine is switched off. Otherwise there is a risk of damaging the gearbox.

- 1 Set the working speed by turning the drill spindle and at the same time move the gear knob to the required position.

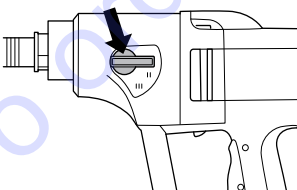

- 2 Turn on the water cooling (wet drilling) or switch on the vacuum cleaner (dry drilling).

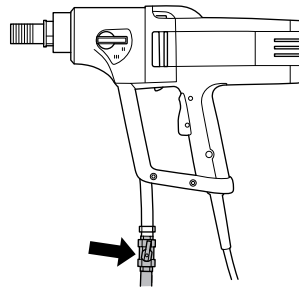

- 3 Hold the machine steady.
- 4 Press in the switch fully. Also press, if desired, the Smartstart™ button.

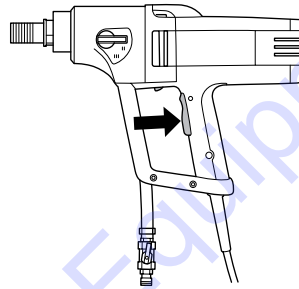

## Stopping



**WARNING! The drill bit continues to rotate for a while after the motor has been switched off. Do not stop the drill bit with your hands. Personal injuries can occur.**

Stop the motor by releasing the power switch.

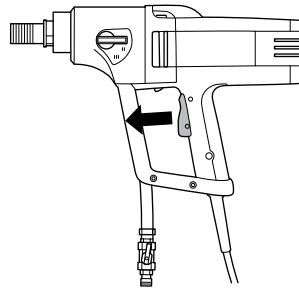

## Cooling

Run the machine unloaded for a minute or two to cool the motor.

# WORKING TECHNIQUES

## General working instructions



**WARNING!** This section takes up the basic safety precautions for working with the drilling machine. This information is never a substitute for professional skills and experience. If you encounter a situation where you are uncertain how to proceed you should ask an expert. Contact your dealer, service agent or an experienced drilling machine user. Do not attempt any task that you feel unsure of!



**WARNING!** Overexposure to vibration can lead to circulatory damage or nerve damage in people who have impaired circulation. Contact your doctor if you experience symptoms of overexposure to vibration. Such symptoms include numbness, loss of feeling, tingling, pricking, pain, loss of strength, changes in skin colour or condition. These symptoms normally appear in the fingers, hands or wrists. These symptoms may be increased in cold temperatures.

- Do not use the machine in bad weather, such as dense fog, rain, strong wind, intense cold, etc. Working in bad weather is tiring and can lead to dangerous conditions, e.g. slippery surfaces.
- Never start to work with the power cutter before the working area is clear and you have a firm foothold. Look out for any obstacles with unexpected movement. Ensure when cutting that no material can become loose and fall, causing operating injury.
- Never perform handheld drilling from a ladder. Use the stand for safe drilling.

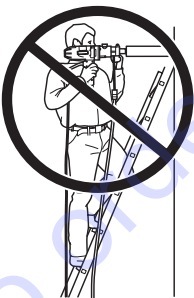

- Remain at a distance from the drill bit when the motor is running.
- Ensure that the working area is sufficiently illuminated to create a safe working environment.

- Make sure that no pipes or electrical cables are routed in the area to be drilled.

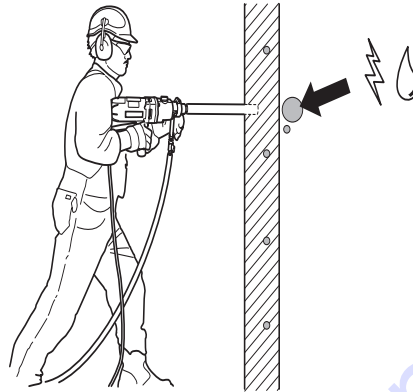

- Ensure the cord is behind you when you start to use the machine so that the cord will not be damaged.
- Never leave the machine unsupervised with the motor running. A rotating drill bit can entail a risk of serious injury.
- Always unplug the machine during longer work breaks.
- Do not overload the machine. Overloading can damage the machine.
- Keep tools sharp and clean in order to enable safer work.
- Always check the rear side of the surface where the drill bit will emerge when drilling right through. Secure and cordon off the area and make sure that no one can be injured or material damaged.
- Always switch off the machine before you move it.
- Never work alone, always ensure there is another person close at hand. Apart from being able to receive help to assemble the machine, you can also get help if an accident should occur.
- Keep all parts in good working order and ensure that all fixtures are properly tightened.

# WORKING TECHNIQUES

## Using the machine

- The machine has a very high torque. This demands good concentration during work, as serious personal injuries can occur if the drill bit suddenly jams.
- Keep your hands at a safe distance from the drill spindle and drill bit when the machine is running.
- Keep an eye open for oil or water leakage. If water or oil trickles out from the leakage hole on the top of the pinion neck, the seals must be replaced

## Handheld drilling



**WARNING! Do not perform handheld drilling in first gear as the machine has a powerful torque that can result in personal injuries should the drill bit jam.**

- Always use a drill bit with a max. diameter of 75 mm with handheld drilling. The larger the drill bit the greater the reaction if the drill jams.
- Always make sure you are standing firmly when carrying out handheld drilling.

## Stand drilling

- Always use a drilling stand if drilling is to be performed from a ladder or scaffold.

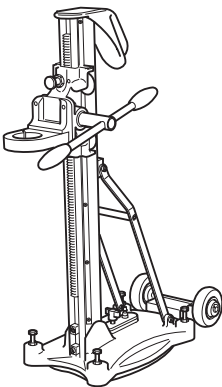

Handheld drilling in these situations is full of risks, as the risk of falling is very high if the drill bit jams.



- Make sure that the stand is secured correctly.
- Make sure that the drilling machine is secured correctly in the stand.

## Drilling outdoors

- Always use extension cables that are approved for outdoor use.

## Drilling in ceilings and the like

- Use a water collector to avoid water penetrating into the machine. The machine must be covered with plastic or the like in order to prevent water penetrating into the machine, but do not cover the air intakes and air outlets.

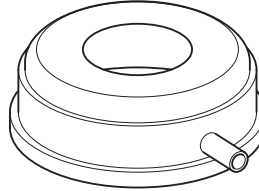

**IMPORTANT! The air intake must not be covered.**

## Changing the drill bit



- 1 Pull out the plug.
- 2 Get:
  - The new drill bit.
  - The supplied open-ended spanners, size 24 mm and 32 mm.
  - Water-resistant grease.
- 3 Remove the old drill bit using the open-ended spanners.
- 4 Apply water-resistant grease to the thread of the new drill bit.
- 5 Attach the drill bit using the open-ended spanners.

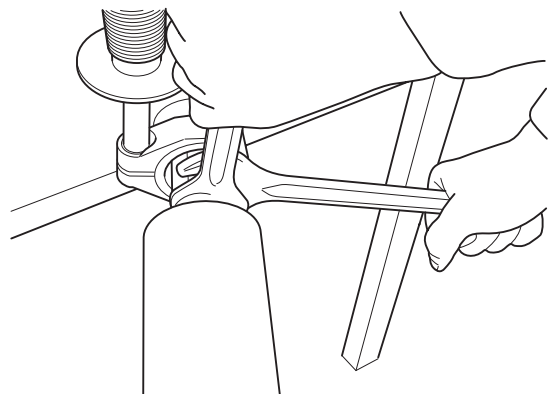

Before the machine is started, carefully check that the new bit is firmly attached.

# MAINTENANCE

## General



**IMPORTANT!** Inspection and/or maintenance should be carried out with the motor switched off and the plug disconnected.

The lifetime of your machine can be extended considerably if it is used, cared for and maintained in the proper manner.

## Cleaning

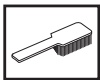

- Keep the machine and drill bit clean in order for drilling to be carried out safely

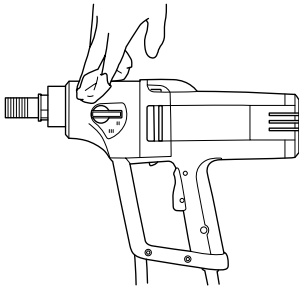

- Keep the handle dry and free of grease and oil.
- In order for the machine to always be cooled sufficiently the cooling air openings must be kept clear and clean. Blow down the machine regularly with compressed air.

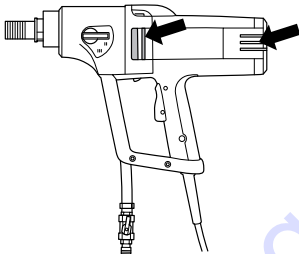

- Use compressed air to periodically clean the motor. Remove the inspection cover and clean the cover.

## Electrical Feed



**WARNING!** Never use damaged cables that can cause serious, even fatal, personal injuries.

Check that the cord and extension cord are intact and in good condition. Never use the machine if the cord is damaged, hand it in to an authorized service workshop for repair.

## Repairs

**Important** All types of repairs may only be carried out by authorised repairmen. This is so that the operators are not exposed to great risks.

## Changing the gearbox oil



Contact your dealer to get the right oil.

The oil in the gearbox must be changed after every 400 hours of operation. Do as follows:

- 1 Get:
  - New oil, Mobile Lube1 SHC 75W90 or other similar transmission oil.
  - A container for the old oil.
- 2 Secure the machine with drill spindle downwards in a vice or the like.
- 3 Unscrew the six screws holding the motor - gearbox modules together.

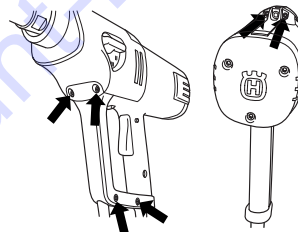

- 4 Carefully disassemble the machine.
- 5 Empty the gearbox oil into the container.
- 6 If necessary contact your dealer to clean the gearbox.
- 7 Pour the new oil into the gearbox, about 0.25 litres.

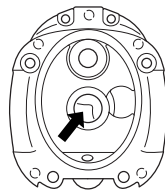

- 8 Fit a new O-ring between the motor cover and the gearbox cover. Contact your dealer to receive the correct O-ring.

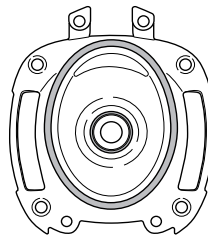

- 9 Reassemble the machine and screw in the six screws.

# MAINTENANCE

## Replacing the carbon brushes



The carbon brushes must be removed and checked regularly. Weekly if the machine is used daily or at longer intervals if the machine is used more seldom. The area of wear should be even and undamaged.

Both carbon brushes must always be replaced as a pair, but one at a time. Do as follows:

- 1 Remove the inspection cover's screws, 3.



- 2 Lift the carbon brush holder spring to one side.
- 3 Loosen the screw.
- 4 Pull out the carbon brush connector.
- 5 Pull the carbon brush out from the holder.

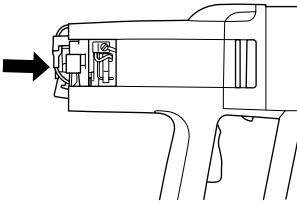

- 6 Clean the brush holder with compressed air or a brush. Replace the brushes if worn.
- 7 Fit the new carbon brushes and, at the same time, check that they slide easily in the brush retainers.
- 8 Put the brush holder spring back into place.
- 9 Insert the carbon brush connection under the screw.
- 10 Repeat the procedure with the other carbon brush.
- 11 Refit the inspection cover screws, 3. Press together the rear section to make it easier to secure the screws. Make sure that the inspection cover enters its slots.

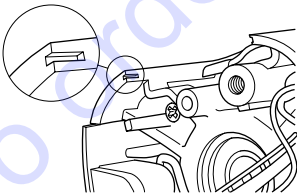

- 12 Let the machine idle for 10 minutes to run in the new carbon brushes.

## Daily maintenance



- 1 Check that nuts and screws are tight.
- 2 Check that the power switch unit works smoothly.
- 3 Clean the outside of the machine.
- 4 Check and clean the cooling air openings
- 5 Check that the cord and extension cord are intact and in good condition.

# TECHNICAL DATA

Electric motor Single-phase  
 Rated voltage, V 230/100-120  
 Rated output, W 1850/8 A

**Rated current, A**

230 V 8 A  
 100-120 V 15 A

Weight, Lbs/kg 7

**Noise emissions**

Sound power level, measured, EN 60745-2-1, dB(A) 94

**Sound levels**

Noise pressure level at the operators ear, measured according to EN 60745-2-1, dB(A) 90

**Diameter drill bit, mm**

Max. diameter of the drill bit, with stand 150 mm (5,9")  
 Max. diameter for the drill bit, handheld 75 mm (3")

Spindle thread G 1/2" G 1 1/4"  
 Water connector G 1/4"  
 Stand, mm Ø 60 mm

**Vibration levels**

Handle, equivalent value, m/s<sup>2</sup> <2,5

Gear housing	Drill bit speed with load	Drill bit load without load	Handheld drilling		Stand drilling	
			Recommended drill bit size (mm)	Recommended drill bit size (inch)	Recommended drill bit size (mm)	Recommended drill bit size (inch)
1	580	730	Not recommended	Not recommended	100-150	4-6
2	1400	1700	40-80	2-4	40-80	2-4
3	2900	3600	0-40	0-2	0-40	0-2

**TO PURCHASE THIS PRODUCT PLEASE CONTACT US**



**Equipment Financing and  
Extended Warranties Available**



**Discount-Equipment.com is your online resource for  
commercial and industrial quality parts and equipment sales.**

**561-964-4949**

**visit us on line @ [www.discount-equipment.com](http://www.discount-equipment.com)**

Select an option below to find your Equipment

**Search by Manufacturer**

**Search by Product Type**

**Request a Quote**

We sell worldwide for the brands: Genie, Terex, JLG, MultiQuip, Mikasa, Essick, Whiteman, Mayco, Toro Stone, Diamond Products, Generac Magnum, Airman, Haulotte, Barreto, Power Blanket, Nifty Lift, Atlas Copco, Chicago Pneumatic, Allmand, Miller Curber, Skyjack, Lull, Skytrak, Tsurumi, Husquvarna Target, Stow, Wacker, Sakai, Mi-T-M, Sullair, Basic, Dynapac, MBW, Weber, Bartell, Bennar Newman, Haulotte, Ditch Runner, Menegotti, Morrison, Contec, Buddy, Crown, Edco, Wyco, Bomag, Laymor, EZ Trench, Bil-Jax, F.S. Curtis, Gehl Pavers, Heli, Honda, ICS/PowerGrit, IHI, Partner, Imer, Clipper, MMD, Koshin, Rice, CH&E, General Equipment, Amida, Coleman, NAC, Gradall, Square Shooter, Kent, Stanley, Tamco, Toku, Hatz, Kohler, Robin, Wisconsin, Northrock, Oztec, Toker TK, Rol-Air, APT, Wylie, Ingersoll Rand / Doosan, Innovatech, Con X, Ammann, Mecalac, Makinex, Smith Surface Prep, Small Line, Wanco, Yanmar