

**COMPLEX SOLUTIONS
MADE SIMPLE.**



DEEP SEA ELECTRONICS PLC

DSE5310

AUTOSTART CONTROL MODULE

OPERATING MANUAL



Deep Sea Electronics Plc
Highfield House
Hunmanby
North Yorkshire
YO14 0PH
ENGLAND

Sales Tel: +44 (0) 1723 890099
Sales Fax: +44 (0) 1723 893303

E-mail: sales@Deepseapl.com
Website: www.deepseapl.com

DSE Model 5310 Control and Instrumentation System Operators Manual

© Deep Sea Electronics Plc

All rights reserved. No part of this publication may be reproduced in any material form (including photocopying or storing in any medium by electronic means or other) without the written permission of the copyright holder except in accordance with the provisions of the Copyright, Designs and Patents Act 1988.

Applications for the copyright holder's written permission to reproduce any part of this publication should be addressed to Deep Sea Electronics Plc at the address above.

Any reference to trademarked product names used within this publication is owned by their respective companies.

Deep Sea Electronics Plc reserves the right to change the contents of this document without prior notice.

TABLE OF CONTENTS

Section	Page
1 INTRODUCTION	5
2 CLARIFICATION OF NOTATION USED WITHIN THIS PUBLICATION.	5
3 OPERATION	6
3.1 AUTOMATIC MODE OF OPERATION	7
3.2 MANUAL OPERATION	9
4 PROTECTIONS.....	10
4.1 WARNINGS	11
4.2 ANALOGUE PRE-ALARMS	13
4.3 HIGH CURRENT WARNING ALARM.....	14
4.4 SHUTDOWNS.....	15
4.5 HIGH CURRENT SHUTDOWN ALARM	19
4.6 ELECTRICAL TRIPS.....	19
5 DESCRIPTION OF CONTROLS	20
5.1 TYPICAL LCD DISPLAY SCREENS	22
5.1.1 TYPICAL STATUS DISPLAY.....	22
5.1.2 TYPICAL INSTRUMENT DISPLAY	22
5.1.3 TYPICAL ALARM DISPLAY	22
5.1.4 TYPICAL EVENT DISPLAY.....	23
5.2 VIEWING THE INSTRUMENTS	23
5.2.1 INSTRUMENT PAGE CONTENT.....	24
5.2.2 MANUALLY SELECTING AN INSTRUMENT	24
5.2.3 MODEM STATUS	25
5.2.4 CAN ERROR MESSAGES	26
5.3 VIEWING THE EVENT LOG.....	26
5.4 USER CONFIGURABLE INDICATORS	27
5.5 CONTROLS	27
6 FRONT PANEL CONFIGURATION	28
6.1.1 ENTERING THE CONFIGURATION EDITOR PIN NUMBER	28
6.2 EDITING A VALUE.....	30
6.2.1 LIST OF ADJUSTABLE PARAMETERS IN 'MAIN CONFIGURATION EDITOR'.....	31
6.2.2 LIST OF ADJUSTABLE PARAMETERS IN 'APPLICATION EDITOR'	32
6.2.3 EDITING THE CURRENT DATE AND TIME	33
7 INSTALLATION INSTRUCTIONS.....	35
7.1 PANEL CUT-OUT.....	35
7.2 COOLING.....	35
7.3 UNIT DIMENSIONS.....	35
7.4 FRONT PANEL LAYOUT.....	36
7.5 REAR PANEL LAYOUT	36
8 ELECTRICAL CONNECTIONS.....	37
8.1 CONNECTION DETAILS.....	37
8.1.1 PLUG "A" 8 WAY	37
8.1.2 PLUG "B" 11 WAY	38
8.1.3 PLUG "C" 3 WAY	38
8.1.4 PLUG "D" 4 WAY (OPTIONAL)	39
8.1.5 PLUG "F" 4 WAY	39
8.1.6 PLUG "G" 5 WAY	39
8.1.7 PLUG "H" 4 WAY	40
8.1.8 PC CONFIGURATION INTERFACE CONNECTOR.....	40
8.1.9 EXPANSION OUTPUT CONNECTOR.....	40
8.2 CONNECTOR FUNCTION DETAILS.....	41
8.2.1 PLUG "A" 8 WAY	41
8.2.2 PLUG "B" 11 WAY	41

8.2.3	PLUG "C" 3 WAY	42
8.2.4	PLUG "D" 4 WAY (OPTIONAL)	42
8.2.5	PLUG "F" 4 WAY	42
8.2.6	PLUG "G" 5 WAY	43
8.2.7	PLUG "H" 4 WAY	43
8.2.8	PURCHASING ADDITIONAL CONNECTOR PLUGS FROM DSE	43
9	SPECIFICATION	44
10	COMMISSIONING	46
10.1.1	PRE-COMMISSIONING	46
11	FAULT FINDING	47
12	FACTORY DEFAULT CONFIGURATION	48
13	TYPICAL WIRING DIAGRAM	52
14	APPENDIX	53
14.1	ALTERNATIVE WIRING TOPOLOGIES	53
14.1.1	3 PHASE, 3 WIRE	53
14.1.2	1 PHASE, 2 WIRE	54
14.1.3	2 PHASE, 3 WIRE (2 PHASE CENTRE TAP NEUTRAL)	54
14.2	ICONS AND LCD IDENTIFICATION	55
14.2.1	PUSH BUTTONS	55
14.2.2	STATUS / MEASUREMENT UNITS	55
14.2.3	LED INDICATION	55
14.3	5310 IDMT TRIPPING CURVES (TYPICAL)	56
14.4	SENDER WIRING RECOMMENDATIONS	57
14.4.1	EARTH RETURN SENDERS	57
14.4.2	INSULATED RETURN SENDERS	57
14.4.3	FUEL LEVEL SENDERS	57
14.5	CAN INTERFACE	59
14.6	OUTPUT EXPANSION	59
14.6.1	RELAY OUTPUT EXPANSION (157)	59
14.6.2	LED OUTPUT EXPANSION (548)	59
14.7	INPUT EXPANSION	59
14.8	COMMUNICATIONS OPTION CONNECTIONS	60
14.8.1	DESCRIPTION	60
14.8.2	PC TO CONTROLLER (DIRECT) CONNECTION	60
14.8.3	MODEM TO CONTROLLER CONNECTION	60
14.8.4	RS485 LINK TO CONTROLLER	61
14.8.5	MODBUS™	62
14.9	ENCLOSURE CLASSIFICATIONS	63

1 INTRODUCTION

The **DSE 5310** autostart module has been designed to allow the user to start and stop the generator, and if required, transfer the load to the generator either manually (via external push-buttons) or automatically. The user also has facility to view all the system operating parameters via the LCD display.

The **DSE 5310** module monitors the engine, indicating the operational status and fault conditions; automatically shutting down the engine and giving a true first up fault condition of an engine failure by a COMMON AUDIBLE ALARM. The exact failure mode is indicated by text messages on the LCD display on the front panel.





The powerful microprocessor contained within the module allows for a range of complex features to be incorporated as standard:

- *Text based LCD display (supporting multiple languages).*
- *Voltage, Current and Power monitoring.*
- *Engine parameter monitoring.*
- *Fully configurable inputs for use as alarms or a range of different functions.*
- *Extensive range of output functions using built in relay outputs or relay expansion modules available.*

Selective operational sequences, timers and alarm trips can be altered by the customer via a PC using the 52/53xx series configuration software and P810 interface. Additionally, a subset of this information can be adjusted from the module's front panel configuration editor.

The module is housed in a robust plastic case for front panel mounting. Connections to the module are via locking plug and sockets.

2 CLARIFICATION OF NOTATION USED WITHIN THIS PUBLICATION.

 NOTE:	Highlights an essential element of a procedure to ensure correctness.
 CAUTION!	Indicates a procedure or practice which, if not strictly observed, could result in damage or destruction of equipment.
 WARNING!	Indicates a procedure or practice, which could result in injury to personnel or loss of life if not followed correctly.
	Compliant with BS EN 60950 Low Voltage Directive Compliant with BS EN 50081-2 EMC Directive Compliant with BS EN 50082-2 EMC Directive
	Indicates a function only applicable when the controller is configured for connection to a CAN engine controller

3 OPERATION

The following description details the sequences followed by a module containing the standard 'factory configuration'. Always refer to your configuration source for the exact sequences and timers observed by any particular module in the field.

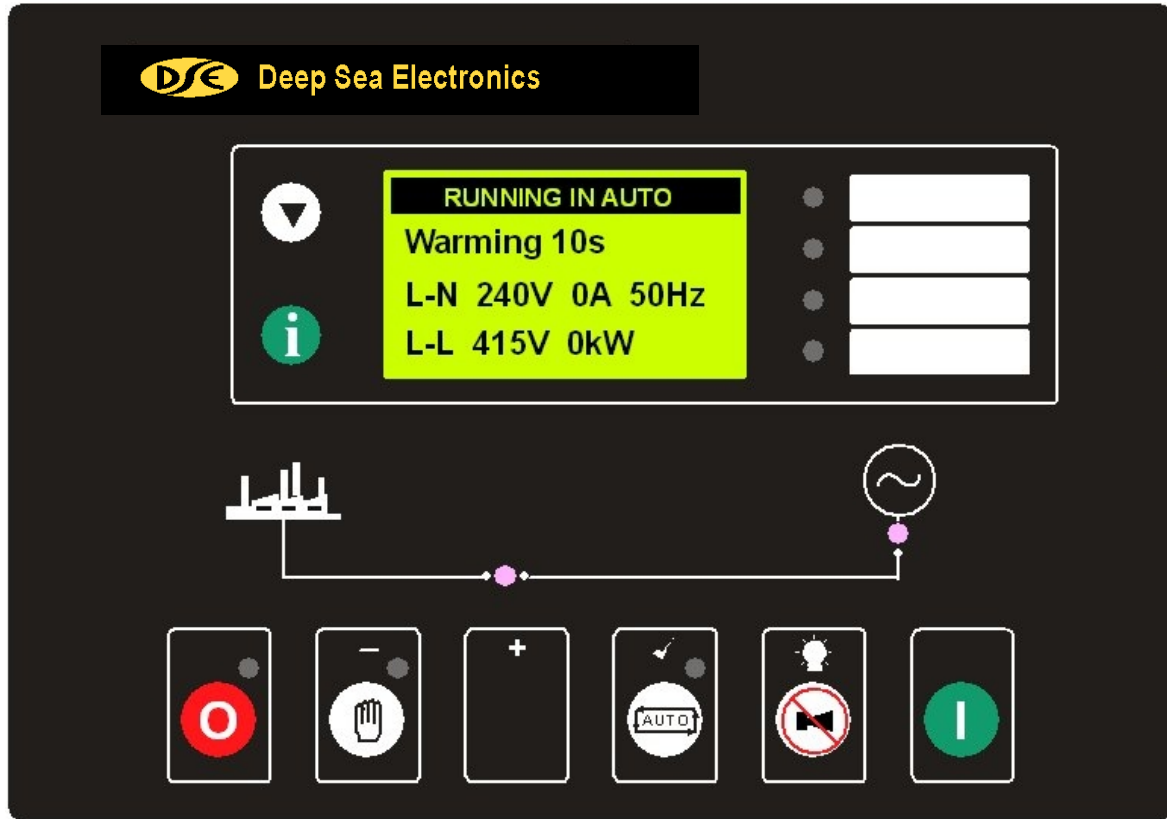



FIG 1

3.1 AUTOMATIC MODE OF OPERATION

NOTE:- If a digital input configured to panel lock is active, changing module modes will not be possible. Viewing the instruments  and  is NOT affected by panel lock. If panel lock is active the Panel lock indicator (if configured) illuminates.

This mode is activated by pressing the  pushbutton. An LED indicator beside the button confirms this action.

If the **Remote Start** input (if configured) is activated the relevant indicator (if configured) illuminates.

To allow for false remote start signals, the Start Delay timer is initiated. After this delay, if the pre-heat output option is selected then the pre-heat timer is initiated, and the corresponding auxiliary output (if configured) will energise.

NOTE:- If the Remote Start signal is removed during the Start Delay timer, the unit will return to a stand-by state.

After the above delays the **Fuel Solenoid (or enable ECU output if configured)** is energised, then one second later, the **Starter Motor** is engaged.

NOTE:- If the unit has been configured for CAN, compatible ECU's will receive the start command via CAN.

The engine is cranked for a pre-set time. If the engine fails to fire during this cranking attempt then the starter motor is disengaged for the pre-set rest period. Should this sequence continue beyond the set number of attempts, the start sequence will be terminated and **Fail to Start** fault will be displayed.

Alarm
Shutdown
Failed to start

When the engine fires, the starter motor is disengaged and locked out at a pre-set frequency from the Alternator output. Alternatively, a Magnetic Pickup mounted on the flywheel housing can be used for speed detection (This is selected by PC using the 5xxx series configuration software). Rising oil pressure can also be used to disconnect the starter motor; however, it cannot be used for underspeed or overspeed detection.

NOTE:- If the unit has been configured for CAN, speed sensing is via CAN.

After the starter motor has disengaged, the **Safety On** timer is activated, allowing Oil Pressure, High Engine Temperature, Under-speed, Charge Fail and any delayed Auxiliary fault inputs to stabilise without triggering the fault.

Once the engine is running, the **Warm Up** timer, if selected, is initiated, allowing the engine to stabilise before accepting the load.



If an auxiliary output has been selected to give a **load transfer** signal, this then activates.

 **NOTE:-A load transfer will not be initiated until the Oil Pressure has risen. Thus preventing excessive wear on the engine.**

On removal of the **Remote Start** signal, the **Stop** delay timer is initiated, once it has timed out, the **load Transfer** signal is de-energised, removing the load. The **Cooling** timer is then initiated, allowing the engine a cooling down period off load before shutting down. Once the **Cooling** timer expires the **Fuel Solenoid** is de-energised, bringing the generator to a stop.

Should the **Remote Start** signal be re-activated during the cooling down period, the set will return on load.

3.2 MANUAL OPERATION

 **NOTE:-** If a digital input configured to panel lock is active, changing module modes will not be possible. Viewing the instruments  and event logs  is NOT affected by panel lock. If panel lock is active the Panel lock indicator (if configured) illuminates.

To initiate a start sequence in **MANUAL**, press the  pushbutton. When the controller is in the manual mode (indicated by an LED indicator beside the button), pressing the **START (I)** button will initiate the start sequence.

 **NOTE:-** There is no Start Delay in this mode of operation.

If the **pre-heat** output option is selected this timer is then initiated, and the auxiliary output selected is energised.

After the above delay, the **Fuel Solenoid (or ECU output if configured)** is energised, then one second later, the **Starter Motor** is engaged.

 **NOTE:-** If the unit has been configured for CAN, compatible ECU's will receive the start command via CAN.

The engine is cranked for a pre-set time period. If the engine fails to fire during this cranking attempt then the starter motor is disengaged for the pre-set rest period. Should this sequence continue beyond the set number of attempts, the start sequence will be terminated and **Fail to Start** will be displayed.

When the engine fires, the starter motor is disengaged and locked out at a pre-set frequency from the Alternator output. Alternatively, a Magnetic Pickup mounted on the flywheel housing can be used for speed detection (This is selected by PC using the 52/53xx series configuration software). Rising oil pressure can also be used to disconnect the starter motor; however, it cannot be used for underspeed or overspeed detection.

 **NOTE:-** If the unit has been configured for CAN, speed sensing is via CAN.

After the starter motor has disengaged, the **Safety On** timer is activated, allowing Oil Pressure, High Engine Temperature, Under-speed, Charge Fail and any delayed Auxiliary fault inputs to stabilise without triggering the fault.

Once the engine is running, the **Warm Up** timer, if selected, is initiated, allowing the engine to stabilise before it can be loaded.

The generator will run off load, unless the **Remote Start on load** signal is applied or, if **Close generator** has been selected as a control source, the appropriate auxiliary output will then activate.

The generator will continue to run **On** load, until the **Auto** mode is selected.

If Auto mode is selected, and the **remote start on load** signal is not active, then the **Stop Delay Timer** begins, after which, the load is disconnected. The generator will then run **off** load allowing the engine a **cooling** down period.

Selecting **STOP (O)** de-energises the **FUEL SOLENOID**, bringing the generator to a stop.

4 PROTECTIONS

When an alarm is present, the Audible Alarm will sound and the Common alarm LED if configured will illuminate.

The audible alarm can be silenced by pressing the 'Mute' button



The LCD display will jump from the 'Information page' to display the Alarm Page

Alarm	
Warning	← The type of alarm. E.g. Shutdown or warning
Low oil pressure	← The nature of alarm, eg Low oil pressure.

The LCD will display multiple alarms E.g. "High Engine Temperature shutdown", "Emergency Stop" and "Low Coolant Warning" alarms have been triggered. These will automatically scroll round in the order that they occurred;

Running in auto	If no alarms are present the LCD will display this default page.
Generator on load	
L-N 230v 240A 50Hz	
L-L 400v 133kW	

In the event of a warning alarm, the LCD will display the appropriate text. If a shutdown then occurs, the module will again display the appropriate text.

Example:-

Alarm
Shutdown High engine temperature

Followed by....

Alarm
Shutdown Emergency stop

Followed by....

Alarm
Warning Low coolant level

The unit will scroll through all active alarms in a continuous loop.

Alarm
Shutdown High engine temperature

4.1 WARNINGS

Warnings are non-critical alarm conditions and do not affect the operation of the generator system, they serve to draw the operators attention to an undesirable condition.

In the event of an alarm the LCD will jump to the alarms page, and scroll through all active warnings and shutdowns.

BATTERY CHARGE FAILURE, will be displayed if the module does not detect a voltage from the warning light terminal on the auxiliary charge alternator.

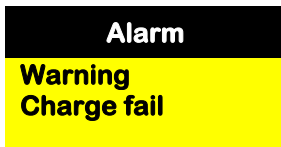

BATTERY LOW VOLTAGE, will be displayed if the module detects that the plant DC supply has fallen below the low volts setting level. The Battery Low Voltage alarm is delayed by the Low DC Volts Delay timer.

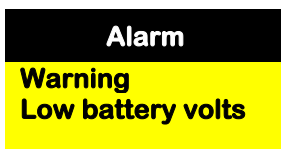

BATTERY HIGH VOLTAGE, will be displayed if the module detects that the plant DC supply has risen above the high volts setting level. The Battery High Voltage alarm is delayed by the High DC Volts Delay timer.

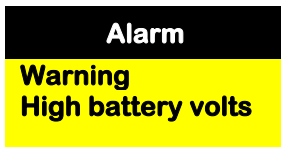

MAINTENANCE ALARM, will be displayed if the maintenance period is exceeded (engine running hours or date interval whichever is configured).

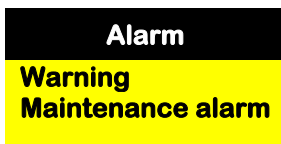

FAIL TO STOP, will be displayed if the module detects the engine is still running when the 'Fail to stop timer' expires.



 **NOTE:- 'Fail to Stop' could indicate a faulty oil pressure sender - If engine is at rest check oil sender wiring and configuration.**

AUXILIARY INPUTS, auxiliary inputs can be user configured and will display the message as written by the user.

Example

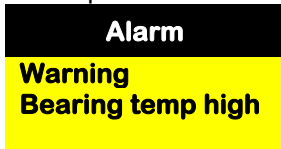

LOW FUEL LEVEL will be displayed if the fuel level detected by the fuel level sender falls below the low fuel level setting.

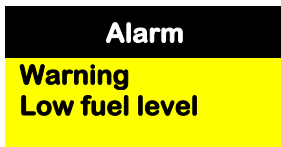

 **CAN ECU ERROR** If the module is configured for **CAN instruments** and receives an "error" message from the engine control unit, 'Can ECU error' is shown on the module's display and a warning alarm is generated.

Example

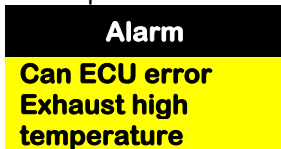

The display will alternate between the text display and the manufacturers error codes

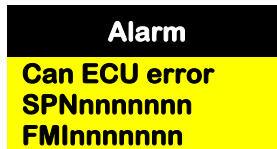

4.2 ANALOGUE PRE-ALARMS

The following alarms are termed 'pre-alarms' as they pre warn the operator of a potentially more serious alarm condition. For instance, if the engine temperature rises past the pre alarm level, a warning condition will occur to notify the operator. If the temperature falls below this level, then the alarm ceases, and the set will continue to run as normal. However if the temperature continues to rise until the coolant temperature trip point is reached, the warning is escalated and a high coolant temperature shutdown is initiated.

LOW OIL PRESSURE, if the module detects that the engine oil pressure has fallen below the low oil pressure pre-alarm setting level after the **Safety On** timer has expired, a warning will occur. Alarm Warning Low Oil Pressure will be displayed.

Alarm
Warning Low oil pressure

HIGH ENGINE TEMPERATURE if the module detects that the engine coolant temperature has exceeded the high engine temperature pre-alarm setting level after the **Safety On** timer has expired, a warning will occur. Alarm Warning High Coolant Temperature will be displayed.

Alarm
Warning High temperature

LOW ENGINE TEMPERATURE if the module detects that the engine coolant temperature has fallen below the low engine temperature pre-alarm setting level after the **Safety On** timer has expired, a warning will occur. Alarm Warning Low Coolant Temp will be displayed.

Alarm
Warning Low Coolant Temp

OVERSPEED, if the engine speed exceeds the pre-alarm trip a warning is initiated. Alarm Warning Overspeed will be displayed. It is an **immediate warning**.

Alarm
Warning Overspeed

UNDERSPEED, if the engine speed falls below the pre-set pre-alarm after the Safety On timer has expired, a warning is initiated. Alarm Warning Underspeed will be displayed.

Alarm
Warning Underspeed

GENERATOR HIGH FREQUENCY if the module detects a generator output frequency in excess of the pre-set pre-alarm, a warning is initiated. Alarm Warning High frequency will be displayed, it is an **immediate warning**.

Alarm
Warning Over frequency

GENERATOR LOW FREQUENCY if the module detects a generator output frequency below the pre-set pre-alarm after the Safety On timer has expired, a warning is initiated. Alarm Warning Low Frequency will be displayed

Alarm
Warning Under frequency

GENERATOR HIGH VOLTAGE if the module detects a generator output voltage in excess of the pre-set pre-alarm, a warning is initiated. Alarm Warning High voltage will be displayed, it is an **immediate warning**.

Alarm
Warning AC Overvolts

GENERATOR LOW VOLTAGE if the module detects a generator output voltage below the pre-set pre-alarm after the Safety On timer has expired, a warning is initiated. Alarm Warning Low Voltage will be displayed.

Alarm
Warning AC Undervolts

 **CAN ECU ERROR** If the module is configured for **CAN instruments** and receives an “error” message from the engine control unit, ‘Can ECU error’ is shown on the module’s display and a warning alarm is generated.

Example

Alarm
Can ECU error Exhaust high temperature

The display will alternate between the text display and the manufacturers error codes

Alarm
Can ECU error SPNnnnnnnn FMInnnnnnn

4.3 HIGH CURRENT WARNING ALARM

GENERATOR HIGH CURRENT, if the module detects a generator output current in excess of the pre-set trip a warning is initiated. Alarm Warning High Current will be displayed. If this high current condition continues for an excess period of time, then the alarm is escalated to a shutdown condition. For further details of the high current alarm, please see High Current Shutdown Alarm.

Alarm
Warning High current

4.4 SHUTDOWNS

Shutdowns are latching and stop the Generator. The alarm must be cleared, and the fault removed to reset the module.

NOTE:- The alarm condition must be rectified before a reset will take place. If the alarm condition remains it will not be possible to reset the unit (The exception to this is the Low Oil Pressure alarm and similar 'delayed alarms', as the oil pressure will be low with the engine at rest).

FAIL TO START, if the engine does not fire after the pre-set number of attempts has been made a shutdown will be initiated. Alarm Shutdown Fail To Start will be displayed.

Alarm
Shutdown
Failed to start

EMERGENCY STOP, removal of the **Positive DC** Supply from the Emergency Stop input initiates the following sequence. Firstly it will initiate a controlled shutdown of the Generator and prevent any attempt to restart the Generator until the Emergency Stop push-button has been reset. Secondly it removes the **Positive DC** supply from both the Fuel Solenoid and Starter Solenoid.

Alarm Shutdown Emergency Stop will be displayed.

Alarm
Shutdown
Emergency stop

NOTE:- The Emergency Stop Positive signal must be present otherwise the unit will shutdown.

LOW OIL PRESSURE, if the module detects that the engine oil pressure has fallen below the low oil pressure trip setting level after the **Safety On** timer has expired, a shutdown will occur. Alarm Shutdown Low Oil Pressure will be displayed.

Alarm
Shutdown
Low oil pressure

HIGH ENGINE TEMPERATURE if the module detects that the engine coolant temperature has exceeded the high engine temperature trip setting level after the **Safety On** timer has expired, a shutdown will occur. Alarm Shutdown High Engine Temperature will be displayed.

Alarm
Shutdown
High temperature

OVERSPEED, if the engine speed exceeds the pre-set trip a shutdown is initiated. Alarm Shutdown Overspeed will be displayed. Overspeed is not delayed, it is an **immediate shutdown**.

Alarm
Shutdown
Overspeed

 **NOTE:-**During the start-up sequence the overspeed trip logic can be configured to allow an extra trip level margin. This is used to prevent nuisance tripping on start-up - Refer to the 53xx series configuration software manual under heading 'Overspeed Overshoot' for details.

UNDERSPEED, if the engine speed falls below the pre-set trip after the Safety On timer has expired, a shutdown is initiated. Alarm Shutdown Underspeed will be displayed.

Alarm
Shutdown
Underspeed

GENERATOR HIGH FREQUENCY if the module detects a generator output frequency in excess of the pre-set trip a shutdown is initiated. Alarm Shutdown High Frequency will be displayed, it is an **immediate shutdown**.

Alarm
Shutdown
Over frequency

GENERATOR LOW FREQUENCY, if the module detects a generator output frequency below the pre-set trip after the Safety On timer has expired, a shutdown is initiated. Alarm Shutdown Low Frequency will be displayed.

Alarm
Shutdown
Under frequency

GENERATOR HIGH VOLTAGE if the module detects a generator output voltage in excess of the pre-set trip a shutdown is initiated. Alarm Shutdown High Volts will be displayed, it is an **immediate shutdown**.

Alarm
Shutdown
AC Overvolts

GENERATOR LOW VOLTAGE if the module detects a generator output voltage below the below the pre-set trip after the Safety On timer has expired, a shutdown is initiated. Alarm Shutdown Low Volts will be displayed.

Alarm
Shutdown
AC Undervolts

OIL PRESSURE SENDER OPEN CIRCUIT, if the module detects a loss of signal from the oil pressure sender (open circuit) a shutdown is initiated. Alarm Shutdown Sender Fault will be displayed. Sender failure is not delayed, it is an **immediate shutdown**.

Alarm
Shutdown
Oil pressure sender fault

AUXILIARY INPUTS, if an auxiliary input has been configured as a shutdown the appropriate message will be displayed as configured by the user.

Alarm
Shutdown
Bearing temp high

MAINTENANCE ALARM, will be displayed if the maintenance period is exceeded (engine running hours or date interval whichever is configured). The engine is shutdown (if configured to do so)

Alarm
Shutdown
Maintenance alarm

LOSS OF SPEED SIGNAL, if the speed sensing signal is lost during cranking, a shutdown is initiated. Alarm Shutdown Loss Of Speed Signal will be displayed.

Alarm
Shutdown
Loss of speed signal

NOTE:- This will only occur if the speed sensing signal is lost during cranking or during the safety on timer. If the signal is lost during normal operation the Generator will shutdown with an Under-speed alarm.

 **CAN DATA FAIL** If the module is configured for CAN operation and does not detect data on the engine Can datalink, a shutdown will occur and 'Can data fail' is shown on the module's display.

Alarm
Shutdown
Can data fail

 **CAN ECU FAIL** If the module is configured for **CAN instruments** and receives a "fail" message from the engine control unit, the engine is shutdown and 'Can ECU fail' is shown on the module's display.

Example

Alarm
Can ECU fail
Fuel pressure low

The display will alternate between the text display and the manufacturers error codes

Alarm
Can ECU fail
SPNnnnnnnn
FMInnnnnnn

 **NOTE:- If the CAN message is a manufacturers specific code, it may not be displayed as text. If this is the case the display will show the generic manufacturers code, which must be cross-referenced with the engine manufacturers literature. . Please contact the engine manufacturer for further assistance.**

Example

Alarm

Can ECU fail

SPNnnnnn

FMInnnn

4.5 HIGH CURRENT SHUTDOWN ALARM

GENERATOR HIGH CURRENT, if the module detects a generator output current in excess of the pre-set trip a warning is initiated. This warning will continue for a period of time depending upon the level of overload that the generator is subjected to, and the configuration setting for Generator High Current in the 5xxx series configuration software.

Alarm
Shutdown High current trip

For instance the factory default settings for Generator High Current allow for a loading of the generator to 110% for one hour. That is to say if the generator load level exceeds the trip point by 10%, a warning alarm will occur while the overload condition exists. If the load level does not drop to normal levels within one hour, the set is stopped, the 5310 module displaying either shutdown alarm or electrical trip alarm depending upon module configuration.

NOTE:- Higher overload levels will result in a faster acting shutdown condition. For instance with the factory default configuration, an overload level twice that of the trip level (typically 200%) will result in a Generator High Current shutdown condition after 36 seconds. For details of the relationship between the overload and the shutdown time, please see the Appendix section of this manual.

4.6 ELECTRICAL TRIPS

Electrical trips are latching and stop the Generator but in a controlled manner. On initiation of the electrical trip condition the module will de-energise the '**Close Generator**' Output to remove the load from the generator. Once this has occurred the module will start the Cooling timer and allow the engine to cool off-load before shutting down the engine. The alarm must be accepted and cleared, and the fault removed to reset the module.

AUXILIARY INPUTS, if an auxiliary input has been configured as an electrical trip the appropriate message will be displayed as configured by the user.

Example

Alarm
Electrical trip Phase rotation

GENERATOR HIGH CURRENT. If the module detects a generator output current in excess of the pre-set trip a warning is initiated. If this high current condition continues for an excess period of time, then the alarm is escalated to either a shutdown or electrical trip condition (depending upon module configuration). For further details of the high current alarm, please see High Current Shutdown Alarm.

Alarm
Electrical trip High current

5 DESCRIPTION OF CONTROLS

The following section details the function and meaning of the various controls on the module.

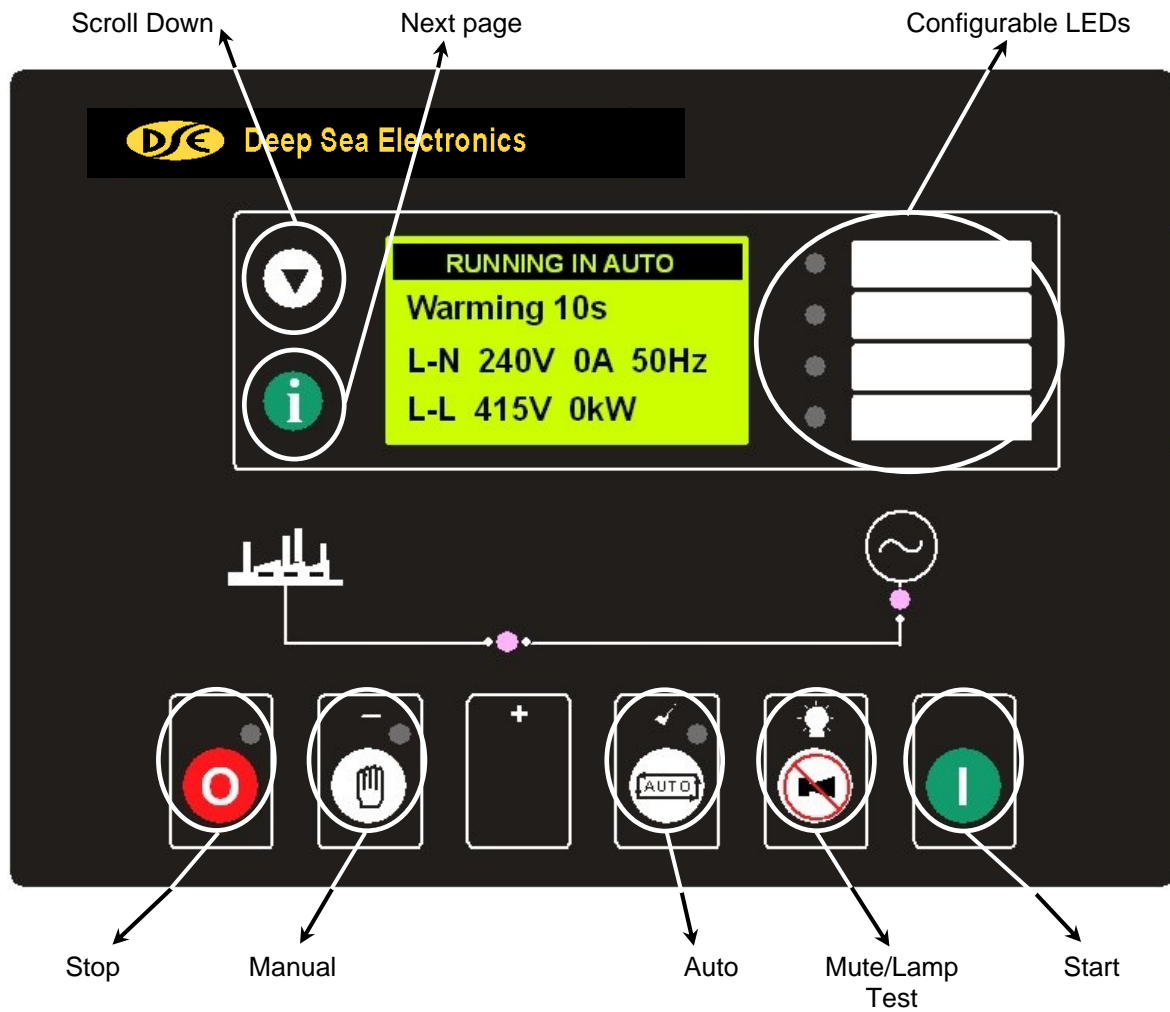

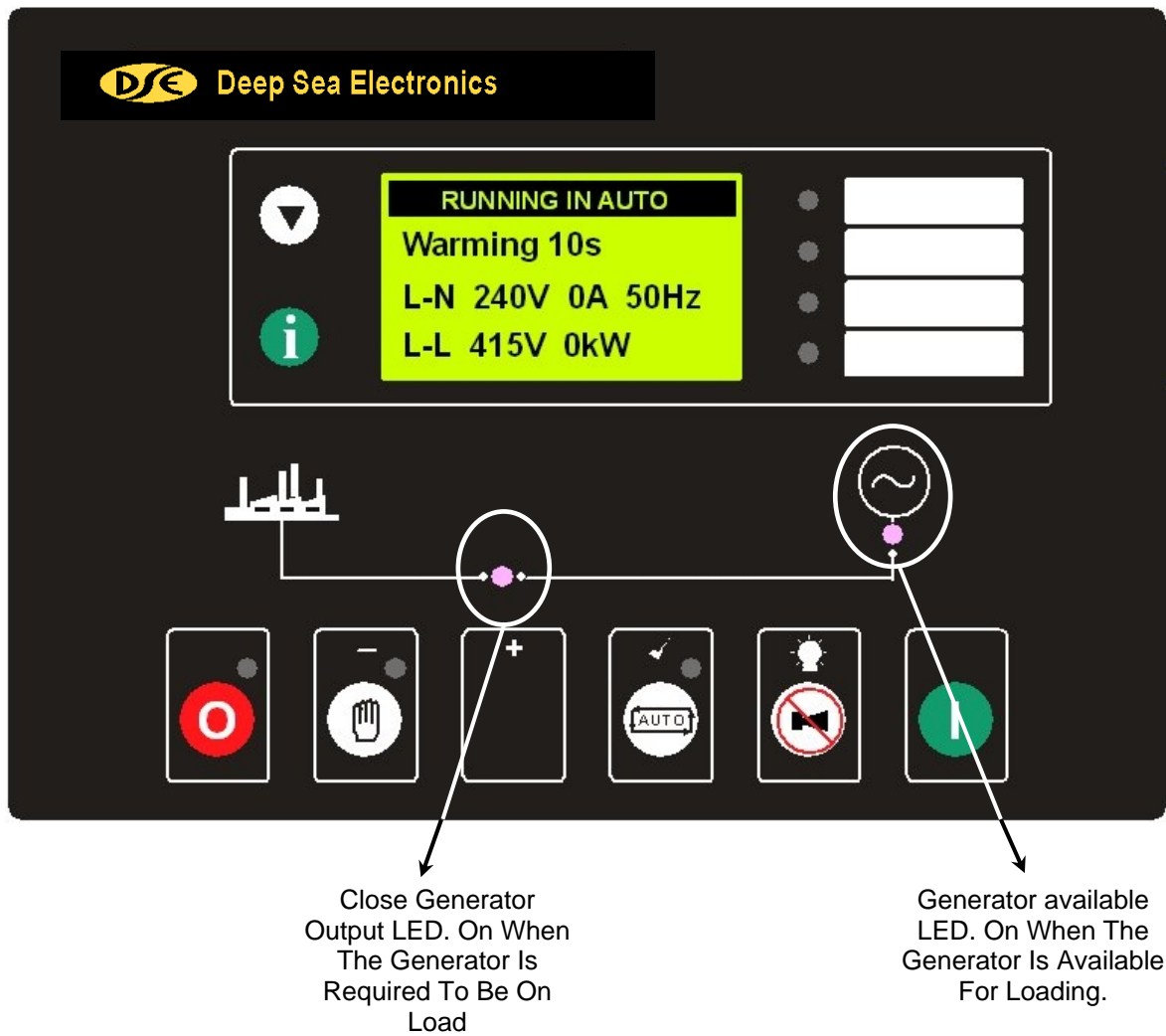

▲ NOTE:- “Generator on load” LED has two modes of operation depending upon the configuration of the controllers digital inputs.

- 1) Digital input configured for “Generator closed auxiliary” – The LED will be lit when the generator closed auxiliary input is active – The LED shows the state of the auxiliary contact.
- 2) There is NO input configured for “Generator closed auxiliary” (factory default setting) – The LED will be lit when the 5310 gives the loading signal to the generator – The LED shows the state of the 5310’s loading request.

5.1 TYPICAL LCD DISPLAY SCREENS

5.1.1 TYPICAL STATUS DISPLAY

Waiting in auto	Indicates that the module is in Automatic. The unit will respond to an active remote start.
Waiting in auto	

Starting remote	Indicates that the module is in automatic and that a start sequence has been initiated, with an active remote start. The module is attempting to crank the generator.
Starting remote Cranking attempt 1	

Running in auto	Indicates that the module is in Automatic, and that the generator is running on load. This default screen also indicates the average line to neutral voltage, highest of the 3 phase currents, generator frequency, average line to line voltage and total kilowatts.
Generator on load	
L-N 230v 240A 50Hz	
L-L 400v 133kW	

5.1.2 TYPICAL INSTRUMENT DISPLAY

Coolant temperature	The display of coolant temperature in both degrees centigrade and Fahrenheit.
60 °C 140 °F	

Oil pressure	The display of engine oil pressure in Bar, Pounds Per Square Inch and kilo Pascal.
6 Bar 87 PSI	
600 kPa	

Generator Amps	The display of all three generator line currents.
L1 L2 L3	
238 241 241	

5.1.3 TYPICAL ALARM DISPLAY

Alarm	The module is warning that the engine oil pressure has fallen below a pre-set level. The generator is not shut down.
Warning Low oil pressure	

Alarm	The oil pressure has fallen below a second pre-set value and has shut down the generator.
Shutdown Low oil pressure	

Alarm	The module is warning that the battery volts is below a pre-set value.
Warning Low battery Volts	

5.1.4 TYPICAL EVENT DISPLAY

Event log 21:15:00 10th September 2005 Low oil pressure Shutdown	On the 10 th September 2005 at 21:15 the unit detected that the oil pressure was below the pre-set trip level, and has shut down the generator.
Event log 20:10:00 8th September 2005 Emergency stop Shutdown	On the 8 th September 2005 at 20:10. The emergency stop button was pressed and the generator was shut down.
Event log 08:46:00 7th September 2005 Over Volts Shutdown	On the 7 th September 2005 at 08:46 the unit detected that the generator out put volts exceeded pre-set trip level, and has shut down the generator.

5.2 VIEWING THE INSTRUMENTS



It is possible to manually scroll to display the different pages of information by repeatedly operating the next page  button.

Page order:-

- *Status display*
- *Instrument display*
- *Alarms display*
- *Event log*

It is possible to manually scroll to display the different instruments by repeatedly operating the next page button . Once selected the instrument will remain on the LCD display until the user selects a different instrument or after a period of inactivity for the duration of the configurable Page Timer, the module will revert to the default display.

Alternatively, to autoscroll through all instruments on the currently selected page, press and hold the scroll  button.







To disable autoscroll, press and hold the scroll  button, or select another page with the page select  button. When autoscroll is disabled, the display will automatically return to the Status/Alarms page if no buttons are pressed for the duration of the configurable Page Timer.

If an alarm becomes active while viewing instruments, the Status/Alarms page will be automatically displayed to draw the operator's attention to the alarm condition.



5.2.1 INSTRUMENT PAGE CONTENT

- Engine speed
- Oil Pressure
- Coolant temperature
- Fuel level (%)
- Engine Hours Run
- DC Battery Voltage
- Charge alternator volts
- Modem Status (GSM only)
- Generator AC RMS Voltage Line-Neutral
- Generator AC RMS Voltage Line-Line
- AC RMS Line Current
- Generator Output
- Number of starts

If enhanced instrumentation is selected, the following instrumentation will become available, if supported by the engine manufacturer.

- Engine oil temperature 
- Inlet manifold temperature 
- Coolant pressure 
- Fuel pressure 
- Fuel consumption 
- Total fuel used 
- Turbo pressure 

5.2.2 MANUALLY SELECTING AN INSTRUMENT

Default display		<p style="text-align: center;">Running in auto</p> <p>Generator on load L-N 230v 240A 50Hz L-L 400v 133kW</p>
Pressing the DOWN button the LCD will then show Engine speed.		<p style="text-align: center;">Engine speed</p> <p>1500 RPM 50 Hz</p>
Pressing the DOWN button the LCD will then show Oil pressure.		<p style="text-align: center;">Oil pressure</p> <p>6 Bar 87 PSI 600 Kpa</p>

Pressing the  button again will scroll through each individual instrument eventually returning to the original instrument displayed.

NOTE:-Once selected the instrument will remain on the LCD display until the user selects a different instrument or after a period of inactivity for the duration of the configurable Page Timer, the module will revert to the initial display.

5.2.3 MODEM STATUS

When configured and connected to a GSM Modem for cellular network communications, the GSM MODEM STATUS screen shows the following information.

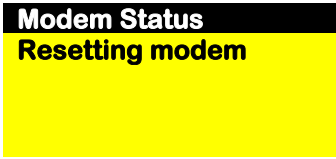

The modem is reset by the 5300 series controller.

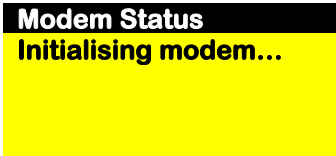

Modem initialising strings are sent to the modem (as set in the *Edit Config | Comms* tab of the configuration software).

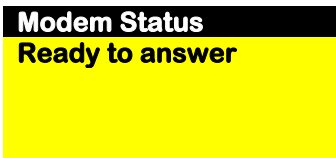

The modem has been initialised and is ready to answer.

If the module does not detect that the modem is operating correctly, this procedure begins again from *Resetting modem* and will continue to repeat until the modem operation is detected correctly.

GSM STATUS

If the DSE controller detects that the modem connected is a GSM modem, the following additional status is shown:

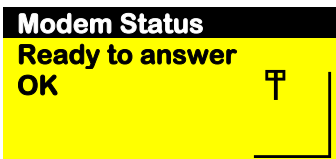

The modem has been initialised and is ready to answer. OK shows the SIM card is inserted but there is no signal

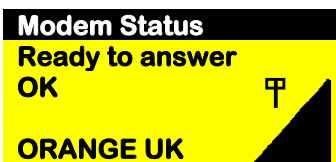

The modem has been initialised and is ready to answer. The SIM card is inserted, the signal is received full strength and the operator name is shown.

NOTE:- Operator name is not available in all GSM areas.

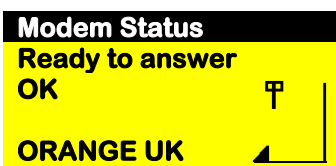

The modem has been initialised and is ready to answer. The SIM card is inserted, the signal is received but is low and the operator name is shown.

NOTE:- Operator name is not available in all GSM areas.

5.2.4 CAN ERROR MESSAGES

 Where 53xx controllers are connected to a suitable Can ECU, alarm status messages are transmitted to the 53xx controller and displayed on the alarms page.

Alarm	Here the ECU code is interpreted by the module, which displays the warning as text. An error is like a warning, and does not shutdown the generator. The display will alternate between the text display and the manufacturers error codes	Alarm
CAN ECU error Exhaust hi temp		CAN ECU error SPNnnnnn FMInnnnn

Alarm	A CAN ECU fail is a shutdown and the module stops the generator. The display will alternate between the text display and the manufacturers error codes	Alarm
CAN ECU fail Fuel pressure low		CAN ECU fail SPNnnnnn FMInnnnn

Alarm	Where the module does not recognise the ECU error / fail code the SPN and FMI codes are displayed. These codes then have to be cross referenced with engine manufactures literature to determine the exact problem.
CAN ECU error SPNnnnnn FMInnnnn	

 **NOTE:- For details on these code meanings, refer to the ECU instructions provided by the engine manufacturer, or contact the engine manufacturer for further assistance.**

 **NOTE:- For further details on connection to electronic engines please refer to the CAN and DSE wiring manual.**

5.3 VIEWING THE EVENT LOG

The 53xx modules maintains a log of the last 30 shutdown alarms to enable the operator or engineer to view the past alarms history. Only shutdown and electrical trip alarms are logged; warning alarms are not logged. Once the log is full (30 events, any subsequent shutdown alarms will overwrite the oldest entry in the log. Hence the log will always contain the 30 most recent shutdown alarms.

The alarm is logged, along with the date and time of the event in the format shown in this example.

Event log 21:15:00
10th September 2005 Low oil pressure Shutdown

To view the event log, repeatedly press the next page button  the LCD screen displays **Event log**.

Press down  to view the next most recent shutdown alarm:

Continuing to press down  will cycle through the past alarms until all 30 logged alarms have been viewed, after which the most recent alarm will again be showed and the cycle will begin again.

To exit the event log and return to viewing the instruments, press the next page  button.







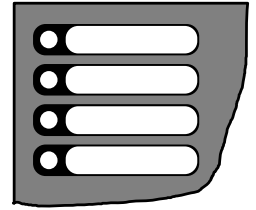

5.4 USER CONFIGURABLE INDICATORS

These LEDs can be configured by the user to indicate any one of **100+ different functions** based around the following:-

- **Indications** - Monitoring of a digital input and indicating associated functioning user's equipment - *Such as Battery Charger On or Louver's Open, etc.*
- **WARNINGS** And **SHUTDOWNS** - Specific indication of a particular warning or shutdown condition, backed up by LCD indication - *Such as Low Oil Pressure Shutdown, Low Coolant level, etc.*
- **Status Indications** - Indication of specific functions or sequences derived from the modules operating state - *Such as Safety On, Pre-heating, Panel Locked, Generator Available, etc.*



5.5 CONTROLS

<p>Stop / Reset This button places the module into its Stop/reset mode. This will clear any alarm conditions for which the triggering criteria have been removed. If the engine is running and this position is selected, the module will automatically instruct the changeover device to unload the generator ('Close Generator' becomes inactive (if used)). The fuel supply will be removed and engine will be brought to a standstill. Should a remote start signal be present while operating in this mode, a remote start will <u>not</u> occur. If configured, the 5310 controller will enter <i>sleep mode</i> after 60 seconds of inactivity as a power saving feature.</p>	
<p>Manual This mode is used to allow manual control of the generator functions. Once in Manual mode the module will respond to the start (I) button and start the engine and run off load. If the engine is running off-load in the Manual mode and a remote start signal becomes present, the module will automatically instruct the changeover device to place the generator on load ('Close Generator' becomes active (if used)). Should the remote start signal then be removed the generator will remain on load until either the 'STOP/RESET' or 'AUTO' positions is selected.</p>	
<p>Auto This button places the module into its 'Automatic' mode. This mode allows the module to control the function of the generator automatically. The module will monitor the remote start input and once a start condition is signalled the set will be automatically started and placed on load ('Close Generator' becomes active (if used)). If the starting signal is removed the module will automatically transfer the load from the generator and shut the set down observing the stop delay timer and cooling timer as necessary. The module will then await the next start event. <i>For further details please see the more detailed description of 'Auto Operation' earlier in this manual.</i></p>	
<p>Test This button places the module into its 'Test' mode. This mode allows the operator to perform an 'on load' test of the system. Once in Test mode the module will respond to the start (I) button and start the engine, and run on load ('Close Generator' becomes active (if used)). The generator will continue to run on load until Auto mode is selected. Then, If the starting signal is removed, the module will automatically transfer the load from the generator and shut the set down observing the stop delay timer and cooling timer as necessary. The module will then await the next start event. <i>For further details please see the more detailed description of 'Test Operation' earlier in this manual.</i></p>	
<p>Start This button is only active in STOP/RESET , MANUAL  or TEST  mode. Pressing this button in manual or test mode will start the engine and run off load (manual) or on load (test). Pressing this button in STOP/RESET mode will turn on the CAN engine ECU (when correctly configured and fitted to a compatible engine ECU)</p>	
<p>Mute / Lamp Test This button silences the audible alarm if it is sounding and illuminates all of the LEDs. If there is no audible alarm this button will only illuminate all the LEDs. When correctly configured and fitted to a compatible engine ECU, pressing this button in STOP/RESET mode after pressing the START (I) button (to power the ECU) will cancel any "passive" alarms on the engine ECU.</p>	

6 FRONT PANEL CONFIGURATION

This configuration mode allows the operator limited customising of the way the module operates.

Operation	Detail
To enter the 'configuration mode' press both the INFO and STOP buttons together.	

6.1.1 ENTERING THE CONFIGURATION EDITOR PIN NUMBER

The configuration editor contains two sections.

- Main configuration editor (for 'site adjustable' or 'commissioning' parameters)
- Application editor (to allow installation engineers to make application changes).
The 'Application Editor' is designed to allow the module to be configured for different applications without needing to re-configure the module settings. This makes it particularly suitable for applications where the generator would be used in a number of different roles, specifically in Rental or mobile type applications.

If the module PIN number has been set, the PIN number request is then shown. The configuration cannot be viewed or changed until the PIN number is correctly entered.

Enter either the 'main' PIN or the application PIN.

If no PIN has been set, then skip to the next section.

NOTE:- The 'Application Editor' must be enabled first in order to make it accessible from the module's fascia. This is done by setting a PIN (number) for the module's main front panel editor, using the 5xxx for Windows™ PC configuration software.

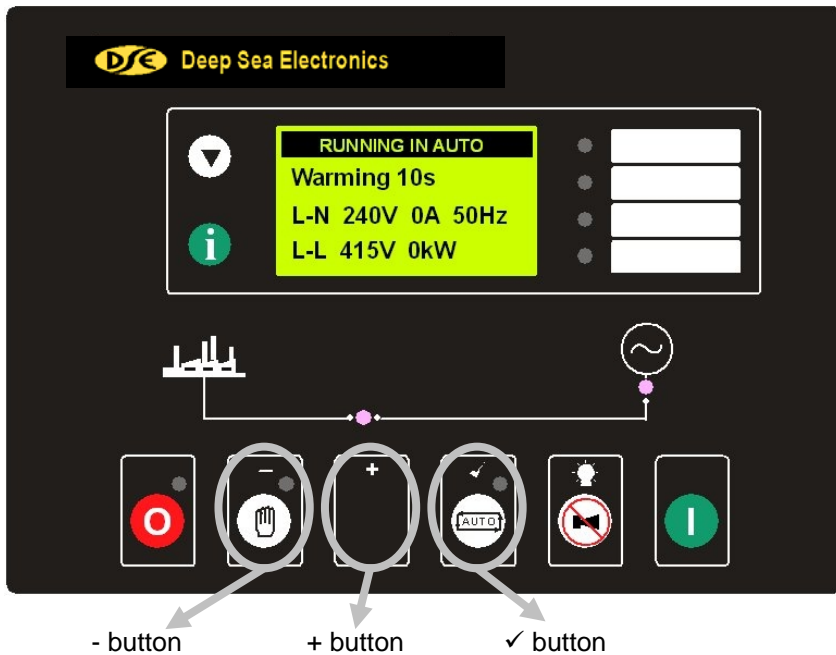

The configuration editor contains two sections.

- Main configuration editor (for 'site adjustable' or 'commissioning' parameters)
- Application editor (to allow installation engineers to make application changes).
The 'Application Editor' is designed to allow the module to be configured for different applications without needing to re-configure the module settings. This makes it particularly suitable for applications where the generator would be used in a number of different roles, specifically in Rental or mobile type applications.

If the module PIN number has been set, the PIN number request is then shown. The configuration cannot be viewed or changed until the PIN number is correctly entered.

Enter either the 'main' PIN or the application PIN.

If no PIN has been set, then skip to the next section.

NOTE:- The 'Application Editor' must be enabled first in order to make it accessible from the module's fascia. This is done by setting a PIN (number) for the module's main front panel editor, using the 5xxx for Windows™ PC configuration software.

Enter pin	The first * is flashing. Press + or – buttons to adjust it to the correct value for the first digit of the PIN number.
* * * *	Press ✓ when the first digit is correctly entered.
	The entered digit will turn back to a * to maintain security.

Enter pin	The second * is now flashing. Press + or – buttons to adjust it to the correct value for the second digit of the PIN number.
* * * *	Press ✓ when the second digit is correctly entered.
	The entered digit will turn back to a * to maintain security.

Enter pin	The third * is now flashing. Press + or – buttons to adjust it to the correct value for the third digit of the PIN number.
* * * *	Press ✓ when the third digit is correctly entered.
	The entered digit will turn back to a * to maintain security.

Enter pin	The fourth * is now flashing. Press + or – buttons to adjust it to the correct value for the fourth digit of the PIN number.
* * * *	Press ✓ when the fourth digit is correctly entered.

NOTE:- When ✓ is pressed after editing the final PIN digit, the PIN is checked for validity. If the number is not correct, the editor is automatically exited. To retry you must re-enter the editor as described above.

Oil pressure pre-alarm	If the Configuration PIN has been entered successfully (or the PIN number has not been set in the module) the first configurable parameter is displayed :
2 Bar 30 PSI 200 kPa	

NOTE:- To exit the front panel configuration editor at any time, press the Stop/Reset  button. Ensure you have saved any changes you have made by pressing the ✓ button first.

NOTE:- When the editor is visible, it is automatically exited after 5 minutes of inactivity to ensure security.

NOTE:- If the Application Menu PIN is entered, then only the Application Menu is displayed. If the Full Configuration PIN is entered, the entire configuration menu is displayed including the Application Menu.

NOTE:- The PIN number is automatically reset when the editor is exited (manually or automatically) to ensure security.

6.2 EDITING A VALUE

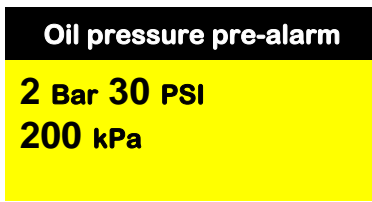

Press the Stop/Reset  and Info  buttons simultaneously.

If the module PIN number has been set, the PIN number request is then shown. The configuration cannot be viewed or changed until the PIN number is correctly entered. (see the section ACCESSING THE FRONT PANEL CONFIGURATION EDITOR)

Press the + button until the desired page is shown. EG oil pressure pre-alarm.

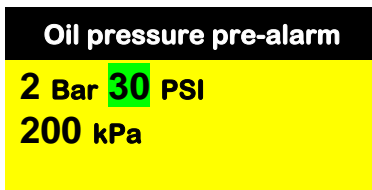

To edit the oil pressure pre-alarm, press the  button, the pressure will start to flash. Pressing the + or - buttons will adjust the parameter to the desired value. In this example, the 30 PSI will be adjusted, and the bar/kPA units will automatically show their respective values.

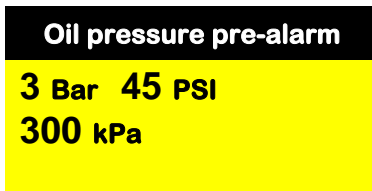

Press the  button to 'save' the value. The value will stop flashing to confirm that it has been saved.

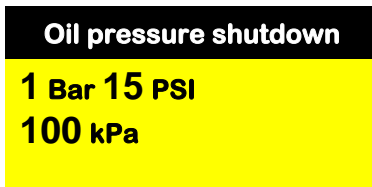

To select another value to edit, press the + button.

 **NOTE:- To exit the front panel configuration editor at any time, press the Stop/Reset  button. Ensure you have saved any changes you have made by pressing the  button first.**

Continuing to press the + or - buttons will cycle through the adjustable parameters in the order shown overleaf:

6.2.1 LIST OF ADJUSTABLE PARAMETERS IN 'MAIN CONFIGURATION EDITOR'

Section	Parameter	Display shows	Values
Input settings	Low Oil Pressure warning	Oil pressure pre-alarm	0-4bar (1.17bar)
	Low Oil Pressure shutdown	Oil pressure shutdown	0-4bar (1.03bar)
	High Temperature warning	Coolant temp pre-alarm	80-140°C (110°C)
	High Temperature shutdown	Coolant temp shutdown	80-140°C (120°C)
	Low Coolant Temperature	Low Coolant Temperature	65-136°C (65°C)
Timers	Generator transient delay	Gen transient delay	0-10s (0s)
	Start delay	Start delay	0-60m (5s)
	Return delay	Return delay	0-60m (30s)
	Preheat	Preheat	0-60m (5s)
	Crank attempt	Cranking time	0-60s (10s)
	Crank rest	Crank rest	0-60s (10s)
	Safety delay	Safety on delay	0-30s (10s)
	Overspeed overshoot	Overspeed overshoot	0-10s (0s)
	Warming up	Warm up	0-60m (0s)
	Cooling run	Cooling	0-60m (60s)
	Fail to stop delay	Fail to stop	0-30s (30s)
	Low battery volts delay	Battery low delay	0-10m (1m)
	High battery volts delay	Battery high delay	0-10m (1m)
	Generator	Generator Under voltage shutdown	Gen low voltage shutdown
Generator Under voltage prealarm		Gen low voltage pre-alarm	50-360V ph-N (196V)
Generator Over voltage prealarm		Gen high voltage pre-alarm	50-360V ph-N (253V)
Generator Over voltage shutdown		Gen high voltage shutdown	50-360V ph-N (265V)
Generator Under frequency shutdown		Gen low frequency shutdown	0-75Hz (40Hz)
Generator Under frequency prealarm		Gen low frequency pre-alarm	0-75Hz (42Hz)
Generator Over frequency prealarm		Gen high frequency pre-alarm	0-75Hz (55Hz)
Generator Over frequency shutdown		Gen high frequency shutdown	0-75Hz (57Hz)
Generator delayed overcurrent	Delayed high current	100-200% (100%)	
Engine	Underspeed (RPM) shutdown	Underspeed shutdown	0-6000RPM (1270)
	Underspeed (RPM) warning	Underspeed pre-alarm	0-6000RPM (1350)
	Overspeed (RPM) warning	Overspeed pre-alarm	0-6000RPM (1650)
	Overspeed (RPM) shutdown	Overspeed shutdown	0-6000RPM (1710)
	Overspeed overshoot %	Overspeed overshoot percent	0-10 (0%)
	Low DC Voltage	Battery low warning	0-24V (8V)
	High DC Voltage	Battery high warning	0-24V (33V)
	Charge Alternator Failure	Charge fail warning	0-24V (6V)
Display	Language	Language	ENGLISH, OTHER (see note below)
Application	Engine speed selection	Alternative Frequency	Disable, Enable
	Volts selection	Alternative Voltage	Disable, Enable
	Wiring topography	AC System	3 phase 4 wire Single phase, 2 wire 3 phase, 3 wire 2 phase 3 wire (L1 & L2) 2 phase 3 wire (L1 & L3)
	Full load current rating	Generator Full Load	5A - 6000A (500A)
	Droop		Disable, Enable
	Droop %		0% - 5%
	LCD Contrast	Contrast	<input type="checkbox"/> <input type="checkbox"/> <input type="checkbox"/> <input type="checkbox"/> <input type="checkbox"/> <input type="checkbox"/> <input type="checkbox"/> <input type="checkbox"/> <input type="checkbox"/> <input type="checkbox"/>
	Date/Time	Date and Time	dd mmm yyyy hh:mm

NOTE:- Display language selection via the modules front panel configuration editor is between English and a PC configurable language. This 'other' language is configurable using the 5xxx PC configuration software in conjunction with the P810 interface.

NOTE:- Droop percent is only applicable to CAN controlled engines when CAN is enabled in the 5300 series controller.

6.2.2 LIST OF ADJUSTABLE PARAMETERS IN 'APPLICATION EDITOR'

Section	Parameter	Display shows	Values
Application	Engine speed selection	Al ternati ve Frequency	Disable , Enable
	Volts selection	Al ternati ve Vol tage	Disable , Enable
	Wiring topography	AC System	3 phase 4 wire Single phase, 2 wire 3 phase, 3 wire 2 phase 3 wire (L1 & L2) 2 phase 3 wire (L1 & L3)
	Full load current rating	Generator Full Load	5A - 6000A (500A)
	Droop		Disable , Enable
	Droop %		0% - 5%
	LCD Contrast	Contrast	<input type="checkbox"/> <input checked="" type="checkbox"/>
	Date/Time	Date and Time	dd mmm yyyy hh:mm



6.2.3 EDITING THE CURRENT DATE AND TIME

The date and time can be set either using the 5xxx series configuration software or the front panel configuration editor.

NOTE:- The 5320 controller maintains the current date and time so long as it is connected to a DC supply within the operating range. Disconnection of the supply will result in the date and time being frozen until the module's power is reapplied. When this occurs, the date and time will resume operation from the time the power was disconnected. If this occurs you can use the front panel configuration editor to correct the date and time or reset it using the 5xxx series configuration software.

NOTE:- The calendar is used by the 5310's run scheduler and the event log.



Press the Stop/Reset  and Info  buttons simultaneously.

If the module PIN number has been set, the PIN number request is then shown. The configuration cannot be viewed or changed until the PIN number is correctly entered. (see the section ACCESSING THE FRONT PANEL CONFIGURATION EDITOR)

Press the + button until the desired page is shown. Date and time

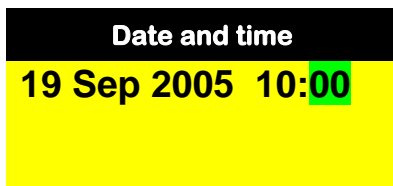

To edit the Date and time, press the  button, the minutes will start to flash. Pressing the + or - buttons will adjust the minutes to the desired value.

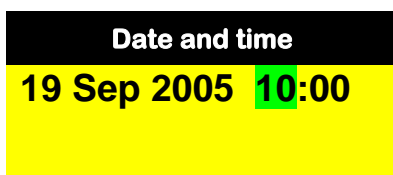

Press the  button to 'save' the value, and select the hours for adjustment. The hours will start to flash.

Pressing the + or - buttons will adjust the hours to the desired value.



Press the  button to 'save' the value, and select the day for adjustment. The day will start to flash.

Pressing the + or - buttons will adjust the day to the desired value.

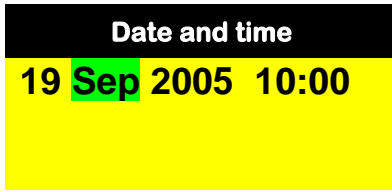

Press the  button to 'save' the value, and select the month for adjustment. The month will start to flash.

Pressing the + or - buttons will adjust the month to the desired value.

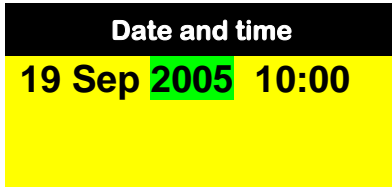

Press the  button to 'save' the value, and select the year for adjustment. The year will start to flash.

Pressing the + or - buttons will adjust the year to the desired value.



Press the  button to 'save' the values.

 **NOTE:-** To exit the front panel configuration editor at any time, press the Stop/Reset  button. Ensure you have saved any changes you have made by pressing the  button first.

Continuing to press the + or - buttons will cycle through the adjustable parameters in the order shown overleaf:

7 INSTALLATION INSTRUCTIONS

The model DSE 5310 Module has been designed for front panel mounting. Fixing is by 4 clips for easy assembly.

7.1 PANEL CUT-OUT

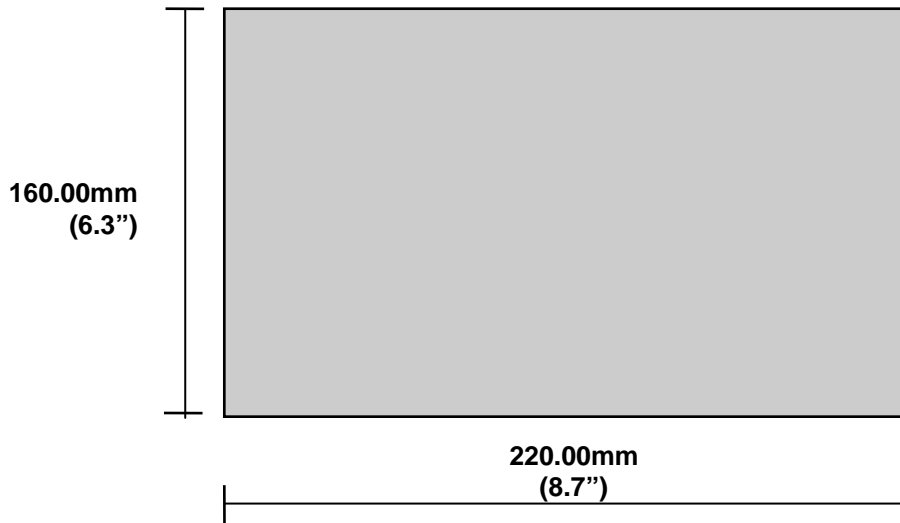

FIG 3

Maximum panel thickness – 8mm (0.3")

In conditions of excessive vibration the module should be mounted on suitable anti-vibration mountings.

7.2 COOLING

The module has been designed to operate over a wide temperature range **-30 to +70° C**. Allowances should be made for the temperature rise within the control panel enclosure. Care should be taken **NOT** to mount possible heat sources near the module unless adequate ventilation is provided. The relative humidity inside the control panel enclosure should not exceed **95%**.

7.3 UNIT DIMENSIONS

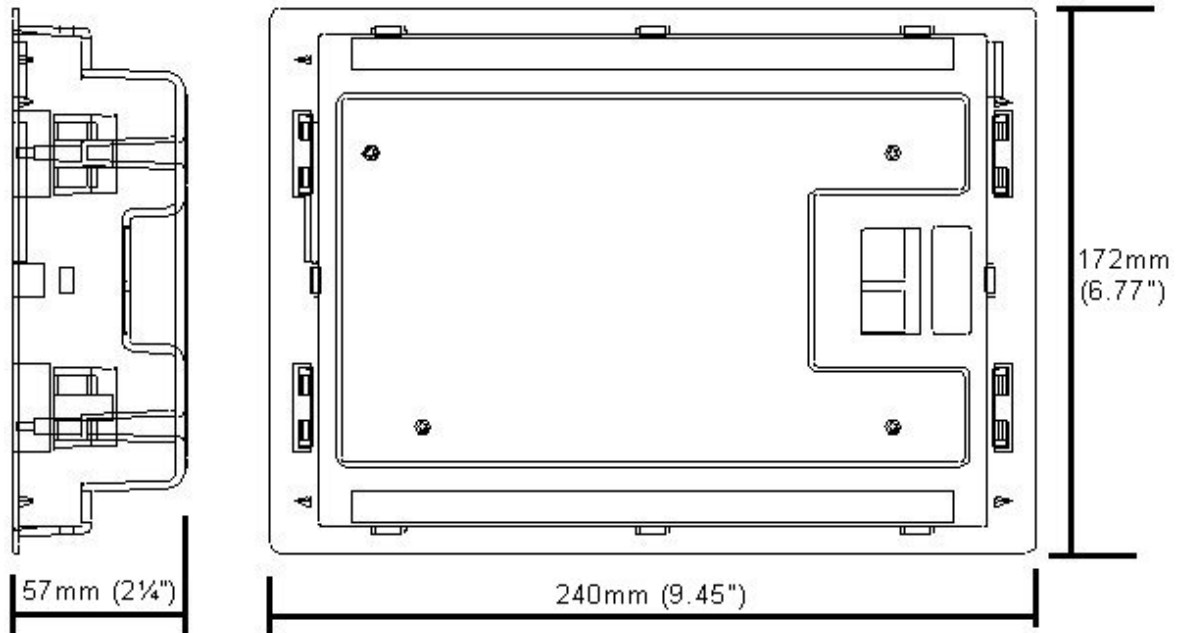

Panel cutout 220mm x 160mm (8.7" x 6.3")

FIG 4

7.4 FRONT PANEL LAYOUT



FIG 5

7.5 REAR PANEL LAYOUT

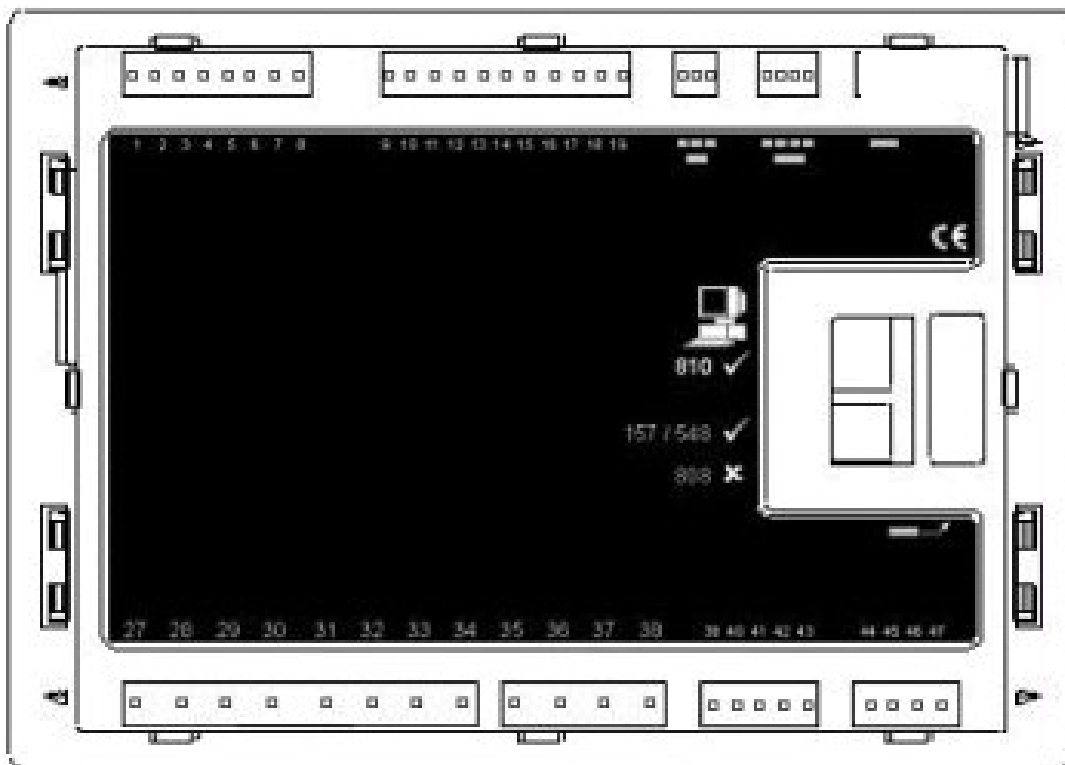

FIG 6

8 ELECTRICAL CONNECTIONS

Connections to the Module are via plug and sockets.

8.1 CONNECTION DETAILS

The following describes the connections and recommended cable sizes to the 7 plugs and sockets on the rear of the Module. See rear panel layout **FIG 6**.

8.1.1 PLUG "A" 8 WAY

PIN No	DESCRIPTION	CABLE SIZE	NOTES
1	DC Plant Supply Input (Negative)	2.5mm ² AWG 13	
2	DC Plant Supply Input (Positive)	2.5 mm ² AWG 13	(Recommended Maximum Fuse 21A)
3	Emergency Stop Input	2.5mm ² AWG 13	Plant Supply Positive. Also supplies fuel & start outputs. (Recommended Maximum Fuse 32A)
4	Fuel relay Output	2.5mm ² AWG 13	Plant Supply Positive from pin 3. 16 Amp rated.
5	Start relay Output	2.5mm ² AWG 13	Plant Supply Positive from pin 3. 16 Amp rated.
6	Auxiliary Output relay 1	1.0mm ² AWG 18	Plant Supply Positive. 5 Amp rated.
7	Auxiliary Output relay 2	1.0mm ² AWG 18	Plant Supply Positive. 5 Amp rated.
8	Auxiliary Output relay 3	1.0mm ² AWG 18	Plant Supply Positive. 5 Amp rated.

NOTE:- When the module is configured for CAN operation, FUEL, START and AUXILIARY output requirements may be different. Refer to CAN and DSE Wiring for further information.

8.1.2 PLUG "B" 11 WAY

PIN No	DESCRIPTION	CABLE SIZE	NOTES
9	Charge fail / excite	2.5mm ² AWG 13	Do not connect to ground (battery Negative)
10	Auxiliary input 1	0.5mm ² AWG 20	Switch to Negative
11	Auxiliary input 2	0.5mm ² AWG 20	Switch to Negative
12	Auxiliary input 3	0.5mm ² AWG 20	Switch to Negative
13	Auxiliary input 4	0.5mm ² AWG 20	Switch to Negative
14	Auxiliary input 5	0.5mm ² AWG 20	Switch to Negative
15	Auxiliary input 6	0.5mm ² AWG 20	Switch to Negative
16	Functional Earth	2.5mm ² AWG 13	Connect to a good clean earth point
17	Magnetic pickup Positive	0.5mm ² AWG 20	Connect to Magnetic Pickup device
18	Magnetic pickup Negative	0.5mm ² AWG 20	Connect to Magnetic Pickup device
19	Not connected	-	

 **NOTE:-** Ensure magnetic pickup screen is connected to ground at one end only.

 **NOTE:-** When the module is configured for CAN operation, terminals 17 & 18 should be left unconnected. Engine speed is transmitted to the 53xx controller on the CAN link. Refer to CAN and DSE Wiring for further information.

8.1.3 PLUG "C" 3 WAY

PIN No	DESCRIPTION	CABLE SIZE	NOTES
20	CAN port Common	0.5mm ² AWG 20	Use only 120Ω CAN approved cable
21	CAN port H	0.5mm ² AWG 20	Use only 120Ω CAN approved cable
22	CAN port L	0.5mm ² AWG 20	Use only 120Ω CAN approved cable

 **NOTE:-** Screened 120Ω impedance cable specified for use with CANBUS must be used. DSE stock and supply Belden cable 9841 which is a high quality 120Ω impedance cable suitable for CANbus use (DSE part number 016-030) Refer to CAN and DSE Wiring for further information.

8.1.4 PLUG "D" 4 WAY (OPTIONAL)

PIN No	DESCRIPTION	CABLE SIZE	NOTES
23	RS485 port Common	0.5mm ² AWG 20	Use only 120Ω RS485 approved cable
24	RS485 port B	0.5mm ² AWG 20	Use only 120Ω RS485 approved cable
25	RS485 port A	0.5mm ² AWG 20	Use only 120Ω RS485 approved cable
26	Not connected	-	

NOTE: - Screened 120Ω impedance cable specified for use with RS485 must be used. DSE stock and supply Belden cable 9841 which is a high quality 120Ω impedance cable suitable for RS485 use (DSE part number 016-030)

NOTE: - Connector E is not fitted to the 5310 remote start module.

8.1.5 PLUG "F" 4 WAY

PIN No	DESCRIPTION	CABLE SIZE	NOTES
35	Generator L1 voltage monitoring input	1.0mm ² AWG 18	Connect to generator L1 output (AC) (Recommend 2A fuse)
36	Generator L2 voltage monitoring input	1.0mm ² AWG 18	Connect to generator L2 output (AC) (Recommend 2A fuse)
37	Generator L3 voltage monitoring input	1.0mm ² AWG 18	Connect to generator L3 output (AC) (Recommend 2A fuse)
38	Generator Neutral input	1.0mm ² AWG 18	Connect to generator Neutral terminal (AC)

8.1.6 PLUG "G" 5 WAY

PIN No	DESCRIPTION	CABLE SIZE	NOTES
39	CT Secondary for L1	2.5mm ² AWG 13	Connect to secondary of L1 monitoring CT
40	CT Secondary for L2	2.5mm ² AWG 13	Connect to secondary of L2 monitoring CT
41	CT Secondary for L3	2.5mm ² AWG 13	Connect to secondary of L3 monitoring CT
42	CT secondary common	2.5mm ² AWG 13	Connect to secondary of all monitoring CT's
43	Not connected	-	

WARNING! - Do not disconnect this plug when the generator set is running. Disconnection will open circuit the secondary of the CT's and dangerous voltages may then develop. Always ensure the generating set is at rest before making or breaking connections to the module.

8.1.7 PLUG “H” 4 WAY

PIN No	DESCRIPTION	CABLE SIZE	NOTES
44	Oil Pressure Input	0.5mm ² AWG 20	Connect to Oil pressure sender
45	Coolant Temperature Input	0.5mm ² AWG 20	Connect to Coolant Temperature sender
46	Fuel Level input	0.5mm ² AWG 20	Connect to Fuel Level sender
47	Sender Common Return	0.5mm ² AWG 20	Return feed for senders*.

NOTE*:- If using single terminal senders refer to connection diagram. If using earth return type senders connect return terminals to pin 47 and also connect pin 47 to earth. This is detailed in the Appendix section entitled “Sender wiring recommendations” elsewhere in this manual.

NOTE:- When the module is configured for CAN operation, terminals 44 & 45 should be left unconnected. Engine oil pressure and coolant temperature is transmitted to the 53xx controller on the CAN link.

8.1.8 PC CONFIGURATION INTERFACE CONNECTOR



8-way connector allows connection to PC via the 810 configuration interface. Module can then be re-configured utilising the **5xxx series configuration software**.

8.1.9 EXPANSION OUTPUT CONNECTOR



The expansion connector allows connection to the 157 relay expansion module or to the 548 LED Remote annunciator module.

8.2 CONNECTOR FUNCTION DETAILS

The following describes the functions of the 7 connectors on the rear of the module. See rear panel layout **FIG 5**.

8.2.1 PLUG "A" 8 WAY

PIN No	DESCRIPTION
1	DC Supply Negative input. (Battery Negative).
2	DC Supply Positive input. (Battery Positive).
3	Emergency Stop input. Internally linked to Starter and Fuel outputs. If this input is not connected to positive the module will be locked out, and if the engine is running it will shutdown immediately. The Positive Supply is also removed from Starter and Fuel outputs, therefore only a single pole Emergency Shutdown button is required.
4	Fuel Relay output. Plant Supply Positive from pin 3. Used to control the fuel solenoid or engine fuel control system.
5	Starter Relay output. Plant Supply Positive from pin 3. Used to control the Starter Motor.
6	Auxiliary Relay output 1. Plant Supply Positive. Configurable output, see Calibration Manual for options available.
7	Auxiliary Relay output 2. Plant Supply Positive. Configurable output, see Calibration Manual for options available.
8	Auxiliary Relay output 3. Plant Supply Positive. Configurable output, see Calibration Manual for options available.

8.2.2 PLUG "B" 11 WAY

PIN No	DESCRIPTION
9	Charge Fail input / Excitation output. Supplies excitation to the Plant Battery Charging Alternator, also an input for the Charge Fail detection circuitry.
10	Auxiliary input 1. This is a negative switched configurable input, see Calibration Manual for options available. It is possible to configure the input to be a normally closed signal or a normally open signal.
11	Auxiliary input 2. This is a negative switched configurable input, see Calibration Manual for options available. It is possible to configure the input to be a normally closed signal or a normally open signal.
12	Auxiliary input 3. This is a negative switched configurable input, see Calibration Manual for options available. It is possible to configure the input to be a normally closed signal or a normally open signal.
13	Auxiliary input 4. This is a negative switched configurable input, see Calibration Manual for options available. It is possible to configure the input to be a normally closed signal or a normally open signal.
14	Auxiliary input 5. This is a negative switched configurable input, see Calibration Manual for options available. It is possible to configure the input to be a normally closed signal or a normally open signal.
15	Auxiliary input 6. This is a negative switched configurable input, see Calibration Manual for options available. It is possible to configure the input to be a normally closed signal or a normally open signal.
16	Functional Earth - Ensure connection to a good clean earth point.
17	Magnetic Input Positive. An AC signal from the magnetic pickup Positive for speed sensing.
18	Magnetic Input Negative. An AC signal from the magnetic pickup Negative for speed sensing.
19	Not connected

 **NOTE:** - Ensure magnetic pickup screen is connected to ground at one end only.

▲NOTE: - When the module is configured for CAN operation, terminals 17 & 18 should be left unconnected. Engine speed is transmitted to the 53xx controller on the CAN link.

8.2.3 PLUG “C” 3 WAY

PIN No	DESCRIPTION
20	CAN port Common. Do not connect this terminal to earth. Use only screened 120Ω cable approved specifically for use in CAN applications.
21	CAN port H. Use only screened 120Ω cable approved specifically for use in CAN applications.
22	CAN port L. Use only screened 120Ω cable approved specifically for use in CAN applications.

▲NOTE:- Screened 120Ω impedance cable specified for use with CANBUS must be used. DSE stock and supply Belden cable 9841 which is a high quality 120Ω impedance cable suitable for CANbus use (DSE part number 016-030)

8.2.4 PLUG “D” 4 WAY (OPTIONAL)

PIN No	DESCRIPTION
23	RS485 port Common
24	RS485 port B. Use only screened 120Ω cable approved specifically for use in RS485 applications.
25	RS485 port A. Use only screened 120Ω cable approved specifically for use in RS485 applications.
26	Not used. Do not connect to this terminal.

▲NOTE:- Screened 120Ω impedance cable specified for use with RS485 must be used. DSE stock and supply Belden cable 9841 which is a high quality 120Ω impedance cable suitable for RS485 use (DSE part number 016-030)

▲NOTE: - Connector E is not fitted to the 5310 remote start module.

8.2.5 PLUG “F” 4 WAY

PIN No	DESCRIPTION
35	Generator L1 sensing input. Connect to alternator L1 output.
36	Generator L2 sensing input. Connect to alternator L2 output. If using single phase only do not connect this terminal.
37	Generator L3 sensing input. Connect to alternator L3 output. If using single phase only do not connect this terminal.
38	Generator N sensing input. Connect to alternator N output.

8.2.6 PLUG "G" 5 WAY

PIN No	DESCRIPTION
39	Generator L1 current transformer connection.
40	Generator L2 current transformer connection. If single phase is used do not connect this pin.
41	Generator L3 current transformer connection. If single phase is used do not connect this pin.
42	Generator current transformer common connection and CT earth connection.
43	Not used. Do not connect to this terminal.



WARNING! - Do not disconnect this plug when the generator set is running. Disconnection will open circuit the secondary of the CT's and dangerous voltages may then develop. Always ensure the generating set is at rest before making or breaking connections to the module.

8.2.7 PLUG "H" 4 WAY

PIN No	DESCRIPTION
44	Oil Pressure sensing input. Connect to resistive type oil pressure sender. Refer to connection diagram for details.
45	Coolant Temperature sensing input. Connect to resistive type coolant temperature sender. Refer to connection diagram for details.
46	Fuel Level sensing input. Connect to resistive type fuel level sender. Refer to connection diagram for details.
47	Sender Common connection. Return feed from sender units - refer to connection diagram for details.



NOTE:- When the module is configured for CAN operation, terminals 44 & 45 should be left unconnected. Engine oil pressure and coolant temperature is transmitted to the 53xx controller on the CAN link.

8.2.8 PURCHASING ADDITIONAL CONNECTOR PLUGS FROM DSE

If you require additional plugs from DSE, please contact our Sales department using the part numbers below.







5310 Terminal	Connector	Plug description	DSE Part number
1-8	A	BL08 8way 5.08mm spacing connector plug	007-125
9-19	B	BL11 11way 5.08mm spacing connector plug	007-135
20-22	C	BL03 3way 3.81mm spacing connector plug	007-409
23-26	D	BL04 4way 3.81mm spacing connector plug	007-408
35-38	F	BL04 4way 10.16mm spacing connector plug	007-003
39-43	G	BL05 5way 5.08mm spacing connector plug	007-329
44-47	H	BL04 4way 5.08mm spacing connector plug	007-100



NOTE:- Plug E is not fitted to this module.

9 SPECIFICATION

DC Supply	Continuous voltage rating : 8V to 35V
	Cranking dip protection : Able to survive 0V for 50mS, providing supply was at least 10V before dropout and supply recovers to 5V. This is achieved without the need for internal batteries
	Charge Fail/ Excitation: 0V to 35V fixed power source 25W
	Max. Standby Current: 250mA at 12V. 125mA at 24V.
	Max. Sleep Mode Current: 75mA at 12V. 45mA at 24V
	Max. Operating Current: 425mA at 12V. 215mA at 24V
Alternator Input	Range: 15V - 277(ph-N) (+20%) 50Hz - 60Hz (Minimum 15V AC Ph-N)
	Accuracy: 1% of full scale Average sensing
	Supported topologies: 3 Phase 4 wire 3 phase 3 wire Single phase 2 wire 2 Phase 3 wire L1 & L2 2 Phase 3 wire L1 & L3
Bus Input	Range: 15V - 277(ph-N) (+20%) 50Hz - 60 Hz
	Accuracy: 1% of full scale Average sensing
	Supported topologies: 3 Phase 4 wire 3 phase 3 wire Single phase 2 wire 2 Phase 3 wire L1 & L2 2 Phase 3 wire L1 & L3
CT's	Burden: 0.5VA
	Primary rating: 1A - 6000A (user selectable)
	Secondary rating: 1A or 5A secondary (user selectable)
	Accuracy of measurement: 1% of full load rating (when using 0.5% or better CTs with 5A secondary winding) Lower class CTs will reduce the overall accuracy of the reading.
	Recommendations: Class 1 required for instrumentation Protection class required if using for protection.
Magnetic Pickup	Voltage range : +/- 0.5V minimum (during cranking) to 70V Peak
	Frequency range: 10,000 Hz (max)
Relay outputs	Fuel: 16 Amp DC at supply voltage
	Start: 16 Amp DC at supply voltage
	Auxiliary outputs 1,2,3: 5 Amp DC at supply voltage
	Output 4 (Generator loading relay) Voltage free, normally open, 8 Amp 250V AC RMS rated
	Output 5 (spare) Voltage free, normally closed, 8 Amp 250V AC RMS rated

Dimensions	Overall: 240mm x 172 mm x 57mm (9 ½" x 6 ¾" x 2 ¼")		
	Panel cut-out: 220mm x 160mm (8.7" x 6.3") Max panel thickness 8mm (0.3")		
Electrical Safety /Electromagnetic Compatibility	BS EN 60950 Safety of information technology equipment, including electrical business equipment		
	BS EN 61000-6-2 EMC Generic Emission Standard (Industrial)		
	BS EN 61000-6-4 EMC Generic Emission Standard (Industrial)		
Environmental	BS EN 60068-2-1 Cold Temperature -30°C		
	BS EN 60068-2-2 Hot Temperature +70°C		
	BS2011-2-1 Humidity 93% RH@40°C for 48 Hours		
	BS EN 60068-2-6 Vibration 10 sweeps at 1 octave/minute in each of 3 major axes 5Hz to 8Hz @ +/-7.5mm constant displacement 8Hz to 500Hz @ 2gn constant acceleration		
	BS EN 60068-2-27 Shock 3 Half sine shocks in each of 3 major axes 15gn amplitude, 11mS duration		
	BS EN 60529 Degrees of protection provided by enclosures: IP55 (Front of module when module is installed into the control panel with the optional sealing gasket). IP42 (front of module when module is installed into the control panel WITHOUT being sealed to the panel)		
	NEMA Rating (Approximate) 12 (Front of module when module is installed into the control panel with the optional sealing gasket). 2 (front of module when module is installed into the control panel WITHOUT being sealed to the panel)		
Product Certification	 European CE approved.	 UL approved C-UL / CSA approved.	 Russia and other CIS countries approved
	 BS EN 2002/95/EC Restriction of Hazardous Substances (RoHS)	 BS EN 2002/96/EC Waste Electrical and Electronic Equipment (WEEE)	 CAN interface certified by MTU for use with MDEC engines
Relevant Company Certification	 BS EN ISO 9001:2000 Applicable to Design, marketing, assembly, service and repair of electronic control modules		

In line with our policy of continual development, Deep Sea Electronics, reserve the right to change specification without notice.

10 COMMISSIONING

10.1.1 PRE-COMMISSIONING

Before the system is started, it is recommended that the following checks are made:-

- 10.1. The unit is adequately cooled and all the wiring to the module is of a standard and rating compatible with the system.
- 10.2. The unit **DC** supply is fused and connected to the battery and that it is of the correct polarity.
- 10.3. The Emergency Stop input is wired to an external normally closed switch connected to **DC** positive.

NOTE:- If Emergency Stop feature is not required, link this input to the DC Positive. The module will not operate unless either the Emergency Stop is fitted correctly OR Pin 3 is connected to DC positive.

- 10.4. To check the start cycle operation take appropriate measures to prevent the engine from starting (disable the operation of the fuel solenoid). After a visual inspection to ensure it is safe to proceed, connect the battery supply. Select "**MANUAL**", the unit start sequence will commence.
- 10.5. The starter will engage and operate for the pre-set crank period. After the starter motor has attempted to start the engine for the pre-set number of attempts the LCD will display '*Failed to start*'. Select the **STOP/RESET** position to reset the unit.
- 10.6. Restore the engine to operational status (reconnect the fuel solenoid), again select "**MANUAL**", this time the engine should start and the starter motor should disengage automatically. If not then check that the engine is fully operational (fuel available, etc.) and that the fuel solenoid is operating. The engine should now run up to operating speed. If not, and an alarm is present, check the alarm condition for validity, then check input wiring. The engine should continue to run for an indefinite period. It will be possible at this time to view the engine and alternator parameters - refer to the 'Description of Controls' section of this manual.
- 10.7. Select "**AUTO**" on the front panel, the engine will run for the pre-set cooling down period, then stop. The generator should stay in the standby mode. If not check that there is not a signal present on the **Remote start** input.
- 10.8. Initiate an automatic start by supplying the remote start signal. The start sequence will commence and the engine will run up to operational speed. Once the generator is available a load transfer will take place, the Generator will accept the load. If not, check the wiring to the Generator Contactor Coil (*if used*). Check the Warming timer has timed out.
- 10.9. Remove the remote start signal, the return sequence will start. After the pre-set time period, the load will be removed from the generator. The generator will then run for the pre-set cooling down period, then shutdown into it's standby mode.
- 10.10. Set the modules internal clock/calendar to ensure correct operation of the scheduler and event logging functions. For details of this procedure see section entitled *Front Panel Configuration – Editing the date and time*.
- 10.11. If, despite repeated checking of the connections between the **5310** and the customer's system, satisfactory operation cannot be achieved, then the customer is requested to contact the factory for further advice on:-

INTERNATIONAL TEL: +44 (0) 1723 890099

INTERNATIONAL FAX: +44 (0) 1723 893303

E-mail: Support@Deepseapl.com



Website : www.deepseapl.com

11 FAULT FINDING

SYMPTOM	POSSIBLE REMEDY
Unit is inoperative	Check the battery and wiring to the unit. Check the DC supply. Check the DC fuse.
Unit shuts down	Check DC supply voltage is not above 35 Volts or below 9 Volts Check the operating temperature is not above 70 °C. Check the DC fuse.
Unit locks out on Emergency Stop	If an Emergency Stop Switch is not fitted, ensure that a positive is connected to the Emergency Stop input. Check emergency stop switch is functioning correctly. Check Wiring is not open circuit.
Intermittent Magnetic Pick-up sensor fault	Ensure that Magnetic pick-up screen is only connected at one end, if connected at both ends, this enables the screen to act as an aerial and will pick up random voltages.
Low oil Pressure fault operates after engine has fired	Check engine oil pressure. Check oil pressure switch/sender and wiring. Check configured polarity (if applicable) is correct (i.e. Normally Open or Normally Closed) or that sender is compatible with the 5310 Module and is correctly configured.
High engine temperature fault operates after engine has fired.	Check engine temperature. Check switch/sender and wiring. Check configured polarity (if applicable) is correct (i.e. Normally Open or Normally Closed) or that sender is compatible with the 5310 Module.
Shutdown fault operates	Check relevant switch and wiring of fault indicated on LCD display. Check configuration of input.
Warning fault operates	Check relevant switch and wiring of fault indicated on LCD display. Check configuration of input.
Fail to Start is activated after pre-set number of attempts to start	Check wiring of fuel solenoid. Check fuel. Check battery supply. Check battery supply is present on the Fuel output of the module. Check the speed sensing signal is present on the 5310 inputs. Refer to engine manual.
Continuous starting of generator when in AUTO	Check that there is no signal present on the "Remote Start" input. Check configured polarity is correct.
Generator fails to start on receipt of Remote Start signal.	Check Start Delay timer has timed out. If remote start fault, check signal is on "Remote Start" input. Confirm input is configured to be used as "Remote Start".
Pre-heat inoperative	Check wiring to engine heater plugs. Check battery supply. Check battery supply is present on the Pre-heat output of module. Check pre-heat has been selected in your configuration.
Starter motor inoperative	Check wiring to starter solenoid. Check battery supply. Check battery supply is present on the Starter output of module. Ensure that the Emergency Stop input is at Positive.
Engine runs but generator will not take load	Check Warm up timer has timed out. Ensure generator load inhibit signal is not present on the module inputs. Check connections to the switching device.
Incorrect reading on Engine gauges	Check engine is operating correctly. Check sender and wiring paying particular attention to the wiring to terminal 47 (refer to appendix). Check that sender is compatible with the 5310 Module and is correctly configured.

NOTE:- The above fault finding is provided as a guide check-list only. As it is possible for the module to be configured to provide a wide range of different features always refer to the source of your module configuration if in doubt.



12 FACTORY DEFAULT CONFIGURATION



In the tables below, the icon  indicates an item that can be adjusted from the module's front panel editor. Absence of the  icon beside an item means that adjustment of this parameter is only possible using the 5300 series configuration software in conjunction with the P810 interface. For further details on adjustment from the front panel editor, see the section entitled "Front panel configuration" elsewhere within this manual.

5300 series configuration software. Configuration for 5310 module.
 Filename – 5310a.XCF
 Printed on 25/10/05

Module settings	Value
Base module	5310 Remote start module

Miscellaneous settings	Value
Two lines of text (Configuration description)	Blank
Alternator fitted	Yes
Poles	4
Magnetic pickup fitted	No
CAN enabled	No
AC System	3 phase, 4 wire
VT Ratio	Disabled
Number of start attempts	3
Enable fast loading feature	No
Audible alarm prior to starting	No
Sleep when in stop mode	No
All warnings are latched	No

Input settings – Analogue Oil pressure	Value
Low oil pressure input type	VDO 10 bar
	Trip
	Return
Low oil pressure pre-alarm	 1.17 Bar 17.0 PSI 1.24 Bar 18.0 PSI
Low oil pressure shutdown	 1.03 Bar 14.9 PSI N/A

Input settings – Analogue Coolant temp	Value
High coolant temp input type	VDO 120 degrees C
	Trip
	Return
High coolant temp pre-alarm	 115°C 239°F 110°C 230°F
High coolant temp shutdown	 120°C 248°F N/A
Low coolant temp pre-alarm	 Disabled Disabled

Input settings – Analogue Fuel level	Value
Fuel level input type	Disabled

Input settings - Digital	Value
1 Remote start on load	Close to activate
2 Lamp test	Close to activate
3 User configured	Close to activate, Warning Active from safety on
4 User configured	Close to activate, Shutdown Always active
5 User configured	Close to activate, Shutdown Active from safety on
6 User configured	Close to activate, Electrical trip Always active



NOTE:- Inputs set to 'User configured' have an extra text box to allow the user to type in a description.

Output settings – Relay	Value
1 Energise	Preheat (during pre-heat timer)
2 Energise	Common alarm
3 Energise	Close generator

Output settings – Expansion A	Value
1 Energise	System in auto mode
2 Energise	Fail to start
3 Energise	Generator available
4 Energise	Delayed alarms armed
5 Energise	Combined under / over freq. shutdown
6 Energise	Combined under / over voltage shutdown
7 Energise	Cooling timer in progress
8 Energise	Mains failure

Output settings – Expansion B	Value
1 Energise	Output not used
2 Energise	Output not used
3 Energise	Output not used
4 Energise	Output not used
5 Energise	Output not used
6 Energise	Output not used
7 Energise	Output not used
8 Energise	Output not used

LED indicator settings	Value
1 Lit	Digital input 1 active
2 Lit	Digital input 2 active
3 Lit	System in auto mode
4 Lit	Common alarm

Timer settings		Value
Start delay	✘	5s
Pre-heat	✘	0s
Cranking time	✘	10s
Crank rest time	✘	10s
Smoke limit		0s
Smoke limit off		0s
Safety on delay	✘	10s
Overspeed overshoot	✘	2s
Warming up time	✘	0s
Breaker close pulse		0.5s
Breaker trip pulse		0.5s
Return delay	✘	30s
Cooling time	✘	1m
ETS solenoid hold		0s
Fail to stop delay	✘	30s
Generator transient delay	✘	0s
Battery low volts delay	✘	1m
Battery high volts delay	✘	1m
LCD page timer		5m

Generator settings – Voltage/frequency		Trip	Return
Under volts trip	✘	184V AC	N/A
Under volts pre-alarm	✘	196V AC	207V AC
Over volts pre-alarm	✘	265V AC	253V AC
Over volts trip	✘	276V AC	N/A
Under frequency trip	✘	40.0Hz	N/A
Under frequency pre-alarm	✘	42.0Hz	45.0Hz
Over frequency pre-alarm	✘	55.0Hz	52.0Hz
Over frequency trip	✘	57.0Hz	N/A
Drop	✘	Disabled	N/A
Drop %	✘	0.0%	N/A

Loading Voltage		207V Ph-N	
Loading Frequency		45.0 Hz	
Alternative voltage	✘	230v norm / 115v alt	Disabled on module
Alternative Frequency	✘	50Hz norm / 60Hz alt	Disabled on module

Generator settings – Current/power		Value
Generator CT primary		600A
Generator CT secondary		5A
CT location		Generator only
Generator full load rating	✘	500 A
Delayed overcurrent	✘	100% (500A)
Trip Curve		36

Engine settings – Crank disconnect		Value
Crank disconnect on generator frequency		21.0Hz
Crank disconnect oil pressure		<Disabled>
Check oil pressure prior to starting		Yes

Engine settings – speed		Value	
Underspeed trip	✘	1250 RPM	Disabled
Underspeed prealarm	✘	1350 RPM	Disabled
Overspeed prealarm	✘	1650 RPM	Disabled
Overspeed trip	✘	1750 RPM	Disabled
Overspeed overshoot	✘	0%	Disabled

Plant battery settings		Trip	Return
Under volts warning	✘	8.0V DC	9.0V DC
Over volts warning	✘	33.0 V DC	32.0V DC
Charge alternator warning	✘	6.0V DC	N/A

Exercise scheduler settings	Value
Enable exercise scheduler	No

Comms	Value
Site identity	
Genset ID	
Modem mode	No modem
Modem init (not auto answer)	E0S7=60S0=0&S0&C1&D3
Modem init (auto answer)	E0S7=60S0=2&S0&C1&D3
Modem Hang	H0
Master inactivity timeout	0
Slave ID	10 (Default)
Baud Rate	19200 (Default)

Languages		Value
Fixed Languages	✘	English (UK)
User configured languages		Not used

13 TYPICAL WIRING DIAGRAM

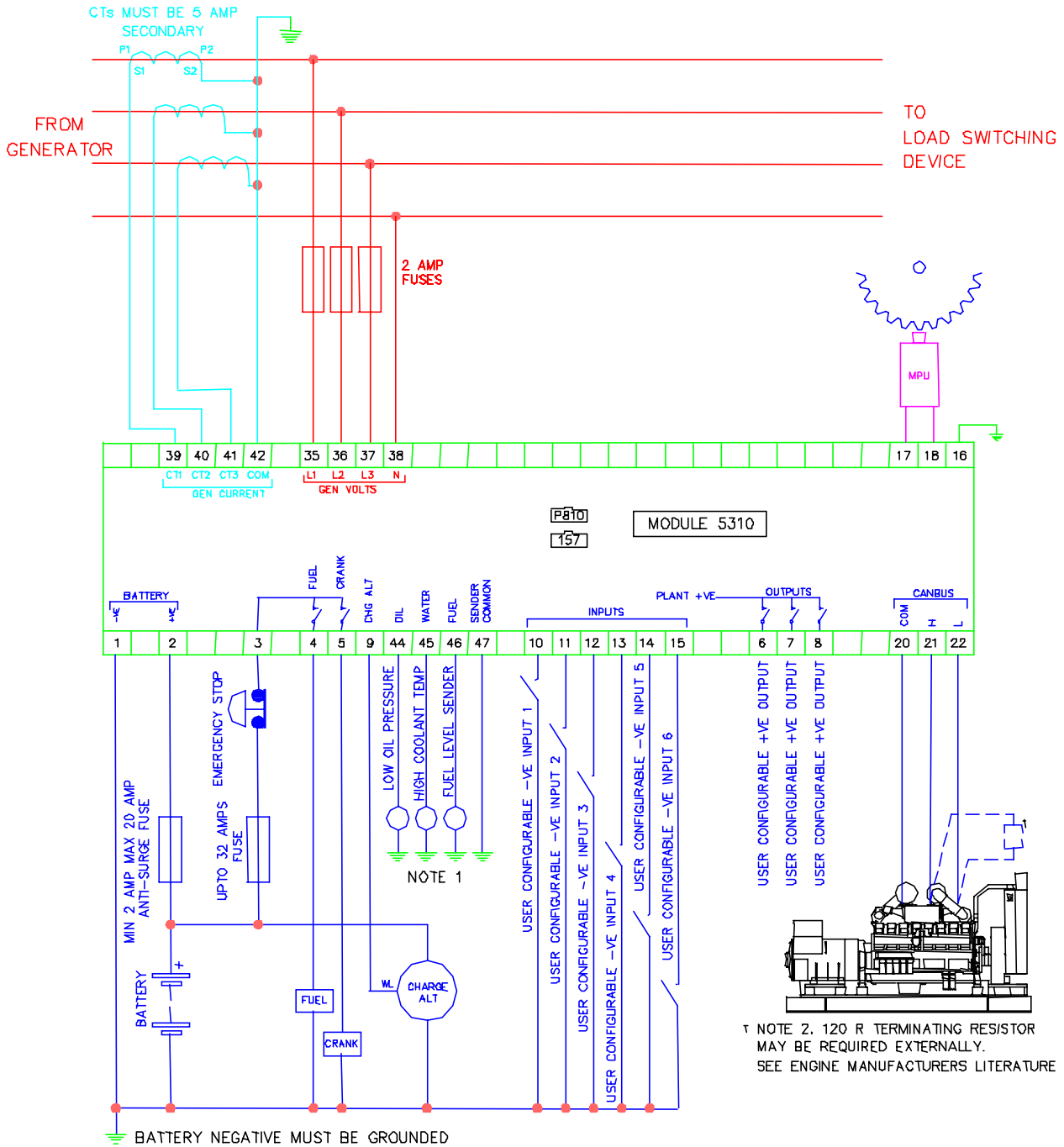

BATTERY NEGATIVE MUST BE GROUNDED
 TERMINALS SUITABLE FOR 22-16 AWG (0.6mm - 1.3mm) FIELD WIRING
 TIGHTENING TORQUE = 0.8Nm (7lb-in)

NOTE 1
 THESE GROUND CONNECTIONS MUST BE ON THE ENGINE BLOCK, AND MUST BE TO THE SENDER BODIES.
 THE GROUND WIRE TO TERMINAL 47 MUST NOT BE USED TO PROVIDE A GROUND CONNECTION TO ANY OTHER DEVICE

14 APPENDIX

14.1 ALTERNATIVE WIRING TOPOLOGIES

The 53xx series controllers can support many different wiring topologies (AC systems) to suit the many systems in use worldwide. The 'Typical connection diagram' details how to connect the module when used in a 3 phase, 4 wire system (3 phase star connected alternators). Changes to this typical wiring diagram for other AC systems are detailed below.

NOTE:- The factory default configuration for the 5310 module is for use with the 3 phase, 4 wire AC system. If another system is to be used, the controller must be reconfigured using the 5xxx series configuration software.

14.1.1 3 PHASE, 3 WIRE

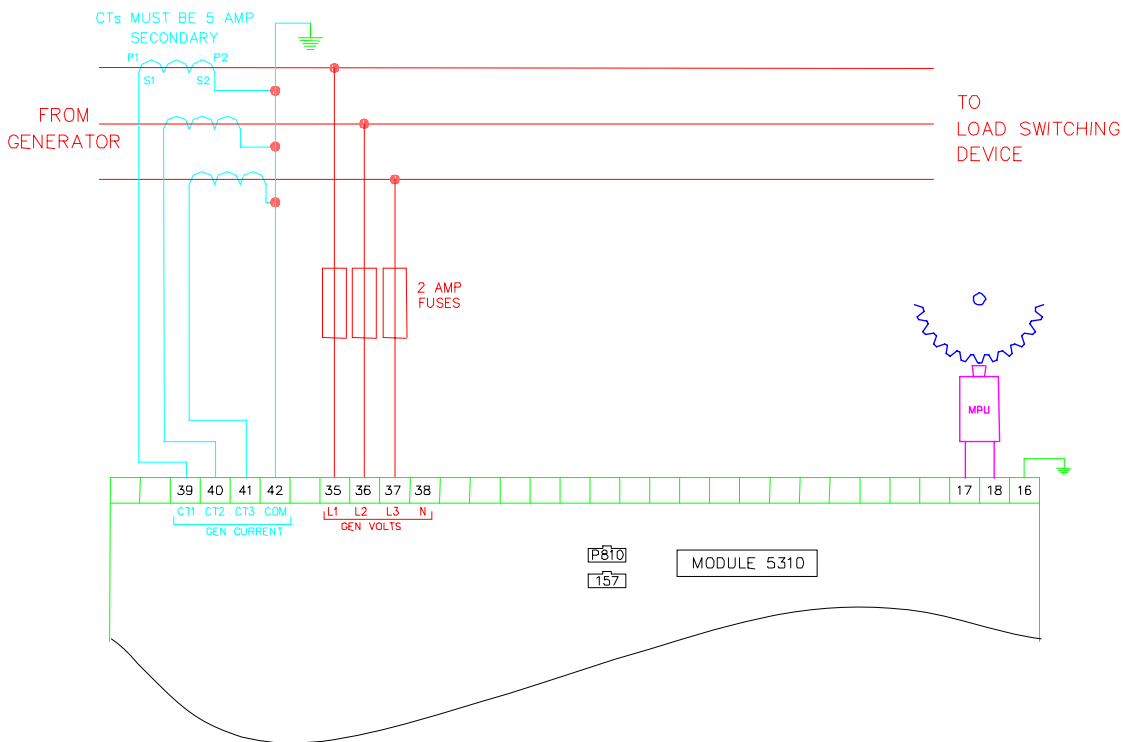

14.1.2 1 PHASE, 2 WIRE

Single phase alternator with neutral conductor.

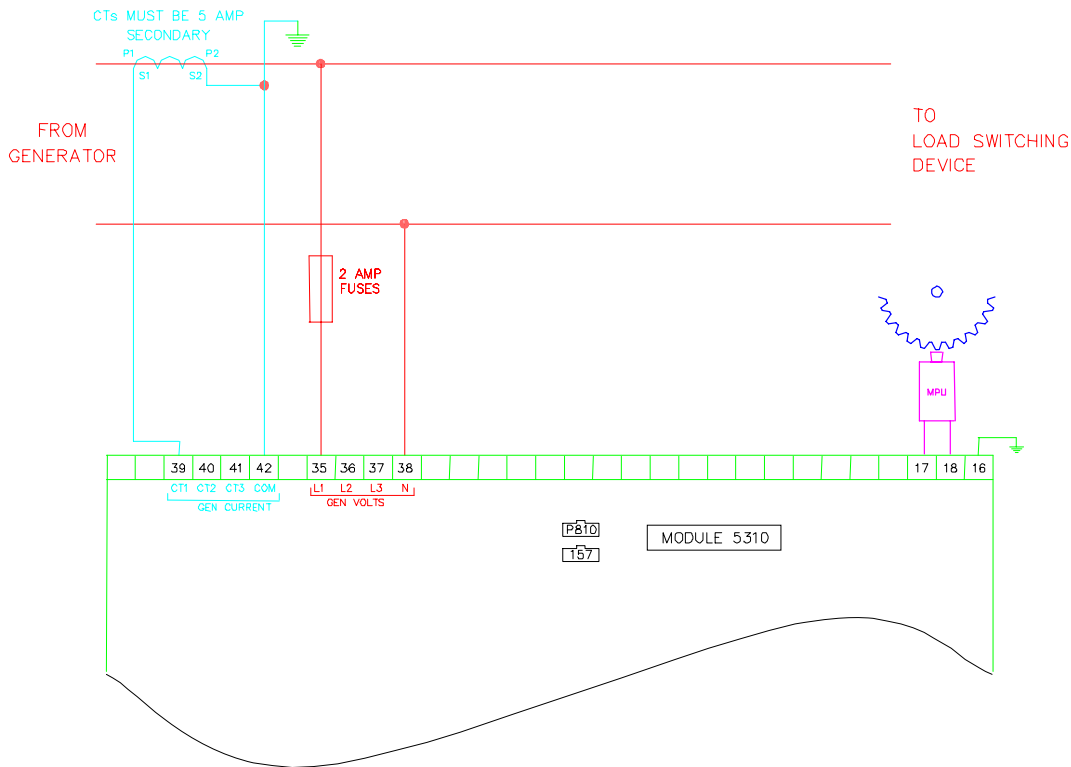





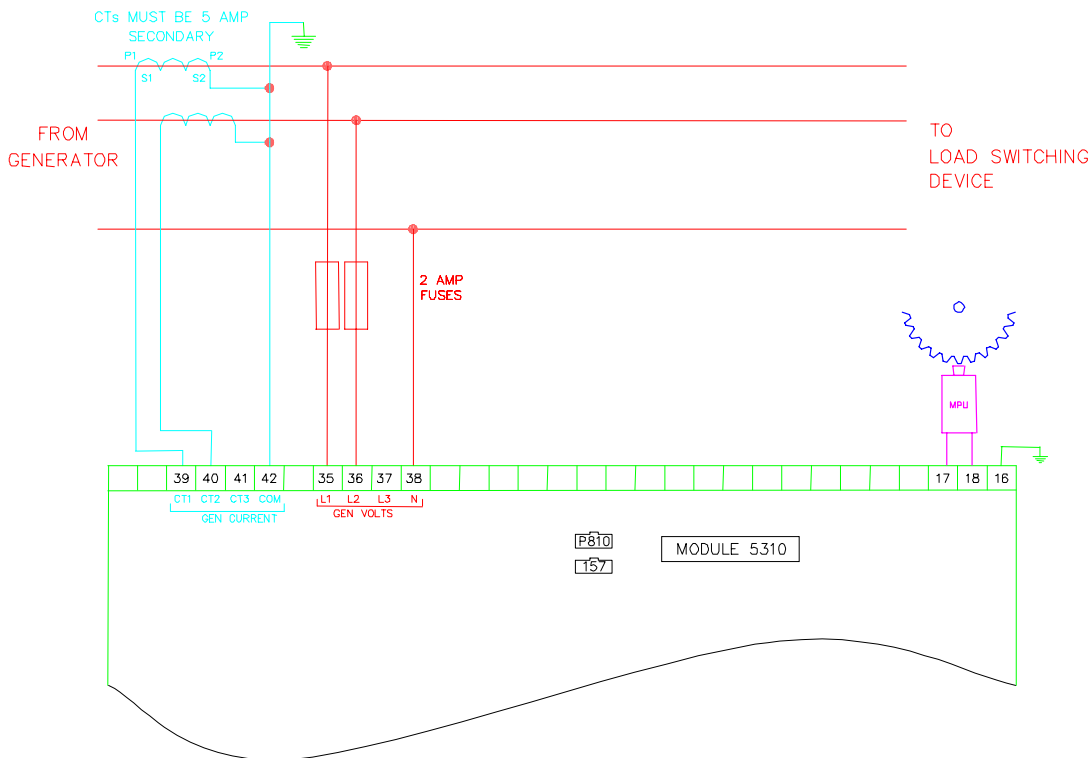

14.1.3 2 PHASE, 3 WIRE (2 PHASE CENTRE TAP NEUTRAL)

The alternator is 2 phase star connected. The live phases are separated by 180°



14.2 ICONS AND LCD IDENTIFICATION

14.2.1 PUSH BUTTONS

Display	Description	Display	Description	Display	Description
	Stop/Reset		Page scroll		Auto mode
	Scroll		Manual mode		Start (when in Manual or Test mode)
	Mute				

14.2.2 STATUS / MEASUREMENT UNITS

Display	Description	Display	Description	Display	Description
L1	Phase	L2	Phase	L3	Phase
L1- N	Phase - Neutral	L2- N	Phase - Neutral	L3- N	Phase - Neutral
L1- L2	Phase - Phase	L2- L3	Phase - Phase	L3- L1	Phase - Phase
BAR	Pressure	KPa	KPa Oil Pressure Units	PSI	Pressure
V	Voltage	°F	Temperature	Hz	Frequency
A	Amperes	°C	Temperature	RPM	Speed
kW	KiloWatts	kVA	Apparent power	CosØ	KW divided by kVA

14.2.3 LED INDICATION

Display	Description
	Generator available

14.3 5310 IDMT TRIPPING CURVES (TYPICAL)

5310 Delayed over-current protection

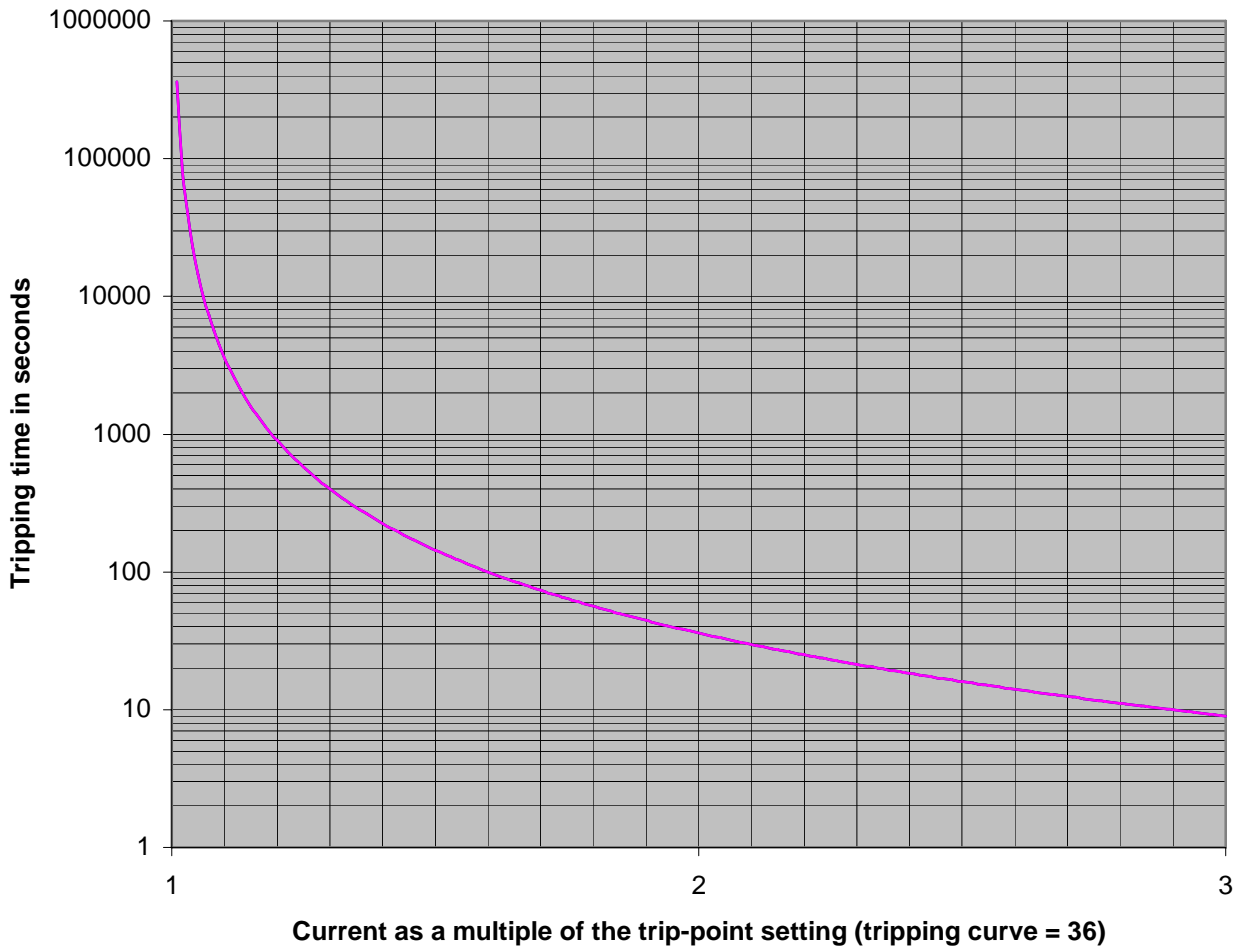

14.4 SENDER WIRING RECOMMENDATIONS

14.4.1 EARTH RETURN SENDERS

Connection Name	Terminal Number
Oil pressure Sender	44
Coolant temperature sender	45
Fuel level sender	46
Sender common	47

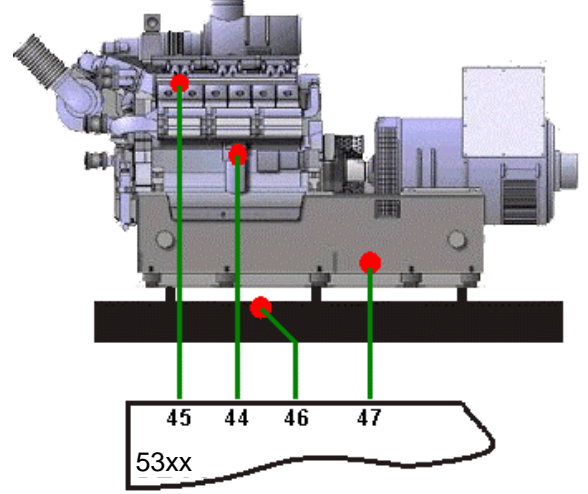

NOTE:- . It is important that terminal 47 (sender common) is soundly connected to an earth point on the **ENGINE BLOCK**, not within the control panel, and must be a sound electrical connection to the sender bodies.

NOTE:- . If you use PTFE insulating tape on the sender thread when using earth return senders, ensure you do not insulate the entire thread as this will prevent the sender body from being earthed via the engine block.

14.4.2 INSULATED RETURN SENDERS

Connection Name	Terminal Number
Oil pressure Sender	44
Coolant temperature sender	45
Fuel level sender	46
Sender common	47

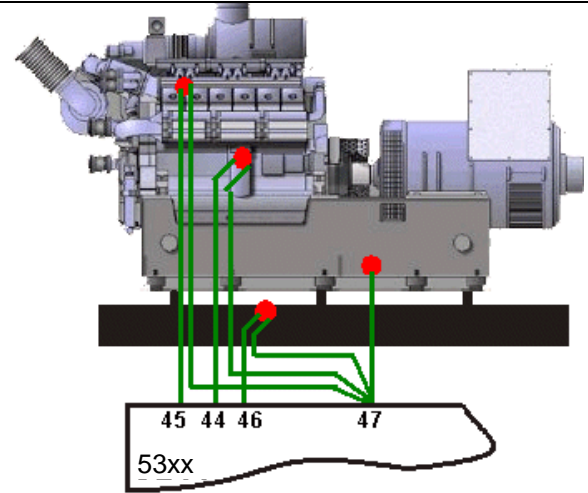

NOTE:- . It is important that terminal 47 (sender common) is soundly connected to an earth point on the **ENGINE BLOCK**, not within the control panel .

14.4.3 FUEL LEVEL SENDERS

The resistive fuel level senders supported by the 5300 series controllers are devices that translate fuel level into resistance. A change in fuel level translates directly to a change in the resistance of the sender. In the case of a parallel sided fuel tank, an accurate measure of the fuel level can easily be made, however as shown in the example below, this is not the case with non-parallel sided fuel tanks. Therefore it is recommended that only parallel sided fuel tanks are used to ensure correct fuel level detection.

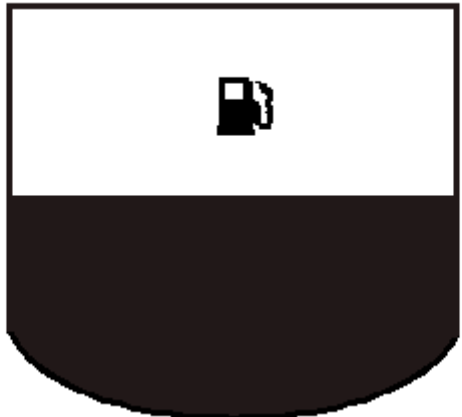
<p>Measured level</p> <p>100% —</p> <p>50% —</p> <p>0% —</p>  <p>Actual level</p> <p>100% —</p> <p>50% —</p> <p>0% —</p>	<p>The fuel sender measures the distance between the top of the tank and the fuel level. Typically, they use a ball float.</p> <p>In this example, the distance between the top of the tank and the level of the fuel is 50% of the height of the tank. The fuel level sender will report the tank correctly as being 50% full.</p> <p>For a parallel-sided tank like this one, 50% distance between the top of the tank and the level of the fuel will occur when the tank is 50% full of fuel.</p>
<p>Measured level</p> <p>100% —</p> <p>50% —</p> <p>0% —</p>  <p>Actual level</p> <p>100% —</p> <p>50% —</p> <p>0% —</p>	<p>In this example, the distance between the top of the tank and the level of the fuel is again 50% of the height of the tank, the fuel level sender will report the tank as being 50% full.</p> <p>However, as the bottom of the tank is curved, the actual amount of fuel in the tank is only about 40%. The fuel sender is incorrectly reporting the amount of remaining fuel.</p>

14.5 CAN INTERFACE



Modules are fitted with the CAN interface as standard and are capable of receiving engine data from engine CAN controllers compliant with the CAN standard.

CAN enabled engine controllers monitor the engines operating parameters such as engine speed, oil pressure, engine temperature (among others) in order to closely monitor and control the engine. The data that is gathered by the engine controller is then transmitted on an industry standard communications interface (CAN). This allows generator controllers such as the DSE 53xx range to access these engine parameters with no physical connection to the sensor device.

NOTE:- For further details for connections to CAN enabled engines refer to the manual CAN and DSE Wiring Part No. 057-004

14.6 OUTPUT EXPANSION

There are several methods of output expansion available for the 5xxx module:-

14.6.1 RELAY OUTPUT EXPANSION (157)

An expansion module is available, which connects to the configuration socket and enables the 53xx to use eight additional relays on the 157 relay module, providing Volt-free contacts for customer connection. A maximum of 2 off 157 relay modules can be connected, there are identified as 'A' and 'B' and give a total of 16 extra relay outputs.

Refer to technical data sheet on the 157 relay module for further details.

14.6.2 LED OUTPUT EXPANSION (548)

An expansion module is available, which connects to the configuration socket, and enables the 53xx to use eight additional LED's on the 548 module, providing remote LED's indication up to 50 metres away. A maximum of 2 off 548 LED modules can be connected, there are identified as 'A' and 'B' and give a total of 16 extra LED outputs.

It is possible to use a mix of 157 and 548 modules to give both relay and LED expansion if required (Please refer to our Technical Support department for details.).

14.7 INPUT EXPANSION

It is possible to increase the number of monitored inputs available by utilising either :

- DSE P130 input expansion
- 54x Protection Expansion/Annunciator.

Please refer to the relevant product documentation for further details.

14.8 COMMUNICATIONS OPTION CONNECTIONS

14.8.1 DESCRIPTION

The 5xxx series configuration software allows the 5310 controller to communicate with a PC. The computer can be connected to the module either directly (P810 shown to the right), via a modem (RS232)* or via an RS485 link**.

The operator is then able to remotely control the module, starting or stopping the generator, selecting operating modes, etc. The various operating parameters (such as output volts, oil pressure, etc.) on the remote generator can also be viewed.

The information contained in this manual should be read in conjunction with the appropriate module documentation. This manual only details the operation of the communications software and how it should be used. The operation of the module is detailed in its own relevant manual.

NOTE: - *If modem communications is a requirement, then it is important to order the correct 5310 module with the RS232 communications board fitted. This provides a 9-way D-type connector suitable for connection to the modem. Please refer to the *comms* section of this manual for details of how the system should be configured.

**If RS485 communications is required, then it is important to order the correct 5310 module with the RS485 communications board fitted. This provides a 3-way terminal block for connection of the RS485 link.

14.8.2 PC TO CONTROLLER (DIRECT) CONNECTION

To connect a 5310 to a modem the following items are required: -

- Any 5310 Module (RS232 or RS485)
- 5xxx series configuration software (Supplied on DSE software CD).
- P810 interface (USB or RS232 as required)

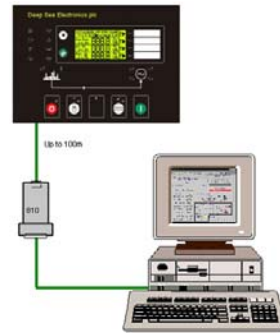

14.8.3 MODEM TO CONTROLLER CONNECTION

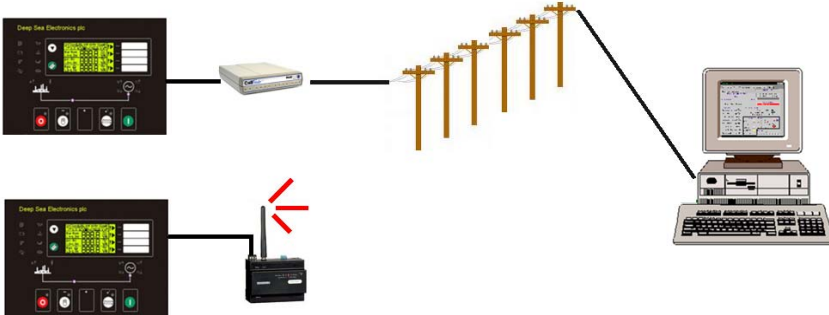

To connect a 5310 to a modem the following items are required: -

- 5310 Module with RS232 Communications Interface
- Compatible RS232 Modem (PSTN or GSM)
- Suitable connection leads
- Power supply for the modem
- 5xxx series configuration software (Supplied on DSE software CD).
- Access to a PSTN Line or GSM network.

CAUTION! - The modem must be powered from a suitably stabilised supply, preferably supplied with the modem (see below). Failure to ensure continuity of supply will result in communication difficulties at such times as Mains failure or during cranking. An uninterruptible power supply arrangement is recommended (AC or DC depending on modem power requirement).

14.8.4 RS485 LINK TO CONTROLLER

The RS485 enabled 5310 modules are able to communicate with a PC or other RS485 enabled device over a standard RS485 connection. Typical uses of RS485 are:

- Direct connection to a remote PC running the 5xxx series configuration software. RS485 is capable of communication over a distance of 1.2km where suitable 120Ω RS485 cable is installed.
- Connection to a building management to allow mains, generator and engine parameters/alarm conditions to be displayed along with information from other devices (air conditioning, fire alarm system etc).

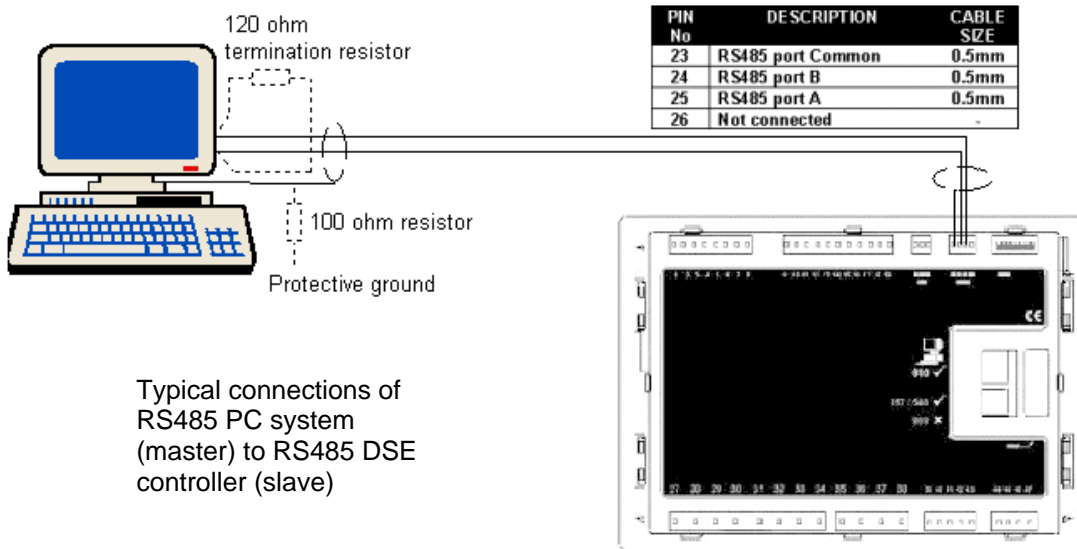

NOTE: - The RS485 system will comprise of one MODBUS master (typically a PC) and up to 31 MODBUS slaves. The 5310 modules are always MODBUS slave devices. To ensure correct operation a suitable 120Ω terminal resistor must be fitted to each end of the RS485 connection bus.

Caution! - The A and B lines of the 485 network should be terminated at each end with a 120Ω resistor.

Some RS485 devices (PC cards in particular) are already fitted with a terminating resistor. However if they are not installed as an 'end of line' device then such terminating resistors must be removed. Other RS485 devices may be fitted with a 'switchable' resistor, again this must be switched out if the device is not installed as an 'end of line' device.

TYPICAL BUILDING MANAGEMENT SCHEME USING RS485 MONITORING

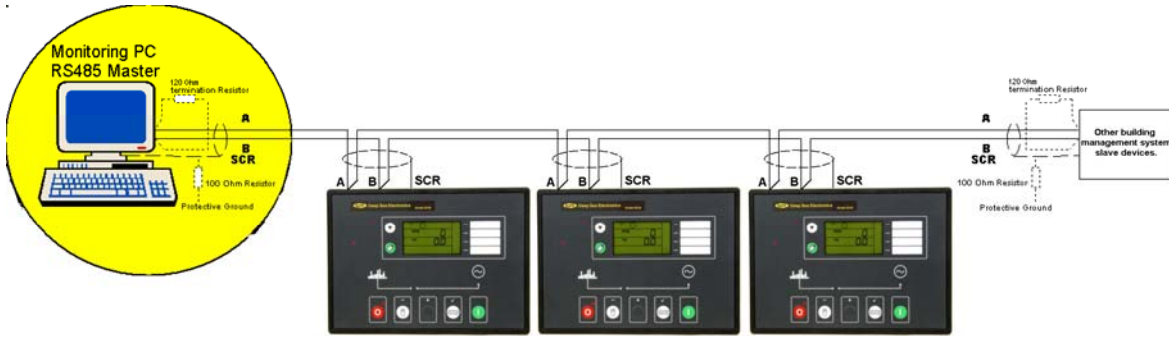

⚠ CAUTION! - RS485 cabling must be 120Ω impedance cable, specified for use with RS485. 120Ω terminating resistors must be fitted to the first and last devices on the bus. Some PC RS485 cards are already fitted with this resistor, and in this case should not be fitted externally. If in doubt, consult the supplier of your PC RS485 card.
If the 5310 controller is the 'last' device on the bus, then it's RS485 connection must be suitably terminated with a 120Ω resistor as detailed in the specification laid out in the RS485 standard.

**Recommended cable BELDEN 9841 120Ω RS485 cable.
 DSE part number 016-030.**

⚠ NOTE: - The RS485 output uses 'MODBUS' protocol. It is possible to use third party software to monitor and control the 5310 module via this protocol. Please refer to Deep Sea Electronics Plc for details.

14.8.5 MODBUS™

The RS485 output uses Modbus™ communications protocol. This uses a master-slave technique to communicate. Only the Master can initiate a packet transaction, called a 'query'. When appropriate the slave (5310 Module) responds to the query and provides the information requested by the master.

All supported data can be read and written as specified in the register table (documentation is available from Deep Sea Electronics Plc.).

When the 5310 Module receives a query it will respond by either supplying the requested register data or performing the requested action. A slave device (the 5310 module) will never initiate communications on the Modbus™ link. The 5310 can only be configured as a slave device. The Master can only query individual slaves. Refer to the Modbus™ protocol document for more details.

14.9 ENCLOSURE CLASSIFICATIONS

IP CLASSIFICATIONS

BS EN 60529 Degrees of protection provided by enclosures

First Digit	Second digit
Protection against contact and ingress of solid objects 0 No protection	Protection against ingress of water 0 No protection
1 Protected against ingress solid objects with a diameter of more than 50 mm. No protection against deliberate access, e.g. with a hand, but large surfaces of the body are prevented from approach.	1 Protection against dripping water falling vertically. No harmful effect must be produced (vertically falling drops).
2 Protected against penetration by solid objects with a diameter of more than 12 mm. Fingers or similar objects prevented from approach.	2 Protection against dripping water falling vertically. There must be no harmful effect when the equipment (enclosure) is tilted at an angle up to 15° from its normal position (drops falling at an angle).
3 Protected against ingress of solid objects with a diameter of more than 2.5 mm. Tools, wires etc. with a thickness of more than 2.5 mm are prevented from approach.	3 Protection against water falling at any angle up to 60° from the vertical. There must be no harmful effect (spray water).
4 Protected against ingress of solid objects with a diameter of more than 1 mm. Tools, wires etc. with a thickness of more than 1 mm are prevented from approach.	4 Protection against water splashed against the equipment (enclosure) from any direction. There must be no harmful effect (splashing water).
5 Protected against harmful dust deposits. Ingress of dust is not totally prevented but the dust must not enter in sufficient quantity to interface with satisfactory operation of the equipment. Complete protection against contact.	5 Protection against water projected from a nozzle against the equipment (enclosure) from any direction. There must be no harmful effect (water jet).
6 Protection against ingress of dust (dust tight). Complete protection against contact.	6 Protection against heavy seas or powerful water jets. Water must not enter the equipment (enclosure) in harmful quantities (splashing over).

NEMA CLASSIFICATIONS

▲ NOTE: - There is no direct equivalence between IP / NEMA ratings. IP figures shown are approximate only.

1 IP30	Provides a degree of protection against contact with the enclosure equipment and against a limited amount of falling dirt.
2 IP31	Provides a degree of protection against limited amounts of falling water and dirt.
3 IP64	Provides a degree of protection against windblown dust, rain and sleet; undamaged by the formation of ice on the enclosure.
3R IP32	Provides a degree of protection against rain and sleet; undamaged by the formation of ice on the enclosure.
4 (X) IP66	Provides a degree of protection against splashing water, windblown dust and rain, hose directed water; undamaged by the formation of ice on the enclosure. (Resist corrosion).
12/12K IP65	Provides a degree of protection against dust, falling dirt and dripping non corrosive liquids.
13 IP65	Provides a degree of protection against dust and spraying of water, oil and non corrosive coolants.

<<< THIS PAGE INTENTIONALLY BLANK >>>