



Husqvarna®



PP 492

EN Operator's manual

2-21

To order go to Discount-Equipment.com



TO PURCHASE THIS PRODUCT PLEASE CONTACT US



**Equipment Financing and
Extended Warranties Available**



**Discount-Equipment.com is your online resource for
commercial and industrial quality parts and equipment sales.**

561-964-4949

visit us on line @ www.discount-equipment.com

Select an option below to find your Equipment

Search by Manufacturer

Search by Product Type

Request a Quote

We sell worldwide for the brands: Genie, Terex, JLG, MultiQuip, Mikasa, Essick, Whiteman, Mayco, Toro Stone, Diamond Products, Generac Magnum, Airman, Haulotte, Barreto, Power Blanket, Nifty Lift, Atlas Copco, Chicago Pneumatic, Allmand, Miller Curber, Skyjack, Lull, Skytrak, Tsurumi, Husquvarna Target, Stow, Wacker, Sakai, Mi-T-M, Sullair, Basic, Dynapac, MBW, Weber, Bartell, Bennar Newman, Haulotte, Ditch Runner, Menegotti, Morrison, Contec, Buddy, Crown, Edco, Wyco, Bomag, Laymor, EZ Trench, Bil-Jax, F.S. Curtis, Gehl Pavers, Heli, Honda, ICS/PowerGrit, IHI, Partner, Imer, Clipper, MMD, Koshin, Rice, CH&E, General Equipment, Amida, Coleman, NAC, Gradall, Square Shooter, Kent, Stanley, Tamco, Toku, Hatz, Kohler, Robin, Wisconsin, Northrock, Oztec, Toker TK, Rol-Air, APT, Wylie, Ingersoll Rand / Doosan, Innovatech, Con X, Ammann, Mecalac, Makinex, Smith Surface Prep, Small Line, Wanco, Yanmar

Contents

Introduction.....	2	Troubleshooting.....	15
Safety.....	4	Transportation and storage.....	17
Assembly.....	7	Technical data.....	17
Operation.....	9	Service.....	19
Maintenance.....	15	EC Declaration of Conformity.....	20

Introduction

Product description

The product is a power pack unit and a remote control. The product is used together with many Husqvarna electrical power tools:

- The remote control is used to control the connected power tools.
- The remote control has a 3.5 in. digital color display.
- The product is kept cool with water. The remote control controls the electric water valve.
- Connect the product to a 400/480 V power supply system with a 32/30 A fuse.

The product is kept cool with water. Always use the product with water.

The product is used in industrial operations by operators with experience.

Model PP 492 has a new PRIME connector. If your PRIME tool does not have this new PRIME connector, you must use an adapter cable. An approved servicing dealer can upgrade the PRIME tool with the new PRIME connector.

Intended use

This product is used to operate applicable Husqvarna electrical power tools with a high frequency motor. All other use is incorrect.

Product overview

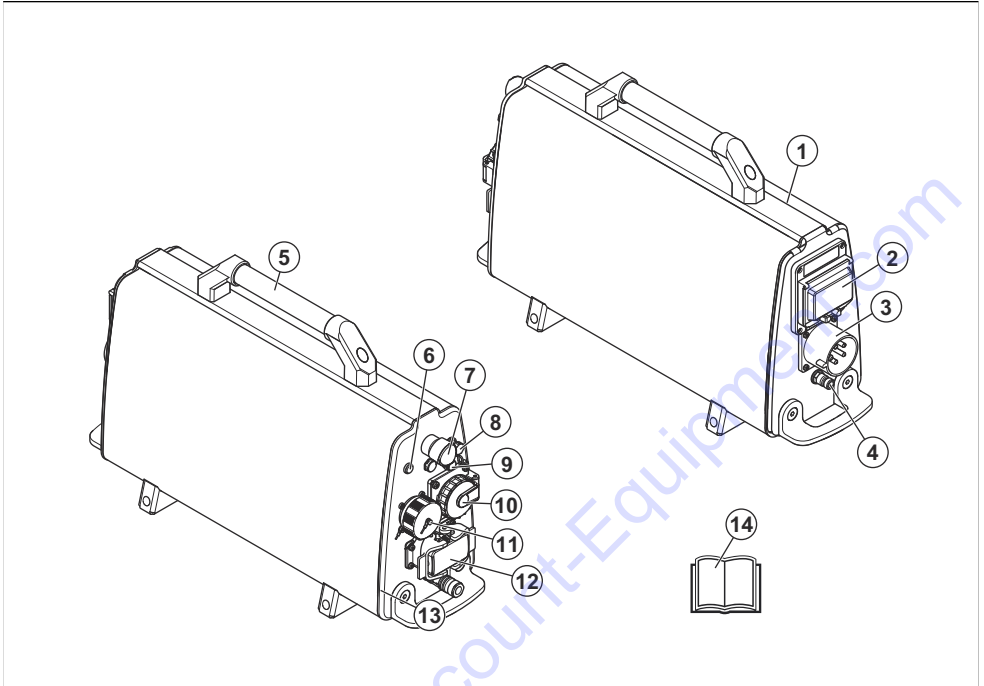

1. Power pack unit
2. Residual-current device
3. Electrical socket
4. Water connector inlet
5. Handle
6. Power indicator
7. Machine stop button
8. CAN bus connector
9. Automatic fuse, 16A (only on 5-pin products)
10. 1 phase socket (only 5-pin products)
11. PRIME connector
12. Wall saw connector
13. Water connector outlet
14. Operator's manual



Read the manual carefully and make sure that you understand the instructions before you use the product.



Always put on hearing protection, eye protection and breathing protection.



Inspection and/or maintenance must be done with the motor stopped and the power plug disconnected.

Symbols on the product



WARNING: Not careful or incorrect use can result in injury or death to the operator or others.



Energized parts.



This product is in compliance with applicable EC directives.



The product agrees with the applicable Australia and New Zealand electromagnetic compatibility directives.



China RoHS Environment-Friendly Use Period (EUFP) symbol.



The product or package of the product is not domestic waste. Recycle it at a recycling station for electrical and electronic equipment.

Note: Other symbols/decals on the product refer to special certification requirements for some markets.

Rating plate

①	②	③	④	
Phase	Voltage	Ampere	Frequency	
Minimum generator rating for full power: 25 kVA Generator grounding required see operator's manual for further information				

1. Phase
2. Voltage
3. Ampere
4. Frequency

Product liability

As referred to in the product liability laws, we are not liable for damages that our product causes if:

- the product is incorrectly repaired.
- the product is repaired with parts that are not from the manufacturer or not approved by the manufacturer.
- the product has an accessory that is not from the manufacturer or not approved by the manufacturer.
- the product is not repaired at an approved service center or by an approved authority.

Safety

Safety definitions

Warnings, cautions and notes are used to point out specially important parts of the manual.

WARNING: Used if there is a risk of injury or death for the operator or bystanders if the instructions in the manual are not obeyed.

CAUTION: Used if there is a risk of damage to the product, other materials or the adjacent area if the instructions in the manual are not obeyed.

Note: Used to give more information that is necessary in a given situation.

General power tool safety warnings

WARNING: Read all safety warnings, instructions, illustrations and specifications provided with this power tool. Failure to follow all instructions listed below may result in electric shock, fire and/or serious injury.

- **Save all warnings and instructions for future reference.** The term "power tool" in the warnings

refers to your mains-operated (corded) power tool or battery-operated (cordless) power tool.

Work area safety

- **Keep work area clean and well lit.** Cluttered or dark areas invite accidents.
- **Do not operate power tools in explosive atmospheres, such as in the presence of flammable liquids, gases or dust.** Power tools create sparks which may ignite the dust or fumes.
- **Keep children and bystanders away while operating a power tool.** Distractions can cause you to lose control.

Electrical safety

- **Power tool plugs must match the outlet. Never modify the plug in any way.** Unmodified plugs and matching outlets will reduce risk of electric shock.
- **Avoid body contact with earthed or grounded surfaces, such as pipes, radiators, ranges and refrigerators.** There is an increased risk of electric shock if your body is earthed or grounded.
- **Do not expose power tools to rain or wet conditions.** Water entering a power tool will increase the risk of electric shock.
- **Do not abuse the cord. Never use the cord for carrying, pulling or unplugging the power tool. Keep cord away from heat, oil, sharp edges or moving parts.** Damaged or entangled cords increase the risk of electric shock.

- **When operating a power tool outdoors, use an extension cord suitable for outdoor use.** Use of a cord suitable for outdoor use reduces the risk of electric shock.
- **If operating a power tool in a damp location is unavoidable, use a residual current device (RCD) protected supply.** Use of a RCD reduces the risk of electric shock.

Personal safety

- **Stay alert, watch what you are doing and use common sense when operating a power tool. Do not use a power tool while you are tired or under the influence of drugs, alcohol or medication.** A moment of inattention while operating power tools may result in serious personal injury.
- **Use personal protective equipment. Always wear eye protection.** Protective equipment such as dust mask, non-skid safety shoes, hard hat or hearing protection used for appropriate conditions will reduce personal injuries.
- **Prevent unintentional starting. Ensure the switch is in the off-position before connecting to power source and/or battery pack, picking up or carrying the tool.** Carrying power tools with your finger on the switch or energising power tools that have the switch on invites accidents.
- **Remove any adjusting key or wrench before turning the power tool on.** A wrench or a key left attached to a rotating part of the power tool may result in personal injury.
- **Do not overreach. Keep proper footing and balance at all times.** This enables better control of the power tool in unexpected situations.
- **Dress properly. Do not wear loose clothing or jewellery. Keep your hair and clothing away from moving parts.** Loose clothes, jewellery or long hair can be caught in moving parts.
- **If devices are provided for the connection of dust extraction and collection facilities, ensure these are connected and properly used.** Use of dust collection can reduce dust-related hazards.
- **Do not let familiarity gained from frequent use of tools allow you to become complacent and ignore tool safety principles.** A careless action can cause severe injury within a fraction of a second.

Power tool use and care

- **Do not force the power tool. Use the correct power tool for your application.** The correct power tool will do the job better and safer at the rate for which it was designed.
- **Do not use the power tool if the switch does not turn it on and off.** Any power tool that cannot be controlled with the switch is dangerous and must be repaired.
- **Disconnect the plug from the power source and/or remove the battery pack, if detachable, from the power tool before making any adjustments, changing**

accessories, or storing power tools. Such preventive safety measures reduce the risk of starting the power tool accidentally.

- **Store idle power tools out of the reach of children and do not allow persons unfamiliar with the power tool or these instructions to operate the power tool.** Power tools are dangerous in the hands of untrained users.
- **Maintain power tools and accessories. Check for misalignment or binding of moving parts, breakage of parts and any other condition that may affect the power tool's operation. If damaged, have the power tool repaired before use.** Many accidents are caused by poorly maintained power tools.
- **Keep cutting tools sharp and clean.** Properly maintained cutting tools with sharp cutting edges are less likely to bind and are easier to control.
- **Use the power tool, accessories and tool bits etc. in accordance with these instructions, taking into account the working conditions and the work to be performed.** Use of the power tool for operations different from those intended could result in a hazardous situation.
- **Keep handles and grasping surfaces dry, clean and free from oil and grease.** Slippery handles and grasping surfaces do not allow for safe handling and control of the tool in unexpected situations.

Service

- **Have your power tool serviced by a qualified repair person using only identical replacement parts.** This will ensure that the safety of the power tool is maintained.

General safety instructions

WARNING: Read the warning instructions that follow before you use the product.

- This product is a dangerous tool if you are not careful or if you use the product incorrectly. This product can cause serious injury or death to the operator or others. Before you use the product, you must read and understand the contents of this operator's manual.
- Save all warnings and instructions.
- Comply with all applicable laws and regulations.
- The operator and the employer of the operator must know and prevent the risks during operation of the product.
- Do not let a person operate the product unless they read and understand the contents of the operator's manual.
- Do not operate the product unless you receive training before use. Make sure that all operators receive training.
- Do not let a child operate the product.
- Only let approved persons operate the product.

- The operator is responsible for accidents that occur to other persons or their property.
- Do not use the product if you are tired, ill, or under the influence of alcohol, drugs or medicine.
- Always be careful and use your common sense.
- This product produces an electromagnetic field during operation. This field can under some circumstances interfere with active or passive medical implants. To decrease the risk of serious injury or death, we recommend persons with medical implants to speak to their physician and the medical implant manufacturer before operating this product.
- Keep the product clean. Make sure that you can clearly read signs and decals.
- Do not use the product if it is defective.
- Do not do modifications to this product.
- Do not operate the product if it is possible that other persons have done modifications to the product.

Safety instructions for operation

WARNING: Read the warning instructions that follow before you use the product.

- Read the operator's manual for the connected power tool carefully. Make sure that you understand the instructions.
- There is always a risk of shocks from electrical products. Do not use the product in bad weather conditions. Prevent that your body touches lightning conductors and metal objects. Always follow the instructions in the operator's manual to prevent damage.
- Connect the product to grounded outlets only.
- Make sure that the mains voltage are the same as the voltage shown on the rating plate of the product.
- Make sure that the power cord and extension cable are not damaged and in good condition.
- Do not use the product if the product or the power cord is damaged. Let an approved service agent repair the product or replace the power cord.
- To prevent overheating, do not use the extension cable while it is folded.
- Do not let children use the product.
- Do not go away from the product when the motor is on.
- Always disconnect the power supply to the product for longer work breaks.
- Do not operate the product unless you can get aid if an accident occurs.
- Make sure that the product stays on a stable surface.
- Always disconnect the power plug before the product is moved.
- Do not disconnect the power cord unless the motor is off and fully stopped.
- Always keep fire protection equipment near.

Personal protective equipment

WARNING: Read the warning instructions that follow before you use the product.

- Always use approved personal protective equipment when you operate the product. Personal protective equipment cannot fully prevent injury but it decreases the degree of injury if an accident does occur. Let your dealer help you select the correct personal protective equipment.
- Regularly do a check of the condition of the personal protective equipment.
- Use an approved protective helmet.
- Use approved hearing protection.
- Use approved respiratory protection.
- Use approved eye protection with side protection.
- Use protective gloves.
- Use boots with steel toe-cap and non-slip sole.
- Use approved work clothing or equivalent close-fitting clothing that has long sleeves and long legs.

Safety devices on the product

WARNING: Read the warning instructions that follow before you use the product.

- Do not use a product with defective safety devices.
- Do a check of the safety devices regularly. If the safety devices are defective, speak to Discount-equipment.

Machine stop buttons

The machine stop buttons on the product and on the remote control decrease the speed of the connected power tool. The machine stop buttons also disconnect the power tool from the power supply.

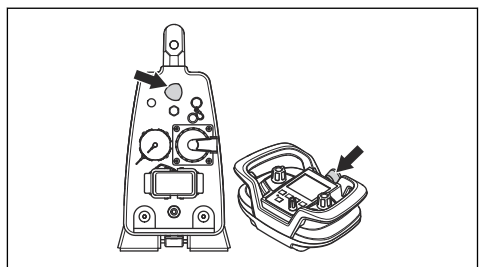

To do a check of the machine stop buttons

1. Turn the machine stop button on the product clockwise to make sure that it is released.
2. Push the ON/OFF button on the remote control.

3. Push and hold the "RETURN" button (A) and turn the dial (B) clockwise to rotate the blade or wire.

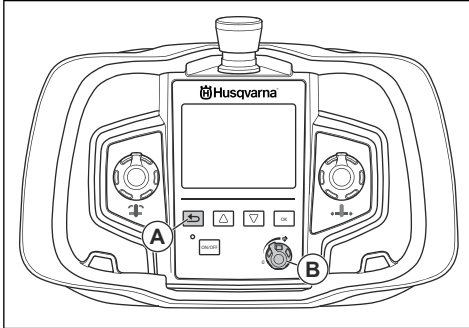

4. Push the machine stop button on the product to stop the blade or wire.
5. Make sure that the power indicator on the product goes out.
6. Do the same procedure to do a check of the machine stop button on the remote control.

RCD

The product has an integrated RCD. The RCD is a protection for the operator if an electrical fault occur.

To do a check of the residual-current device

WARNING: Always do a test of the residual-current device before use.

1. Connect the product to a grounded 3-phase outlet socket.
2. Open the cover of the residual-current device to get access to the power switch (A) and the test button (B).

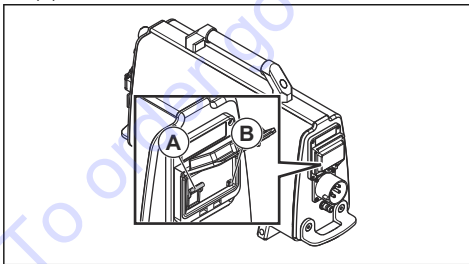

3. Push the power switch of the residual-current device to 1.
4. Push the test button. The residual-current device must release to disconnect the unit from the power supply.
5. Reset the residual-current device. Push the power switch of the residual-current device to 0 and then to 1.
6. Close the cover.

Safety instructions for maintenance

WARNING: Read the warning instructions that follow before you do maintenance on the product.

- Not approved changes and/or accessories can cause serious injury or death to the operator or others.
- Only Discount-equipment must open the enclosure and do service to the product.
- Do the daily maintenance to make sure that the product operates correctly. Refer to *Maintenance on page 15*.
- Do the inspection and/or maintenance with the motor stopped and the power plug disconnected.
- Clean the product with water. Do not use high pressure washer. Do not point the water at electrical components or bearings.
- Only let an approved service person do service on the product. Use only Husqvarna or equivalent replacement parts.

Assembly

Power source for the product

To use full power output, the product must be connected to a 32 A fuse. With a 16 A or a 25 A fuse the available

power output is lower. It is necessary to select an applicable fuse in the remote control menu system.

At a lower voltage the available power output decreases in a linear fall down to 80%. Refer to *Technical data on page 17* for more information.

Gasoline generator as a power source

CAUTION: A generator that supplies more input voltage than specified in the voltage range can cause damage to the product.

A generator that operates on gasoline can be used as a power source if it can supply sufficient power. Refer to *Technical data on page 17* for typical generator operation conditions. The generator must be grounded to prevent damage to the product.

To connect a power source to the product

CAUTION: Do not connect the product to a power source without an applicable fuse.

1. Connect the power cord from the power source to the electric socket on the product.

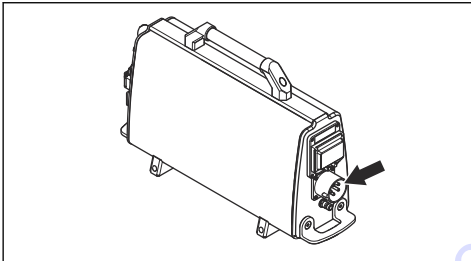

Note: A 5-pin product with a 1 phase socket (230 V), must have a neutral wire (N) for the electric socket to operate. The product can be operated without a neutral wire.

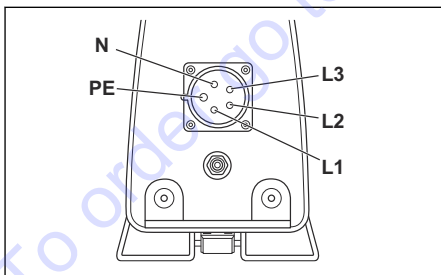

2. Use the remote control to select the correct fuse. In the menu system, select "DRIVE CHOICES" and then "SET FUSE".

3. Select the correct fuse.

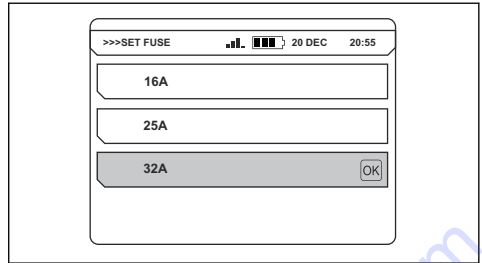

To connect the water supply

CAUTION: Use only clean water to prevent that dirt causes a blockage in the water system.

Note: The water coolant does not stop during a power failure.

Note: The product has an electric water valve, which is closed when the product starts. When the product is disconnected from the current, the water valve opens to drain the water coolant. This is to prevent the water inside the product to freeze.

1. Connect the water hose to the water connector inlet on the product.

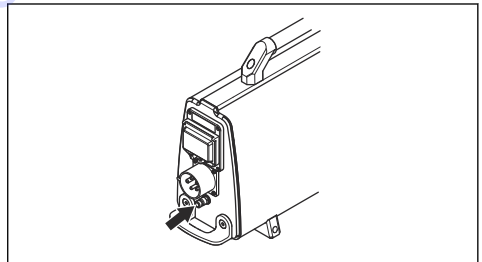

2. Connect the water connector outlet on the product to the power tool.

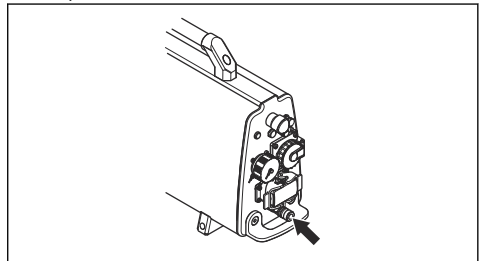

3. To adjust the flow of water coolant to the power tool, refer to the operator's manual for the power tool.

4. Refer to *Technical data on page 17* for water pressure.

To connect power tools

1. Use the upper connector (A) for the PRIME products.

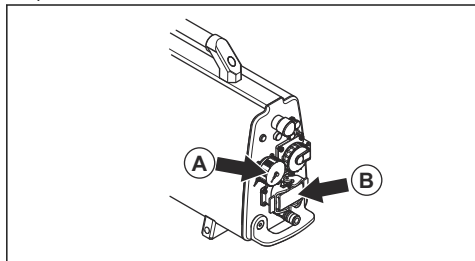

2. Use the lower connector (B) to connect to wall saws.
3. For more information, refer to *Technical data on page 17*.

Operation

Introduction

WARNING: Before you operate the product, you must read and understand the safety chapter.

Before you operate the product

1. Read the operator's manual carefully and make sure that you understand the instructions.
2. Do daily maintenance. Refer to *Daily maintenance on page 15*.
3. Make sure that only approved persons are in the work area, because there is a risk of serious injury.
4. Use personal protective equipment. Refer to *Personal protective equipment on page 6*.

The remote control

Use the "RETURN" button (A) to go back in the menu. Use the arrow buttons (B) to move up and down in the menus and the "OK" button (C) to do the selection.

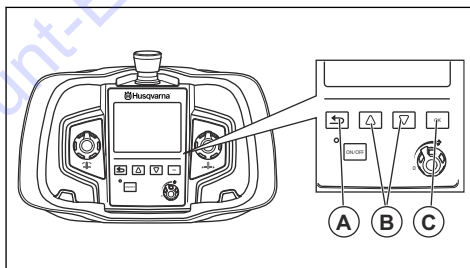

Menu system overview

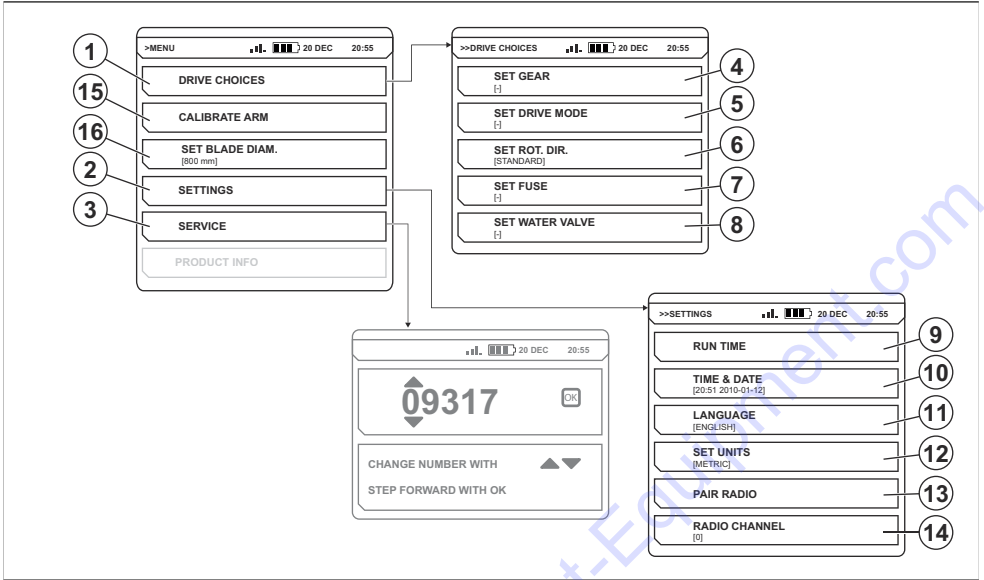

Main menu	Submenu	Adjustment
1. "DRIVE CHOICES"	4. "SET GEAR"	The connected wall saw has 2 mechanical gears: 1. (600-900 rpm) 2. (800-1200 rpm)
	5. "SET DRIVE MODE"	Set the necessary "DRIVE MODE" for the product: <ul style="list-style-type: none"> • "BLADE MAN" for wall sawing • "BLADE STD" for wall sawing • "WIRE" for wire cutting • "CHAIN" for chain sawing
	6. "SET ROT. DIR."	Stop the product before change of direction of the blade. Select between: <ul style="list-style-type: none"> • "STANDARD" • "REVERSE"
	7. "SET FUSE"	To use full power output, the product must be connected to a 32 A fuse. With a fuse that is lower rated, the power output must be lower to not overload the fuse. Select the applicable fuse rated value that is related to the connected product: <ul style="list-style-type: none"> • 16A • 25A • 32A
	8. "SET WATER VALVE"	The water flow is adjusted with the ball valve at the water connector inlet. Select correct water regulation: <ul style="list-style-type: none"> • "ON" - The water valve is always open. • "AUTO" - The water valve opens when the dial is turned from its closed position.

Main menu	Submenu	Adjustment
2. "SETTINGS"	9. "RUN TIME"	<ul style="list-style-type: none"> • "TIME COUNTER" - A stop monitor counts the time that the blade or the wire rotates during the operation when minimum 1 supply is on. • "CLEAR RUNTIME" - Releases the stop monitor. • "CURRENT RUNTIME" - Shows the current run time.
	10. "TIME & DATE"	<ul style="list-style-type: none"> • "SET TIME" - Set the current time. • "SET DATE" - Set the current date. • "TIME FORMAT" - Select time format: <ul style="list-style-type: none"> • 12h • 24h • "DATE FORMAT" - Select date format: <ul style="list-style-type: none"> • "YYYY-MM-DD" • "YYYY/DD/MM" • "DD/MM/YYYY"
	11. "LANGUAGE"	Select display language.
	12. "SET UNITS"	Select unit for the remote control: <ul style="list-style-type: none"> • "AMERICAN" • "METRIC"
	13. "PAIR RADIO"	Connect the remote control with the product.
	14. "RADIO CHANNEL"	<p>If there is interference or loss of signal, the radio channel for the remote control and the product must be changed. To set up the radio channel, the remote control must be connected to the product with a CAN bus cable. Select the correct radio channel:</p> <ul style="list-style-type: none"> • 0 (2.410 GHz) • 1 (2.415 GHz) • ... • 11 (2.465 GHz)
3. "SERVICE"		The "SERVICE" menu is locked by password. Only servicing personnel have access to do the adjustment in the "SERVICE" menu.
15. "CALIBRATE ARM"		The calibrate menu is used to calibrate the position of the pivot arm. Use the position of the pivot arm to calculate the current depth of the blade.
16. "SET BLADE DIAMETER"		The blade diameter adjustment is used to calculate the depth of the blade.

Radio communication system

Before you can operate the connected power tool, you must do a pairing operation between the remote control and the product.

The remote control can only control the connected product.

If the supplied remote control is replaced, you must do a pairing operation between the remote control and the product again.

If it is necessary to interchange the remote controls between 2 power pack units, you must do a pairing operation between the interchanged remote control and the product.

To do a pairing operation between the remote control and the product

1. Connect the remote control to the product with the supplied CAN bus cable.

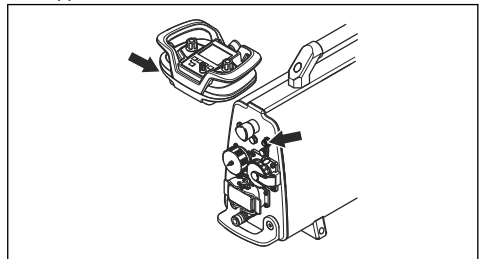

2. Tighten the cable connector screws by hand.

3. Wait until the remote control starts and the main menu is shown on the display.
4. Push the "OK" button to get access to the main menu.

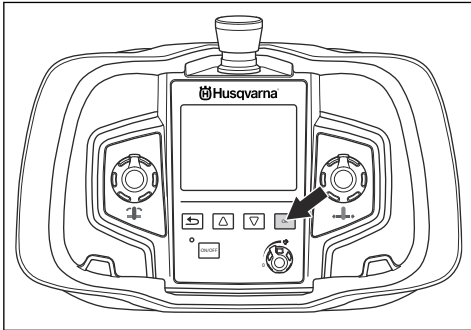

5. Find the "SETTINGS" menu with the arrow buttons and then push the "OK" button.

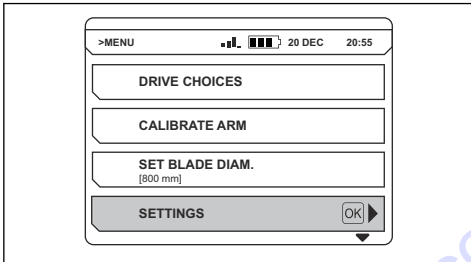

6. Find "PAIR RADIO" with the arrow buttons and then push the "OK" button.

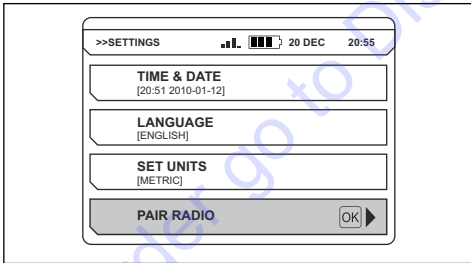

Note: A message on the display tells if the pairing operation was done or not. If you cannot do a pairing operation between the remote control and the product, refer to *Troubleshooting - wall saw on page 15*.

Remote control battery

Note: You must charge the remote control battery before you use the remote control for the first time.

The remote control battery is a Li-ion battery. Use only original batteries for this product. Refer to an approved dealer for more information.

A fully charged remote control battery can operate maximum 8-10 hours. Cold weather decreases the capacity and the operation time of the remote control battery. The operation time of the remote control battery also decreases if the display is on.

Dispose a damaged remote control battery at your nearest service center or recycle it at an applicable location.

Remove and install the remote control battery from the rear side of the remote control.

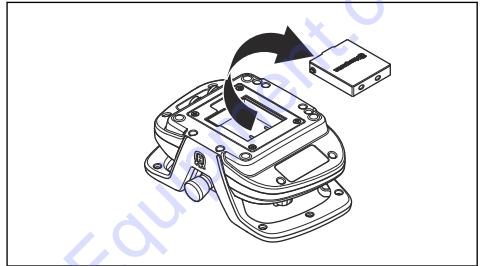

To charge the remote control battery

CAUTION: Keep the charger of the remote control battery dry and in protection against temperature variation.

1. Connect the charger to a socket outlet.
2. Attach the remote control battery to the charger. Make sure that the lamp on the charger comes on and is orange.

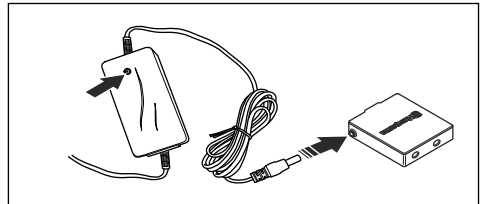

3. Charge the remote control battery for approximately 2-3 hours to make it fully charged.
4. Remove the charger when the remote control battery is fully charged and the lamp shows green.

Other software adjustments

Do the adjustments that follow before you operate the product:

Note: Refer to *Menu system overview on page 10* for more information.

- Set time and date. Select the "SETTINGS" menu and then the "TIME & DATE".
- Set the correct display language. Select the "SETTINGS" menu and then "LANGUAGE".
- Set the necessary measurement units. Select the "SETTINGS" menu and then "SET UNITS".

To start the product

1. Open the water supply to the product.
2. Turn the machine stop button on the product and on the remote control clockwise to disengage.

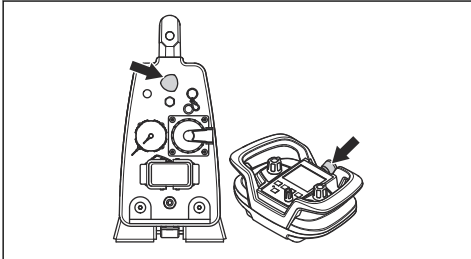

3. Push the ON/OFF button to start the remote control. This also starts the connected wall saw, information is shown on the display. Refer to the operator's manual for the connected wall saw for more information.

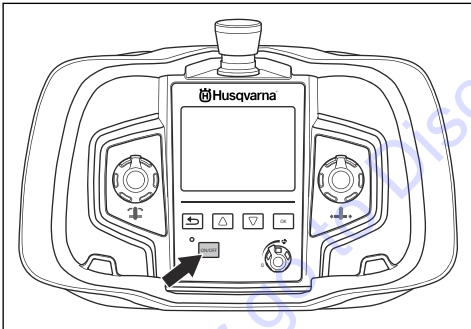

4. If a PRIME tool is connected to the product, push the ON/OFF button to stop the remote control. The PRIME tool starts. Refer to the operator's manual for the connected PRIME tool for more information.

To stop the product

WARNING: Always close the water supply to the product when it is not connected to the power supply.

1. To stop the blade, turn the dial that controls the speed counterclockwise to its 0 position.

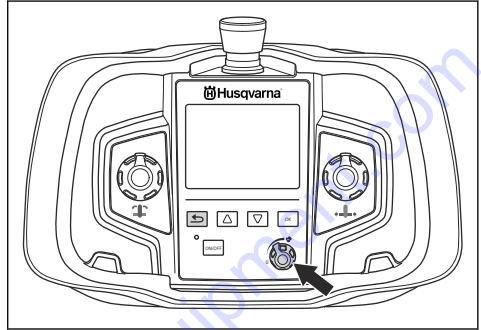

2. Close the water supply to the product. If the water coolant is set to "AUTO", the water supply will stop automatically.
3. Stop the remote control unit, push the "ON/OFF" button.

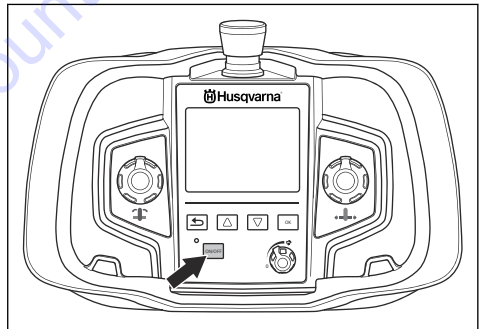

4. Push the emergency stop button to stop the product.

To operate the product

- To operate the product, refer to the operator's manual for the power tool.

Maintenance

Introduction

WARNING: Read and understand the safety chapter before you do maintenance on the product.

Daily maintenance

WARNING: Disconnect the product from the power supply and wait minimum 5 minutes before you start the maintenance.

CAUTION: Do not use a high-pressure washer to clean the product. The high pressure can cause damage to the seals

and cause water and dirt to come into the product.

- Do a check of the safety equipment. Make sure that it is not damaged. Refer to *Safety devices on the product on page 6*.
- Make sure that the power cord and the extension cable are in good condition and not damaged.
- Make sure that the water hose and water couplings are in good condition and not damaged.
- Always clean the product at the end of the work day. Use a heavy duty handheld brush or a large paint brush.
- Keep the connectors and pins clean. Clean with a cloth or brush.
- Clean the filter in the water connector inlet. Use a 16 mm wrench to loosen the coupling and use compressed air to remove dirt from the filter.
- Make sure that the water system is not damaged.

Troubleshooting

Error messages - wall saw

If there are errors, an error code (A) and an error message (B) are shown on the display of the remote control.

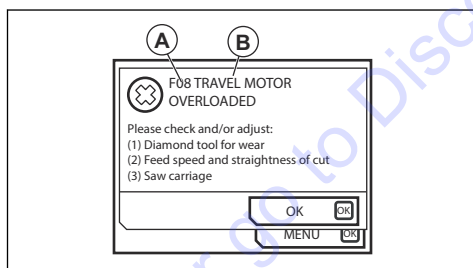

Do the procedure shown on the display or speak to an Discount-equipment. Push the "OK" button to delete the error message.

If you close the error message and it does not show on the display again, you can continue to operate the product.

If the error message shows again, refer to *Troubleshooting - wall saw on page 15* or speak with Discount-equipment. If necessary, do an update of the software of the product.

Troubleshooting - wall saw

Error code	Error message	Possible fault	Possible solution
F01	"MOTOR OVERHEATED"	There is not sufficient water coolant flow to the saw motor.	Make sure that the water coolant flows to the saw motor. The temperature must be maximum 25 °C and the water flow must be minimum 3.5 l/minute.
F02	"POWER PACK OVERHEATED"	There is not sufficient water coolant flow to the product.	Make sure that the water coolant flows to the product. The temperature must be maximum 25 °C and the water flow must be minimum 3.5 l/minute. If the message shows up when the connected product is started, go to the operations menu "Water coolant" and select "ON". Let the water coolant supply the product for a minute before you start the product again.

Error code	Error message	Possible fault	Possible solution
F03	"LOW VOLTAGE"	There is low voltage supply to the product.	Examine the voltage during operation. Make sure that all 3 phases are energized. Make sure that the products supply cables have sufficient cable area.
F04	"HIGH VOLTAGE"	There is high voltage supply to the product.	Examine the voltage during operation. This message usually shows when the product is supplied by a generator.
F05	"OVER CURRENT"	There is current overload to the saw motor.	Make sure that the power cord is installed correctly and that it is not damaged.
F06	"NO HALL-SENSOR LENGTH"	There is fault on the HALL-sensor board for travel movement.	Speak to your servicing dealer.
F07	"NO HALL-SENSOR ARM"	There is fault on the HALL-sensor card for depth movement.	Speak to your servicing dealer.
F08	"TRAVEL MOTOR OVERLOADED"	There is current overload on the travel motor.	Turn the dial to the 0 position to reset the product. If the error message occurs again, the diamond tool is not sharp or the saw carriage is not adjusted correctly. Clean the rails and lubricate the gears. If the error message stays, speak to your servicing dealer.
F09	"DEPTH MOTOR OVERLOADED"	There is current overload in the depth motor.	Turn the dial to the 0 position to reset the product. If the error message occurs again, the diamond tool is not sharp. If the error message stays, speak to your servicing dealer.
F10	"BLADE JAM"	The blade can not rotate.	Remove the blade from the cut and start the product again.
F11	"GROUND FAULT OR NO SAW HEAD"	There is incorrect ground of the product/saw or there is no saw unit connected to the product.	Do a check of the electrical connection to the product. Make sure that the saw unit is connected to the product. If the error message stays, speak to your servicing dealer.
F12	"NON-COMPATIBLE SAW UNIT"	The incorrect saw unit is connected to the product.	Connect a compatible saw unit to the product.
F13	"NO CONTACT CHECK CAN-CABLE"	There is no connection signal between the product and the remote control.	Replace the CAN bus cable.
F14	"NO RADIO CONTACT"	There is no radio signal between the remote control and the product.	Make sure that the product is in operation and that the green light is on. If the error message stays, speak to your servicing dealer. The product can be used with the CAN bus cable connected between the product and the remote control.
F15	"NO DSP RESPONSE"	There is internal error in the power unit.	Speak to your servicing dealer.

Troubleshooting - PRIME tools

Error code	Error message	Possible faults	Possible procedure
F0101	There is current overload.	There is current overload to the tool in operation.	Speak to your servicing dealer.

Error code	Error message	Possible faults	Possible procedure
FXX08* ¹	There is high motor temperature.	The motor temperature is too high.	Increase the flow of water coolant. Use clean water to prevent blockage in the water channels. Refer to <i>Technical data on page 17</i> for specifications for water flow, temperature and pressure.
F0112	There is low input voltage.	The input voltage is too low.	Refer to the minimum voltage input in the manual.
F0113	There is high input voltage.	The input voltage is too high.	Refer to the maximum voltage input in the manual.
FXX14*	Error in the tool temperature sensor.	Stop or short circuit in the temperature sensor.	Speak to your servicing dealer.
F0118	There is a hardware fault.	N/A.	Speak to your servicing dealer.
F0119	The temperature in the product is too high.	The product is too hot.	Increase the flow of water coolant. Use clean water to prevent a blockage in the water channels. Refer to <i>Technical data on page 17</i> for specifications for water flow, temperature and pressure.
F0130	There is a general error.	The blade does not move freely.	Stop the product and release the blade.

Transportation and storage

Transportation of the product

- Make sure that the product is safely attached during transportation to prevent transport damage and accidents.
- Always stop the product and disconnect the power cord before you move the product.
- Always disconnect the power tool and the power tool cord before transportation.

- Keep the product in a dry area.
- Make sure that the temperature is not lower than -25°C (-77°F) and not higher than 50°C (122°F).
- If there is a risk that the water will freeze, the product must be drained of all remaining water coolant. Tilt the product to drain the water coolant from the water connector outlet.

Storage of the product

- Keep the product in a locked area to prevent access for children or persons that are not approved.

Technical data

Technical data

Rated voltage	380-480
Max. output, kVA	20
Rated current, A	16/25/32

¹ XX: different numbers on different tool that is connected to the power unit.

Input voltage, V/Hz	380-480/50-60
Output voltage, V/Hz	340/0-500
Secondary output voltage, V/Hz	24/0-500
Power supply	3P+PE+N
1- phase outlet, V	230
Recommended cable area, 32A	
Length, m/ft	Cable area, mm²/AWG
0-30/0-100	6/10
30-60/100-200	10/8
60-100/200-300	16/6
Effect power generator	
kVA min (400V/16A)	12
kVA min (400V/25A)	20
kVA min (400V/32A)	25
Weight	
Power pack unit, kg/lb	25.8/56
Water coolant	
Max. water coolant temperature at 3,5 l/min, °C/ 0.92 Gallon/min, °F	25/77
Max. water coolant pressure, bar/psi	7/102
Control system	
Control type	Remote control
Signal transmission	Wireless/cable
Frequency bands for the tool, GHz	2.400-2.480
Maximum radio frequency power transmitted, dBm/mW	4/2.5

Product dimensions

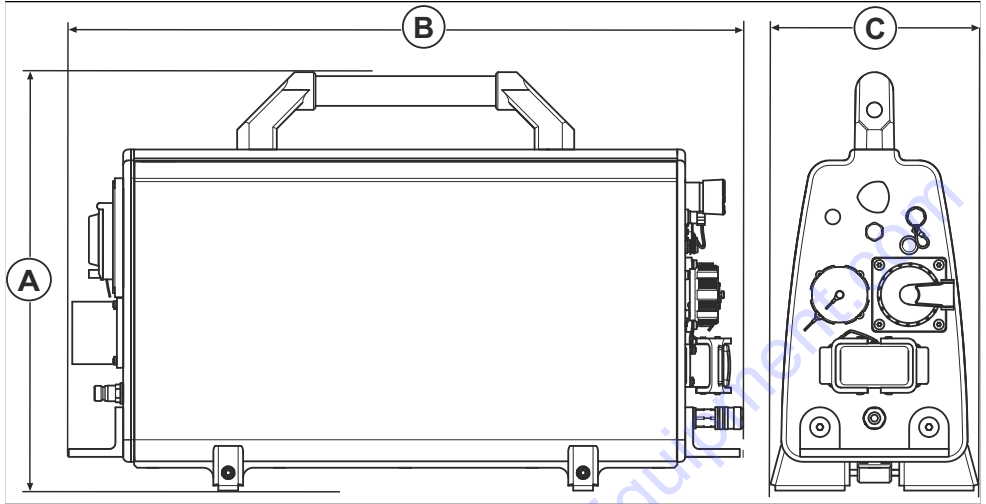

A	Height, mm/in.	422/16.6
B	Length, mm/in.	680/26.8
C	Width, mm/in.	205/8.1

EC Declaration of Conformity

EC Declaration of Conformity

Description	Power pack
Brand	Husqvarna
Type/Model	PP 492
Identification	Serial numbers dating from 2021 and onwards

complies fully with the following EU directives and regulations:

Directive/Regulation	Description
2014/53/EU	"relating to radio equipment"
2011/65/EU	"relating to restriction of hazardous substances"

and that the following harmonized standards and/or technical specifications are applied;

- EN ISO 12100:2010
- EN 61000-6-4:2007+A1:2011
- EN 61000-6-2:2005/C1:2005
- EN 60204-1:2018
- ETSI EN 301 489-1 V2.1.1
- ETSI EN 301 489-17 V3.1.1
- ETSI EN 300 328 V2.1.1

Partille, 2021-06-10

UK Declaration of Conformity

Description	Power pack
Brand	Husqvarna
Type/Model	PP 492
Identification	Serial numbers dating from 2021 and onwards

complies fully with the following UK directives and regulations:

Regulation	Description
S.I. 2017/1206	The Radio Equipment Regulations 2017
S.I. 2012/3032	The Restriction of the Use of Certain Hazardous Substances in Electrical and Electronic Equipment Regulations 2012

and that the following harmonized standards and/or technical specifications are applied;

EN ISO 12100:2010

EN 61000-6-4:2007+A1:2011

EN 61000-6-2:2005/C1:2005

EN 60204-1:2018

ETSI EN 301 489-1 V2.1.1

ETSI EN 301 489-17 V3.1.1

ETSI EN 300 328 V2.1.1

Partille, 2021-06-10



To order go to Discount-Equipment.com

Original instructions

1142783-98



2021-06-22

TO PURCHASE THIS PRODUCT PLEASE CONTACT US



**Equipment Financing and
Extended Warranties Available**



**Discount-Equipment.com is your online resource for
commercial and industrial quality parts and equipment sales.**

561-964-4949

visit us on line @ www.discount-equipment.com

Select an option below to find your Equipment

Search by Manufacturer

Search by Product Type

Request a Quote

We sell worldwide for the brands: Genie, Terex, JLG, MultiQuip, Mikasa, Essick, Whiteman, Mayco, Toro Stone, Diamond Products, Generac Magnum, Airman, Haulotte, Barreto, Power Blanket, Nifty Lift, Atlas Copco, Chicago Pneumatic, Allmand, Miller Curber, Skyjack, Lull, Skytrak, Tsurumi, Husquvarna Target, Stow, Wacker, Sakai, Mi-T-M, Sullair, Basic, Dynapac, MBW, Weber, Bartell, Bennar Newman, Haulotte, Ditch Runner, Menegotti, Morrison, Contec, Buddy, Crown, Edco, Wyco, Bomag, Laymor, EZ Trench, Bil-Jax, F.S. Curtis, Gehl Pavers, Heli, Honda, ICS/PowerGrit, IHI, Partner, Imer, Clipper, MMD, Koshin, Rice, CH&E, General Equipment, Amida, Coleman, NAC, Gradall, Square Shooter, Kent, Stanley, Tamco, Toku, Hatz, Kohler, Robin, Wisconsin, Northrock, Oztec, Toker TK, Rol-Air, APT, Wylie, Ingersoll Rand / Doosan, Innovatech, Con X, Ammann, Mecalac, Makinex, Smith Surface Prep, Small Line, Wanco, Yanmar