

To order go to Discount-Equipment.com

Load and weight on ground diagram DXR

Please read the operator's manual carefully and make sure you understand the instructions before using the machine.



English

TO PURCHASE THIS PRODUCT PLEASE CONTACT US



**Equipment Financing and
Extended Warranties Available**



**Discount-Equipment.com is your online resource for
commercial and industrial quality parts and equipment sales.**

561-964-4949

visit us on line @ www.discount-equipment.com

Select an option below to find your Equipment

Search by Manufacturer

Search by Product Type

Request a Quote

We sell worldwide for the brands: Genie, Terex, JLG, MultiQuip, Mikasa, Essick, Whiteman, Mayco, Toro Stone, Diamond Products, Generac Magnum, Airman, Haulotte, Barreto, Power Blanket, Nifty Lift, Atlas Copco, Chicago Pneumatic, Allmand, Miller Curber, Skyjack, Lull, Skytrak, Tsurumi, Husquvarna Target, Stow, Wacker, Sakai, Mi-T-M, Sullair, Basic, Dynapac, MBW, Weber, Bartell, Bennar Newman, Haulotte, Ditch Runner, Menegotti, Morrison, Contec, Buddy, Crown, Edco, Wyco, Bomag, Laymor, EZ Trench, Bil-Jax, F.S. Curtis, Gehl Pavers, Heli, Honda, ICS/PowerGrit, IHI, Partner, Imer, Clipper, MMD, Koshin, Rice, CH&E, General Equipment, Amida, Coleman, NAC, Gradall, Square Shooter, Kent, Stanley, Tamco, Toku, Hatz, Kohler, Robin, Wisconsin, Northrock, Oztec, Toker TK, Rol-Air, APT, Wylie, Ingersoll Rand / Doosan, Innovatech, Con X, Ammann, Mecalac, Makinex, Smith Surface Prep, Small Line, Wanco, Yanmar

CONTENTS

Contents

CONTENTS

Contents	2
LOAD AND WEIGHT ON GROUND DIAGRAMS	
General	3
Diagram explanations	3
LOAD AND WEIGHT ON GROUND DIAGRAMS DXR140	
1. On outriggers – forward	4
2. On outriggers – side	5
3. On outriggers – diagonal	6
4. On tracks - forward	7
LOAD AND WEIGHT ON GROUND DIAGRAMS DXR250	
1. On outriggers – forward	8
2. On outriggers – side	9
3. On outriggers – diagonal	10
4. On tracks - forward	11
LOAD AND WEIGHT ON GROUND DIAGRAMS DXR270	
1. On outriggers – forward	12
2. On outriggers – side	13
3. On outriggers – diagonal	14
4. On tracks - forward	15
LOAD AND WEIGHT ON GROUND DIAGRAMS DXR300	
1. On outriggers – forward	16
2. On outriggers – side	17
3. On outriggers – diagonal	18
4. On tracks - forward	19
LOAD AND WEIGHT ON GROUND DIAGRAMS DXR310	
1. On outriggers – forward	20
2. On outriggers – side	21
3. On outriggers – diagonal	22
4. On tracks - forward	23
GROUND PRESSURE	
Ground pressure	24

LOAD AND WEIGHT ON GROUND DIAGRAMS

General

The diagrams in this document show values for load and weight on ground for standard machines in static position. During use of machine, forces can be higher depending on type of work performed.

Values in diagrams are approximate and variations of +/-10% should be considered as normal.

The weight on ground values given in diagram shows values for each contact point to ground.

Four different positions for the machine are shown in diagrams.

1. On outriggers – forward - weight on ground will appear on two outriggers.
2. On outriggers – side - weight on ground will appear on two outriggers.
3. On outriggers – diagonal - weight on ground will appear on single outrigger.
4. On tracks - forward - weight on ground will appear on front end of both tracks.

Please read the operator's manual carefully and make sure you understand the instructions before using the machine.

Diagram explanations

Horizontal axis specifies distance from machine slewing center and load.

Vertical axis in top diagram specifies static load the machine can handle without tipping.

Vertical axis in the bottom diagram specifies static load the machine exerts on the floor.

To order go to Discount-Equipment.com

LOAD AND WEIGHT ON GROUND DIAGRAMS DXR140

1. On outriggers – forward DXR140 - weight on ground will appear on two outriggers.

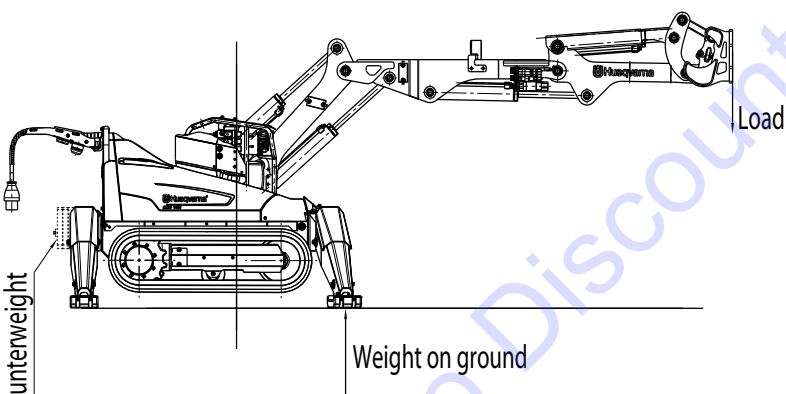
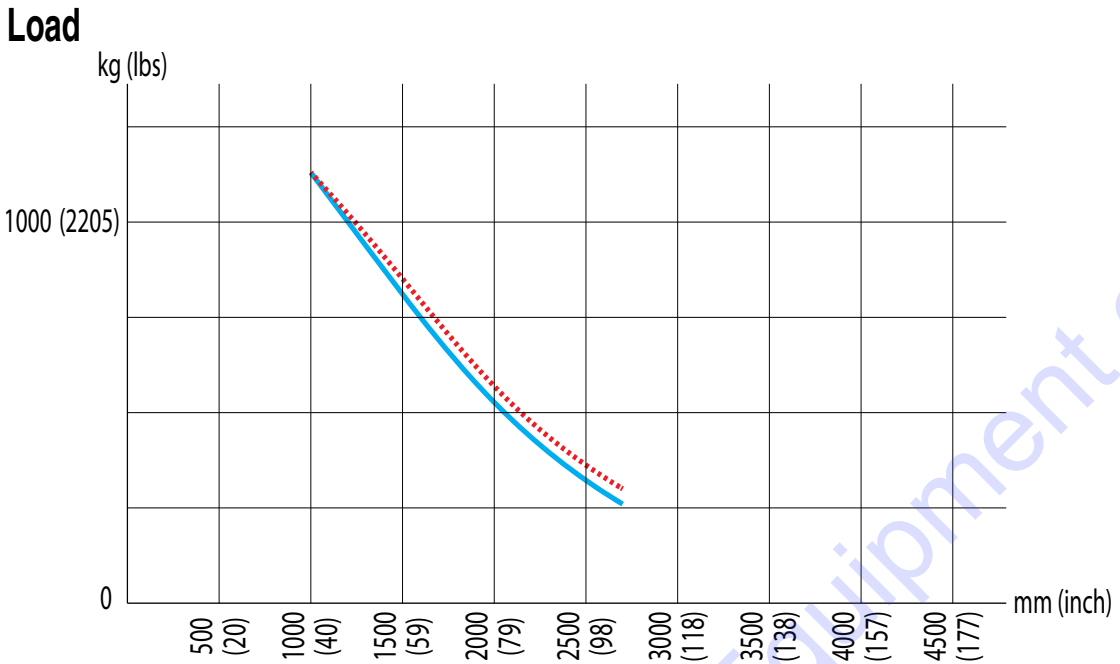

With optional counterweight
Standard machine

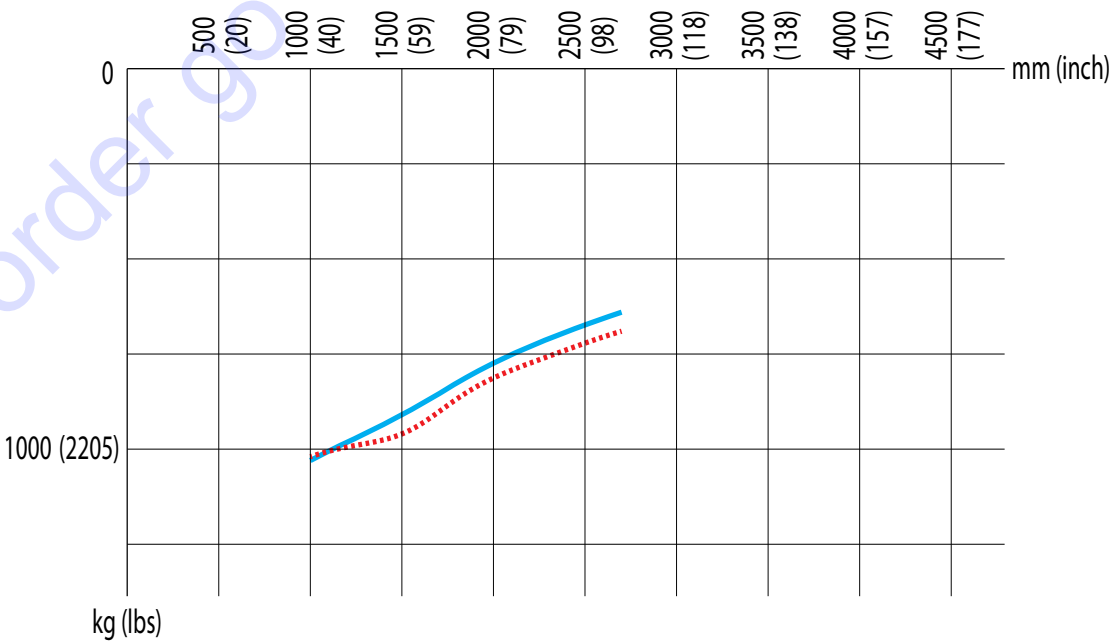

Weight on ground

LOAD AND WEIGHT ON GROUND DIAGRAMS DXR140

2. On outriggers – side DXR140 - weight on ground will appear on two outriggers.

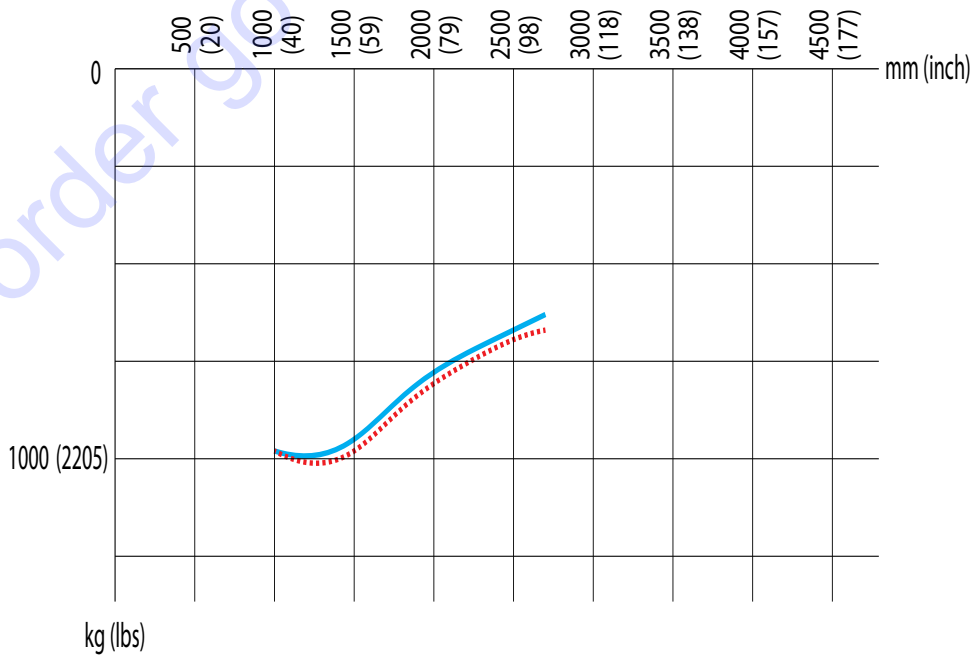
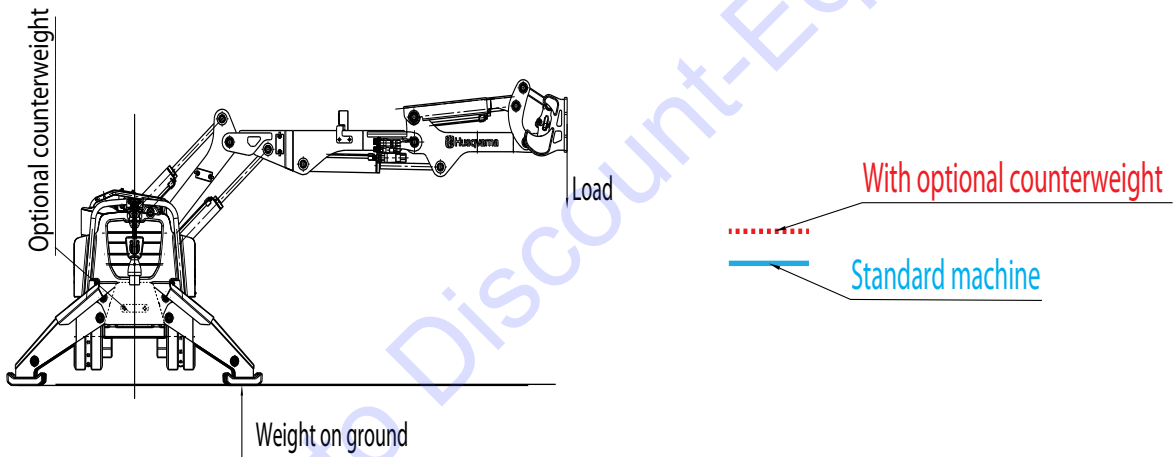
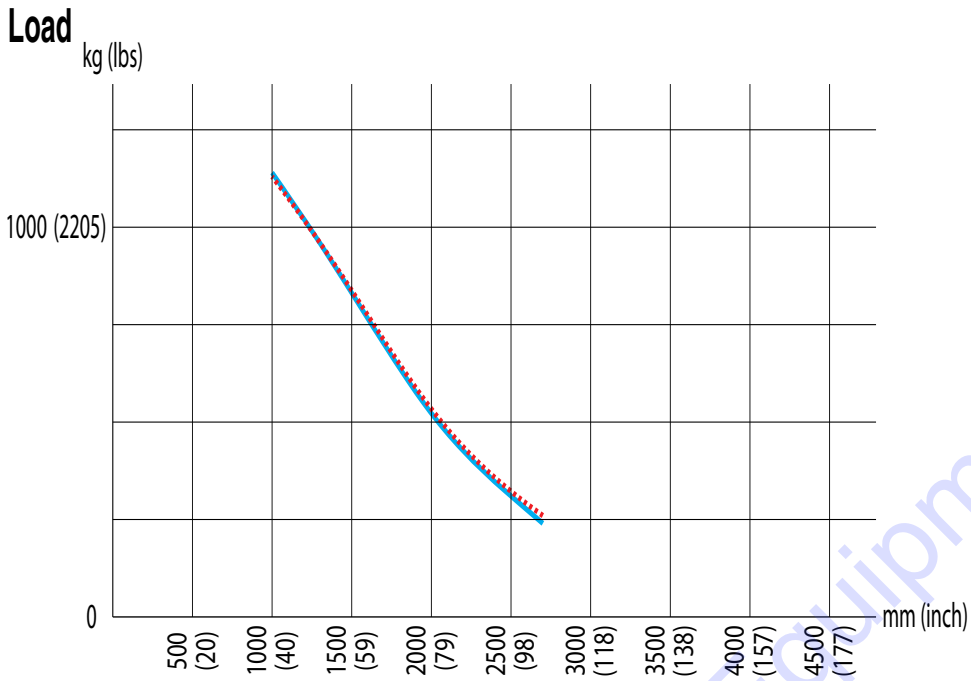

Weight on ground

LOAD AND WEIGHT ON GROUND DIAGRAMS DXR140

3. On outriggers – diagonal DXR140 - weight on ground will appear on single outrigger.

Load

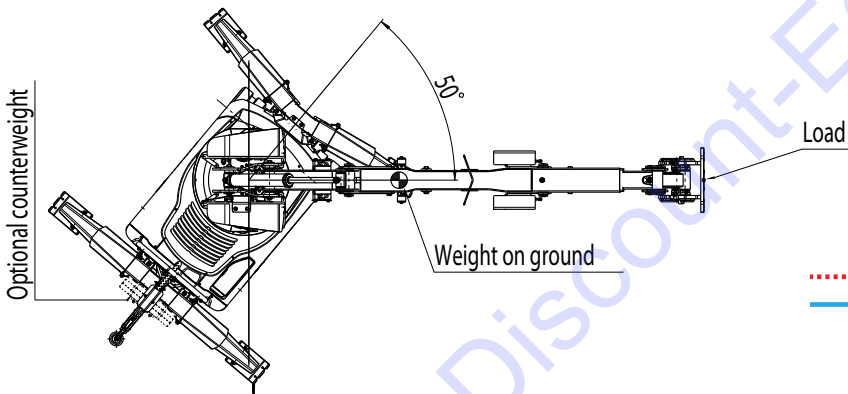
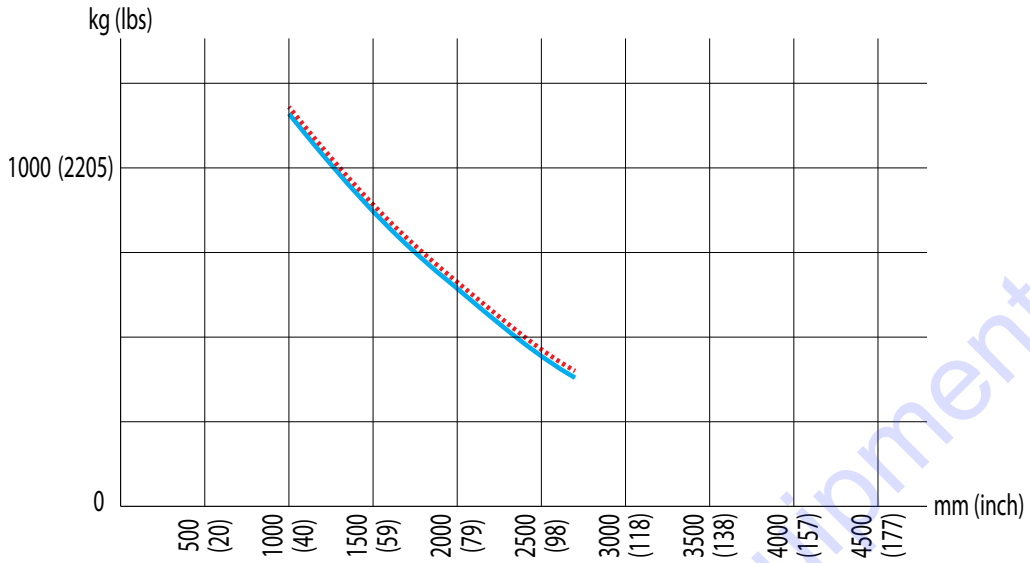

With optional counterweight
Standard machine

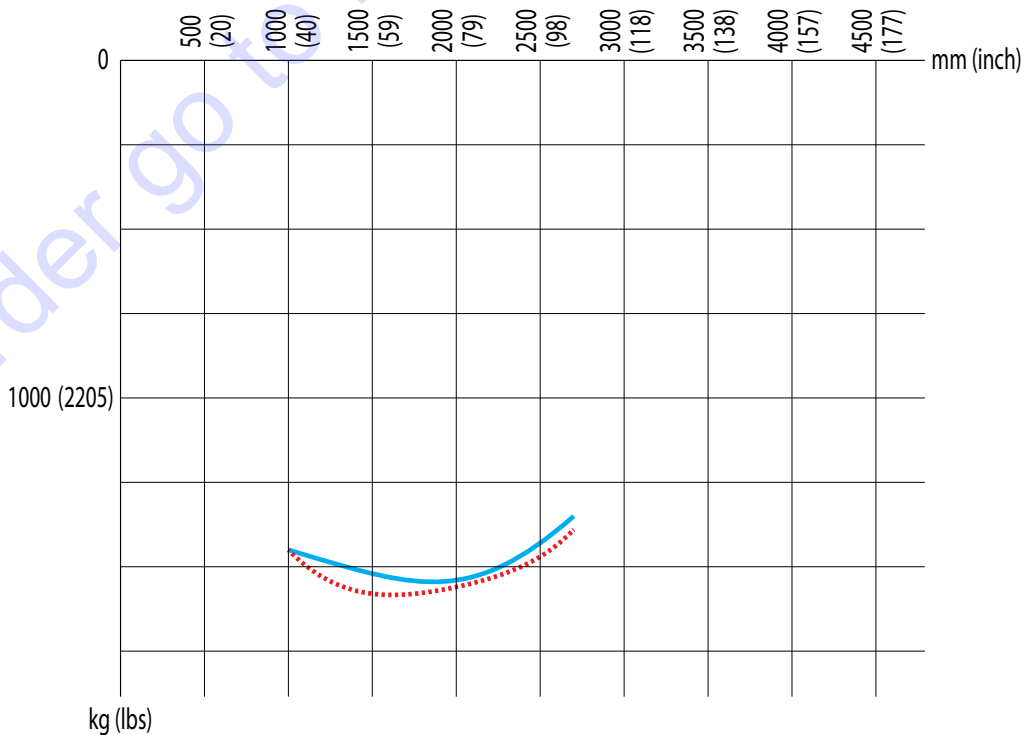

Weight on ground

LOAD AND WEIGHT ON GROUND DIAGRAMS DXR140

4. On tracks - forward DXR140 - weight on ground will appear on front end of both tracks.

Load

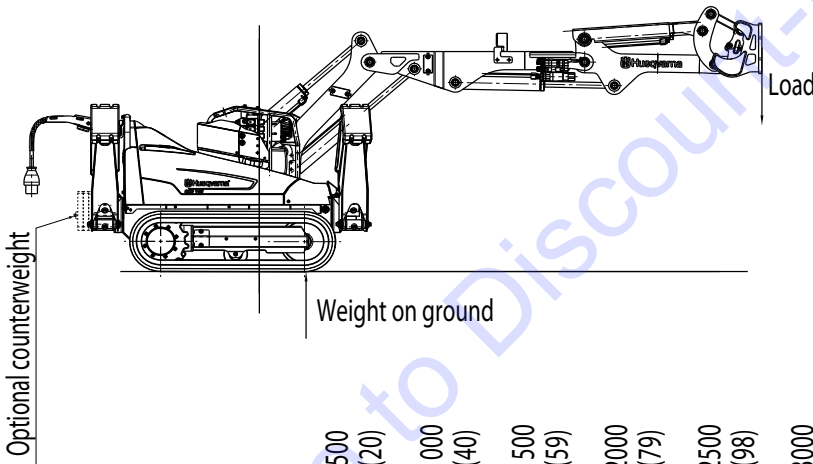
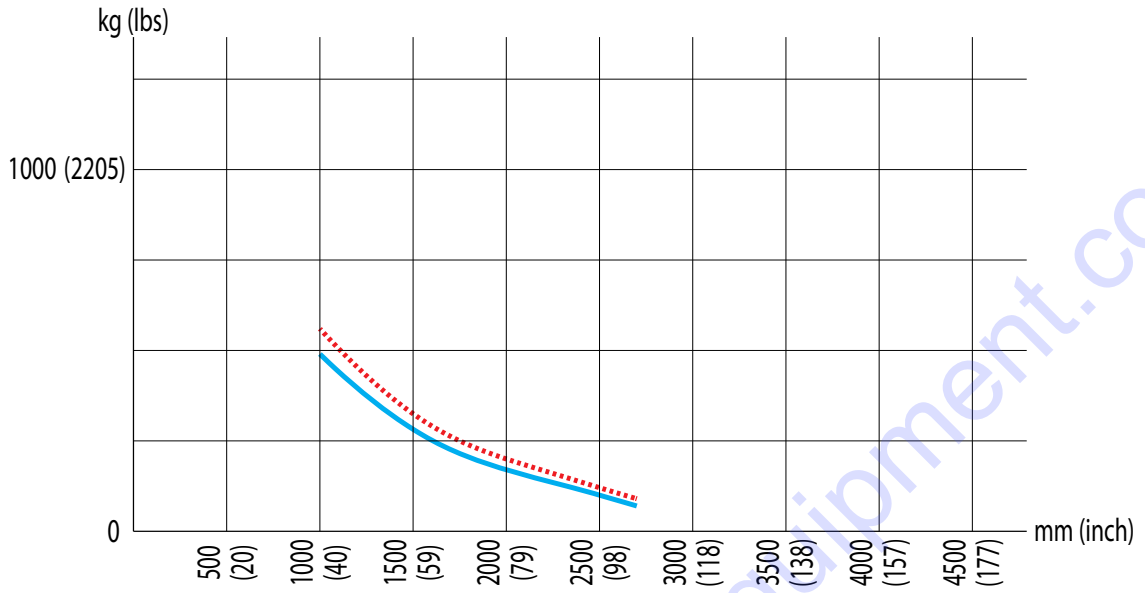

With optional counterweight
Standard machine

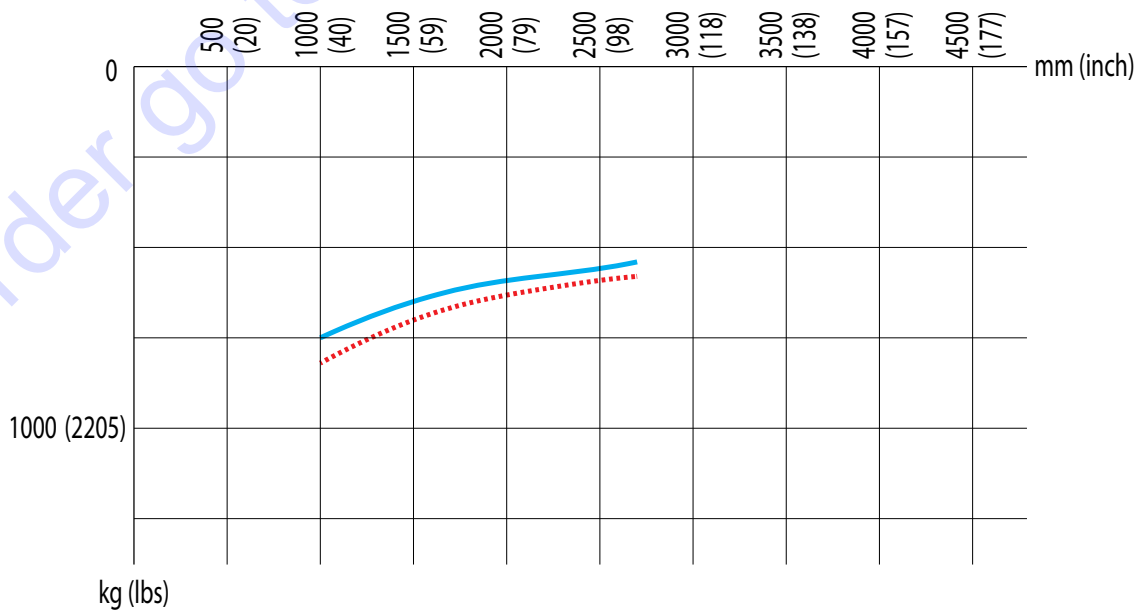

Weight on ground

LOAD AND WEIGHT ON GROUND DIAGRAMS DXR250

1. On outriggers – forward DXR250 - weight on ground will appear on two outriggers.

Load

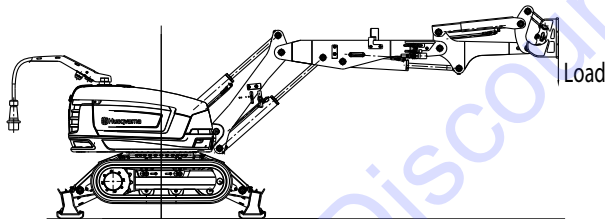
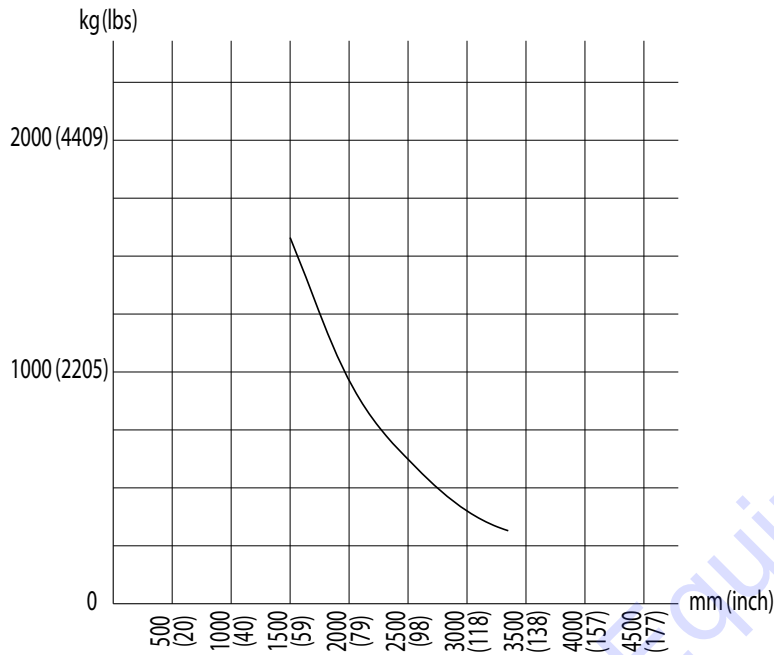

Weight on ground

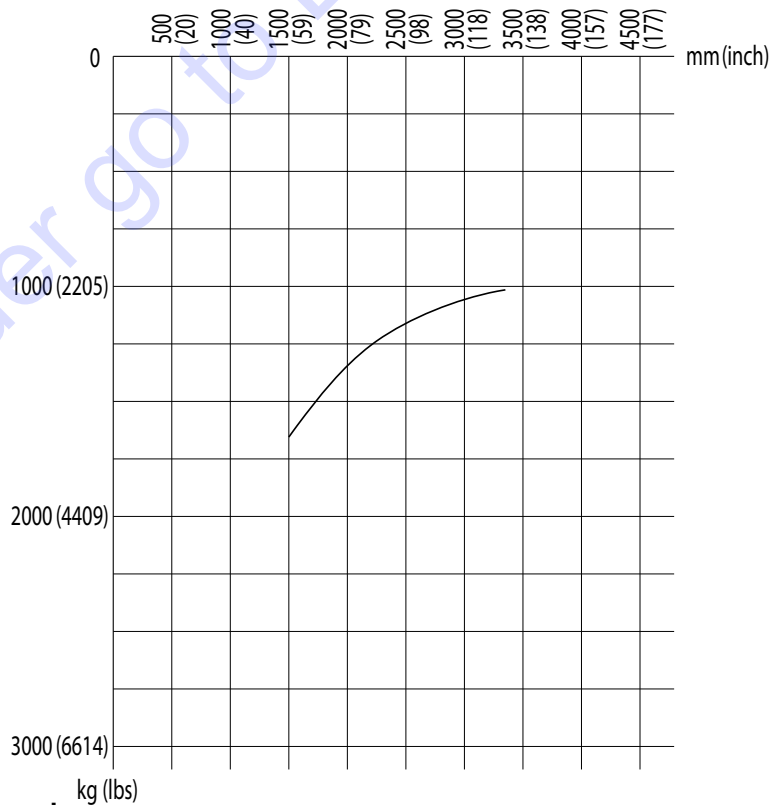

Weight on ground

LOAD AND WEIGHT ON GROUND DIAGRAMS DXR250

2. On outriggers – side DXR250 - weight on ground will appear on two outriggers.

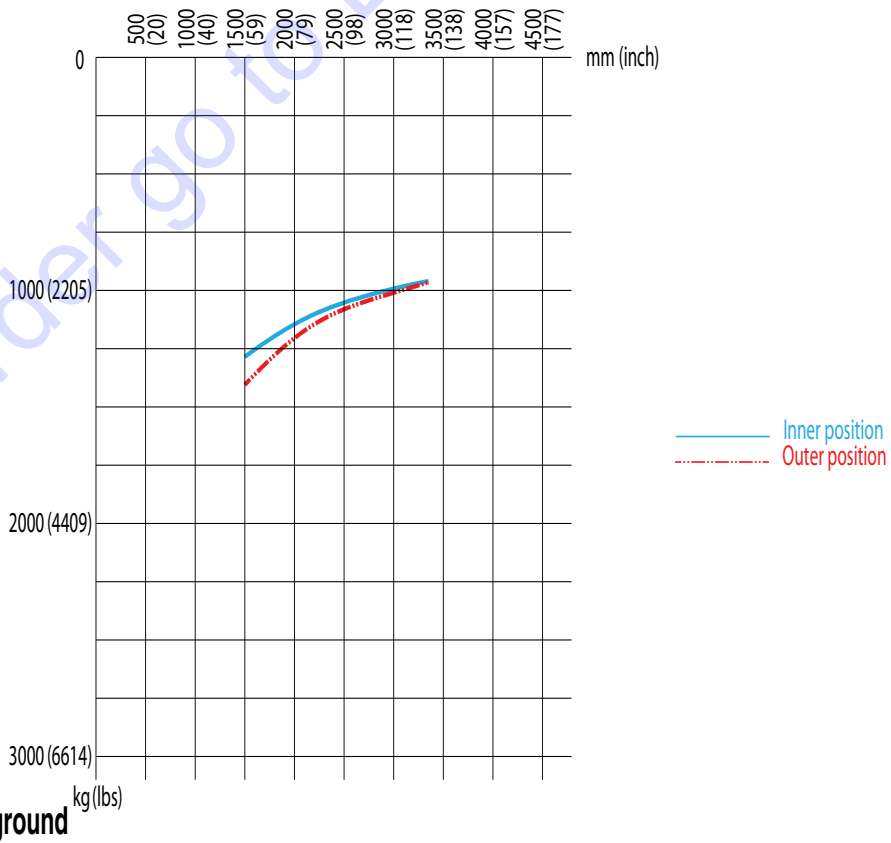
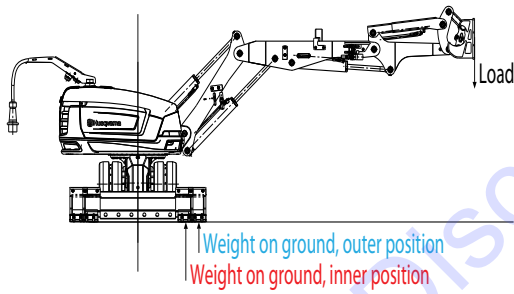
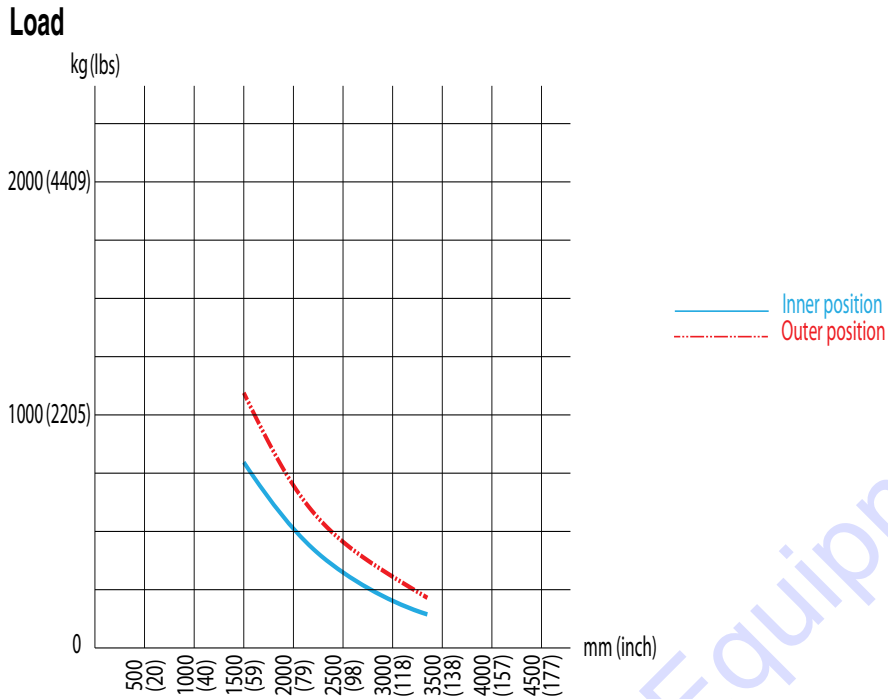

LOAD AND WEIGHT ON GROUND DIAGRAMS DXR250

3. On outriggers – diagonal DXR250 - weight on ground will appear on single outrigger.

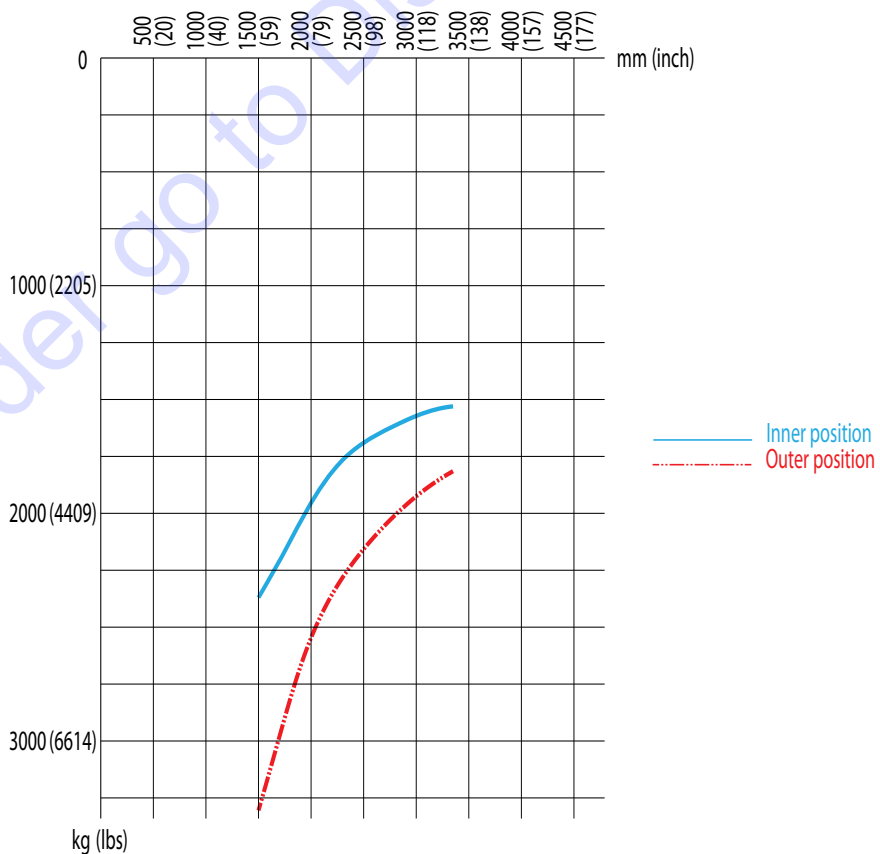
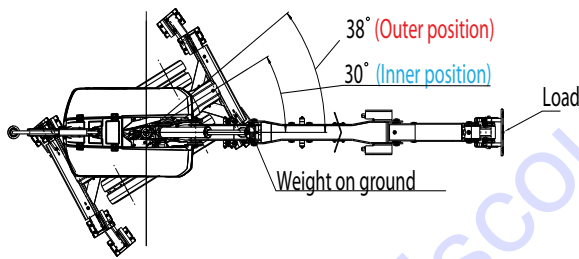
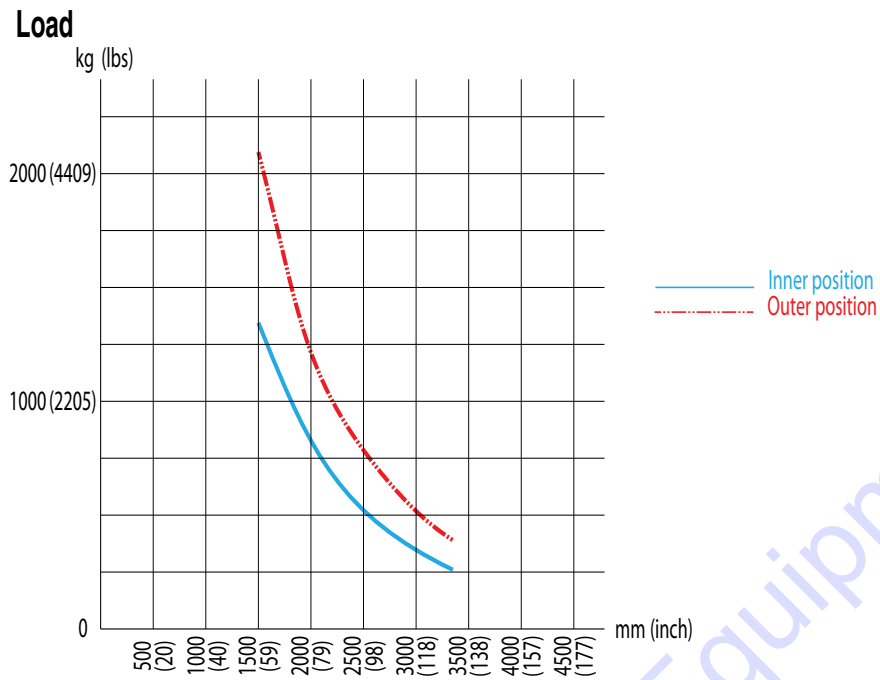

Weight on ground

LOAD AND WEIGHT ON GROUND DIAGRAMS DXR250

4. On tracks - forward DXR250 - weight on ground will appear on front end of both tracks.

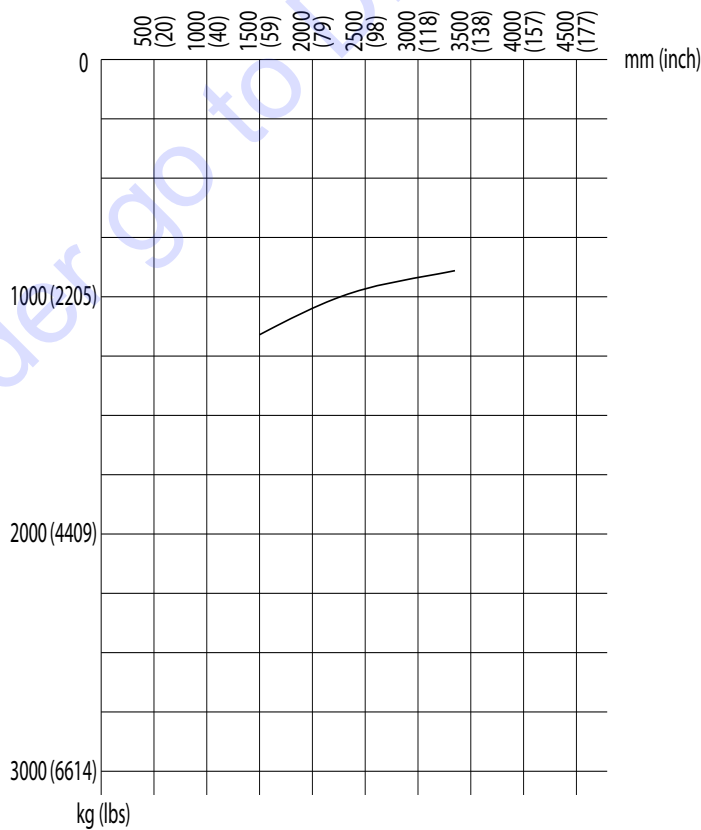
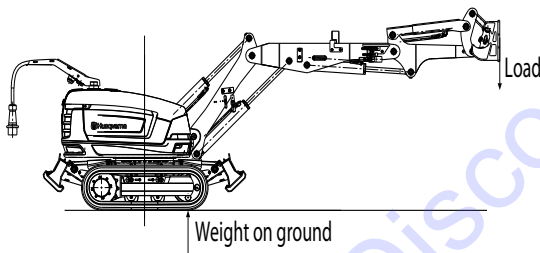
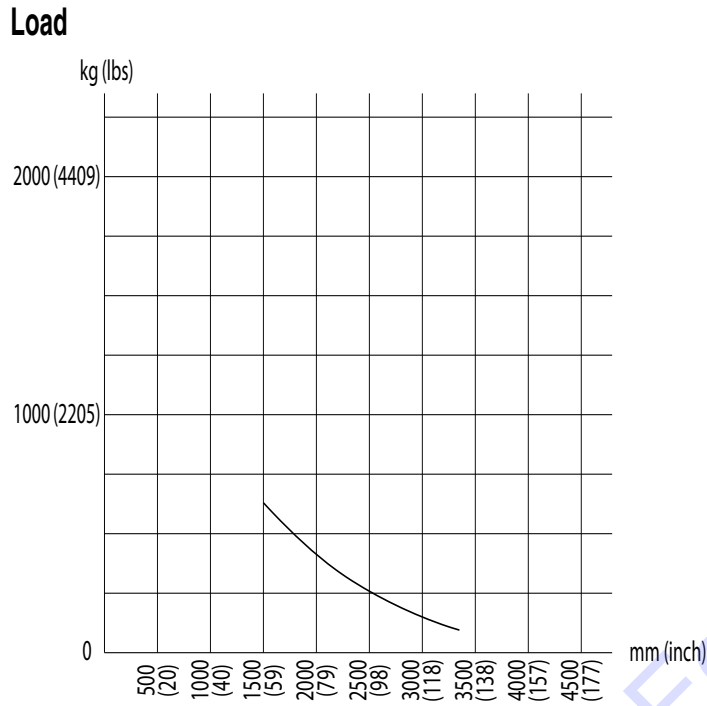

Weight on ground

LOAD AND WEIGHT ON GROUND DIAGRAMS DXR270

1. On outriggers – forward DXR270 - weight on ground will appear on two outriggers.

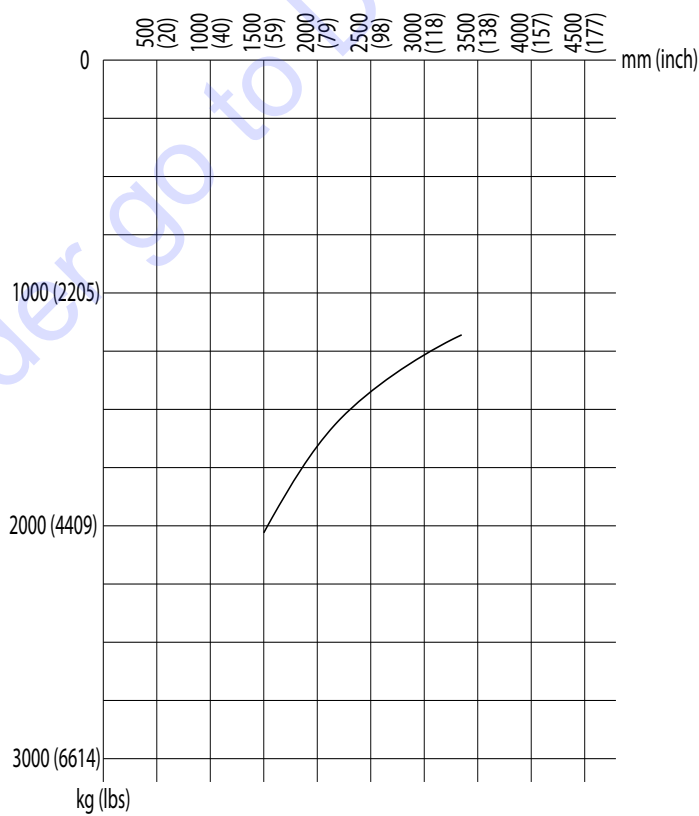
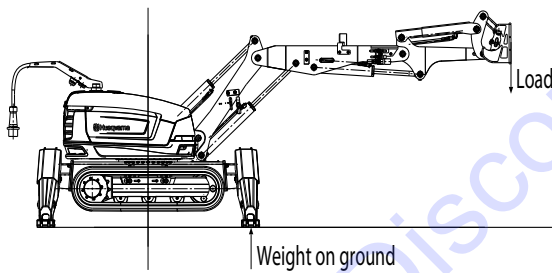
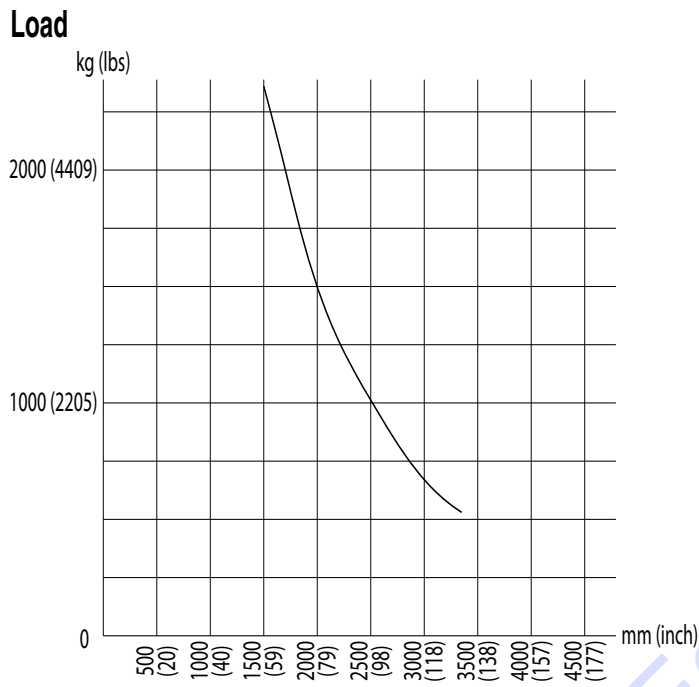

Weight on ground

LOAD AND WEIGHT ON GROUND DIAGRAMS DXR270

2. On outriggers – side DXR270 - weight on ground will appear on two outriggers.

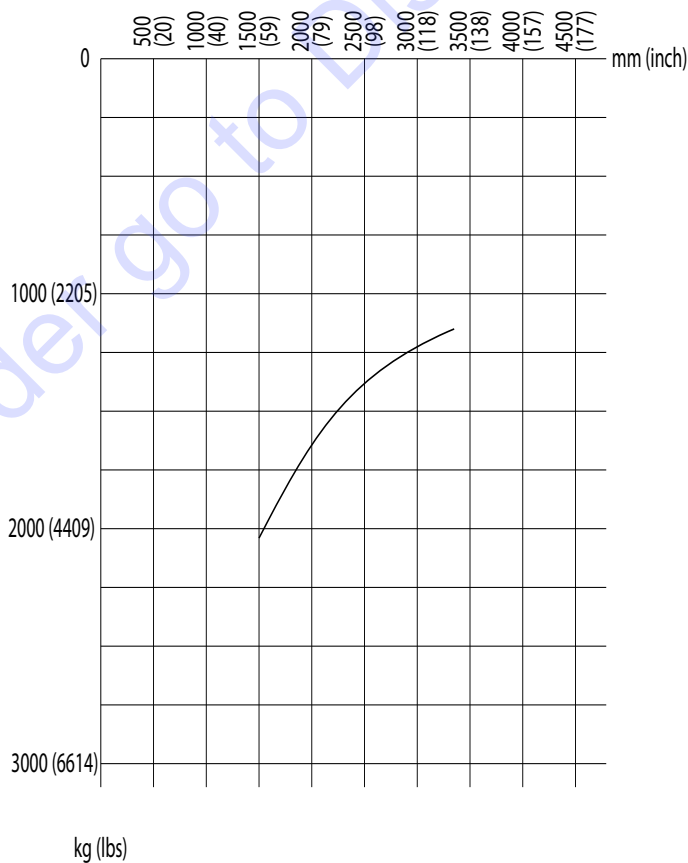
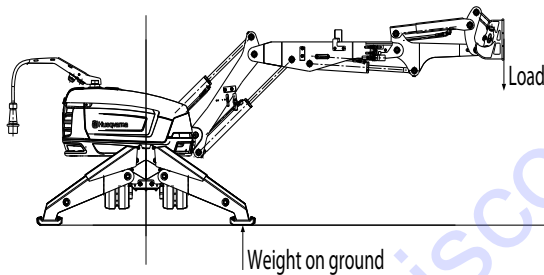
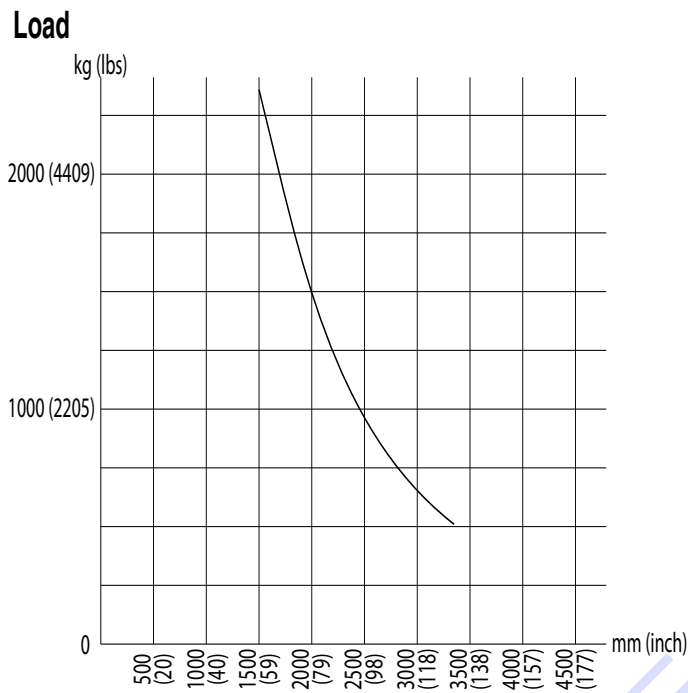

Weight on ground

LOAD AND WEIGHT ON GROUND DIAGRAMS DXR270

3. On outriggers – diagonal DXR270 - weight on ground will appear on single outrigger.

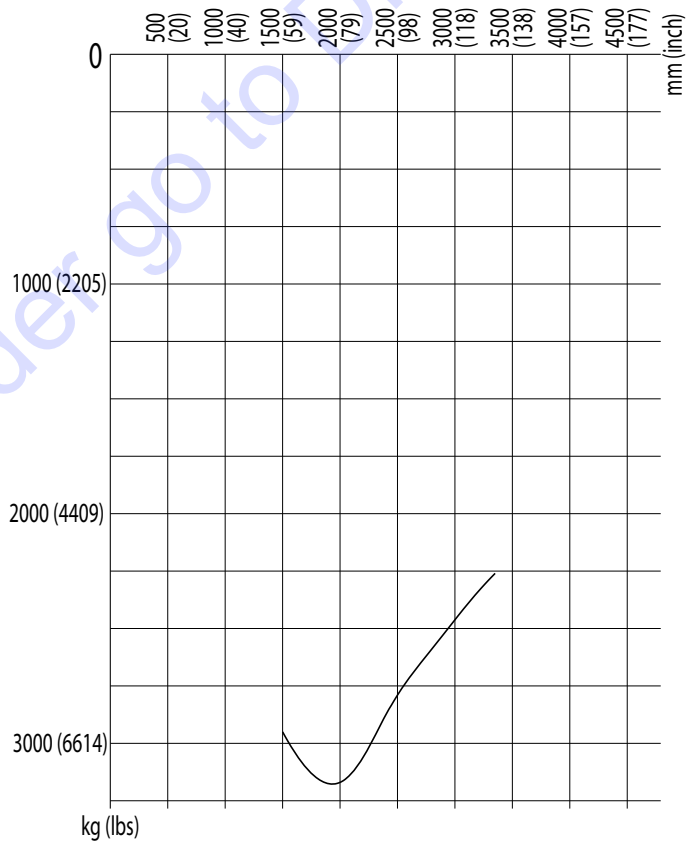
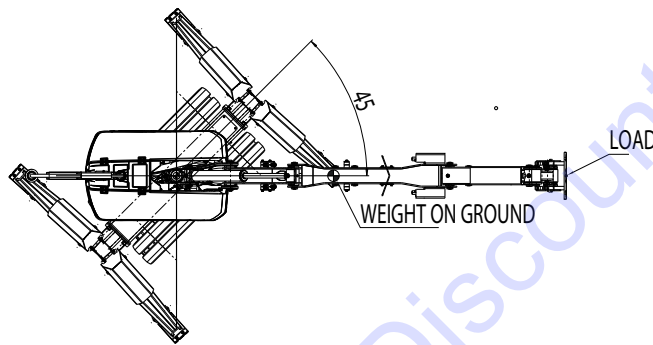
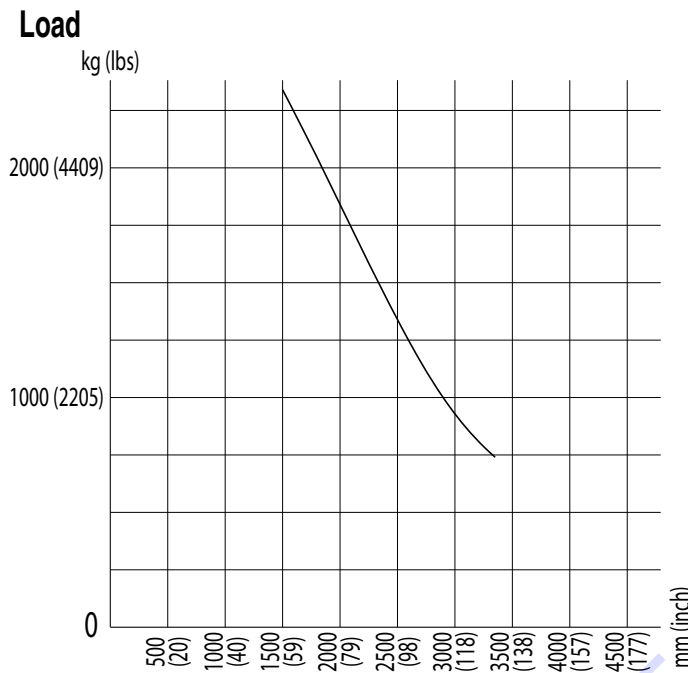

Weight on ground

LOAD AND WEIGHT ON GROUND DIAGRAMS DXR270

4. On tracks - forward DXR270 - weight on ground will appear on front end of both tracks.

Load

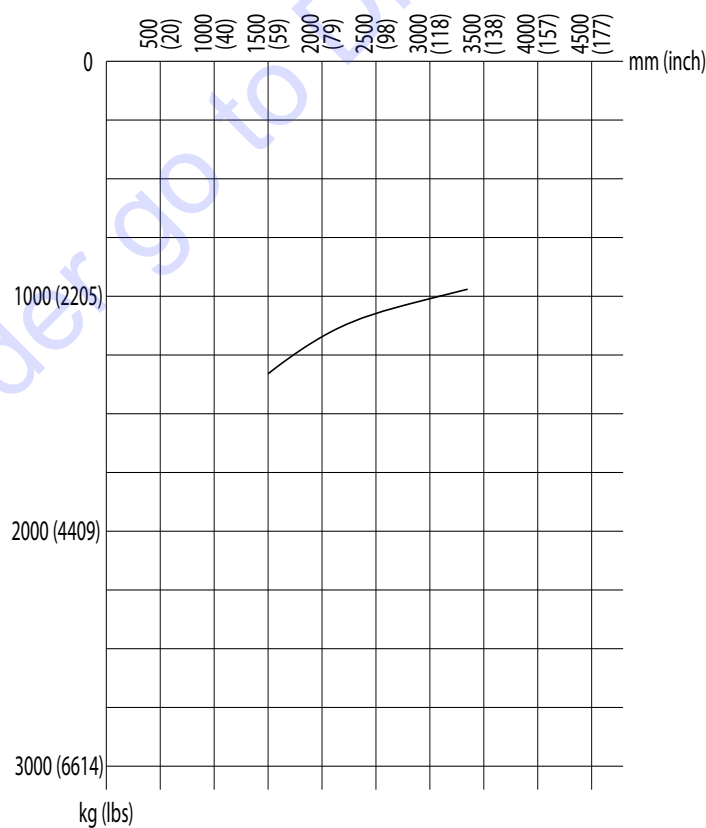
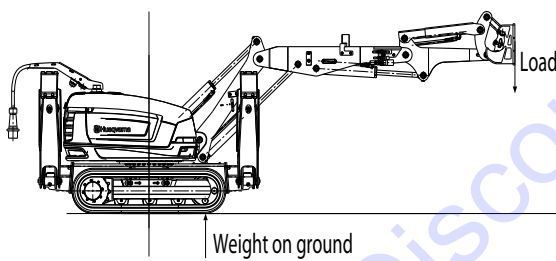
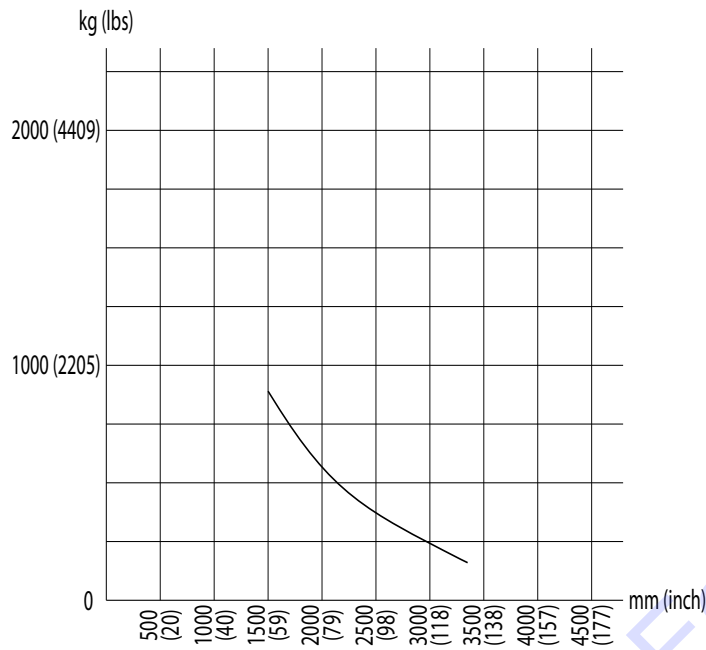

Weight on ground

LOAD AND WEIGHT ON GROUND DIAGRAMS DXR300

1. On outriggers – forward DXR300 - weight on ground will appear on two outriggers.

Load

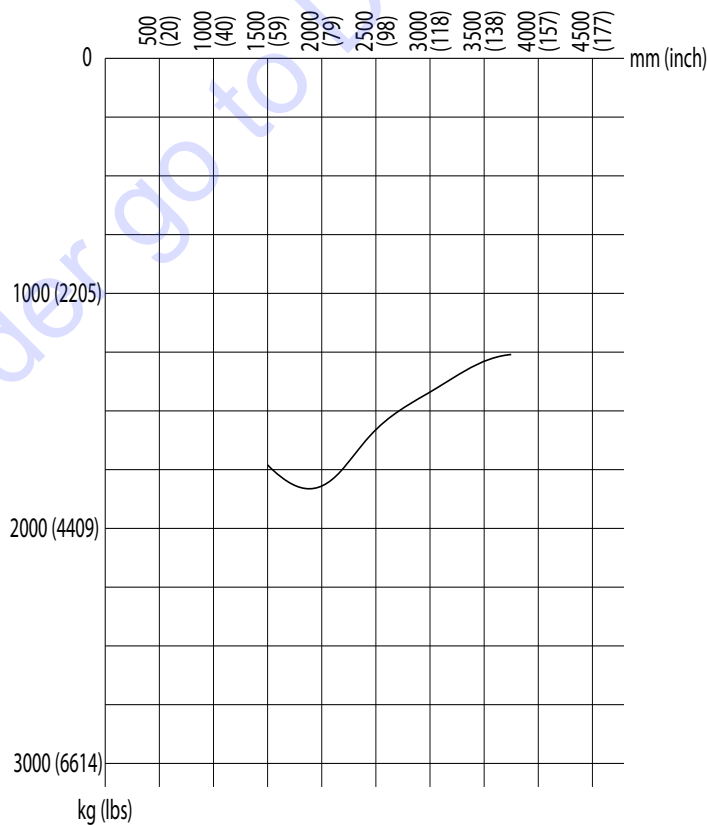
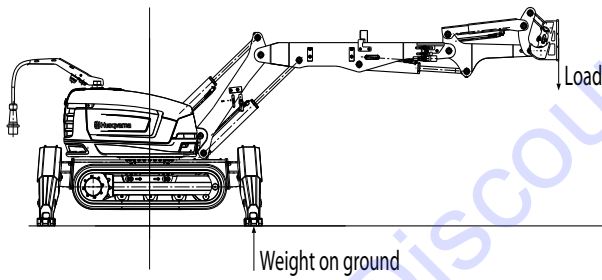
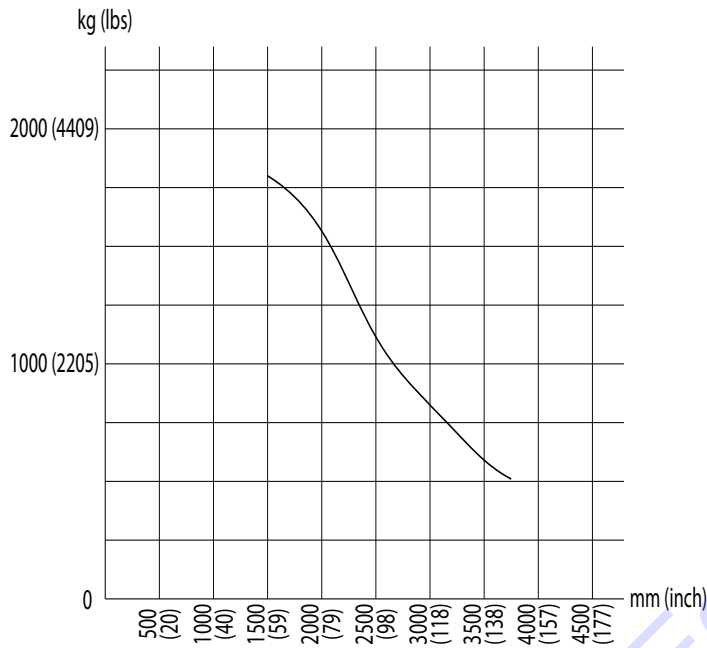

Weight on ground

LOAD AND WEIGHT ON GROUND DIAGRAMS DXR300

2. On outriggers – side DXR300 - weight on ground will appear on two outriggers.

Load

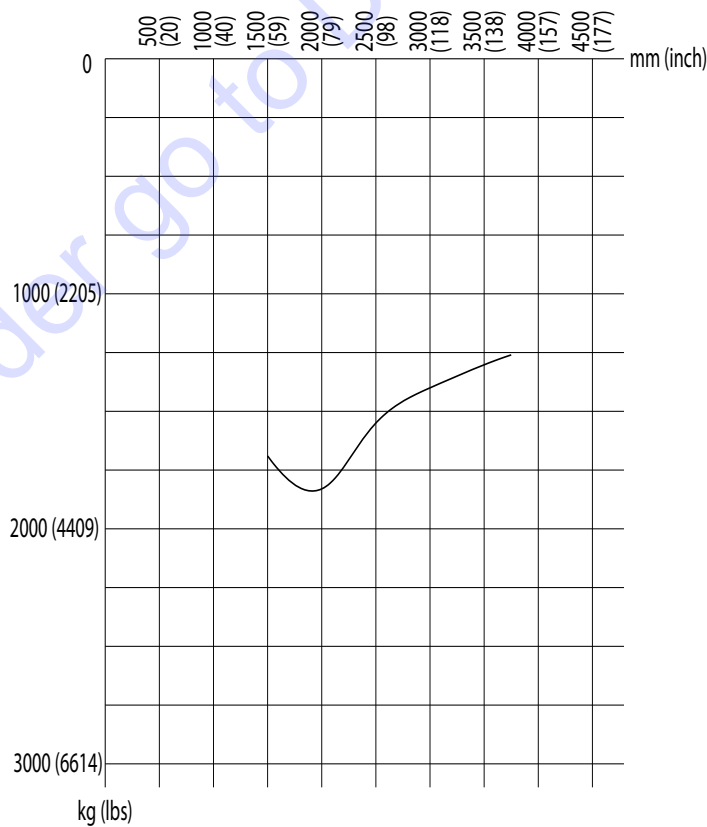
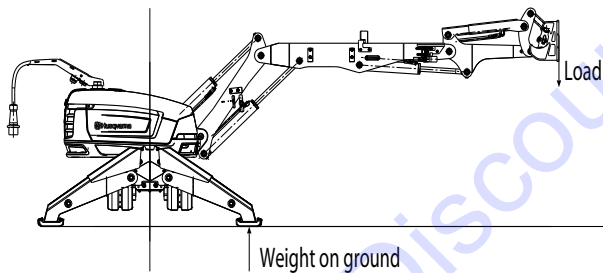
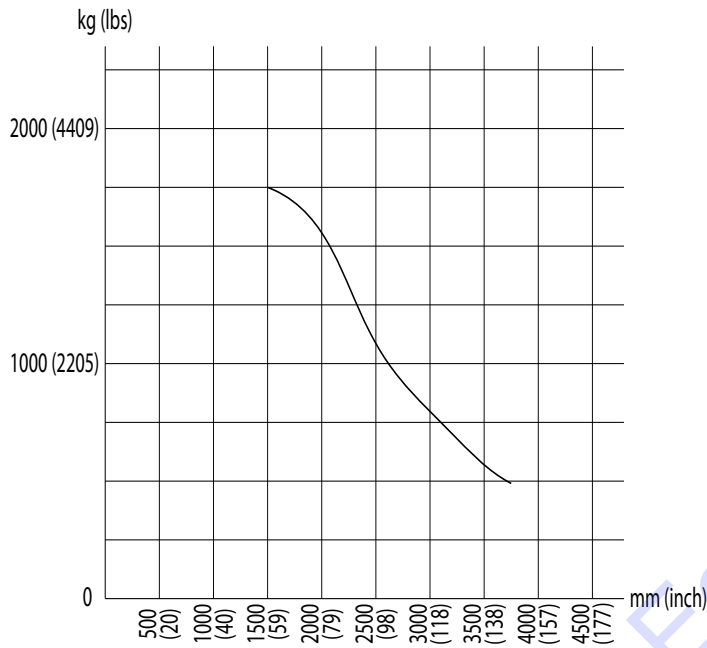

Weight on ground

LOAD AND WEIGHT ON GROUND DIAGRAMS DXR300

3. On outriggers – diagonal DXR300 - weight on ground will appear on single outrigger.

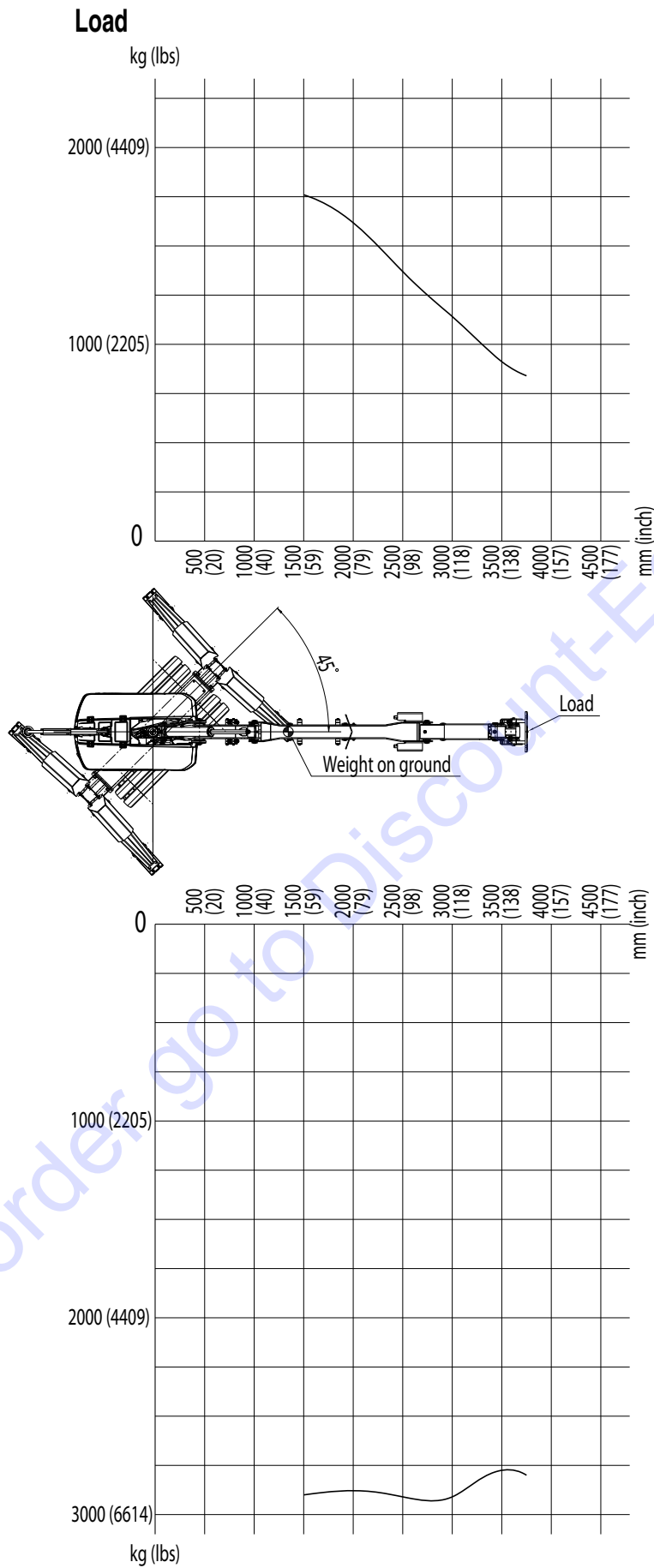

Weight on ground

LOAD AND WEIGHT ON GROUND DIAGRAMS DXR300

4. On tracks - forward DXR300 - weight on ground will appear on front end of both tracks.

Load

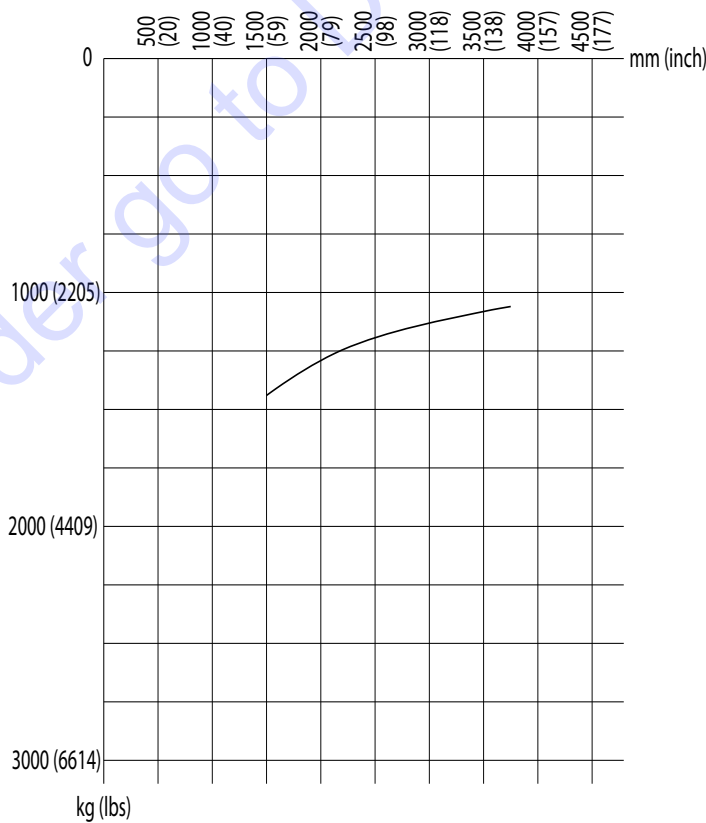
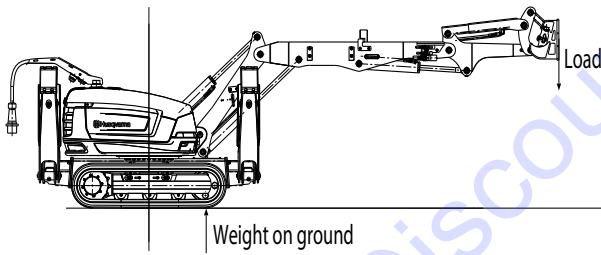
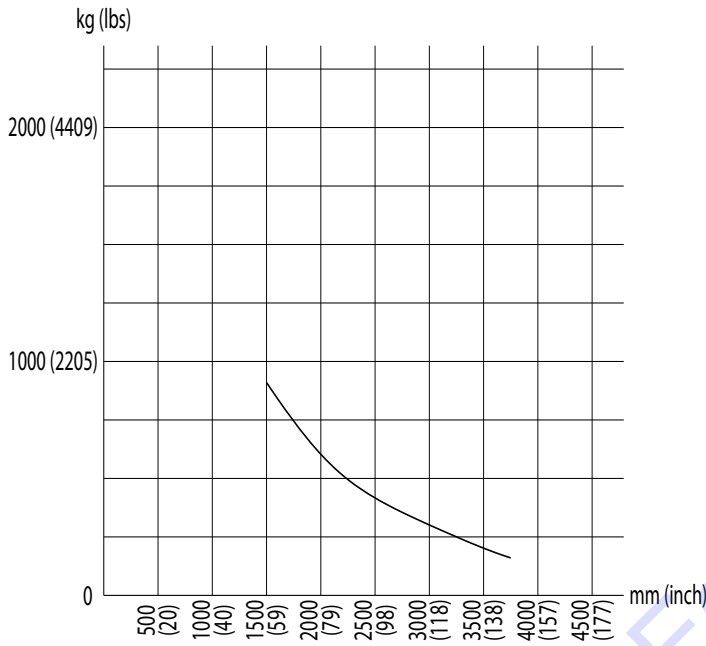

Weight on ground

LOAD AND WEIGHT ON GROUND DIAGRAMS DXR310

1. On outriggers – forward DXR310 - weight on ground will appear on two outriggers.

Load

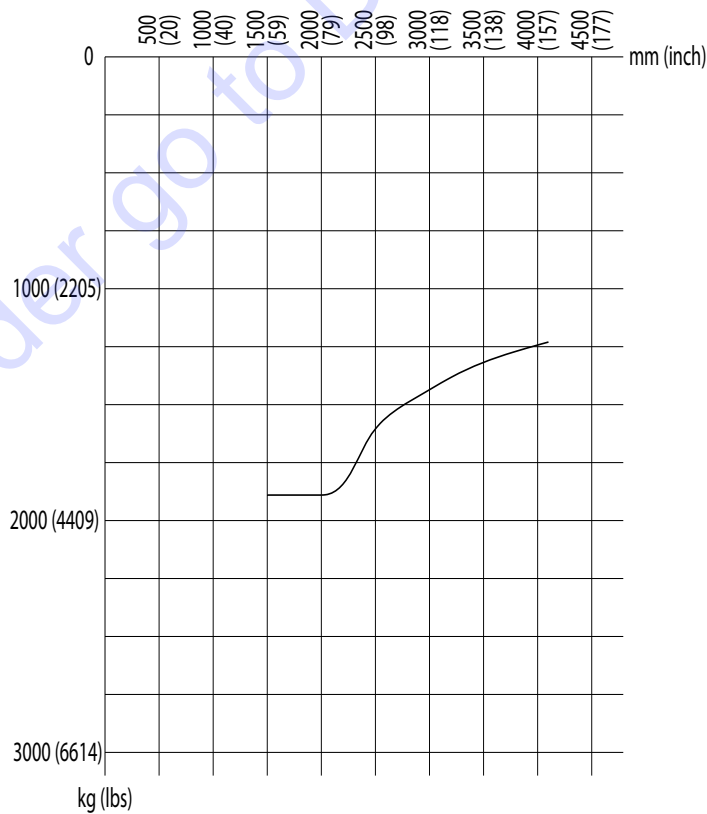
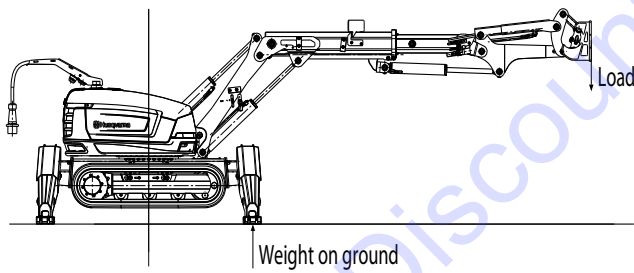
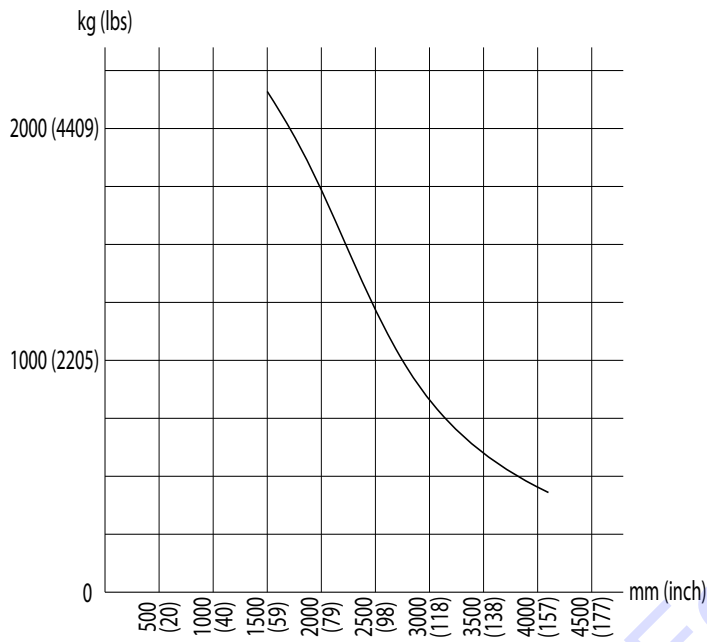

Weight on ground

LOAD AND WEIGHT ON GROUND DIAGRAMS DXR310

2. On outriggers – side DXR310 - weight on ground will appear on two outriggers.

Load

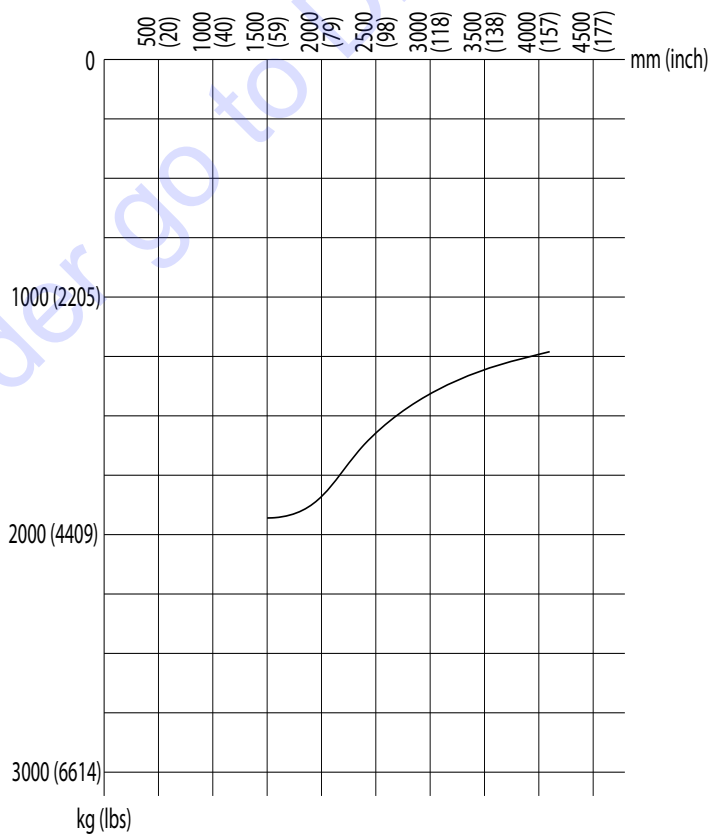
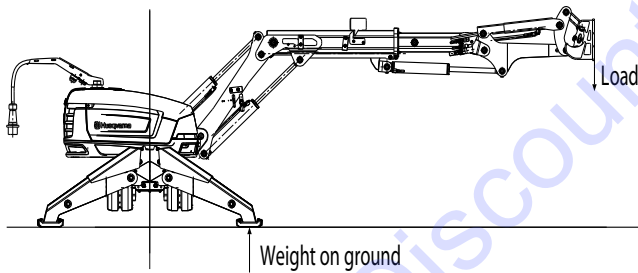
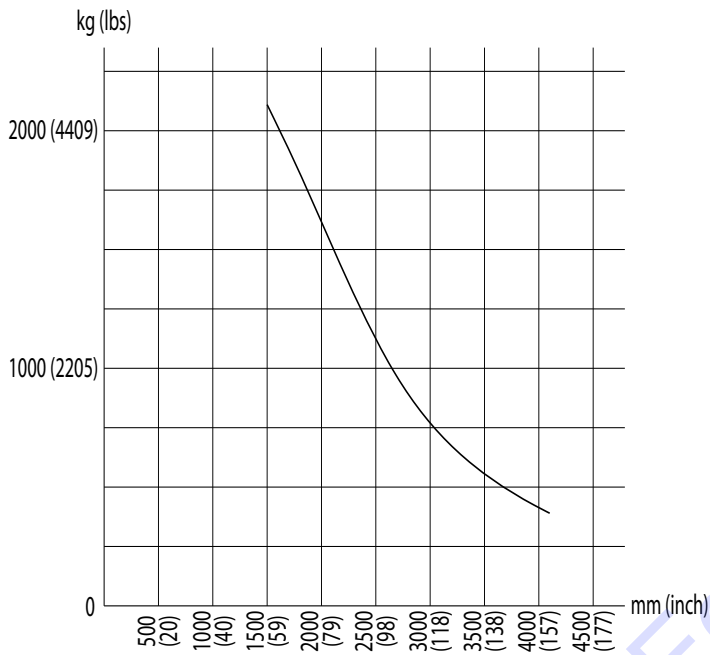

Weight on ground

LOAD AND WEIGHT ON GROUND DIAGRAMS DXR310

3. On outriggers – diagonal DXR310 - weight on ground will appear on single outrigger.

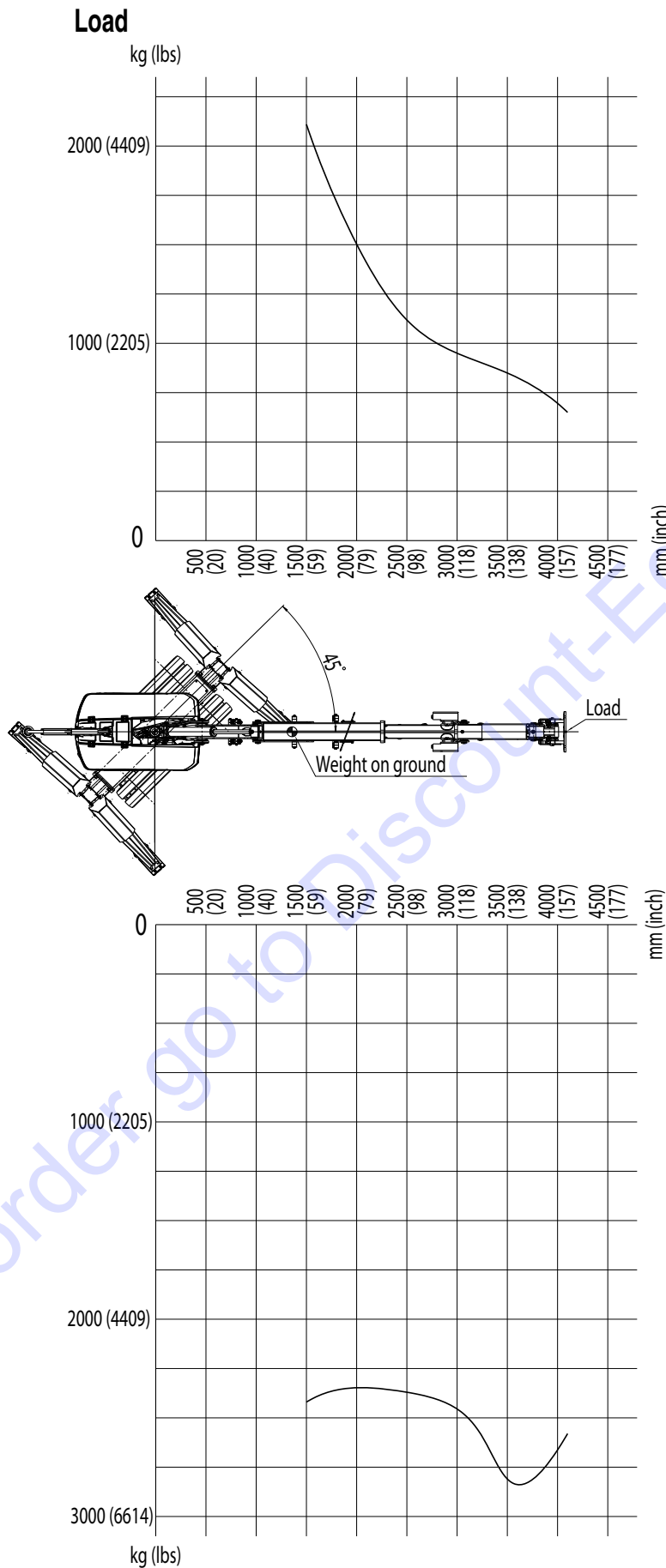

Weight on ground

LOAD AND WEIGHT ON GROUND DIAGRAMS DXR310

4. On tracks - forward DXR310 - weight on ground will appear on front end of both tracks.

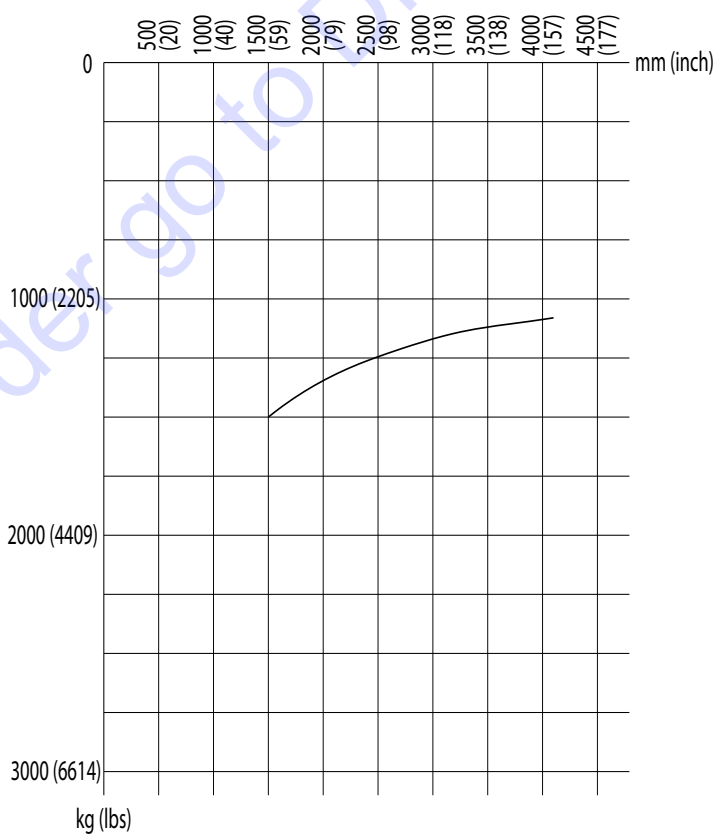
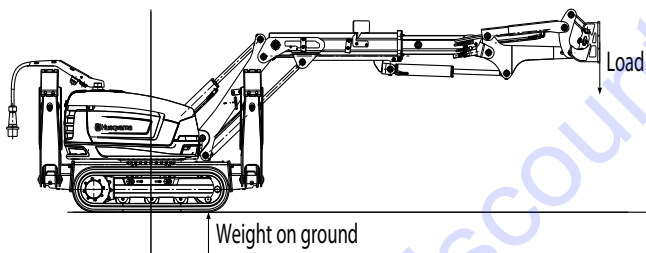
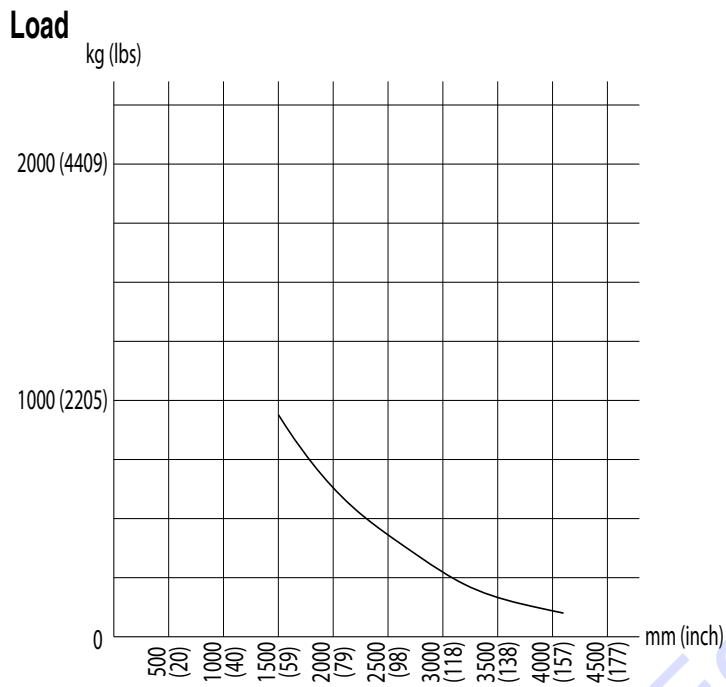

Weight on ground

GROUND PRESSURE

Ground pressure

NOTICE! The content of this section is for the purpose of providing reference information only. Husqvarna assume no warranty or liability for its content or its correctness. Husqvarna will have no responsibility or liability for any damage arising as a result of any inaccuracy in the information provided herein. Any use of the information provided herein shall occur at the user's own risk.

- 1 Weight including hammer, divided on area enclosed by outrigger support points.
- 2 Weight including hammer, divided on track contact surface.
- 3 Max point load measured at tip over load, weight including hammer.

	1) Propagated load		2) Load from tracks		3) Max point load on outriggers	
	(kg/m ²)	(lbs/ft ²)	(kg/m ²)	(lbs/ft ²)	(kg)	(lbs)
DXR140*	458	94	4136	851	1158	2553
DXR250**	776	159	4903	1002	1863	4107
DXR270**	479	98	4152	845	1993	4394
DXR300**	530	108	4590	934	2203	4857
DXR300***	552	113	4781	973	2295	5060
DXR310**	544	111	4715	959	2263	4989

*Breaker SB152, **Breaker SB202, ***Breaker SB302

NOTICE! All values are static loads where numbers are subject to change without notice. Please consult with the engineer at the site. Husqvarna assumes no liability for accidents.

Measurement contact surfaces

	1) A x B		2) A x B		3) A x B	
	(mm)	(inch)	(mm)	(inch)	(mm)	(inch)
DXR140	1610 x 1572	63,4 x 61,9	790 x 180	31,1 x 7,1	149 x 172	5,9 x 6,8
DXR250	1748 x 1371	68,1 x 54	828 x 230	32,6 x 9,1	177 x 151	7 x 5,9
DXR270	2071 x 2008	81,5 x 79	1044 x 230	32,6 x 9,1	149 x 172	5,9 x 6,8
DXR300	2071 x 2008	81,5 x 79	1044 x 230	32,6 x 9,1	149 x 172	5,9 x 6,8
DXR310	2071 x 2008	81,5 x 79	1044 x 230	32,6 x 9,1	149 x 172	5,9 x 6,8

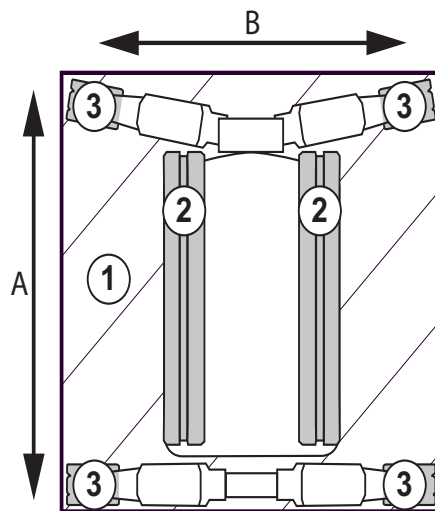

NOTICE! All values are static loads where numbers are subject to change without notice. Please consult with the engineer at the site. Husqvarna assumes no liability for accidents.

To order go to Discount-Equipment.com

1157581-26



2016-10-19

TO PURCHASE THIS PRODUCT PLEASE CONTACT US



**Equipment Financing and
Extended Warranties Available**



**Discount-Equipment.com is your online resource for
commercial and industrial quality parts and equipment sales.**

561-964-4949

visit us on line @ www.discount-equipment.com

Select an option below to find your Equipment

Search by Manufacturer

Search by Product Type

Request a Quote

We sell worldwide for the brands: Genie, Terex, JLG, MultiQuip, Mikasa, Essick, Whiteman, Mayco, Toro Stone, Diamond Products, Generac Magnum, Airman, Haulotte, Barreto, Power Blanket, Nifty Lift, Atlas Copco, Chicago Pneumatic, Allmand, Miller Curber, Skyjack, Lull, Skytrak, Tsurumi, Husquvarna Target, Stow, Wacker, Sakai, Mi-T-M, Sullair, Basic, Dynapac, MBW, Weber, Bartell, Bennar Newman, Haulotte, Ditch Runner, Menegotti, Morrison, Contec, Buddy, Crown, Edco, Wyco, Bomag, Laymor, EZ Trench, Bil-Jax, F.S. Curtis, Gehl Pavers, Heli, Honda, ICS/PowerGrit, IHI, Partner, Imer, Clipper, MMD, Koshin, Rice, CH&E, General Equipment, Amida, Coleman, NAC, Gradall, Square Shooter, Kent, Stanley, Tamco, Toku, Hatz, Kohler, Robin, Wisconsin, Northrock, Oztec, Toker TK, Rol-Air, APT, Wylie, Ingersoll Rand / Doosan, Innovatech, Con X, Ammann, Mecalac, Makinex, Smith Surface Prep, Small Line, Wanco, Yanmar