

Operator's manual
K 770, K 770 Rescue,
K 770 OilGuard

Please read the operator's manual carefully and make sure you understand the instructions before using the machine.



English

TO PURCHASE THIS PRODUCT PLEASE CONTACT US



**Equipment Financing and
Extended Warranties Available**



**Discount-Equipment.com is your online resource for
commercial and industrial quality parts and equipment sales.**

561-964-4949

visit us on line @ www.discount-equipment.com

Select an option below to find your Equipment

Search by Manufacturer

Search by Product Type

Request a Quote

We sell worldwide for the brands: Genie, Terex, JLG, MultiQuip, Mikasa, Essick, Whiteman, Mayco, Toro Stone, Diamond Products, Generac Magnum, Airman, Haulotte, Barreto, Power Blanket, Nifty Lift, Atlas Copco, Chicago Pneumatic, Allmand, Miller Curber, Skyjack, Lull, Skytrak, Tsurumi, Husquvarna Target, Stow, Wacker, Sakai, Mi-T-M, Sullair, Basic, Dynapac, MBW, Weber, Bartell, Bennar Newman, Haulotte, Ditch Runner, Menegotti, Morrison, Contec, Buddy, Crown, Edco, Wyco, Bomag, Laymor, EZ Trench, Bil-Jax, F.S. Curtis, Gehl Pavers, Heli, Honda, ICS/PowerGrit, IHI, Partner, Imer, Clipper, MMD, Koshin, Rice, CH&E, General Equipment, Amida, Coleman, NAC, Gradall, Square Shooter, Kent, Stanley, Tamco, Toku, Hatz, Kohler, Robin, Wisconsin, Northrock, Oztec, Toker TK, Rol-Air, APT, Wylie, Ingersoll Rand / Doosan, Innovatech, Con X, Ammann, Mecalac, Makinex, Smith Surface Prep, Small Line, Wanco, Yanmar

KEY TO SYMBOLS

Manual version

This manual is the International version used for all English speaking countries outside North America. If you operate in North America use the US-version.

Symbols on the machine

WARNING! The machine can be a dangerous tool if used incorrectly or carelessly, which can cause serious or fatal injury to the operator or others. Please read the operator's manual carefully and make sure you understand the instructions before using the machine.

Wear personal protective equipment. See instructions under the "Personal protective equipment" heading.

This product is in accordance with applicable EC directives.

WARNING! Dust forms when cutting, this can cause injuries if inhaled. Use an approved breathing mask. Avoid inhaling exhaust fumes. Always provide for good ventilation.

WARNING! Kickbacks can be sudden, rapid and violent and can cause life threatening injuries. Read and understand the instructions in the manual before using the machine.

WARNING! Sparks from the cutting blade can cause fire in combustible materials such as: petrol (gas), wood, clothes, dry grass etc.

Ensure the blades are not cracked or damaged in any other way.

Do not use circular saw blades

Choke.

Air purge

Decompression valve



Starter handle



Refuelling, petrol/oil mix



Starting instruction decal See instructions under the heading Starting and stopping.



Cutting equipment decal

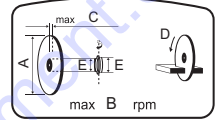

A= Cutting blade diameter

B= Max. speed of output shaft

C= Max blade thickness

D= Direction of blade rotation

E= Bushing dimension

Noise emission to the environment according to the European Community's Directive. The machine's emission is specified in the Technical data chapter and on the label.



Rating plate

Row 1: Brand, Model (X, Y)

Row 2: Serial No. with manufacturing date (Y, W, X): Year, Week, Sequence No.

Row 3: Product No. (X)

Row 4: Manufacturer

Row 5: Manufacturer address

Row 6-7: If applicable, EC typ-approval (X, Y): Approval code, Approval stage or Chinese MEIN number

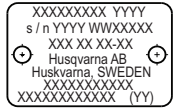

Other symbols/decals on the machine refer to special certification requirements for certain markets.



KEY TO SYMBOLS

Explanation of warning levels

The warnings are graded in three levels.

WARNING!



WARNING! Indicates a hazardous situation which, if not avoided, will result in death or serious injury.

CAUTION!



CAUTION! Indicates a hazardous situation which, if not avoided, could result in minor or moderate injury.

NOTICE!

NOTICE! Is used to address practices not related to personal injury.

To order go to Discount-Equipment.com

CONTENTS

Contents

KEY TO SYMBOLS

Manual version	2
Symbols on the machine	2
Explanation of warning levels	3

CONTENTS

Contents	4
----------------	---

PRESENTATION

Dear Customer,	5
Design and features	5

PRESENTATION

What is what on the power cutter - K 770, K 770 OilGuard?	7
---	---

PRESENTATION

What is what on the power cutter - K 770 Rescue?	8
--	---

MACHINE'S SAFETY EQUIPMENT

General	9
---------------	---

CUTTING BLADES

General	11
Abrasive blades	12
Diamond blades	12
Toothed blades, carbide tipped blades and emergency situations	13
Transport and storage	13

ASSEMBLING AND ADJUSTMENTS

General	14
Checking the spindle shaft and flange washers	14
Checking the arbor bushing	14
Checking the direction of the blade rotation	14
Fitting the cutting blade	14
Blade guard	14
Disengaging OilGuard	15
Reversible cutting head	15
Wheel kit	16
Cutting trolley	16

FUEL HANDLING

General	17
Fuel	17
Fueling	18
Transport and storage	18
OilGuard	18

OPERATING

Protective equipment	19
General safety precautions	19
Transport and storage	24

STARTING AND STOPPING

Before starting	25
Starting	25
Stopping	26

MAINTENANCE

General	27
Maintenance schedule	27
Cleaning	28
Functional inspection	28
Disposal, scrapping	31

TROUBLESHOOTING

Troubleshooting schedule	32
--------------------------------	----

TECHNICAL DATA

Technical data	33
Recommended abrasive and diamond cutting blade, specification	33
EC Declaration of Conformity	34

PRESENTATION

Dear Customer,

Thank you for choosing a Husqvarna product!

It is our wish that you will be satisfied with your product and that it will be your companion for a long time. A purchase of one of our products gives you access to professional help with repairs and services. If the retailer who sells your machine is not one of our authorized dealers, ask him for the address of your nearest service workshop.

This operator's manual is a valuable document. Make sure it is always at hand at the work place. By following its content (operating, service, maintenance etc.) the life span and the second-hand value of the machine can be extended. If you will sell this machine, make sure that the buyer will get the operator's manual.

More than 300 years of innovation

Husqvarna AB is a Swedish company based on a tradition that dates back to 1689, when the Swedish King Karl XI ordered the construction of a factory for production of muskets. At that time, the foundation was already laid for the engineering skills behind the development of some of the world's leading products in areas such as hunting weapons, bicycles, motorcycles, domestic appliances, sewing machines and outdoor products.

Husqvarna is the global leader in outdoor power products for forestry, park maintenance and lawn and garden care, as well as cutting equipment and diamond tools for the construction and stone industries.

Owner responsibility

It is the owner's/employer's responsibility that the operator has sufficient knowledge about how to use the machine safely. Supervisors and operators must have read and understood the Operator's Manual. They must be aware of:

- The machine's safety instructions.
- The machine's range of applications and limitations.
- How the machine is to be used and maintained.

National legislation could regulate the use of this machine. Find out what legislation is applicable in the place where you work before you start using the machine.

The manufacturer's reservation

Subsequent to publishing this manual Husqvarna may issue additional information for safe operation of this product. It is the owner's obligation to keep up with the safest methods of operation.

Husqvarna AB has a policy of continuous product development and therefore reserves the right to modify the design and appearance of products without prior notice.

Design and features

This Husqvarna power cutter is a portable handheld cut-off machine designed to cut hard materials like concrete, masonry, stone and steel, and should not be used for any purpose not described in this manual. Safe operation of this product requires the operator to read this manual carefully. Ask Discount-equipment if you need more information.

Some of the unique features of your product are described below.

Active Air Filtration™

Centrifugal air cleaning for longer service life and longer service intervals.

OilGuard (K 770 OilGuard)

An optical detection system to detect if there is oil in the fuel or if the oil type is wrong.

SmartCarb™

Built-in automatic filter compensation maintains high power and reduces fuel consumption.

Dura Starter™

Dust sealed starter unit, where the return spring and the pulley bearing are sealed which makes the starter virtually maintenance free and even more reliable.

X-Torq®

The X-Torq® engine provides a more accessible torque for a wider range of speeds which results in maximum cutting capacity. X-Torq® reduces the fuel consumption by up to 20% and the emissions by up to 60%.

EasyStart

The engine and starter are designed to ensure quick and easy starting of the machine. Reduces the pull resistance in the starter cord by up to 40%. (Reduces the compression during starting.)

Air purge

When you push the air purge diaphragm, fuel is pumped through to the carburettor. Fewer pulls are required for starting, meaning the machine becomes easier to start.

Water cooling and dust management

Less slurry and low water consumption.

Excellent dust control with a wet cutting kit. A progressive water valve for exact adjustment of the water volume to efficiently bind the dust and reduce slurry.

Efficient vibration damping system

Efficient vibration dampers spare arms and hands.

PRESENTATION

Reversible cutting head

The machine is fitted with a reversible cutting head allowing cutting close to a wall or at ground level, restricted only by the thickness of the blade guard.

Smart Tension

A semi automatic belt tensioning system with a spring loaded mechanism which makes it easy to get the correct belt tension. It is also very easy to change the drive belt and reverse the cutting head.

Specially designed starter handle (K 770 Rescue)

Specially designed starter handle, with room for heavy gloves.

Adjustable carry strap (K 770 Rescue)

Adjustable carry strap for full freedom of movement.

Reflective blade guard (K 770 Rescue)

A reflective blade guard, visible in smoke and water spray, enhances control of the cutter.

PRESENTATION

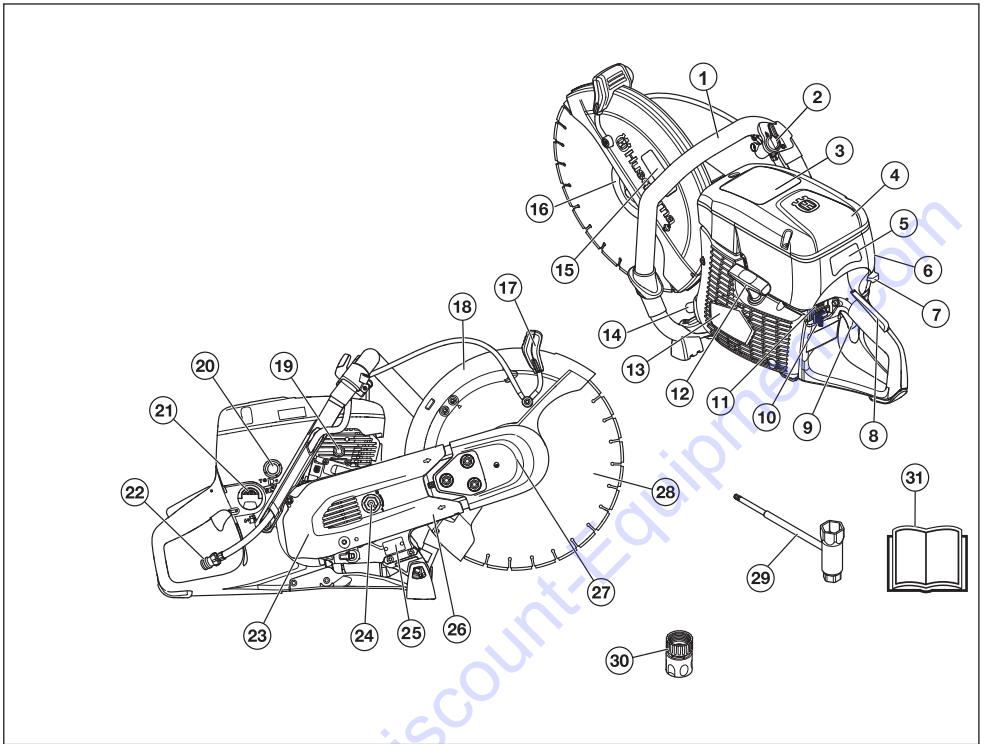

What is what on the power cutter - K 770, K 770 OilGuard?

- | | |
|--|---------------------------------|
| 1 Front handle | 17 Adjustment handle for guard |
| 2 Water valve | 18 Blade guard |
| 3 Warning decal | 19 Decompression valve |
| 4 Air filter cover | 20 Air purge |
| 5 Starting instruction decal | 21 Fuel cap |
| 6 Cylinder cover | 22 Water connection with filter |
| 7 Choke control with start throttle lock | 23 Belt guard |
| 8 Throttle trigger lockout | 24 Belt tensioner |
| 9 Throttle trigger | 25 Rating plate |
| 10 Stop switch | 26 Cutting arm |
| 11 Disconnection function for OilGuard (K 770 OilGuard) | 27 Cutting head |
| 12 Starter handle | 28 Cutting blade (not supplied) |
| 13 Starter housing | 29 Combination spanner |
| 14 Muffler | 30 Water connector, GARDENA® |
| 15 Cutting equipment decal | 31 Operator's manual |
| 16 Flange, spindle, bushing (see instructions in the section "Assembling and adjustments") | |

PRESENTATION

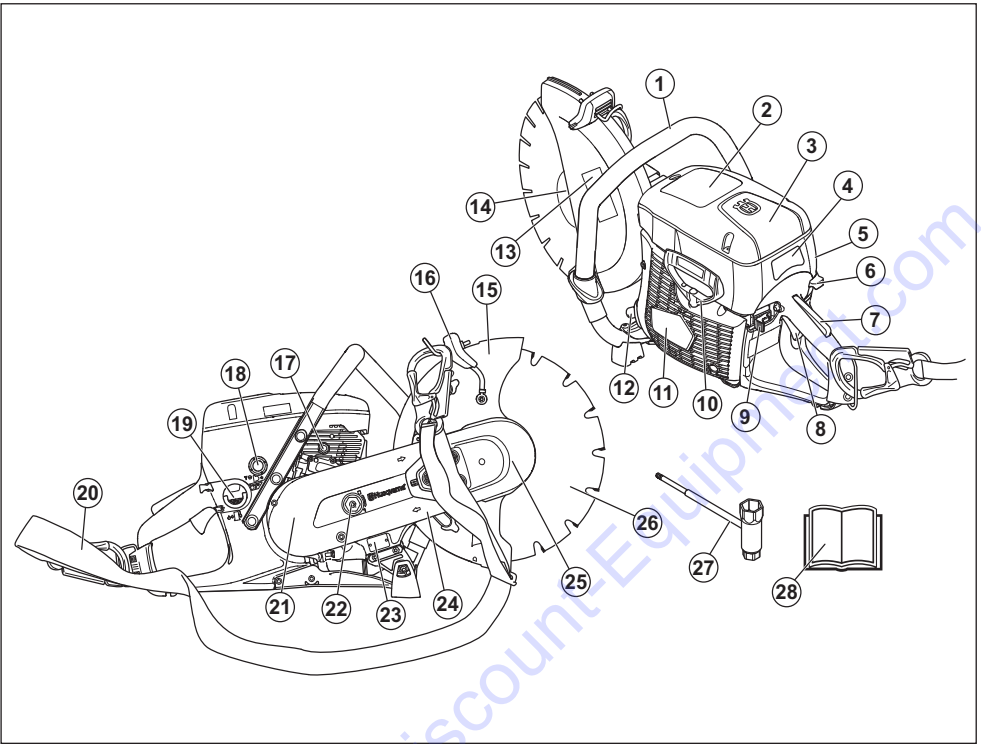

What is what on the power cutter - K 770 Rescue?

- | | |
|--|---------------------------------|
| 1 Front handle | 15 Blade guard |
| 2 Warning decal | 16 Adjustment handle for guard |
| 3 Air filter cover | 17 Decompression valve |
| 4 Starting instruction decal | 18 Air purge |
| 5 Cylinder cover | 19 Fuel cap |
| 6 Choke control with start throttle lock | 20 Adjustable carry strap |
| 7 Throttle trigger lockout | 21 Belt guard |
| 8 Throttle trigger | 22 Belt tensioner |
| 9 Stop switch | 23 Rating plate |
| 10 Starter handle | 24 Cutting arm |
| 11 Starter housing | 25 Cutting head |
| 12 Muffler | 26 Cutting blade (not supplied) |
| 13 Cutting equipment decal | 27 Combination spanner |
| 14 Flange, spindle, bushing (see instructions in the section "Assembling and adjustments") | 28 Operator's manual |

MACHINE'S SAFETY EQUIPMENT

General



WARNING! Never use a machine that has faulty safety equipment! If your machine fails any checks contact Discount-equipment to get it repaired.

The engine should be switched off, and the stop switch in STOP position.

This section describes the machine's safety equipment, its purpose, and how checks and maintenance should be carried out to ensure that it operates correctly.

Throttle trigger lockout

The throttle trigger lock is designed to prevent accidental operation of the throttle. When the lock (A) is pressed in this releases the throttle (B).

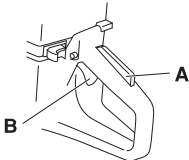

The trigger lock remains pressed in as long as the throttle is pressed. When the grip on the handle is released the throttle trigger and the throttle trigger lock both return to their original positions. This is controlled by two independent return spring systems. This means that the throttle trigger is automatically locked in the idle position.

Checking the throttle lockout

- Make sure that the throttle trigger is locked at idle setting when the throttle trigger lockout is released.

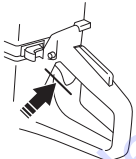

- Press the throttle lockout and make sure it returns to its original position when you release it.

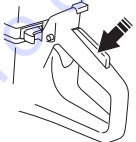

- Check that the throttle trigger and throttle lockout move freely and that the return springs work properly.

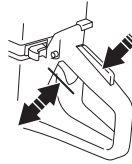

- Start the power cutter and apply full throttle. Release the throttle control and check that the cutting blade stops and remains stationary. If the cutting blade rotates when the throttle is in the idle position you should check the carburettor's idle adjustment. See instructions in the section "Maintenance".

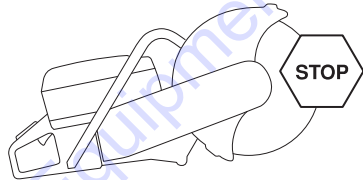

Stop switch

Use the stop switch to switch off the engine.

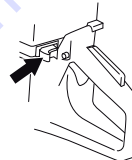

Checking the stop switch

- Start the engine and make sure the engine stops when you move the stop switch to the stop setting.

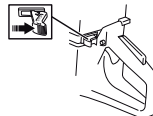

MACHINE'S SAFETY EQUIPMENT

Blade guard



WARNING! Always check that the guard is correctly fitted before starting the machine.

This guard is fitted above the cutting blade and is designed to prevent parts of the blade or cutting fragments from being thrown towards the user.

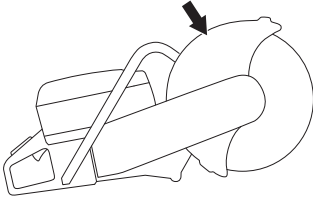

Checking the blade and the blade guard

- Check that the guard over the cutting blade is not cracked or damaged in any other way. Replace when damaged.
- Check that the cutting blade is fitted correctly and does not show signs of damage. A damaged cutting blade can cause personal injury.

Vibration damping system



WARNING! Overexposure to vibration can lead to circulatory damage or nerve damage in people who have impaired circulation. Contact your doctor if you experience symptoms of overexposure to vibration. Such symptoms include numbness, loss of feeling, tingling, pricking, pain, loss of strength, changes in skin colour or condition. These symptoms normally appear in the fingers, hands or wrists. These symptoms may be increased in cold temperatures.

- Your machine is equipped with a vibration damping system that is designed to minimize vibration and make operation easier.
- The machine's vibration damping system reduces the transfer of vibration between the engine unit/cutting equipment and the machine's handle unit. The engine body, including the cutting equipment, is insulated from the handles by vibration damping units.

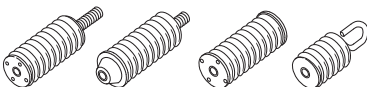

Checking the vibration damping system



WARNING! The engine should be switched off, and the stop switch in STOP position.

- Check the vibration damping units regularly for cracks or deformation. Replace them if damaged.
- Check that the vibration damping element is securely attached between the engine unit and handle unit.

Muffler



WARNING! Never use a machine without a muffler, or with a faulty muffler. A damaged muffler may substantially increase the noise level and the fire hazard. Keep fire fighting equipment handy.

The muffler gets very hot during and after use as well as when idling. Be aware of the fire hazard, especially when working near flammable substances and/or vapours.

Keep fire fighting equipment handy.

The muffler is designed to keep noise levels to a minimum and to direct exhaust fumes away from the user.

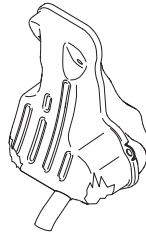

Inspecting the muffler

Check regularly that the muffler is complete and secured correctly.

CUTTING BLADES

General



WARNING! A cutting blade may burst and cause injury to the operator.

The cutting blade manufacturer issues warnings and recommendations for the use and proper care of the cutting blade. Those warnings come with the cutting blade. Read and follow all instructions from the cutting blade manufacturer.

A cutting blade should be checked before it is assembled on the saw and frequently during use. Look for cracks, lost segments (diamond blades) or pieces broken off. Do not use a damaged cutting blade.

Test the integrity of each new cutting blade by running it at full throttle for about 1 minute.

- Cutting blades are available in two basic designs; abrasive blades and diamond blades.

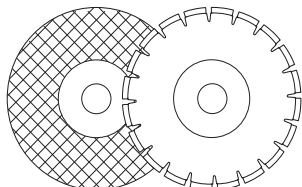

- High-quality blades are often most economical. Lower quality blades often have inferior cutting capacity and a shorter service life, which results in a higher cost in relation to the quantity of material that is cut.
- Make sure that the right bushing is used for the cutting blade to be fitted on the machine. See the instructions under the heading Fitting the cutting blade.

Suitable cutting blades

Cutting blades	K 770	K 770 Rescue
Abrasive blades	Yes*	Yes*
Diamond blades	Yes	Yes
Toothed blades	Do not use	Yes**

For more information, see the "Technical data" section.

*Without water

**See instructions under the heading "Toothed blades, carbide tipped blades and emergency situations".

Cutting blades for different materials



WARNING! Never use a cutting blade for any other materials than what it was intended to cut.

Never use a diamond blade to cut plastic material. The heat produced during cutting may melt the plastic and it can stick to the cutting blade and cause a kickback.

Cutting metal generates sparks that may cause fire. Do not use the machine near ignitable substances or gases.

Follow the instructions supplied with the cutting blade concerning the suitability of the blade for various applications, or consult your dealer in case of doubts.

	Concrete	Metal	Plastic	Cast iron
Abrasive blades	X	X	X	X
Diamond blades	X	X*		X*

* Only specialty blades.

Hand held, high speed machines



WARNING! Never use a cutting blade with a lower speed rating than that of the power cutter. Only use cutting blades that are in compliance with national or regional standards, for example EN 13236 or EN 12413 or ANSI B7.1.

- Many cutting blades that might fit this power cutter are intended for stationary saws and have a lower speed rating than is needed for this hand-held saw. Cutting blades with a lower speed rating shall never be used on this saw.
- Husqvarna cutting blades are manufactured for high-speed, portable power cutters.
- Check that the blade is approved for the same or higher speed according to the approval plate of the engine. Never use a cutting blade with a lower speed rating than that of the power cutter.

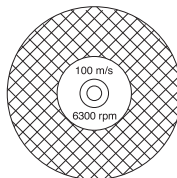

CUTTING BLADES

Blade vibration

- The blade can become out-of-round and vibrate if an excessive feed pressure is used.
- A lower feed pressure can stop the vibration. Otherwise replace the blade.

Abrasive blades



WARNING! Do not use abrasive blades with water. The strength is impaired when abrasive blades are exposed to water or moisture, which results in an increased risk of the blade breaking.

- The cutting material on abrasive blades consists of grit bonded using an organic binder. "Reinforced blades" are made up of a fabric or fibre base that prevents total breakage at maximum working speed if the blade should be cracked or damaged.
- A cutting blade's performance is determined by the type and size of abrasive corn, and the type and hardness of the bonding agent.
- Ensure the cutting blade is not cracked or damaged.

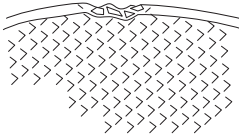

- Test the abrasive blade by hanging it on your finger and tapping it lightly with a screwdriver or the like. If the blade does not produce a resonant, ringing sound it is damaged.

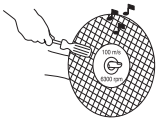

Abrasive blades for different materials

Blade type	Material
Concrete blade	Concrete, asphalt, stone masonry, cast iron, aluminium, copper, brass, cables, rubber, plastic, etc.
Metal blade	Steel, steel alloys and other hard metals.

Diamond blades

General



WARNING! Never use a diamond blade to cut plastic material. The heat produced during cutting may melt the plastic and it can stick to the cutting blade and cause a kickback.

Diamond blades become very hot when used. An overheated blade is a result of improper use, and may cause deformation of the blade, resulting in damage and injuries.

Cutting metal generates sparks that may cause fire. Do not use the machine near ignitable substances or gases.

- Diamond blades consist of a steel core provided with segments that contain industrial diamonds.
- Diamond blades ensure lower costs per cutting operation, fewer blade changes and a constant cutting depth.
- When using diamond blades make sure that it rotates in the direction indicated by the arrow on the blade.

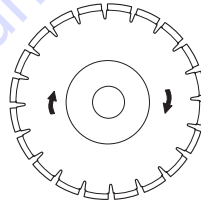

Diamond blades for different materials

- Diamond blades are ideal for masonry, reinforced concrete and other composite materials.
- Diamond blades are available in several hardness classes.
- Special blades should be used when cutting metal. Ask your dealer for help in choosing the right product.

Sharpening diamond blades

- Always use a sharp diamond blade.
- Diamond blades can become dull when the wrong feeding pressure is used or when cutting certain materials such as heavily reinforced concrete. Working with a dull diamond blade causes overheating, which can result in the diamond segments coming loose.
- Sharpen the blade by cutting in a soft material such as sandstone or brick.

CUTTING BLADES

Diamond blades and cooling

- During cutting the friction in the cut causes the diamond blade to be heated up. If the blade is allowed to get too hot this can result in loss of blade tensioning or core cracking.

Diamond blades for dry cutting

- Although no water is required for cooling, dry cutting blades must be cooled with air flow around the blades. For this reason dry cutting blades are recommended only for intermittent cutting. Every few seconds of cutting the blade should be allowed to run "free" with no load to allow the air flow around the blade to dissipate the heat.

Diamond blades for wet cutting

- Wet cutting diamond blades must be used with water to keep the blade core and segments cool during sawing.
- Wet cutting blades should NOT be used dry.
- Using wet cutting blades without water can cause excessive heat build-up, resulting in poor performance, severe blade damage and is a safety hazard.
- Water cools the blade and increases its service life while also reducing the formation of dust.

Diamond blade - side clearance



WARNING! Certain cutting situations or poor blades may suffer excessive wear on the side of the segments.

Check that the diamond segment (T1) is wider than the blade core (T2), to prevent binding in the cutting slot and a kickback.

Replace the blade before it is completely worn out.

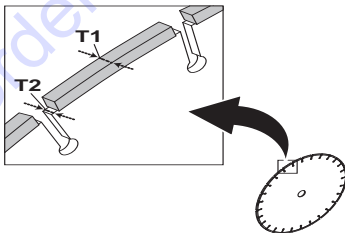

Some Husqvarna blades are available with side clearance wear indicators to help determine a blade's end of life.

Toothed blades, carbide tipped blades and emergency situations



WARNING! Never use toothed blades such as wood cutting blades, circular toothed blades, carbide tipped blades etc. The risk of kickback is significantly increased and tips can be torn off and thrown at high speed. Carelessness can result in serious personal injury or even death.

Government regulation requires a different type of guarding for carbide tipped blades not available on power cutters – a so called 360 degree guard. Power Cutters (this saw) use Abrasive or Diamond blades and have a different guarding system which does not provide protection against the dangers presented by wood cutting blades.

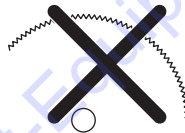

Use of this power cutter with a carbide tipped blade is a violation of work safety regulations.

Due to the hazardous nature and exigent circumstances involved with fire fighting and rescue operations conducted by the various highly trained public safety forces, safety professionals (fire departments), Husqvarna is aware that they may use this power cutter with carbide tipped blades in certain emergency situations due to the ability of carbide tipped blades to cut many different types of obstructions and materials in combination without having to take time to switch blades or machines. When using this power cutter be aware at all times that carbide tipped blades are more kickback prone than abrasive or diamond blades if not used properly. Carbide tipped blades can also throw pieces of material away from the blade.

For these reasons, a power cutter equipped with a carbide tipped blade should never be used except by highly trained public safety professionals who are aware of the risks associated with its use and then only in those exigent circumstances when other tools are deemed inefficient and ineffective to for fire or rescue operations. A power cutter equipped with carbide tipped blade should never be used to cut wood in non-rescue operations.

Transport and storage

- Do not store or transport the power cutter with the cutting blade fitted. All blades should be removed from the cutter after use and stored carefully.
- Store cutting blades in dry, frost free conditions. Special care should be taken with abrasive blades. Abrasive blades must be stored on a flat, level surface. If an abrasive blades is stored in humid conditions, this can cause imbalance and result in injury.
- Inspect new blades for transport or storage damage.

ASSEMBLING AND ADJUSTMENTS

General



WARNING! The engine should be switched off, and the stop switch in STOP position.

Husqvarna's blades are high speed blades approved for hand held power cutters.

Checking the spindle shaft and flange washers

When the blade is replaced with a new one, check the flange washers and the spindle shaft.

- Check that the threads on the spindle shaft are undamaged.
- Check that the contact surfaces on the blade and the flange washers are undamaged, of the correct dimension, clean, and that they run properly on the spindle shaft.

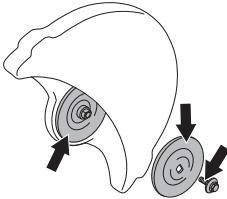

Do not use warped, notched, indented or dirty flange washers. Do not use different dimensions of flange washers.

Checking the arbor bushing

The arbor bushings are used to fit the machine to the centre hole of the cutting blade. The machine is supplied with either a bushing that can be flipped over to fit blades with either 20 mm or 1" (25,4 mm) centre holes, or with a fixed 20 mm bushing. A decal on the blade guard indicates which bushing has been factory fitted together with appropriate blade specification.

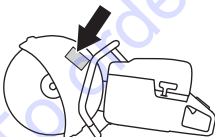

- Check that the bushing on the machine's spindle shaft corresponds with the centre hole of the cutting blade. The blades are marked with the diameter of the centre hole.

Use only bushings supplied by Husqvarna. Those bushings have been designed for your power cutter.

Checking the direction of the blade rotation

- When using diamond blades make sure that it rotates in the direction indicated by the arrow on the blade. The direction of rotation for the machine is shown by arrows on the cutting arm.

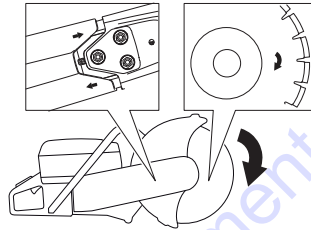

Fitting the cutting blade

- The blade is placed on the bushing (A) between the inner flange washer (B) and the flange washer (C). The flange washer is turned so that it fits on the axle.

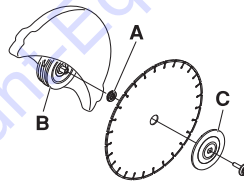

- Lock the shaft. Insert a tool in the hole in the cutting head and rotate the blade until it is locked.

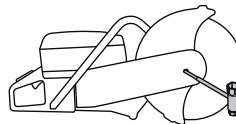

- Tightening torque for the bolt holding the blade is: 25 Nm (215 in.lb).

Blade guard

The guard for the cutting equipment should be adjusted so that the rear section is flush with the work piece. Spatter and sparks from the material being cut are then collected up by the guard and led away from the user.

The blade guard is friction locked.

- Press the ends of the guard against the work piece or adjust the guard with the adjustment handle. The guard must always be fitted on the machine.

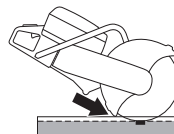

ASSEMBLING AND ADJUSTMENTS

Disengaging OilGuard (K 770 OilGuard)

- When the machine is delivered, the OilGuard plug (A) and the blue indicator pin (B) are fitted in the tank.

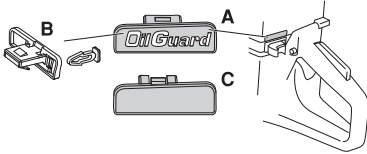

- If you are in a situation where you do not have access to Husqvarna OilGuard oil, but you have oil of a similar quality, you can deactivate the OilGuard system using the disconnection function.
- To deactivate the function, pry off the OilGuard plug using a screwdriver and then break off the indicator pin. Now fit the disconnector plug (C) in the tank to complete deactivation and to cover the hole.
- If you want to reactivate the OilGuard system, press the OilGuard plug again. The system is then reactivated, but note that the broken indicator pin cannot be refitted.
- A broken indicator pin indicates that the OilGuard system has been disconnected.
- You can purchase a new indicator pin as a spare, but this is only sold in grey which indicates that the OilGuard system has been deactivated since the machine left the factory.

Reversible cutting head

The machine is fitted with a reversible cutting head allowing cutting close to a wall or at ground level, restricted only by the thickness of the blade guard.

In the event of a kickback it is harder to control the machine when cutting with the cutting head reversed. The cutting blade is further away from the centre of the machine which means the handle and the cutting blade are no longer in alignment. It is more difficult to restrain the machine if the blade gets jammed or stuck in its kickback danger zone. See under the "Kickback" heading in the "Operating" section for additional information.

Some of the machine's good ergonomic features are jeopardised such as balance. Cutting with the cutting head reversed should only occur with cuts that are not possible in a standard manner.

- Loosen the three nuts (A) holding the upper belt guard. Turn the belt tensioner (B) to position "0" to release the tension.

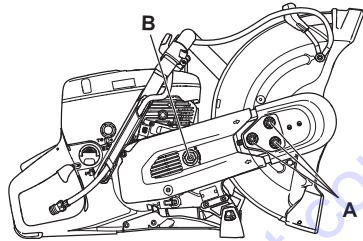

- Remove the upper belt guard.
- Disconnect the water hose nipples and handle from the blade guard (C). Remove the stop (D).

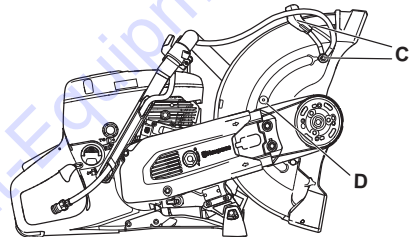

- The cutting head is now loose and can be removed from the machine. Remove the belt from the belt pulley.

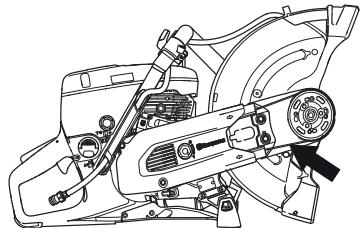

- Rotate the bearing housing to opposite direction and reassemble the stop.

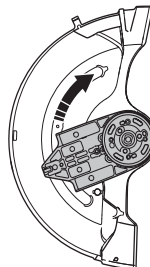

ASSEMBLING AND ADJUSTMENTS

- Attach the cutting head to the other side of the cutting arm.

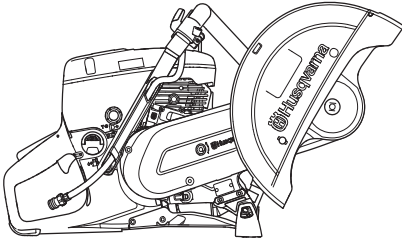

Turn the belt tensioner (B) to position "1" to tighten the drive belt.

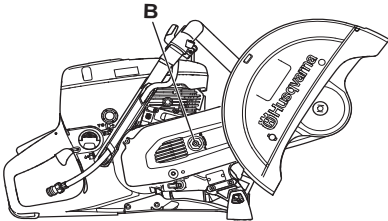

- Fit the belt guard to the reversed cutting head.
- Assemble the water hose nipples and the hose on the opposite upper side of the blade guard.
- To obtain the correct drive belt tension, tighten the nuts (A) first and then loosen them 1-2 turns. Wiggle the blade guard (E) up and down 3-5 times, and then tighten the nuts (A) with the combination spanner.

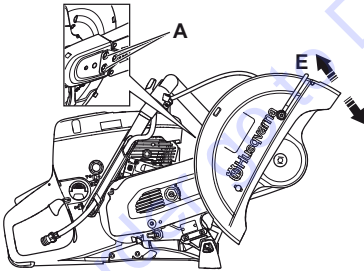

Wheel kit (Accessory)

Wheels can easily be added.

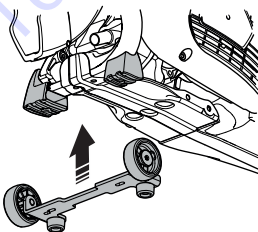

Cutting trolley (Accessory)

A cutting trolley makes it easier to cut in floors and roads, especially long cuts at a fixed depth. Quick connections makes it easy to install the cutter on the trolley.

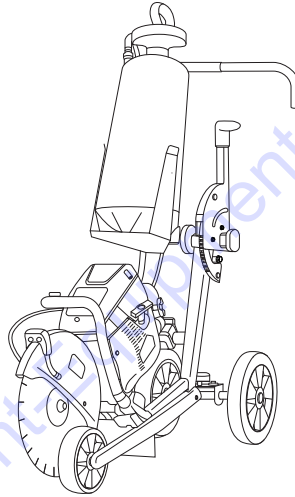

FUEL HANDLING

General



WARNING! Running an engine in a confined or badly ventilated area can result in death due to asphyxiation or carbon monoxide poisoning. Use fans to ensure proper air circulation when working in trenches or ditches deeper than one meter.

Fuel and fuel fumes are flammable and can cause serious injury when inhaled or allowed to come in contact with the skin. For this reason observe caution when handling fuel and make sure there is adequate ventilation.

The exhaust fumes from the engine are hot and may contain sparks which can start a fire. Never start the machine indoors or near combustible material!

Do not smoke and do not place any hot objects in the vicinity of fuel.

Fuel

NOTICE! The machine is equipped with a two-stroke engine and must always be run using a mixture of petrol and two-stroke oil. It is important to accurately measure the amount of oil to be mixed to ensure that the correct mixture is obtained. When mixing small amounts of fuel, even small inaccuracies can drastically affect the ratio of the mixture.

Petrol

- Use good quality unleaded or leaded petrol.
- The lowest octane recommended is 90 (RON). If you run the engine on a lower octane grade than 90 so-called knocking can occur. This gives rise to a high engine temperature, which can result in serious engine damage.
- When working at continuous high revs a higher octane rating is recommended.

Environment fuel

HUSQVARNA recommends the use of alkylate fuel, either Aspen two-stroke fuel or environmental fuel for four-stroke engines blended with two-stroke oil as set out below. Note that carburettor adjustment may be necessary when changing the type of fuel (see the instructions under the heading Carburettor).

Ethanol blended fuel, E10 may be used (max 10% ethanol blend). Using ethanol blends higher than E10 will create lean running condition which can cause engine damage.

Two-stroke oil

- For best results and performance use HUSQVARNA two-stroke engine oil, which is specially formulated for our air-cooled two-stroke engines.
- Never use two-stroke oil intended for water-cooled engines, sometimes referred to as outboard oil (rated TCW).
- Never use oil intended for four-stroke engines.

K 770 OilGuard

- Use HUSQVARNA OilGuard two stroke oil.

Mixing

- Always mix the petrol and oil in a clean container intended for fuel.
- Always start by filling half the amount of the petrol to be used. Then add the entire amount of oil. Mix (shake) the fuel mixture. Add the remaining amount of petrol.
- Mix (shake) the fuel mixture thoroughly before filling the machine's fuel tank.
- Do not mix more than one month's supply of fuel at a time.

Mixing ratio

- 1:50 (2%) with HUSQVARNA two-stroke oil or equivalent.

Petrol, litre	Two-stroke oil, litre 2% (1:50)
5	0,10
10	0,20
15	0,30
20	0,40

- 1:33 (3%) with oils class JASO FB or ISO EGB formulated for air-cooled, two-stroke engines or mix as per recommendation from the oil manufacturer.

FUEL HANDLING

Fueling



WARNING! Taking the following precautions, will lessen the risk of fire:

Do not smoke and do not place any hot objects in the vicinity of fuel.

Always stop the engine and let it cool for a few minutes before refuelling. The engine should be switched off, and the stop switch in STOP position.

When refuelling, open the fuel cap slowly so that any excess pressure is released gently.

Clean the area around the fuel cap.

Tighten the fuel cap carefully after refuelling.

If the cap is not properly tightened the cap might vibrate loose and fuel may escape from the fuel tank creating a fire hazard.

Move the machine at least 3 m from the refuelling point before starting it.

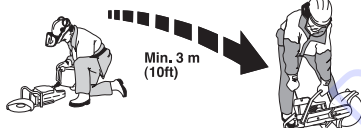

Never start the machine:

- If you have spilled fuel or engine oil on the machine. Wipe off the spill and allow the remaining fuel to evaporate.
- If you have spilled fuel on yourself or your clothes, change your clothes. Wash any part of your body that has come in contact with fuel. Use soap and water.
- If the machine is leaking fuel. Check regularly for leaks from the fuel cap and fuel lines.
- Unless the fuel cap is securely tightened after refueling.

Transport and storage

- Store and transport the machine and fuel so that there is no risk of any leakage or fumes coming into contact with sparks or open flames, for example, from electrical machinery, electric motors, electrical relays/ switches or boilers.
- When storing and transporting fuel always use approved containers intended for this purpose.

Long-term storage

- When storing the machine for long periods the fuel tank must be emptied. Contact your local petrol station to find out where to dispose of excess fuel.

OilGuard (K 770 OilGuard)

- Machines fitted with OilGuard have a built-in system for identifying incorrect fuel mixtures.
- Once the machine is running, a detector reads the fuel quality which takes about ten seconds. If the correct amount of Husqvarna OilGuard oil has been used, the machine will run at a normal speed. If the wrong type of oil has been used, the machine senses this and restricts the speed of the engine to 3,800 rpm to avoid damaging the engine.
- In order for the machine to run at normal speed again, you must drain the incorrect fuel mixture and then fill the machine with a fuel mixture containing the correct ratio (2 %) of Husqvarna OilGuard oil.

OPERATING

Protective equipment

General

- Do not use the machine unless you are able to call for help in the event of an accident.

Personal protective equipment

You must use approved personal protective equipment whenever you use the machine. Personal protective equipment cannot eliminate the risk of injury but it will reduce the degree of injury if an accident does happen. Ask your dealer for help in choosing the right equipment.



WARNING! The use of products such as cutters, grinders, drills, that sand or form material can generate dust and vapours which may contain hazardous chemicals. Check the nature of the material you intend to process and use an appropriate breathing mask.

Long-term exposure to noise can result in permanent hearing impairment. Always use approved hearing protection. Listen for warning signals or shouts when you are wearing hearing protection. Always remove your hearing protection as soon as the engine stops.

Always wear:

- Approved protective helmet
- Hearing protection
- Approved eye protection. If you use a face shield then you must also wear approved protective goggles. Approved protective goggles must comply with standard ANSI Z87.1 in the USA or EN 166 in EU countries. Visors must comply with standard EN 1731.
- Approved respiratory protection
- Heavy-duty, firm grip gloves.
- Tight-fitting, heavy-duty and comfortable clothing that permits full freedom of movement. Cutting generates sparks that can ignite clothing. Husqvarna recommends that you wear flame-retardant cotton or heavy denim. Do not wear clothing made of material such as nylon, polyester or rayon. If ignited such material can melt and cling to the skin. Do not wear shorts
- Boots with steel toe-caps and non-slip sole.

Other protective equipment



CAUTION! Sparks may appear and start a fire when you work with the machine. Always keep fire fighting equipment handy.

- Fire Extinguisher
- Always have a first aid kit nearby.

General safety precautions

This section describes basic safety directions for using the machine. This information is never a substitute for professional skills and experience.

- Please read the operator's manual carefully and make sure you understand the instructions before using the machine. It is recommended that first time operators also obtain practical instruction before using the machine.
- Keep in mind that it is you, the operator that is responsible for not exposing people or their property to accidents or hazards.
- The machine must be kept clean. Signs and stickers must be fully legible.

Always use common sense

It is not possible to cover every conceivable situation you can face. Always exercise care and use your common sense. If you get into a situation where you feel unsafe, stop and seek expert advice. Contact Discount-equipment. Do not attempt any task that you feel unsure of!



WARNING! The machine can be a dangerous tool if used incorrectly or carelessly, which can cause serious or fatal injury to the operator or others.

Never allow children or other persons not trained in the use of the machine to use or service it.

Never allow anyone else to use the machine without first ensuring that they have read and understood the contents of the operator's manual.

Never use the machine if you are fatigued, while under the influence of alcohol or drugs, medication or anything that could affect your vision, alertness, coordination or judgement.

OPERATING



WARNING! Unauthorized modifications and/or accessories may lead to serious injury or death to the user or others. Under no circumstances may the design of the machine be modified without the permission of the manufacturer.

Do not modify this product or use it if it appears to have been modified by others.

Never use a machine that is faulty. Carry out the safety checks, maintenance and service instructions described in this manual. Some maintenance and service measures must be carried out by trained and qualified specialists. See instructions under the Maintenance heading.

Always use genuine accessories.



WARNING! This machine produces an electromagnetic field during operation. This field may under some circumstances interfere with active or passive medical implants. To reduce the risk of serious or fatal injury, we recommend persons with medical implants to consult their physician and the medical implant manufacturer before operating this machine.

Work area safety



WARNING! The safety distance for the power cutter is 15 metres (50 foot). You are responsible to ensure that animals and onlookers are not within the working area. Do not start cutting until the working area is clear and you are standing firmly.

- Observe your surroundings to ensure that nothing can affect your control of the machine.
- Ensure that no one/nothing can come into contact with the cutting equipment or be hit by parts thrown by the blade.
- Do not use the machine in bad weather, such as dense fog, heavy rain, strong wind, intense cold, etc. Working in bad weather is tiring and can lead to dangerous conditions, e.g. slippery surfaces.
- Never start to work with the machine before the working area is clear and you have a firm foothold. Look out for any obstacles with unexpected movement. Ensure when cutting that no material can become loose and fall, causing injury to the operator. Take great care when working on sloping ground.

- Ensure that the working area is sufficiently illuminated to create a safe working environment.
- Make sure that no pipes or electrical cables are routed in the working area or in the material to be cut.
- If cutting into a container (drum, pipe, or other container) you must first make sure it does not contain flammable or other volatile material.

Basic working techniques



WARNING! Do not pull the power cutter to one side, this can cause the blade to jam or break resulting in injury to people.

Under all circumstances avoid grinding using the side of the blade; it will almost certainly be damaged or break and can cause immense damage. Only use the cutting section.

Before entering an existing slot made by another blade, check that the slot is not thinner than your blade as that may result in binding in the cutting slot and a kickback.

Never use a diamond blade to cut plastic material. The heat produced during cutting may melt the plastic and it can stick to the cutting blade and cause a kickback.

Cutting metal generates sparks that may cause fire. Do not use the machine near ignitable substances or gases.

- The machine is designed and intended for cutting with abrasive blades or diamond blades intended for high speed handheld machines. The machine shall not be used with any other type of blade, or for any other type of cutting.
- Check that the cutting blade is fitted correctly and does not show signs of damage. See the instructions in the sections "Cutting blades" and "Assembly and adjustments".
- Check that the correct cutting blade is used for the application in question. See instructions in the section "Cutting blades".

OPERATING

- Never cut asbestos materials!
- Hold the saw with both hands; keep a firm grip with thumbs and fingers encircling the handles. The right hand should be on the rear handle and the left hand on the front handle. All operators, weather right or left handed shall use this grip. Never operate a power cutter holding it with only one hand.

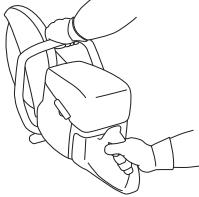

- Stand parallel to the cutting blade. Avoid standing straight behind. In the event of a kickback the saw will move in the plane of the cutting blade.



- Maintain a safe distance from the cutting blade when the engine is running.
- Never leave the machine unsupervised with the motor running.
- Never move the machine when the cutting equipment is rotating. Make sure that the blade has come to a complete stop before the machine is put on the ground. The machine is equipped with a friction retarder to shorten the blade stop time.
- The guard for the cutting equipment should be adjusted so that the rear section is flush with the work piece. Spatter and sparks from the material being cut are then collected up by the guard and led away from the user. The guards for the cutting equipment must always be fitted when the machine is running.

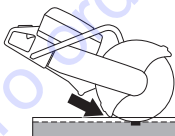

- Never use the kickback zone of the blade **for cutting**. See instructions under the heading "Kickback".
- Keep a good balance and a firm foothold.
- Never cut above shoulder height.

- Never cut from a ladder. Use a platform or scaffold if the cut is above shoulder height. Do not overreach



- Stand at a comfortable distance from the work piece.
- Check that the blade is not in contact with anything when the machine is started
- Apply the cutting blade gently with high rotating speed (full throttle) Maintain full speed until cutting is complete.
- Let the machine work without forcing or pressing the blade.
- Feed down the machine in line with the blade. Pressure from the side can damage the blade and is very dangerous.



- Move the blade slowly forwards and backwards to achieve a small contact area between the blade and the material to be cut. This reduces the temperature of the blade and ensures effective cutting.

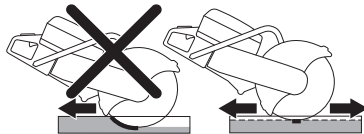

Managing dust

The machine is fitted with a low flushing water kit that offers maximum dust suppression.

Use wet cutting blades with water cooling when possible for optimal dust management. See instructions in the section "Cutting blades".

Adjust the water flow using the valve to bind the cutting dust. The volume of water required varies depending on the type of job at hand.

If water hoses loosen from their supply sources, this indicates that the machine is connected to a water pressure that is too high. See instructions under the "Technical data" heading for recommended water pressure.

OPERATING

Cutting with toothed/carbide tipped blades during rescue operations



WARNING! A power cutter should never be used with carbide tipped blade for non-emergency work, such as in the construction trades.

Be aware at all times that carbide tipped blades are more kickback prone than abrasive or diamond blades if not used properly.

If the public safety force (fire department) that purchased this power cutter has decided to equip this unit with a carbide tipped blade for rescue operations, the following safety considerations must be adhered to.

Training and protective equipment

- Only operators trained in the use of cutting with a power cutter equipped with carbide tipped blade shall be allowed to operate the power cutter.
- Full protective fire fighting gear shall be worn by the operator at all times.
- A full face shield (not just protective eye glasses) shall be worn by the operator to protect the face from flying debris or a sudden kick-back of the power cutter.

Risk area

No persons that do not have the protective equipment described above shall be allowed inside the risk area for thrown material.

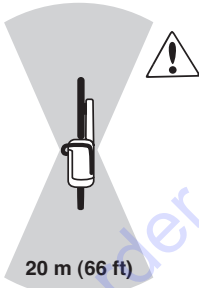

Blade speed

Apply the cutting blade gently with high rotating speed (full throttle) Maintain full speed until cutting is complete. Low blade speed, especially in hard and thin materials can result in jamming and the breaking-off of the carbide tips.

Thin material

Cutting thin and hard material (i.e. a sheet metal covered roof) should be conducted in a forward direction for best control.

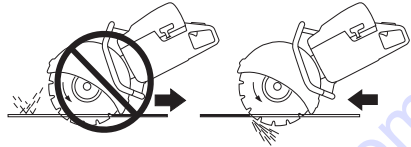

Pinching or jamming

Make a careful evaluation of how the object will move during the final stage of the cutting to avoid pinching or jamming. The cut must open during the cut. If the object sags and the cut begins to close the blade may pinch, possibly resulting in a kick-back or damage to the blade.

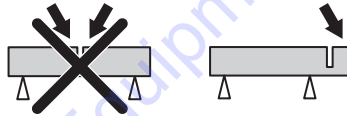

Cutting in line

Skewing or twisting in the line of cut will reduce cutting efficiency and damage the blade.

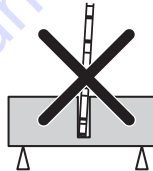

Before each rescue operation

Check that the blade and the blade guard are not damaged or cracked. Replace the blade or the blade guard if it has been exposed to impact or is cracked.

- Check that no carbide tips have loosened from the cutting blade.
- Check that the blade is not skew or shows signs of cracking or other defects.

When cutting in hard materials carbide tipped blades will rapidly lose its sharpness. For best performance during rescue operations we recommend that a new blade be installed.

OPERATING

Kickback



WARNING! Kickbacks are sudden and can be very violent. The power cutter can be thrown up and back towards the user in a rotating motion causing serious or even fatal injury. It is vital to understand what causes kickback and how to avoid it before using the machine.

Kickback is the sudden upward motion that can occur if the blade is pinched or stalled in the kickback zone. Most kickbacks are small and pose little danger. However a kickback can also be very violent and throw the power cutter up and back towards the user in a rotating motion causing serious or even fatal injury.

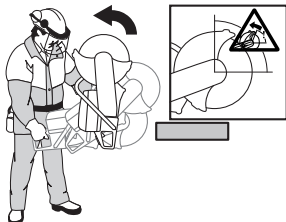

Reactive force

A reactive force is always present when cutting. The force pulls the machine in the opposite direction to the blade rotation. Most of the time this force is insignificant. If the blade is pinched or stalled the reactive force will be strong and you might not be able to control the power cutter.

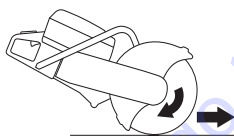

Never move the machine when the cutting equipment is rotating. Gyroscopic forces can obstruct the intended movement.

Kickback zone

Never use the kickback zone of the blade **for cutting**. If the blade is pinched or stalled in the kickback zone, the reactive force will push the power cutter up and back towards the user in a rotating motion causing serious or even fatal injury.



Climbing kickback

If the kickback zone is used for cutting the reactive force drives the blade to climb up in the cut. Do not use the

kickback zone. Use the lower quadrant of the blade to avoid climbing kickback.

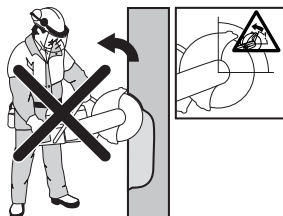

Pinching kickback

Pinching is when the cut closes and pinches the blade. If the blade is pinched or stalled the reactive force will be strong and you might not be able to control the power cutter.



If the blade is pinched or stalled in the kickback zone, the reactive force will push the power cutter up and back towards the user in a rotating motion causing serious or even fatal injury. Be alert for potential movement of the work piece. If the work piece is not properly supported and shifts as you cut, it might pinch the blade and cause a kick back.

Pipe cutting

Special care should be taken when cutting in pipes. If the pipe is not properly supported and the cut kept open through out the cutting, the blade might be pinched in the kickback zone and cause a severe kickback. Be especially alert when cutting a pipe with a belled end or a pipe in a trench that, if not properly supported, may sag and pinch the blade.

Before starting the cut the pipe must be secure so it does not move or roll during cutting.

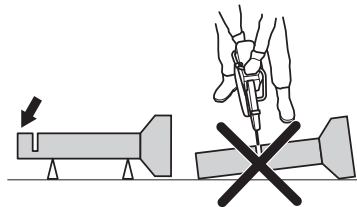

If the pipe is allowed to sag and close the cut, the blade will be pinched in the kick back zone and a severe kick back might develop. If the pipe is properly supported the

OPERATING

end of the pipe will move downward, the cut will open and no pinching will occur.

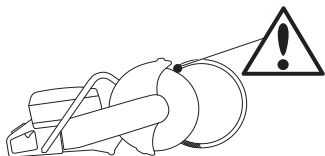

Proper sequence cutting a pipe

- 1 First cut section I.
- 2 Move to side II and cut from section I to bottom of the pipe.
- 3 Move to side III and cut the remaining part of the pipe ending at the bottom.

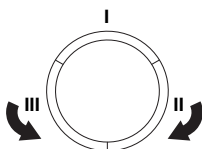

How to avoid kickback

Avoiding kickback is simple.

- The work piece must always be supported so that the cut stays open when cutting through. When the cut opens there is no kickback. If the cut closes and pinches the blade there is always a risk of kickback.



- Take care when inserting the blade in an existing cut.
- Be alert to movement of the work piece or anything else that can occur, which could cause the cut to close and pinch the blade.

Transport and storage

- Secure the equipment during transportation in order to avoid transport damage and accidents.
- Do not store or transport the power cutter with the cutting blade fitted.
- For transport and storage of cutting blades, see the section "Cutting blades".
- For transport and storage of fuel, see the section "Fuel handling".
- Store the equipment in a lockable area so that it is out of reach of children and unauthorized persons.

STARTING AND STOPPING

Before starting



WARNING! Note the following before starting: Please read the operator's manual carefully and make sure you understand the instructions before using the machine.

Wear personal protective equipment. See under heading "Personal protective equipment".

Do not start the machine without the belt and belt guard fitted. Otherwise the clutch could come loose and cause personal injuries.

Check that the fuel cap is properly secured, and that there is no fuel leakage.

Make sure no unauthorised persons are in the working area, otherwise there is a risk of serious personal injury.

- Perform daily maintenance. See instructions in the section "Maintenance".

Starting



WARNING! The cutting blade rotates when the engine is started. Make sure it can rotate freely.

With a cold engine:



- Make sure that the stop switch (STOP) is in the left position.

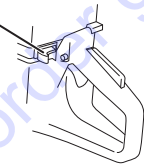

- Start throttle position and choke is obtained by pulling out the choke control completely.



- **Decompression valve:** Press in the valve to reduce the pressure in the cylinder, this is to assist starting the power cutter. The decompression valve should always be used when starting. The valve

automatically returns to its initial position when the machine starts.

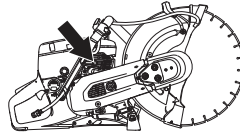

- Press the air purge diaphragm repeatedly until fuel begins to fill the diaphragm (about 6 times). The diaphragm need not be completely filled.

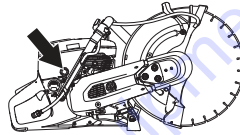

- Grip the front handle with your left hand. Put your right foot on the lower section of the rear handle pressing the machine against the ground. Pull the starter handle with your right hand until the engine starts. **Never twist the starter cord around your hand.**



- Push in the choke control as soon as the engine starts, with the choke pulled out the engine will stop after a few seconds. (If the engine stops anyway, pull the starter handle again.)
- Press the throttle trigger to disengage the start throttle and the machine will idle.

NOTICE! Pull with your right hand out the starter cord slowly until you feel a resistance (as the starter pawls engage) and then pull firmly and rapidly. Do not pull the starter cord all the way out and do not let go of the starter handle when the cord is fully extended. This can damage the machine.

STARTING AND STOPPING

With a warm engine:



- Make sure that the stop switch (STOP) is in the left position.

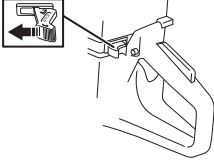

- Set the choke control in the choke position. The choke position is also the automatic start throttle position.



- **Decompression valve:** Press in the valve to reduce the pressure in the cylinder, this is to assist starting the power cutter. The decompression valve should always be used when starting. The valve automatically returns to its initial position when the machine starts.



- Push the choke control to disable the choke (the start throttle position remains).



- Grip the front handle with your left hand. Put your right foot on the lower section of the rear handle pressing the machine against the ground. Pull the starter handle with your right hand until the engine starts. **Never twist the starter cord around your hand.**



- When the machine starts, press the throttle trigger to disengage the start throttle, and the machine will idle.

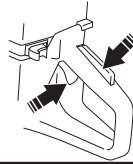

NOTICE! Pull with your right hand out the starter cord slowly until you feel a resistance (as the starter pawls engage) and then pull firmly and rapidly.

Do not pull the starter cord all the way out and do not let go of the starter handle when the cord is fully extended. This can damage the machine.



WARNING! When the engine is running the exhaust contains chemicals such as unburned hydrocarbons and carbon monoxide. The content of the exhaust fumes is known to cause respiratory problems, cancer, birth defects or other reproductive harm.

Carbon monoxide is colorless and tasteless and is always present in exhaust fumes. The onset of carbon monoxide poisoning is distinguished by a slight dizziness which may or may not be recognized by the victim. A person may collapse and lapse into unconsciousness with no warning if the concentration of carbon monoxide is sufficiently high. Since carbon monoxide is colorless and odorless, its presence can not be detected. Any time exhaust odors are noticed, carbon monoxide is present. Never use a petrol powered power cutter indoors or in trenches more than 3 foot (1 meter) deep or in other areas with poor ventilation. Ensure proper ventilation when working in trenches or other confined areas.

Stopping



CAUTION! The cutting blade continues to rotate up to a minute after the motor has stopped. (Blade coasting.) Make sure that the cutting blade can rotate freely until it is completely stopped. Carelessness can result in serious personal injury.

- Stop the engine by moving the stop switch (STOP) to the right.

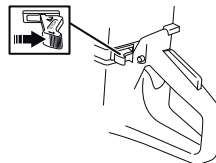

MAINTENANCE

General



WARNING! The user must only carry out the maintenance and service work described in this Operator's Manual. More extensive work must be carried out by an authorized service workshop.

The engine should be switched off, and the stop switch in STOP position.

Wear personal protective equipment. See under heading "Personal protective equipment".

The life span of the machine can be reduced and the risk of accidents can increase if machine maintenance is not carried out correctly and if service and/or repairs are not carried out professionally. If you need further information please contact Discount-equipment.

- Let Discount-equipment regularly check the machine and make essential adjustments and repairs.

Maintenance schedule

In the maintenance schedule you can see which parts of your machine that require maintenance, and with which intervals it should take place. The intervals are calculated based on daily use of the machine, and may differ depending on the rate of usage.

Daily maintenance	Weekly maintenance	Monthly maintenance
Cleaning	Cleaning	Cleaning
External cleaning		Spark plug
Cooling air intake		Fuel tank
Functional inspection	Functional inspection	Functional inspection
General inspection	Vibration damping system*	Fuel system
Throttle lockout*	Muffler*	Air filter
Stop switch*	Drive belt	Drive gear, clutch
Blade guard*	Carburettor	
Cutting blade**	Starter housing	
Water delivery system		
Check for fuel leaks.		

*See instructions in the section "Machine's safety equipment".

** See instructions in the section "Cutting blades" and "Assembly and settings".

MAINTENANCE

Cleaning

External cleaning

- Clean the machine daily by rinsing it with clean water after the work is finished.

Cooling air intake

- Clean the cooling air intake when needed.

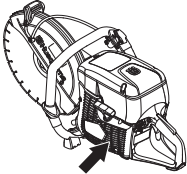

NOTICE! A dirty or blocked air intake results in the machine overheating which causes damage to the piston and cylinder.

Spark plug

- If the machine is low on power, difficult to start or runs poorly at idle speed: always check the spark plug first before taking other steps.
- Ensure that the spark plug cap and ignition lead are undamaged to avoid the risk of electric shock.
- If the spark plug is dirty, clean it and at the same time check that the electrode gap is 0.5 mm. Replace if necessary.

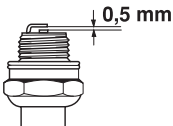

NOTICE! Always use the recommended spark plug type! Use of the wrong spark plug can damage the piston/cylinder.

These factors cause deposits on the spark plug electrodes, which may result in operating problems and starting difficulties.

- An incorrect fuel mixture (too much or incorrect type of oil).
- A dirty air filter.

Functional inspection

General inspection

- Check that nuts and screws are tight.

Drive belt

Tensioning the drive belt

The tension of a new drive belt must be readjusted after one or two tanks of fuel have been used.

When the machine is equipped with a friction retarder, a scraping sound can be heard from the bearing housing when the blade is turned by hand. This is quite normal. Please contact an accredited Husqvarna workshop if you have any questions.

The drive belt is enclosed and well protected from dust and dirt.

- Loosen the three bolts (A) one turn anticlockwise.

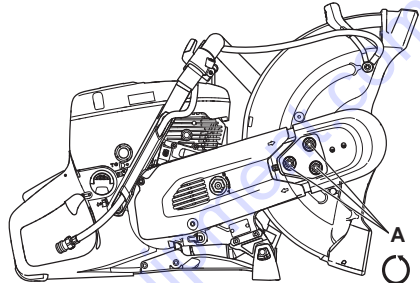

- Wiggle the blade guard (E) up and down 3-5 times, and then tighten the nuts (A) with the combination spanner.

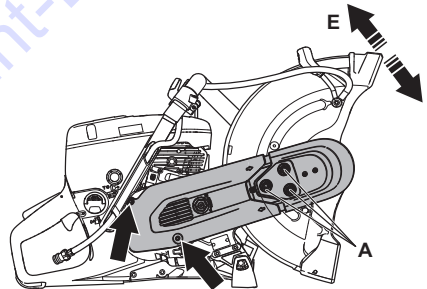

Replacing the drive belt



WARNING! Never start the engine when the belt pulley and clutch are removed for maintenance. Do not start the machine without the cutting arm or cutting head fitted. Otherwise the clutch could come loose and cause personal injuries.

- Loosen the three nuts (A) holding the upper belt guard. Turn the belt tensioner (B) to position "0" to release the tension.

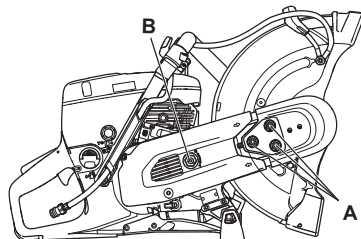

MAINTENANCE

- Remove the upper belt guard.
- Now remove the rear belt guard.

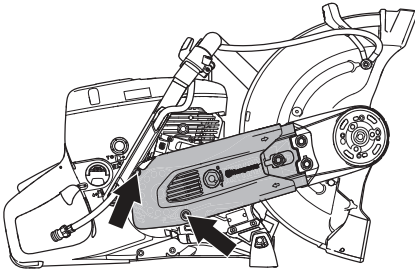

- Replace the drive belt. Turn the belt tensioner (B) to position "1" to tighten the drive belt.

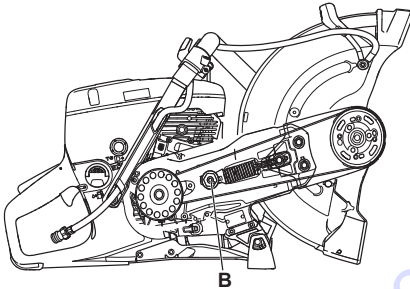

- Fit the belt guards and tighten the nuts (A) finger tight. Wiggle the blade guard (E) up and down 3-5 times, and then tighten the nuts (A) with the combination spanner.

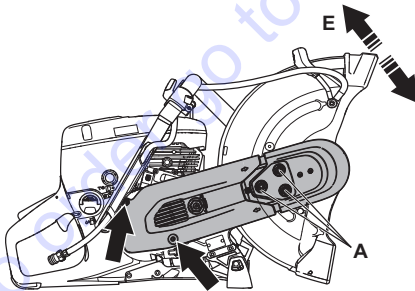

Carburettor

The carburettor is equipped with fixed needles to ensure the machine always receives the correct mixture of fuel and air. When the engine lacks power or accelerates poorly, do the following:

- Check the air filter and replace if necessary. When this does not help, contact Discount-equipment.

Adjusting the idle speed



CAUTION! Contact Discount-equipment, if the idle setting cannot be adjusted so that the blades are stationary. Do not use the machine until it has been properly adjusted or repaired.

Start the engine and check the idling setting. When the carburettor is set correctly the cutting blade should be still while engine is idling.

- Adjust the idle speed using the T screw. When an adjustment is necessary, first turn the screw clockwise until the blade starts to rotate. Now turn the screw anti-clockwise until the blade stops rotating.

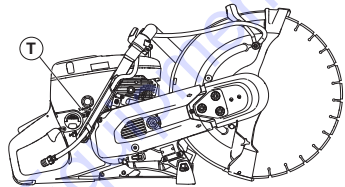

Rec. idle speed: 2700 rpm

Starter housing



WARNING! When the recoil spring is wound up in the starter housing it is under tension and can, if handled carelessly, pop out and cause personal injury.

Always be careful when changing the recoil spring or the starter cord. Always wear protective goggles.

Changing a broken or worn starter cord

- Loosen the screws that hold the starter against the crankcase and remove the starter.

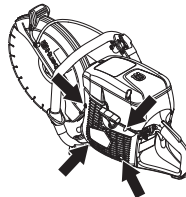

MAINTENANCE

- Pull the cord out about 30 cm and lift it into the cut-out in the periphery of the starter pulley. When the cord is intact: Release the spring tension by letting the pulley rotate slowly backwards.

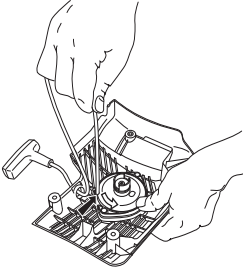

- Remove any remnants of the old starter cord and check that the return spring works. Insert the new starter cord through the hole in the starter housing and in the cord pulley.

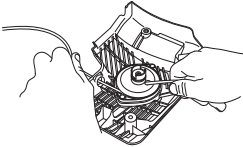

- Secure the starter cord around the cord pulley as illustrated. Tighten the fastening well and ensure that the free end is as short as possible. Secure the end of the starter cord in the starter handle.

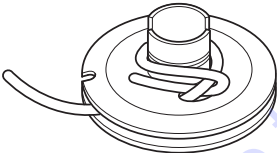

Tensioning the recoil spring

- Guide the cord through the cut-out in the periphery of the pulley and wind the cord 3 times clockwise around the centre of the starter pulley.

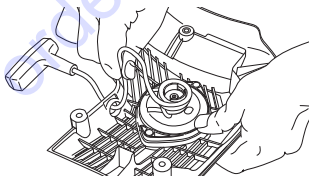

- Now pull the starter handle and in doing so tension the spring. Repeat the procedure once more, but this time with four turns.
- Note that the starter handle is drawn to its correct home position after tensioning the spring.
- Check that the spring is not drawn to its end position by pulling out the starter line fully. Slow the starter pulley with your thumb and check that you can turn the pulley at least a further half turn.

Changing a broken recoil spring

- Undo the bolt in the centre of the pulley and remove the pulley.

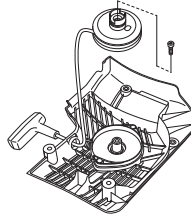

- Bear in mind that the return spring lies tensioned in the starter housing.
- Loosen the bolts holding the spring cassette.

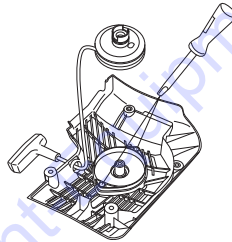

- Remove the recoil spring by turning the starter over and loosen the hooks, with the help of a screwdriver. The hooks hold the return spring assembly on the starter.

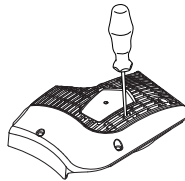

- Lubricate the recoil spring with light oil. Fit the pulley and tension the recoil spring.

Fitting the starter

- To fit the starter, first pull out the starter cord and place the starter in position against the crankcase. Then slowly release the starter cord so that the pulley engages with the pawls.

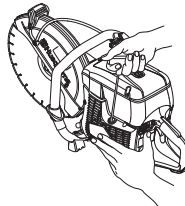

- Tighten the screws.

MAINTENANCE

Fuel system

General

- Check that the fuel cap and its seal are not damaged.
- Check the fuel hose. Replace when damaged.

Fuel filter

- The fuel filter sits inside the fuel tank.
- The fuel tank must be protected from contamination when filling. This reduces the risk of operating disturbances caused by blockage of the fuel filter located inside the tank.
- The filter cannot be cleaned but must be replaced with a new filter when it is clogged. **The filter should be changed at least once per year.**

Air filter

The air filter only needs to be checked if the engine drops in power.

- Loosen the screws. Remove the air filter cover.

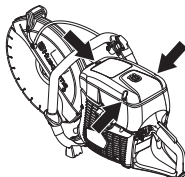

- Check the air filter and replace if necessary.

Replacing the air filter



CAUTION! Unhealthy dust can be spread during filter change. Wear approved respiratory protection. Dispose of filters correctly.

NOTICE! The air filter must not be cleaned or blown clean with compressed air. This will damage the filter.

- Loosen the screws. Remove the cover.

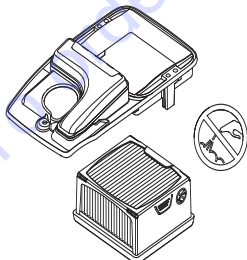

- Replace the air filter.

Drive gear, clutch

- Check the clutch centre, drive gear and clutch spring for wear.

Water delivery system

Check the nozzles on the bladeguard and the filter in the water connection for clogging and clean as necessary.

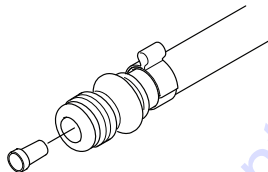

Disposal, scrapping

This product should be submitted to an appropriate recycling station in accordance with local requirements.

By ensuring that this product is taken care of correctly, you can help to counteract the potential negative impact on the environment and people that can otherwise result through the incorrect waste management of this product.

For more detailed information about recycling this product, contact your municipality, your domestic waste service or the shop from where you purchased the product.

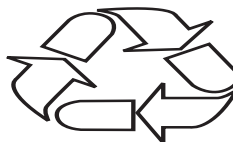

TROUBLESHOOTING

Troubleshooting schedule



WARNING! If service operations or troubleshooting does not require the machine to be on, the engine should be switched off, and the stop switch in STOP position.

Problem	Probable cause	Potential Solution
The machine does not start	Incorrect starting procedure.	See instructions under the heading Starting and stopping.
	Stop switch in the right (STOP) position	Make sure that the stop switch (STOP) is in the left position.
	There is no fuel in the fuel tank	Refill with fuel
	Spark plug defective	Replace the spark plug.
	Defective clutch	Contact Discount-equipment.
The blade rotates at idle	Idle speed too high	Adjust the idle speed
	Defective clutch	Contact Discount-equipment.
The blade does not rotate while throttling up	Belt too loose or defective	Tighten the belt / Replace the belt with a new one
	Defective clutch	Contact Discount-equipment.
	Blade fitted incorrectly	Make sure the blade is properly installed.
The machine has no power while attempting to throttle up	Clogged air filter	Check the air filter and replace if necessary.
	Clogged fuel filter	Replace the fuel filter.
	Fuel tank vent blocked	Contact Discount-equipment.
Vibration levels are too high	Blade fitted incorrectly	Check that the cutting blade is fitted correctly and does not show signs of damage. See the instructions in the sections "Cutting blades" and "Assembly and adjustments".
	Blade defective	Change the blade and make sure it is intact.
	Vibration damping elements defective	Contact Discount-equipment.
Temperature of the machine is too high	Air intake or cooling flanges blocked	Clean the machine's air intake/cooling flanges
	Belt slipping	Check belt / adjust the tension
	Clutch slipping / is defective	Always cut at full throttle.
Check clutch / contact Discount-equipment		

TECHNICAL DATA

Technical data

	K 770, K 770 OilGuard, K 770 Rescue
Cylinder displacement, cm ³ /cu.in	74/4.5
Cylinder bore, mm/inch	51/2
Stroke, mm/inch	36/1.4
Idle speed, rpm	2700
Wide open throttle - no load, rpm	9300 (+/- 150)
Power, kW/hp @ rpm	3.7/5 @ 9000
Spark plug	NGK BPMR7A
Electrode gap, mm/inch	0.5/0.02
Fuel tank capacity, litre/US fl. Oz	0.9/30
Recommended water pressure, bar/PSI	0.5-10/7-150

Weight	12" (300 mm)	14" (350 mm)
Power cutter without fuel and cutting blade, kg/lb*	10/22	10.1/22.3
*Rescue carry strap, additional 0.4kg/0.9lb.		
Spindle, output shaft		
Max spindle speed, rpm	4700	4700
Max. peripheral speed, m/s / ft/min	80/16000	90/18000

Noise emissions (see note 1)		
Sound power level, measured dB(A)	113	113
Sound power level, guaranteed L _{WA} dB(A)	115	115
Sound levels (see note 2)		
Equivalent sound pressure level at the operator's ear, dB(A)	101	101
Equivalent vibration levels, a_{hveq} (see note 3)		
Front handle, m/s ²	<2,5	<2,5
Rear handle, m/s ²	<2,5	<2,5

Note 1: Noise emissions in the environment measured as sound power (L_{WA}) in conformity with EC directive 2000/14/EC. The difference between guaranteed and measured sound power is that the guaranteed sound power also includes dispersion in the measurement result and the variations between different machines of the same model according to Directive 2000/14/EC.

Note 2: Equivalent sound pressure level, according to EN ISO 19432, is calculated as the time-weighted energy total for different sound pressure levels under various working conditions. Reported data for equivalent sound pressure level for the machine has a typical statistical dispersion (standard deviation) of 1 dB(A).

Note 3: Equivalent vibration level, according to EN ISO 19432, is calculated as the time-weighted energy total for vibration levels under various working conditions. Reported data for equivalent vibration level has a typical statistical dispersion (standard deviation) of 1 m/s².

Recommended abrasive and diamond cutting blade, specification

Cutting blade	Max cutting depth, mm/inch	Blade speed rating, rpm	Blade speed rating, m/s / ft/min	Blade center hole diameter, mm/inch	Max blade thickness, mm/inch
12" (300 mm)	100/4	5100	80/16000	25.4/1 or 20/0.79	5/0.2
14" (350 mm)	125/5	5500	100/19600	25.4/1 or 20/0.79	5/0.2

TECHNICAL DATA

To order go to Discount-Equipment.com

To order go to Discount-Equipment.com

GB - Original instructions

1158925-26, rev 2



2018-10-18

TO PURCHASE THIS PRODUCT PLEASE CONTACT US



**Equipment Financing and
Extended Warranties Available**



**Discount-Equipment.com is your online resource for
commercial and industrial quality parts and equipment sales.**

561-964-4949

visit us on line @ www.discount-equipment.com

Select an option below to find your Equipment

Search by Manufacturer

Search by Product Type

Request a Quote

We sell worldwide for the brands: Genie, Terex, JLG, MultiQuip, Mikasa, Essick, Whiteman, Mayco, Toro Stone, Diamond Products, Generac Magnum, Airman, Haulotte, Barreto, Power Blanket, Nifty Lift, Atlas Copco, Chicago Pneumatic, Allmand, Miller Curber, Skyjack, Lull, Skytrak, Tsurumi, Husquvarna Target, Stow, Wacker, Sakai, Mi-T-M, Sullair, Basic, Dynapac, MBW, Weber, Bartell, Bennar Newman, Haulotte, Ditch Runner, Menegotti, Morrison, Contec, Buddy, Crown, Edco, Wyco, Bomag, Laymor, EZ Trench, Bil-Jax, F.S. Curtis, Gehl Pavers, Heli, Honda, ICS/PowerGrit, IHI, Partner, Imer, Clipper, MMD, Koshin, Rice, CH&E, General Equipment, Amida, Coleman, NAC, Gradall, Square Shooter, Kent, Stanley, Tamco, Toku, Hatz, Kohler, Robin, Wisconsin, Northrock, Oztec, Toker TK, Rol-Air, APT, Wylie, Ingersoll Rand / Doosan, Innovatech, Con X, Ammann, Mecalac, Makinex, Smith Surface Prep, Small Line, Wanco, Yanmar