



**CORE CUT
OPERATOR'S MANUAL**

**CC7574DK
CC7574DD**

JULY 2020

TO PURCHASE THIS PRODUCT PLEASE CONTACT US



**Equipment Financing and
Extended Warranties Available**



**Discount-Equipment.com is your online resource for
commercial and industrial quality parts and equipment sales.**

561-964-4949

visit us on line @ www.discount-equipment.com

Select an option below to find your Equipment

Search by Manufacturer

Search by Product Type

Request a Quote

We sell worldwide for the brands: Genie, Terex, JLG, MultiQuip, Mikasa, Essick, Whiteman, Mayco, Toro Stone, Diamond Products, Generac Magnum, Airman, Haulotte, Barreto, Power Blanket, Nifty Lift, Atlas Copco, Chicago Pneumatic, Allmand, Miller Curber, Skyjack, Lull, Skytrak, Tsurumi, Husquvarna Target, Stow, Wacker, Sakai, Mi-T-M, Sullair, Basic, Dynapac, MBW, Weber, Bartell, Bennar Newman, Haulotte, Ditch Runner, Menegotti, Morrison, Contec, Buddy, Crown, Edco, Wyco, Bomag, Laymor, EZ Trench, Bil-Jax, F.S. Curtis, Gehl Pavers, Heli, Honda, ICS/PowerGrit, IHI, Partner, Imer, Clipper, MMD, Koshin, Rice, CH&E, General Equipment, Amida, Coleman, NAC, Gradall, Square Shooter, Kent, Stanley, Tamco, Toku, Hatz, Kohler, Robin, Wisconsin, Northrock, Oztec, Toker TK, Rol-Air, APT, Wylie, Ingersoll Rand / Doosan, Innovatech, Con X, Ammann, Mecalac, Makinex, Smith Surface Prep, Small Line, Wanco, Yanmar

TABLE OF CONTENTS

Table of Contents

Introduction	6
CC7574DK Controls	7
CC7574DK Dimensions	9
CC7574DK Specifications	10
CC7574DD Controls	11
CC7574DD Dimensions	13
CC7574DD Specifications	14
Safety	15
Safety Alerts	15
Proposition 65	15
Spark Arrester Requirement	15
Respiratory Hazards	15
General Safety	16
Battery and Electrical Safety	17
Blade Safety	17
Blade Guard Safety	17
Fuel Safety	18
Engine Safety	18
Cutting Safety	18
Hydraulic Safety	19
Belt Safety	19
Transporting Safety	19
Lifting Safety	19
Display Panel	20
Soft Keys (Buttons)	21
Status Icons	22
Main Menu	23
Arrow	23
DPF Commands	23
Main Menu Action Items	24
Gauges	24
Diagnostics	24
Active Diagnostics	25
Logged Diagnostics	25
System Information	25
User Settings	26
Screen Color	26
Screen Brightness	26
Language	27
Units	27
Automatic Shutdown	27
Operating	28
Tie-Downs	28
Footrest	28
Weight Bar (Optional)	28
Spotlight	28
Handlebars	28
Adjusting the Handlebars	28
Control Grip Pushbuttons	29
Fuel System	29
Adding Fuel	29
Blade Guard	29

TABLE OF CONTENTS

Installing the Blade Guard.....	30
Removing the Blade Guard	30
Flange Guard	30
Installing the Flange Guard	30
Removing the Flange Guard.....	30
Diamond Blades.....	30
Inspecting the Blade.....	31
Blade Speed.....	31
Wrench.....	31
Installing the Blade.....	31
Removing the Blade.....	32
Engine.....	33
Tasks Prior to Starting the Engine.....	33
Throttle Operation.....	33
Starting the Engine.....	33
Stopping the Engine.....	33
Speed Control Lever.....	34
Blade Lowering Speed.....	34
Water Supply.....	34
Using the Water Supply.....	34
Cutting Guides	35
Adjusting the Front Pointer.....	35
Adjusting the Rear Pointer(s).....	35
Concrete Cutting.....	35
Helpful Hints Prior to Cutting.....	35
Tasks Prior to Cutting.....	36
Making a Cut.....	36
Making a Cut Using the Blade Depth Stop.....	36
Continuing a Partial Cut.....	37
Finishing a Cut.....	37
Hood Operation.....	37
Shifting the Three Speed Transmission.....	37
Maintenance.....	38
General.....	38
Daily.....	38
After First 50 Hours.....	38
Every 100 Hours.....	38
Every 250 Hours.....	38
Every 500 Hours.....	38
Part Lubrication.....	38
Fuel/Water Separator.....	39
Speed Control Lever.....	39
Adjusting the Lever Tension.....	39
Adjusting the Spring Plungers.....	40
Inner Blade Flange.....	40
Installing the Inner Blade Flange.....	40
Removing the Inner Blade Flange.....	40
Drive Alignment.....	40
Adjusting the Drive Alignment.....	40
Wheels.....	40
Replacing the Front Wheels.....	41
Replacing the Rear Wheels.....	41
Maximum Cutting Depth.....	41
Handlebar Cylinder Rod.....	42

TABLE OF CONTENTS

Removing the Cylinder Rod.....	42
Connecting the Cylinder Rod.....	42
Battery.....	42
Battery Type.....	43
Servicing the Battery.....	43
Electrical System.....	43
Radiator.....	43
Adding Radiator Fluid – CC7574DK.....	44
Adding Radiator Fluid – CC7574DD.....	44
Changing the Radiator Fluid – CC7574DK.....	44
Changing the Radiator Fluid – CC7574DD.....	45
Bleeding Air from the Coolant System – CC7574DK.....	45
Hydraulic System.....	45
Adding Fluid to the Hydraulic Lift Pump.....	45
Adding Hydraulic Fluid to the Hydro Pump Reservoir Tank.....	46
Replacing the Hydraulic Oil Filter.....	46
Upper Gearbox.....	46
Changing the Upper Gearbox Oil.....	46
Draining the Upper Gearbox Heat Sink.....	46
Lower Gearbox.....	47
Changing the Lower Gearbox Fluid.....	47
Changing the In-Line Oil Suction Filter.....	47
Belt Sheaves.....	47
Removing the Belt Sheaves.....	47
Installing Belt Sheaves.....	48
Blade Drive Belts.....	48
Tensioning/Replacing the Blade Drive Belts.....	48
In-Line Fuel Filter.....	49
Engine.....	49
Cleaning the Engine.....	50
Changing the Engine Oil.....	50
Air Cleaner.....	50
Restriction Indicator.....	50
Rubber Dust Ejector Boot.....	50
Cleaning/Replacing the Outer Primary Filter.....	51
Replacing the Inner Safety Filter.....	51
Storing.....	52
Disposal.....	52
Engine Regeneration.....	52
Passive Regeneration.....	52
Active Regeneration.....	53
Parked Regeneration.....	53
Cold Weather Parked Regeneration.....	54
Requesting a Parked Regeneration.....	54
Appendix A.....	56
Daily Maintenance Task Chart.....	56
Appendix B.....	57
Troubleshooting the CC7574DK.....	57
Troubleshooting the CC7574DD.....	58
Appendix C.....	60
Additional References.....	60
Appendix D.....	62
Model and Serial Numbers.....	62

INTRODUCTION

Introduction

Welcome to the Diamond Products family and thank you for choosing Diamond Products equipment. At Diamond Products we are driven to ensure you are completely satisfied with your product and continually strive to improve our product line so that we can offer you the best possible equipment in the industry.

This operator's manual is a critical document that provides pertinent information regarding the safety, operation, maintenance, and care of your new equipment. Keep this manual available at all times. Operate the equipment and all of its components according to this manual. Failure to comply with and understand the following safety, operation and maintenance instructions can result in serious injuries and/or death. All operators must be properly trained or supervised by experienced personnel prior to using this saw and should understand the risks and hazards involved. Diamond Products discourages improper or unintended equipment usage and cannot be held liable for any resulting damages.

Equipment modifications should be made by Diamond Products to ensure safety and design. Any modifications made by the owner(s) are not the responsibility of Diamond Products and void all equipment warranties if a problem arises as a result of the modification.

Refer to the Diamond Products Parts List for additional information and part diagrams. Refer to the engine manufacturer as the primary source for all safety, operations, and maintenance instructions regarding the engine. Prior to operating, record the saw's serial number, and the engine's model and serial numbers in Appendix D.

CC7574DK Controls

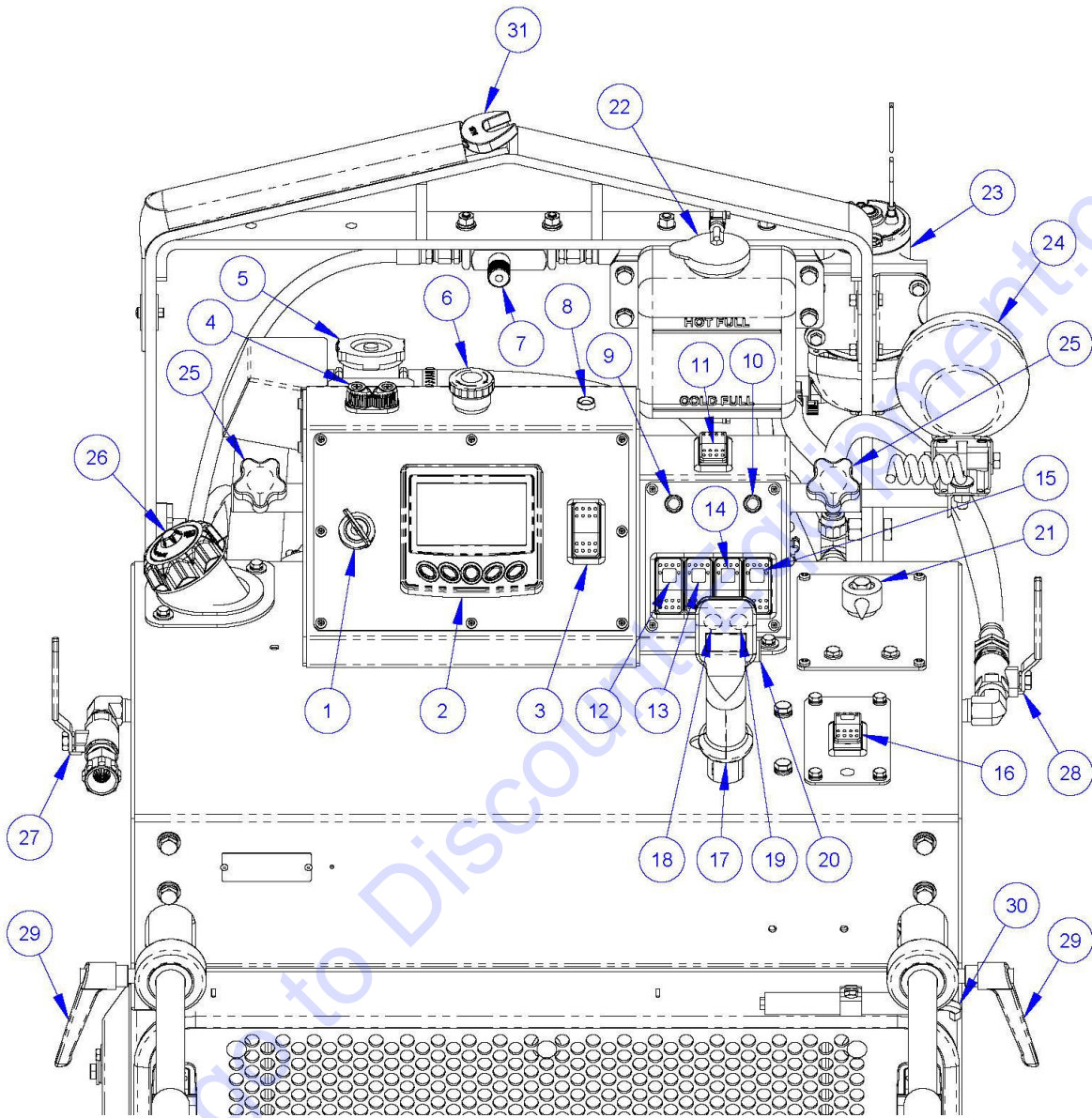

- | | |
|---|--|
| <ol style="list-style-type: none"> 1. Ignition Switch – Starts the engine and provides power to certain components. 2. Engine Display Panel – Monitors and displays various engine and machine parameters. 3. Engine Throttle Switch – Increases and decreases engine/blade speed (RPM). 4. Cable Cleat – Secures front pointer rope. 5. Radiator Cap – Fill port for changing radiator coolant. 6. Emergency Stop Button – Stops the engine. 7. Lowering Speed Control Valve – Adjusts saw's lowering speed. | <ol style="list-style-type: none"> 8. Blade Gearbox Temperature Light – Indicates high oil temperature in blade gearbox. 9. Low Blade Water Light – Indicates low water pressure to blade. 10. Blade Depth Set Light – Indicates that the blade depth is set. 11. Blade Depth Stop Switch – Sets and resets blade depth setting. 12. Free Wheel Switch – Allows operator to move saw forward/backward (with ignition switch at <i>RUN</i>). 13. Auto Water Switch – Activates automatic water system. Water turns on/off when depth indicator enters <i>Auto Water On/Off Zone</i> |
|---|--|

INTRODUCTION

14. **Spotlight Switch** – Activates spotlight.
15. **Water Pump Switch (Optional)** – Activates water pump.
16. **Blade Clutch Switch (DKC Model)** – Allows for engaging/disengaging blade rotation.
17. **Speed Control Lever** – Forward, reverse, and neutral control.
18. **Saw Raise Pushbutton** – Activates hydraulic pump to raise saw.
19. **Saw Lower Pushbutton** – Bleeds hydraulic pressure from lift cylinder to lower saw.
20. **Tilt Handlebar Pushbutton** – Adjusts angle of handlebars.
21. **Cutting Depth Indicator** – Indicates blade depth from cutting surface.
22. **Coolant Recover Tank Cap** – Fill port for adding radiator coolant.
23. **Water Pump (Optional)** – Transfers water from the water source to the saw blade.
24. **Spot Light** – Illuminates the work area.
25. **Spot Light Adjustment Knob** – Locks the spot light bar in place.
26. **Fuel Filler Cap** – Fill Port.
27. **Water Metering Control Valve** – Controls water flow rate. Connects to the water source hose.
28. **Water On/Off Control Valve**- Turns water flow, to the saw blade, on and off.
29. **Handlebar Lock Lever** – Locks the handlebar in position.
30. **Speed Control Friction Wrench** – Used to adjust pressure on the speed control friction washer.
31. **Blade Shaft Wrench** – Used to install and remove blades from the blade shaft.

INTRODUCTION

CC7574DK Dimensions

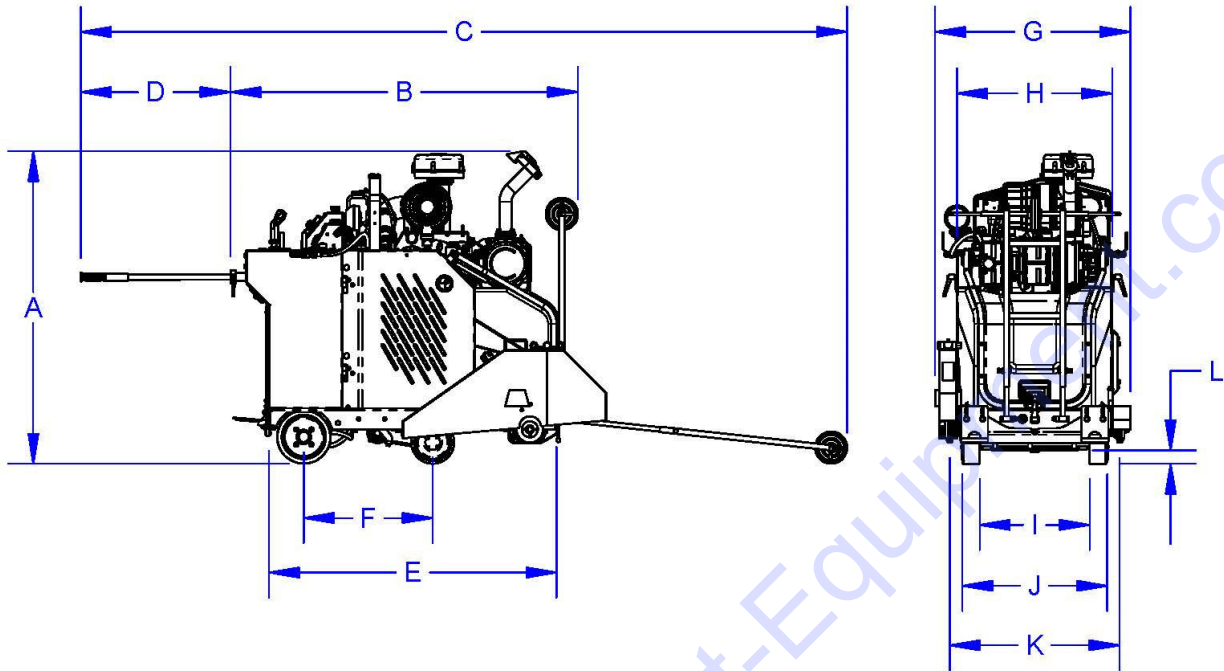

CC7574DK Dimensions		Inches	Millimeters
A	Saw Height	58-1/2	1486
B	Saw Length – Minimum	65	1651
C	Saw Length – Maximum	143	3632
D	Handle Extension – Maximum	28	711
E	Frame Length	53-3/4	1365
F	Wheel Base Length	24-1/4	616
G	Saw Width	36-1/2	927
H	Frame Width	29	737
I	Front Wheels Inside Width	20-1/2	520
J	Rear Wheels Outside Width	27-1/4	692
K	Inner Flange to Inner Flange Width	31-3/4	806
L₁	Ground Clearance (Saw Level)	2-1/2	63
L₂	Ground Clearance (Saw Raised)	1-3/4	44
-	Blade Raised Height - Maximum	26	660

INTRODUCTION

CC7574DK Specifications

CC7574DK Specifications	
Maximum Cutting Depth	19-3/4" with 48" blade
Blade Shaft Diameter	2"
Arbor Diameter	1" with single drive pin
Blade Shaft Bearings	Multiple ball bearings in oil bath
Blade Shaft Drive	20 V-belts (four power bands)
Blade Mounting	Right or left
Blade Raise/Lower	Electro-hydraulic pump
Blade Coolant	Dual multi-spray tubes
Blade Guard Attachment	Slip-on through 30", bolt-on 36" and up
Handlebars	Length and tilt adjustable
Drive Speed	0-250 feet/min
Front Wheels	8" x 3"
Rear Wheels	10" x 3"
Transmission	Hydro pump powering dual wheel motors
Uncrated Weight <i>(add 125 Lbs. for crated weight)</i>	2,000-2,300 Lbs. <i>(weight depends on model and added options)</i>

Engine Specifications	
Manufacturer	Kubota
Model	V3307-CR-T-E4-B
Maximum Horsepower (HP)	74.3 HP @ 2,600 RPM
Fuel Capacity	Nine gallons
Fuel Type	Low sulfur/ultra-low sulfur diesel fuel
Air Filter	Four-stage with restriction indicator
Power at Blade Shaft	70 HP
<i>Note: Refer to the engine manual and manufacturer for additional engine information and specifications.</i>	

CC7574DD Controls

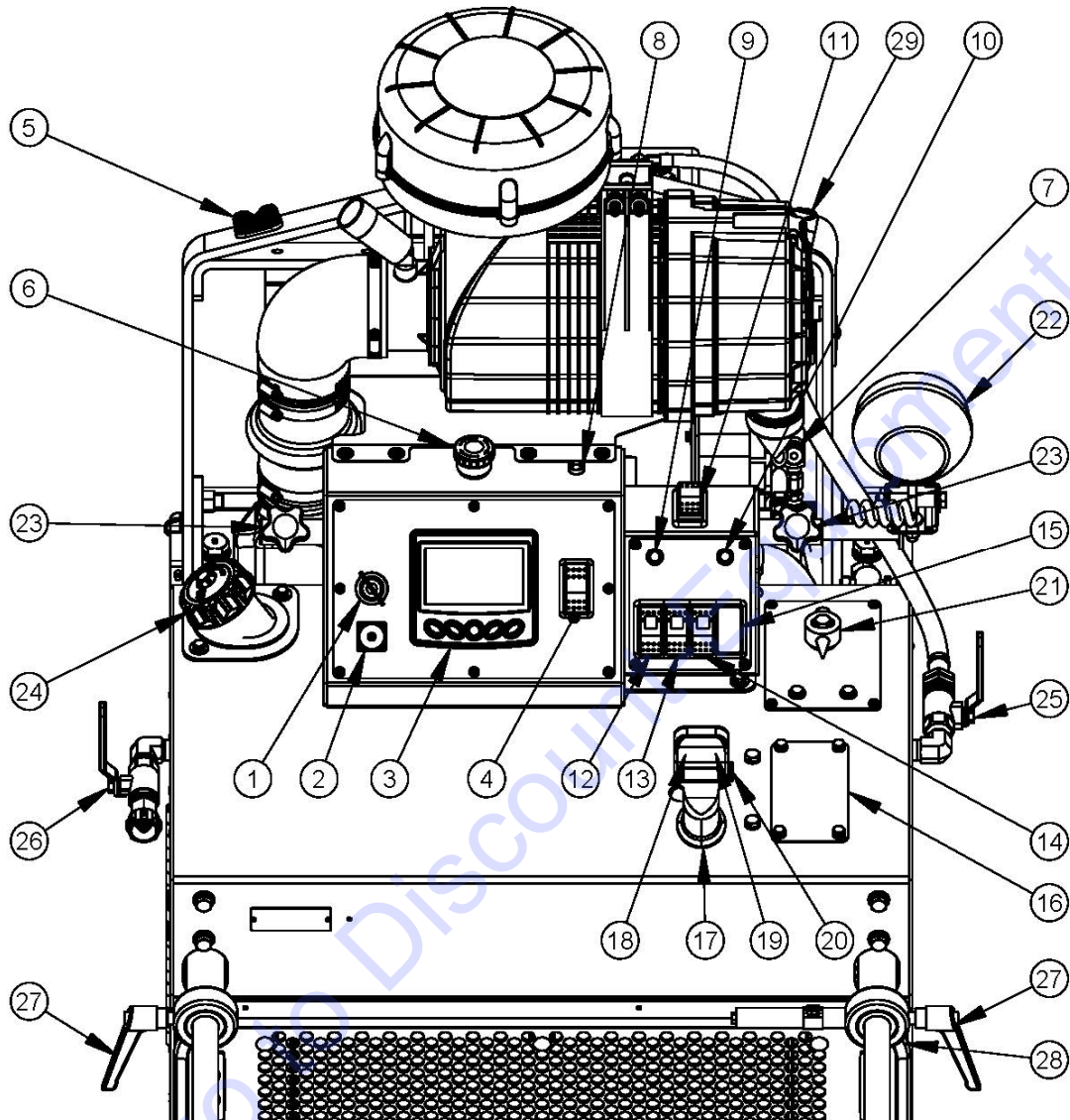

- | | |
|--|---|
| <ol style="list-style-type: none"> 1. Ignition Switch – Starts the engine and provides power to certain components. 2. Diagnosis Port – Used by service personnel to monitor engine parameters. 3. Engine Display Panel – Monitors and displays various engine and machine parameters. 4. Engine Throttle Switch – Increases and decreases engine/blade speed (RPM). 5. Cable Cleat – Secures front pointer rope. 6. Emergency Stop Button – Stops the engine. 7. Lowering Speed Control Valve – Adjusts saw's lowering speed. | <ol style="list-style-type: none"> 8. Blade Gearbox Temperature Light – Indicates high oil temperature in blade gearbox. 9. Low Blade Water Light – Indicates low water pressure to blade. 10. Blade Depth Set Light – Indicates that the blade depth is set. 11. Blade Depth Stop Switch – Sets and resets blade depth setting. 12. Auto Water Switch – Activates automatic water system. Water turns on/off when depth indicator enters <i>Auto Water On/Off Zone</i>. 13. Free Wheel Switch – Allows operator to move saw forward/backward (with ignition switch at <i>RUN</i>). |
|--|---|

INTRODUCTION

14. **Spotlight Switch** – Activates spotlight.
15. **Water Pump Switch (Optional)** – Activates water pump.
16. **Blade Clutch Switch (DDC Model)** – Allows for engaging/disengaging blade rotation.
17. **Speed Control Lever** – Forward, reverse, and neutral control.
18. **Saw Raise Pushbutton** – Activates hydraulic pump to raise saw.
19. **Saw Lower Pushbutton** – Bleeds hydraulic pressure from lift cylinder to lower saw.
20. **Tilt Handlebar Pushbutton** – Adjusts angle of handlebars.
21. **Cutting Depth Indicator** – Indicates blade depth from cutting surface.
22. **Spot Light** – Illuminates the work area.
23. **Spot Light Adjustment Knob** – Locks the spot light bar in place.
24. **Fuel Filler Cap** – Fill Port.
25. **Water Metering Control Valve** – Controls water flow rate. Connects to the water source hose.
26. **Water On/Off Control Valve**- Turns water flow, to the saw blade, on and off.
27. **Handlebar Lock Lever** – Locks the handlebar in position.
28. **Speed Control Friction Wrench** – Used to adjust pressure on the speed control friction washer.
29. **Blade Shaft Wrench** – Used to install and remove blades from the blade shaft.

INTRODUCTION

CC7574DD Dimensions

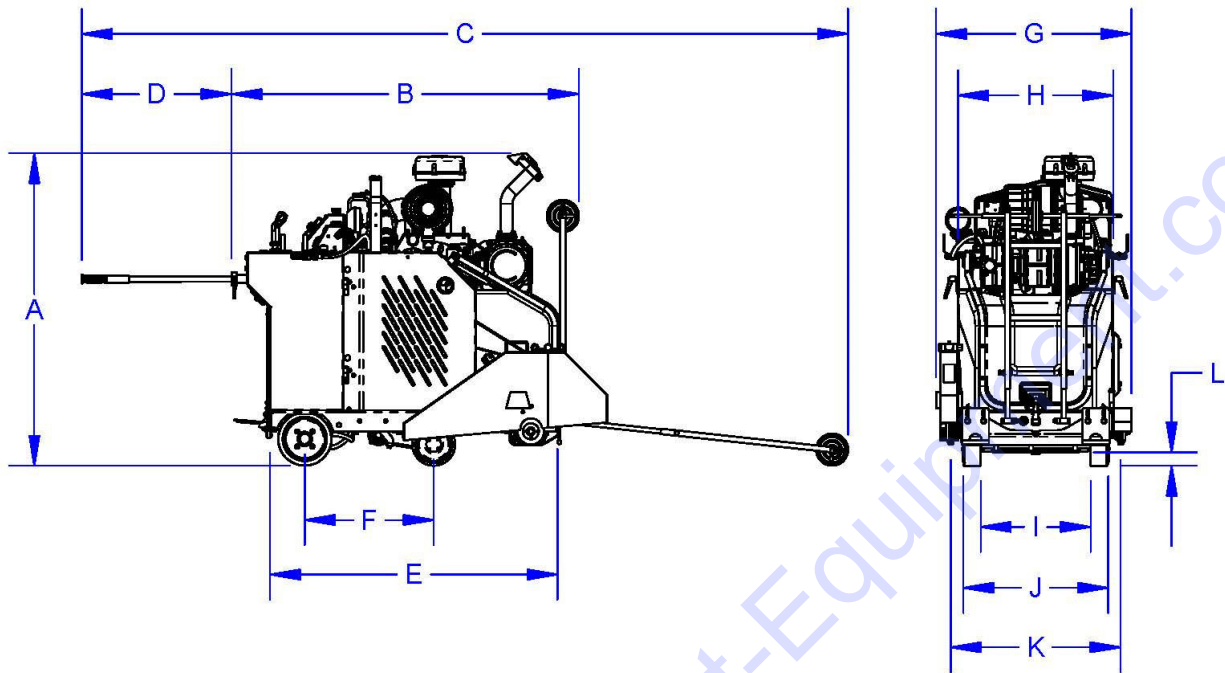

CC7475DD Dimensions		Inches	Millimeters
A	Saw Height	58-1/2	1486
B	Saw Length – Minimum	65	1651
C	Saw Length – Maximum	143	3632
D	Handle Extension – Maximum	28	711
E	Frame Length	53-3/4	1365
F	Wheel Base Length	24-1/4	616
G	Saw Width	36-1/2	927
H	Frame Width	29	737
I	Front Wheels Inside Width	20-1/2	520
J	Rear Wheels Outside Width	27-1/4	692
K	Inner Flange to Inner Flange Width	31-3/4	806
L₁	Ground Clearance (Saw Level)	2-1/2	63
L₂	Ground Clearance (Saw Raised)	1-3/4	44
-	Blade Raised Height - Maximum	26	660

INTRODUCTION

CC7574DD Specifications

CC7574DD Specifications	
Maximum Cutting Depth	19-3/4" with 48" blade
Blade Shaft Diameter	2"
Arbor Diameter	1" with single drive pin
Blade Shaft Bearings	Multiple ball bearings in oil bath
Blade Shaft Drive	20 V-belts (four power bands)
Blade Mounting	Right or left
Blade Raise/Lower	Electro-hydraulic pump
Blade Coolant	Dual multi-spray tubes
Blade Guard Attachment	Slip-on through 30", bolt-on 36" and up
Handlebars	Length and tilt adjustable
Drive Speed	0-250 feet/min
Front Wheels	8" x 3"
Rear Wheels	10" x 3"
Transmission	Hydro pump powering dual wheel motors
Uncrated Weight <i>(add 125 Lbs. for crated weight)</i>	2,000-2,300 Lbs. <i>(weight depends on model and added options)</i>

Engine Specifications	
Manufacturer	Deutz
Model	TD 2.9 L4
Maximum Horsepower (HP)	74.3 HP @ 2,600 RPM
Fuel Capacity	Nine gallons
Fuel Type	Low sulfur/ultra-low sulfur diesel fuel
Air Filter	Four-stage with restriction indicator
Power at Blade Shaft	74 HP
<i>Note: Refer to the engine manual and manufacturer for additional engine information and specifications.</i>	

SAFETY PRECAUTIONS

Safety

Operate the equipment and all of its components according to this manual. Failure to comply with and understand the following safety, operation and maintenance instructions can result in serious injuries and/or death. All operators must be properly trained or supervised by experienced personnel prior to using this saw and should understand the risks and hazards involved. Diamond Products discourages improper or unintended equipment usage and cannot be held liable for any resulting damages.

Equipment modifications should be made by Diamond Products to ensure safety and design. Any modifications made by the owner(s) are not the responsibility of Diamond Products and void all equipment warranties if a problem arises as a result of the modification.

Refer to the Diamond Products Parts List for additional information and part diagrams. Refer to the engine manual and manufacturer as the primary source for all safety, operations, and maintenance instructions regarding the engine. Prior to operating, record the saw's serial number, and the engine's model and serial numbers in Appendix D.

Notice: The information in this manual may be updated at any time!

Safety Alerts



DANGER

Serious injuries and/or death will occur if these instructions are not followed.



WARNING

Serious injuries and/or death could occur if these instructions are not followed.



CAUTION

Mild and/or moderate injuries could occur if these instructions are not followed.

Proposition 65

PROPOSITION 65



WARNING: This product produces gasoline or diesel engine exhaust, which is known to the state of California to cause cancer, birth defects or other reproductive harm. For more information go to:

WWW.P65WARNINGS.CA.GOV

Spark Arrester Requirement



WARNING

In the State of California it is a violation of section 4442 or 4443 to use or operate the engine on any forest-covered, brush-covered, or grass-covered land unless the engine is equipped with a spark arrester, as defined in section 4442, maintained in effective, working order or the engine is constructed, equipped, and maintained for the prevention of fire pursuant to section 4443.

Respiratory Hazards



WARNING

Concrete cutting produces dust and fumes known to cause illness, death, cancer, respiratory disease, birth defects, and/or other reproductive harm. Safety protection techniques include, but are not limited to:

- Wearing gloves.
- Wearing safety goggles or a face shield.
- Using approved respirators.
- Washing work clothes daily.
- Using water when wet cutting to minimize dust.
- Washing the hands and face prior to eating/drinking.

For additional safety and self-protection information contact your employer, the Occupational Safety and Health Administration (OSHA), and/or The National Institute for Occupational Safety and Health (NIOSH).

SAFETY PRECAUTIONS

General Safety

- Read and understand all safety, operations, and maintenance instructions provided in this manual prior to operating or servicing the saw.
- Keep equipment components clean and free of slurry, concrete dust, and debris.
- Inspect water hoses prior to operating the equipment. Clean, repair, or replace damaged components.
- Raise the equipment to a proper height for access when working underneath the equipment. Use chocks to block the wheels, and fit blocks or jacks under the frame edges.



WARNING

Do NOT work on equipment using the hydraulic lift system to keep the equipment in the raised position for maintenance or repair. Accidental loss of hydraulic pressure could cause the equipment to drop suddenly, resulting in serious injury or death.

- When using a jack to raise the equipment, place the jack against a solid, flat area under the frame base to properly support the equipment.
- Repair the equipment immediately when a problem arises.
- Replace equipment decals if unreadable.
- Dispose of all hazardous waste materials according to city, state, and federal regulations.
- Always have a phone nearby, and locate the nearest fire extinguisher and first aid kit prior to operating the equipment.
- Operate the equipment wearing flame resistant clothing.
- Always wear safety glasses when removing retaining rings.
- Underage or non-trained personnel should not operate the equipment.
- Keep all body parts away from rotating machinery.
- Replace all guards and access panels (unless stated otherwise) prior to operating the equipment.
- Always pivot front of blade guard fully closed to avoid serious injuries.

DO NOT:

- Assume the equipment will remain still when in neutral or when parking/stopping the equipment on a slope. Chock the wheels to help prevent unnecessary movement.
- Drop equipment, supplies, tools, etc., when handling to help prevent injuries.
- Lift and carry equipment, supplies, tools, etc., that are too heavy and/or cannot be lifted easily.
- Operate the equipment without using the appropriate safety equipment required for the work task.



- Operate or service the equipment with any clothing, hair, or accessories that can snag in the machinery, which could lead to serious injuries or death!
- Operate the equipment using attachments not associated with or recommended for the equipment.
- Operate the equipment around combustible materials.
- Operate the equipment with anyone near the work area or within the direct line of the blade.
- Operate the equipment until all unnecessary materials have been removed from the work area.
- Operate the equipment with loose nuts, screws, and bolts.
- Operate the equipment when ill or fatigued.
- Operate the equipment under the influence of drugs and/or alcohol.
- Operate the equipment on steep slopes.
- Cut concrete with guards and access panels removed.
- Grease the equipment with the engine running.
- Touch hot components when operating the equipment.
- Leave the equipment unattended until the engine is off and the blade has stopped.
- Place the equipment into storage until it has cooled down.
- Service the equipment until it has cooled down.
- Service the equipment with the engine running.

Battery and Electrical Safety

- Ignitable explosive gases are emitted from the battery. DO NOT expose the battery to sparks or open flames. 
- Keep the area around the battery well-ventilated.
- Keep the battery level when handling it.
- Use protective eyewear or a face shield, and avoid contact with the skin when handling/servicing the battery.
- Use a proper battery tester when testing the battery strength.
- Always be sure to connect the battery cables to the proper terminal when reconnecting the cables.
- Occasionally inspect the battery, cables, clamps, and terminals for damages. Service components as necessary.
- Always keep the battery cable clamps away from the battery terminals when the battery is disconnected to avoid accidental connections while servicing.
- Immediately rinse your clothing, skin, or eyes with water if exposed to battery acid. Seek medical attention immediately!
- Disconnect the battery prior to servicing all equipment components (unless stated otherwise).
- Remove the battery when storing the equipment for longer periods.
- Always use the correct size fuses (amps) to prevent fires.

Blade Safety

- Always use reinforced abrasive blades or steel-centered diamond blades.
- Never use a wet cutting blade without an adequate water supply to properly lubricate the blade.
- Inspect all blades prior to usage and discard damaged blades.
- DO NOT install or remove a blade with the engine running.
- Keep all body parts away from rotating blades.
- Inspect the blade flanges for damages, wear, and cleanliness. Clean or replace dirty/damaged components immediately.

- DO NOT expose yourself or anyone else to the direct line of the blade when operating the equipment. 
- Always use an appropriate size blade and the correct blade type based on the cutting task and the type of material being cut.
- The blade must always fit snug on the blade shaft, outer flange, and/or inner flange.
- Wear gloves and be alert to the surrounding environment when handling blades.
- When installing the blade, always point the arrow printed on the blade in the direction of the blade shaft's rotation.
- DO NOT exceed the blade's maximum recommended speed when cutting. Excessive blade speeds can cause blade breakage, resulting in serious injuries and/or death!
- DO NOT use damaged blades when cutting to avoid harming yourself, others, or the equipment.
- DO NOT use a blade for cutting that requires a lower speed than the blade shaft speed.
- Always tighten the blade shaft bolt/screw as directed to properly secure the outer flange and blade. Failure to properly secure the outer flange and blade may cause parts to loosen or fall off the equipment, resulting in serious injuries or death!
- Let the blade cool prior to removal when dry cutting (applicable models).

Blade Guard Safety

- DO NOT operate the equipment with the blade guard raised or removed.
- Blade exposure should not exceed 180° while cutting.
- When pivoting the front of the blade guard, raise/lower it cautiously and slowly to avoid serious injuries.
- DO NOT pivot the blade guard front up or down when installing/removing very large blades. Attempting to pivot the front of a heavy guard when the guard is positioned higher up for blade installation/removal makes the guard difficult to lift and/or lower. In this situation, install/remove the blade guard front instead of pivoting it.

SAFETY PRECAUTIONS



- Always pivot the front of the blade guard 180° (fully upward) so the guard does not swing down unexpectedly, causing serious injuries. 
- Always secure the pivoted section of the blade guard using the detent pin (guards 26" and up).
- Use extreme caution when installing/removing parts of a guard or the entire guard as guards can be extremely heavy and may require installation/removal at moderate heights.
- DO NOT install or remove the blade guard with the engine running.
- Always use a blade guard that corresponds with the blade size.
- Inspect the blade guard and water tubes prior to starting the equipment. Clean or replace dirty/damaged components immediately.

Fuel Safety

- Always use caution when refueling.
- Store all fuel in appropriate safety containers.
- DO NOT operate the equipment with a fuel leak.
- DO NOT fuel the equipment with the engine running.
- Let the engine cool prior to adding fuel.
- Refer to the engine manual for recommended fuels.
- Always use appropriate fuels in cold weather.
- Move the equipment away from the refueling area prior to starting the engine.
- DO NOT smoke or expose fuel to open flames when filling the fuel tank or working with fuel. 
- Clean up any spilled fuel prior to starting the engine.
- Drain the fuel tank and fuel lines when storing the equipment for longer periods of time. Refer to the engine manual for additional recommendations.

Engine Safety

- Refer to the engine manual as the primary source for engine safety.
- Always know how to turn off the engine quickly for emergency purposes.

- Make sure the equipment is in neutral when starting the engine.
- Fill the fuel tank and check the oil level prior to starting the engine.
- Keep all body parts away from rotating equipment parts with the engine in operation. 
- DO NOT start the engine without the air filter(s) installed.
- DO NOT allow dust to enter the air intake tube when cleaning/replacing air filter(s).
- Replace damaged components immediately that may allow dust to enter the engine.
- DO NOT leave the engine running unattended.
- Always operate the equipment in well-ventilated areas. Concentrated engine exhaust can cause loss of consciousness and/or death. 
- DO NOT touch the engine/muffler assembly with the engine running, and always let them cool down prior to touching or servicing the equipment.
- Handle hot oil carefully when changing the oil.
- Let the engine cool prior to removing pressurized caps (applicable models).
- DO NOT use any starter substances or starter fluids (e.g., starter fluid sprayed into the air filter) when starting the engine using a glow plug (applicable models). These materials are extremely flammable and explosive, and can melt parts or possibly explode when used to help start the engine.

Cutting Safety

- The direct work area should not contain buried or embedded electrical, gas, or water lines that could be damaged and/or cause personal injury while cutting.
- Turn off all electricity, gas, and water around the direct work area prior to cutting.
- Inspect the work area to ensure nothing will impede full control of the machine at all times.
- DO NOT expose yourself or anyone else to the direct line of the blade when operating the equipment.

SAFETY PRECAUTIONS

- DO NOT allow any person, animal, and/or objects in and around the work area while cutting.
- DO NOT install a blade on the machine until it is in the cutting area.
- Ensure the work area is adequately illuminated to ensure safe operation of the machine.

Hydraulic Safety

- Turn off the engine prior to servicing hydraulic components.
- Lower the equipment completely prior to servicing to decrease the hydraulic pressure in the lines.
- Always make sure any hydraulic components being serviced are not supporting the weight of other equipment components. If a particular component is under pressure when connection points are loosened, oil may spray out forcefully.
- Always place a piece of cardboard or paper up against hydraulic components, or use a leak detection fluid to check for hydraulic fluid leaks. Keep all body parts away from leaks and/or areas that may eject hydraulic fluid. Pressurized hydraulic fluid can penetrate the skin, causing serious injuries. Seek medical attention immediately!



Belt Safety

- Turn off the engine and let the belts cool down prior to servicing them.
- Regularly inspect the belts for fraying, stress cracks, and/or breakage and replace immediately when damaged. Always check the belt alignment prior to operating the equipment.
- Use extreme caution when working with belts and rotating machine parts to avoid entanglement.
- Over-tensioning belts may reduce the life of the gearbox bearings. Under-tensioning belts may cause slippage, shorter belt life, and/or poor equipment performance.
- Squealing belts indicate looseness.
- DO NOT use old and new belts together on the same sheave.

Transporting Safety

- Remove the blade prior to transporting the equipment.
- Make sure the truck/trailer is in good, working condition and sufficient to transport the load. DO NOT tow the equipment behind a vehicle.
- Close the fuel shutoff valve (applicable models) when transporting.
- Drain the fuel tank when transporting long distances.
- Use heavy-duty ramps that will support the weight of the equipment and yourself when loading or unloading.
- Raise the equipment to avoid damaging components while moving up and down ramps.
- Use extreme caution when guiding the equipment up and down ramps. Slowly drive the equipment forward down the ramp. Slowly back the equipment in reverse up the ramp. Avoid standing directly downhill from the equipment to prevent machine rollover.
- Place the equipment in neutral and turn off the engine once the equipment is loaded in the truck/trailer.
- Chock the wheels and secure the saw in the truck/trailer prior to transporting.
- Refer to the Discount-equipment for additional transportation recommendations.



Lifting Safety

- Move yourself and others away from the lifting area when hoisting the saw to prevent being crushed.
- Secure the appropriate hoisting cables, straps, and/or chains to the saw's designated lift points prior to hoisting.
- Never use the tie-down brackets (applicable models) to lift the saw.
- DO NOT attempt to lift the saw irresponsibly and/or improperly.

Display Panel

The display panel is a rugged CAN-based controller. This section explains the functions of the unit, describes the display screens and gives details about the configuration.

Turning the ignition switch to run or start will activate the display panel. A sequence of screens will display on the control panel. First you will see a notation in the upper left corner, "Booting", followed by Diamond Products logo and then the gauge screen. If one or more of the emergency stop triggers are activated, the E-stop switch is active, coolant level is low, or back panel is open (on certain models) an emergency shutdown window will be displayed. Operator must clear these messages before engine can start.



Figure 1: Display Panel with Emergency Shutdown Window

The Gauge Screen (Home) displays three dial gauges and four digital gauges.

Dial Gauge







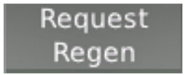

- Engine and Tachometer Speed/RPM
- Engine Coolant Temperature
- Electrical Potential Voltage

Digital Gauge

- Oil Pressure – Lamp Only
- Fuel Level – Lamp Only
- Engine Total Hours of Operation
- Service – Engine Hours Logged since Last Service Date









Soft Keys (Buttons)

The Soft Key choices are associated with the throttle source. These will appear on the bottom of the display screen and can be selected by pushing the button directly below the soft key.

Soft Key	Description
	DPF Commands – Displays the Diesel Particulate Filter (DPF) command to access the Un-inhibit Regen and Inhibit Regen
	Request Regen – Sends message to Engine Control Unit (ECU) to start regenerating the DPF when prompted by engine ECU
	Stop Regen – Sends message to ECU to stop regenerating the DPF (should not be used unless necessary)
	Freeze Frame – Requests the freeze frame data from the ECU when faults are present
	Main Menu – Two pages that list seven action items. Five are available to the operator: Gauges, Diagnostics, System Info, Lamp Info and User settings. (Panel Configuration and Service are reserved for technical support)
	Down – Navigates the cursor downward through a list
	Up – Navigates the cursor upward through a list
	Select – Enters the action item next to the cursor in a list. Also used with the Main Menu soft key to get back to the Main Menu from any screen
	Deselect – Closes pop-up messages
	Right – Toggles between the main menu and a larger engine/blade shaft RPM dial gauge

Status Icons

The Status Icons are color coded and light up when communicating to the operator. Pay close attention to any Status Icons and color if it appears.

Status Icon	Description
	Check Engine – Yellow icon is visible if the controller receives a DM1 (Active Diagnostic Trouble Code) message with an amber lamp command.
	Check Engine – Red icon is visible if the controller receives a DM1 message with a red lamp command.
	Parking Brake Switch – Green icon displays when the parking brake is applied.
	Transmission Disengaged – Green icon displays when the transmission is disengaged.
	Emergency Stop Button – Red icon displays when emergency stop button is engaged.
	Engine Exhaust High Temperature Lamp – Red icon displays during active DPF regeneration when the DPF outlet temperature is greater than 450°C and post engine fuel injection is occurring.
	Diesel Particulate Filter Lamp Command – Red icon is: (1) On solid during regeneration (2) Blinking to request parked regeneration. Yellow Icon is on solid to request automatic active regeneration when regeneration is inhibited.
	DPF Regeneration set to Inhibit – Displays when the machine or the operator has inhibited regeneration.

Glossary of Terms and Acronyms

- CAN – Controller Area Network
- DM1 – Diagnostic Message 1, Active Diagnostic Trouble Codes
- DM2 – Diagnostic Message 2, Previously Active Diagnostic Trouble Codes
- DM4 – Freeze Frame Parameters
- DPF – Diesel Particulate Filter
- DTC – Diagnostic Trouble Code
- ECU – Engine Control Unit
- FMI – Failure Mode Identifier
- PGN – Parameter Group Number
- SPN – Suspect Parameter Number

DISPLAY PANEL

Main Menu

The Main Menu is the default gauge screen (Home). There are three soft key options available from the Main Menu:

1. Arrow
2. DPF Commands
3. Main Menu Soft Key (☰).



Gauge Screen (Main Menu)

Arrow

Selecting the soft key under the Arrow will display the Engine and Tachometer RPM and the DPF Outlet Gas Temperature gauge screen.

The RPM gauge displays engine RPM with the red arrow (arrow #1) and the blade RPM with the red line pointer (arrow #2).



RPM Gauge Indicator Arrows

To return to Main Menu select the soft key below the Arrow or the soft key below Main Menu then using the up and down arrows place cursor on Gauges and select the soft key under (☰).

DPF Commands

Select the soft key under DPF Commands and the soft key options will display three soft key options:

- Return
- Main Menu
- Inhibit Regen (default) or Un-inhibit Regen.

Note: The saw will default to auto regen mode. Therefore, when starting the saw Inhibit Regen will display.)



DPF Command Display

1. Return – Select the soft key under Return to take you back to the Main Menu.
2. Main Menu – Select the soft key under the main menu icon, then using the up and down arrows place the cursor on Gauges and select the soft key under (☰) to take you back to the main gauge screen.
3. Inhibit Regen – Select to temporarily turn off the default auto regen and place the saw in Inhibit Regen status. The DPF will remain in Inhibit Regen status until the engine is shutdown. The next time the engine starts the DPF will default back auto.

DISPLAY PANEL

A yellow warning window will display letting you know you are temporarily inhibiting the DPF regeneration. Select the soft key X to close the window.

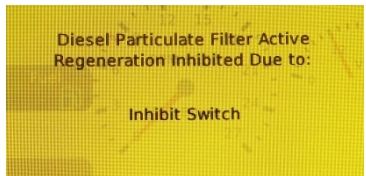

DPF Regeneration Inhibited

Main Menu Action Items

Press the Main Menu (☰) soft key to view the menu action list. Scroll through the Main Menu action list on two screens, using the Up/Down soft keys to maneuver the cursor to the action item you want, then press the soft key under the circle (○).

1. Gauges (Main Menu default screen)
2. Diagnostics
3. System Information
4. User Settings
5. Panel Configuration (Password Required)
6. Service (Password Required)

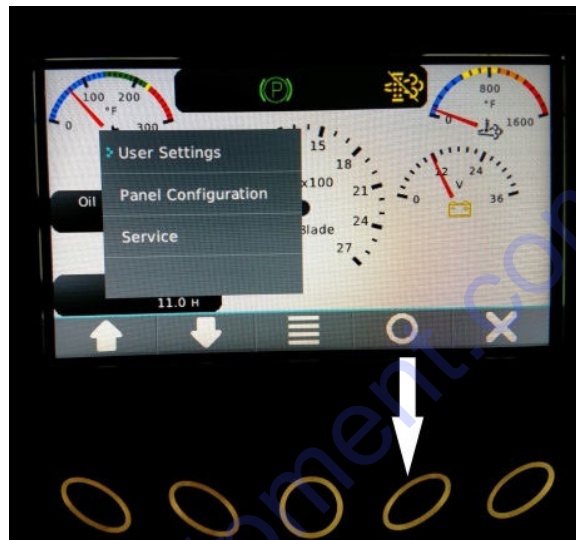

Main Menu Action Items – Screen 2

Gauges

Returns screen to Main Menu

Diagnostics

The screen displays the following items:

- Active Diagnostics
- Logged Diagnostics

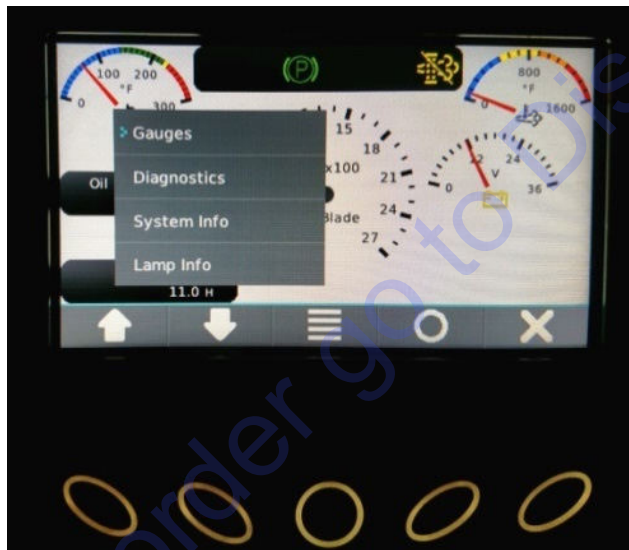

Main Menu Action Items – Screen 1



Active or Logged Diagnostics

Active Diagnostics

Use the UP/DOWN soft keys and stop the cursor next to the action item Active Diagnostics. Press to select (OK) soft key. The screen displays active warnings or faults from the ECU. Each diagnostic is shown with the appropriate Suspect Parameter Number (SPN) and Failure Mode Indicator (FMI), Text Description (if available) and the ID/Name of the device that transmitted the DM1 message.

Press the UP/DOWN soft keys to reach the next diagnostic in the list.



Active Diagnostics Screen

Logged Diagnostics

Use the UP/DOWN soft keys, and stop the cursor next to the action item Logged Diagnostics. Press to select (OK) soft key. The screen displays the controller requests DM2 (stored trouble codes, not active), warning or faults from the ECU. Each diagnostic is shown with the appropriate information:

- Suspect Parameter Number (SPN)
- Failure Mode Indicator (FMI)
- Text Description (if available)
- ID/Name of the device that transmitted the DM1 message

Note: Select the Freeze Frame Button to request the freeze frame data from the ECU when faults are present.



Logged Diagnostics

System Information

Scroll through the Menu list using the UP/DOWN soft keys, and stop the cursor next to the action item System Info. Press to select (OK) soft key. The screen displays the following items:

- Engine Model
- Engine Serial Number
- ECU Software ID
- Fuel Rate
- Time Since Last Active Regen
- File Name of Installed Software

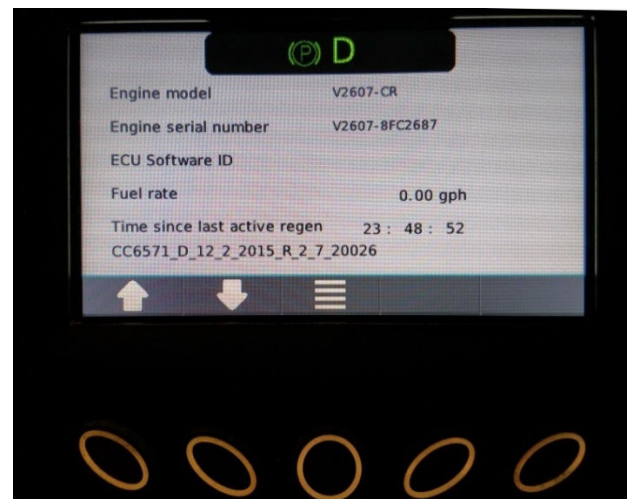

System Info Screen

Press the UP/DOWN soft keys to display a screen with application and configuration information.

User Settings

Scroll through the Menu list using the UP/DOWN soft keys, and stop the cursor next to the action item **User Settings** - Press to select (⊙) soft key. The screen displays the following action items:

- Colors
- Brightness
- Language
- Units

Screen Color

Using the UP/DOWN soft keys stop the cursor next to the action item, Colors. Set your preference for day or night vision by using the +/- soft keys. To exit the screen select the Main Menu (☰) soft key and then select the (⊙) soft key.



Night Setting Preference Screen

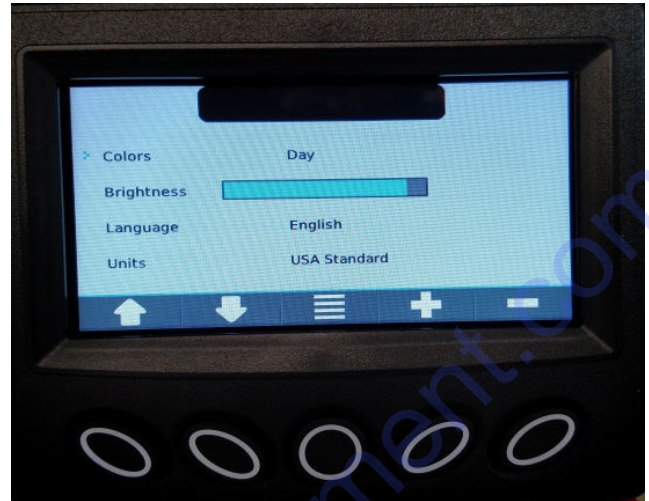

Day Setting Preference Screen

Screen Brightness

Using the UP/DOWN soft keys stop the cursor next to the action item **Brightness**. Set the brightness of the backlight by using the +/- soft keys. To exit the screen select the Main Menu (☰) soft key and then select (⊙) soft key.

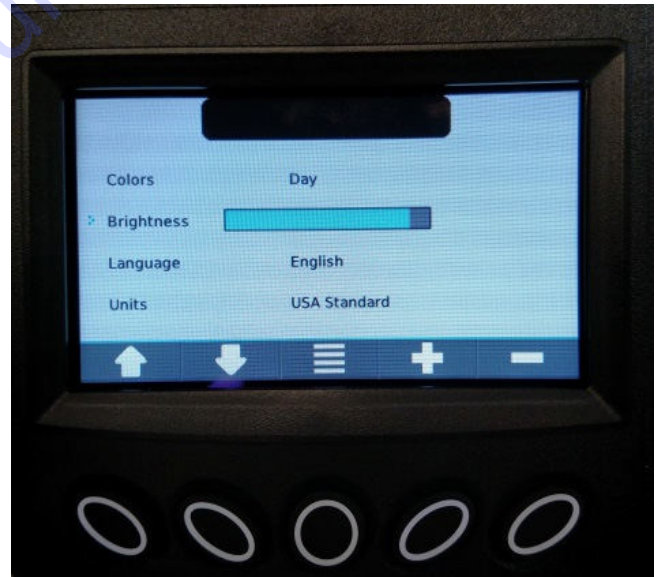

Screen Brightness

DISPLAY PANEL

Language

Using the UP/DOWN soft keys stop the cursor next to the action item, Language. Set your language preference using the +/- soft keys.

- English
- French
- German
- Spanish
- Italian
- Japanese

To exit this screen, select the Main Menu (☰) soft key and then select (⊙) soft key.

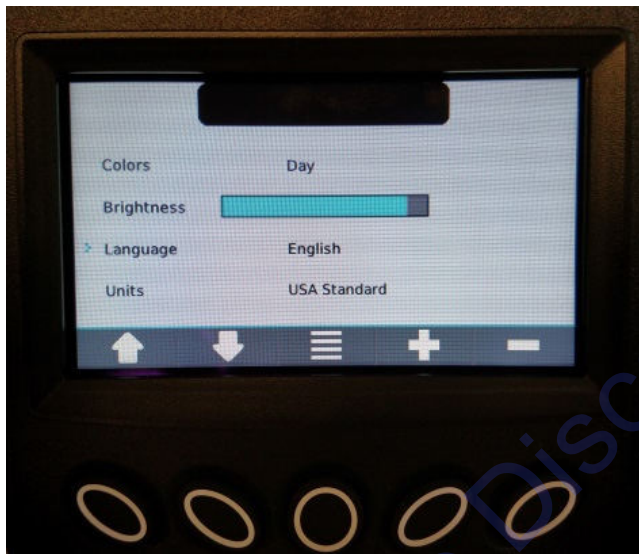

Set Language Preference Screen

Units

Using the UP/DOWN soft keys stop the cursor next to the action item, **Units**. Set your unit preference using the +/- soft keys. To exit the screen select the Main Menu (☰) soft key and then Select (⊙) soft key.

- USA Standard
- Metric kPa
- Metric Bar

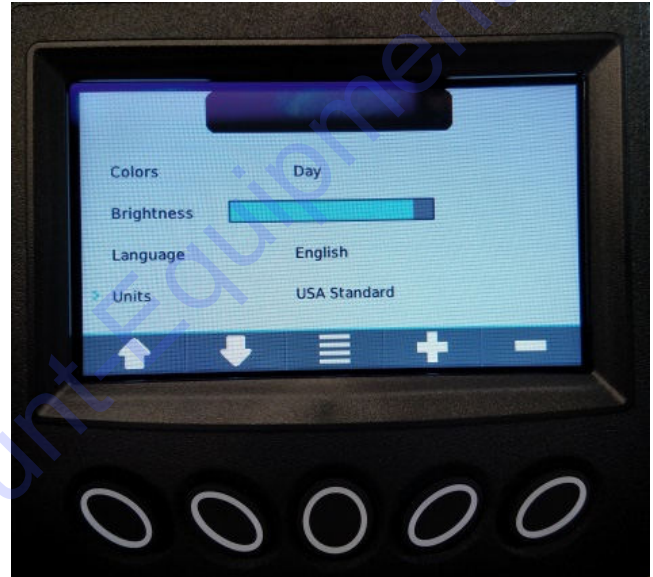

Set Unit Preferences Screen

Automatic Shutdown

There are two faults the engine communicates to the display screen to initiate a shutdown. The two faults from the ECU are displayed on the display screen as P0093 and P1274 to the operator. The engine is shut down for safety reasons. Contact a qualified service facility if this occurs.

Operating

For additional information and detailed diagrams on individual saw components, refer to the CC7574 Parts List in conjunction with this manual.

Tie-Downs

Use the tie-downs (one at the back and one at the front end of the saw) when securing the saw in a truck/trailer for transportation. DO NOT over-tighten a chain/rope to the front end tie-down, which may bend the frame and damage the saw.

Footrest

Use the footrest, if desired, to add body weight to the rear of the saw and improve the rear wheel traction when cutting.



Footrest

Weight Bar (Optional)

The weight bar (optional) adds 56 Lbs. to the saw to improve the rear wheel traction when cutting.

Note: The weight bar is a standard feature on the 48" blade saw.

1. Attach the second footrest to the back of the frame base using the screws, washers, and lock nuts provided.
2. Rest the weight bar on top of both footrests.
3. Place a flat washer onto both screws. Fit the screws through the screw holes on top of the weight bar and through the slot on both footrests.

4. Place a fender washer onto each screw underneath the footrest and secure with a lock nut.
5. Remove the weight bar as necessary.

Spotlight

1. Loosen both spotlight bar lock knobs and slide the spotlight bar from side-to-side to adjust the length of the bar.
2. Tighten the lock knobs to secure.
3. Turn the spotlight switch on or off as needed for additional lighting.

Handlebars

The handlebars help to guide and maneuver the saw. Place the handlebars in the desired position for better leverage when lifting and steering. To maneuver the saw forward or backward, turn on the *Free Wheel* switch and move the saw as desired (the free wheel component only works with the ignition key at *Run*).

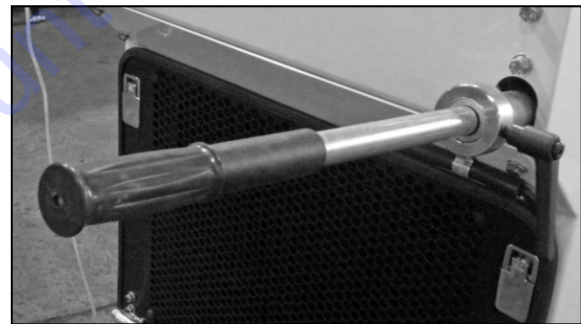

Handlebar

Adjusting the Handlebars

1. Loosen the handlebar adjusting lever.
2. Move the handlebar forward or backward to adjust the length and retighten the adjusting lever to secure.
3. Press the *Tilt Handlebar* pushbutton, located on the side of the control grip, and move the handlebar up or down to adjust the angle.

Note: The button only works with the ignition key at the Run position.

4. To reposition adjustment lever, pull out and move to desired lever position.

Control Grip Pushbuttons

The control grip pushbuttons only work with the ignition key at *Run* or with the engine running.

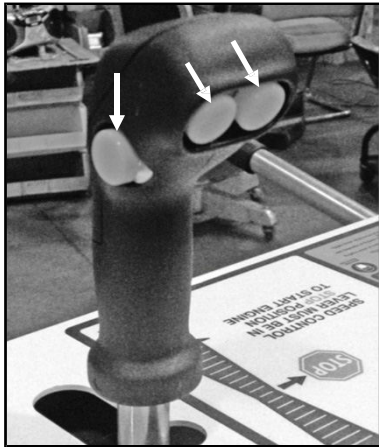

Control Grip Pushbuttons

1. Press the *Raise* (left) pushbutton to raise the saw and blade, and release to stop.

Note: Always raise the blade when maneuvering the saw to provide proper clearance between the blade and the ground.

2. Press the *Lower* (right) pushbutton to lower the saw and blade, and release to stop.
3. Press the *Tilt Handlebar* pushbutton, located on the side of the control grip, and move the handlebar up or down to adjust the angle.

Fuel System

! WARNING

- Always use caution when refueling
- DO NOT operate the saw with a fuel leak
- DO NOT fuel the saw with the engine running
- DO NOT smoke or expose fuel to open flames when filling the fuel tank or working with fuel



! CAUTION

- Clean up any spilled fuel prior to starting the engine.
- Fuel may seep out from the fuel cap vent (applicable models) when raising the saw if the fuel tank is overfilled.

Adding Fuel

1. Lower the saw to level the frame.
2. Turn off the engine and let the saw cool down.
3. Remove the fuel tank cap.
4. Fill the fuel tank with low sulfur or ultra-low sulfur diesel fuel. DO NOT overfill the tank for expansion purposes. Refer to the engine manual for information on appropriate diesel fuels in normal and cold weather temperatures,
5. Replace the fuel tank cap and secure.

Blade Guard

! WARNING

- DO NOT operate the saw with the blade guard raised or removed.
- DO NOT remove the blade guard with the engine running.
- Blade exposure should not exceed 180° while cutting.
- Always pivot the front of the blade guard 180° (fully upward) so the guard does not swing down unexpectedly, which may cause serious injuries.
- Always secure the pivoted section of the blade guard using the detent pin (guards 26" and up)
- When pivoting the front of the blade guard, raise/lower it cautiously and slowly to avoid serious injuries.



The blade guard shields the blade and must always be in place when operating the saw. Blade guards generally stay in place at all times, except for when changing to another guard size or when using the guard on the opposite side of the saw. Regularly inspect the blade guard and water tubes. Clean, repair, or replace dirty or damaged components immediately.

Note: Always use a guard size that matches the blade size. Refer to the parts list for additional information.

Installing the Blade Guard

Always install the blade guard with the blade off the saw.

1. Holding the blade guard handle, face the front of the blade guard forward and fit the tapered mount on the side of the guard onto the tapered mount on the frame.



Frame Base Mount

2. Insert the lock pin through the hole on the tapered frame mount to secure the guard.
3. For guards 36" and up, raise the saw slightly. Place a lock washer and then a flat washer onto the blade guard screw. Fit the screw through the slot near the back of the guard and through the hole on the frame base, and secure the guard to the frame using the provided wrench.
4. Connect the water supply hose to the blade guard.

Removing the Blade Guard

Always remove the blade guard with the blade off the saw.

1. Disconnect the water supply hose from the blade guard.
2. For guards 36" and up, raise the saw slightly. Remove the screw from the frame base and blade guard.
3. Remove the lock pin from the tapered frame mount.
4. Use the handle on the blade guard to rock the guard back and forth while lifting the guard off the tapered frame mount.

Flange Guard

Install the flange guard over the blade flange that is not in use.

Installing the Flange Guard

1. Fit the tapered mount on the back of the flange guard onto the tapered mount on the frame.
2. Insert the lock pin through the hole on the tapered frame mount to secure the guard.



Flange Guard Installed

Removing the Flange Guard

1. Remove the lock pin from the tapered frame mount.
2. Remove the flange guard from the tapered frame mount.

Diamond Blades



WARNING

- DO NOT exceed the blade's maximum recommended speed when cutting. Excessive blade speeds can cause blades breakage, resulting in serious injury or death.
- DO NOT use damaged blades when cutting to avoid harming yourself, others, or the saw.

Using the proper blade (size and type) preserves the blade and improves efficiency, resulting in lower costs. Refer to the Association of Equipment Manufacturers (AEM) safety brochure for diamond blades and www.discount-equipment.com for additional blade information.

Inspecting the Blade

Inspect each blade prior to installation and discard all damaged blades. Inspect the blades for:

- Cracks, nicks, and dents
- A damaged/deformed arbor (center hole)
- Darkness/discoloration near edge of blade
- A deformed blade circumference
- Segment loss/cracks
- Core wear
- Bending
- Uneven side-widths

Blade Speed

Refer to the CC7574 RPM Chart, the blade, or the blade packaging information for the recommended blade speeds when cutting. DO NOT exceed the maximum recommended blade speed. DO NOT use a blade for cutting that requires a lower speed than the minimum blade shaft speed.

Wrench

Use the wrench provided when installing or removing a blade. Apply force to the opposite end of the wrench and tighten the blade shaft bolt/screw to 125 ft-lb (170 Nm) minimum to secure the outer flange and blade.

Note: 125 ft-lb is equivalent to applying 125 pounds at the end of a 12" wrench.

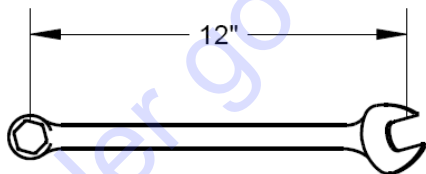

Wrench

Installing the Blade

CAUTION

- Wear gloves and be alert to the surrounding environment when handling blades.

WARNING

- DO NOT install a blade with the engine running.
- Failure to secure the outer flange and blade may cause parts to loosen or fall off the saw resulting in serious injury or death.
- DO NOT pivot the front blade guard up or down when installing very large blades. Attempting to pivot the front of a heavy guard when the guard is positioned higher up for blade installation makes the guard difficult to lift and/or lower. In this situation, remove the front blade guard instead of pivoting it.
- Always secure the pivoted section of the blade guard using the detent pin (guards 26" and up).

The blade can be installed on the right or left side of the saw. Install the blade on the side preferred or most appropriate for the cutting task.

1. Select a blade size and type. Remember to check the blade for damages and discard as necessary.

Note: If changing the blade size, adjust and/or change all necessary saw components according to the information in the CC7574 Parts List.

2. Remove the detent pin (guards 26" and up) from the guard hinge and pivot the front of the blade guard 180° (fully upward) to gain access to the blade flanges. For larger, heavier guards that are positioned too high up and are unsafe to pivot, remove the lock nut and screw from the center of the guard hinge. Remove the front of the guard.

Note: Have a second trained operator hold the guard in place while removing the hinge screw and nut.

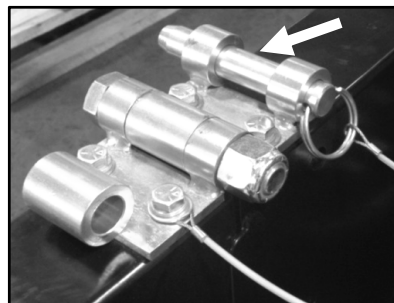

Detent Pin

TO PURCHASE THIS PRODUCT PLEASE CONTACT US



**Equipment Financing and
Extended Warranties Available**



**Discount-Equipment.com is your online resource for
commercial and industrial quality parts and equipment sales.**

561-964-4949

visit us on line @ www.discount-equipment.com

Select an option below to find your Equipment

Search by Manufacturer

Search by Product Type

Request a Quote

We sell worldwide for the brands: Genie, Terex, JLG, MultiQuip, Mikasa, Essick, Whiteman, Mayco, Toro Stone, Diamond Products, Generac Magnum, Airman, Haulotte, Barreto, Power Blanket, Nifty Lift, Atlas Copco, Chicago Pneumatic, Allmand, Miller Curber, Skyjack, Lull, Skytrak, Tsurumi, Husquvarna Target, Stow, Wacker, Sakai, Mi-T-M, Sullair, Basic, Dynapac, MBW, Weber, Bartell, Bennar Newman, Haulotte, Ditch Runner, Menegotti, Morrison, Contec, Buddy, Crown, Edco, Wyco, Bomag, Laymor, EZ Trench, Bil-Jax, F.S. Curtis, Gehl Pavers, Heli, Honda, ICS/PowerGrit, IHI, Partner, Imer, Clipper, MMD, Koshin, Rice, CH&E, General Equipment, Amida, Coleman, NAC, Gradall, Square Shooter, Kent, Stanley, Tamco, Toku, Hatz, Kohler, Robin, Wisconsin, Northrock, Oztec, Toker TK, Rol-Air, APT, Wylie, Ingersoll Rand / Doosan, Innovatech, Con X, Ammann, Mecalac, Makinex, Smith Surface Prep, Small Line, Wanco, Yanmar

3. On the pivoted guards, insert the detent pin through the interlocking barrels on the top of the guard to secure the front of the guard.

Note: Failure to fully pivot and secure the front of the guard may cause serious injuries.

4. Remove the blade shaft bolt. Note: clockwise loosens on right side, counterclockwise loosens on left side (when viewed from the operating position) using the provided wrench.
5. Carefully remove the outer flange. Inspect the flange assembly and clean or replace dirty/damaged components.
6. Place the blade against the inner flange. For large blades, carefully roll the blade up to the inner flange. Adjust the height of the saw to align the flange and blade arbor.

Note: Point the arrow printed on the blade in the direction of the blade shaft's rotation.

7. Align and fit the outer flange and flange pin through the blade and into the inner flange and blade shaft.

Note: The outer flange should fit snug with the blade, inner flange, and blade shaft.

8. Slightly rotate the outer flange and blade backward to eliminate backlash (looseness) between parts.
9. Place the lock washer and then the flat washer onto the blade shaft screw and insert the screw into the blade shaft through the center of the outer flange.
10. Tighten the screw by hand. Slowly lower the saw, if necessary, until the blade just touches the ground.
11. Tighten the screw again, using the wrench, to 125 ft-lb (170 Nm) minimum to secure the outer flange and blade.
12. Remove the detent pin (guards 26" and up) from the guard hinge and pivot the front of the guard down over the blade to secure.
13. Re-insert the detent pin.

Removing the Blade



WARNING

- DO NOT install a blade with the engine running.
- Failure to secure the outer flange and blade may cause parts to loosen or fall off the saw resulting in serious injury or death.
- DO NOT pivot the front blade guard up or down when installing very large blades. Attempting to pivot the front of a heavy guard when the guard is positioned higher up for blade installation makes the guard difficult to lift and/or lower. In this situation, remove the front blade guard instead of pivoting it.
- Always secure the pivoted section of the blade guard using the detent pin (guards 26" and up).

1. Remove the detent pin (guards 26" and up) from the guard hinge and pivot the front of the blade guard 180° (fully upward) to gain access to the blade. For larger, heavier guards that are positioned too high up and are unsafe to pivot, remove the lock nut and screw from the center of the guard hinge. Remove the front of the guard.

Note: Have a second trained operator hold the guard in place while removing the hinge screw and nut.

2. On the pivoted guards, insert the detent pin through the interlocking barrels on the top of the guard to secure the front of the guard.

Note: Failure to fully pivot and secure the front of the guard may cause serious injuries.

3. Slowly lower the saw, if necessary, until the blade just touches the ground.
4. Remove the blade shaft screw using the wrench.
5. Carefully remove the outer flange and blade. Place the blade in an appropriate storage location.

Note: If the outer flange is difficult to remove, tighten a setscrew into two of the holes on the outer flange to help separate the outer flange from the blade.

6. Inspect the flange assembly and clean or replace dirty/damaged components.

7. Carefully fit the outer flange back into the inner flange and/or blade shaft.
8. Place the lock washer and then the flat washer onto the blade shaft screw and insert the screw into the blade shaft through the center of the outer flange.
9. Retighten the blade shaft screw to secure the flanges.
10. Remove the detent pin (guards 26" and up) from the guard hinge and pivot the front of the guard down over the blade flanges to secure.
11. Re-insert the detent pin.

1. Insert the key into the ignition and turn it to *RUN*; leave the key in this position until the main menu appears on the display, then turn the key to Start and release when the engine starts.

Note: If the engine does not start within 10 seconds, turn off the key and try again approximately 30 seconds later. DO NOT allow the starter motor to run continuously for more than 20 seconds. Refer to the engine manual for troubleshooting recommendations after several failed attempts.

Engine

⚠ WARNING

- Operate the saw in a well ventilated areas. Concentrated engine exhaust can cause loss of consciousness and/or death
- DO NOT touch the engine/muffler with the engine running and always let them cool down prior to touching or servicing the saw.
- DO NOT leave the saw unattended while the engine is running.

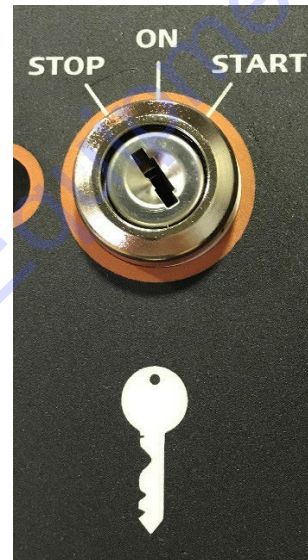

Ignition Switch

Tasks Prior to Starting the Engine

Complete the tasks listed below prior to starting the engine to ensure a safe start:

- Fill fuel tank, check engine oil and coolant levels.
- Turn off water valves.
- Turn off water safety switch.
- Turn off water pump switch.
- Place speed control lever at Neutral.
- Disengage transmission.
- Pull up on emergency stop button.
- Remove all tools from work area.

2. Let the engine warm up. Check all warning lights and turn off the engine immediately if there are any problems prior to operating the saw.

Throttle Operation

1. To increase engine/blade speed, press the throttle switch in the upwards direction.
2. To decrease the engine/blade speed, press the throttle switch in the downward direction.

Stopping the Engine

⚠ CAUTION

- DO NOT leave the saw unattended until the engine is off and the blade has stopped spinning.

Starting the Engine

Notice: In an emergency, press the emergency stop button to immediately stop the engine and any saw movement!

1. Place the speed control lever at *Stop* and raise the blade from the cut.
2. Turn off all controls, switches, and water.
3. Decrease the engine speed to idle for five minutes to cool down the engine after full load operation.
4. Turn the ignition key to *Stop* and remove the key.

Speed Control Lever

The speed control lever moves the saw forward and backward at up to 250 ft/min.

Note: The engine must be running at half throttle or greater to move the saw using the speed control lever.



Speed Control Lever

1. Slowly push the lever toward *Forward* to move the saw forward and release when at the desired traveling speed.
2. Slowly pull the lever toward *Reverse* to move the saw backward and release when at the desired traveling speed.
3. Place the lever at *Stop* to put the saw in neutral. DO NOT assume at any time that the neutral position will act as a brake when saw is running.

Note: Always start the engine with the speed control lever at Stop.

Blade Lowering Speed

Turn the blade lowering speed valve counter-clockwise to increase the blade's lowering speed and clockwise to decrease the blade's lowering speed.

Note: The valve does not adjust the blade's raising speed.

The valve is located on the frame lift assembly directly in front of the operator on the CC7574DK and on the right hand side of the frame lift assembly on the CC7574DD.

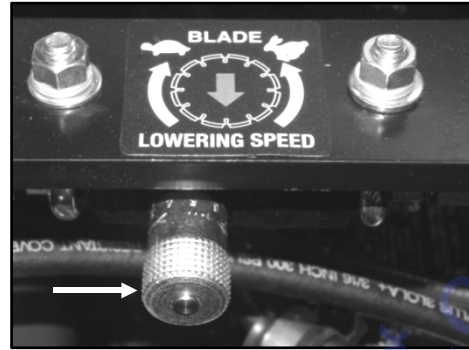

Blade Lowering Speed Valve (CC7574DK)



Blade Lowering Speed Valve (CC7574DD)

Water Supply

The water supply cools the gearbox, blade and minimizes dust when cutting.

Note: Always test the water supply for adequate pressure and flow prior to cutting.

Using the Water Supply

1. Ensure the water valves on the right and left side of the saw are shut.
2. Connect the water source hose to the water valve fitting on the left side of the saw.
3. Check the following supply hose connections to ensure they are tight:
 - Supply hose from the right side water valve to the inlet of the fuel cooler assembly.
 - Supply hose from the discharge of the fuel cooler assembly to the inlet of the water solenoid valve.
 - Supply hose from the discharge of the water solenoid valve to the inlet of the gearbox.
 - Supply hose from the discharge of the gearbox.

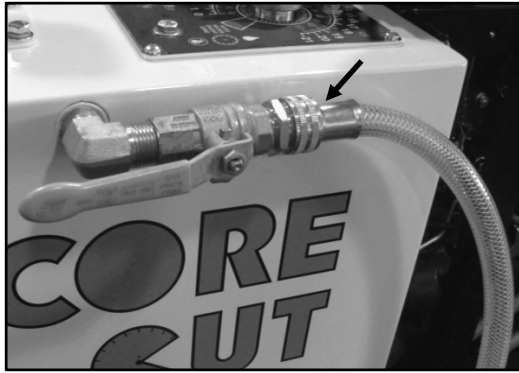

Water Source Hose

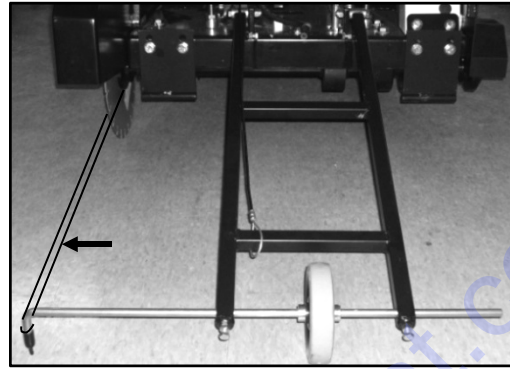

Tensioned String Line

4. Connect water supply hose from the discharge of the gearbox to the water manifold on the blade guard.
5. Move the water valve lever on right side of saw to full open. Increase or decrease water flow by moving the valve lever on the left side of the saw connected to the source hose.

Note: water on/off operation and flow adjustment can be made from either side of saw, if desired.

6. When finished cutting, shut off water supply to the blade guard, shut off water supply at source and remove source hose from the saw.
7. Drain water from upper gearbox heat sink. (ref. maintenance instructions: upper gearbox)

Cutting Guides

Use the cutting guides as needed to help follow the cutting line. Always check the cutting guides for proper alignment with the blade prior to cutting.

Adjusting the Front Pointer

1. Remove the lanyard from the cable cleat.
2. Lower the front pointer frame to the ground.
3. Loosen both front pointer frame screws.
4. Divide an 8–10 ft piece of string in half.
5. Place the looped end of string into a gullet on the backside of the blade.
6. Place one string line up against the backside of the blade and one string line up against the front side of the blade. Holding the string ends in one hand, tension the lines out toward the front pointer rod.

7. Adjust the pointer rod to place the tip between the tensioned string lines.
8. Retighten both front pointer frame screws.
9. Lift the frame off the ground when finished.
10. Tension the lanyard and secure it to the cable cleat.

Adjusting the Rear Pointer(s)

1. Loosen the rear pointer nut and screw on the back of the frame base.
2. Adjust the orientation of the rear pointer rod and retighten the screw and nut to secure.

Concrete Cutting

WARNING

- DO NOT expose yourself or anyone else to the direct line of the blade while operating the saw.
- The direct work area should not contain buried or embedded electrical, gas, or water lines that could be damaged and/or cause personal injury or death.

Note: Always raise the blade to provide proper clearance between the blade and the ground when maneuvering the saw.

Helpful Hints Prior to Cutting

Keep the following in mind for better efficiency while cutting:

- Use just enough handle pressure to guide the saw down the cutting line. DO NOT forcibly direct (twist) the saw from side to side when cutting. DO NOT jam, cock, or wedge the blade in a cut.
- Moving too quickly when cutting may stall the saw, or may cause the blade to climb out from the cut. If the saw stalls while cutting, put the saw in neutral and raise the blade from the cut to restart the engine.

OPERATING

- Avoid sawing excessively deep to preserve the blade and reduce sawing costs.
- DO NOT lower the blade too quickly or move the saw forward too quickly when finishing a partial-cut to avoid forcing the blade into the concrete.
- Always have a proper water flow when cutting for maximum blade efficiency. Using too much water when cutting will make the slurry look clear. Not using enough water will make the slurry look thick and pasty.
- Refer to the Diamond Products' Guide for Professional Concrete Cutters for additional cutting tips and information.

Tasks Prior to Cutting

Complete the following tasks prior to cutting:

- Align the cutting guide(s) with the blade.
- Clearly mark the cutting line.
- Turn off all electricity, gas, and water around the direct work area.

Making a Cut

1. Align the blade and cutting guide(s) with the cut line.
2. If the saw is equipped with a clutch (optional), turn on the *Blade Clutch* switch with engine at idle to start the blade rotation.
3. Turn on the water and adjust the water flow.
4. Lower the blade to just above the cutting surface and set the cutting depth indicator at zero.



Cutting Depth Indicator

5. Turn on the *Auto Water* switch if desired for automatic water on/off when cutting.

Note: When the cutting depth indicator enters the Auto Water On/Off Zone the water will turn on/off automatically and will not require the water flow to be reset every time the blade is lowered back into the cut. If the auto water feature is functioning in reverse (water goes off when blade is lowered into cut), rotate depth indicator 360 degrees to reset.

6. Slowly lower the blade into the surface at the start of the cut line for the initial cut. Make the initial pass across the entire cutting line using the most effective travel speed. If the blade is coming up out of the cut, decrease travel speed and/or feed depth. **DO NOT CUT FULL DEPTH IN ONE PASS.** Always use the step-cut method when cutting for maximum efficiency. For example, when cutting to a depth of ten inches, begin with a two-inch deep maximum initial pass, then a four-inch deep pass, and finish with another four-inch deep pass to complete the cut.
7. Raise the blade out of the cut and reposition the saw at the start of the cut line. DO NOT move backwards with the blade in a previous cut.
8. At the start of the cut line, lower the blade back into the cut and make a second, deeper pass across the entire cutting line.
9. Continue the step-cut process to reach the maximum depth. DO NOT cut any deeper than required.

Making a Cut Using the Blade Depth Stop

1. Align the blade and cutting guide(s) with the cut line.
2. If the saw is equipped with a clutch (optional), turn on the *Blade Clutch* switch with the engine at idle to start the blade rotation.
3. Turn on the water and adjust the water flow.
4. Lower the blade to just above the cutting surface and set the cutting depth indicator at zero.
5. Turn on the *Auto Water* switch if desired for automatic water on/off when cutting.
6. Slowly lower the blade into the surface to the desired cut depth.

Note: Initial cut should be less than 2 inches.

7. Push the *Blade Depth Stop* button to the "Set Blade Depth" position. The *Blade Depth Set* light will turn on, which means the cutting depth is set.
8. Raise the blade out of the cut and reposition the saw at the start of the cut. DO NOT move backwards with the blade in a previous cut.
9. Push the *Blade Depth Stop* button to the "Override Blade Depth" position and hold it down for approximately three seconds, noting when the *Blade Depth Set* light goes out. Set the cutting depth at a different depth measurement following guidelines in steps 6 & 7.
10. Continue the step-cut process using the depth stop to reach the maximum depth. DO NOT cut any deeper than required.

Continuing a Partial Cut

1. Maneuver the saw to the desired location.
2. Align the blade with the previous cut and slowly lower the blade back into the concrete. Use extreme caution to make sure the blade is perfectly aligned within the cut. DO NOT continue cutting until the blade is aligned within the cut!
3. Continue the step-cut process (using the blade depth stop if preferred) to reach the maximum depth. DO NOT cut any deeper than required.

Finishing a Cut

1. Place the speed control lever at *Stop*.
2. Raise the blade from the cut (provide proper ground clearance).
3. If the saw is equipped with a clutch (optional), turn off the *Blade Clutch* switch with engine at idle to stop the blade rotation.
4. Turn off the *Auto Water* switch and water supply.

Hood Operation

1. Pull up and out on rubber latch located on lower front of hood.
2. Grasp bottom of hood firmly and lift upwards.



Hood

Shifting the Three Speed Transmission



- DO NOT attempt to shift the transmission while the engine is running.

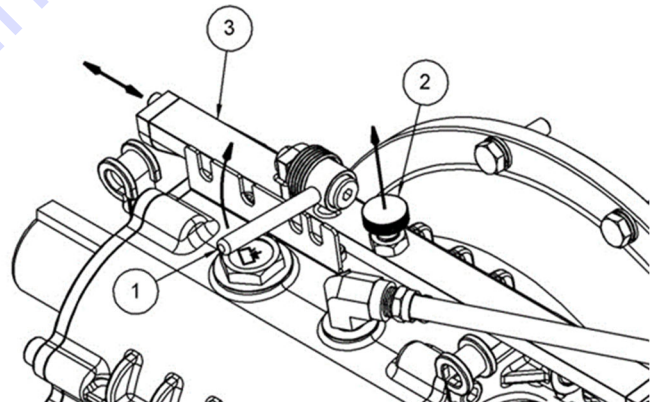

1. Stop engine.
2. Lift hood.
3. Lift and hold shift lever (1) and detent plunger (2).
4. Slide shift bar (3) until shift lever is over desired slot in shift gate (from left to right Medium, Low, Neutral, and High, marked M, L, N, and H).

Note: You will need to rotate the output shaft BY HAND to complete this motion.

5. Drop shift lever into desired shift gate slot.
6. Make certain that the detent plunger is completely engaged.

Maintenance

Failure to read and comply with the maintenance instructions provided in this manual prior to performing maintenance may result in serious injuries and/or death, and may harm the saw. DO NOT attempt to perform maintenance on the saw if you are not properly trained for it, or are not supervised by an experienced person.

Refer to the CC7574 Parts List for additional information and part diagrams when performing maintenance tasks. Refer to the engine manual and manufacturer as the primary source for all safety, operations, and maintenance instructions for the engine. Contact Discount-equipment with any additional questions.

Remove all necessary guards and access panels prior to servicing the saw. Replace prior to operating.

General

Complete the following tasks as required. DO NOT delay maintenance! Print the Daily Maintenance Task Chart from Appendix A to help keep track of maintenance tasks completed daily.

Daily

- Inspect the saw for damages and repair.
- Tighten loose nuts, screws, and bolts.
- Check all fluid levels (fuel, engine oil, hydraulic fluid, radiator fluid, upper and lower gearbox oil) and fill as necessary.
- Wipe down and clean all saw components to remove dust, debris, and slurry (especially from fans).
- Inspect all belts for tension and wear. Replace or tension as necessary.
- Clean the air cleaner (see engine manual).
- Check and clean the water filter strainer at water valve fitting.
- Clean the radiator and wipe down the cooling fan.
- Drain the upper gearbox heat sink.
- Drain water from water separator.
- Look for fluid leaks and check all hoses. Repair all damaged components.

After First 50 Hours

- Replace hydraulic oil filter.

Note: This is completed only after the first 50 hours of service, then it is completed every 250 hours as scheduled.

Every 100 Hours

- Lubricate the front axle bearing grease fittings (2).
- Lubricate the hydraulic lift cylinder grease fitting (1).
- Clean the upper and lower gearbox breather vents.
- Change the upper and lower gearbox oil.
- Clean the in-line oil suction filter.

Every 250 Hours

- Change the hydraulic oil filter (replace once after first 50 hours, then as scheduled).
- Change the in-line fuel filter.

Every 500 Hours

- Change the radiator fluid.

Note: Refer to the engine manual and manufacturer for a full list of routine engine maintenance tasks.

Part Lubrication



WARNING

- DO NOT grease parts with the engine running.

Lubricate all necessary parts on schedule for maximum saw efficiency. Occasionally lubricate controls, cables, and linkages with a spray lubricant when movement becomes stiff and/or sluggish. Use one to two full pumps of NLGI No. 2 premium, lithium-based grease when lubricating all grease fittings.

Note: Use more grease on bearing grease fittings if they are too hot to touch after completing work.

Fuel/Water Separator

Inspect the fuel/water separator daily and drain as necessary. The unit is located on the left side of the saw near the alternator on the CC7574DK and on the left side attached to the inside of the fuel door on the CC7574DD.

1. Locate the drainage cap on the underside of the fuel/water separator.
2. Loosen the cap only enough to allow water to be discharged from drainage tube. **Do not remove the cap.**
3. When no more water is discharged, re-tighten the drainage cap.



Fuel/Water Separator (CC7574DK)



Fuel/Water Separator (CC7574DD)

Speed Control Lever

Adjusting the Lever Tension

Adjust the tension felt in the speed control lever, when moving the lever forward and backward, to the desired setting as necessary.

1. Remove the (4) M10-1.5 hex head bolts from the rear access panel.
2. Remove the access panel.



Access Panel and Allen Wrench

3. Remove the grease cap from the pivot housing.
4. Loosen the jam nut on the opposite side of the speed control frame using provided 15/16" wrench.

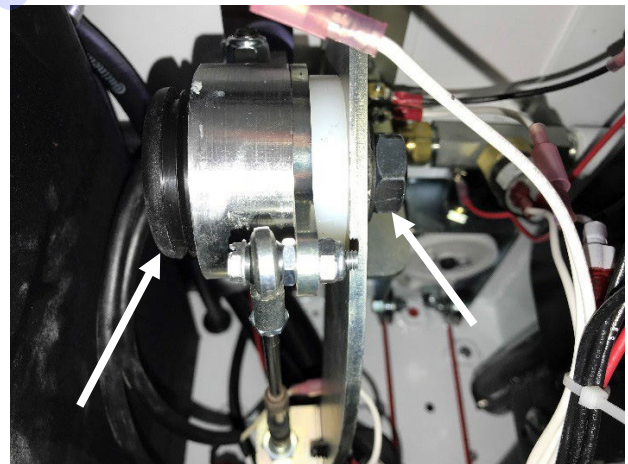

Grease Cap and Jam Nut

5. Use the Allen wrench, located on the access panel, to adjust the shoulder screw.
6. Retighten the jam nut.
7. Move the speed control lever forward and backward to test the lever tension. Readjust the shoulder screw/jam nut if desired.
8. Secure the grease cap to the pivot housing.
9. Replace access panel and retighten

Adjusting the Spring Plungers

Adjust the spring plungers if the speed control lever feels floppy or loose when moving the lever forward and backward, or when the lever is hard to place into or out of the *Stop* position.

1. Loosen both hex nuts from the speed control tube.
2. Screw the spring plungers slightly out to let the speed control lever move easily into and out of the *Stop* position. Screw the spring plungers slightly in to let the speed control lever move forward and backward firmly in the forward/reverse slot.
3. Retighten both hex nuts to secure.

Inner Blade Flange

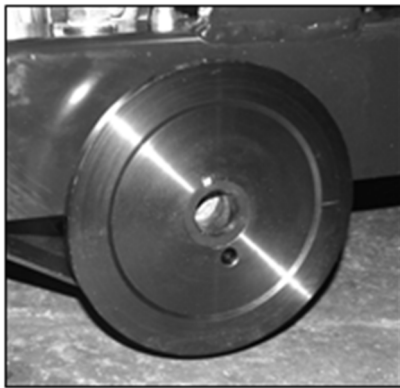

Inner Flange

Installing the Inner Blade Flange

1. Inspect the inner flange for damages. Clean or replace damaged components as necessary.
2. Align the flange with the blade shaft key and place the flange onto the blade shaft.
3. Apply Loctite 262 (red) or an equivalent to the setscrew threads.
4. Tighten the setscrew(s) into the back of the inner flange to secure.

Removing the Inner Blade Flange

1. Remove the setscrew(s) from the back of the inner flange using an Allen wrench.
2. Carefully remove the flange from the blade shaft.

Drive Alignment

Adjusting the Drive Alignment

Adjust the rear axle when the saw's drive alignment is off (saw will not cut in a straight line).

Note: The rear axle does not have to be adjusted for straightness; it can also be adjusted based on the specifications of the cutting job.

1. Turn the tap bolt clockwise using the provided wrench to adjust the drive alignment toward the right, or counterclockwise to adjust the drive alignment toward the left



Adjustment Bolt

Wheels

⚠️ WARNING

- Raise the saw to a proper height for access when working underneath the saw. Use chocks to block the wheels, and fit blocks or jacks under the frame edges at the front and back of the frame.



Front Wheels

Replacing the Front Wheels

Replace the front wheels when they are damaged and/or affecting saw performance.

1. Move the saw to level ground. Use a jack to lift the front wheels off the ground.
2. Remove all four screws from the wheel cover.
3. Pry the wheel cover gasket and wheel cover off the wheel using a screwdriver or pry bar.
4. Remove the screw securing the wheel, and then remove the wheel from the front axle.
5. Place a new wheel onto the front axle.
6. Fit the lock washer and then the flat washer onto the wheel screw and retighten the screw through the center of the wheel to secure.
7. Replace the wheel cover gasket and wheel cover, and retighten all four wheel cover screws to secure.
8. Replace the second front wheel as directed above.
9. Slowly lower the jack and remove the jack stand when the wheels are firmly touching the ground.

Replacing the Rear Wheels

Replace the rear wheels when they are damaged and/or affecting saw performance.

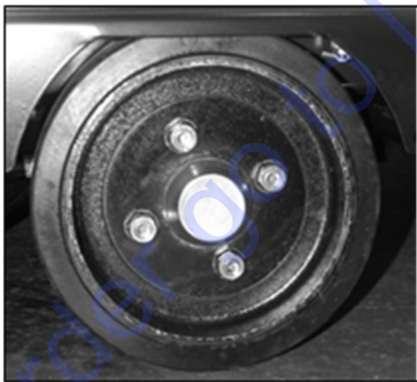

Rear Wheel

1. Move the saw to level ground. Use a jack to lift the rear wheels off the ground.
2. Pry the hubcap off the wheel using a screwdriver or pry bar.
3. Remove all four lug nuts from the wheel.
4. Remove the wheel and place a new wheel onto the wheel hub.

5. Replace the lug nuts and tighten to secure.
6. Replace the hubcap and secure in place using a rubber mallet.
7. Replace the second rear wheel as directed. Slowly lower the jack and remove the jack stand when the wheels are firmly touching the ground.

Maximum Cutting Depth

! WARNING

- Raise the saw to a proper height for access when working underneath the saw. Use chocks to block the wheels, and fit blocks or jacks under the frame edges at the front and back of the frame.

Always adjust the maximum cutting depth when changing the blade size, sheave size, flange size, and belt size to avoid damaging saw components. Refer to the CC7574 Parts List for additional information.

1. Raise the saw to gain access to the maximum cutting depth bolts underneath the frame base.
2. Loosen the nut on both bolts.
3. Turn the bolts counterclockwise to decrease the maximum cutting depth, or turn the bolts clockwise to increase the maximum cutting depth.

Note: Both bolts must be the same length when finished.



Maximum Depth Bolts

4. Bottom out the nut on each bolt with the frame base to secure the bolts.

- Remove all tools from the area and lower the saw completely. The blade flanges must be at least 1/4" from the ground to prevent component damage.

Note: Make sure both skid plates on the front of the saw are in the correct set of holes in order to lower the saw completely (refer to CC7574 Parts List).

- Readjust the depth bolts as necessary.

Handlebar Cylinder Rod

The handlebar cylinder rod must be serviced by Diamond Products if the handlebars can be moved up or down in excess amounts when locked in place (movement may feel sluggish). Send the entire assembly to Diamond Products to be recharged or pressurized.

Removing the Cylinder Rod

- Disconnect the two wires from the solenoid block valve.
- Remove the hairpin cotter and clevis pin from the cylinder rod end.



Clevis Pin

- Holding the cylinder, remove the hairpin cotter and clevis pin from the isolator mount tube.
- Remove the entire assembly from the saw.

Connecting the Cylinder Rod

- Fit the cylinder into the cylinder rod end mount and isolator mount tube.
- Fit the clevis pin through the cylinder rod end mount and cylinder rod end. Secure in place with the hairpin cotter.
- Fit the second clevis pin through the isolator mount tube and cylinder u-block. Secure in place with the hairpin cotter.

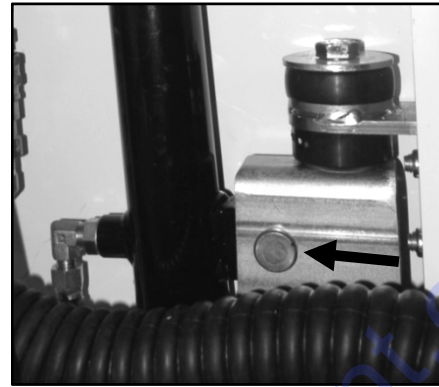

Clevis Pin

- Connect the two wires to the solenoid block valve according to the wiring diagrams in the CC7574 Parts List.

Battery

⚠️ WARNING

- Ignitable explosive gases are emitted from the battery. DO NOT expose the battery to sparks or open flames, and keep the area around the battery well ventilated.
- Disconnect the battery prior to servicing the saw unless stated otherwise.
- Always keep the battery cable clamps away from the battery terminals when the battery is disconnected to avoid accidental connections while servicing.
- Always be sure to connect the battery cables to the proper terminal when reconnecting.

⚠️ CAUTION

- Use a proper battery tester when testing the battery strength.
- Use protective eyewear or a face shield and avoid contact with the skin when handling/servicing the battery.

The saw contains a charged battery with one positive cable lead and one negative cable lead.

MAINTENANCE



Battery – CC7574DK



Battery – CC7574DD

Battery Type

12 Volt, Group 31 (CC7574DK)

12 Volt, Group 24 (CC7574DD)

Servicing the Battery

1. Unsecure the battery from the hold-down bracket as follows:
 - CC7574DK – Remove the two ratchet knobs from the battery hold-down tie rods and lift the hold-down bracket lid off.
 - CC7574DD – Unbuckle the battery hold-down strap.
2. Disconnect the negative cable lead from the negative terminal.

Note: Always disconnect the negative cable first.

3. Disconnect the positive cable lead from the positive terminal.
4. Carefully remove the battery from the battery box.

5. When replacing the battery, carefully place a new battery into the battery box. Bring the old battery to a recycling facility; many battery retailers also accept old batteries.
6. When cleaning the battery, inspect the terminals, clamps, and cables for damages and corrosion. Clean the terminals and clamps using a wire brush, or use another approved technique for cleaning. Use acid-free, acid-resistant grease to grease the battery clamps and terminals. Carefully place the battery back into the battery box.
7. Reconnect the positive cable lead to the positive battery terminal. **Note:** Always reconnect the positive cable first.
8. Reconnect the negative cable lead to the negative battery terminal.
9. Re-secure the battery to the hold-down bracket as follows:
 - CC7574DK – Re-insert the hold-down battery lid over the two tie rod bolts and tighten it using the two ratchet knobs.
 - CC7574DD – Re-attach the hold-down strap to the buckle and tighten securely.

Electrical System

WARNING

- Disconnect the battery prior to servicing the saw unless stated otherwise.
- Always use the correct size fuses (amps) to prevent fires.

Inspect all fuses if switches or controls are not working properly and replace as necessary. If fuses are failing frequently, determine the cause and repair immediately. Refer to the CC7574 Parts List for electrical diagrams.

Radiator

- Open radiator door, hose down the radiator and wipe down the radiator fan daily

CAUTION

- **DO NOT** use a high pressure spray to clean the radiator as this will damage the radiator fins and reduce the cooling capacity.

- Turn off the saw and inspect the cooling system when the coolant temperature light turns on, or when the coolant temperature gauge passes the red mark.

Adding Radiator Fluid – CC7574DK

1. Remove the coolant recovery tank cap.
2. Add a 50/50 mix of water and anti-freeze, as called out in the CC7574DK Parts List, to the tank.

Note: Refer to the Cold Full and Hot Full marks when filling and operating.



Coolant Recovery Tank – CC7574DK

3. Replace the coolant recovery tank cap and tighten to secure.

Adding Radiator Fluid – CC7574DD

The coolant system on the CC7574DD is a pressurized system. Care must be taken when servicing the system.

1. Remove the coolant expansion tank cap.
2. Add Deutz approved anti-freeze, as called out in the CC7574DD Parts List, to the expansion tank. Fill only to the bottom of the fill tube, approximately 50% of tank capacity, to ensure enough air volume is present for coolant expansion.
3. Replace the coolant expansion tank cap and tighten to secure.



Coolant Expansion Tank – CC7574DD

Changing the Radiator Fluid – CC7574DK

Change the radiator fluid every 500 hours of operation, or every two years (whichever comes first). DO NOT drain the radiator fluid when hot.

1. Open the radiator door.
2. Place a drain pan under the radiator drain valve.



Drain Valve Wing Nut

3. Slowly remove the radiator cap.

Note: Remove the radiator cap only when it feels cool to the touch, and always open it slowly to relieve any built up pressure.

4. Loosen the drain valve wing nut (below radiator door) and drain the fluid completely. Dispose of the used fluid according to city, state, and federal regulations.
5. Tighten the drain valve wing nut to secure.
6. Open the air bleed valve wing nut (inside radiator door, near top of door).



Air Bleed Valve Wing Nut

7. Add a 50/50 mix of water and anti-freeze, as called out in the CC7574DK Parts List, through the radiator fill port until it begins to leak out of the air bleed valve.

8. Close the air bleed valve wing nut.
9. Add more radiator fluid through the fill port until the fluid reaches the overflow hole inside the filler neck.
10. Replace the radiator cap and retighten to secure.

Changing the Radiator Fluid – CC7574DD

Change the radiator fluid every 500 hours of operation, or every two years (whichever comes first). DO NOT drain the radiator fluid when hot.

1. Open the radiator door.
2. Place a drain pan under the radiator drain valve.
3. Slowly remove the coolant expansion tank cap.

Note: Remove the expansion tank cap only when it feels cool to the touch, and always open it slowly to relieve any built up pressure.

4. Loosen the drain valve wing nut (below radiator door) and drain the fluid completely. Dispose of the used fluid according to city, state, and federal regulations.
5. Tighten the drain valve wing nut to secure.
6. Add Deutz approved anti-freeze, as called out in the CC7574DD Parts List, to the expansion tank. Fill only to the bottom of the fill tube, approximately 50% of tank capacity, to ensure enough air volume is present for coolant expansion.
7. Replace the coolant expansion tank cap and retighten to secure.

Bleeding Air from the Coolant System – CC7574DK

After initially filling the coolant system with fluid, air pocket(s) may form causing a low coolant level condition that will prevent the engine from starting. If this happens, complete the following procedure:

1. Ensure the engine is cool.
2. Slowly remove the radiator cap.

Note: Remove the radiator cap only when it feels cool to the touch, and always open it slowly to relieve any built up pressure.

3. Open the air bleed valve wing nut (inside radiator door, near top of door).
4. Add a 50/50 mix of water and anti-freeze, as called out in the CC7574DK Parts List,

through the radiator fill port until it begins to leak out of the air bleed valve.

5. Close the air bleed valve wing nut.
6. Add additional radiator fluid through the fill port until the fluid reaches the overflow hole inside the filler neck.
7. Replace the radiator cap and retighten to secure.

Hydraulic System

WARNING

- Always place a piece of cardboard or paper up against hydraulic components, or use a leak detection fluid to check for hydraulic fluid leaks. Keep all body parts away from leaks and/or areas that may eject hydraulic fluid. Pressurized hydraulic fluid can penetrate the skin causing serious injuries. Seek medical attention immediately!
- Always make sure any hydraulic components being serviced are not supporting the weight of other saw components. If a particular component is under pressure when connection points are loosened, oil may spray out forcefully.

Inspect all hydraulic hoses and fittings daily for leaks. Remember to use cardboard or a piece of paper when checking for leaks and replace damaged components immediately.

Adding Fluid to the Hydraulic Lift Pump

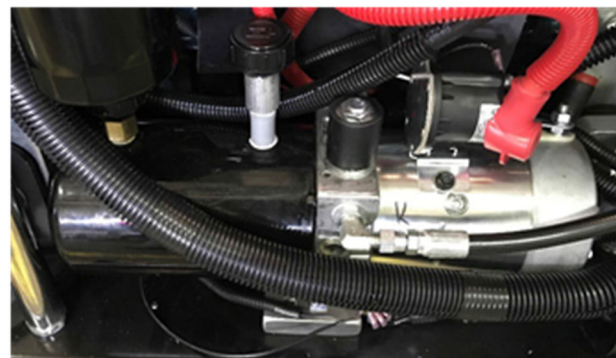

Hydraulic Lift Pump

Check the fluid daily and add fluid to the pump as necessary.

1. Lower the saw to level the frame.
2. Remove pump cover.
3. Remove the shorter hydraulic pump breather cap.

4. Add SAE15W-40 oil or an equivalent to just below where the fill port extends into the hydraulic pump. Do not overfill, as this will cause oil leakage through the breather cap when raising the saw.
5. Replace the breather cap and retighten to secure.

Adding Hydraulic Fluid to the Hydro Pump Reservoir Tank

Check the hydraulic fluid daily and add fluid to the reservoir tank as necessary.

1. Lower the saw to level the engine.
2. Remove the reservoir tank cap.
3. Add SAE 15W-40 oil or equivalent to the reservoir tank fill line. DO NOT overfill as fluid will leak out from the reservoir cap.
4. Replace the cap and tighten to secure.



Hydro Pump Reservoir Tank

Replacing the Hydraulic Oil Filter

Replace the hydraulic oil filter after the first 50 hours of operation, and then every 250 hours.

1. Lower the saw completely.
2. Place a drain pan under the filter.
3. Remove the filter using an appropriate tool. Dispose of the used oil and filter according to city, state, and federal regulations.
4. Wipe down the sealing surface with a clean cloth, and use clean oil to lightly oil the filter gasket.
5. Fill new filter with SAE15W-40 oil. Remove bracket to allow attachment of filter in vertical position.
6. Tighten the new filter to the filter head following the directions on the filter.
7. Inspect the seal for leaks and recheck the oil level in the reservoir.

Upper Gearbox

Clean the upper gearbox breather vent (inside breather cap) using compressed air to remove oil, dirt, and slurry every 100 hours.

Changing the Upper Gearbox Oil

Change the upper gearbox oil every 100 hours.

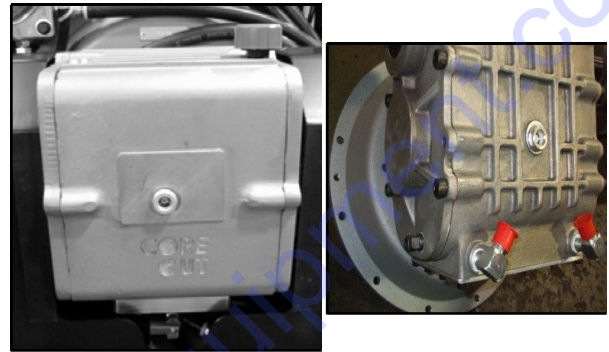

Upper Gearbox & 3-Speed Gearbox

1. Lower the saw to level the frame.
2. Place a drain pan under the gearbox drain plug (underneath gearbox, near front of box for single speed & on the right hand side cover for the 3-speed).
3. Remove the gearbox drain plug and drain the oil completely. Dispose of the used oil according to city, state, and federal regulations.
4. Replace the drain plug and retighten to secure.
5. Remove the oil fill breather cap and add Mobil 1 Synthetic Gear Lube 75W-90 oil to the upper gearbox to at least half full (view level through sight glass).
6. Replace the oil fill breather cap and retighten to secure.

Draining the Upper Gearbox Heat Sink

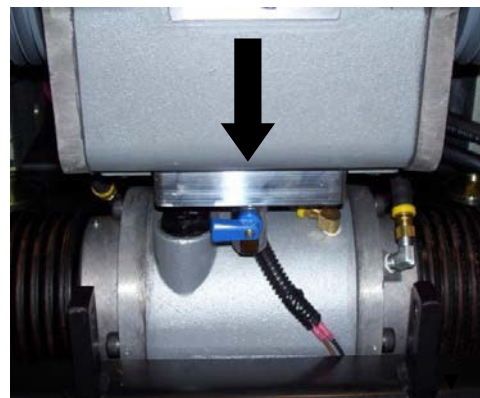

Upper Gearbox Heat Sink

Drain the heat sink daily; especially in freezing weather conditions.

1. Lower the saw completely.
2. Open the water drain valve on the heat sink and drain the heat sink completely.
3. Close the water drain valve.

Lower Gearbox

Clean the lower gearbox breather vent (at end of vent tube) using compressed air to remove oil, dirt, and slurry every 100 hours.

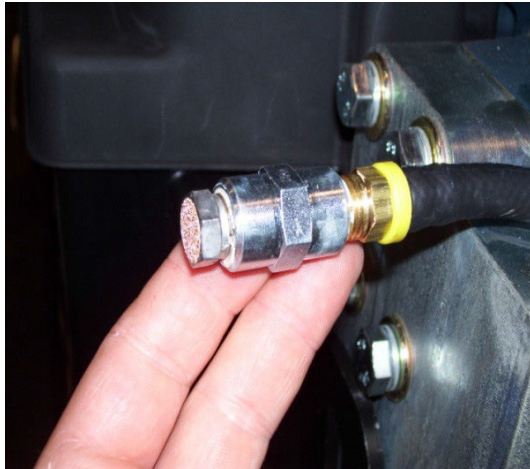

Lower Gearbox Breather Vent

Changing the Lower Gearbox Fluid

Change the lower gearbox fluid every 100 hours.

1. Place a drain pan under the gearbox drain plug (on back of gearbox).
2. Remove the gearbox drain plug and drain the fluid completely. Dispose of the used fluid according to city, state, and federal regulations.
3. Replace the drain plug and retighten to secure.
4. Lower saw to level frame.
5. Remove the red vinyl plug from the frame base (below gearbox) to view the fluid level from the sight glass.
6. Remove the fill cap and add Synthetic ATF fluid to the lower gearbox to at least half full (view level through sight glass).
7. Replace the fill cap and retighten to secure.
8. Replace the red vinyl plug in frame base.

Changing the In-Line Oil Suction Filter

Clean the in-line oil suction filter every 100 hours. Replace the filter when it cannot be properly cleaned or is damaged.

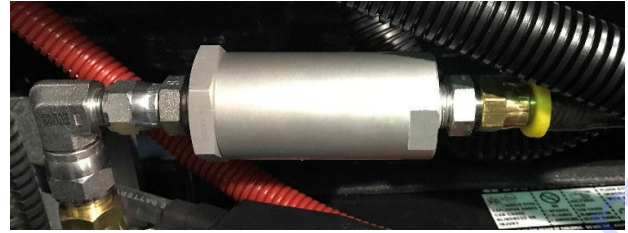

In-Line Oil Suction Filter

1. Lower the saw completely.
2. Place a drain pan underneath the filter.
3. Use a wrench to hold the hex filter cap in position. Use another wrench on the barrel flats and loosen the barrel from the cap. A very small amount of oil may drain. Dispose of the used oil according to city, state, and federal regulations.
4. Remove the spring and bronze element from the barrel. Clean the inside of the barrel and the bronze filter element using an industrial cleaning solvent. Replace the filter if damaged or not cleanable.
5. Fit the bronze filter inside the spring and place the assembly back into the filter barrel.
6. Retighten the filter barrel to the hex filter cap to secure.

Belt Sheaves

The upper and lower belt sheaves may need to be changed when changing the blade size. Refer to the CC7574 Parts List for additional information.

Removing the Belt Sheaves

1. Loosen the two engine cradle screws.
2. Loosen the nut away from the engine foot on both blade drive belt tension bolts.
3. Turn both blade drive belt tension bolts (large threaded bolt on engine foot) counterclockwise to loosen the belts.
4. Remove both sets of belts from the four sheaves.
5. Remove both setscrews from one of the sheaves.

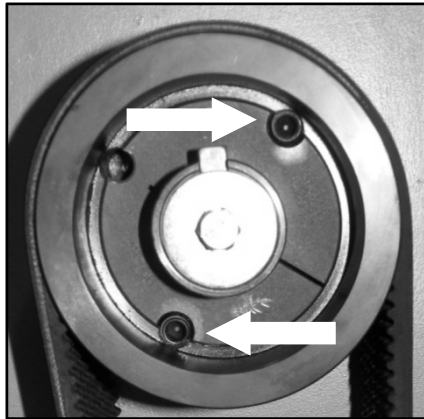

Sheave Setscrews

6. Place one of the removed setscrews into the third setscrew hole (in line with slot) on the bushing. Using a 1/2" impact wrench, tighten the setscrew into the hole to separate the sheave from the bushing. If the sheave and bushing will not separate, wedge a flat-head screwdriver into the slot on the bushing and tap the other end of the screwdriver with a rubber mallet to separate the sheave and bushing.
7. Remove the sheave from the bushing.
8. Repeat steps 5–7 to remove the three remaining sheaves.
9. Remove the setscrew used to separate the sheave and bushing from all four bushings.

Installing Belt Sheaves

1. Fit the appropriate size sheave onto each bushing.
2. On one side of the saw, place a straightedge against the edge of the upper or lower sheave. Adjust either sheave to align the outside edge of both sheaves.
3. Place two setscrews into the setscrew holes (in line with each other) on both sheaves and retighten the setscrews to secure.

Note: Make sure both sheaves are properly aligned prior to securing.

4. Repeat steps 2–3 for the second set of sheaves.
5. Turn both blade drive belt tension bolts (large threaded bolt on engine foot) clockwise equally to tighten the belts. Test the belt tension and readjust the bolts as necessary. **DO NOT** exceed the manufacturer's tension settings.

6. Tighten the nut on both blade drive belt tension bolts down to the engine foot.
7. Retighten the two engine cradle screws.

Blade Drive Belts

⚠ WARNING

- Turn off the engine prior to servicing the belts.
- Use extreme caution when working with belts and rotating machine parts to avoid entanglement.

⚠ CAUTION

- Let the belts cool down prior to servicing them.

Inspect all belts daily for fraying, stress cracks, and/or breakage and replace immediately when damaged. Always re-tension new belts after the first four hours of use. **DO NOT** exceed the manufacturer's recommended belt tension settings when tensioning belts.

Note: Over-tensioning belts may reduce the life of the gearbox bearings. Under-tensioning belts may cause slippage, shorter belt life, and/or poor saw performance. Squealing belts indicate looseness.

Tensioning/Replacing the Blade Drive Belts

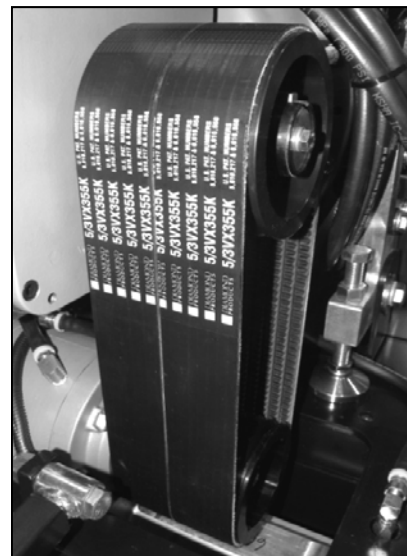

Blade Drive Belts

1. Test the belt tension.

2. Loosen the two engine cradle screws. If tensioning the belts, proceed with steps 7–9. If replacing the belts, continue with steps 3–9.
3. Loosen the nut away from the engine foot on both blade drive belt tension bolts.
4. Turn both blade drive belt tension bolts (large threaded bolt on engine foot) counterclockwise to loosen the belts.

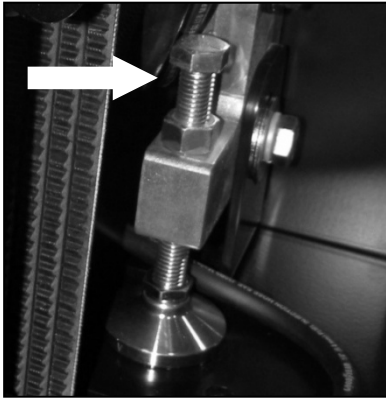

Belt Tension Bolt

5. Remove both sets of belts from the four sheaves.
6. Loop and align the first matched set of belts around the lower gearbox sheave and then around the upper gearbox sheave, and repeat with the second matched set of belts. Repeat the procedure for the second set of sheaves.

Note: Make sure the belts are fitted against each other, and are aligned on the sheaves.

7. Turn both blade drive tension bolts (large threaded bolt on engine foot) clockwise equally to tighten the belts. Test the belt tension and readjust the bolts as necessary. **DO NOT** exceed the manufacturer's tension settings.
8. Tighten the nut on both blade drive belt tension bolts down to the engine foot.
9. Retighten the two engine cradle screws.

In-Line Fuel Filter

Change the in-line fuel filter every 250 to 500 hours, depending on the amount of buildup in the filter.



In-Line Fuel Filter

1. Lower the saw completely.
2. Place a drain pan under the hoses and in-line filter.
3. Pinch the hose on both sides of the filter using an appropriate pinch-off tool for tubing.
4. Remove the hose clamp from both sides of the filter.
5. Remove the filter from the hoses. Drain any escaping fuel and dispose of the used fuel and filter according to city, state, and federal regulations.
6. Place the fuel hose coming from the fuel tank onto the end of the filter (the arrow on the filter should not point toward this hose). Push the hose tightly up against the edge of the filter and secure with the hose clamp.
7. Place the fuel hose coming from the fuel pump onto the other end of the filter (the arrow on the filter should point toward this hose). Push the hose tightly up against the edge of the filter and secure with the hose clamp.
8. Remove the pinch-off tool from the hoses and check for leaks.

Engine

 **WARNING**

- Let the engine cool down prior to servicing the saw.
- **DO NOT** service the saw with the engine running unless otherwise stated.

Refer to the engine manual and manufacturer for a full engine maintenance schedule and additional engine maintenance information.

Cleaning the Engine

Clean and wipe down the engine's exterior, fans, and guards daily to prevent high operating temperatures.

Changing the Engine Oil

- Refer to Engine Operators manual for oil specifications and capacities.
 - Change the oil after the first 50 hours of operation, then every 500 hours afterward.
 - If the annual operating hours are less than 500, change the oil every year.
 - The oil filter should be changed when the oil is changed.
 - Refer to Engine Manual for Oil Filter Specifications.
1. Remove Hydraulic lift pump cover.
 2. Remove oil drain hose from behind lift pump.

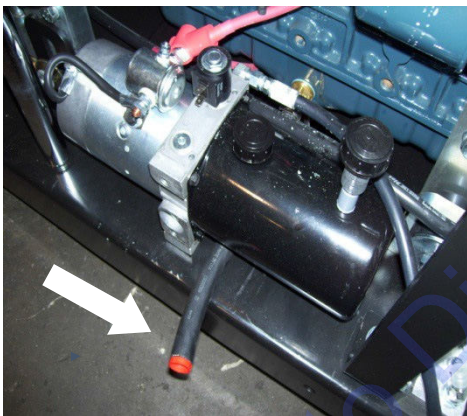

Oil Drain Hose

3. Level saw frame and place drain pan beneath drain hose.
4. Remove red plastic drain plug and open drain valve on side of oil pan.

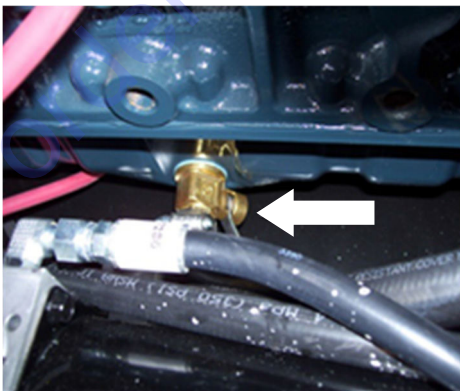

Oil Drain Valve

5. Drain oil completely and dispose of according to city, state and federal regulations.
6. Shut oil drain valve and replace red plastic drain plug.
7. Return oil drain hose to original position on engine side of the lift pump.
8. Replace hydraulic pump cover and retighten.

Air Cleaner

Restriction Indicator



Restriction Indicator

- Service the air filters when the restriction indicator turns red.
- Press the restriction indicator reset button on the top of the indicator to reset the unit after the air filters has been serviced.

Rubber Dust Ejector Boot

The rubber dust ejector boot valve ejects debris and water when operating the saw. Occasionally inspect and clean the ejector boot.

- Press inward on both sides of the ejector boot near the valve opening to release debris and water, and clean the valve opening as necessary.



Rubber Dust Ejector Boot

Cleaning/Replacing the Outer Primary Filter

Service the outer primary filter according to the restriction indicator service bar. Replace the filter annually. **DO NOT** operate the saw without the filter installed.

1. Pull out the tab on the air cleaner housing end cover.



End Cover Tab

2. Turn the end cover counter-clockwise to unlock and pull the cover away from the main air cleaner housing.
3. Pull the outer primary filter out of the air cleaner and inspect it for damages. Replace as necessary.
4. Move away from the saw and clean the filter from the inside out. Use dry compressed air to clean the filter (a maximum of 40 psi or 2.75 bar).
5. Inspect the inside of the air cleaner housing and the end cover for debris, and wipe them down with a damp cloth as necessary. **DO NOT** use compressed air to blow out the inside of the air cleaner housing. **DO NOT** allow dust to enter the air intake tube when cleaning or replacing parts.
6. Place the filter into the air cleaner housing (over the inner safety filter) and gently push the filter into the unit until it feels secure.

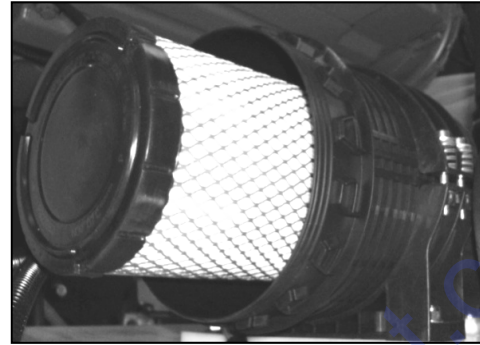

Outer Primary Filter

7. Place the end cover tightly up against the ridge at the end of the air cleaner housing.
8. Turn the end cover clockwise to lock the cover onto the air cleaner housing, making sure the dust ejector boot is in the vertical position.
9. Push the tab in on the air cleaner housing end cover to secure.

Replacing the Inner Safety Filter

- **DO NOT** clean the inner safety filter.
 - Replace it after approximately one year, or if there are damages. **DO NOT** operate the saw without the filter installed.
1. Pull the tab out on the air cleaner housing end cover.
 2. Turn the end cover counter-clockwise to unlock and pull cover away from the air cleaner housing.
 3. Pull the outer primary filter and the inner safety filter out of the air cleaner housing. Inspect the outer primary filter for damages and replace as necessary.
 4. Inspect the inside of the air cleaner housing and the end cover for debris, and wipe them down with a damp cloth as necessary. **DO NOT** use compressed air to blow out the inside of the air cleaner. **DO NOT** allow dust to enter the air intake tube when cleaning or replacing parts.
 5. Insert a new inner safety filter into the air cleaner housing and gently push the filter into the unit until it feels secure.

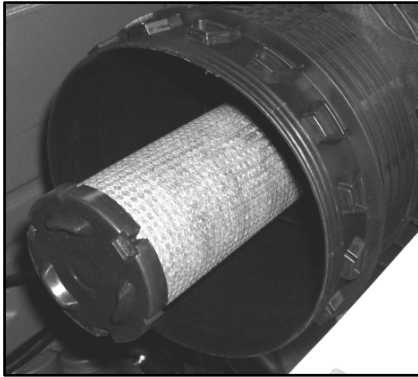

Inner Safety Filter

6. Place the outer primary filter into the air cleaner housing (over the inner safety filter) and gently push the filter into the unit until it feels secure.
7. Place the end cover tightly up against the ridge at the end of the air cleaner housing.
8. Turn the end cover clockwise to lock the cover onto the air cleaner housing.
9. Push the tab in on the air cleaner housing end cover to secure.

Storing

Complete the tasks listed below prior to storing the saw for longer time frames:

- Drain the water lines/hoses.
- Turn off all switches and controls.
- Lower the saw completely to remove strain on the lifting mechanism.
- Clean and wipe down the saw to remove dust, debris, and slurry from saw components (especially fans).
- Remove the battery and store in a proper location, out of reach from children
- Refer to the engine manual for all engine and fuel recommendations prior to storing.
- Store the saw in a dry area, protected from outdoor elements and out of reach from children.
- Refer to the engine manual for all engine and fuel recommendations prior to storing.
- Store the saw in a dry area, protected from outdoor elements and out of reach from children.

Disposal

Dispose of the saw when it's no longer repairable, and/or contains safety hazards not worth repairing or maintaining. Complete the tasks listed below when discontinuing usage:

- Drain all fluids and dispose of according to city, state, and federal regulations.

- Remove the battery and bring to a recycling facility; many battery retailers also accept old batteries.
- Transport the saw to a salvage yard or recycling facility.

Engine Regeneration

The engine is installed with a Diesel Particulate Filter (DPF). A DPF is a device designed to remove diesel particulate matter or soot from the exhaust gas of the diesel engine. This removal process is called a regeneration.

There are three types of regeneration associated with the engine:

- Passive
- Active
- Parked

There are five status levels that correspond to each particular regeneration type:

- Level 1 - Passive regeneration
- Level 2 - Active regeneration
- Levels 3 & 4 - Parked regeneration
- Level 5 – Regeneration impossible

Passive Regeneration

Occurs when the temperature of the exhaust is high enough to naturally burn off at least some of the particulates (soot) captured by the DPF. Most normal use of the saw where the engine is operated under full load will cause exhaust temperatures high enough (above 300°C / 572°F) to produce passive regen, preventing soot buildup. There is no action required from operator and there is no effect on machine operation.

This type of regeneration corresponds to Level 1 status as long as the “Regen Settings” in the Utilities menu are set to “Uninhibit Regen” (default setting). If it is set on “Inhibit Regeneration” a yellow Level 1 pop-up message will appear on the control screen:

The Diesel Particulate Filter is loaded with soot and needs to be regenerated.

When safe please uninhibit automatic active regeneration.

Regeneration Level 1 Yellow Caution

When this pop-up message appears, the operator can choose one of two options:

1. Reset the “Regen Settings” in the Utilities menu to “Uninhibit Regen”. This will allow for a passive regeneration to occur without further action from the operator.
2. Cancel out of the regeneration process and return to the Home screen. This will not allow for a passive regeneration to occur and the DPF will continue to build up diesel particulate matter. No further action from the operator is required at this time.

Active Regeneration

The “Regen Settings” are set to “Uninhibit Regen” (Default setting) in the Utilities menu. This will allow active regeneration to occur if the system detects the exhaust temperatures are insufficient to passively keep the DPF from clogging with particulates. The engine controls inject diesel fuel directly into the DPF to increase temperature to burn off, i.e. clean, the soot captured in the filter.

This should occur infrequently, but will happen more often if the engine is allowed to idle excessively (longer than five minutes) or sawing is lightly loaded. Failure to change oil at recommended intervals can also contribute to excessive soot buildup. It is not unusual to see excessive smoke being emitted from the tailpipe during regeneration. . Machine operation is NOT interrupted. It is recommended to let the regeneration complete automatically, typically 20 minutes, but if it needs to be interrupted turn the ignition to **STOP**.

 **CAUTION**

ACTIVE REGENERATION will cause the exhaust temperatures to be extremely high. Ensure exhaust will not come into contact with combustible materials

During active regeneration the display panel will show the red status icon, Engine Exhaust High Temperature Lamp.

This type of regeneration corresponds to Level 2 status. If the Regen Settings” in the Utilities menu are set to “Inhibit Regen” and a Level 1 pop-up message was cancelled, then a series of two orange Level 2 pop-up messages will appear on the control screen:

The Diesel Particulate Filter is loaded with soot and needs to be regenerated.

Whenever safe either uninhibit automatic active regeneration or complete a parked regeneration:

More...

**Regeneration Level 2 Orange Caution
Screen 1**

- 1) Move the machine to a safe location.
 - 2) Place in Park or Neutral.
 - 3) Set the engine to low idle.
 - 4) Uninhibit regeneration.
 - 5) Apply the parking brake (if equipped).

**Regeneration Level 2 Orange Caution
Screen 2**

When this pop-up message appears, the operator can choose one of three options:

1. Cancel out of the regeneration process and continue operations.
2. Change the “Regen Settings” in the Utilities menu to “Uninhibit Regen” which will allow for an active regen to take place. The regeneration process will typically take 20 minutes to complete. This option will also allow for the continued use of the machine without any further action from the operator. *However, the operator must be aware that the exhaust temperatures will be extremely high.*
3. Move the machine to a safe location and conduct a Parked Regeneration. This option is recommended as long as time permits.

Parked Regeneration

When the diesel particulate levels in the DPF become too high, a red Level 3 pop-up message will appear on the control screen:

Urgent engine output limited. The Diesel Particulate Filter is EXTREMELY loaded with soot and needs to be regenerated.

Continued operation without completing a parked regeneration can cause unwarranted engine damage.

IMMEDIATELY: MORE....

**Regeneration Level 3 Red Caution
Screen 1**

- 1) Move the machine to a safe location.
- 2) Place in Park or Neutral.
- 3) Set the engine to low idle.
- 4) Uninhibit regeneration.
- 5) Apply the parking brake (if equipped).

**Regeneration Level 3 Red Caution
Screen 2**

When this pop-up message appears, the operator can choose one of two options:

1. Cancel out of the regeneration process and continue operations.

 **WARNING**
Continued operation at a Level 3 status may cause unwarranted engine damage

2. Move the machine to a safe area and conduct a parked regeneration. A parked regeneration will typically take 30 minutes to complete. It is strongly recommended to conduct a parked regeneration immediately to prevent possible engine damage.

If a regeneration is not conducted, a red Level 4 pop-up message will appear on the control screen:

Urgent engine output limited.

DPF regeneration is required IMMEDIATELY by a qualified engine or OEM service technician.

IMMEDIATELY take the machine to a safe location, shutdown and contact a qualified service facility.

Regeneration Level 4 Red Caution

If this Level 4 message appears, it is critical that the machine be taken to a safe area and shutdown. A DPF regeneration is required to be completed by a qualified engine or OEM service technician. Any further operation of the machine will result in a Level 5 status warning:

Urgent engine output is SEVERELY limited. DPF Regeneration is impossible.

The DPF must be removed and cleaned by a qualified cleaning facility and the ECU must be reset by a qualified engine or OEM service technician. IMMEDIATELY take the machine to a safe location, shutdown and contact a qualified service facility.

Regeneration Level 5 Red Caution

Once a Level 5 message is displayed, the machine must be taken to a safe area and shutdown. It will need to have the DPF removed and cleaned by a qualified cleaning

facility and the ECU will need to be reset by a qualified engine or OEM technician.

Whenever a successful regeneration occurs, a green “Completed” pop-up message will appear on the control screen:

DPF regeneration is complete

The machine may be returned to normal usage.

Regeneration Complete

Cold Weather Parked Regeneration

When the ambient temperature is 50° F (10° C) or below, a cold weather regeneration will be necessary to allow the engine to reach sufficient temperatures to conduct a proper regeneration. The cold weather regeneration process is exactly the same as a parked regeneration except that a canvas cover needs to be placed over the radiator.

The canvas cover is located on the inside of the rear cover screen.

1. Open the rear cover screen.
2. Unstrap the canvas cover.
3. Snap the canvas cover over the radiator at the four corners.
4. Close the rear cover screen.
5. Request a parked regeneration in accordance with the operation in this manual.
6. When the regeneration process is complete, unstrap the canvas cover and re strap it to the inside of the rear cover screen.

Requesting a Parked Regeneration

 **CAUTION**

PARKED REGENERATION will cause the exhaust temperatures to be extremely high. Ensure exhaust will not come into contact with combustibile materials

 **WARNING**

If the DPF soot level reaches Regen Level 4 (Red) due to inhibiting regeneration, the engine should be shut down and a qualified engine or OEM service technician will be required to perform a forced regeneration.

1. To conduct a parked regeneration of the DPF the following conditions must be met:
 - Machine is in a safe area with the speed control lever in the *STOP/PARK* position
 - Engine is in low idle
 - Regen setting must be set to “Uninhibit Regen”
 - If ambient temperature is at or below 50° F > (10° C), ensure the canvas radiator cover is installed in accordance with the “Cold Weather Parked Regeneration” procedure called out earlier in this manual
2. Once these conditions are met, go to the Menu screen and choose “Utilities”
3. From the Utilities menu select “Regen Settings”
4. From the “Regen” menu select “Request Regen”
5. A series of three blue pop-up messages will appear on the control screen:

The DPF will now regenerate. This may take 20–40 minutes. The engine speed may increase during this process, this is normal.

The exhaust temperature may reach very high levels; ensure that proper safety measures are taken to avoid injuries and property damage. More...

Regeneration, Screen 1

During this process:
DO NOT move the machine out of park or neutral.
DO NOT touch the accelerator pedal/lever.
DO NOT turn the engine off or stop the regeneration process. More...

Regeneration, Screen 2

Unless there is an emergency, in which case the machine can be moved or shut down by normal means.

When the above conditions are met, begin the parked regeneration by pushing the “Request Regen” button.

Regeneration, Screen 3

6. Use the UP/DOWN arrows to maneuver through the screens until the “Request Regen” soft key appears.
7. Select “Request Regen” to begin the regeneration process.

NOTE: During the regeneration process, the engine speed will increase and there may be noticeable sound difference.

CAUTION

DO NOT attempt to operate the unit, change engine RPM or move from “Parked/Stop” while regeneration is occurring. This will abort the regeneration process and require to start the process over.

CAUTION

Once the process has started it can be stopped by selecting the “Stop Regen” soft key. DO NOT shutdown unless it is absolutely necessary. Continue to monitor the surrounding areas during the process. If unsafe conditions develop, shutdown the unit immediately.

The regeneration process will take approximately 20-30 minutes to complete. The following green pop-up message will appear on the control screen when the process is completed:

DPF regeneration is complete

The machine may be returned to normal usage.

Regeneration Complete

When this message appears, the machine can return to normal operation.

Appendix A

Daily Maintenance Task Chart

Daily Maintenance Task Chart							
Date							
		✓	✓	✓	✓	✓	✓
1.	Inspect all belts for tension and wear. Replace or tension as necessary.						
2.	Inspect the saw for damages,						
3.	Tighten loose nuts, screws, and bolts.						
4.	Check fuel level and fill as necessary.						
5.	Check engine oil level and fill as necessary.						
6.	Check hydraulic fluid level and fill as necessary.						
7.	Check transmission fluid level and fill as necessary.						
8.	Check radiator coolant level and fill as necessary.						
9.	Wipe down and clean all saw components to remove dust, debris, and slurry.						
10.	Clean the air cleaner (see engine manual).						
11.	Check and drain the fuel/water separator as necessary.						
12.	Clean the radiator and wipe down the cooling fan.						
13.	Drain the heat sink.						
14.	Look for fluid leaks and check all hoses. Repair all damaged components.						
15.	Refer to the engine manual and manufacturer for daily engine care and routine maintenance tasks.						

Appendix B

Troubleshooting the CC7574DK

Troubleshooting the CC7574DK		
Symptom	Problem	Solution
1. Engine will not start.	Out of Fuel?	Fill fuel tank.
	Fuel lines clogged?	Unclog or replace fuel lines.
	Air in fuel lines?	Bleed fuel lines.
	Worn out battery?	Charge or replace battery.
	Faulty battery connection?	Inspect, clean, and tighten battery cables.
	Engine malfunction?	Refer to engine manual.
	Bad fuse?	Check and replace bad fuses.
2. Engine will not start due to a shutdown condition indicated on display panel. <i>NOTE: All problems must be cleared before saw will restart.</i>	E-Stop is active.	Pull up emergency stop button.
	Coolant level is extremely low.	Fill coolant system in accordance with "Bleeding Air from the Coolant System" procedure outlined in the Maintenance section of this manual.
	Back door panel is open.	Shut and latch the radiator door. Check for proper operation of the door interlock switch.
3. Saw will not raise.	Defective solenoid start switch?	Replace solenoid on hydraulic pump unit.
	Worn out battery?	Charge or replace battery.
	Defective raise button?	Replace raise button.
	Low hydraulic fluid?	Check hydraulic fluid level and fill as necessary.
4. Saw will not lower.	Debris in lowering valve stem?	Inspect and clean stem.
	Worn out battery?	Charge or replace battery
	Defective valve coil?	Check for magnetism of valve stem when activated.
	Defective lowering button?	Replace lowering button.
5. Saw will not lower completely.	Depth stop set?	Reset depth stop.
	Skid plates in wrong set of holes?	Adjust skid plates to correct set of mounting holes.
	Maximum cutting depth set incorrectly?	Adjust maximum cutting depth bolt.
6. Saw lowers too slow or too fast.	Improper lowering speed setting?	Adjust blade lowering speed valve.
7. Blade does not cut straight.	Drive alignment off?	Adjust rear axle adjustment bolt.
	Excessive force used when sawing?	Reduce forward speed. DO NOT twist blade from side to side.
	Wrong blade?	Contact Discount-equipment.
8. Short belt life.	Loose belts causing slippage?	Check and adjust belt tension.
	Sheaves misaligned?	Use straightedge to check blade shaft sheave alignment. Adjust as necessary.
	Worn sheave grooves?	Check for groove wear and replace sheaves when necessary.
	Mismatched belts?	Replace with matched set of belts. DO NOT use old and new belts together.

Troubleshooting the CC7574DD

Troubleshooting the CC7574DD		
Symptom	Problem	Solution
1. Engine will not start.	Out of Fuel?	Fill fuel tank.
	Fuel lines clogged?	Unclog or replace fuel lines.
	Air in fuel lines?	Bleed fuel lines.
	Worn out battery?	Charge or replace battery.
	Faulty battery connection?	Inspect, clean, and tighten battery cables.
	Engine malfunction?	Refer to engine manual.
	Bad fuse?	Check and replace bad fuses.
2. Engine will not start due to a shutdown condition indicated on display panel. <i>NOTE: All problems must be cleared before saw will restart.</i>	E-Stop is active.	Pull up emergency stop button.
	Back door panel is open.	Shut and latch the radiator door.
		Check for proper operation of the door interlock switch.
3. Low engine coolant level warning indicated on display panel. <i>NOTE: Saw will continue to run at reduced power until engine is turned off. If the problem is not cleared a shutdown warning will be displayed the next time the keyed is turned to the on position.</i>	Coolant level is extremely low.	Fill the coolant system in accordance with the "Adding Radiator Fluid" procedure outlined in the Maintenance section of this manual
4. Saw will not raise.	Defective solenoid start switch?	Replace solenoid on hydraulic pump unit.
	Worn out battery?	Charge or replace battery.
	Defective raise button?	Replace raise button.
	Low hydraulic fluid?	Check hydraulic fluid level and fill as necessary.
5. Saw will not lower.	Debris in lowering valve stem?	Inspect and clean stem.
	Worn out battery?	Charge or replace battery
	Defective valve coil?	Check for magnetism of valve stem when activated.
	Defective lowering button?	Replace lowering button.
6. Saw will not lower completely.	Depth stop set?	Reset depth stop.
	Skid plates in wrong set of holes?	Adjust skid plates to correct set of mounting holes.
	Maximum cutting depth set incorrectly?	Adjust maximum cutting depth bolt.
7. Saw lowers too slow or too fast.	Improper lowering speed setting?	Adjust blade lowering speed valve.

REFERENCE

Troubleshooting the CC7574DD		
Symptom	Problem	Solution
8. Blade does not cut straight.	Drive alignment off?	Adjust rear axle adjustment bolt.
	Excessive force used when sawing?	Reduce forward speed. DO NOT twist blade from side to side.
	Wrong blade?	Contact Discount-equipment.
9. Short belt life.	Loose belts causing slippage?	Check and adjust belt tension.
	Sheaves misaligned?	Use straightedge to check blade shaft sheave alignment. Adjust as necessary.
	Worn sheave grooves?	Check for groove wear and replace sheaves when necessary.
	Mismatched belts?	Replace with matched set of belts. DO NOT use old and new belts together.

To order go to Discount-Equipment.com

Appendix C

Additional References

1. Kubota (www.kubota.com)
 - Operator's Manual Kubota Engine, V3307-CR-T-E4-B
 - Operator's Manual Deutz Engine, TD-2.9-L4
2. Discount-equipment (www.discount-equipment.com)
 - CC7574 Concrete Saw Parts List; Ohio, 2010
 - A Guide for Professional Concrete Cutters
 - Training Manual – Introduction to Diamond Blades, Bits, and Equipment
 - Diamond Products' Equipment Catalog
 - Discount-equipment' Website (www.discount-equipment.com)
3. Concrete Sawing and Drilling Association (www.csda.org)
 - The CSDA has many helpful concrete cutting publications available to members and non-members.
4. Association of Equipment Manufacturers (www.aem.org)
 - The AEM has a variety of safety and technical manuals available for various types of equipment, along with a list of industry-standardized safety symbols.
5. Occupational Safety & Health Administration (OSHA) (www.osha.gov/)
 - OSHA provides information on work-related safety and health practices.
6. The National Institute for Occupational Safety and Health (NIOSH) (www.cdc.gov/NIOSH/)
 - NIOSH provides information on work-related safety and health practices.

Appendix D

Model and Serial Numbers

Record the saw's serial number below for future reference and customer service purposes.

Serial Number	
---------------	--

Record the engine's model and serial numbers below for future reference and customer service purposes.

Model Number	
Serial Number	

To order go to Discount-Equipment.com

EQUIPMENT AND PARTS WARRANTY

Discount-equipment warrants all equipment sold by it against defects in workmanship or materials for a period of one (1) year from the date of shipment to Customer.

The responsibility of Discount-equipment under this Warranty is limited to replacement or repair of defective parts, of such parts as shall appear to us upon inspection at such parts, to have been defective in material or workmanship, with expense for transportation and labor borne by Customer.

In no event shall Discount-equipment be liable for consequential or incidental damages arising out of the failure of any Product to operate properly.

Integral units such as engines, electric motors, batteries, transmissions, etc., are excluded from this Warranty and are subject to the prime manufacturer's warranty.

**THIS WARRANTY IS IN LIEU OF ALL OTHER WARRANTIES,
EXPRESSED OR IMPLIED, AND ALL SUCH OTHER WARRANTIES ARE
HEREBY DISCLAIMED.**



TO PURCHASE THIS PRODUCT PLEASE CONTACT US



**Equipment Financing and
Extended Warranties Available**



**Discount-Equipment.com is your online resource for
commercial and industrial quality parts and equipment sales.**

561-964-4949

visit us on line @ www.discount-equipment.com

Select an option below to find your Equipment

Search by Manufacturer

Search by Product Type

Request a Quote

We sell worldwide for the brands: Genie, Terex, JLG, MultiQuip, Mikasa, Essick, Whiteman, Mayco, Toro Stone, Diamond Products, Generac Magnum, Airman, Haulotte, Barreto, Power Blanket, Nifty Lift, Atlas Copco, Chicago Pneumatic, Allmand, Miller Curber, Skyjack, Lull, Skytrak, Tsurumi, Husquvarna Target, Stow, Wacker, Sakai, Mi-T-M, Sullair, Basic, Dynapac, MBW, Weber, Bartell, Bennar Newman, Haulotte, Ditch Runner, Menegotti, Morrison, Contec, Buddy, Crown, Edco, Wyco, Bomag, Laymor, EZ Trench, Bil-Jax, F.S. Curtis, Gehl Pavers, Heli, Honda, ICS/PowerGrit, IHI, Partner, Imer, Clipper, MMD, Koshin, Rice, CH&E, General Equipment, Amida, Coleman, NAC, Gradall, Square Shooter, Kent, Stanley, Tamco, Toku, Hatz, Kohler, Robin, Wisconsin, Northrock, Oztec, Toker TK, Rol-Air, APT, Wylie, Ingersoll Rand / Doosan, Innovatech, Con X, Ammann, Mecalac, Makinex, Smith Surface Prep, Small Line, Wanco, Yanmar