



LGMG North America Inc.



www.Discount-Equipment.com

Maintenance Manual

T65J/T85J

Mobile Elevating Work Platform

ANSI



WARNING

Before operation and maintenance, the drivers and service personnel shall always read and thoroughly understand all information in this manual. Failure to do so may result in, fatal accidents or personal injury.

This manual must be kept with this machine at all times.

Contents

Contents.....	I
Chapter 1 Maintenance	1
1.1 Compliance.....	3
1.2 Inspecting the Pivoting Support	3
1.3 Inspecting the Boom Wear Pad	4
1.4 Inspecting the Wire Rope.....	4
1.5 Inspecting the Drive Hub Oil Level.....	5
1.6 Inspecting the Hydraulic Oil And Filter	5
1.7 Check for Engine Oil Level	6
1.8 Replacement of Engine Oil and Filter	7
1.9 Check for Fuel Leakage.....	8
1.10 Discharge Fuel Filter.....	9
1.11 Replacement of the Fuel filter	10
1.12 Check for Engine Air Filter	11
1.13 Cleaning or Replacement of Air Filter.....	11
1.14 Check for Coolant Liquid Level	12
1.15 Filling or Replacement of Engine Coolant	12
1.16 Check for Engine Belt	13
1.17 Regular Maintenance.....	13
1.18 Inspecting the battery	13
1.19 Engine fault table	15
1.20 Engine fault Codes	18
Chapter 2 Schematics	25

Foreword

Thank you for choosing to use this Mobile Elevating Work Platform from LGMG North America. This machine is designed according to A92.20-2018. The information specified in this manual is intended for the safe and proper operation of this machine for its' intended purpose.

For maximum performance and utilization of this machine, thoroughly read and understand all the information in this manual before starting, operating, or performing maintenance on this machine.

Due to continuous product improvements, LGMG North America reserves the right to make specification changes without any prior notifications. For any updated information, contact LGMG North America.

Ensure all preventive maintenance to the machine is performed according to the interval specified in the maintenance schedule.

Keep this manual with this machine for reference at all times. When the ownership of this machine is transferred, this manual shall be transferred with this machine. This manual must be replaced immediately if it is lost, damaged, or becomes illegible.

This manual is copyrighted material. The reproduction or copy of this manual is not allowed without the written approval of LGMG North America.

The information, technical specifications and drawings in this manual are the latest available when this manual is issued. Due to continuous improvement, LGMG North America reserves the right to change the technical specifications and machine design without notice. If any specifications and information in the manual are not consistent with your machine, please contact the service department of LGMG North America.

WARNING

Only personnel who have been properly trained and qualified to operate or maintain this machine can operate, repair and maintain this machine.

Improper operation, maintenance, and repair are dangerous and can cause personal injury and death.

Before any operation or maintenance, the operator shall thoroughly read this manual. Do not operate, perform any maintenance or make any repairs on this machine before reading and understanding this manual.

The user shall load the platform strictly according to the load rating of the platform. Do not overload the platform or make any modifications to the platform without permission from LGMG North America.

The operation regulations and preventions in this manual are only applicable for the specified use of this machine.

Safety Precautions

The operator of this machine shall understand and follow the existing safety regulations of state and local governments. If these are unavailable, the safety instructions in this manual shall be followed.

To help prevent accidents, read and understand all warnings and precautions in this manual before operation or performing maintenance.

It is impossible to foresee every possible hazard and the safety instructions in this manual may not cover all safety prevention measures. Always ensure the safety of all personnel and protect the machine against any damage. If unable to confirm the safety of some operations, contact LGMG North America.

The operation & maintenance prevention measures listed in this manual are only applicable to the specified uses of this machine. LGMG North America assumes no responsibility if this machine is used beyond the range of this manual. The user and the operator shall be responsible for the safety of such operations.

Do not perform any operation forbidden in this manual in any situation.

The following signal words are applicable for identifying the level of safety information in this manual.

 **Danger:**

An imminent situation, that if not avoided, will result in severe injuries or death. This is also applicable to situations that will cause serious machine damage, if not avoided.

 **Warning:**

A potentially dangerous situation, that if not avoided, may result in severe injuries or death. This is also applicable to situations that may cause serious machine damage, if not avoided.

 **Notice:**

A situation, that if not avoided, may result in minor or intermediate injury. This is also applicable to situations that may cause machine damage or shorten machine service life.

Chapter 1 Maintenance

Go to Discount-Equipment.com to order your parts

1.1 Compliance

- 1) You accept the proper training of safety operation and machine maintenance, and have corresponding aptitudes.
- 2) It is necessary to read, understand and adhere to all safety regulations of this manual, safety regulations of workplace and applicable laws and regulations of government.
- 3) Protective articles, such as safety helmet, safety belt, work shoes, goggles and protective clothing, have been equipped all over the body, and the physical state is excellent.
- 4) Operators can only conduct conventional inspection and maintenance items as specified in this manual.
- 5) Only technical maintenance personnel who are trained and get corresponding certificates may complete scheduled maintenance.
- 6) Waste and old materials shall be disposed according to government regulations and work site rules.
- 7) Only LGMG North America approved parts and consumables can be used.
- 8) Function test shall be always conducted upon maintenance.

1.2 Inspecting the Pivoting Support

- 1) The turntable shall rotate smoothly without jamming, and meshing play between the turntable bearing and the swing gearbox is measured using a feeler gauge, which shall be between 0.2mm and 0.3mm. Measurement is conducted every 250 h or quarterly.

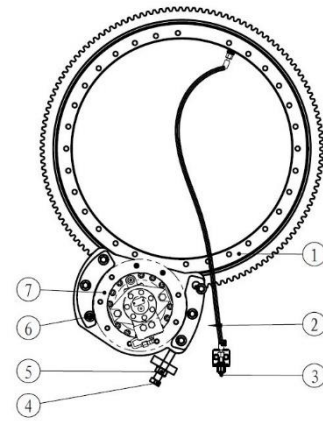

Figure 1-1

- Unscrew bolt 6 and locking nut 5
 - Turn adjusting bolt 4 to adjust the position of the swing gearbox
 - Measure play between the turntable bearing and the swing gearbox using a feeler gauge
 - If the play ranges from 0.2mm to 0.3mm, tighten lock nut 5 and bolt 6
 - Measure play between the turntable bearing and the swing gearbox again to verify the measurement
 - Tighten bolt 6, and torque to $(595 \pm 5) \text{N} \cdot \text{m}$.
- 2) Check lubrication in the turntable bearing and the swing gearbox at intervals of 100 hours. It is necessary for maintaining performance and maintenance life to lubricate the turntable bearing frequently. Incorrect lubrication will cause damage to components. As shown in Figure 1-1, find the grease port 3 on the side of the bearing, swing the turntable multiple times while filling grease until grease overflows from the upper and lower fixed surfaces of the bearing. Lubricating grease must be: Lubrication EP2 or equivalent.
 - 3) Inspect the lubrication of the turntable bearing and the swing gearbox, if necessary, clean the gear surface, and recoat with grease.



Caution: In the case of an extremely dirty working environment, increase the oil filling frequency.

1.3 Inspecting the Boom Wear Pad

- 1) Inspect the wear pad every 1,000 h or yearly.
- 2) The wear pad is located on the housing surface and inner wall of the boom to reduce friction. It is necessary for safe operation of the machine to maintain the wear pad in good condition. Continuous use of wear pads that are extremely worn will result in damage to components and unsafe operating conditions.
- 3) Extend the boom to check if the wear pad loosens, if the wear pad loosens, torque the securing bolt to: 28Nm. Inspect play between the wear pad and the boom, if the play is more than 1mm, arrange shims to achieve zero play and zero drag. Replace the wear pad if necessary. Part numbers of shims, please refer to the Parts Manual, and select the correct parts. Upon installation of the shims, it is necessary to extend the boom multiple times to eliminate potential binding.

1.4 Inspecting the Wire Rope

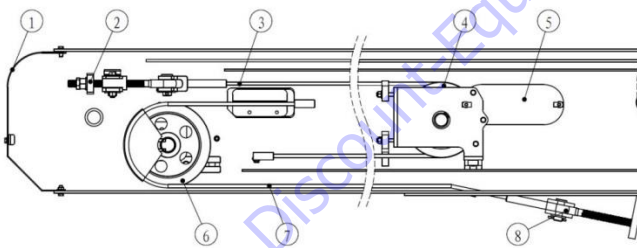

Figure 1-2 Boom Telescope System

1. Cover Plate
2. Extend Rope Anchor
3. Extend Rope
4. Extension Pulley Block
5. Cover Plate
6. Retract Pulley Block
7. Retract Rope
8. Retract Rope Anchor

After long-term operation of equipment, the wire

rope will stretch, resulting in boom sections not synchronized, separation of wire rope from pulley, boom shaking during extension, contact of wire rope to inner wall of boom sections or rubbing between wire rope and inner wall of the boom and other problems. It is necessary to conduct periodic checks on the condition of the wire rope. Inspect the stretching wire rope for stretching every 250 h or quarterly.

- 1) Raise the boom to horizontal, extend the boom, and inspect if the second-section and third-section booms are synchronized in the extension process of the boom. If the third-section boom lags behind the second-section boom, this means the wire rope is loose.
- 2) Raise the boom to horizontal, extend the boom, and inspect whether or not the third-section boom shakes or if there is “flap” sound from the wire rope whipping the inside of the boom section during extension. If this happens, it indicates the wire rope is loose.
- 3) Remove the rear cover plate (1) of the boom, and see if the extend rope anchor (2) deflects to one side. See if the retract rope anchor (8) deflects to one side. If deflection exists, it means the wire rope is loose.
- 4) Raise the boom to horizontal, extend the boom completely, remove the rear cover plate (1) and the side cover plate (5), and visually inspect for wear on the extension pulley block (4,) the retract pulley block (6), the extend rope (3) and the retract rope (7). The pulley shall be fixed firmly secured without play, non-uniform wear of the pulley groove shall be less than 3mm, and the wear of the pulley flange shall be smaller than 10% of the original wall thickness. There must be no loosening, breaks, and serious corrosion in the wire rope. During extension and retracting, there must be no flapping in the pulley. In the case of any abnormalities, stop using the machine immediately and tag out the machine.

Note: To adjust the wire rope, please refer to Service and Repair manual. **How to adjust the boom wire rope.**

1.5 Inspecting the Drive Hub Oil Level

- 1) Inspect the oil level of the drive hubs every 250 h or quarterly. Improper oil level will result in reduced performance. Continuous use will result in damage to components.
- 2) Inspect oil level



Figure 1-3 Traveling slowdown
1. Oil filler 2. Viewing port

- Drive the machine until one plug is located at the horizontal position as shown as shown in Figure 1-3.
- Remove the viewing port plug at the horizontal position, and inspect oil level.
- Result: Oil level shall be flush with the bottom of the viewing port.
- If necessary, add oil at the oil filler until the oil level is flush with the bottom of the viewing port, select gear oil by referring to Machine Specifications section.
- Coat the plugs with pipe thread sealant and install the plugs.
- Repeat this step for every drive hub.

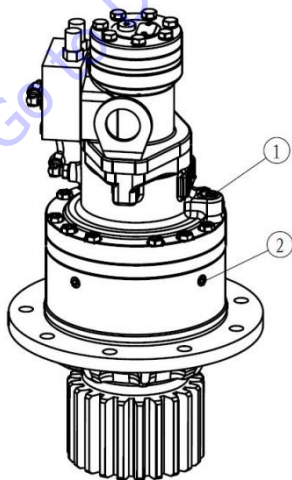

Figure 1-4 Swing Gearbox
1. Oil filler 2. Viewing port

- 3) Inspect oil level of swing gearbox
 - Remove the plug on the side and inspect the oil level, as shown in Figure 1-4.

Result: Oil level shall be flush with viewing port (2).

- If necessary, add gear oil at the oil filler plug until the oil level is flush with the bottom of the viewing port, select gear oil by referring to the Machine Specifications section.
 - Coat the plugs with pipe thread sealant and install the plugs.
- 4) Replace lubricant after the first 50h of use, then every 1,000 h or yearly.

1.6 Inspecting the Hydraulic Oil And Filter

- 1) Inspect hydraulic oil level every 8 h or every day.



Caution: Perform this step when the boom is in the retracted position.

- Park the vehicle on the flat site. Fully retract the boom.

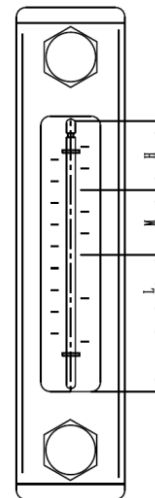

Figure 1-5 Oil Level Sight Gauge

- Examine the oil level on the hydraulic oil tank, i.e., level shall fall within the M range shown as Figure 1-5, and in the case of level lower than L, it is necessary to add hydraulic oil.
- 2) Inspect hydraulic oil leakage every 8 h or

daily.

 **Caution: Personal injury danger,**

i.e., leaking hydraulic oil can penetrate or burn skin. Wear goggles and protective gloves.

- Leakage of high-pressure oil may be invisible to eyes, use cardboard or wooden boards as a search tool for hydraulic oil leakage. Hands shall be prohibited from being used for leakage confirmation. Inspect oil drops or residual oil on the following components:
- Hydraulic oil tank, filter, pump, hydraulic oil cylinder, motor, reduction gear, valve block and hydraulic tubing.
- Inspect oil drops or residual oil at the following areas:

Rear of boom, fly jib, upper side of turntable, upper and lower sides of chassis, and ground underneath equipment.

- 1) Test or replace hydraulic oil every 2,000 h or every two years.

 **Caution: If the oil isn't replaced**

after the two year interval, it must be tested quarterly and replaced when it no longer passes the testing.

- 1) Replace hydraulic oil suction filter, oil return filter and high pressure filter every 500 h or every 6 months. Replace oil suction filter, oil return filter and high pressure filter after first 50 h of use. It is necessary to replace the hydraulic filter to maintain performance and service life of the machine. Dirt or a clogged filter may cause performance degradation of hydraulic components, and continuous use will cause damage to components. In dirty work environments it is necessary to increase the change intervals.

Use temperature	Oil type
The lowest temperature >	L-HV 32 low temperature

-25°C	hydraulic oil
-40 °C < The lowest temperature ≤ -25°C	L-HS32 ultra low temperature hydraulic oil
The lowest temperature ≤ -40°C	10# aviation hydraulic oil

1.7 Check for Engine Oil Level



 **Do not operate on running**

engines! No smoking and open fires! Be careful when contacting with high temperature engine oil. Danger of scalding!

 **When operating on the oil system, pay attention to the surface cleaning. Carefully clean all areas involved. Blow wet parts with compressed air.**

 **Please observe the safety**

regulations for engine oil and relevant local regulations. Dispose of spilled engine oil and filter elements as required. Waste oil cannot penetrate into the ground.

 **Test run shall be carried out after**

each operation. At the same time, pay attention to the sealing and lubricating oil pressure, and then check the engine oil level.

Check the engine oil level every 8 hours or every day.

Insufficient or excessive engine oil may cause

damage to the engine. The engine oil level can only be checked when the engine is placed horizontally and closed. If the engine is hot, close the engine and check the engine oil level 5 minutes later. Check it immediately if the engine is cooled.

- 1) Insert the oil measuring rod and clean it with a piece of clean and fiber-free cloth.
- 2) Insert the oil measuring rod into the bottom.
- 3) Pull out the oil measuring rod and read the value of engine oil level.
- 4) The engine oil level shall always be between MIN and MAX!

Fill up to the maximum liquid level if necessary.

1.8 Replacement of Engine Oil and Filter

Do not operate on running

engines! No smoking and open fires! Be careful when contacting with high temperature engine oil. Danger of scalding!

When operating on the oil system,

pay attention to the surface cleaning. Carefully clean all areas involved. Blow wet parts with compressed air.

Please observe the safety

regulations for engine oil and relevant local regulations. Dispose of spilled engine oil and filter elements as required. Waste oil cannot penetrate into the ground.

Test run shall be carried out after

each operation. At the same time, pay attention to the sealing and lubrication

oil pressure, and then check the engine oil level.

It is available in the first 50 hours, and the engine oil and filter shall be replaced every 500 hours. (If the ambient temperature continues to be below -10°C. (14 °F) or the temperature of engine oil is below 60°C (84 °F), or the sulphur content in the diesel fuel is 0.5 - 1%, the oil change period is reduced by a half; if the engine oil does not reach the replacement interval period within a year, the oil shall be replaced at least once a year.)

Danger of burn, be careful of

high-temperature engine parts and oil, contacting with high temperature engine oil and/or engine parts will cause severe burns.

Perform the function after engine

warm up to normal operation temperature.

Replacement of engine oil

After the filter element is replaced,

be sure to keep the engine idling at a low speed for at least 3-5 minutes, so that the engine has been lubricated before being put into operation.

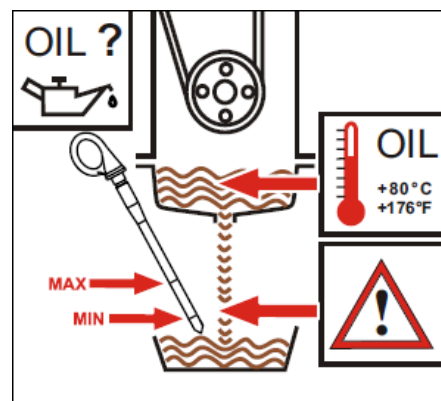

Figure 1-6

- 1) Warm up and run the engine (engine oil

temperature > 80°C).

- 2) Place the engine horizontally.
- 3) Shut down the engine.
- 4) Place the container under the engine oil drain plug.
- 5) Screw off the engine oil drain plug to drain the old engine oil.
- 6) Install the new seal ring for the engine oil drain plug and screw in and tighten it.
- 7) Add engine oil at the engine oil filler.
- 8) Warm up and run the engine (engine oil temperature > 80°C).
- 9) Place the engine horizontally.
- 10) Check the engine oil level and fill it if necessary.

Oil specification	CH-4/15W-40
Capacity	8.5L

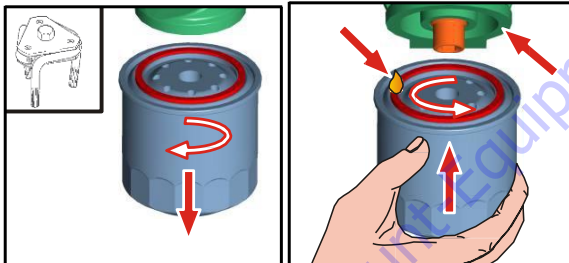

Figure 1-7

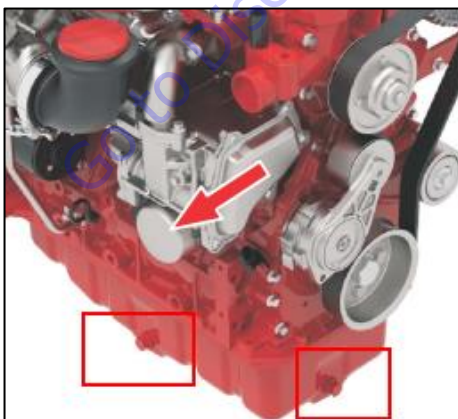

Figure 1-8 Oil filter and oil drain plug

Replacement of the Engine Oil Filter

The engine oil filter element must also be replaced every time the engine oil is replaced.

⚠ Never fill the filter in advance.

There is risk of contamination.

- 1) If a torsion stopper is installed, remove the clamping clamp (optional).
- 2) Release and unscrew the filter element with a wrench.
- 3) Contain the oil that was drained.
- 4) Clean the sealing surface of the filter holder with a clean fiber-free wiper.
- 5) Apply a thin layer of engine oil to the seal ring of the new filter.
- 6) Screw in a new filter manually until seal fit and tighten it with 10-12 Nm.

1.9 Check for Fuel Leakage

⚠ The engine must be shut down!

No smoking and open fires!

Be careful when contacting high temperature fuel!

Please observe the safety regulations for fuel and relevant local regulations. Dispose of spilled fuel and filter elements in accordance with national regulations. The fuel cannot seep into the ground.

Visually check for fuel leakage every 8 hours or every day.

⚠ There is danger of explosion and

fire. The fuel of the engine is combustible. Check the position of the machine. When this step is performed, the machine should be in a well-ventilated area away from the heater, spark, flame, and burning tobacco. A qualified fire extinguisher shall be placed in an easily accessible place.

 **There is danger of explosion and fire. If fuel leaks, prevent any additional person from entering the area or operating the equipment. Repair the leakage immediately.**

1.10 Vent Fuel Pre-Filter

 **Risk of explosion and fire. Engine**

fuel is combustible. The position where the equipment is located shall be inspected. When the step is executed, equipment shall be located in an open and well-ventilated area that keeps away from the heater, spark, flame and burning tobacco. A qualified fire extinguisher shall be placed at the location that is easily accessible.

 **Perform the step when the engine**

flames out.

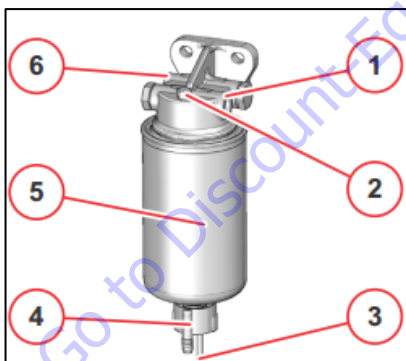

Figure 1-9

1. Fuel supply flow to the pump
2. Venting screw
3. Electrical connection for water level sensor
4. Drain plug
5. Filter insert
6. Fuel inlet from the fuel tank

Check and drain the fuel filter every 8 hours or

every day.

- 1) Shut down the engine, and find the fuel filter.
- 2) Disconnect cable connection.
- 3) Loosen the drainage plug located at the bottom of the filter cartridge, allowing the water drained to an appropriate container. Once any fuel starts to flow out, screw down the drainage plug immediately.
- 4) Wipe up any fuel that may be splashed.
- 5) Start the engine from the ground control and inspect whether or not there is leakage in the fuel filter.

Change the fuel pre-filter insert

- 1) Switch off the engine.
- 2) Shut off the fuel supply to the engine (with high-level tank).
- 3) Place suitable collecting containers underneath.
- 4) Disconnect cable connections.
- 5) Loosen drain plug and drain liquid.
- 6) Disassemble filter insert.
- 7) Clean any dirt of the opposite side of filter head.
- 8) Wet the sealing surfaces of the filter cartridge slightly with fuel and screw back on to the filter head, clockwise (17-18 Nm).
- 9) Mount drain plug.
- 10) Open the fuel shutoff tap and vent the system, see venting the fuel system.

Vent the fuel system

The fuel system is vented via the electric fuel supply pump.

In order to ensure that no error messages are generated, no attempt should be made to start the system up whilst venting.

This process is carried out as follows:

- Ignition "ON"

The electronic fuel supply pump switches on for 20 seconds in order to vent the fuel system and build up the required fuel pressure.

Wait until the electric fuel supply pump is

disconnected from the control unit.

- Ignition "OFF"

Repeat the process at least 2 times until the fuel system is vented

⚠ Risk of explosion and fire. Where there is fuel leakage, prevent any irrelevant personnel from entering the area and strictly prohibit operating the equipment. Repair the leak immediately.

1.11 Replacement of the Fuel filter

⚠ The engine must be shut down!

No smoking and open fires!

Be careful when contacting high temperature fuel!

⚠ Do not release the injection

pipeline or the high-pressure oil pipeline when the engine is running.

⚠ Carefully clean all areas involved

in cleaning. Blow wet parts with compressed air.

⚠ Please observe the safety

regulations for fuel and relevant local regulations. Dispose of spilled fuel and filter elements in accordance with national regulations. The fuel cannot seep into the ground.

⚠ After completing the operation on

the fuel system, exhaust the system, perform the trial operation and check the seal performance.

It is available in the first 50 hours, and it will be replaced every 500 hours, or half a year, but an increase in the number of replacement filters is required for the extremely dirty work environment.

⚠ There is danger of explosion and fire. The fuel of the engine is combustible. Check the position of the machine.

When this step is performed, the machine should be in a well-ventilated area away from the heater, spark, flame, and burning tobacco.

A qualified fire extinguisher shall be placed in an easily accessible place.

⚠ Never fill the filter in advance.

There is risk of contamination.

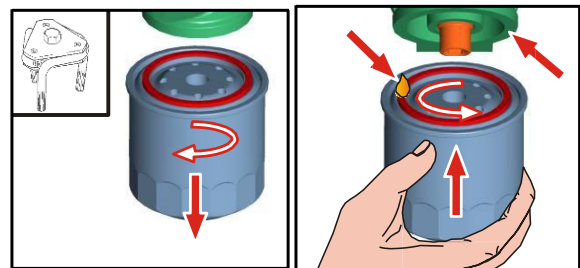

Figure 1-10

- 1) If a torsion stopper is installed, remove the clamping clamp (optional).
- 2) Release and unscrew the filter element with a wrench.
- 3) Contain the diesel fuel drained.
- 4) Clean the sealing surface of the filter holder with a clean fiber-free wiper.
- 5) Apply a thin layer of diesel to the seal ring of the new filter.

- 6) Screw in a new filter manually until seal fit and tighten it with 10-12 Nm.
- 7) Fix the clamping clamp of a torsion stopper (optional).
- 8) Exhaust the fuel system.

1.12 Check for Engine Air Filter

Check the maintenance indicator for the air filter every 8 hours or every day.

 **Perform this step when the engine is turned off.**



Figure 1-11

Check the maintenance indicator of the air filter. When the transparency of the indicator turns red, filter element needs to be maintained and cleaned or replaced.

1.13 Cleaning or Replacement of Air Filter

Clean it every 250 hours or quarterly and replaced it for every 1000 hours.

 **Do not operate on running engines!**

 **Be sure to pay attention to the cleanliness of the external surface when operating on the engine suction system, and close the suction inlet**

when necessary. The old filter elements are handled in an environmentally friendly manner.

Cleaning of air filter

 **Do not clean the filter element (4) with gasoline or high temperature liquid.**

If the primary element is stained heavily, replace it soon. At this time, replace the secondary element too.

The secondary element should be removed only if it is to be replaced.

To protect the engine, do not remove the secondary element in servicing the primary element.

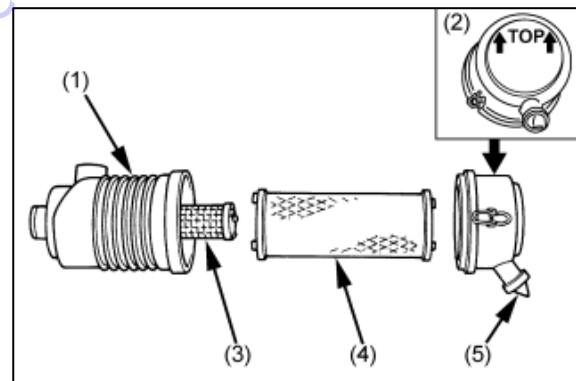

Figure 1-12

1. Air cleaner body
2. Dust cup
3. Secondary element
4. Primary element
5. Evacuator valve

Make sure the hooking clip for the element is tight enough. If it is loose, dust and dirt may be sucked in wearing down the cylinder liner and piston ring earlier and thereby resulting in poor power output.

Do not overservice the air cleaner element.

Overservicing may cause dirt to enter the engine causing premature wear. Use the dust indicator as a guide on when to service.

- 1) Open the hooking clip.
- 2) Remove the filter cover (2) and screw off the filter element (4).
- 3) Filter element (4): For slight contamination, purge with dry compressed air (maximum 205 Kpa) from inside to outside for cleaning (general cleaning times are no more than 5 times);

Replace it in case of serious contamination.

Replacement of the Safety Filter Tube of the Air Filter

 **Never clean the safety filter tube (3).**

- 1) Screw off the Primary element (4) and the Secondary element (3).
- 2) Install the new Secondary element.
- 3) Install the filter element (4), place the outer cover (2) and fix it with the hooking clip.

1.14 Check for Coolant Liquid Level

Check the coolant liquid level every 8 hours or every day.

 **The coolant at high temperature**

has the risk of scald.

The cooling system is under pressure! The cover can only be opened in the cooling state.

Coolant must have a specified concentration of cooling system protectant!

Please observe the safety regulations for coolant and relevant local regulations.

Dispose of the spilled coolant as specified, without leaving it on the ground.

Never run the engine without coolant, even if it's a very short time.

- 1) Carefully open the cover for the cooling

system.

- 2) The coolant liquid level shall always be between min and max! Fill up to the maximum liquid level if necessary.

1.15 Filling or Replacement of Engine Coolant

Replace it every 2,000 hours or two years.

 **The coolant at high temperature has the risk of scald.**

The cooling system is under pressure! The cover can only be opened in the cooling state.

Coolant must have a specified concentration of cooling system protectant!

Please observe the safety regulations for coolant and relevant local regulations.

Dispose of the spilled coolant as specified, without leaving it on the ground.

Never run the engine without coolant, even if it's a very short time.

Draining of the Cooling System

- 1) Carefully open the cooler cover.
- 2) Place the receiving container under the coolant interface.
- 3) Drain the coolant.
- 4) Reconnect and tighten the coolant interface.
- 5) Close the cooler cover.

Filling of the Coolant

- 1) Carefully open the cover for the cooling system.
- 2) Loosen the cooler exhaust bolts that may be present.
- 3) Fill the coolant to max or the filling limit position.
- 4) Open the possible heater and switch to the maximum gear, to fill the heating circuit and exhaust.
- 5) Close the cooler cover.

- 6) Run the engine to the running temperature.
- 7) Shut down the engine.
- 8) Check the coolant liquid level when the engine is cooled, and fill it to max if necessary.

! Note: The coolant with different

freezing point should be selected according to the local ambient temperature, the principle is that the freezing point of coolant is 10°C-15°C lower than the local minimum temperature.

1.16 Check for Engine Belt

Check it every 8 hours or every day.

! Only when the engine is stationary

can the belt drive operation be carried out.

! There is danger of burn. Be

cautious of high-temperature engine components. Contact with them may cause serious burn.

Belt Check

- 1) Visually inspect whether all belt drives for damage.
- 2) Replace damaged components.
- 3) Reinstall the protector if necessary.
- 4) When it is a new belt, check whether the position is correct. After running for 15 minutes, check the tension.

Replacement of belt

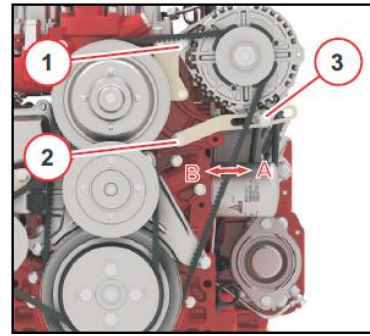

Figure 1-13

- 1) Loosen bolts (1,2,3) and nuts.
- 2) Move the engine in direction B, until the belt is loose.
- 3) Remove the old belt, and install a new one.
- 4) Move the engine in direction A until the correct belt tension is reached.
- 5) Check the belt tension.
- 6) Tighten the bolts and nuts.

Tightening torque

Screw 1 42 Nm

Screw 2 30 Nm

Screw 3 M8 30 Nm

Screw 3 M10 42 Nm

1.17 Regular Maintenance

Maintenance items with period of a quarter, a year, and two years must be completed by qualified staff upon training in maintenance of the machine in accordance with procedures in the machine maintenance manual. For machines that are idle for more than three months, quarterly check must be performed before they can be re-used.

1.18 Inspecting the battery

! Danger: Explosion Danger!

Electric Shock Danger! Burn Danger!

Keep away from fire, remove all rings, watches and other jewelry. If necessary, wear goggles, protective gloves and

protective clothing. Avoid contacting overflowed electrolyte, and neutralize any overflowed electrolyte with sodium bicarbonate solution.



It is crucial for machine performance and security-related operations to keep the battery in proper condition. Improper voltage or damaged cables and wires may cause damage to components and danger. Inspect the battery every 8 hours or daily.

- Ensure the battery hold down hardware is secure.
- Inspect the battery cables for corrosion.
- Inspect for fluid leaks, and whether or not the battery is dry and clean.
- As shown in Figure 1-14, inspect the color of the battery hydrometer (if applicable):

Hydrometer Color	Meaning and Handling Method
White	Lack of battery fluid, please shut down the machine, and stop using
Black	Lack of electricity
Green	Measure the voltage of each battery, and voltage lower than 11V indicates damage to battery; and voltage between 12.4V and 12.7V indicates that the battery is in good state

Table 11-1 Color and description of hydrometer color

- If the battery hydrometer's color is green, and voltage is more than 12V, but cannot drive the starter, further check the battery circuits by

personnel with machine maintenance training and certified to perform such work.

⚠ Caution: If charging the battery with an external power supply, only use a charger accepted by LGMG North America.

11.9 Periodic maintenance

- 1) Maintenance items every quarter, every year and every two years must be performed by personnel with machine maintenance training and certified to perform such work.
- 2) A machine not used for a time exceeding three months must not be put into use again until a quarterly inspection and maintenance have been performed.



Figure 1-14 Battery hydrometer

1.19 Engine fault table

Faults	Cause	Measures
Engine does not start or is difficult to start	Not disconnected (if possible)	Check coupling
	Fuel tank empty	Tanks
	Fuel suction pipe blocked	Check
	Below starting limit temperature	Check
	Cold starting device	Check/replace
	Wrong SAE viscosity class of the engine lubricating oil	Change the lubricating oil
	Fuel quality does not comply with operating manual	Change the fuel
	Battery defective or discharged	Check battery
	Cable connection to starter loose or oxidized	Check cable connections
	Starter defective or pinion does not engage	Check starter
	Air filter clogged / turbocharger defective	Check/replace
	Air in fuel system	Vent fuel system
	Compression pressure too low	Check compression pressure
	Exhaust gas backpressure too high	Check
	Injection line leaks	Check injection line
High-pressure pump defective	Check/replace	
Engine does not start and diagnostic lamp flashes	Engine electronics prevents starting	Check error according to error code and eliminate error if necessary
Engine starts, but runs irregularly or fails	Exhaust gas backpressure too high	Check
	Compression pressure too low	Check compression pressure
	Cold starting device	Check/replace
	Air in fuel system	Vent
	Fuel filter contaminated	Clean
	Fuel quality does not comply with operating manual	Change the fuel
	Injector defective	Change
	Injection line leaks	Check injection line
	Engine cable harness defective	Check/replace
Speed changes are possible and diagnostic lamp lights up	Engine electronics has detected a system error and activates an equivalent speed	Check error according to error code and eliminate error if necessary
Engine becomes excessively hot. Temperature warning system activates	Vent line blocked	Clean
	Lube oil cooler defective	Check/replace
	Lube oil filter contaminated on the air or lube oil side	Change
	Lube oil level too high	Check lube oil level, if necessary drain off.
	Lubricating oil level too low	Fill up lube oil
	Injector defective	Change

	Coolant heat exchanger soiled	Clean
	Defective cooling water pump (torn or loose V-belt)	Check whether torn or loose
	Low coolant	Fill up
	Resistance in cooling system is too high / flow volume too low	Check the cooling system
	Fan / viscous coupling defective, V-belt torn or loose	Check/replace/tension
	Charge air line leaking	Check charge air line
	Charge air cooler soiled	Check/clean
	Air filter clogged / turbocharger defective	Check/replace
	Air filter maintenance switch / maintenance indicator defective	Check/replace
	Fan defective/V-rib belt torn or loose	Check fan/V-belt, change if necessary
	Exhaust gas backpressure too high	Check
	Throttle valve defective	Check/replace
	Coolant temperature transmitter	Check/replace
	Coolant thermostat defective	Check/replace
	Coolant cover defective	Check/replace
Engine output is deficient	Lube oil level too high	Check lube oil level, if necessary drain off.
	Fuel suction temperature too high	Check the system
	Fuel quality does not comply with operating manual	Change the fuel
	Air filter clogged / turbocharger defective	Check/replace
	Air filter maintenance switch / maintenance indicator defective	Check/replace
	Fan defective/V-rib belt torn or loose	Check fan/V-belt, change if necessary
	Charge air line leaking	Check charge air line
	Charge air cooler soiled	Clean
	Injection line leaks	Check injection line
	Injector defective	Change
	Throttle valve defective	Check/replace
	Exhaust gas recirculation, actuator defective	Check/replace
	Exhaust gas backpressure too high	Check/clean
	Exhaust gas turbocharger defective	Change
Engine performs poorly and diagnostic lamp lights	Engine electronics reduce performance	Please contact your LGMG partner
Engine does not run on all cylinders	Injection line leaks	Check injection line
	Injector defective	Change
	Compression pressure too low	Check compression pressure
	Engine cable harness defective	Check/replace
Engine lubricating oil pressure is nonexistent or excessively low	Lubricating oil level too low	Fill up lube oil
	Excessive inclination of engine	Check engine mounting / reduce

		inclination
	Wrong SAE viscosity class of the engine lubricating oil	Change the lubricating oil
	Lubricating oil pressure sensor defective	Check/replace
	Lubricating oil control valve jammed	Check/clean
	Lubricating oil suction pipe blocked	Check/clean
Engine lubricating oil consumption excessive	Lube oil level too high	Check lube oil level, if necessary drain off
	Excessive inclination of engine	Check engine mounting / reduce inclination
	Crankcase breather	Check/replace
Lubricating oil in the exhaust system	Engine operated continuously with too low a load (< 20-30%)	Check load factor
	Valve shaft seals defective	Check/replace
	Exhaust gas turbocharger defective	Check/replace
Engine producing blue smoke	Lube oil level too high	Check lube oil level, if necessary drain off
	Excessive inclination of engine	Check engine mounting / reduce inclination
Engine producing white smoke	Fuel quality does not comply with operating manual	Change the fuel
	Injector defective	Change
	Condensation	Warm up engine so that water residues evaporate
Engine producing black smoke	Air filter clogged / turbocharger defective	Check/replace
	Air filter maintenance switch / maintenance indicator defective	Check/replace
	Charge air line leaking	Check charge air line
	Injector defective	Change
Engine shutdown frequently	Air filter clogged / turbocharger defective	Check/replace
	Charge air line leaking	Check charge air line
	Injector defective	Change
	Differential pressure of flow meter defective	Change
	Nox sensor defective	Change
	Differential pressure sensor of diesel particulate filter is issuing an implausible signal	Change
	Differential pressure line added	Clean

1.20 Engine fault Codes

KWP-Code	SPN	FMI	Error Identification
45	168	3	Battery voltage: The voltage measured by ECU is out of the target range, system reaction is initiated.
46	168	4	Battery voltage: The voltage measured by ECU is out of the target range, system reaction is initiated.
47	168	2	Battery voltage: The voltage measured by ECU is out of the target range, system reaction is initiated.
84	639	14	CAN bus 0: The ECU is not allowed to send messages because the status "BusOff" is detected.
85	1231	14	CAN-Bus 1: The ECU is not allowed to send messages, because the status "BusOff" is detected. Warning, no diagnostic with SERDIA2010 is possible.
88	102	2	Charge air pressure measured by sensor is above the warning threshold.
89	102	2	Charge air pressure measured by sensor is above shut off threshold.
92	110	0	Coolant temperature sensor: The voltage of the sensor measured by ECU is out of the target range
93	110	1	Coolant temperature sensor: The voltage of the sensor measured by ECU is out of the target range.
96	110	3	Coolant temperature sensor: The voltage of the sensor measured by ECU is out of the target range (Signal range check high).
97	110	4	Coolant temperature sensor: The voltage of the sensor measured by ECU is out of the target range (signal range check low).
98	110	0	Coolant temperature: The coolant temperature calculated by ECU is above the target range; The ECU activates a system reaction.
99	110	0	Coolant temperature: The coolant temperature calculated by ECU is above the target range. The ECU activates a system reaction.
101	111	1	Coolant level: The coolant level calculated by ECU is below the allowed minimum
126	523603	9	Timeout Error of CAN-receive-frame AMB; Ambient temperature sensor
171	523212	9	Timeout error of CAN-Receive-Frame ComEngPrt. Engine Protection.
179	523240	9	Timeout CAN-message FunModCtl. Function Mode Control.
291	523776	9	Timeout error of CAN-Receive-Frame TSC1TE - active
292	523777	9	Passive timeout error of CAN-Receive-Frame TSC1TE. Setpoint
305	898	9	Timeout error of CAN-Receive-Frame TSC1TE. Setpoint
360	523982	0	Powerstage diagnosis disabled. High battery voltage.
361	523982	1	Powerstage diagnosis disabled. Low battery voltage
362	523090	2	When any of the switch inputs is not active for a period of time.
376	630	12	Internal hardware monitoring, the ECU finds an error during the access to its EEPROM memory or works with an alternative value
377	630	12	Internal hardware monitoring: The ECU finds an error during the access to its EEPROM memory or works with an alternative value

378	630	12	Internal hardware monitoring: The ECU finds an error during the access to it's EEPROM memory or works with an alternative value
387	523612	12	Internal hardware monitoring: The CPU of the ECU is set to RESET and the cause is logged internally. No item will be created in error memory
388	190	0	Engine speed: The engine speed calculated by ECU is above the target range.
389	190	0	Engine speed: The engine speed calculated by ECU is above the target range. The ECU activates a system reaction.
390	190	11	Engine speed: The engine speed calculated by ECU is above the target range. The ECU activates a system reaction
391	190	14	Engine speed: The engine speed calculated by ECU is above the target range. The ECU activates a system reaction.
419	190	8	Camshaft speed sensor: The ECU receives no signal and uses the signal from crankshaft speed sensor as alternative to calculate the engine speed.
420	190	12	Camshaft speed sensor: The ECU receives no signal and uses the signal from camshaft speed sensor as alternative to calculate the engine speed.
420	190	2	Offset angle between crank- and camshaft-sensor is too large
422	190	8	Sensor crankshaft detection. Out of range, signal disrupted or no signal
423	190	12	Crankshaft speed sensor: The ECU receives no signal and uses the signal from camshaft speed sensor as alternative to calculate the engine speed
457	975	3	PWM-Signal fan, short-circuit to battery.
464	97	3	Fuel filter water level sensor: The sensor voltage measured by ECU is out of the target range
465	97	4	Fuel filter water level sensor: The voltage of sensor measured by ECU is out of the target range
472	94	3	Low fuel pressure sensor: The voltage of sensor measured by ECU is out of the target range
473	94	4	Low fuel pressure sensor: The voltage of sensor measured by ECU is out of the target range
474	94	1	Low fuel pressure: The low fuel pressure calculated by ECU is underneath the target range. The ECU activates a system reaction
475	94	1	Low fuel pressure, shut off threshold exceeded.
547	729	12	The cold start aid relay is overheated.
559	523895	13	Check of missing injector adjustment value programming (IMA) injector 1.
560	523896	13	Check of missing injector adjustment value programming (IMA) injector 2.
561	523897	13	Check of missing injector adjustment value programming (IMA) injector 3
564	523900	13	Check of missing injector adjustment value programming (IMA) injector 6
565	523350	4	Injector cylinder bank 1: The current drop measured by ECU is above the target range
566	523352	4	Injector cylinder bank 2: The current drop measured by ECU is above the target range.
567	523354	12	Internal hardware monitoring: The ECU detects an error of its injector high current output
568	651	5	Injector cylinder 1: Interruption of electrical connection

569	652	5	Injector cylinder 2: Interruption of electrical connection
570	653	5	Injector cylinder 3: interruption of electrical connection
571	654	5	Injector cylinder 4: Interruption of electrical connection
572	655	5	Injector cylinder 5: interruption of electrical connection
573	656	5	Injector cylinder 6: Interruption of electrical connection.
580	651	3	Injector cylinder 1: The current drop measured by ECU is above the target range
581	652	3	Injector cylinder 2: The current drop measured by ECU is above the target range
582	653	3	Injector cylinder 3: The current drop measured by ECU is above the target range
583	654	3	Injector cylinder 4: The current drop measured by ECU is above the target range
584	655	3	Injector cylinder 5: The current drop measured by ECU is above the target range
585	656	6	Injector cylinder 6: The current drop measured by ECU is above the target range.
592	523615	5	Detecting an open load fault in the metering unit of the fuel system
594	523615	3	Fuel metering unit: The current drain measured by ECU is above the target range
595	523615	4	Fuel metering unit: The current drain measured by ECU is above the target range
596	523615	3	Fuel metering unit: The current drain measured by ECU is above the target range
597	523615	4	Fuel metering unit: The current drain measured by ECU is above the target range
612	523612	12	Internal hardware monitoring: the CPU of the ECU is reset and the cause is logged internally; no item will be created in error memory
613	523612	12	ECU reported internal software error Internal ECU monitoring detection reported error
614	523612	12	Internal hardware monitoring: the CPU of the ECU is reset and the cause is logged internally; no item will be created in error memory
619	523612	12	Internal hardware monitoring: the CPU of the ECU is reset and the cause is logged internally; no item will be created in error memory
625	523612	12	Internal hardware monitoring: the CPU of the ECU is reset and the cause is logged internally; no item will be created in error memory
637	523612	12	Engine speed: the engine speed calculated by ECU is above the target range; the ECU activates a system reaction
732	100	3	Oil pressure sensor: the voltage of sensor measured by ECU is out of the target range
733	100	4	Oil pressure sensor: the voltage of sensor measured by ECU is out of the target range
734	100	0	High oil pressure; warning threshold exceeded
735	100	0	High oil pressure; shut off threshold exceeded
736	100	1	Oil pressure is below the target range (warning threshold)
737	100	1	Oil pressure is below the target range (shut off threshold)
746	175	0	High oil temperature; shut off threshold exceeded
747	1237	2	Override switch: the ECU receives a permanent signal.
752	107	0	Air filter differential pressure: the pressure difference of the intake air between the filter inlet and outlet calculated by ECU is above the target range and the ECU activates a

			system reaction
776	102	3	Charge air pressure sensor: the measured voltage of sensor by ECU is out of the target range
777	102	4	Charge air pressure sensor: the measured voltage of sensor by ECU is out of the target range
825	523009	9	The pressure relief valve (PRV) has reached the number of allowed activations.
826	523470	2	Pressure relief valve is forced to open, perform pressure increase
827	523470	2	Pressure Relief Valve (PRV) forced to open. Performed by pressure increase.
828	523470	12	Pressure Relief Valve (PRV) forced to open. Shutoff conditions.
829	523470	12	Pressure Relief Valve (PRV) forced to open. Warning conditions.
830	523470	14	Open Pressure Relief Valve (PRV)
831	523470	11	Rail pressure relief valve can not be opened due to the railpressure.
832	523470	11	Rail pressure out of tolerance range. The PRV can not be opened at this operating point with a pressure shock.
833	523009	10	The pressure relief valve (PRV) has reached the allowed opening time
834	523906	5	ECU detects open load on the electric fuel feed pump output
835	523906	12	ECU detects too high temperature in powerstage of fuel pump circuit.
836	523906	3	ECU detects shortcut to battery in fuel feed pump circuit.
837	523906	4	Electrical fuel pre - supply pump. Short circuit to ground.
856	523613	0	Rail pressure below setpoint, speed-dependent threshold exceeded. The rail pressure is below the target range, which is determined as a function of the engine speed.
857	523613	0	Rail pressure below setpoint, threshold exceeded
858	523613	0	Rail pressure: the fuel pressure in rail calculated by ECU is above the target range which is dependant on the engine speed
859	523613	0	Rail pressure: the fuel pressure in rail calculated by ECU is below the target range which is dependant on the engine speed.
861	523613	1	Rail pressure: the fuel pressure in rail calculated by ECU is below the target range which is dependant on the engine speed
862	523613	0	Rail pressure: the fuel pressure in rail calculated by ECU is above the target range.
864	523613	2	Rail pressure metering unit, Setpoint of metering unit in overrun mode not plausible.
876	523470	7	Rail pressure is out of the expected average range.
877	157	3	Rail pressure sensor: the voltage of sensor measured by ECU is out of the target range
878	157	4	Rail pressure sensor: the voltage of sensor measured by ECU is out of the target range
932	29	3	Analog accelerator pedal 2 (hand pedal): the voltage measured by ECU is out of the target range.
935	91	3	Analog accelerator pedal sensor 1 or double accelerator pedal sensor: the voltage measured by ECU is out of the target range or the calculated pedal position is implausible compared with the position of the second pedal
937	29	4	Handthrottle; short circuit to ground

940	91	4	Sensor error accelerator pedal. Signal is below the range
946	1079	13	Internal hardware monitoring: the ECU detects a deviation of the target range of the power supply voltage of sensor output 1
947	1080	13	Internal hardware monitoring: the ECU detects a deviation of the target range of the power supply voltage of sensor output 2
948	523601	13	Internal hardware monitoring: the ECU detects a deviation of the target range of the power supply voltage of sensor output 3
956	677	3	Start relay (high side power stage): the current drop measured by ECU is above the target range.
957	677	4	Start relay (high side power stage): the current drain measured by ECU is above the target range
958	677	5	Start relay (low side power stage): the current drop measured by ECU is above the target range
959	677	12	Start relay (low side power stage): the current drop measured by ECU is above the target range
960	677	3	Start relay (low side power stage): the current drain measured by ECU is above the target range
961	677	4	Starter relay low side short circuit to ground
973	523612	14	Internal hardware monitoring: the CPU of the ECU is reset and the cause is logged internally; no item will be created in error memory
974	523612	14	Internal hardware monitoring: the CPU of the ECU is reset and the cause is logged internally; no item will be created in error memory.
975	523612	14	Internal hardware monitoring: the CPU of the ECU is reset and the cause is logged internally; no item will be created in error memory
976	91	11	Diagnostic fault check of synchronism of single potentiometer and Low idle switch(LIS).
978	29	2	Plausibility error between sensor and idle switch, Acceleration Pedal Detection. In case of Hand Throttle with Low Idle Switch, it is the plausibility check between hand throttle and idle switch
980	523550	12	Terminal 50 was operated for more than 2 minutes. This may happen due to short to battery or wrong usage of Terminal 50. Starter control is disabled until this error is healed.
994	105	3	Electrical error charged air temperature. Signal range check high.(SRC)
995	105	4	Electrical error charged air temperature. Signal range check low
996	105	0	Charged air cooler temperature. System reaction initiated. High charged air cooler temperature. Warning threshold exceeded.
997	105	0	Charge air temperature downstream calculated by ECU is over the shut off threshold. The ECU activates a system reaction.
1016	51	7	Actuator position for EGR valve is not plausible, internal error, angular misalignment of the flap
1024	51	3	Actuator of the external EGR valve: the ECU detects a short circuit to battery or open load
1025	51	4	Actuator of the external EGR valve: the ECU detects a short circuit to ground
1157	97	12	Water in fuel level prefilter; maximum value exceeded
1170	523612	12	Internal hardware monitoring: the CPU of the ECU is reset and the cause is logged internally; no item will be created in error memory

1180	168	0	Physical range check high for battery voltage
1181	168	1	Physical range check low for battery voltage
1223	51	5	Actuator EGR-Valve: Open load on ECU output is detected
1224	51	6	Actuator EGR-valve: too high current is going into the actuator. Output is switched off
1226	51	3	Actuator EGR-valve: short cut to battery is detected
1227	51	3	Actuator EGR-valve: short cut to battery on ECU pin is detected
1228	51	4	Actuator EGR-valve: short cut to ground on ECU pin is detected
1229	51	4	EGR-Valve (2.9;3.6) or Throttle-Valve (4.1;6.1;7.8); short circuit to ground
1230	51	6	Actuator error EGR-Valve (2.9;3.6) or Throttle-Valve (4.1;6.1;7.8); Overload by short-circuit
1231	51	11	Power stage overtemperature due to high current.
1232	51	4	actuator AGR valve (2.9;3.6) throttle valve (4.1;6.1;7.8); Voltage below threshold
1505	524057	2	Fuel low pressure pump; error pressure build up
1668	524105	9	Timeout error of CAN-Transmit-Frame ComEGRMsFlw (EGR Steller)
1669	524108	9	Timeout error of CAN-Transmit-Frame ComEGRTVActr (EGR actuator)
1670	524110	9	Timeout error of CAN-Transmit-Frame ComETVActrTO.
1671	524112	9	Timeout ComIntake Throttle Valve Actr.
1677	524106	9	Timeout error of CAN-Receive-Frame ComRxEGRMsFlw1 (EGR actuator)
1678	524107	9	Timeout error of CAN-Receive-Frame ComRxEGRMsFlw2 (EGR actuator)
1679	524109	9	Timeout error of CAN-Receive-Frame ComRxEGRTVActr (EGR actuator)
1680	524111	9	Timeout error of CAN-Receive-Frame ComRxETVActr
1681	524113	9	Timeout error of CAN-Receive-Frame ComRxITVActr
1683	524121	9	Timeout error of CAN-Receive-Frame ComRxTrbChActr (wastegate actuator)
1687	524125	9	Timeout error of CAN-Receive-Frame ComTxTrbChActr (Wastegate actuator)

Chapter 2 Schematics

Go to Discount-Equipment.com to order your parts

Electric schematic-T65J

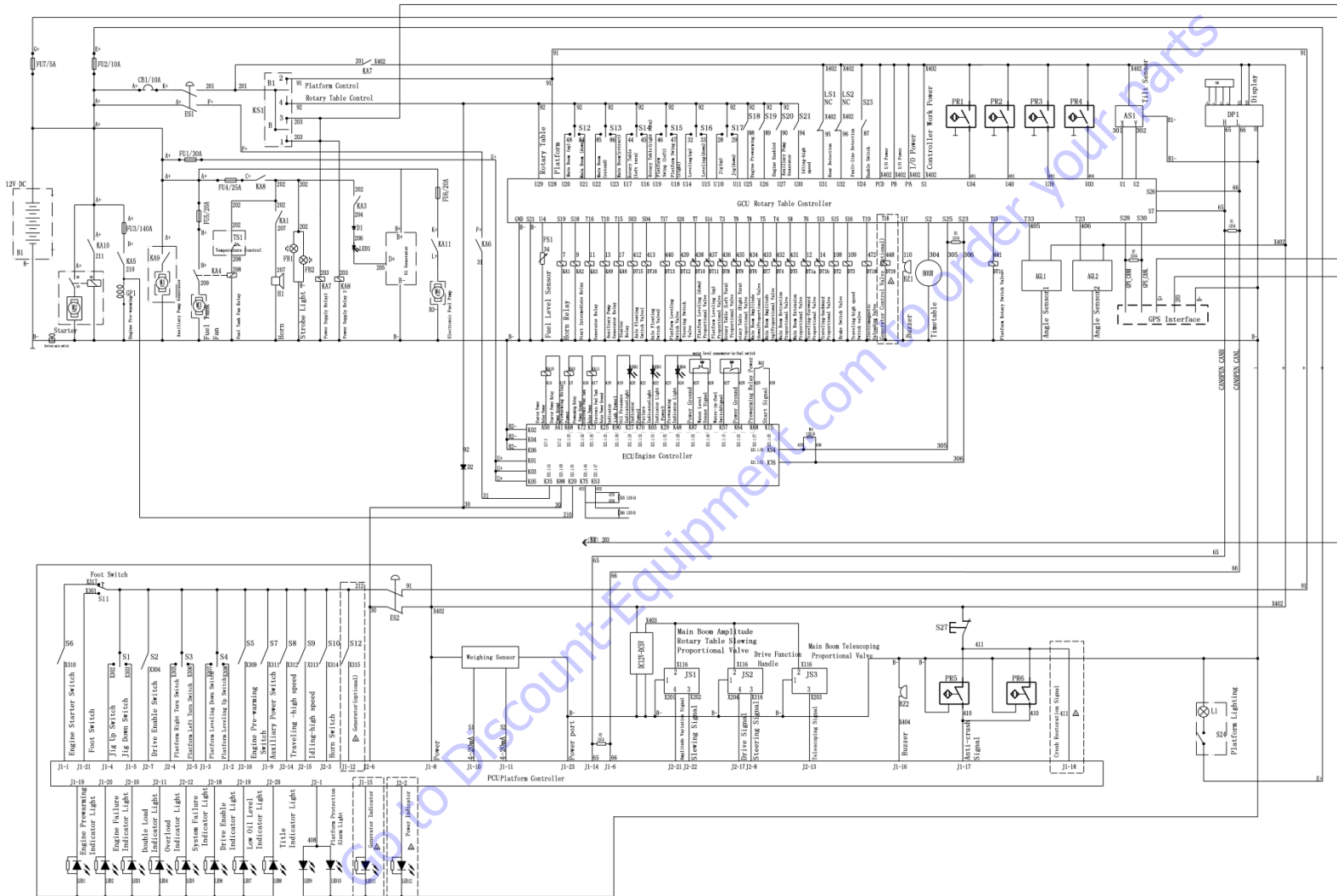

Electric schematic-T85J

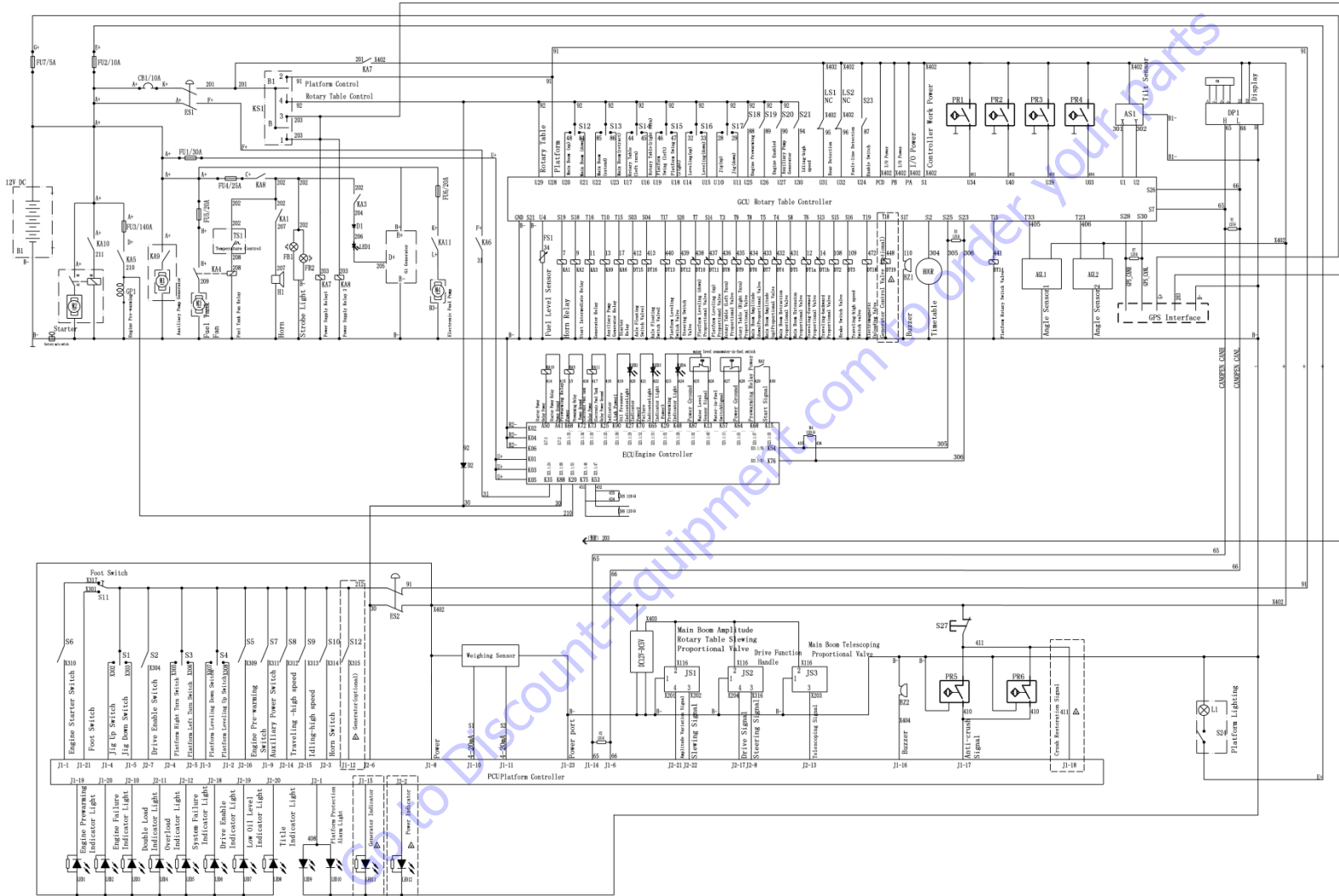

Hydraulic schematic-T65J

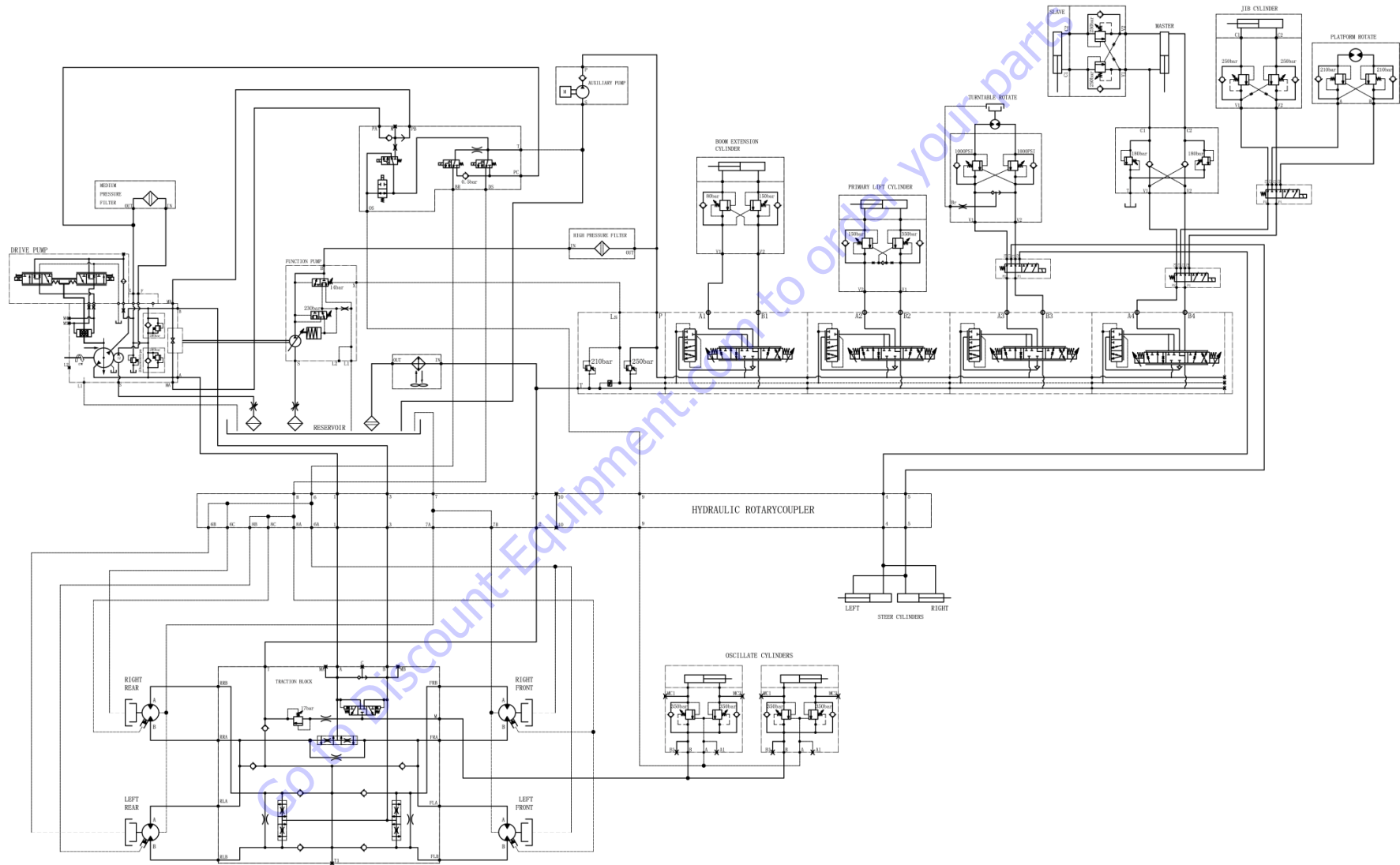

Hydraulic schematic-T85J

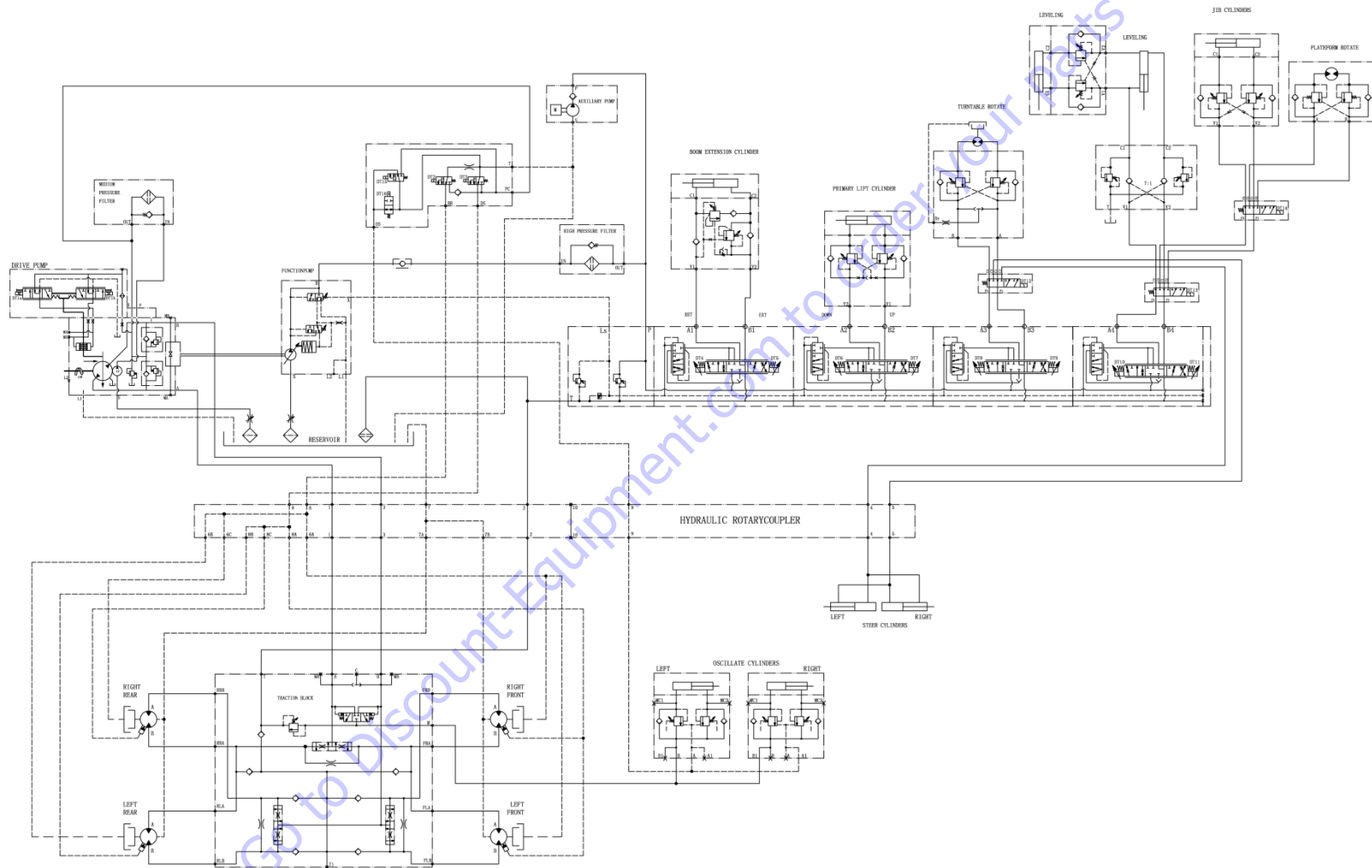

California Proposition 65

 **WARNING**

Operating, servicing and maintaining this equipment can expose you to chemicals including engine exhaust, carbon monoxide, phthalates, and lead, which are known to the State of California to cause cancer and birth defects or other reproductive harm. These chemicals can be emitted from or contained in other various parts and systems, fluids and some component wear by-products. To minimize exposure, avoid breathing exhaust, do not idle the engine except as necessary, service your equipment and vehicle in a well-ventilated area and wear gloves or wash your hands frequently when servicing your equipment or vehicle and after operation. For more information go to www.P65Warnings.ca.gov/passenger-vehicle.

Breathing diesel engine exhaust exposes you to chemicals known to the State of California to cause cancer and birth defects or other reproductive harm.

- Always start and operate the engine in a well-ventilated area.
- If in an enclosed area, vent the exhaust to the outside.
- Do not modify or tamper with the exhaust system.
- Do not idle the engine except as necessary.

For more information go to www.P65warnings.ca.gov/diesel.

PARTS FINDER

**Search Website
by Part Number**



**Search Manual
Library For Parts
Manual & Lookup Part
Numbers – Purchase
or Request Quote**

Search Manuals

Enter your information to search for manuals and parts.

* Brand:

* Model:

* Serial:

* Part Number:

SEARCH

**Can't Find Part or
Manual? Request Help
by Manufacturer,
Model & Description**

Parts Order Form

Please fill in the following information:

Manufacturer:

Model:

Description:

Quantity:

Part Number:

Part Name:

Part Description:

Part Location:

Part Condition:

Part Status:

Part Price:

Part Weight:

Part Dimensions:

Part Material:

Part Color:

Part Finish:

Part Notes:

Submit

Discount-Equipment.com is your online resource for quality parts & equipment.

Florida: **561-964-4949** Outside Florida TOLL FREE: **877-690-3101**

Need parts?

Click on this link: <http://www.discount-equipment.com/category/5443-parts/> and choose one of the options to help get the right parts and equipment you are looking for. Please have the machine model and serial number available in order to help us get you the correct parts. If you don't find the part on the website or on once of the online manuals, please fill out the request form and one of our experienced staff members will get back to you with a quote for the right part that your machine needs.

We sell worldwide for the brands: Genie, Terex, JLG, MultiQuip, Mikasa, Essick, Whiteman, Mayco, Toro Stone, Diamond Products, Generac Magnum, Airman, Haulotte, Barreto, Power Blanket, Nifty Lift, Atlas Copco, Chicago Pneumatic, Allmand, Miller Curber, Skyjack, Lull, Skytrak, Tsurumi, Husquvarna Target, , Stow, Wacker, Sakai, Mi-T- M, Sullair, Basic, Dynapac, MBW, Weber, Bartell, Bennar Newman, Haulotte, Ditch Runner, Menegotti, Morrison, Contec, Buddy, Crown, Edco, Wyco, Bomag, Laymor, Barreto, EZ Trench, Bil-Jax, F.S. Curtis, Gehl Pavers, Heli, Honda, ICS/PowerGrit, IHI, Partner, Imer, Clipper, MMD, Koshin, Rice, CH&E, General Equipment, ,AMida, Coleman, NAC, Gradall, Square Shooter, Kent, Stanley, Tamco, Toku, Hatz, Kohler, Robin, Wisconsin, Northrock, Oztec, Toker TK, Rol-Air, Small Line, Wanco, Yanmar



www.Discount-Equipment.com

T65J/T85J
Mobile Elevating Work Platform
Maintenance Manual

Fourth Edition – June 2021



LGMG North America Inc.