



LGMG North America Inc.



www.Discount-Equipment.com

Operation and Safety Manual

T65J/T85J

Mobile Elevating Work Platform

ANSI



WARNING

Before operation and maintenance, the drivers and service personnel shall always read and thoroughly understand all information in this manual. Failure to do so may result in, fatal accidents or personal injury.

This manual must be kept with this machine at all times.

TO PURCHASE THIS PRODUCT PLEASE CONTACT US



**Equipment Financing and
Extended Warranties Available**



**Discount-Equipment.com is your online resource for
commercial and industrial quality parts and equipment sales.**

561-964-4949

visit us on line @ www.discount-equipment.com

Select an option below to find your Equipment

Search by Manufacturer

Search by Product Type

Request a Quote

We sell worldwide for the brands: Genie, Terex, JLG, MultiQuip, Mikasa, Essick, Whiteman, Mayco, Toro Stone, Diamond Products, Generac Magnum, Airman, Haulotte, Barreto, Power Blanket, Nifty Lift, Atlas Copco, Chicago Pneumatic, Allmand, Miller Curber, Skyjack, Lull, Skytrak, Tsurumi, Husquvarna Target, Stow, Wacker, Sakai, Mi-T-M, Sullair, Basic, Dynapac, MBW, Weber, Bartell, Bennar Newman, Haulotte, Ditch Runner, Menegotti, Morrison, Contec, Buddy, Crown, Edco, Wyco, Bomag, Laymor, EZ Trench, Bil-Jax, F.S. Curtis, Gehl Pavers, Heli, Honda, ICS/PowerGrit, IHI, Partner, Imer, Clipper, MMD, Koshin, Rice, CH&E, General Equipment, Amida, Coleman, NAC, Gradall, Square Shooter, Kent, Stanley, Tamco, Toku, Hatz, Kohler, Robin, Wisconsin, Northrock, Oztec, Toker TK, Rol-Air, APT, Wylie, Ingersoll Rand / Doosan, Innovatech, Con X, Ammann, Mecalac, Makinex, Smith Surface Prep, Small Line, Wanco, Yanmar

Contents

Contents.....	I
Chapter 1 Safety	1
1.1 Danger.....	3
1.2 Before operating the machine, please ensure that:.....	3
1.3 Classification of dangers.....	3
1.4 Purpose	3
1.5 Maintenance of safety signs	4
1.6 Danger of electric shock	4
1.7 Danger of tilting	4
1.8 General safety	6
1.9 Danger of operating the machine on slopes.....	6
1.10 Danger of falling.....	6
1.11 Danger of collision	7
1.12 Dangers of explosion and fire	7
1.13 Danger of damage to the machine.....	8
1.14 Danger of body injury.....	8
1.15 Battery safety.....	8
Chapter 2 Legend	9
Chapter 3 Labels.....	13
Chapter 4 Machine Specifications	19
Chapter 5 Control Box.....	29
5.1 Lower control box	31
5.2 Upper control box	34
Chapter 6 Pre-operational Check	39

6.1 Before operating the machine, please ensure that:.....	41
6.2 Basic principles.....	41
6.3 Pre-operational check.....	41
Chapter 7 Workplace Inspection	43
7.1 Basic principles.....	45
7.2 Workplace inspection.....	45
Chapter 8 Functional Test	47
8.1 Basic principles.....	49
8.2 At the ground controller.....	49
8.3 On the platform.....	49
Chapter 9 Operation Instructions.....	53
9.1 Basic principles.....	55
9.2 Starting up the engine.....	55
9.3 Emergency shutdown	55
9.4 Auxiliary power	55
9.5 Operating the machine on ground.....	56
9.6 Operating the machine on the platform	56
9.7 Platform overload.....	58
9.8 Non-level state of the machine.....	58
9.9 System fault.....	58
9.10 Upon every use.....	61
Chapter 10 Transport Description.....	63
10.1 Compliance and obedience	65
10.2 Brake release when using the capstan	65
10.3 Ensuring transport safety	65

Foreword

Thank you for choosing to use this Mobile Elevating Work Platform from LGMG North America. This machine is designed according to A92.20-2018. The information specified in this manual is intended for the safe and proper operation of this machine for its' intended purpose.

For maximum performance and utilization of this machine, thoroughly read and understand all the information in this manual before starting, operating, or performing maintenance on this machine.

Due to continuous product improvements, LGMG North America reserves the right to make specification changes without any prior notifications. For any updated information, contact LGMG North America.

Ensure all preventive maintenance to the machine is performed according to the interval specified in the maintenance schedule.

Keep this manual with this machine for reference at all times. When the ownership of this machine is transferred, this manual shall be transferred with this machine. This manual must be replaced immediately if it is lost, damaged, or becomes illegible.

This manual is copyrighted material. The reproduction or copy of this manual is not allowed without the written approval of LGMG North America.

The information, technical specifications and drawings in this manual are the latest available when this manual is issued. Due to continuous improvement, LGMG North America reserves the right to change the technical specifications and machine design without notice. If any specifications and information in the manual are not consistent with your machine, please contact the service department of LGMG North America.

WARNING

Only personnel who have been properly trained and qualified to operate or maintain this machine can operate, repair and maintain this machine.

Improper operation, maintenance, and repair are dangerous and can cause personal injury and death.

Before any operation or maintenance, the operator shall thoroughly read this manual. Do not operate, perform any maintenance or make any repairs on this machine before reading and understanding this manual.

The user shall load the platform strictly according to the load rating of the platform. Do not overload the platform or make any modifications to the platform without permission from LGMG North America.

The operation regulations and preventions in this manual are only applicable for the specified use of this machine.

Safety Precautions

The operator of this machine shall understand and follow the existing safety regulations of state and local governments. If these are unavailable, the safety instructions in this manual shall be followed.

To help prevent accidents, read and understand all warnings and precautions in this manual before operation or performing maintenance.

The safety measures are specified in Chapter 1 Safety.

It is impossible to foresee every possible hazard and the safety instructions in this manual may not cover all safety prevention measures. Always ensure the safety of all personnel and protect the machine against any damage. If unable to confirm the safety of some operations, contact LGMG North America.

The operation & maintenance prevention measures listed in this manual are only applicable to the specified uses of this machine. LGMG North America assumes no responsibility if this machine is used beyond the range of this manual. The user and the operator shall be responsible for the safety of such operations.

Do not perform any operation forbidden in this manual in any situation.

The following signal words are applicable for identifying the level of safety information in this manual.

Danger:

An imminent situation, that if not avoided, will result in severe injuries or death. This is also applicable to situations that will cause serious machine damage, if not avoided.

Warning:

A potentially dangerous situation, that if not avoided, may result in severe injuries or death. This is also applicable to situations that may cause serious machine damage, if not avoided.

Notice:

A situation, that if not avoided, may result in minor or intermediate injury. This is also applicable to situations that may cause machine damage or shorten machine service life.

Chapter 1 Safety

To order go to Discount-Equipment.com

1.1 Danger



Warning: Failure to follow the

instructions and safety rules in this manual may result in serious injury or death. Alcoholics, drug users, and those who take anti-reactive drugs are strictly prohibited from approaching and operating the machine.

1.2 Before operating the machine, please ensure that:

- 1) You are equipped with full-body protective equipment such as helmets, safety belts, safety shoes, goggles and protective gloves, and are in good physical condition.
- 2) You have understood and practiced the safety rules for machine operation in this operation manual.
- 3) You know and understand the rules for safe operation of the machine before proceeding to the next step.
- 4) You always perform pre-operational checks.
- 5) You always perform pre-use functional tests.
- 6) You check the workplace.
- 7) You use the machine for the specified purpose only.
- 8) You read, understand and abide by all applicable laws and regulations.
- 9) You have been trained to operate the machine safely.

1.3 Classification of Hazards



Notice

Classification of hazards

The meanings of symbols, color codes and characters of LGMG North America's products are as follows:

Security warning symbol: are used for warning of potential personal injuries.

Observe all safety instructions below these signs, to avoid situations causing potential personal injury and death.



Red: Signifies dangerous situations. If not avoided, will result in personal death or severe injury.



Orange: Signifies dangerous situations. If not avoided, may result in personal death or severe injury.



Yellow: Signifies dangerous situations. If not avoided, may result in minor or intermediate personal injury.

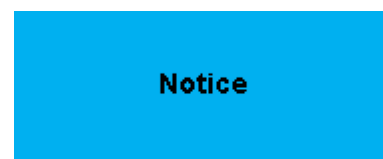

Blue: Signifies dangerous situations. If not avoided, property loss or damage can occur.

1.4 Intended Purpose

The purpose of this machine is limited to lifting personnel and their tools and materials to high-altitude workplaces, and it can be used indoors and outdoors.

⚠ Caution: It is strictly forbidden to use the machine to carry loads.

1.5 Safety Sign Maintenance

- 1) The operators should always keep in mind their safety when replacing any missing or damaged safety signs.
- 2) The safety decal should be cleaned with mild soap and water.
- 3) Do not use solvent-based cleaners as they may damage the material of the safety label.

1.6 Risk of Electric Shock

⚠ Warning: This machine is not insulated and is not provided with electrical shock protection when it comes into contact with or near electrical wire.



This machine should be kept an adequate safety distance from power line and electrical equipment according to applicable government laws and regulations and the following table.

Voltage	Required safety distance
0V-50 KV	3.05m/10ft
50 KV-200 KV	4.60m/15ft
200 KV-350 KV	6.10m/20ft
350 KV-500 KV	7.62m/25ft
500 KV-750 KV	10.67m/35ft
750 KV-1,000 KV	13.72m/45ft

Table 1-1 Safe distance between the equipment and power line

⚠ Caution: The effects of strong winds or gusts on the movement of the platform, the swinging and slackening of the wires should be considered.

- 1) If the machine comes into contact with live wires, keep away from the vehicle. No one is allowed to touch or operate the vehicle on the ground or platform before cutting off the power supply.
- 2) Do not operate the machine when there is lightning or storms.
- 3) Do not use the machine as a ground wire when welding.

1.7 Risk of Tipping

- 1) The personnel, equipment and materials on the platform may not exceed the maximum load capacity of the platform.

Item	T65J	T85J
Maximum Load Capacity of the Platform	250Kg /551lbs	250Kg/551lbs
		340Kg/750 lbs (Restricted range of motion)
Maximum occupants	2	2
		3 (Restricted)
Maximum Allowable Wind Speed	12.5m/s/28mph	12.5m/s/28mph

Table 1-2 Maximum Load Capacity of the

Platform

- 2) If the platform is overloaded, the alarm will sound. Please reduce the platform load before continuing.
- 3) When the platform is lifted, drive speed may not exceed 0.8km/h (0.5mph).
- 4) The tilt sensor may not be used as a level indicator. The alarm on the turntable will sound only when the vehicle is heavily tilted.
- 5) Be very careful if the alarm sounds when the platform is lifted. The machine's non-level indicator will light up and the drive function will not work in either direction. First determine the status of the upper boom on the slope, as shown below. Then follow the steps below to lower the boom before moving the machine to solid and level ground. Do not rotate the boom when lowering.

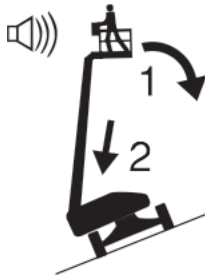

- 6) If the alarm sounds when the platform goes up the slope

- ① Lower the boom
- ② Retract the boom

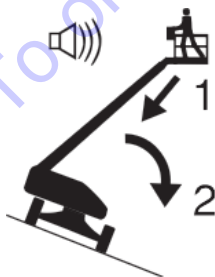

- 7) If the alarm sounds when the platform goes down the slope

- ① Retract the boom
- ② Lower the boom



- 8) Do not lift the boom when the wind speed may exceed 12.5 m/s/28mph. If the wind speed exceeds 12.5 m/s/28mph after the boom is lifted, lower the boom and do not continue to operate the machine.
- 9) Do not operate the machine in strong winds or gusts. Do not increase the surface area of the platform or load. Increasing the area exposed to the wind will reduce the stability of the machine.
- 10) Do not use the upper control box to operate the machine when the platform is trapped, jammed, or other objects nearby are blocking its normal movement. If you plan to operate the machine with the lower control box, all personnel must leave the platform before you do so.
- 11) In the retracted state, please be very careful and reduce the speed when the machine is running on gravels, unstable or smooth surfaces and near the entrance of holes or steep slopes.



- 12) When the boom is lifted, the machine cannot run on uneven terrain, unstable surfaces, or other dangerous conditions, or run near these areas.
- 13) Do not use the platform to push or pull

anything outside the platform.

- 14) Do not use the machine as a crane.
- 15) Do not place, tie or hang loads on any part of the machine.
- 16) Do not use the boom to push a machine or other objects.

1.8 General safety

- 1) Do not operate the machine with the hood open.
- 2) Do not allow the boom to approach or touch anything.
- 3) Do not change or modify all sensors such as length transducer, tilt angle sensor, the weighing sensor and rope-breaking detection devices.
- 4) Do not tie the boom or platform to adjacent objects.



- 5) This machine shall not be modified without the prior written permission of the manufacturer. Additional devices installed on platforms, pedals or guardrails for placing tools or materials will increase the weight and surface area of the platform.
- 6) Do not place ladders or scaffolds in the platform or against any part of the machine.
- 7) Only tools and materials that are evenly distributed and can be safely moved by people on the platform can be transported.
- 8) Do not use the machine on moving surfaces or vehicles.
- 9) Do not place your hands and arms near the area where there is a risk of cutting or crushing.
- 10) Do not alter or damage any parts that may affect the safety and stability of the machine.

- 11) Do not replace parts that affect machine stability with parts of different specifications.
- 12) Ensure that all tires are in good condition and the nuts are properly tightened, and do not replace the original tires with tires of different specifications.
- 13) The ambient temperature of the machine is -20 ° C ~ 40 ° C.
- 14) Ensure this manual is kept in the manual box in the platform.

1.9 Risk of Operating on Slopes

Do not drive the machine on slopes exceeding the machine's maximum uphill, downhill or side slope ratings. The slope rating applies only to machines that are in the retracted state.

The maximum slope rating for when the boom is retracted is as follows

Downhill	45% (24°)
Uphill	30% (17°)
Side Slope	25% (14°)

Table 1-3 Maximum slope rating for when the boom is retracted



Caution: The slope rating is

limited by ground conditions and traction. Please refer to driving on a slope in the "Operation Instructions" section of this manual.

1.10 Risk of Falling

- 1) In the process of operation, the staff on the platform must wear safety protection equipment such as helmets, safety belts and safety shoes according to the requirements on site, and use, inspect and periodically replace the safety equipment according to the manufacturer's instructions.

Warning: The safety harness

lanyards must be secured to the approved attachment points, and only one lanyard can be secured to each attachment point.



- 2) Do not sit, stand or climb on the guardrail of the platform. Stand steadily on the platform floor at all times.
- 3) When the platform is lifted, do not climb down from the boom.
- 4) Keep the platform floor free of debris and trash.
- 5) Close the entrance door before operation.
- 6) Do not enter or exit the platform unless the machine is in a retracted state.

1.11 Risk of Collision

- 1) When operating the machine on the ground, please maintain normal judgment and planning. Maintain a safe distance among the operator, the machine and objects.
- 2) When starting or operating the machine, please pay attention to the range of visibility and blind spots.



- 3) When rotating the turntable, pay attention to the position of the boom and the tail of the turntable.
- 4) Check the work area to avoid overhead obstacles or other possible hazards.
- 5) When holding onto the platform guardrail, beware of the risk of crushing.

- 6) Lower the boom only when there are no people or obstacles in the area underneath.



- 7) Limit the drive speed according to the ground conditions, congestion levels, slope, personnel location and any other factors that may cause a collision.
- 8) It is not allowed to operate the vehicle on any crane or moving overhead vehicle route unless the crane control unit has been locked and/or precautions have been taken to prevent any potential collision.
- 9) Do not drive dangerously or play while operating the machine.
- 10) Users must follow user rules, workplace rules and government rules for personal protective equipment.
- 11) Please observe the direction of the driving and steering functions.

1.12 Risk of Explosion and Fire

- 1) Do not operate the vehicle where it is dangerous or where flammable or explosive gases or particles may be present.
- 2) Do not refuel the machine when the engine is running.
- 3) Only refuel the machine in open and well-ventilated places far away from sparks, open flames, burning cigarettes, etc.
- 4) Do not use the machine or charge the battery in places that are dangerous or where flammable or explosive gases or dust may exist.
- 5) Do not spray ether into an engine equipped with a glow plug.

1.13 Risk of Machine Damage

- 1) Do not operate a machine that is damaged or faulty.
- 2) Do not use the machine as a ground wire during welding, and the battery anode and cathode must be disconnected during welding.
- 3) Do not use the machine in places where strong magnetic fields, strong ionization and radioactive radiation may exist.
- 4) Do not use any battery or charger larger than 12V to start the engine.
- 5) Before each work shift, thoroughly perform the pre-operation inspection against the vehicle and test all functions. A damaged or faulty vehicle should be immediately tagged out and stopped.
- 6) Make sure all maintenance operations have been performed as specified in this manual.
- 7) Ensure that all decals are properly positioned and easily identifiable.

1.14 Risk of Bodily Injury



- 1) Always operate the machine in a well-ventilated area to avoid of carbon monoxide poisoning.
- 2) Do not operate the vehicle with hydraulic oil leaks, which may penetrate when under pressure or burn your skin.
- 3) Incorrect contact with any component under the cover may cause serious injury. Only qualified authorized service personnel can access the compartment. It is recommended that the operator perform the inspection only during the pre-operation inspection. All compartments must be closed and locked during operation.

1.15 Battery safety

- 1) Danger of burns
 - The battery is a maintenance-free lead storage battery containing acidic substances. It is forbidden to disassemble the battery case.
 - If the acid in the battery overflows, use soda water to neutralize.
 - The battery pack must be placed vertically.
 - Do not expose batteries or chargers to water or rain.
- 2) Danger of explosion



- Sparks, flames or lit cigarettes are prohibited from getting close to the battery. The battery may release explosive gases.
 - Do not touch the battery terminals or cable clamps with tools that may cause sparks.
- 3) Danger of electric shock
 - The battery charger can only be connected to a 12V battery charger.
 - Check the cable and wiring for damage daily and replace the damaged items before operation.
 - Avoid electric shock caused due to contact with battery terminals.
 - Remove all rings, watches and other jewelry when checking.

Chapter 2 Legend

To order go to Discount-Equipment.com

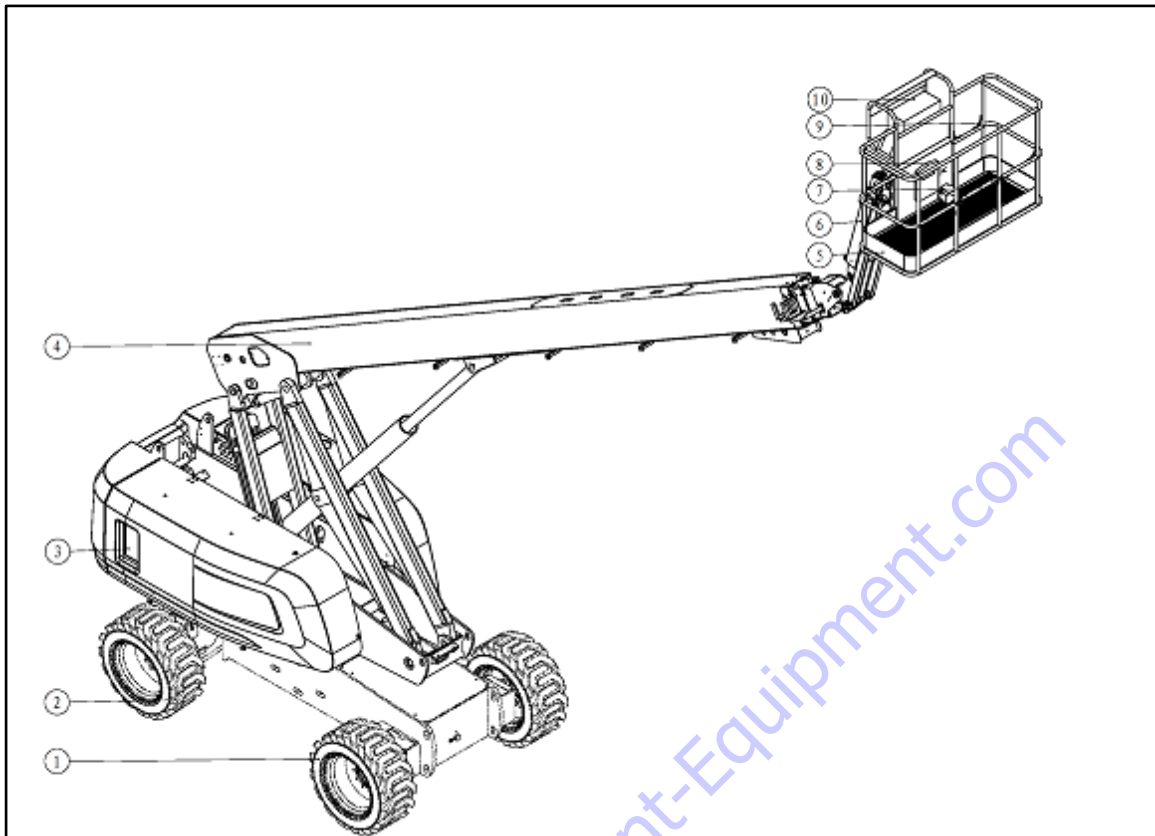

Figure 2-1 Legend of the complete machine

- 1 Non-Steering Wheel
- 2 Steering Wheel
- 3 Ground Control Station
- 4 Boom
- 5 Platform
- 6 Jib
- 7 Lifting Rod
- 8 Manual Box
- 9 Lanyard Attach Point
- 10 Platform Control Station

Chapter 3 Decals

To order go to Discount-Equipment.com

T65J/T85J decals

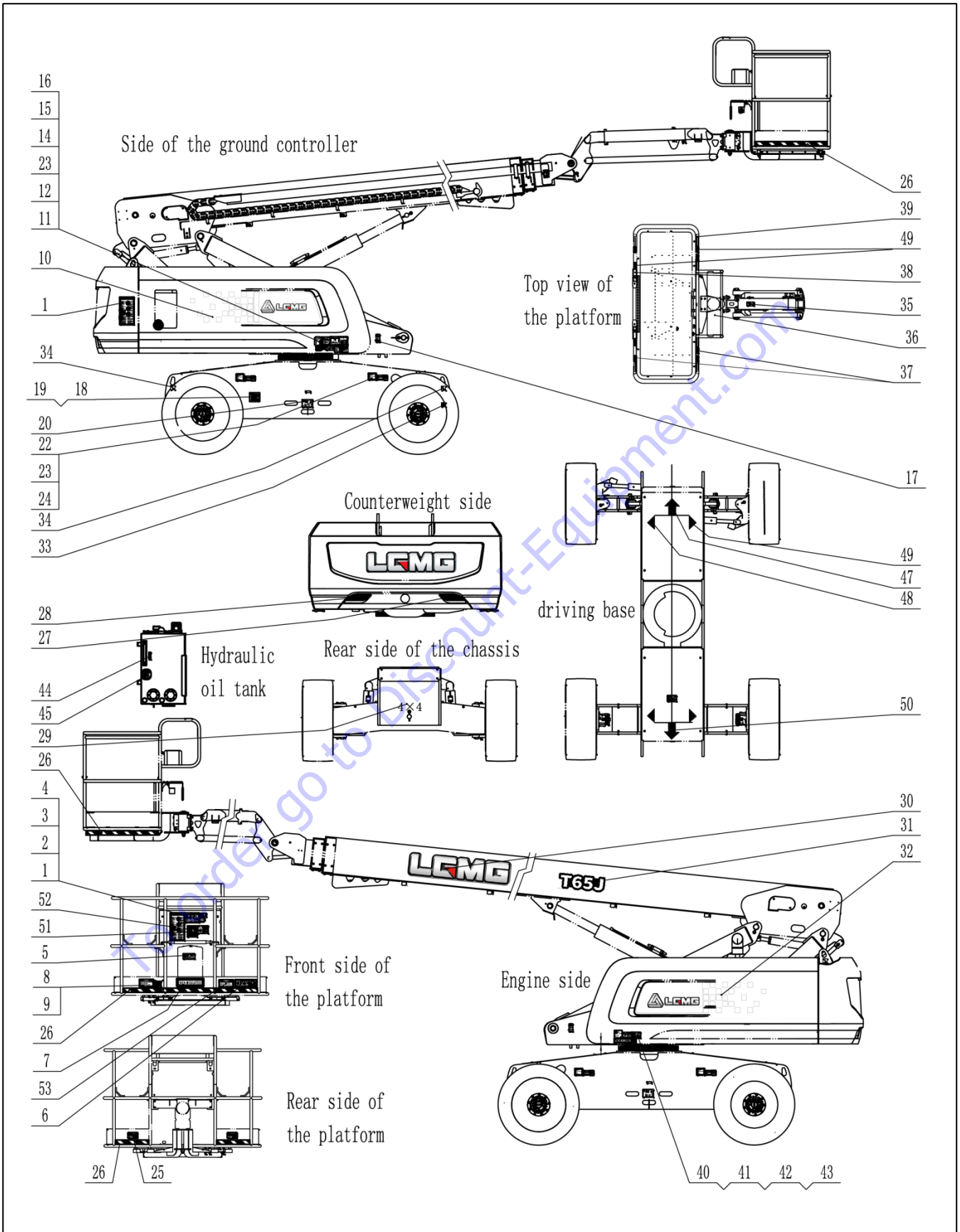

Figure 3-1 Positions of labels

1-2534001540	2-2534001696	3-2534000026	4-2534001570	5-2534001542	6-2534002466
			<p>If Safety Manual, Operator's Manual or Responsibilities Manual are missing, contact LGMG.</p>		
7-2534000724	8-2534001560	9-2534001559	10-2534000194	11-2534000998	12-2534001558
<p>NON-INSULATED</p>		<p>NOTICE Maximum allowable side force on platform 90 lbs / 400 N. Maximum allowable wind speed 12.5 m/sec (28 mph).</p>			<p>NOTICE One or more of the following hazardous materials are used on this machine:</p> <ul style="list-style-type: none"> • Gasoline • Liquid Petroleum Gas (LPG) • Diesel Fuel • Hydraulic Fluid • Antifreeze • Engine Oil • Grease • Lead-Acid Battery
13-2534001546/144	14-2831991548	15-2534000974	16-2534001080	17-2534001543	18-2534001850
19-419000012	20-2534001178	21-2534000177	22-254001691/779	23-2534001578	24-2534001692/780
			<p>4WD Foam-Filled Industrial Tire Size: 355/55R205 Do not add air. Minimum New Foam-Filled Tire Weight 445 lbs / 202 kg Wheel Lug Torque 238 lb-ft / 320 Nm</p> <p>4WD Foam-Filled Industrial Tire Size: 18-825 Do not add air. Minimum New Foam-Filled Tire Weight 465 lbs / 211 kg Wheel Lug Torque 318 lb-ft / 427 Nm</p>		
25-2534001177	26-2534000024	27-2534000197	28-2534000196	29-2534000056	30-2534001775
				<p>4x4</p>	
31-2534002464/5	32-2534000195	33-2831990027	34-2534000027	35-2534001180	36-2534001743
<p>T65J</p> <p>T85J</p>					

37-2534000017	38-2534000248	39-2534001809	40-2534000786	41-2534001086	42-2534001545
43-2534001576	44-2534002027	45-2534001995	46-2534002026	47-2534000053	48-2534000051
49-2534000050	51-2534002550	51-2534002550	52-2534002556/8	53-2534001722	

To order go to DiscountEquipment.com

Code	Number	Name	Code	Number	Name
1	2534001540	Sign for safe rules description	28	2534000196	Reflective sticker
2	2534001696	Sign for caution of tipping up and down the slope	29	2534000056	Driving form sign
3	2534000026	Sign for reading instructions	30	2534001775	Group LOGO-english-365
4	2534001570	Manual loss description	31	2534002464/5	Model signs
5	2534001542	Sign for reading instructions carefully	32	2534000195	Group LOGO
6	2534002466	Sign for double load	33	2831990027	Lifting eye sign
7	2534000724	Sign for no-insulating	34	2534000027	Lifting sign
8	2534001560	Caution sign for lifting and lowering the middle guardrail	35	2534001180	Sign for caution of falling
9	2534001559	Sign for maximum hand power	36	2534001743	Ground connection sign
10	2534000194	Group LOGO	37	2534000017	Sign for lanyard fixed point
11	2534000998	Sign for spark prohibition	38	2534000248	Anti-scratch sticker
12	2534001558	Sign for caution of hazardous materials	39	2534001809	Anti-scratch sticker
13	2534001546/ 2534000144	Warning signs for explosion burn	40	2534000786	107dB
14	2534001548	Electric shock hazard sign	41	2534001086	Warning sign for explosion
15	2534000974	In-box maintenance sign	42	2534001545	Tilting risk sign
16	2534001080	Warning sign for fire prohibition	43	2534001576	Sign of country of origin
17	2534001543	Anti-crush hazard sign	44	2534002027	Hydraulic oil level
18	2534001850	Machine nameplate	45	2534001995	Hydraulic oil
19	4019000012	Bolt	46	2534002026	Power switch
20	2534001178	Sign for lanyard fixed point	47	2534000053	Forward arrow sign - blue
21	2534000177	Fuel tank sign	48	2534000051	Left-turn arrow sign - blue
22	2534001691/ 2534001779	Tire description sign	49	2534000050	Right-turn arrow sign - yellow
23	2534001578	Sign for caution of tilting	50	2534000052	Backward arrow sign - yellow
24	2534001692/ 2534001780	Wheel load sign	51	2534002550	Driving on a slop
25	2534001177	Stay away from machine	52	2534002556/8	Range of motion
26	2534000024	Warning line	53	25340001722	Decal-Platform safety
27	2534000197	Reflective sticker			

Table 3-1 Codes and names of labels

Chapter 4 Machine Specifications

To order go to Discount-Equipment.com

T65J Specifications

4.1 Performance Specifications

Item	Specification	Item	Specification
Rated Load (Kg/Lbs)	250/551	One Rotation Of Turntable (Collection) (S)	78-86
Maximum occupants	2	One Rotation Of Turntable(Unfolded) (S)	125-165
Maximum Working Height (m/ft)	21.7 /71.2	Main Boom Lift (S)	60-70
Maximum Platform Height (m/ft)	19.7/64.6	Main Boom Lowering (S)	60-70
Maximum Horizontal Extension (m/ft)	17.2/56.4	Boom Extension (S)	58-66
Driving Speed (collection) (km/h/ mph)	4.8±0.25/ 3±0.155	Boom Retraction (S)	53-62
Driving Speed (lifting state) (km/h/mph)	0.8±0.05/ 0.5±0.03	Jib Lift (S)	40-50
climbing Speed (collection) (km/h/ mph)	1.2≤V≤1.5 0.7≤V≤0.9	Jib Lowering (S)	20-35
Climbing Speed (lifting state) (km/h/mph)	0.3≤V≤0.8 0.2≤V≤0.5	Platform Rotation (S)	13-26
Minimum Turning Radius (Inner Wheel) (m/ft)	2.5/8.1	Maximum Tilt Angle Allowed	4.5°
Minimum Turning Radius (Outer Wheel) (m/ft)	5.5/17.8	Machine Weight (Kg/Lbs)	11400/25132
Theoretical Gradeability	45%	Max manual force (N)	400

4.2 Dimensions

Item	Specification	Item	Specification
Machine Length (mm/in)	9470/373	Tread (mm/in)	2130/84
Machine Width (mm/in)	2495/98	Wheelbase (front/rear) (mm/in)	2510/99
Machine Height (mm/in)	2770/109	Work Platform Size (length × width) (mm/in)	2440×900/96×35
Ground Clearance (Retracted State) (mm/in)	395/15.5	Tire Specifications (Diameter×Width)(mm/in)	936×360 36.9in×14.2

4.3 Engine System

Item	Specification	Item	Specification
Model	D2.9L4	Rated revolving speed (r/min)	2600

Displacement (ml)	2900	Maximum torque (N•m) revolving speed (r/min)	147/1600
Rated power (kW)	36.4	Emission standard	Meet EPA Tier 4f emissions

4.4 Drive system

Item		Specification/Content
Driving reducer	Output torque (N*m)	3390
Rotary reducer	Output torque (N*m)	1690

4.5 Hydraulic System

Item		Specification/Content	
Driving system	Model	Drive closed system	
	Pump displacement (ml/r)	46	
	Max working Pressure (Mpa/Psi)	28/4061	
	Motor displacement (ml/r)	38	
Functional system	Model	Open system	
	Pump displacement (ml/r)	28	
	Lifting system	Max working Pressure (Mpa/Psi)	23/3336
	Rotary system	Max working Pressure (Mpa/Psi)	23/3336
	Steering system	Max working Pressure (Mpa/Psi)	23/3336

4.6 Electrical System

Item		Specification/Content
Battery	Model	6-QW-120B
	Output voltage (V)	12
	Capacity (AH)	120(20 hours)
Control system	Voltage (V)	12



Caution: Select corresponding brand of fuel oil according to the local working environment temperature, and refer to *the Deutz D2.9L4 Engine User Manual* for fuel recommendations and technical specifications.

4.7 Fueling/Grease Capacity

Item	Condition	Type	Capacity	Remarks
Hydraulic oil(L/gal)	The lowest temperature > -25°C	L-HV32 Low temperature hydraulic oil	180/47.5	Recommended chevron brand
	-40°C < The lowest temperature ≤ -25°C	L-HS32 Ultra low temperature hydraulic oil		
	The lowest temperature ≤ -40°C	10# Aviation hydraulic oil		
Driving Reducer oil (×4) (L/gal)	30° C < The lowest temperature	85W/140	0.68/0.18	SAE API 1560 GL-5
	-10° C < The lowest temperature < 30° C	85W/90		
Rotary reducer (L/gal)	-30° C < The lowest temperature < -10° C	80W/90	0.45/0.12	
	The lowest temperature < -30° C	75W		
Engine oil(L/gal)	Working temperature: -20°C ~ 40°C	CH-4/15W-40	8.5/2.2	/
	Working temperature: -25°C ~ 30°C	CH-4/10W-30		
	Working temperature: -30°C ~ 30°C	CH-4/5W-30		
	Working temperature: -35°C ~ 20°C	CH-4/0W-20		
Diesel (L/gal)	/	ULSD	100/26.4	EN590 and ASTM D 975
Antifreeze(L/gal)	/	/	7.7/2	/
The inner track of gyration support	/	Lithium base grease 2#	Moderate	/
The surface of the gear	/	Lithium base grease 2#	Moderate	/

4.8 Working Range Diagram

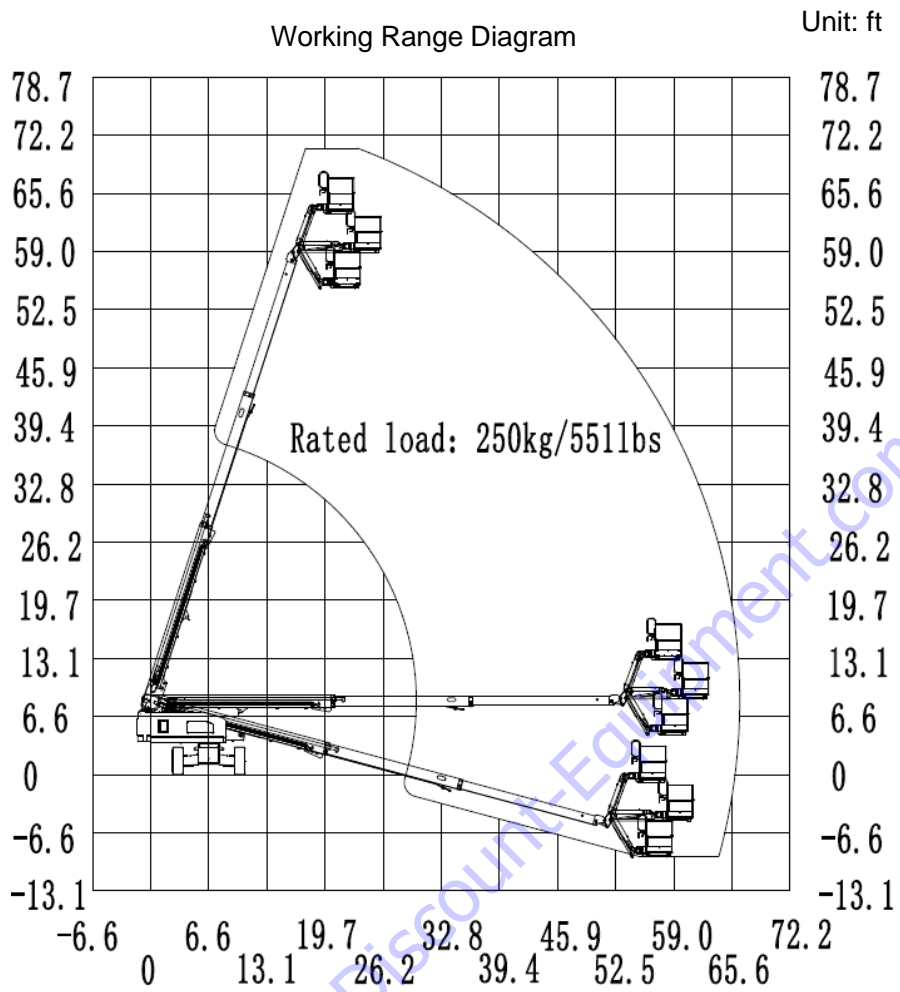

Figure 4-1 Scope of work

To order go to DiscountEquipment.com

T85J Specifications

4.1 Performance Specifications

Item	Specification	Item	Specification
Rated load (Kg/lbs)	250/551	One rotation of turntable (collection) (S)	90-110
	2 people		
Restricted load (Kg/lbs)	340/750	One rotation of turntable(unfolded) (S)	170-200
	3 people		
Maximum working height (m/ft)	27.9 /91.5	Base boom ascent (S)	70-90
Maximum platform height (m/ft)	25.9/84.9	Base boom descent (S)	70-90
Maximum Horizontal Extension (m/ft)	23.32/76.5	Boom extension (S)	55-73
Driving Speed (collection) (km/h/ mph)	4.8±0.25/ 3±0.155	Boom retraction (S)	55-73
Driving Speed (lifting state) (km/h/mpH)	0.8±0.05/ 0.5±0.03	Small arm ascent (S)	25-35
climbing Speed (collection) (km/h/ mph)	1.2≤V≤1.5 0.75≤V≤0.93	Small arm descent (S)	15-25
Climbing Speed (lifting state) (km/h/mpH)	0.3≤V≤0.8 0.19≤V≤0.5	Platform rotation (S)	13-26
Minimum turning radius (inner wheel) (m/ft)	3.66/12.	Maximum tilt angle allowed	4.5°
Minimum turning radius (outer wheel) (m/ft)	6.55/21.5	Machine weight (Kg/lbs)	18000/39683
Theoretical gradeability	45%	Max manual force (N)	400

4.2 Main Dimensions

Item	Specification	Item	Specification
Machine length (mm/in)	12600/496	Tread (mm/in)	2050/80.7
Machine width (mm/in)	2500/98	Wheelbase (front/rear) (mm/in)	2850/112
Machine height (mm/in)	2840/112	Work platform size (length × width) (mm/in)	2440×900/96×35
Ground clearance (retracted state) (mm/in)	440/17	Tire specifications (diameter × width)(mm/in)	1036 × 440 40.8in × 17.3

4.3 Engine System

Item	Specification	Item	Specification
Model	TD2.9L4	Rated revolving speed (r/min)	2600
Displacement (ml)	2900	Maximum torque (N•m) revolving speed (r/min)	260/1800
Rated power (kW)	55.4	Emission standard	US EPA T4F

4.4 Drive system

Item		Specification/Content
Driving reducer	Output torque (N*m)	5500
Rotary reducer	Output torque (N*m)	1690

4.5 Hydraulic System

Item		Specification/Content	
Driving system	Model	Drive closed system	
	Pump displacement (ml/r)	46	
	Max working Pressure (Mpa/Psi)	28/4061	
	Motor displacement (ml/r)	45	
Functional system	Model	Open system	
	Pump displacement (ml/r)	35	
	Lifting system	Max working Pressure (Mpa/Psi)	23/3336
	Rotary system	Max working Pressure (Mpa/Psi)	23/3336
	Steering system	Max working Pressure (Mpa/Psi)	23/3336

4.6 Electrical System

Item		Specification/Content
Battery	Model	6-QW-120B
	Output voltage (V)	12
	Capacity (AH)	120(20 hours)
Control system	Voltage (V)	12



Caution: Select corresponding brand of fuel oil according to the local working environment temperature, and refer to *the Deutz TD2.9L4 Engine User Manual* for fuel recommendations and technical specifications.

4.7 Fueling/Grease Capacity

Item	Condition	Type	Capacity	Remarks
Hydraulic oil(L/gal)	The lowest temperature > -25°C	L-HV32 Low temperature hydraulic oil	180/47.5	Recommended chevron brand
	-40°C < The lowest temperature ≤ -25°C	L-HS32 Ultra low temperature		

		hydraulic oil		
	The lowest temperature $\leq -40^{\circ}\text{C}$	10# Aviation hydraulic oil		
Reducer oil $\times 4$ (L/gal)	$30^{\circ}\text{C} < \text{The lowest temperature}$	85W/140	0.68/0.18	SAE API 1560 GL-5
	$-10^{\circ}\text{C} < \text{The lowest temperature} < 30^{\circ}\text{C}$	85W/90		
Rotary reducer (L/gal)	$-30^{\circ}\text{C} < \text{The lowest temperature} < -10^{\circ}\text{C}$	80W/90	0.45/0.12	
	The lowest temperature $< -30^{\circ}\text{C}$	75W		
Engine oil (L/gal)	Working temperature: $-20^{\circ}\text{C} \sim 40^{\circ}\text{C}$	CH-4/15W-40	8.5/2.2	/
	Working temperature: $-25^{\circ}\text{C} \sim 30^{\circ}\text{C}$	CH-4/10W-30		
	Working temperature: $-30^{\circ}\text{C} \sim 30^{\circ}\text{C}$	CH-4/5W-30		
	Working temperature: $-35^{\circ}\text{C} \sim 20^{\circ}\text{C}$	CH-4/0W-20		
Diesel (L/gal)	/	ULSD	100/26.4	EN590 and ASTM D 975
Antifreeze (L/gal)	/	/	9.3/2.5	/
The inner track of gyration support	/	Lithium base grease 2#	Moderate	/
The surface of the gear	/	Lithium base grease 2#	Moderate	/

4.8 Working Range Diagram

Working Range Diagram

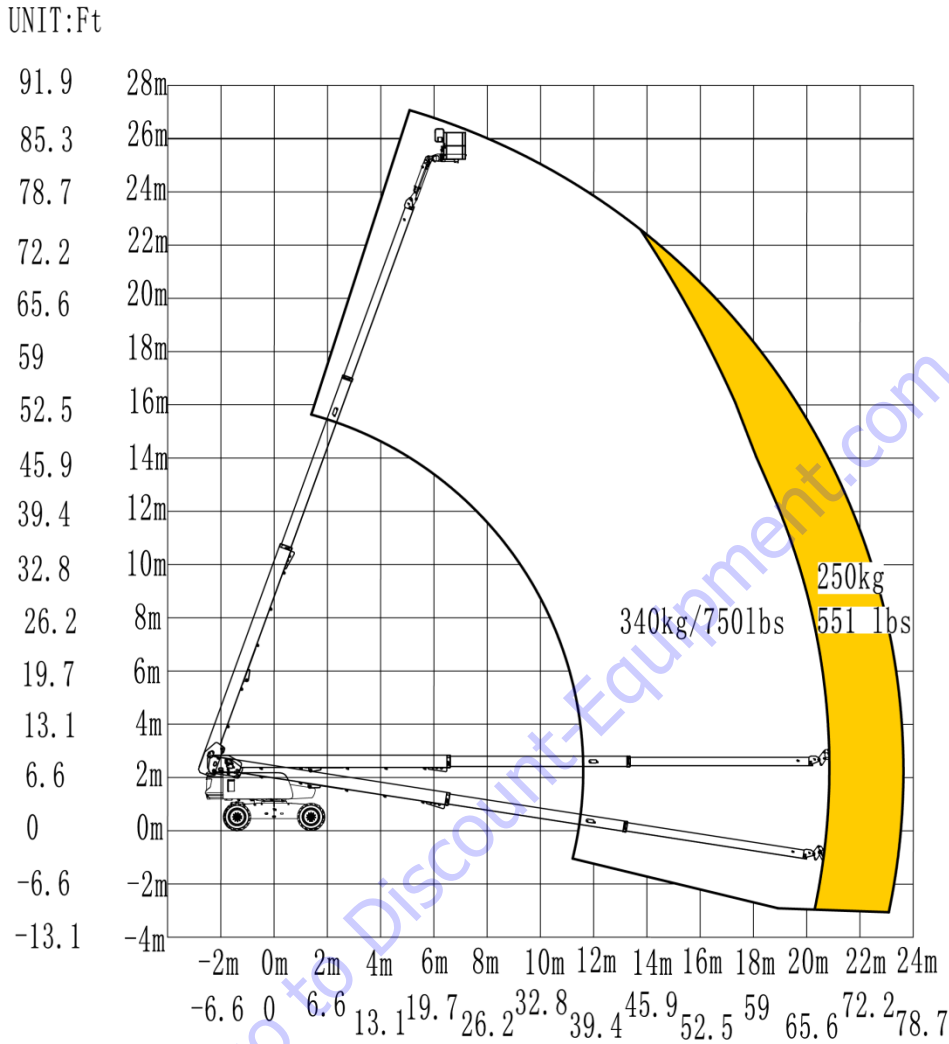

Figure 4-2 Scope of work

sequence of operation:

When operating with a ground controller: the machine motion range is automatically controlled according to the load on the platform.

When the platform load is less than 250Kg, T85J motion range is not limited.

When the platform load is greater than 250Kg and less than 340Kg, T85J motion range is limited.

When operating with the platform controller: the machine motion range is controlled by the load selection button switch of the platform controller.

Turn the dial button switch to 250Kg: the rated load of the machine is 250Kg, and the motion range of T85J is not restricted.

Turn the dial button switch to 340Kg: the restricted load of the machine is 340Kg, and the motion range of T85J is restricted.

Chapter 5 Control Station

To order go to Discount-Equipment.com

5.1 Ground Control Station

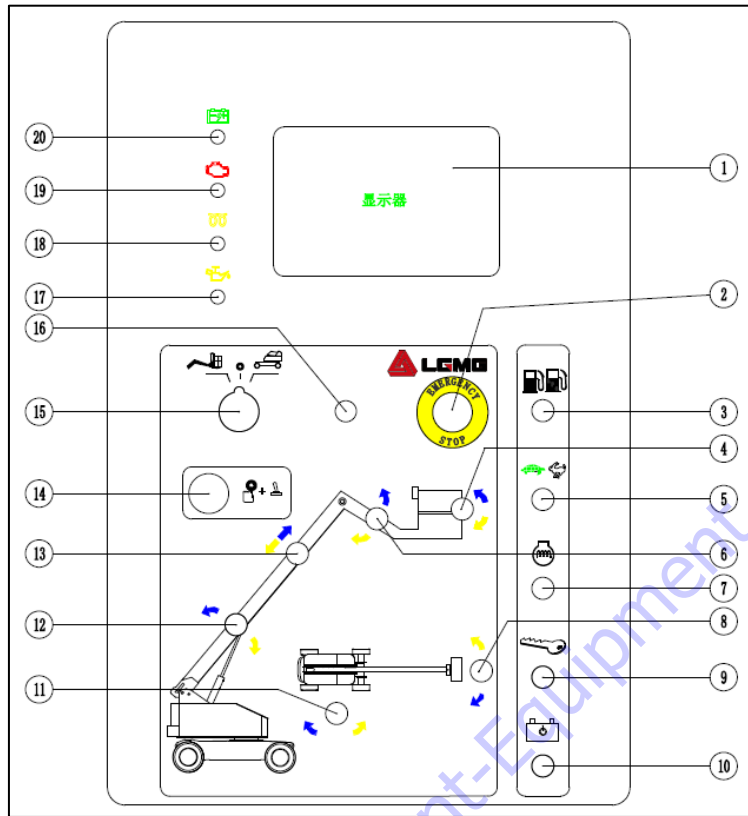



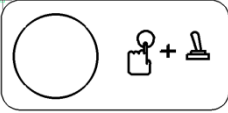



Figure 5-1 Panel of the lower control box

Number	Name	Number	Name
1	Display	11	Turntable Rotary Switch
2	Emergency Stop Switch	12	Boom Up/Down Switch
3	Gasoline/LPG Model: Fuel Selector Switch	13	Boom Extension/Retraction Switch
4	Platform Leveling Switch	14	Function Enable Button
5	Engine Idle Speed (Rpm) Selector Switch	15	Key Toggle Switch
6	Short Arm Up/Down Switch	16	10A Self-Resetting Fuse For Controlling Circuit
7	Engine Warm-Up	17	Engine oil alarm
8	Platform Rotary Switch	18	Engine warm up indicator
9	Engine Start Switch	19	Engine failure alarm
10	Emergency Power Unit Switch	20	Power on indicator

Table 5-1 Names of the functions of the lower control panel

The table below describes the functions of the button/toggle switches:

Item	Button/Toggle Switch	Function Description
Lower control box	Key toggle switch	 <p>Turn the key toggle switch to the platform position, and the upper control box will work. Turn the key toggle switch to the off position, and the machine will be turned off. Turn the key toggle switch to the get off position, and the lower control box will work.</p>
	Engine start switch	 <p>Turn the engine start switch to the upper side for 2-3S to start the engine.</p>
	Emergency stop switch	 <p>Push the red "emergency stop" button inward to the off position to stop all functions; Rotate the red "emergency stop" button to the on position to operate the machine and the warning light flashes.</p>
	Function enabling button switch	 <p>If you do not press and hold the function enabling button switch, all boom and platform functions will not work. Press and hold the function enabling button switch and start each boom and platform function toggle switch to run all boom and platform functions.</p>
	Engine warm-up switch(If equipped)	 <p>When starting at a low temperature, turn the toggle switch to the upper side to warm up the engine for 20-30s, and then pull back the toggle switch to stop warming up.</p>
	Emergency power switch	 <p>If the main power source (engine) fails, please use the emergency power unit. Start the required function while keeping the emergency power unit switch on.</p>
	<ol style="list-style-type: none"> 1. Turn the key toggle switch to the lower control box. 2. Rotate the red "emergency stop" button outward to the on position. 3. Press the function enable button. 	
	Platform rotary switch	<p>Push the platform rotary toggle switch upward, the platform will rotate to the right; Push the platform rotary toggle switch downward, the platform will rotate to the left.</p>
	Turntable swing switch	<p>Rotate the toggle switch to the right, the turntable will move to the right; Rotate the toggle switch to the left, the turntable will move to the left.</p>
	Boom up/down switch	<p>Push the toggle switch to the upward, the boom will rise; Push the toggle switch to the downward, the boom will descend. When the boom descends, the buzzer should sound; When the boom is swung to the maximum and minimum positions, the buzzer will sound.</p>
	Boom extension/retraction switch	<p>Push the toggle switch to the upward, the boom will extend; Push the toggle switch to the downward, the boom will retracted. When the boom extends and retracts to the maximum position, the buzzer will sound.</p>
Jib up/down switch	<p>Push the toggle switch to the upward, the short arm will rise; Push the toggle switch to the downward, the short arm will descend.</p>	



	Platform leveling switch	Move the switch up, the platform level will rise. Move the switch down, the platform level will descend.
	Engine idle speed selector switch	  Pull the idle speed selector switch to the turtle position, the engine starts the low idle speed; Pull the idle speed selector switch to the rabbit position, the engine starts the high idle speed. After releasing the function enable button, the engine enters the low idle speed.

Table 5-2 Description of functions of the toggle switches on the lower control box panel

To order go to Discount-Equipment.com

5.2 Platform Control Station

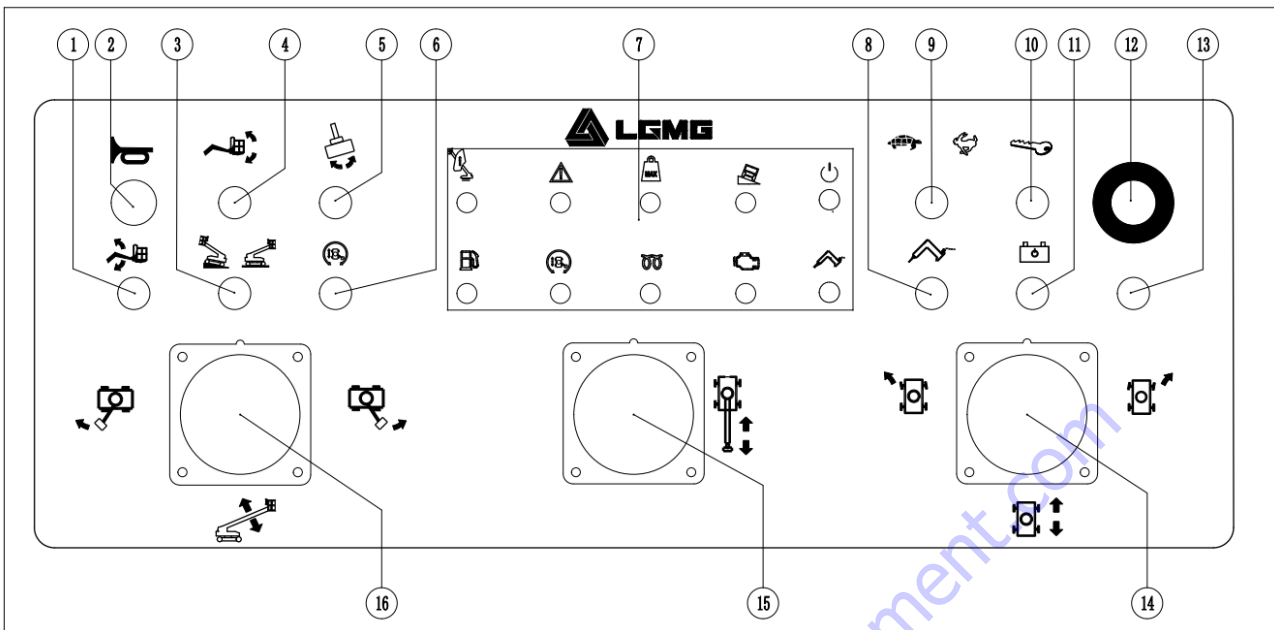

Figure 5-2 Panel of the upper control box (T65J)

Number	Name	Number	Name
1	Small arm up/down switch	9	Engine idle speed selector switch
2	Horn switch	10	Engine start
3	Drive speed selector switch	11	Emergency power unit switch
4	Platform leveling switch	12	Emergency stop switch
5	Platform rotary switch	13	Reserve
6	Drive enabling switch	14	Drive/steering control handle
7	Indicator light	15	Boom extension and retraction
8	Generator switch	16	Boom up/down and turntable rotary switch

Table 5-3 Names of the functions of the platform control station panel

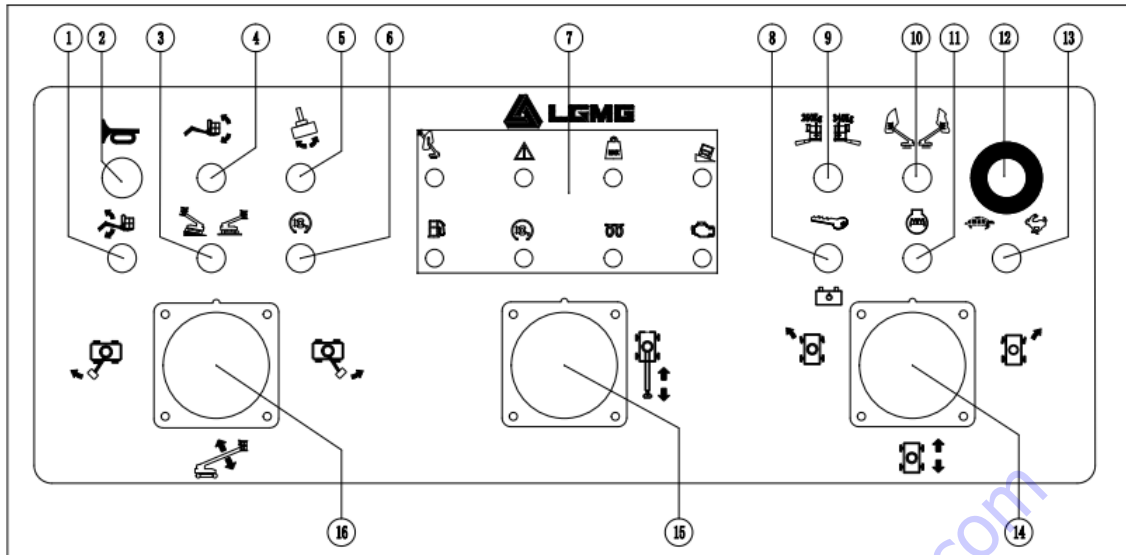

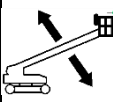



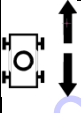

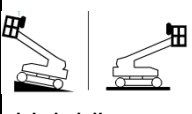



Figure 5-3 Panel of the upper control box (T85J)

Number	Name	Number	Name
1	Small arm up/down switch	9	Load selection switch
2	Horn switch	10	Working range selection switch (reserved)
3	Drive speed selector switch	11	Engine warm-up
4	Platform leveling switch	12	Emergency stop switch
5	Platform rotary switch	13	Engine idle speed selector switch
6	Drive enabling switch	14	Drive/steering control handle
7	Indicator light	15	Boom extension and retraction
8	Engine start/ Emergency power unit switch	16	Boom up/down and turntable rotary switch

The table below describes the functions of the button/toggle switches on the platform control station.

Item	Button/Toggle Switch	Function Description
Upper control box	Engine start switch	Move the engine start switch to one side to start the engine.
	Emergency stop switch	Push the red "emergency stop" button inward to the off position, you can stop all upper control functions and shut down the engine without any impact on the lower control box. Rotate the red "emergency stop" button to the on position, you can operate the machine on the upper control box.
	Engine warm-up switch (If equipped)	When starting at a low temperature, turn the toggle switch to the other side to warm up the engine. After the engine reaches a certain temperature, pull back the toggle switch to stop warming up.

<p>1. Turn the key toggle switch to the platform control station position. 2. Pull the red "emergency stop" button outward to the on position. 3. Step on the foot switch.</p>	
Platform rotary toggle switch	 <p>Rotate the platform rotary toggle switch to the right, the platform will rotate to the right. Rotate the platform rotary toggle switch to the left, the platform will rotate to the left.</p>
Boom up/down and turntable rotary handle	 <p>Move the control handle to the right, the turntable will move to the right. Move the control handle to the left, the turntable will move to the left.</p>
	 <p>Move the control handle up, the boom will rise; Move the control handle downward, the boom will descend. When the boom descends, the buzzer should sound; When the boom is swung to the maximum and minimum positions, the buzzer will sound.</p>
Boom extension/retraction	 <p>Move the control handle down, the boom extends; move the control handle up, the boom retracts. When the boom extends and retracts to the maximum position, the buzzer will sound.</p>
Jib up/down toggle switch	 <p>Move the control handle up, the small arm will rise; Move the control handle down, the small arm will descend. When the small arm descends, the buzzer will sound;</p>
Platform leveling toggle switch	 <p>Move the switch up, the platform level will rise; move the switch down, the platform level will descend.</p>
Drive/steering control handle	 <p>Move the control handle upward, the machine will drive forward; Move the control handle down, the machine will drive backward.</p>
	 <p>Press the left side of the thumb stick, the machine will turn to the left; Press the right side of the thumb stick, the machine will turn to the right.</p>
Drive speed selector switch	 <p>When the machine is on the slope symbol, it is used for driving the operation in the low speed range. At this time, the engine automatically switches to the high idle speed; When the machine is in the horizontal plane symbol, it is used for driving the high speed operating range.</p>
Drive enabling switch	 <p>When the turntable is rotated to a certain angle, the drive function cannot be operated and the drive enabling indicator alarms. Move the drive enabling toggle switch to one side and slowly move the drive controller handle, then the drive function will operate.</p>
Engine idle speed selector switch	 <p>Pull the idle speed selector switch to the turtle position, the engine starts the low idle speed; Pull the idle speed selector switch to the rabbit position, step on the foot switch and turn the handle, then the engine starts the high idle speed. After releasing the handle, the engine enters the low idle speed.</p>



	Emergency power switch		<p>If the main power source (engine) fails, please use the emergency power unit. Step on the foot switch to start the required functions while keeping the emergency power switch on.</p>
	Load selection switch(T85J)		<p>Move the switch to the left side,the paltform rated load is 250Kg; move the switch to the right side,the paltform maximun load is 340Kg.(The working range is show in Figure 4-2)</p>
	Generator switch		<p>To operate the generator, move the generator toggle switch to the on position. To stop the generator, move the generator toggle switch to the off position</p>

Table 5-4 Description of the functions of the toggle switches on the platform control station

The table below describes the functions of the LED display panel and indicators:



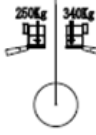





	Platform overweight alarm		Minimum fuel level alarm
	Drive enabling alarm		System failure alarm
	Machine tilt alarm		Engine failure alarm
	Generator is in use		Glow plugs are on

Table 5-5 Description of the functions of the LED display panel

Chapter 6 Pre-Operational Check

To order go to Discount-Equipment.com

6.1 Before Operating the Machine, Please Ensure That:

- 1) You are equipped with full-body protective equipment such as helmets, safety belts, safety shoes, goggles and protective gloves, and are in good physical condition.
- 2) You have understood and practiced the rules for safe operation of the machine in this operation manual.
- 3) To avoid dangerous situations, you know and understand the safety rules before moving to the next step.
- 4) To check the workplace, please refer to the workplace inspection section of this manual.
- 5) You read, understand and abide by all applicable government laws and regulations.
- 6) You are properly trained and qualified to operate the machine safely.
- 7) Only qualified maintenance technicians can repair the machine according to our company's regulations.

6.2 Basic Principles

- 1) It is the operator's responsibility to conduct pre-operational check and routine maintenance.
- 2) Pre-operational check is an intuitive inspection process that is performed by the operator before each shift. The purpose of inspection is to find out whether there is a significant problem with the machine before the operator performs a functional test.
- 3) Pre-operational checks can also be used to determine whether a routine maintenance procedure is required. The operator can only perform routine maintenance items as specified in this manual.
- 4) Please refer to the list on the next page and check each item.
- 5) In the event of any damage or any unauthorized changes different from the

normal status, the vehicle should be marked and prohibited from putting into operation.

- 6) Only qualified maintenance technicians can repair the machine. After the repair is completed, the operator must perform a pre-operational check before continuing the functional test.
- 7) Regular maintenance inspections shall be performed by qualified maintenance technicians in accordance with the manufacturer's specifications and the requirements listed in the manual.

6.3 Pre-Operational Check

- 1) Ensure that the manual is complete, easy to read and kept in a file box in the platform. If you need to replace the manual, please contact the service personnel from LGMG North America.
- 2) Ensure that all decals are clear, legible and in the right place. Please refer to the "Decals" section. If you need to replace the labels, please contact the service personnel from LGMG North America.
- 3) Check whether the two ball valves at the oil suction port at the bottom of the hydraulic oil tank are open. They must be kept open if there are no any special circumstances, and they must be in an open state when the engine starts. Failure to open the valve before starting the engine will cause complete damage to the oil pump.
- 4) Please refer to the "maintenance" section to check whether the hydraulic oil is leaking and whether the oil level is appropriate.
- 5) Check whether the battery fluid leaks and the wiring is firm.
- 6) Please refer to the "Maintenance" section to check whether the engine oil is leaking and whether the oil level is appropriate.
- 7) Check whether the engine fuel leaks and the oil level is appropriate. When the fuel indicator lights up, please refuel in time.
- 8) Check the engine indicator. If the indicator is on, immediately ensure that the engine is off, mark the machine and check the engine

thoroughly with reference to the maintenance manual.

9) Check the following parts for damage, improper installation, loose or missing parts, and unauthorized changes:

- Electrical plugs, wiring and cables
- Boarding controller, getting-off controller
- Platform control handle
- Tilt angle sensor, long angle sensor and weighing sensor
- Display, alarm indicator, flashing light, horn, buzzer, broken rope limit switch and drive enabling limit switch
- Valve block, hose, hydraulic joint, cylinder, motor and reducer
- Fuel tank and hydraulic oil tank, hydraulic oil cooler
- Wear pad, tire and slewing bearing
- Nuts, bolts and other fasteners
- Platform entrance lift

10) Check the complete machine to find:

- Crack in a weld or structural member
- Dent or damage to the machine
- Severe rust, corrosion or oxidation

Ensure that all structural members and other critical components are complete and that all relevant fasteners and pins are in the correct position and tightened. After completing the inspection, ensure that the hood is properly positioned and locked.

Chapter 7 Workplace Inspection

To order go to Discount-Equipment.com

7.1 Basic principles

- 1) Workplace inspection helps the operator to determine whether the workplace is safe for operation. The operator should do this work before moving the machine to the workplace.
- 2) It is the operator's responsibility to understand and remember the hazards in the workplace so that he/she can be aware of and avoid these problems when moving, installing and operating the machine.

7.2 Workplace inspection

Beware of and avoid the following dangerous situations:

- Steep slope or cave
- Protrusions, ground obstacle or debris
- Uneven surface
- Unstable or smooth surface
- Overhead obstacles and high voltage wires
- Surface support that is not sufficient to withstand the full load applied by the vehicle
- Instantaneous wind speeds exceed 12.5m/s/28mph.
- If the ambient temperature and humidity exceed the required temperature and humidity requirements, please refer to the working conditions in the machine Specifications section of this manual.
- The presence of unauthorized personnel
- Other possible unsafe situations

Chapter 8 Functional Test

To order go to Discount-Equipment.com

8.1 Basic Principles

- 1) You have understood and practiced the rules for safe operation of the machine in this operation manual.
- 2) According to on-site needs, you have been equipped with full-body protective equipment such as helmets, safety belts, safety shoes and goggles, and are in good physical condition.
- 3) Choose a test area that is solid, level and free of obstructions.
- 4) To avoid dangerous situations, you know and understand the safety rules before moving to the next step.
- 5) Functional tests are used for detecting faults before starting to use the machine.
- 6) The operator must follow the procedure to test all the functions of the machine.
- 7) It's forbidden to use a malfunctioning machine. If a fault is found, the machine must be marked and stopped.
- 8) Only qualified maintenance technicians can repair the machine according to our company's regulations.
- 9) After the repair, the operator must perform the pre-operational check and functional test again before starting to use the machine.

8.2 From the Ground Control Station

- 1) Turn the key switch to the ground control station position.
- 2) Pull out the red "emergency stop" button to the "ON" position, and the warning light will begin to flash.
- 3) Refer to the "Operation Instructions" section and start the engine.
- 4) Test the emergency stop
 - Push the red "emergency stop" button inward to the "off" position.

Result: The engine is off and none of the functions work.

- Pull the red emergency stop button to the "on" position to restart the engine.
- 5) Test the machine function
 - Do not press and hold the function enabling switch. Try to enable each boom and platform function toggle switch.

Result: All boom and platform functions are not operational.

- Press and hold the function enabling button switch and start each boom and platform function toggle switch.

Result: All boom and platform functions run for a full cycle. When the platform lowers, the alarm sounds.

- 6) Test the function of the emergency power unit.



Caution: Perform this step with

the engine shut down. In order to save battery energy, test each function half a cycle.

- Turn the key switch to the ground control station and pull out the red emergency stop button to the "on" position.
- At the same time, press the emergency power unit switch to the on position and start each arm function switch.

Result: All boom functions are operational.

- 7) Inspect the automatic leveling of the work platform.
 - Start the engine from the ground.
 - Press the function enable switch and use the platform leveling switch to adjust the work platform to the horizontal position.
 - Raise and lower the boom through a full cycle.

Result: The work platform is always level.

8.3 From the Platform Control Station

- 1) Test emergency stop

- Turn the key switch to the platform control station position.
- Enter the platform to pull out the red "emergency stop" button and start the engine.
- Push the red "emergency stop" button of the platform to the off position.

Result: The engine is off and no function can be operated.

2) Test the horn

- Press the horn button.

Result: The horn sounds.

3) Test the foot switch

- Push the red "emergency stop" button of the platform to the off position.
- Pull out the red "emergency stop" button to the on position and do not start the engine.
- Press down the foot switch and try to start the engine by pulling the start switch to the upper side.

Result: The engine does not start.

- Do not press the foot switch and restart the engine.
- Do not press the foot switch and test the machine's actions.

Result: None of the actions are running.

4) Test the machine function

- Press down the foot switch.
- Start each function control handle or toggle switch on the machine.

Result: All boom/platform actions work properly in one full cycle.

5) Test the auxiliary power function



Caution: Perform this step when

the engine is off. In order to save battery energy, test each function half a cycle.

- Turn the key switch to the platform control station position.
- Pull out the red emergency stop button to the "on" position on the work platform

control and press the foot switch.

- Press the emergency power unit switch to the "on" position and turn on each function control handle or toggle switch.

Result: All boom and steering functions and drive functions do not operate.

6) Test the steering

- Press down the foot switch.
- Press the left side of the thumb stick switch on the top of the drive control handle.

Result: The steering wheel turns in the direction indicated by the colorless arrow on the drive chassis.

- Press the right side of the thumb stick switch on the top of the drive control handle.

Result: The steering wheel turns in the direction indicated by the yellow arrow on the drive chassis.

7) Test the drive and brake function

- Press down the foot switch.
- Slowly move the drive control handle forward until the machine begins to move, and then return the handle to the center position.

Result: The machine should move in the direction indicated by the colorless arrow on the drive chassis and then stop suddenly.

- Slowly move the drive control handle backward until the machine begins to move, and then return the handle to the center position.

Result: The machine should move in the direction indicated by the yellow arrow on the drive chassis and then stop suddenly.



Caution: The brakes must be able to hold the machine on any slope that it can climb.

8) Test the tilt angle sensor

- Start the engine and drive the machine to a certain slope, then make the turntable tilt 4.5° along the direction of the boom, which has an upward variable amplitude of

5° or an extension of 0.6m/2ft.

Result: The alarm on the platform sounds.

- Drive the machine to a certain slope, and then make the turntable tilt 4.5° along the vertical direction of the boom, which has an upward variable amplitude of 5° or an extension of 0.6m/2ft.

Result: The alarm on the platform sounds.

- Drive the machine to a certain slope to make the buzzer sound.
- Start all boom functions in succession.
- Operate the handle to start the turntable rotary function.

Result: The upward variable amplitude of the boom cannot continue after reaching the position of 5° above the horizontal plane. The boom cannot continue to extend after an extension of 0.6m/2ft. The rest of the boom functions can be used normally, the turntable cannot be rotated and the drive function cannot be used.



Caution: If the turntable tilts

4.5° along the direction of the boom or 4.5° along the vertical direction of the boom, the boom can rise to 5° above the horizontal plane or the boom can extend more than 0.6 m. The machine should be marked immediately and stopped using.

9) Test the floating cylinder

- Start the engine on the platform.
- Drive the right steering wheel to a 0.15m/0.5ft high obstacle or curb.

Result: The other three tires are in close contact with the ground.

- Drive the left steering wheel to a 0.15m/0.5ft high obstacle or curb.

Result: The other three tires are in close contact with the ground.

- Drive the left rear wheel to a 0.15m/0.5ft high obstacle or curb.

Result: The other three tires are in close contact

with the ground.

- Drive the right rear wheel to a 0.15m/0.5ft high obstacle or curb.
- Result: The other three tires are in close contact with the ground.

10) Test the drive enabling system



Figure 8-1 Drive enabling

- Press down the foot switch and descend the boom to the retracted state.
- Rotate the turntable until the boom is turned to a certain angle, as shown in Figure 8-1.

Result: The drive enabling indicator should be illuminated when the boom is at the position.

- Move the drive control handle away from the center position.

Result: The drive function does not work.

- Move the drive enabling switch to the upper side while slowly moving the drive controller handle away from the center position.

Result: The drive function operates and the maximum drive speed that can be achieved does not exceed 0.8km/h/0.5mph.



Caution: When using the drive enabling system, the machine may travel in the opposite direction of travel and steering control handle movement. Use the color-coded direction arrows on the drive chassis to determine the direction of movement.

11) Test the limited drive speed

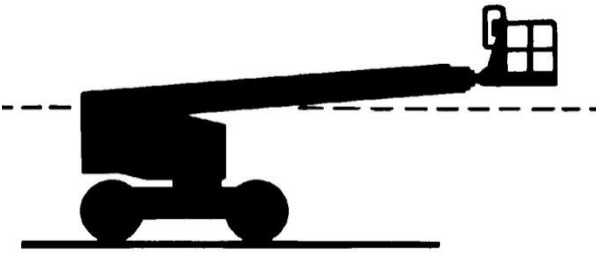

Figure 8-2 Drive limit

- Press down the foot switch.
- Raise the boom to 5° above the horizontal plane.
- Slowly move the drive control handle to the full drive position.

Result: When the boom is lifted, the maximum drive speed that can be achieved does not exceed 0.8km/h/0.5mph.

- Lower the boom to the retracted state.
- Extend the boom by about 0.6m/2ft.
- Slowly move the drive control handle to the full drive position.

Result: When the boom is in the extended state, the maximum drive speed that can be achieved does not exceed 0.8km/h/0.5mph.

! Caution: If the drive speed of the boom when it is raised or extended exceeds 0.8km/h/0.5mph, the machine should be tagged out and taken out of service immediately.

12) Test the limited rotary speed of the turntable

- Press down the foot switch.
- Raise the boom to 5° above the horizontal plane.
- Slowly move the turntable control handle to the full drive position.

Result: The time it takes the boom to rotate for a circle in the extended state is not less than 125s(T65J)/170s(T85J).

- Lower the boom to the retracted state.
- Extend the boom by about 0.6m/2ft.
- Slowly move the turntable control handle to the full drive position.

Result: The time it takes the boom to rotate for a circle in the extended state is not less than 125s(T65J)/170s(T85J).

! Caution: If the time it takes the boom to rotate for a circle in the extended state is less than 125s(T65J)/170s(T85J), the machine should be tagged out and taken out of service immediately.

12) Test the platform overload

- T65J: Load more than 250Kg/551 lbs of weight on the platform.
- T85J: Load more than 250Kg/551 lbs (under the mode that the range of motion of the boom is restricted) or 340Kg/750lbs (under the mode that the range of motion of the boom is unrestricted) of weight on the platform.

Result: The indicator lamp is ON, the buzzer sounds, and the machine can't move.

- Remove the load on the platform until the indicator lamp goes out.

Result: The machine can be operated.

14) Test the drive/boom function

- Press down the foot switch.
- Move the drive control handle away from the center position and start a boom function handle or toggle switch.

Result: All boom functions should be operational. The machine moves in the direction indicated on the control panel.

Chapter 9 Operation Instructions

To order go to Discount-Equipment.com

9.1 Basic principles

- 1) This machine is hydraulically-driven aerial work equipment that is equipped with a work platform on a straight boom mechanism. This machine can be used to load workers and their portable tools to a certain height from the ground, or to reach a certain work area above the machine or equipment.
- 2) The operation instructions section provides specific instructions for all aspects of the operation of the machine. It is the operator's responsibility to follow all safety rules and instructions in the operation manual.
- 3) This machine is designed for lifting workers and tools to the overhead workplace, it is unsafe or even dangerous to use the vehicle for other purposes.



Warning: This machine is strictly

prohibited from carrying loads or being used as a crane.

- 4) Only trained and authorized personnel can operate the machine. If more than one operator uses the same machine at different times during the same shift, they must all be qualified operators and follow all safety rules and instructions in the operation manual. This means that every new operator should perform pre-operational checks, functional tests and workplace inspections before operating the machine.

9.2 Starting the Engine

- 1) From the ground control station, turn the key switch to the required position.
- 2) Ensure red "Emergency Shutdown" buttons on the ground control station and the platform control station are pulled to the ON position.
- 3) The engine can be automatically preheated at low temperatures when the whole vehicle is powered on.

- 3) Turn the engine startup switch to the upper side for 2s to 3s. In the case of failure to startup or halt for the engine, disenable the startup switch for 3s during startup.
- 4) In the case of failure to start the engine upon 15s, find out the reason and repair the fault. Wait for 60s before trying to restart the engine.
- 5) At -6°C and lower temperature, upon startup, keep the engine at idle speed for 5 min prior to operation to prevent damage to the lubrication system for the engine.
- 6) At temperature lower than -18°C , try to start up the engine, and boosting battery may be used.



Caution: Upon the normal running of the engine, do not start up again.

9.3 Emergency Stop

- 1) Push the red emergency shutdown button on the ground or upper control box to the "OFF" position to stop all functions and shut down the engine.
- 2) If any operational functions need to be fixed, it is necessary to implement after pressing the red "Emergency Shutdown" button.
- 3) Select and operate the red "Emergency Shutdown" button of the lower control box to shut down the platform.
- 4) Allow the engine to idle for 5 minutes before shutting it off after a full load operation. Failure to do so may lead to turbo-charger trouble.

9.4 Auxiliary Power

If the main power fails, the auxiliary power should be used.

- 1) Turn the key switch to the ground or platform for control.
- 2) Pull out the red "Emergency Shutdown" button to the "ON" position.
- 3) When operating the power unit (i.e., emergency pump) on the platform, press

the foot switch.

- 4) Enable the desired function while keeping the power unit (i.e., emergency pump) open. The drive function will not work with the power unit.
- 5) Do not use the auxiliary power for a period of more than 30min.

9.5 Operation from the Ground Control Station

- 1) Turn the key switch to the lower control box.
- 2) Pull the red “Emergency Stop” button to the “ON” position.
- 3) Push the engine startup switch of the engine to the start position for 2s to 3s, followed by starting up the engine.
- 4) Adjust platform position.
 - Press and hold the function enabling button.
 - Move the proper toggle switch according to the mark on the control panel, and adjust the platform to the suitable position. Driving and steering functions cannot be used on the ground.
- 5) Selection of engine idle speed
 - Select engine idle speed with the sign on the control panel.

Turtle sign: Press the function enabling button to activate low idle speed.

Rabbit sign: Press the function enabling button, and turn the switch to activate high idle speed.

- In the case of, the engine will keep idle speed at the lowest rpm level.

9.6 Operation from the Platform Control Station

- 1) Turn the key switch to the upper control box position.
- 2) Pull out the red “Emergency Shutdown” buttons on the ground and the platform to the “ON” position.
- 3) Push the engine startup switch to the start

position for 2s to 3s, followed by starting up the engine. Do not step down on the pedal switch when starting up the engine.

- 4) Adjust platform position
 - Step down on the pedal switch.
 - Slowly activate the function control handle or the toggle switch as per the icon on the control panel.
- 5) Steering
 - Step down on the pedal switch.
 - Turn the steering wheels by pushing the thumb rocker on the top of the control handle. Press the button on the left side of the thumb rocker, the steering wheel of the machine will turn left; and press the button on the right side of the thumb rocker, the steering wheels of the machine will turn right.



Caution: Determine the steering direction of the wheels using the direction arrows on the upper control box and the machine chassis.

- 6) Driving
 - Step down on the pedal switch.
 - Increase the speed: Slowly move the driving controller handle, making it off center.

Decrease the speed: Slowly move the driving controller handle, making it point at the center.

Stop: Make the driving control handle return to the center or release the pedal switch.

- When the boom rises to the horizontal plane by more than 5° or extends out of 0.6m/2ft, the moving speed of machine will not exceed 0.8km/h/0.5mph.



Caution: Determine the direction of driving the machine using color label direction arrows on the upper control box and the driving chassis.

- 7) Drive the machine on a slope
 - Determine the uphill, downhill and side

slope ratings of the vehicle.



Maximum slope rated value, down-slope of platform (gradeability): 45% (24°)



Maximum slope rated value, up-slope of platform: 30% (17 °)



Maximum slope rated value: 25% (14°)



Caution: The slope rating is

limited by the ground conditions and traction.

- Determine the boom is located between the non-steering wheels, and the boom is lowered to below 5° of horizontal and is in the retracted position. When the turntable tilts by 4.5° along the direction of the boom, the alarm sounds, the tilt lamp is ON, at which driving function and boom function are not limited. The driving speed selector switch can be turned to the slope sign to get more driving torque.



Caution: When the boom is

located above 5° of horizontal plane, the driving function will be limited, until the boom is lowered to below 5°.

- Determine slope

Measure the slope by using a digital inclinometer or as per the following steps.

- ✓ Required tools: Carpenters rule, straight wood block (with length of at least 1m), tape measure and other tools.
- ✓ Place the wood block on the slope, place the carpenters rule on the upper limb of the wood block at the end of down-slope, and lift the end of the wood block until it is horizontal.

- ✓ Keep the wood block in the horizontal state, and measure vertical height from the bottom of the wood block to the ground.
- ✓ Height is divided by the length of wood block (stroke), i.e.,



Stroke=3.6m/11.8ft

lifting height=0.3m/1ft

$0.3 \div 3.6 = 0.083 = 8.3\%$



Caution: If the slope exceeds the maximum uphill, downhill or side slope rating, the vehicle must be lifted or transported up and down the slope. See the Transportation and Lifting section for further instructions on transporting the machine.

8) Drive enabling

- If the indicator is on, it indicates that the boom has moved beyond one of the two non-steering wheels and the drive function is disabled.
- To drive, turn the driving enabling switch to eight side, while slowly moving the driving control handle to make it off center.



Caution The vehicle may move in the opposite direction to the drive and steering control handles.

9) Selection of drive speed

- The machine is located at sign on the slope: The engine is switched to high idle speed automatically. To acquire more driving torque, select the slope sign on the inclined or rough ground.
- The machine is located at the sign on the horizontal plane: For operation of maximum

driving speed.

10) Selection of engine idle speed

- Select engine idle speed with the sign on the control panel.
- In the case of failure to stepdown of pedal switch or toggling of handle, the engine will keep idle speed at the lowest revolution.

Turtle sign: Step down the pedal switch to activate low idle speed.

Rabbit sign: Step down the pedal switch, and toggle the handle to activate high idle speed.

9.7 Platform overload

The platform overload indicating lamp is ON, and the buzzer gives an alarm. Unload from the platform until the indicating lamp is OFF before continuing to operate.

9.8 Tilt Indicator

If the lamp is on, it indicates the vehicle is not level. When the indicator is on, the alarm will sound and the vehicle must be moved to a hard, level surface. Determine the state of the articulating boom on slope, as shown below. Before moving the machine to the solid and horizontal ground, lower the articulating boom per the following steps. Before lowering the boom, do not rotate the boom.



If the tilt alarm sounds on the up-slope of platform:

1. Lower the boom.
2. Retract the boom.



If the tilt alarm sounds on the down-slope of

platform:

1. Retract the boom.
2. Lower the boom.

9.9 System Fault

The alarm sounds, and the system fault indicating lamp is ON, indicating that the control system has a fault. The LED display will show the corresponding fault code, and the corresponding functions of the machine will be shut down, shown as Table 9-1.

When the system indicating lamp is ON, operate as per the following steps:

- 1) Lower and retract boom.
- 2) Move the machine to the stowed position, shut down the engine, tag out the machine and shut down.
- 3) The machine can be used again only after relevant qualified personnel maintain, troubleshoot and conduct complete inspection.
- 4) System fault code is shown as the following figure:

error code	Description	Limit action
1	Controller output power supply 1 open circuit	Main boom upper luffing
2	Controller output power supply 2 open circuit	Main boom upper luffing
3	Controller output power supply 3, 4 open circuit	Main boom upper luffing
4	The CAN bus of the expansion module of the platform electric box is disconnected	Equivalent to the limit logic of all three handle failures and load cell failures
7	Turntable tilt sensor failure	Main boom upper luffing, main boom lower luffing, main boom extended, main boom retracted, turntable rotation, walking
8	Load cell 1 failure	Main boom upper luffing
9	Load cell 2 failure	Main boom upper luffing
10	Load cell 3 failure	Main boom upper luffing
11	Load cell 4 failure	Main boom upper luffing
12	Left handle failure	Main boom upper luffing 、 main boom lower luffing (platform operation), turntable rotation (platform operation)
13	Right handle failure	Main boom upper luffing、 walking、 steering
14	Middle handle failure	Main boom upper luffing, main boom extended, main boom retracted (platform operation)
15	Wire rope disconnect	Main boom upper luffing, main boom lower luffing, main boom extended, main boom retracted、 turntable rotation, walking
16	Main boom angle sensor 1 failure	Main boom upper luffing
17	Main boom angle sensor 2 failure	Main boom upper luffing
18	Main boom angle sensor calibration failure	Main boom upper luffing
19	Boom length sensor 1 failure	Main boom upper luffing、 main boom extended
20	Boom length sensor 2 failure	Main boom upper luffing、 main boom extended
21	Main arm length sensor calibration failure	Main boom upper luffing、 main boom extended
22	Load cell calibration failure	Main boom upper luffing
23	Main boom retraction approach switch 1 failure	Main boom upper luffing
24	Main boom retraction approach switch 2 failure	Main boom upper luffing
25	Main boom extension approach switch 3 failure	Main boom upper luffing
26	Main boom extension approach switch 4 failure	Main boom upper luffing
101	The maximum angle of the boom is limited upward	Main boom upper luffing
102	The minimum angle of the main boom is limited downward	main boom lower luffing
103	Maximum boom extension limit	main boom extended
104	The minimum length of the main boom retracts limit	main boom retracted
105	Turntable tilt	

106	The turntable is tilted, the main boom angle is greater than positive 5 degrees, the main boom is up and the main boom is extended	Main boom upper luffing, main boom extended, turntable rotation, walking
107	The turntable is tilted, the extension length of the main boom exceeds 60cm, the main boom is in the upward range, and the main boom extension is limited	Main boom upper luffing, main boom extended, turntable rotation, walking
109	Drive does not enable travel function limit	Walking
110	Platform overload	Limit all actions
111	Long angle sensor bus disconnected	Main boom upper luffing, main boom extended
112	Long angle sensor failure	Main boom upper luffing, main boom extended
113	Low fuel level alarm	
114	Operating range exceeds the safety zone limit	Main boom lower luffing, main boom extended
115	Manual lock reminder	Main boom upper luffing, main boom extended
116	Manually lock the car	Main boom upper luffing, main boom extended, walking
117	GPS and ECU do not match	
118	GPS is removed	Main boom upper luffing, main boom extended

Table 9-1 System fault codes and limit actions

To order go to Discount-Equipment.com

9.10 Parking and Storage

- 1) Select a solid, level, and safe position where it is moisture-proof, high-temperature resistant, open flame resistant, free from corrosive gas and well-ventilated.
- 2) Retract and lower the boom to the stowed state.
- 3) Close and lock all enclosures and box doors.
- 4) Wipe up dust and oil dirt on the machine body, and keep the machine clean.
- 5) Rotate the turntable to make the boom located between non-steering wheels.
- 6) Secure the wheels using wheel chocks.
- 7) Turn the key toggle switch to the "OFF" position, and remove the key to avoid unauthorized use.
- 8) During long-term storage
 - Disconnect the positive and negative electrodes of the battery, drain the fuel completely, and prior to use, conduct overall cleaning and maintenance on the entire machine.
 - When the storage period exceeds three months, run the machine for not less than one hour every three months, and conduct cleaning and maintenance.

Chapter 10 Instructions for Transportation and Lifting

To order go to Discount-Equipment.com

10.1 Compliance

- 1) The transport driver shall be responsible for ensuring the machine has been secured correctly and select proper trailers according to local traffic laws.
- 2) Only personnel with high-altitude lifting qualifications can load and unload the vehicle.
- 3) The transport vehicle must be parked on a level surface.
- 4) When loading the vehicle, the transport vehicle must be secured to prevent movement.
- 5) Make sure the transport vehicle's capacity, loading surface, chains or belts are sufficient to withstand the weight of the vehicle. Refer to the nameplate for the weight of the vehicle.

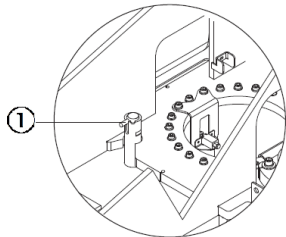

Figure 10-1 Turntable Lock Pin

- 6) Ensure the turntable has been secured using the turntable lock prior to transport, as shown in Figure 10-1. Ensure the turntable is unlocked during operation.
- 7) Do not drive the vehicle on a slope that exceeds the vehicle's uphill, downhill or slope rating. Refer to "Drive on the Slope" in the "Operation Instructions" section.
- 8) If the slope of the transport vehicle exceeds the maximum slope rating, the winch must be used to load and unload the vehicle as specified.
- 9) The vehicle is equipped with a sophisticated weighting system. It is forbidden to place heavy goods on the platform, when the vehicle is transporting, otherwise the weighting system may be damaged.

10.2 Freewheel configuration for trailers

- 1) Wedge the wheel to prevent the vehicle from moving.

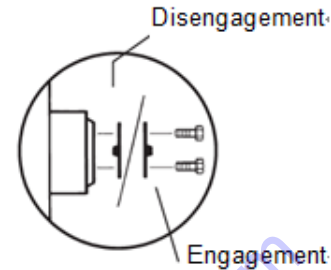

Figure 10-2 Brake release

- 2) Turn over all four driving wheel hub separating covers to release wheel brakes, as shown in Figure 10-2.
- 3) Make sure that the winch cable is properly secured to the fastening point of the drive chassis and that there are no obstacles in the moving direction.
- 4) Reverse the above procedures to reengage the brakes.



Caution: The drive control shall

always be kept in the off state.

10.3 Transportation Safety

- 1) When transporting the machine every time, it is necessary to lock the turntable using the turntable lock pin, as shown in Figure 10-1.
- 2) Prior to transport, turn the key switch to the "OFF" position, followed by removing the key.
- 3) Conduct a complete inspection of the machine to ensure there are no loose or unsecured components.
- 4) Secure the chassis.
- 5) Ensure the chains or belts have sufficient load strength, and use at least 5 chains. Adjust the rigging to prevent damage to chains, as shown in Figure 10-3.

- 6) Secure the platform.
- 7) Place a block below the platform rotator, making sure to not make the block contact the platform cylinder. Make the nylon strap runs through the platform support to secure the platform. Do not apply excessive downward force when securing boom components, as shown in Figure 10-4.

10.4 Instructions for Lifting the Machine

- 1) Only qualified hoisting and rigging workers can assemble the rigging and lift the machine.

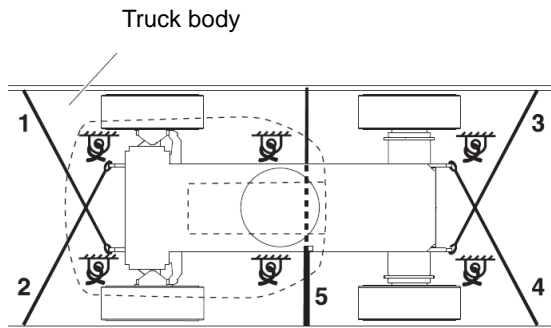

Figure 10-3 Schematic diagram of chassis fixing

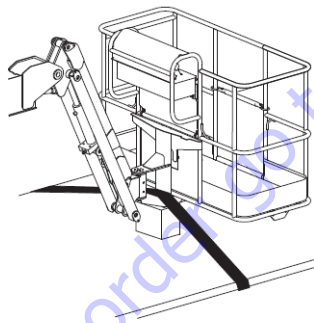

Figure 10-4 Schematic diagram of platform fixing

- 2) Ensure the lifting capacity of crane, belts or straps is sufficient to support the weight of the machine. Please refer to "Nameplate" for the weight of the machine.
- 3) Completely lower and retract the boom, and disassemble all loosened components on the machine.
- 4) Secure the turntable using the turntable lock. Determine the center of gravity of the machine using data in Figure 10-5.
- 5) Only connect the rigging to the designated

lifting points of the machine.

- 6) Adjust the rigging to avoid damage to the machine and keep the machine level.

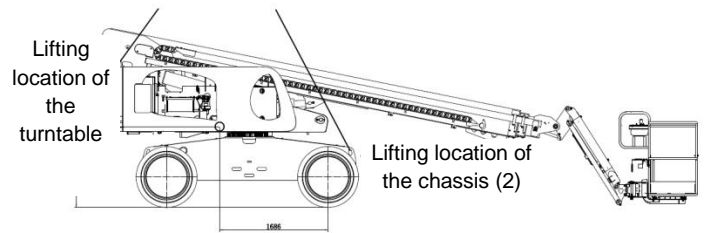

Figure 10-5 Schematic diagram of connection during machine lifting

California Proposition 65

 **WARNING**

Operating, servicing and maintaining this equipment can expose you to chemicals including engine exhaust, carbon monoxide, phthalates, and lead, which are known to the State of California to cause cancer and birth defects or other reproductive harm. These chemicals can be emitted from or contained in other various parts and systems, fluids and some component wear by-products. To minimize exposure, avoid breathing exhaust, do not idle the engine except as necessary, service your equipment and vehicle in a well-ventilated area and wear gloves or wash your hands frequently when servicing your equipment or vehicle and after operation. For more information go to www.P65Warnings.ca.gov/passenger-vehicle.

Breathing diesel engine exhaust exposes you to chemicals known to the State of California to cause cancer and birth defects or other reproductive harm.

- Always start and operate the engine in a well-ventilated area.
- If in an enclosed area, vent the exhaust to the outside.
- Do not modify or tamper with the exhaust system.
- Do not idle the engine except as necessary.

For more information go to www.P65warnings.ca.gov/diesel.

TO PURCHASE THIS PRODUCT PLEASE CONTACT US



**Equipment Financing and
Extended Warranties Available**



**Discount-Equipment.com is your online resource for
commercial and industrial quality parts and equipment sales.**

561-964-4949

visit us on line @ www.discount-equipment.com

Select an option below to find your Equipment

Search by Manufacturer

Search by Product Type

Request a Quote

We sell worldwide for the brands: Genie, Terex, JLG, MultiQuip, Mikasa, Essick, Whiteman, Mayco, Toro Stone, Diamond Products, Generac Magnum, Airman, Haulotte, Barreto, Power Blanket, Nifty Lift, Atlas Copco, Chicago Pneumatic, Allmand, Miller Curber, Skyjack, Lull, Skytrak, Tsurumi, Husquvarna Target, Stow, Wacker, Sakai, Mi-T-M, Sullair, Basic, Dynapac, MBW, Weber, Bartell, Bennar Newman, Haulotte, Ditch Runner, Menegotti, Morrison, Contec, Buddy, Crown, Edco, Wyco, Bomag, Laymor, EZ Trench, Bil-Jax, F.S. Curtis, Gehl Pavers, Heli, Honda, ICS/PowerGrit, IHI, Partner, Imer, Clipper, MMD, Koshin, Rice, CH&E, General Equipment, Amida, Coleman, NAC, Gradall, Square Shooter, Kent, Stanley, Tamco, Toku, Hatz, Kohler, Robin, Wisconsin, Northrock, Oztec, Toker TK, Rol-Air, APT, Wylie, Ingersoll Rand / Doosan, Innovatech, Con X, Ammann, Mecalac, Makinex, Smith Surface Prep, Small Line, Wanco, Yanmar



www.Discount-Equipment.com

T65J/T85J

Mobile Elevating Work Platform
Operation and Safety Manual

Third Edition – May 2021



LGMG North America Inc.