



WHEELBARROW MIXER

Part# MIX3, MIX3-UK | EDI# 27275, 27276



Go to Discount-Equipment.com to order your parts



www.Discount-Equipment.com

TO PURCHASE THIS PRODUCT PLEASE CONTACT US



**Equipment Financing and
Extended Warranties Available**



**Discount-Equipment.com is your online resource for
commercial and industrial quality parts and equipment sales.**

561-964-4949

visit us on line @ www.discount-equipment.com

Select an option below to find your Equipment

Search by Manufacturer

Search by Product Type

Request a Quote

We sell worldwide for the brands: Genie, Terex, JLG, MultiQuip, Mikasa, Essick, Whiteman, Mayco, Toro Stone, Diamond Products, Generac Magnum, Airman, Haulotte, Barreto, Power Blanket, Nifty Lift, Atlas Copco, Chicago Pneumatic, Allmand, Miller Curber, Skyjack, Lull, Skytrak, Tsurumi, Husquvarna Target, Stow, Wacker, Sakai, Mi-T-M, Sullair, Basic, Dynapac, MBW, Weber, Bartell, Bennar Newman, Haulotte, Ditch Runner, Menegotti, Morrison, Contec, Buddy, Crown, Edco, Wyco, Bomag, Laymor, EZ Trench, Bil-Jax, F.S. Curtis, Gehl Pavers, Heli, Honda, ICS/PowerGrit, IHI, Partner, Imer, Clipper, MMD, Koshin, Rice, CH&E, General Equipment, Amida, Coleman, NAC, Gradall, Square Shooter, Kent, Stanley, Tamco, Toku, Hatz, Kohler, Robin, Wisconsin, Northrock, Oztec, Toker TK, Rol-Air, APT, Wylie, Ingersoll Rand / Doosan, Innovatech, Con X, Ammann, Mecalac, Makinex, Smith Surface Prep, Small Line, Wanco, Yanmar

TABLE OF CONTENTS

Introduction.....	2
Safety Precautions.....	3
Warranty.....	4
Assembly Guide	
Parts	5
Hardware	6
Frame.....	7
Handle	8
Wheels.....	9
Attach Motor.....	10
Drum Blades.....	11
Attach Drum.....	12
Motor Hood	13
Pedestal.....	14
Attach Mixer to Pedestal	15
Operation	16
Concrete Mixing Guide	16
Issues & Resolution.....	17
Parts & Service Information	17

INTRODUCTION

The Marshalltown Wheelbarrow mixer is great for the do-it-yourself home project. It allows you to work almost anywhere. The mixer will clear a 30" door and easily fits into an elevator. A sturdy 110-volt or 230-volt electric motor allows you to work indoors without emissions.

An included pedestal allows the mix to be discharged into wheelbarrows, buckets or between forms easily.

Used in the mixing of concrete, adhesives, chemicals, seed, and grain - there are many options.

- Mixes 3 Cu. Ft. of cement, mortar mix, or 7 bags of 60 lbs. concrete mix.
- High torque 1/2 HP single phase 110 volt/60 Hz (North America configuration) or 230 Volt/50 Hz (Europe/Asia/Africa/Australia configuration) electric motor with "On/Off" Switch
- Rugged steel drum
- Direct drive gearbox – easy to assemble, no belts or pulleys
- Fast mixing and easy clean up
- Lightweight – 110 lbs. (49.89 kg) – Can ship UPS
- Clears a 30 inch (76.20cm) door opening
- Spins at 28 RPM
- Drum diameter: 24" (61cm)
- Discharge outlet height: 18" (45.72cm)
- Wheel dimensions: 14" x 3.5" (35.50cm x 8.90cm)
- Storage dimensions: 45" x 29" x 35.5" (1.14m x 0.75m x 0.90m)

SAFETY PRECAUTIONS



DANGER or WARNING safety signs are located near specific hazards.

General precautions are listed on CAUTION safety signs.



IMPORTANT—READ THIS MANUAL BEFORE ASSEMBLING OR OPERATING



After referring to the operation manual, if you still require assistance, please contact our customer service department.

This operator's manual has been prepared to provide the information you need to correctly operate and maintain your unit. Read it carefully and keep it for future reference.

The replacement of any part on this product by other than the manufacturer's authorized replacement part may adversely affect the performance, durability or safety of this product. Should you ever require repair parts or service, contact your authorized parts and service dealer.

The manufacturer reserves the right to make changes or add improvements to its product at any time without prior notice.

The manufacturer also reserves the right to decide, upon its discretion at any time, to discontinue a product.

Read and follow all safety precautions and operating instructions in this manual.

The following precautions are suggested to help prevent accidents. Before operating this equipment read all precautions. Only trained individuals should operate equipment. If the safety instructions and warnings are not read and carefully followed, personal injury could occur.

- Do not operate this mixer until all the warnings and safety instructions have been read and understood by the operator.



Keep all unauthorized and untrained people away from the mixer at all times.

- Wear safety glasses when mixer is in use.



Clear the work area around the machine to prevent tripping or falling onto the mixer.

- Operate on level ground to prevent the mixer from tipping over.
- Make sure that the mixing drum is clear of obstructions and stand clear of the mixer while making power cord connections.
- Properly grounded electric circuit is required to protect the operator from possible electric shock.
- Do not start the motor if the drum is fully loaded.
- DO NOT OPERATE this mixer under the influence of alcohol or while taking medication that impairs your reactions.
- Keep all people excluding the operator at least 5 feet away from the mixer during operation.
- NEVER run the mixer unattended, turn off the motor when you leave the machine.



Keep hands and clothing away from any moving parts while the mixer is running.



NEVER attempt to move the mixer while the motor is on.



NEVER plug or unplug the motor while standing in or around damp or wet ground.



Do not pull the cord to disconnect it. Keep the cord away from heat, oil, and sharp edges and in locations where it would not be easily tripped over.

- Keep the mixer clean and free of debris and aggregate build-up.
- Lightly grease wheel axles and the swivel bracket.
- Periodically examine the mixer for significant or abnormal damage/wear.
- Use factory authorized parts for replacement.

WARRANTY

This product is warranted to the original purchaser only, to be free of defects in material and workmanship under normal use, for one year from purchase date. Marshalltown Company shall, without charge for parts and labor, repair or replace such parts which are found to be defective. All transportation charges for replacement parts must be borne by the purchaser.

For warranty service, the product must be delivered, with proof of purchase date, to the dealer of original purchase, or any factory authorized service dealer. The delivery of the unit must be made no later than 30 days after the expiration of the warranty period.

If difficulty is encountered in having warranty work performed, contact the Customer Service Department at (800)888-0127.

All implied warranties, including those of merchantability and fitness for a particular purpose, are limited to one year from date of purchase by the original retail customer and to the extent permitted by law and all implied warranties are excluded and disclaimed after the expiration of such period.

Some states do not allow limitations on how long an implied warranty lasts, or the exclusion or limitations of incidental or consequential damages, so the above limitations or exclusions may not apply to you. This warranty gives you specific legal rights, and you may also have other rights, which vary from state to state.

Exclusion from this warranty:

1. The following items are not covered under the Marshalltown Company one year warranty and are warranted by their respective manufacturer.

- a) Motors

- b) Enclosed gear transmissions

NOTE: A copy of the warranty and service contact information for the above items is furnished with the individual product.

2. All consequential damages, including pickup and delivery of the unit, communication, mileage charges and/or rental of a replacement unit during repairs are not covered under this warranty, nor are any loss of income and/or other loss resulting from the failure of the product to function due to a warranty defect.

3. This warranty will not apply when the product becomes inoperative due to misuse, normal wear, neglect, improper maintenance, accident or freight damage; has not been operated and maintained in accordance with the instructions furnished in the Operator's Manual; or has been altered or modified without approval from the factory Service Department.

4. No parts or products are to be returned to the factory without prior written approval from the factory.

ASSEMBLY GUIDE - PARTS

1. Lay out the mixer parts.

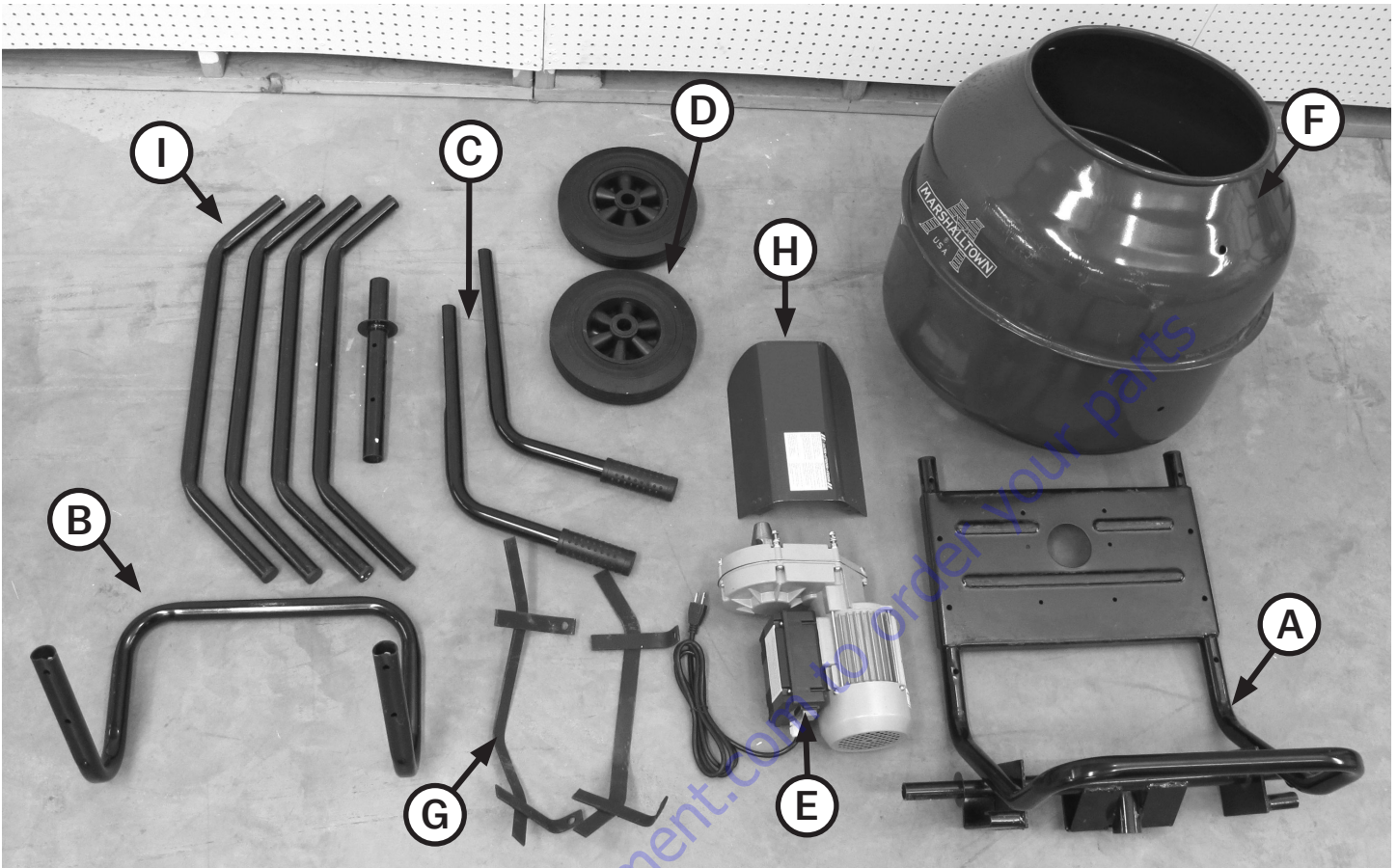

Refer to page 17 for instructions on reordering parts and mixer maintenance.

- | | | |
|------------------|------------------------|-----------------------|
| (A) Chassis | (D) Wheels (x2) | (G) Paddles (x2) |
| (B) Draw Bar | (E) Direct-Drive Motor | (H) Motor Hood |
| (C) Handles (x2) | (F) Drum | (I) Pedestal Assembly |

PARTS AVAILABLE FOR REPLACEMENT

	NAME	PART#
E	Motor Assembly	27278
E	Motor Assembly UK	27279
E	Motor Assembly France	27280
F	Drum	27281
*	On/Off Switch	27282
I	Pedestal	27283
D	Wheel (single)	27284
*	Gearbox	27285
G	Paddle (single)	27286

* Component of E

ASSEMBLY GUIDE - HARDWARE

2. Lay out all hardware

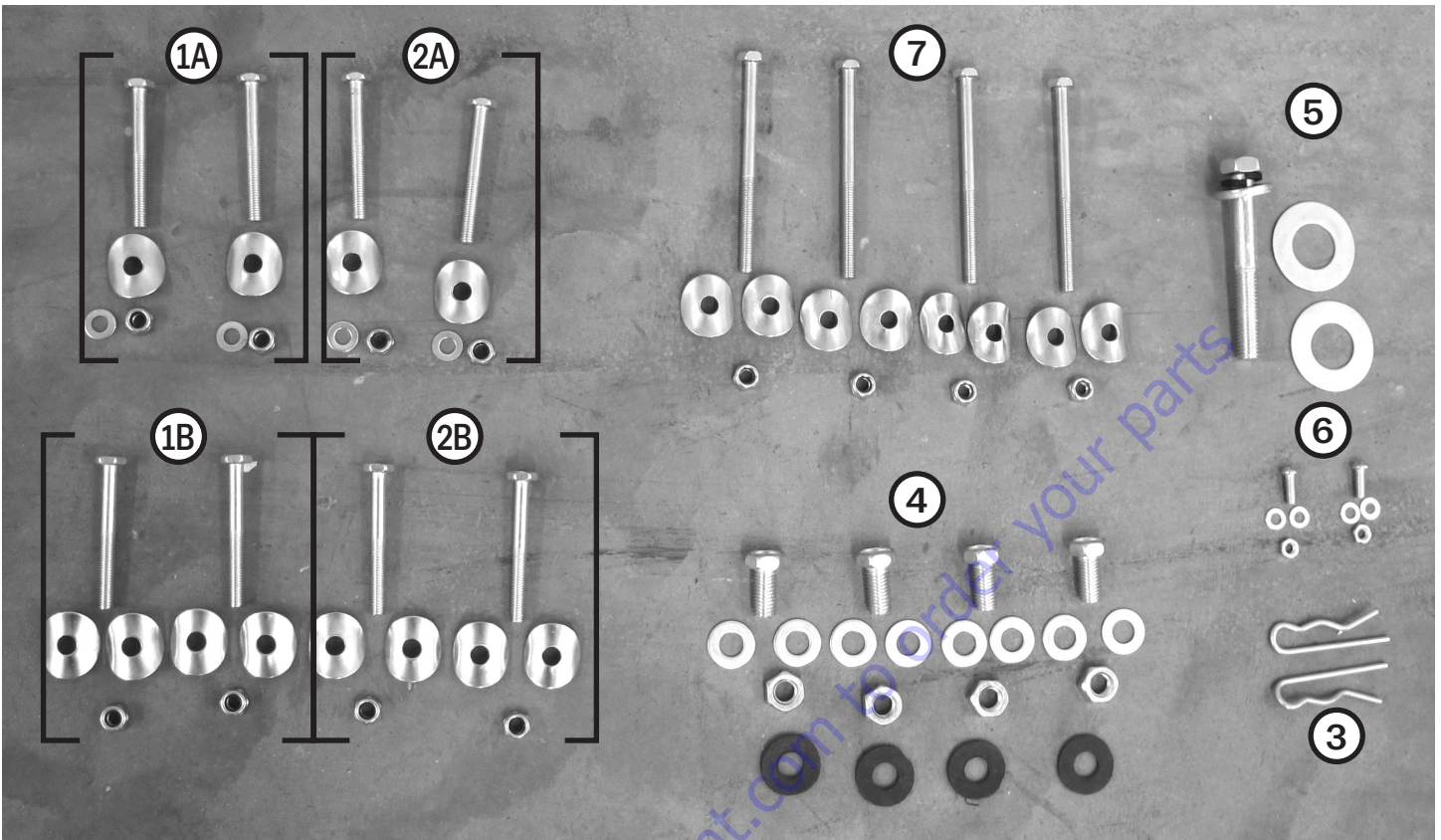

Refer to page 17 for instructions on reordering parts and mixer maintenance.

- | | | |
|---|---|---|
| <p>①A M8 x 70mm Hex Bolts (x2)
M8 Curved Washers (x2)
M8 Lock Nuts (x2)
M8 Washers (x2)</p> | <p>①B M8 x 70mm Hex Bolts (x2)
M8 Curved Washers (x4)
M8 Lock Nuts (x2)</p> | <p>②A M8 x 70mm Hex Bolts (x2)
M8 Curved Washers (x2)
M8 Lock Nuts (x2)
M8 Washers (x2)</p> |
| <p>②B M8 x 70mm Hex Bolts (x2)
M8 Curved Washers (x4)
M8 Lock Nuts (x2)</p> | <p>③ Cotter Pins (x2)</p> | <p>④ M12 x 25mm Hex Bolts (x4)
M12 Rubber Washers (x4)
M12 Washers (x8)
M12 Nuts (x4)</p> |
| <p>⑤ M14 x 108mm Hex Bolt
M14 Lock Washer
M14 Washer
14mm Washers (x2)</p> | <p>⑥ M6 x 40mm Machine Bolts (x2)
M6 Washers (x4)
M6 Lock Nuts (x2)</p> | <p>⑦ M8 x 105mm Hex Bolts (x4)
M8 Curved Washers (x8)
M8 Lock Nuts (x4)</p> |

ASSEMBLY GUIDE - FRAME (PARTS A & B)

3. Connect draw bar to the back of the drum frame. Hardware required: SETS 1A & 1B

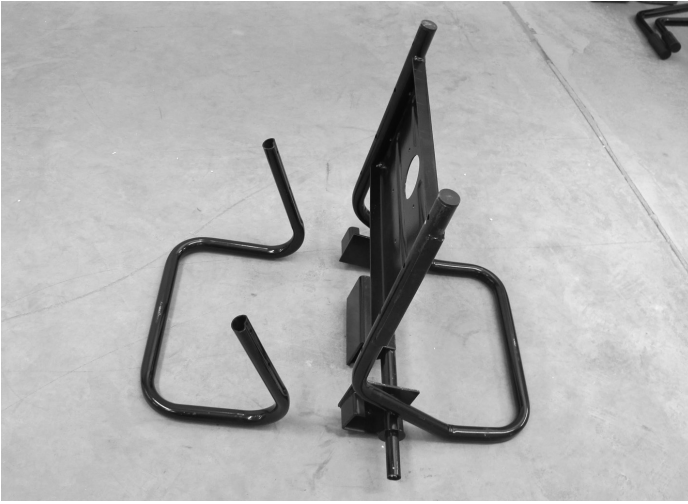

Use hardware **1A** on top, use **1B** on bottom.



Fasten using a 14mm wrench and 14mm socket.



Finished frame.

ASSEMBLY GUIDE - HANDLES (PARTS C)

4. Connect the handles to the drum frame. Hardware required: SETS 2A & 2B



Use hardware **2B** on top, **2A** on bottom.



Fasten using a 14mm wrench and 14mm socket.



Use hardware **2B** on top, **2A** on bottom.



Fasten using a 14mm wrench and 14mm socket.



Finished frame with handles.

ASSEMBLY GUIDE - WHEELS (PARTS D)

5. Connect wheels to the drum frame assembly. Hardware required: SET 3



Insert wheel and fasten with cotter pin. (Hardware 3)



Repeat step for other side.



Finished frame with wheels.

ASSEMBLY GUIDE - ATTACH MOTOR (PART E)

6. Mount engine on the drum frame assembly. **Hardware required:** (Hardware included on motor assembly)



Remove nuts and washers from motor studs.



Install with black box facing up.



Insert washers onto studs between nuts and frame, and fasten nuts using 10mm wrench and 10mm socket.



Finished frame with motor.

ASSEMBLY GUIDE - DRUM BLADES (PARTS F & G)

7. Connect drum blades to drum interior. Hardware required: SET 4

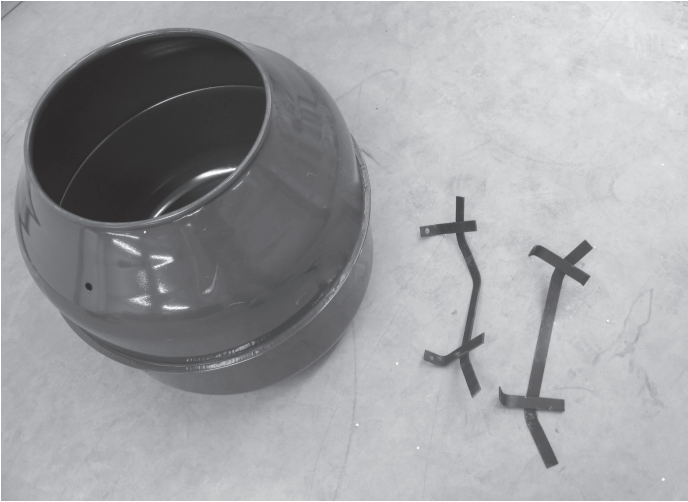

Insert bolts through drum.



Place rubber washers onto bolts.



Install paddles with short side facing outward, towards top of the drum.

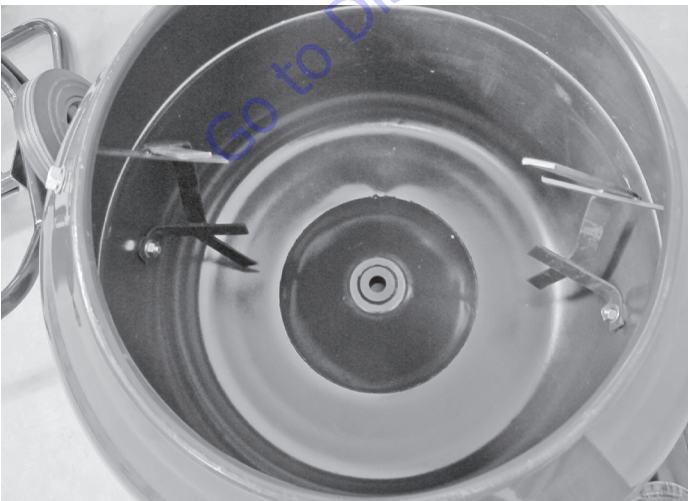

Fasten using a 19mm wrench and 19mm socket.

ASSEMBLY GUIDE - ATTACH DRUM

8. Connect drum to output drive shaft (align drum over set screw) **Hardware required: SET 5**



Align set screw using a standard screwdriver, perpendicular to mixer frame. **See Inset A**



NOTE: Assembly is easier with frame laying flat as shown.



Drum will straddle set screw and fit tightly on motor spindle.

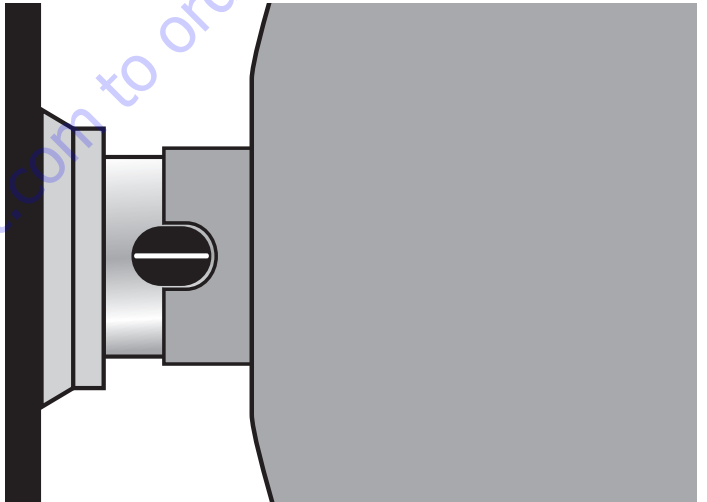

Inset A



Two washers placed on bottom of drum, secured with bolt.



Use a 22mm socket to tighten drum to motor spindle.

ASSEMBLY GUIDE - MOTOR HOOD (PART H)

9. Attach hood to drum frame assembly. Hardware required: SET 6

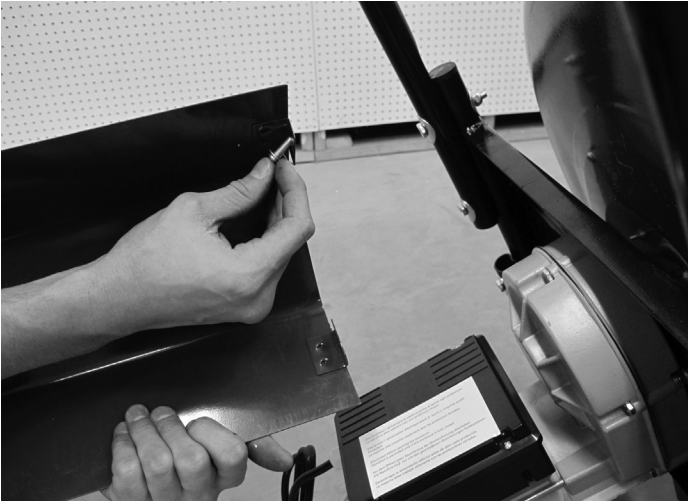

Put screws through mounting holes.



Mount to mixer frame.



Use a Phillips screwdriver and 10mm wrench to tighten.



Finished mixer.

ASSEMBLY GUIDE - PEDESTAL (PARTS I)

10. Assemble Pedestal. Parts Hardware Required: SET 7



Put screws through corresponding mounting holes, attach two legs as shown. **Note:** Two legs have high mounting holes, and two have lower mounting holes.



Tighten hardware using a 14mm wrench and 14mm socket.



Attach remaining legs.



Tighten remaining hardware.



Finished pedestal.

ASSEMBLY GUIDE - MIXER TO PEDESTAL

11. Mount mixer to pedestal



Lay mixer flat.



Lift mixer slightly and insert pedestal.



Grab mixer handles and carefully lift mixer into the upright position.



Completed mixer with pedestal.

OPERATION

GETTING READY FOR MIXING

Lay out forms for your concrete floor, patio, driveway, sidewalk, etc. The quality of concrete is directly related to the quality of the cement paste. The quality of the paste, in turn, is directly related to the amount of water mixed with the cement. For a given amount of cement, as the amount of mixing water is reduced, the strength of the paste increases, making the concrete stronger and more durable. Calculate the proportions of your mix components (cement, sand and coarse aggregate) according to the job specifications.

LOADING THE MIXER

Start the mixer. After drum has started rotating, pour about half of the water in the drum.

NOTE: The drum may leak slightly when first used. This will stop after a few batches. Add aggregate (gravel) first then cement and last sand. For mixing instructions, refer to the mixing guide below.

UNLOADING THE MIXER

Allow the entire mixture to mix for one full minute. Do not stop mixer from rotating. Dump concrete to either side by tilting the handles in the direction required. Before reloading the mixer, slowly pour a pail of water over the lip of the drum, permitting water to clean the inside of drum. When cleaned, dump water. Now you are ready for your next batch.

CARE OF MIXER

It is important to keep the inside of the mixing drum free of hardened concrete. After discharging the last batch of concrete each day, add a pailful of water and two shovelfuls of gravel to the drum. This will scour the inside of the drum. Mix for about two minutes, discharge and rinse the drum with water. Never permit concrete to harden on either the inside or outside of drum.

EXTENSION CORDS-ELECTRIC MOTOR

The following size extension cords should be used for this mixer: length of cord, up to 100 ft -14 gauge wire; up to 200 ft -12 gauge wire; up to 300 ft -10 gauge wire; up to 400 ft - 8 gauge wire.

LUBRICATION & STORAGE

Lightly grease all moving parts – motor spindle, wheel axles and pedestal mounting shaft with SAE 30 engine oil.

For short term storage, clean the mixer and store in a dry place. If the mixer is not to be used for an extended period of time, service mixer completely and store it in a dry place. Cover exposed metal surfaces with a thin coat of SAE 30 engine oil.

CONCRETE MIXING GUIDE

MIXING PRE-MIX CONCRETE

Needed:

1-1/4 gallons of water
(x1) 80 lb bag of pre-mix concrete

1. Start Mixer
2. Put in 1 gallon of water, or as specified in concrete mix instructions
3. Add 1/2 of 80 lb bag of pre-mix concrete – mixture will be very sloppy
4. Slowly add 2nd half bag of concrete
5. Add 1/4 gallon of water slowly to obtain desired thickness, or as specified in concrete mix instructions

MIXING SAND & GRAVEL

Needed:

Square point shovel
Portland cement
Gravel or round stone
Masonry sand

1. Start Mixer
2. Put in 1 gallon of water *
3. Add 3 shovels full of gravel or round stone
4. Add 1 shovel full of Portland cement
5. Add 2 shovels full of masonry sand – slowly
6. Add water to obtain desired thickness

* Amount of water will vary according to moisture content of sand and gravel.

ISSUES & RESOLUTIONS

ISSUE	RESOLUTION
There are parts missing in the package.	Contact MARSHALLTOWN customer service at (800)888-0127.
The drum wobbles and is unstable.	Review step 8 (page 12) in the operations manual to ensure that the drum is straddling the set screw appropriately. Make sure there is a lock washer, a small washer, and two large washers being used with the shaft spindle bolt. Make sure the drum seats fully on the taper.
The drum shaft bolt keeps backing out of the shaft spindle.	Review step 8 (page 12) in the operations manual to ensure that the drum is straddling the set screw appropriately. Make sure there is a lock washer, a small washer, and two large washers being used with the shaft spindle bolt. Make sure the drum seats fully on the taper.
The mixer is making a noise while mixing.	Review step 8 (page 12) in the operations manual to ensure that the drum is straddling the set screw appropriately.
The mixer is making a noise while mixing and the shaft is set properly.	Lightly grease the motor spindle.
The mixer is still making a noise.	Contact MARSHALLTOWN customer service at (800)888-0127.
The mixer is not spinning as fast as it should.	There will be some variation in the rotation of the mixer depending on the load in the mixer and how well the shaft spindle is lubricated. Other issues could be the extension cord is not the appropriate size. Use a 14 gauge cord up to 100'; 12 gauge to 200'; 10 gauge to 300'; 8 gauge to 400'.
The mixer is not mixing well.	There could be several reasons for this. First, review step 7 (page 11) to ensure that the paddles are installed correctly. If so, the mixture may require more water. Instead of starting with half the amount of water, start with 3/4 the amount of water needed. Variations in when and how much of the mixture is added will allow the mixer to mix better. The mixer may also need to run a little longer with the amount that is being mixed.
The pedestal will not fit together properly.	Review step 10 (page 14) two of the legs have mounting holes located higher on the pedestal and the other two have lower mounting holes.
The motor will not run.	Check to make sure that there is power to the mixer. Check to make sure there is nothing impeding the mixers rotation. Contact MARSHALLTOWN customer service if problem persists.
There is a problem with the motor.	If the problem has been isolated to the motor, please Contact MARSHALLTOWN customer service at (800)888-0127.

PARTS FINDER

**Search Website
by Part Number**



**Search Manual
Library For Parts
Manual & Lookup Part
Numbers – Purchase
or Request Quote**

Search Manuals

Enter your information to search for manuals and parts.

* Brand:

* Model:

* Serial:

* Part Number:

SEARCH

**Can't Find Part or
Manual? Request Help
by Manufacturer,
Model & Description**

Parts Order Form

Please fill in the following information:

Manufacturer:

Model:

Description:

Quantity:

Part Number:

Part Name:

Part Description:

Part Location:

Part Condition:

Part Status:

Part Color:

Part Material:

Part Weight:

Part Dimensions:

Part Price:

Part Notes:

Submit

Discount-Equipment.com is your online resource for quality parts & equipment.

Florida: **561-964-4949** Outside Florida TOLL FREE: **877-690-3101**

Need parts?

Click on this link: <http://www.discount-equipment.com/category/5443-parts/> and choose one of the options to help get the right parts and equipment you are looking for. Please have the machine model and serial number available in order to help us get you the correct parts. If you don't find the part on the website or on once of the online manuals, please fill out the request form and one of our experienced staff members will get back to you with a quote for the right part that your machine needs.

We sell worldwide for the brands: Genie, Terex, JLG, MultiQuip, Mikasa, Essick, Whiteman, Mayco, Toro Stone, Diamond Products, Generac Magnum, Airman, Haulotte, Barreto, Power Blanket, Nifty Lift, Atlas Copco, Chicago Pneumatic, Allmand, Miller Curber, Skyjack, Lull, Skytrak, Tsurumi, Husquvarna Target, , Stow, Wacker, Sakai, Mi-T- M, Sullair, Basic, Dynapac, MBW, Weber, Bartell, Bennar Newman, Haulotte, Ditch Runner, Menegotti, Morrison, Contec, Buddy, Crown, Edco, Wyco, Bomag, Laymor, Barreto, EZ Trench, Bil-Jax, F.S. Curtis, Gehl Pavers, Heli, Honda, ICS/PowerGrit, IHI, Partner, Imer, Clipper, MMD, Koshin, Rice, CH&E, General Equipment, ,AMida, Coleman, NAC, Gradall, Square Shooter, Kent, Stanley, Tamco, Toku, Hatz, Kohler, Robin, Wisconsin, Northrock, Oztec, Toker TK, Rol-Air, Small Line, Wanco, Yanmar



www.Discount-Equipment.com