



Operator's Instruction Manual Concrete/Asphalt Saws



ELECTRIC, GASOLINE AND PNEUMATIC MODELS



EQUIPMENT DEVELOPMENT CO., INC.

TO PURCHASE THIS PRODUCT PLEASE CONTACT US



**Equipment Financing and
Extended Warranties Available**



**Discount-Equipment.com is your online resource for
commercial and industrial quality parts and equipment sales.**

561-964-4949

visit us on line @ www.discount-equipment.com

Select an option below to find your Equipment

Search by Manufacturer

Search by Product Type

Request a Quote

We sell worldwide for the brands: Genie, Terex, JLG, MultiQuip, Mikasa, Essick, Whiteman, Mayco, Toro Stone, Diamond Products, Generac Magnum, Airman, Haulotte, Barreto, Power Blanket, Nifty Lift, Atlas Copco, Chicago Pneumatic, Allmand, Miller Curber, Skyjack, Lull, Skytrak, Tsurumi, Husquvarna Target, Stow, Wacker, Sakai, Mi-T-M, Sullair, Basic, Dynapac, MBW, Weber, Bartell, Bennar Newman, Haulotte, Ditch Runner, Menegotti, Morrison, Contec, Buddy, Crown, Edco, Wyco, Bomag, Laymor, EZ Trench, Bil-Jax, F.S. Curtis, Gehl Pavers, Heli, Honda, ICS/PowerGrit, IHI, Partner, Imer, Clipper, MMD, Koshin, Rice, CH&E, General Equipment, Amida, Coleman, NAC, Gradall, Square Shooter, Kent, Stanley, Tamco, Toku, Hatz, Kohler, Robin, Wisconsin, Northrock, Oztec, Toker TK, Rol-Air, APT, Wylie, Ingersoll Rand / Doosan, Innovatech, Con X, Ammann, Mecalac, Makinex, Smith Surface Prep, Small Line, Wanco, Yanmar



Table of Contents

<u>Section</u>	<u>Page Number</u>
Specifications	2
Safety Information	3-9
Notes	10
Safety Guidelines	11
Operating Controls	12
Operating Instructions	13-14
Changing Blades	15
Maintenance Instructions/Schedule.....	16-18
Limited Equipment Warranty	Inside Back Page

SPECIFICATIONS

Note: All dimensions and weights are for reference only and subject to change at any time.



Figure 1

Model #	DS-20	DS-18	KL-18	SK-14	SB-14	ASB-14
"A"	39"	39 3/8"	38 1/2"	38"	37"	37"
"B"	19 3/4"	19 3/4"	19 3/4"	16 1/2"	17 3/4"	17 3/4"
"C"	50"	48 3/4"	43"	48"	48 3/4"	48 3/4"
"D"	18"	20 1/2"	15"	14 3/4"	14 1/2"	14 1/2"
"E"	24 1/2"	24 1/2"	20"	21"	21"	21 1/2"
"F"	27"	27"	25 3/4"	23 1/2"	23 1/2"	23 1/2"
Weight	265 lbs	254 lbs	212 lbs	173 lbs	180 lbs	160 lbs



SAFETY INFORMATION



SAFETY MESSAGES

- Safety Instructions are preceded by a graphic alert symbol of DANGER, WARNING, or CAUTION.



Indicates an imminent hazard which, if not avoided, will result in death or serious injury.



Indicates an imminent hazard which, if not avoided, can result in death or serious injury.



Indicates hazards which, if not avoided, could result in serious injury and or damage to the equipment.

GASOLINE / PROPANE POWERED EQUIPMENT



- Engine exhaust from this product contains chemicals known to the State of California to cause cancer, birth defects or other reproductive harm.



- Tilting a gasoline powered machine fitted with an EPA approved vented charcoal filter gas cap, beyond 20° can cause fuel leakage. If a leak occurs, do not start or run the engine until the leak is fixed. Eliminate all other ignition sources in the immediate area (no smoking, flares, sparks or flames). Use approved gasoline absorbing material to contain the fuel leakage. Then use clean, non-sparking tools to collect absorbed materials then dispose of these contaminants properly.



- Gasoline is extremely flammable and poisonous. It should only be dispensed in well ventilated areas, and with a cool engine.

- Small gasoline engines produce high concentrations of carbon monoxide (CO) example: a 5 HP 4 cycle engine operation in an enclosed 100,000 cu. ft. area with only one change of air per hour is capable of providing deadly concentrations of CO in less than fifteen minutes. Five changes of air in the same area will produce noxious fumes in less than 30 minutes. Gasoline powered equipment should not be used in enclosed or partially enclosed areas. Symptoms of CO poisoning include, head-ache, nausea, weakness, dizziness, visual problems and loss of consciousness. If symptoms occur - get into fresh air and seek medical attention immediately.
- Never refuel a hot engine or an engine while it is running.
- Engines are shipped from factory without fuel/oil.

PROPANE POWERED EQUIPMENT CONTINUED



- Propane is extremely flammable and is heavier than air and tends to settle in low areas where a spark or flame could ignite gas. DO NOT start or operate this propane engine in a poorly ventilated area where leaking propane gas could accumulate and endanger safety of persons in area. If headache develops, shut off machine. Have it checked for carbon monoxide emissions by a qualified technician before using it again. To ensure personal safety, installation and repair of propane fuel supply systems must be performed only by qualified technicians. Carbon monoxide emissions from this machine are greatly increased due to a dirty combustion air cleaner.

ELECTRICAL POWERED EQUIPMENT



Extreme care must be taken when operating electric models with water present: Ensure power cord is properly grounded, is attached to a Ground-Fault-Interrupter (GFI) outlet, and is undamaged.

- Check all electrical cables - be sure connections are tight and cable is continuous and in good condition. Be sure cable is correctly rated for both the operating current and voltage of this equipment.
- Improper connection of the equipment grounding conductor can result in a risk of electric shock. Check with qualified electrician or service person if there is any doubt as to whether the outlet is properly grounded. Adhere to all local codes and ordinances.
- **NOTE:** In the event of a malfunction or breakdown, grounding provides a path of least resistance for the electric current to dissipate. The motor is equipped with a grounded plug and must be connected to an outlet that is properly installed and properly grounded. DO NOT modify the plug provided on the motor. If the plug does not fit the outlet have a qualified electrician install the proper receptacle.
- Do not disconnect power by pulling cord. To disconnect, grasp the plug, not the cord.
- Unplug power cord at the machine when not in use and before servicing.
- Switch motor OFF before disconnecting power.
- Never use frayed, damaged, taped or under rated extension cords. Electrical shock could result in death or serious injury to the operator and damage to the equipment.
- Assure you are using the proper extension cord length.



SAFETY INFORMATION



AIR POWERED EQUIPMENT



- When operating this equipment, the operator must wear approved job related safety attire. Eye and hearing protection must be worn at all times while equipment is in use as sound levels exceed 85 dBA. Steel toe safety shoes should be worn. Head protection is required if work is performed overhead. Wear proper dust mask based on material being removed.
- Use the correct size air hose for the tool, 1/2" diameter (minimum). Hose and fittings must be rated for safe handling in excess of 100 PSI pressure. The working pressure of this tool is 80-90 PSI and should never be allowed to exceed 100 PSI. If damaged hose is present, replace the hose before further use.
- Limit the hose length to 30 feet (10 meters) maximum. Note: The pressure drop of 1/2" diameter hose is approximately 1 PSI per 90 linear feet.
- Limit the hose length to 30 feet (10 meters) maximum. Note: The pressure drop of 3/8" diameter hose is approximately 3 PSI per 90 linear feet.
- A filter/water separator must be provided on the air source to afford an adequate supply of clean, dry air to this machine. Keep hoses clear at all times.

WARNING

• Disconnect the air supply before performing any maintenance on this machine. Use only genuine EDCO parts with this equipment. Failure to do so may result in serious bodily injury or death.

- Replace any damaged parts immediately. Use only genuine EDCO parts.
- Do **NOT** force the tool into the work. The hammering action of the tool will perform the work for you. If the tool does not seem to perform the work to your specifications, check the air supply to verify proper air pressure and lubricator is functioning properly. If above suggestions do not remedy the problem contact Discount-equipment
- After turning the air valve hand lever off, the tool will continue to operate for a few seconds. This is a normal result of stored up pressure in the machine casing being released gradually. **Be sure to firmly grip the machine until ALL air leaves the chamber.**

AIR POWERED EQUIPMENT CONTINUED

- Remove the air source from the machine when not in use.

WARNING

• This equipment will create dust from the material being removed. That dust may contain a chemical known to the state of California to cause cancer and/or birth defects or other reproductive harm. Check the chemical properties of the materials to be removed.

CAUTION

• It is the operator's responsibility to keep other people (workers, pedestrians, bystanders, etc.) away during operation. Block off the work area in all directions with roping, safety netting, etc. for a safe distance. Failure to do so may result in others being injured by flying debris or exposing them to harmful dust and noise.

DUST WARNING

WARNING

Some dust created by power sanding, sawing, grinding, drilling, and other construction activities contains chemicals known to cause cancer, birth defects, or other reproductive harm. Materials being removed can be toxic or hazardous. A breathing respirator is required to help protect the operator. Some examples of these chemicals are:

- Lead from lead-based paints.
- Crystalline silica from bricks, concrete and other masonry products. Your risk of exposure to these chemicals varies depending on how often you do this type of work. To reduce your risk: work in a well ventilated area, use a dust control system, such as an industrial-style vacuum, and wear approved personal safety equipment, such as a dust/particle respirator designed to filter out microscopic particles.
- See more on the importance of dust prevention and silica warnings at: osha.gov/silica



SAFETY INFORMATION

GENERAL INSTRUCTIONS

- Equipment should only be operated by trained personnel in good physical condition and mental health (not fatigued). The operator and maintenance personnel must be physically able to handle the bulk weight and power of this equipment.
- This is a one person tool. Maintain a safe operating distance to other personnel. It is the **operators' responsibility** to keep other people (workers, pedestrians, bystanders, etc.) away during operation. Block off the work area in all directions with roping, safety netting, etc. Failure to do so may result in others being injured by flying debris or exposing them to harmful dust and noise.
- This equipment is intended for commercial use only.
- For the operator's safety and the safety of others, always keep all guards in place during operation.
- Never let equipment run unattended.



- Personal Protection Equipment and proper safety attire must be worn when operating this machinery. The operator must wear approved safety equipment appropriate for the job such as hard hat and safety shoes when conditions require. Hearing protection **MUST** be used when operational noise levels of this equipment may exceed 85db. Eye protection **MUST** be worn at all times.



Keep body parts, loose clothing and accessories away from moving parts. Failure to do so could result in dismemberment or death.

- Do not modify the machine.
- Stop motor/engine when adjusting or servicing this equipment. Maintain a safe operating distance from flammable materials. Sparks from the cutting-action of this machine can ignite flammable materials or vapors.



OPERATOR RESPONSIBILITIES

- Read and follow all safety decals and labels.
- Maintain a safe operating distance to other personnel.
- Be familiar with all aspects of the machine's operation and controls before applying power to the equipment.
- Use the correct accessory for the job being performed and material being removed. Make sure accessories are mounted correctly.
- Never operate this machine while under the influence of drugs or alcohol, while taking medications that impair the senses or reactions, or when excessively tired or under stress.
- Follow the instructions in the operator's manual and exercise caution.
- Comply with all local safety and health regulations as well as EPA and OSHA regulations.
- Read/Maintain a copy of the equipment's operator's manual and the engine/motor manufactures operators manual with the machine for reference at all times.
- Be sure all decals on the machine can be clearly read and understood. Replace worn/missing decals immediately.



WARNING: California Proposition 65

Proposition 65 applies to any company operating in California, selling products in California, or manufacturing products that may be sold in or brought into California. The purpose of Proposition 65 is to inform the public about exposure to these chemicals. EDCO has not shifted manufacturing processes, this is strictly an updated warning procedure required by the state of California. While the exposure from EDCO products may be negligible or well within the “no significant risk” range, out of an abundance of caution, EDCO has elected to provide these Proposition 65 warnings.

Depending on machine/part model the following warnings may apply:



WARNING: Cancer and Reproductive Harm -
For more information go to: www.P65Warnings.ca.gov



WARNING: Batteries, battery posts, terminals and related accessories can expose you to chemicals including lead and lead compounds, and other chemicals known to the State of California to cause cancer and birth defects or other reproductive harm. WASH HANDS AFTER HANDLING. For more information go to www.P65Warnings.ca.gov



WARNING: This product can expose you to chemicals including soots, tars, and mineral oils, which are known to the State of California to cause cancer, and carbon monoxide, which is known to the State of California to cause birth defects or other reproductive harm. For more information go to www.P65Warnings.ca.gov



WARNING: This machine used in its application on concrete/cement/brick surfaces can expose you to chemicals including crystalline silica which is known to the State of California to cause cancer. For more information go to www.P65Warnings.ca.gov



DUST AND CRYSTALLINE SILICA WARNING



WARNING

Grinding/cutting/drilling of masonry, concrete, metal and other materials can generate dust, mists and fumes containing chemicals known to cause serious or fatal injury or illness, such as respiratory disease, cancer, birth defects or other reproductive harm. If you are unfamiliar with the risks associated with the particular process and/or material being cut or the composition of the tool being used, review the material safety data sheets and/or consult your employer, the manufacturers/suppliers, governmental agencies such as OSHA and NIOSH and other sources on hazardous materials. California and some other authorities, for instance, have published lists of substances known to cause cancer, reproductive toxicity, or other harmful effects.

Control dust, mist and fumes at the source where possible. In this regard use good work practices and follow the recommendations of the manufacturers/suppliers, OSHA/NIOSH, and occupational and trade associations. Water should be used for dust suppression when wet grinding/cutting/drilling is feasible. When the hazards from inhalation of dust, mists and fumes cannot be eliminated, the operator and any bystanders should always wear a respirator approved by NIOSH/MSHA for the material being used.

WARNING

Grinding/cutting/drilling of masonry, concrete and other materials with silica in their composition may give off dust or mists containing crystalline silica. Silica is a basic component of sand, quartz, brick clay, granite and numerous other minerals and rocks. Repeated and/or substantial inhalation of airborne crystalline silica can cause serious or fatal respiratory diseases, including silicosis. In addition, California and some other authorities have listed re-spirable crystalline silica as a substance known to cause cancer. When grinding/cutting/drilling such materials, always follow the respiratory precautions mentioned above.



SAFETY SYMBOLS



This symbol means that the guards must remain in place while the engine/motor on the machine is running because death or personal injury may result.
(Yellow background with black pictogram and black outline)



This symbol means that there are moving parts and if feet/fingers/digits are inserted under any edge of the cutter/grinder/saw cover while the engine/motor on the machine is running that personal injury and loss of foot/fingers/digits may result.
(Yellow background with black pictogram and black outline)



This symbol means the surface is HOT and that if fingers/digits/hands or any bare or unprotected skin comes in contact with this surface or hot accessory, possible serious burns and personal injury may result.
(Yellow background with black pictogram and black outline)



This symbol means that potential hazardous voltages are present and the equipment must be properly grounded and extreme caution should be taken. If for any reason maintenance or repair is needed, insure that voltage(s) are disconnected at the machine and the source unless (be cautious) voltage needs to be present to troubleshoot the problem, then only qualified personal should work on "live" systems.
(Yellow background with black pictogram and black outline)



This symbol means that the machine is heavy if the machine needs to be lifted onto or off of a truck, loading dock etc. that proper technique or heavy duty lifting device should be used, personal injury could result.
(Yellow background with black pictogram and black outline)



This symbol means that dangerous chemicals, gases, dust particles and/or fumes are present including carbon monoxide. Proper ventilation must be maintained. Do not use gasoline or diesel powered equipment indoors.
(Yellow background with black pictogram and black outline)



This symbol means that there are sharp components and if feet/fingers/digits come in contact personal injury or death could result.
(Yellow background with black pictogram and black outline)



This symbol means hazardous pressures are present. Caution should be exercised to prevent personal injury or damage to equipment. Face, eye and head protection should be used.
(Yellow background with black pictogram and black outline)



This symbol means explosive and hazardous vapors are present. Caution should be exercised to prevent personal injury to face and eyes. Breathing and personal protection should be used when servicing.
(Yellow background with black pictogram and black outline)



SAFETY SYMBOLS



This symbol means that the Operator's, owners, instruction and/or manufacturer(s) manuals must be read and understood before operating or attempting to operate this electrical, gasoline, diesel or propane powered equipment, failure to do so can result in personal injury and possible death. (Blue background with white pictogram.)



This symbol means that proper eye protection must be worn/used during the operation of this equipment. There is a potential risk of operator eye damage, injury or loss of sight. This also applies to any personnel standing nearby observing the operation of this equipment. (Blue background with white pictogram.)



This symbol means that proper ear protection should be worn/used during the operation of this equipment. There is a potential risk of operator hearing damage, injury or loss of hearing which will increase based on the length of exposure. This also applies to any personnel standing nearby observing the operation of this equipment. (Blue background with white pictogram.)



This symbol means that proper head protection should be worn/used during the operation of this equipment there is a potential risk of operator head injury from foreign or loose objects the equipment might come in contact with during operation. This also applies to any personnel standing nearby or observing the operation of this equipment. (Blue background with white pictogram.)



This symbol means that proper breathing protection or engineering controls must be worn/used during the operation of this equipment there is a potential risk of operator lung damage. Repeated and/or substantial inhalation of airborne crystalline silica can cause serious or fatal respiratory diseases, including silicosis. In addition, to California and some other authorities have listed respirable crystalline silica as a substance known to cause cancer. When grinding/cutting/drilling such materials, always follow local respiratory precautions. This also applies to any personnel standing nearby or observing the operation of this equipment. (Blue background with white pictogram.)



This symbol denotes the lifting point and means that if lifting of this equipment is necessary use a lifting device that is designed to accommodate or exceed the weight of this machine. Check the Operator's manual for specifications. Using a device that is not designed to accommodate or exceed the weight of this machine could result in damage to the machine and personal injury. Do not lift equipment over people because death or serious injury could result. (Blue background with white pictogram.)



This symbol means do not insert fingers/digits under any edge of the belt cover while the engine/motor on the machine is running because personal injury and loss of fingers/digits may result. (Black pictogram with red "No" symbol outline)



This GHS pictogram identifies that the chemicals contained present serious health hazards. (Black pictogram with red diamond symbol outline)



Read and understand this *Operator's Instruction Manual*,
and the *Engine Manufacturer's Owner's Manual*
before operating this equipment.
Death of serious injury can result if this machine is used improperly.



Safety Guidelines



Maintain a safe operating distance from flammable materials. Sparks from the cutting-action of this saw can ignite flammable materials or vapors.



Operator must wear appropriate clothing and footwear. Do not wear loose clothing or jewelry that can get tangled or caught in moving parts.



Eye and ear protection must be worn at all times when this machine is in use. During normal use, sound levels exceed 85dBA. Use only ANSI approved safety glasses to help prevent eye injury. Everyday eyeglasses have only impact resistant lenses; they are NOT safety glasses.

- Keep a safe operating distance from other personnel and never leave the machine running unattended.
- Maintain the machine in safe operating condition with all guards in place and secure, all mechanical fasteners tight, all controls in working order and the saw configured for the job application.
- The SK-14, SB-14, DS-20, KL-18, and the DS-18 are designed to cut flat, horizontal concrete or asphalt slabs using diamond saw blades.
- The SK-14, SB-14, DS-20, KL-18, and the DS-18 are to be operated by a single operator from a position at the rear of the saw.
- Avoid deck inserts, pipes, columns, openings, electrical outlets, or any objects protruding from slab surface.
- Inspect the blades carefully before installing. Do not use any questionable blade since serious personal injury and/or damage to property can result.
- Never operate this saw while under the influence of drugs, alcohol or when taking medications that impair the senses or reactions, or when excessively tired or under stress.
- Be sure all safety decals on the machine can be clearly read and understood. Replace damaged or missing decals immediately.

Safety warnings and guidelines do not by themselves eliminate danger.
They are not given as substitutes for proper accident prevention and good judgement.



Operating Controls

Diagrams shown with Honda Cyclone Dual-Filter Element Engine as an example. Consult the *Engine Manufacturer's Owner's Manual* for information on specific models.



Please Note:

Controls shown are for the model indicated.

The location of these controls may vary on the different models.

Due to improvements and changes in the equipment, the illustration shown may be different from the actual machine.

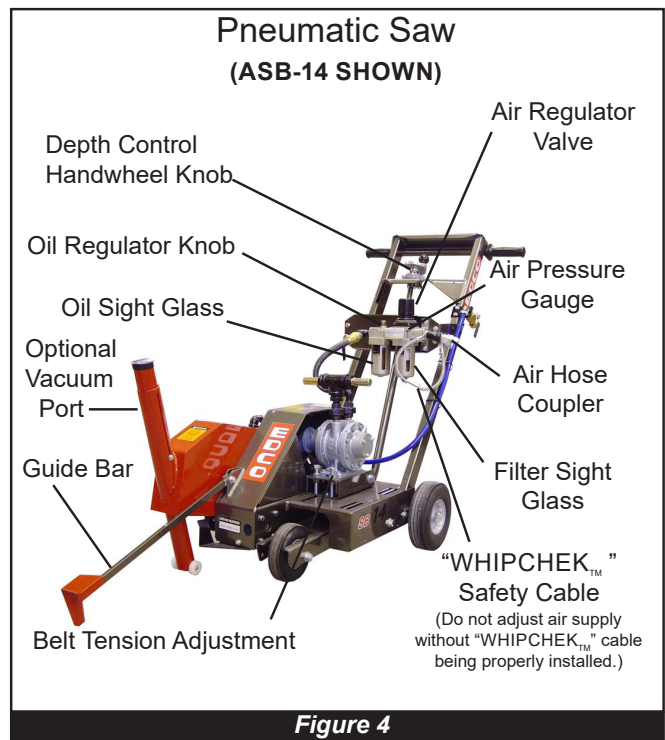
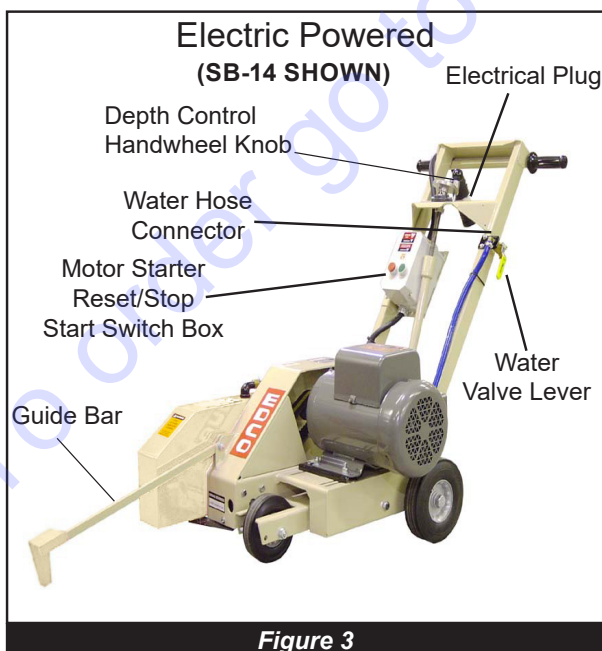



Operating Instructions

- **FOR WET CUTTING:** Attach the water supply. A flow rate of approximately 2 gallons per minute (minimum) is required. Attach the water hose to the coolant valve. Use the valve to control the flow of water.
- **FOR DRY CUTTING:** Provide a respirator and dust control system.
- **FOR ELECTRIC MODELS:** Be sure the “OFF” button is depressed. Hook up the electrical power source by plugging into the connector provided. If the cord does not mate with the connector, consult a qualified licensed electrician before continuing. Be sure that the equipment is properly grounded.
- **FOR GASOLINE MODELS:** Put the engine stop switch in the “RUN” position. Consult the engine manufacturers operating instructions and follow the directions for starting and breaking in the engine.
- **FOR PNEUMATIC MODELS:** Before connecting the air source, be sure the “WHIPCHEKTM” cable is properly installed and the flow control lever is in the “OFF” position. Adjust the air pressure to 90 psi (100 psi MAX.) using the air regulator valve (see Figure 4 on page 6). Open the flow control lever gradually to start and adjust the oil regulator knob as required for your application.

Before Starting Engine:

- **BEFORE STARTING THE ENGINE OR MOTOR:** Raise the saw blade clear of the working surface. The blade is raised using the depth control handwheel knob mounted on the upper handle assembly (Figure 5). Lift the knob to unlock and turn the handwheel clockwise until the blade is clearly off the ground.
- **START ENGINE AND ALLOW IT TO REACH OPERATING SPEED:** Position the saw over the cutting line. Bring the engine to full speed. Lower the blade into the slab surface by slowly turning the depth control handwheel knob. **NOTE** - the 14 inch blade has a maximum cutting depth of 4 3/4". Do not allow the arbor flanges to contact slab surface.

When the selected cutting depth is reached, lock the depth control handwheel knob and proceed to push the saw forward. The saw blade must remain straight, do not twist, and do not force blade, the engine or motor should not strain when cutting.

Cutting to maximize depth should be achieved in stepped increments of 1".



Figure 5

Refer to the *Rx for Diamond Blades* for more detailed information on diamond blades.



Operating Instructions

- **TO STOP THE MACHINE:** Stop forward motion. On gasoline models push the throttle to idle. Turn the depth control handwheel knob counter clockwise to raise the blade clear of the cut. Turn ignition or power switch off and let the engine come to a complete stop. Turn off the water supply.
- **WHEN MANEUVERING THE SAW:** Make sure the blade is raised high enough so it does not strike the slab surface. Damage to blade may occur with inadvertent contact with the slab or other object.
- **DO NOT FORCE BLADE WHILE CUTTING.**
- **IF THE POWER SOURCE STALLS IN THE CUT:** Raise the blade completely out of the cut. Disconnect the power source (i.e. the spark plug wire on a gasoline engine or disconnect an electric model at the machine). Inspect the blade flange nut/bolt to verify that they are still tight, and inspect the blade for damage. Replace damaged (or questionable) blades immediately.
- **WHEN TRANSPORTING THE SAW:** Be sure to remove the blade. Before removing the blade, disconnect the power source before lifting or removing any guard. See the directions for Installing Blades on *(page 15)*.
- **WHEN HOISTING A CONCRETE SAW EQUIPPED WITH A LIFTING BAIL:** Always inspect frame and

Optional Accessories



Model SK-14, with WaterTank Option, shown

Optional Water Tank Kit for
 SK-14 (P/N 52075),
 SB-14 (P/N 51090),
 DS-18 (P/N 56310).
 DS-20 (P/N 56310).
 KL-18 (P/N 56310)

**KL-18 Requires optional
 lifting bail for Water
 Tank Kit assembly**

Figure 6



Changing Blades - On EDCO saws in this manual

WARNING

Disconnect the machine from the power source before performing any work on the equipment (i.e. changing the blade). To disconnect the power source on gasoline engine models, remove the spark plug lead. On electric models, unplug the electrical power cord at the machine.

- Make sure you have the proper blade for the job. Determine the hardness and composition of the slab. Give your dealer complete information including whether re-bars are present, the desired depth of the cut, and length of the cut. If in doubt, contact the blade manufacturer.

DANGER

Inspect the blades before installing. Check diamond blades for cracks, loose segments and oversize, worn, or out-of-round arbor holes (**On page 17**). Do not use **any** questionable blade since serious personal injury and/or damage to property can result. Do not use warped, twisted, or out-of-balance blades. Unbalanced blades will wear excessively, vibrate and damage both arbor shaft and bearings. Do not use blade without a drive pinhole (**Figure 10**).

WARNING

For safety reasons, EDCO **does not** recommend the use of any abrasive blades. Abrasive blades can break and cause serious personal injury to operator and/or bystanders. If abrasive blades are used by choice, use only reinforced abrasive blades. Inspect blades carefully.

DANGER

Never exceed the maximum operating speed of the blade. Be sure to match the blade speed rating with the arbor shaft speed on the machine. The standard models of the SK-14, SB-14, DS-18 have an arbor shaft speed (unloaded) of 3600 RPM and 3000 RPM under load.

- Do not remove or lift the blade guard unless machine is stopped and all power is disconnected. Be sure to reinstall blade guard before reconnecting the power source.
- Be sure the arbor shaft, backing plate, and blade cap are clean and in good condition. Make sure the threads are clean and undamaged. If any damage is detected, consult Discount-equipment.
- The backing plate and blade cap (**Figure 11**) should be the same diameter, do not use if they are different diameters. For abrasive blades and for all steel centered diamond blades, the backing plate and blade cap must be at least 1/4 the diameter of the blade.
- The drive pin should be tight in the blade cap and long enough to fit through blade and into hole in backing plate.
- Place the blade on the arbor shaft and turn until the drive pinhole lines up with the backing plate.
- Place the blade cap on the arbor shaft so the drive pin goes through the holes in the blade and backing plate.
- Put washer and arbor shaft nut and tighten arbor shaft nut.
- Secure the blade guard in the operating position before reconnecting the power supply or starting engine.



Figure 10

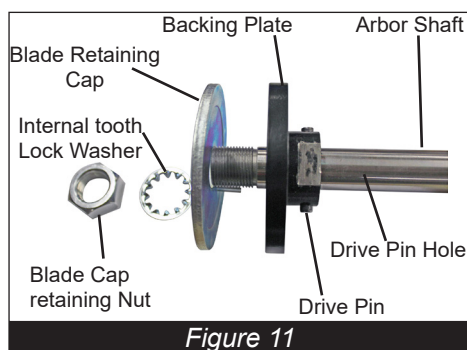

Figure 11



Disconnect the machine from the power source. Remove the spark plug lead on gasoline engine models or disconnect the supply voltage connector on electric models, before performing any maintenance. All maintenance to be performed regularly by qualified personnel



Maintenance Instructions

- Never work under saw without first placing chocks on the wheels and support device under the saw to prevent it from moving or falling. Always work on a flat and level surface.
- Refer to the engine manual for maintenance information specific to the engine used. Be sure to check oil level before operation. Clean air filter element daily.
- Grease bearings daily during use. Refer to *(page 17)* for lubrication points on available models.
- Perform a visual inspection of the entire machine before operation. Be sure all fasteners are tight and secure, check for signs of metal cracking or fatigue, inspect for damage to electrical wiring, damage to fuel lines, check bearings and inspect to be sure proper guards are in place and secure, etc...
- Inspect belts before operation. Check belt tension. On new equipment, belts should be re-tensioned after the first four hours of use. Damaged, stretched or excessively worn belts should be replaced with a new matched set.
- To tension belts, loosen motor mounting hardware slightly. Either push motor towards the rear of the saw (handle bar side) until the belts are tight or on the models with a belt tensioning adjustment bolt, use bolt to adjust the motor until the belts are tight. Re-torque the engine mounting hardware.
- Proper belt tension must be maintained to transmit the engine power to the cutting blade. Slipping belts will overheat, the blade life will be shortened and the cutting speed limited. Over tensioned belts will shorten the belt and bearing life.
- Check diamond blades for cracks, loose segments and oversize, worn, or out-of-round arbor holes *(See Page 16)*. Do not use any questionable blade since serious injury and/or damage to property can result. Do not use warped, twisted, or out-of-balance blades. Unbalanced blades will wear excessively, vibrate and damage both arbor shaft and bearings. Do not use a blade without a drive pinhole.
- For safety reasons, EDCO does not recommend the use of any abrasive blades. Abrasive blades can break and cause serious personal injury to operator and/or bystanders. If abrasive blades are used by choice, use only reinforced abrasive blades. Inspect abrasive blades carefully.
- Be sure arbor shaft, backing plate and blade cap are clean and in good condition. Flanges should be free of nicks and burrs. Replace if out-of-round or worn.

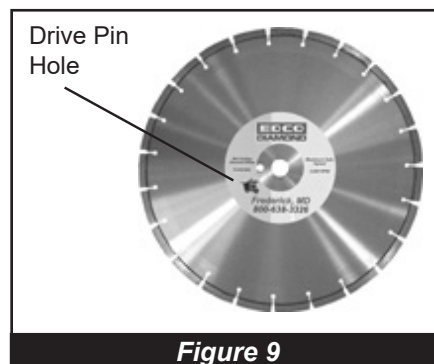

Figure 9



Lubrication Points

Grease Bearings Every 4 Hours of Use
NOTE: Wipe grease fittings clean before servicing.



GREASE FITTINGS

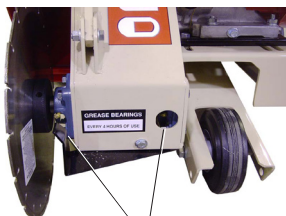

GREASE FITTINGS

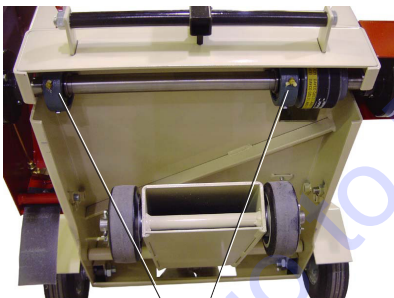

GREASE FITTINGS

MODEL SK-14



MODEL SB-14
ASB-14



MODEL DS-18, DS-20 &
KL-18



Possible Diamond Blade Problems

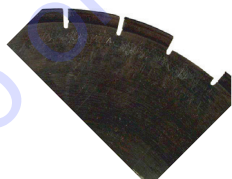

Segment Loss:
Usually insufficient water

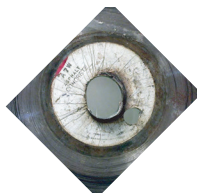

Arbor Hole Out-of-Round:
Blade not properly tightened or seated on arbor



Cracked Segments and/or Core:
Wrong blade for the job

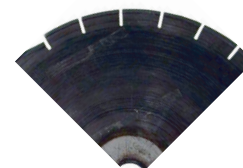

Blade Will Not Cut:
Blade is glazed or too hard for the job

Possible Diamond Blade Problems



Repairs are to be done
by authorized EDCO
Dealers only.



Read and follow instructions
in the Engine Manufacturer's
Owner's Manual.

Maintenance Schedule

This is for a quick reference to the information supplied in the Maintenance portion of this manual.

Follow the Engine Manufacturer's Maintenance Instructions	Before Operation	Daily	After Operation	As Required	Annually
Visually Inspect Entire Machine and Hardware	X				
Check Engine Oil	X				
Inspect Blade and Arbor Shaft	X				
Inspect Guards		X			
Clean Air Filter Element		X			
Grease Bearings		X			
Clean Dust and Dirt Off Machine			X		
Change Engine Oil				X	
Inspect Belts				X	
Replace Spark Plug					X

TO PURCHASE THIS PRODUCT PLEASE CONTACT US



**Equipment Financing and
Extended Warranties Available**



**Discount-Equipment.com is your online resource for
commercial and industrial quality parts and equipment sales.**

561-964-4949

visit us on line @ www.discount-equipment.com

Select an option below to find your Equipment

Search by Manufacturer

Search by Product Type

Request a Quote

We sell worldwide for the brands: Genie, Terex, JLG, MultiQuip, Mikasa, Essick, Whiteman, Mayco, Toro Stone, Diamond Products, Generac Magnum, Airman, Haulotte, Barreto, Power Blanket, Nifty Lift, Atlas Copco, Chicago Pneumatic, Allmand, Miller Curber, Skyjack, Lull, Skytrak, Tsurumi, Husquvarna Target, Stow, Wacker, Sakai, Mi-T-M, Sullair, Basic, Dynapac, MBW, Weber, Bartell, Bennar Newman, Haulotte, Ditch Runner, Menegotti, Morrison, Contec, Buddy, Crown, Edco, Wyco, Bomag, Laymor, EZ Trench, Bil-Jax, F.S. Curtis, Gehl Pavers, Heli, Honda, ICS/PowerGrit, IHI, Partner, Imer, Clipper, MMD, Koshin, Rice, CH&E, General Equipment, Amida, Coleman, NAC, Gradall, Square Shooter, Kent, Stanley, Tamco, Toku, Hatz, Kohler, Robin, Wisconsin, Northrock, Oztec, Toker TK, Rol-Air, APT, Wylie, Ingersoll Rand / Doosan, Innovatech, Con X, Ammann, Mecalac, Makinex, Smith Surface Prep, Small Line, Wanco, Yanmar