



CONCRETE SAW OPERATOR'S MANUAL

MODELS CC6571D and CC6571D-3

December 18, 2015

Part # 1804004

TO PURCHASE THIS PRODUCT PLEASE CONTACT US



**Equipment Financing and
Extended Warranties Available**



**Discount-Equipment.com is your online resource for
commercial and industrial quality parts and equipment sales.**

561-964-4949

visit us on line @ www.discount-equipment.com

Select an option below to find your Equipment

Search by Manufacturer

Search by Product Type

Request a Quote

We sell worldwide for the brands: Genie, Terex, JLG, MultiQuip, Mikasa, Essick, Whiteman, Mayco, Toro Stone, Diamond Products, Generac Magnum, Airman, Haulotte, Barreto, Power Blanket, Nifty Lift, Atlas Copco, Chicago Pneumatic, Allmand, Miller Curber, Skyjack, Lull, Skytrak, Tsurumi, Husquvarna Target, Stow, Wacker, Sakai, Mi-T-M, Sullair, Basic, Dynapac, MBW, Weber, Bartell, Bennar Newman, Haulotte, Ditch Runner, Menegotti, Morrison, Contec, Buddy, Crown, Edco, Wyco, Bomag, Laymor, EZ Trench, Bil-Jax, F.S. Curtis, Gehl Pavers, Heli, Honda, ICS/PowerGrit, IHI, Partner, Imer, Clipper, MMD, Koshin, Rice, CH&E, General Equipment, Amida, Coleman, NAC, Gradall, Square Shooter, Kent, Stanley, Tamco, Toku, Hatz, Kohler, Robin, Wisconsin, Northrock, Oztec, Toker TK, Rol-Air, APT, Wylie, Ingersoll Rand / Doosan, Innovatech, Con X, Ammann, Mecalac, Makinex, Smith Surface Prep, Small Line, Wanco, Yanmar

Table of Contents

Safety Precautions	4	Neutral Control	23
Safety Alerts.....	4	Transmission	23
Proposition 65	4	Engaging the Transmission.....	23
Spark Arrester Requirement	4	Disengaging the Transmission.....	23
Respiratory Hazards	4	Shifting Three Speed Transmission	23
General Safety	4	Fuel System.....	24
Battery and Electrical Safety.....	6	Adding Fuel	24
Blade Safety.....	6	Cold Weather Fuel	24
Blade Guard Safety.....	6	Storage.....	24
Fuel Safety.....	7	Display Panel	25
Engine Safety.....	7	Soft Keys (Buttons).....	26
Cutting Safety	8	Status Icons	27
Hydraulic Safety.....	8	Main Menu	28
Belt Safety.....	8	Arrow	28
Transmission Safety	8	DPF Commands.....	28
Transporting Safety.....	8	Main Menu Action Items.....	29
Lifting Safety	9	Gauges.....	30
Introducing the CC6571	10	Diagnostics.....	30
Components.....	10	System Information	31
Introducing the CC6571-3	11	Lamp Information	32
Components.....	11	User Settings.....	33
Controls	12	Automatic Shutdown.....	34
Dimensions.....	13	Regeneration	35
Specifications	14	Passive Regeneration	35
Operating the CC6571 and CC6571-3.....	15	Active Regeneration.....	35
Handlebars.....	15	Parked Regeneration	35
Adjusting the Handlebars	15	Cancel Parked Regeneration.....	36
Front Pointer	15	Request Parked Regeneration.....	37
Adjusting the Front Pointer	15	Regeneration Message Levels	39
Rear Pointers	16	Engine.....	40
Adjusting the Rear Pointers.....	16	Ignition Switch	40
Battery.....	16	Starting the Engine	40
Diamond Blades.....	16	Stopping the Engine	41
Inspecting the Blade	16	Concrete Cutting.....	41
Blade Speed	17	Adjusting the Depth Stop.....	42
Installing the Blade	17	Lighting	42
Removing the Blade	19	Spot Light	42
Blade Guard.....	20	Parking Brake	43
Installing the Blade Guard	20	Engaging the Parking Brake.....	43
Removing the Blade Guard	20	Disengaging the Parking Brake.....	43
Flange Guard	20	Maintaining the CC6571 and CC6571-3.....	44
Installing the Flange Guard	20	Maintenance Overview	44
Removing the Flange Guard	21	Daily and/or Regularly.....	44
Water Supply	21	50 Hours	44
Using the Water Supply.....	21	500 Hours.....	44
Water Safety Switch	21	Handlebars	44
Water Pump.....	22	Part Lubrication	44
Control Grip.....	22	Front Axle	44
Raising the Saw.....	22	Rear Axle.....	45
Lowering the Saw	22	PTO.....	45
Lowering Speed.....	22	Inner Blade Flange	45
Speed Control Lever.....	22	Installing the Inner Blade Flange	45
Forward Control.....	22	Removing the Inner Blade Flange	45
Reverse Control.....	23	Rear Wheels	45
		Battery	45
		Battery Type.....	45

Servicing the Battery	46
Electrical System	46
Fuse Panel	46
Relays and Circuit Breakers	46
Magnetic Sensor	47
Adjusting the Magnetic Sensor	47
Replacing the Magnetic Sensor	47
Air Cleaner	47
Restriction Indicator	48
Rubber Dust Ejector Boot	48
Cleaning/Replacing the Outer Primary Filter	48
Replacing the Inner Safety Filter	49
Speed Control Lever	49
Adjusting the Speed Control Lever	49
Drive Alignment	50
Adjusting the Rear Drive	50
Oil Bath Blade Shaft /Oil Expansion Tank	50
Changing the Oil - Single Speed	50
Changing Oil - Three Speed	51
Draining Heat Exchanger – Freezing Temps	52
Hydraulic System	52
Adding Hydraulic Fluid	52
Rear Drive Transmission	53
Cooling Fan	53
Adding Oil	53
Adjusting the Rear Drive Chain	53
Belt System	53
Blade Drive Belts	53
Belt Tension Setting	53
Testing the Belt Tension	53
Adjusting the Blade Drive Belts	54
Replacing the Blade Drive Belts	55
Primary Transmission V-Belt	56
Replacing the Primary Transmission V-Belt	56
Secondary Transmission V-Belt	56
Replacing the Secondary Transmission V-Belt	56
Engine V-Belt	56
Rotary Tensioner	56
Adjusting the Rotary Tensioner	56
Replacing the Rotary Tensioner	57
Engine	58
Engine Cooling System	58
Radiator	58
Cooling Fan	58
In-Line Fuel Filter	59
Oil and Fuel Lines	59
Storing	59
Disposal	59
References	60
Appendix A	60
Model and Serial Numbers	60
Appendix B	61
Daily Maintenance Task Chart	61
Appendix C	62
Troubleshooting	62
Appendix D	64

Additional Resources	64
Warranty	68

Safety Precautions

Operate the CC6571 Concrete Saw and CC6571-3 Concrete Saw and all of their components according to this manual. Failure to comply with and understand the following safety, operations, and maintenance instructions can result in serious injuries and/or death. All operators must be properly trained or supervised prior to using these saws and should understand the risks and hazards involved. Improper or unintended saw usage is discouraged and Diamond Products cannot be held liable for any resulting damages.

Saw modifications should be made by Diamond Products to ensure proper safety and accuracy. Modifications made to these saws by the owner are not the responsibility of Diamond Products and void all saw warranties if a problem arises as a result of the modification.

Refer to the Diamond Products' Parts Lists for additional information and part diagrams. Prior to operating the saw, record the saw's serial number, and the engine's model and serial numbers in the Serial Tags section in the Index for future reference.

The information in this manual may be updated at any time!

Safety Alerts

DANGER

Serious injuries and/or death will occur if these instructions are not followed.

WARNING

Serious injuries and/or death could occur if these instructions are not followed.

CAUTION

Mild and/or moderate injuries could occur if these instructions are not followed.

Proposition 65

WARNING

Engine exhaust and some of its constituents are known to the State of California to cause cancer, birth defects, and/or other reproductive harm.

Spark Arrester Requirement

WARNING

In the State of California it is a violation of Section 4442 or 4443 to use or operate the engine on any forest-covered, brush-covered, or grass-covered land unless the engine is equipped with a spark arrester, as defined in Section 4442, maintained in effective, working order or the engine is constructed, equipped, and maintained for the prevention of fire pursuant to Section 4443

Respiratory Hazards

WARNING

Concrete cutting produces dusts and fumes known to cause illness, death, cancer, respiratory disease, birth defects, and/or other reproductive harm. Safety protection techniques include, but are not limited to:

- Wearing gloves.
- Wearing safety goggles or a face shield.
- Using approved respirators.
- Washing work clothes daily.
- Using water when wet cutting to minimize dust.
- Washing the hands and face prior to eating/drinking.

For additional safety and self-protection information contact your employer, the Occupational Safety and Health Administration (OSHA), and/or The National Institute for Occupational Safety and Health (NIOSH).

General Safety

- Read and understand all of the safety, operations, and maintenance instructions

provided in this manual prior to operating or servicing the saw.

- Keep saw components clean and free of slurry, concrete dust, and debris.
- Inspect water hoses prior to operating the saw. Clean, repair, or replace damaged components.

- Raise the saw to a proper height for access when working underneath the saw. Use chocks to block the wheels, and fit blocks or jacks under the frame edges at the front and back of the frame for additional support.



- When using a jack to raise the saw, place the jack against a solid, flat area under the frame base to properly support the saw while lifting.
- Repair the saw immediately when a problem arises.
- Replace saw decals if unreadable.
- Dispose of all hazardous waste materials according to city, state, and federal regulations.
- Always have a phone nearby, and locate the nearest fire extinguisher and first aid kit prior to operating the saw.
- Operate the saw wearing flame resistant clothing.
- Always wear safety glasses when removing retaining rings.
- Persons under the statutory age limit should not operate the saw.
- Keep all body parts away from rotating machinery.
- Replace all guards and access panels (unless stated otherwise) prior to operating the saw.
- Always pivot guards fully to avoid serious injuries.
- DO NOT assume the saw will remain still when in *Neutral* or when parking/stopping the saw on a slope. Chock the tires to help prevent unnecessary movement.
- All non-routine maintenance tasks should be performed by an authorized service center.

DO NOT:

- Drop equipment, supplies, tools, etc., when handling to help prevent injuries.
- Operate the saw around combustible materials or fumes to prevent fires/explosions.
- Lift and carry equipment, supplies, tools, etc., that are too heavy and/or cannot be lifted easily.
- Operate the saw without using the appropriate safety equipment required for the work task.



- Operate or service the saw with clothing, hair, or accessories that can snag in the machinery, which could lead to serious injuries or death!
- Operate the saw with anyone near the work area.
- Operate the saw until unnecessary materials have been removed from the work area.
- Operate the saw using attachments not associated with or recommended for the saw.
- Operate the saw around combustible materials or fumes to prevent fires/explosions.
- Operate the saw with anyone near the work area or within the direct line of the blade.
- Operate the saw until all unnecessary materials have been removed from the work area.
- Operate the saw with loose nuts, screws, and bolts.
- Operate the saw when ill or fatigued.
- Operate the saw under the influence of drugs and/or alcohol.
- Operate the saw on steep slopes.
- Cut concrete with guards and access panels removed.
- Grease the saw with the engine running (unless stated otherwise).
- Touch hot components when operating the saw.
- Leave the saw unattended until the engine is off and the blade has stopped spinning.
- Place the saw into storage until it has cooled down.
- Service the saw until it has cooled down.
- Service the saw with the engine running (unless stated otherwise).

Battery and Electrical Safety

- Ignitable explosive gases are emitted from the battery. DO NOT expose the battery to sparks or open flames. 
- Keep the area around the battery well-ventilated.
- Keep the battery level when handling it.
- Use protective eyewear or a face shield, and avoid contact with the skin when handling/servicing the battery.
- Use a proper battery tester when testing the battery strength.
- Always be sure to connect the battery cables to the proper terminal when reconnecting the cables.
- Regularly inspect the battery, cables, clamps, and terminals for damages. Clean, replace, tighten and grease components as necessary.
- Always keep the battery cable clamps away from the battery terminals when the battery is disconnected to avoid accidental connections while servicing.
- Immediately rinse your clothing, skin, or eyes with water if exposed to battery acid. Seek medical attention immediately!
- Disconnect the battery prior to servicing all saw components (unless stated otherwise).
- Remove the battery when storing the saw for longer periods.
- Always use the correct size fuses (amps) to prevent fires.

Blade Safety

- Always use reinforced abrasive blades or steel-centered diamond blades.
- Never use a wet cutting blade without an adequate water supply to properly lubricate the blade.
- Inspect all blades prior to usage and discard damaged blades. Clean dirty blades as necessary.
- DO NOT install or remove a blade with the engine/motor running.
- Keep all body parts away from rotating blades.

- Inspect the blade flanges for damages, wear, and cleanliness. Clean or replace dirty/damaged components immediately.
- DO NOT expose yourself or anyone else to the direct line of the blade when operating the saw. 
- Always use an appropriate size blade and the correct blade type based on the cutting task and the type of material being cut.
- The blade must always fit snug on the blade shaft and/or outer flange.
- Wear gloves and be alert to the surrounding environment when handling blades.
- When installing the blade, always point the arrow printed on the blade in the direction of the blade shaft's rotation.
- DO NOT exceed the blade's maximum recommended speed when cutting. Excessive blade speeds can cause blade breakage, resulting in serious injuries and/or death!
- DO NOT use damaged blades when cutting to avoid harming yourself, others, or the saw.
- DO NOT use a blade for cutting that requires a lower speed than the blade shaft speed.
- Tighten the blade shaft screw/nut as directed to properly secure the outer flange and blade. Failure to properly secure the outer flange and blade may cause parts to loosen or fall off the saw.
- Let the blade cool prior to removal when dry cutting (applicable models).
- Always install the correct blade shaft sheave, blade drive belts, and flanges when changing the blade size. Changing the blade shaft sheave requires assistance from technical support. Contact technical support prior to running the saw.
- Refer to the RPM Chart posted on the saw or in the Parts List for additional information.

Blade Guard Safety

- DO NOT operate the saw with the blade guard raised or removed.
- Blade exposure should not exceed 180° while cutting.
- When pivoting the front of the blade guard, raise/lower it cautiously and slowly to avoid serious injuries.



- Always pivot the front of the blade guard 180° (fully upward) so the guard does not swing down unexpectedly, causing serious injuries. 
- DO NOT install or remove the blade guard with the engine running.
- Always use a blade guard that corresponds with the blade size.
- Inspect the blade guard and water tubes prior to starting the saw. Clean or replace dirty/damaged components immediately.
- When lowering the front part of the blade guard, pivot it cautiously and slowly to avoid serious injuries.

Fuel Safety

- Always use caution when refueling.
- Store all fuel in appropriate safety containers.
- DO NOT operate the saw with a fuel leak.
- DO NOT fuel the saw with the engine running.
- Let the engine cool prior to adding fuel.
- Refer to the engine manual for recommended fuels.
- Always use appropriate fuels in cold weather.
- Move the saw away from the refueling area prior to starting the engine.
- DO NOT smoke or expose fuel to open flames when filling the fuel tank or working with fuel. 
- Clean up any spilled fuel prior to starting the engine.
- Drain the fuel tank and fuel lines when storing the saw for longer periods of time. Refer to the engine manual for additional recommendations.
- Fuel may seep out from the fuel cap vent (applicable models) when raising the saw if the fuel tank has been overfilled.

Engine Safety

- Refer to the engine manual as the primary source for engine safety.
- Refer to the engine manual for recommended oil.
- Always know how to turn off the engine quickly for emergency purposes.

- Make sure the speed control lever (applicable models) is at *Neutral* when starting the engine.
- Fill the fuel tank and check the oil level prior to starting the engine.
- Keep all body parts away from rotating parts with the engine running. 
- DO NOT start the engine without the air filter(s) installed.
- DO NOT allow dust to enter the air intake tube when cleaning/replacing air filter(s).
- Immediately replace damaged saw components that may allow dust to enter the engine.
- DO NOT leave the engine/motor running unattended.
- Always operate the saw in well-ventilated areas. Concentrated engine exhaust can cause loss of consciousness and/or death. 
- DO NOT operate the saw around combustible materials or fumes to prevent fires/explosions.
- DO NOT leave the saw unattended until the engine is off and the blade has stopped spinning.
- DO NOT touch the engine/muffler assembly with the engine running, and always let them cool down prior to touching or servicing the saw.
- Handle hot oil carefully when changing the oil.
- Wipe down the engine/motor exterior and guards daily or regularly to prevent high operating temperatures.
- DO NOT spray the engine/motor with water to prevent engine/motor damage.
- Let the engine cool prior to removing pressurized caps (applicable models). 
- Clean the engine cooling system regularly to prevent high operating temperatures.
- DO NOT use any starter substances or starter fluids (e.g., starter fluid sprayed into the air filter) when starting the engine using a glow plug (applicable models). These materials are extremely flammable and explosive, and can melt parts or possibly explode when used to help start the engine.

Cutting Safety

- The direct work area should not contain buried or embedded electrical, gas, or water lines that could be damaged and/or cause personal injury while cutting.
- Turn off all electricity, gas, and water around the direct work area prior to cutting.
- DO NOT expose yourself or anyone else to the direct line of the blade when operating the saw. 
- DO NOT allow any person, animal, and/or object in and around the work area while cutting.
- DO NOT assume the saw will remain still while in *Neutral* when stopping and/or parking the saw on a slope. Chock the wheels to prevent unnecessary movement.

Hydraulic Safety

- Turn off the engine prior to servicing and/or disconnecting hydraulic components.
- Lower the saw completely to relieve some hydraulic fluid pressure prior to servicing the saw.
- Always place a piece of cardboard or paper up against hydraulic components, or use a leak detection fluid to check for hydraulic fluid leaks. Keep all body parts away from leaks and/or areas that may eject hydraulic fluid. Pressurized hydraulic fluid can penetrate the skin, causing serious injuries. Seek medical attention immediately. 

Belt Safety

- Turn off the engine and let the belts cool down prior to servicing them.
- Regularly inspect the belts for fraying, stress cracks, and/or breakage and replace immediately when damaged.
- Always check belt alignment prior to operating the saw.
- Over-tensioning the belts may damage the power take-off (PTO). Under-tensioning the belts may cause slippage, shorter belt life, and/or poor saw performance.

- Squealing belts indicate looseness.
- DO NOT use old and new belts on the same sheave together.

Transmission Safety

Clean the transmission fan and fan guard regularly to prevent high oil temperatures.

Transporting Safety

- Remove the blade prior to transporting the saw.
- Make sure the truck/trailer is in good, working condition and sufficient to transport the load. DO NOT tow the saw behind a vehicle.
- Close the fuel shutoff valve when transporting.
- Drain the fuel tank when transporting long distances.
- Use heavy-duty ramps that will support the weight of the saw and yourself when loading or unloading.
- Raise the saw to avoid damaging components while moving up and down ramps.
- Use extreme caution when guiding the saw up and down ramps. Slowly drive/push the saw forward down the ramp. Slowly back/pull the saw in reverse up the ramp. Avoid standing directly downhill from the saw to avoid serious injuries. 

- Chock the wheels and secure the saw in a truck/trailer prior to transporting.
- Turn off the engine/motor once the saw is loaded into the truck/trailer. For self-propelled models, place the speed control lever at *Neutral* and engage the transmission prior to turning off the engine.
- Engage the brake once the saw is secure in the truck/trailer to help secure.
- Refer to the Department of Transportation (DOT) for additional information on proper transportation techniques and truck/trailer requirements.

Lifting Safety

- Move yourself and all others away from the lifting area when hoisting the saw to prevent being crushed.



Secure the appropriate hoisting cables, straps, and/or chains to the saw's designated lift points prior to hoisting.

DO NOT attempt to lift the saw irresponsibly and/or improperly.

Go to Discount-Equipment.com to order your parts

Introducing the CC6571

Components

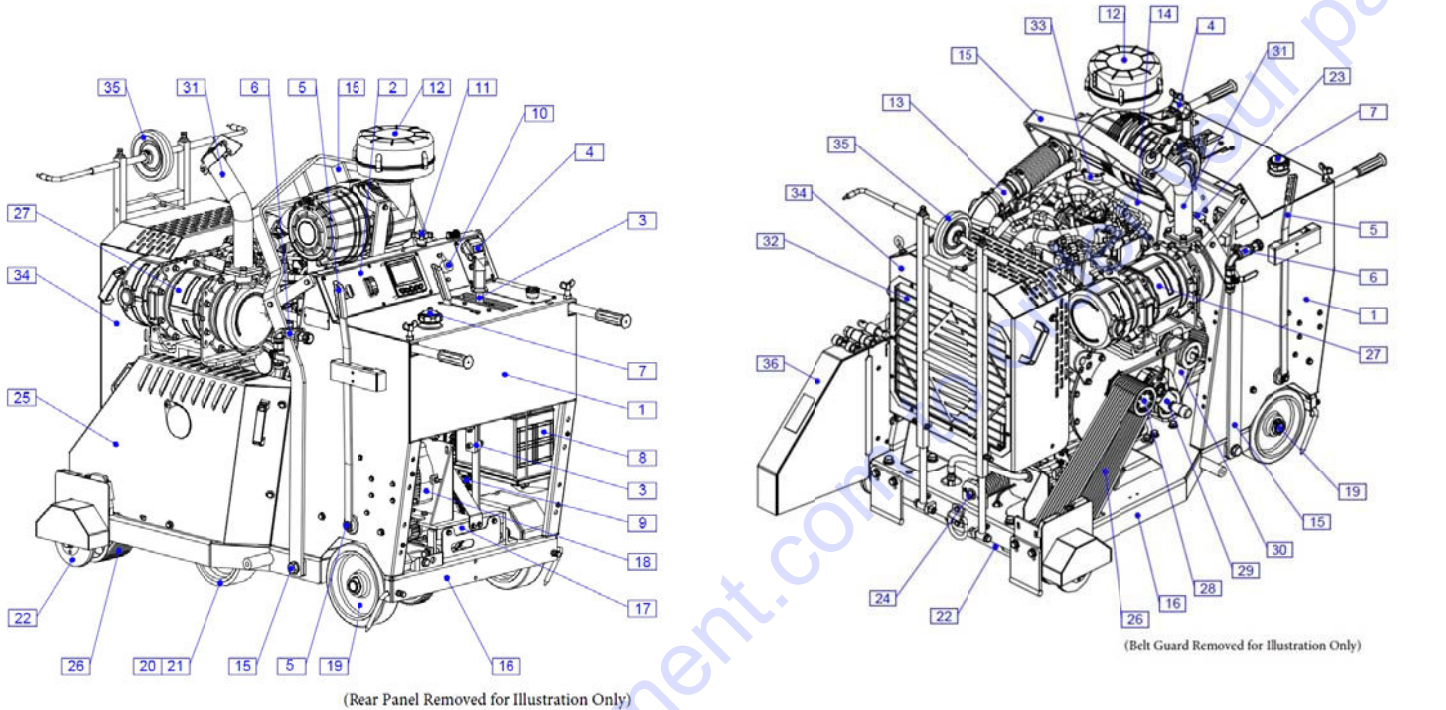

Figure 1: Side Views of CC6571

- | | | |
|-------------------------|--------------------------|------------------------|
| 1. Frame Upright | 14. ECU | 28. PTO |
| 2. Instrument Panel | 15. Lift Frame | 29. Rotary Tensioner |
| 3. Control Lever | 16. Frame Base | 30. Transmission |
| 4. Control Grip | 17. Rear Drive Assembly | Jackshaft |
| 5. Parking Brake | 18. Eaton Transmission | 31. Exhaust Pipe |
| 6. Water Supply | 19. Rear Axle | 32. Radiator |
| 7. Fuel Tank | 20. Front Axle | 33. Coolant Tank |
| 8. Battery Assembly | 21. Front Wheel Assembly | 34. Radiator Shroud |
| 9. Breaker Panel | 22. Blade Shaft | 35. Dual Front Pointer |
| 10. Depth Indicator | 23. Expansion Tank | 36. Blade Guard |
| 11. Depth Stop Assembly | 24. Belt Tensioner | |
| 12. Air Cleaner | 25. Belt Guard | |
| 13. Air Intake | 26. Belt Drive Assembly | |
| | 27. Engine | |

Introducing the CC6571-3

Components

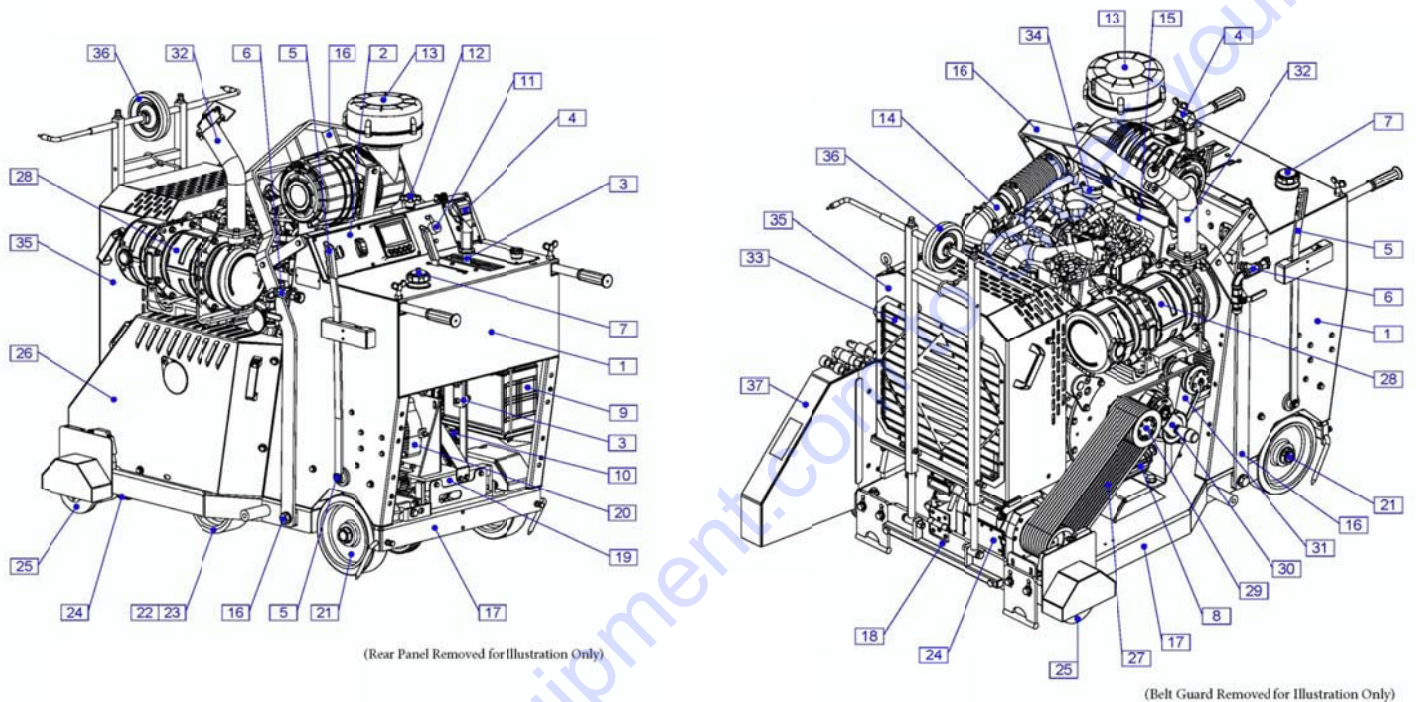

Figure 2: Side Views of CC6571-3

- | | | |
|-------------------------|--------------------------|------------------------|
| 1. Frame Upright | 14. Air Intake | 28. Engine Assembly |
| 2. Instrument Panel | 15. ECU | 29. PTO |
| 3. Control Lever | 16. Lift Frame | 30. Rotary Tensioner |
| 4. Control Grip | 17. Frame Base | 31. Transmission |
| 5. Parking Brake | 18. Access Door | Jackshaft |
| 6. Water Supply | 19. Rear Drive Assembly | 32. Exhaust Pipe |
| 7. Fuel Tank | 20. Eaton Transmission | 33. Radiator |
| 8. Fuel Cooler | 21. Rear Axle | 34. Coolant Tank |
| 9. Battery Assembly | 22. Front Axle | 35. Radiator Shroud |
| 10. Breaker Panel | 23. Front Wheel Assembly | 36. Dual Front Pointer |
| 11. Depth Indicator | 24. 3 Speed Transmission | 37. Blade Guard |
| 12. Depth Stop Assembly | 25. 3 Speed Blade Shaft | |
| 13. Air Cleaner | 26. Belt Guard | |
| | 27. Belt Drive | |

Controls

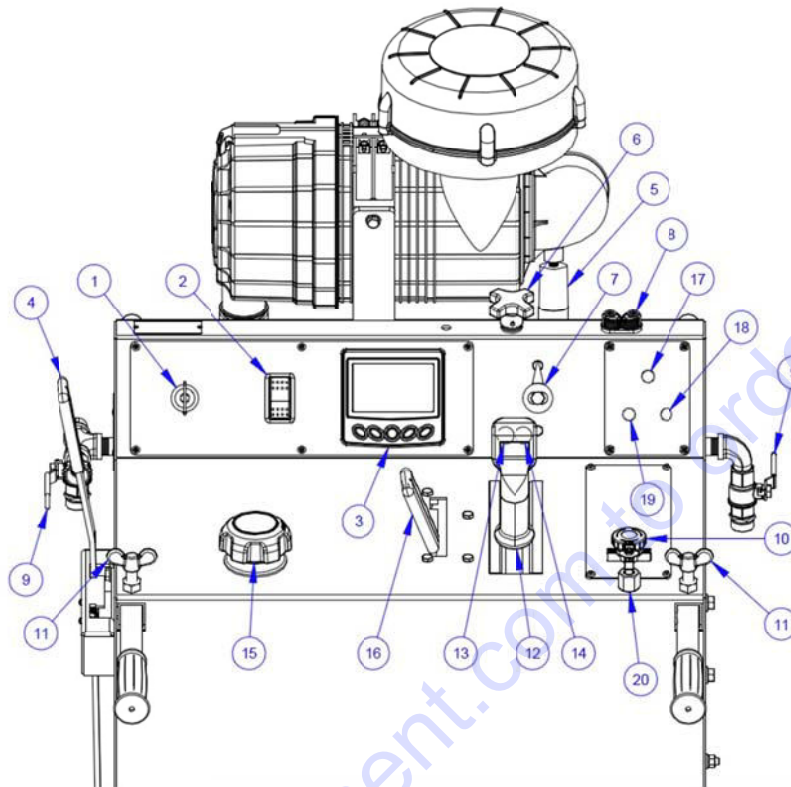
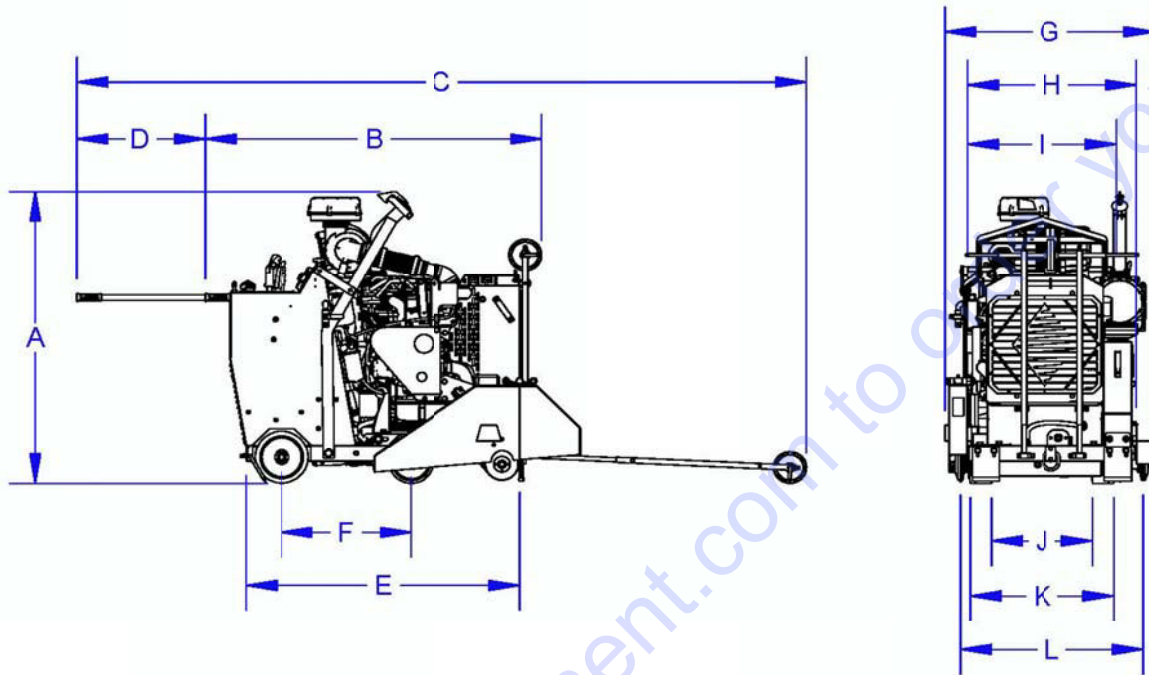

Figure 3: Saw Controls

1. **Ignition Switch**—Starts engine.
2. **Engine Throttle Rocker**—Increases and decreases engine speed/blade speed (RPM).
3. **Engine Display Panel** – Displays specific engine information, speed (RPM), fuel level, DPF regeneration, etc.
4. **Parking Brake Lever.**
5. **Air Cleaner Restriction Indicator** – Determines when to service air cleaner.
6. **Depth Stop Knob**—Secures cutting depth.
7. **Cutting Depth Indicator**—Indicates blade's depth from surface.
8. **Pointer Rope Cleat**—Secures front pointer cable.
9. **Water Valve**—Controls water flow to blade.
10. **Emergency Stop Button**—Stops engine.
11. **Handle Lock Knobs**—Secure handlebars to frame upright.
12. **Travel Speed Control Lever**—Controls forward/neutral/reverse motion of saw.
13. **Raise Pushbutton**—Raises saw and blade.
14. **Lower Pushbutton**—Lowers saw and blade.
15. **Fuel Filler / Gauge Cap**—Opening to add fuel; indicates fuel level.
16. **Transmission Engagement Lever**—Engages/disengages transmission.
17. **Water Safety Switch (Optional Item)**—Detects an improper water pressure.
18. **Spotlight Switch (Optional Item)**—Powers spotlight.
19. **Water Pump Switch (Optional Item)**—Pumps water to blade.
20. **Lowering Speed Valve (Optional Item)** – Changes saw's lowering speed.

CC6571 Dimensions



A	Saw Height	55-1/2"
B	Saw Length - Min.	62"
C	Saw Length - Max.	135"
D	Handle Extension - Max.	24"
E	Frame Length	50-3/4"
F	Wheel Base Length	23-7/8"
G	Saw Width	38-3/4"
H	Frame Width (Front)	31-1/4"
I	Frame Width (Rear)	27-5/8"
J	Front Wheels Inside Width	18-3/4"
K	Rear Wheels Outside Width	26-5/8"
L	Inner Flange to Inner Flange Width	33-3/4"
-	Blade Raise Height - Max.	22-1/2"

Specifications

Table 1: Saw Specifications	
Maximum Cutting Depth	17-3/4" with 42" blade
Blade Shaft Diameter	2"
Arbor Diameter	1" with driven pin
Blade Shaft Bearings	Oil Filled
Blade Shaft Drive	10 V-Belts
Blade Mounting	Right or left
Blade Raise/Lower	Electro-hydraulic pump
Blade Coolant	Dual multi-spray water tubes
Blade Guard Attachment	Slip-on up to 30"; bolt-on for 36" and 42"
Front Wheel Dimensions	8" x 3" x 1 5/8"
Rear Wheel Dimensions	10" x 3" x 2"
Handlebars	Two-position tilt
Transmission	Eaton model 10
Drive Speed	0-200 ft./min
Electric Start	Standard
Hour Meter	Standard
Amp Meter	Warning light
Fuel Capacity	Nine gallons
Tachometer	Standard
Cutting Depth Indicator	Standard
Quick Disconnect Blade Flanges	Standard
Frame Lift	Standard
Quick Release Rear Wheels	Standard
Uncrated Weight (add 100 lb. for crated weight)	1,844 – 1,901 lb.

Table 2: Engine/Motor Specifications	
Manufacturer	Kubota
Model	V2607 Tier 4
H.P. (SAEJ1349) (HP / rpm)	2700 RPM
Fuel Type	Ultra-low sulfur diesel fuel
Cylinders	4
Note: Refer to the engine manual for additional engine information and specifications.	

Operating the CC6571 and CC6571-3

Handlebars

The handlebars help the operator guide and maneuver the saw.

Adjusting the Handlebars

1. Loosen both handle lock knobs.
2. Hold the handlebar grip and place the first handlebar into the handlebar opening below the handle lock knob. The handlebar fits through two different pathways inside the handlebar opening. Place the handlebar at the desired length.
3. Tighten the handle lock knob to secure the handlebar.



Figure 5: Handle Lock Knob and Handlebar

4. Repeat steps 2–3 to secure the second handlebar.
5. Adjust the handlebar length as necessary.

Front Pointer

The front pointer assembly helps the operator follow the cutting line.

Adjusting the Front Pointer

1. Remove the tensioned pointer lanyard from the cable cleat on the frame upright.
2. Lower the front pointer frame to the floor.
3. Loosen both front pointer frame screws.
4. Divide an 8–10 ft. piece of string in half.
5. Place the looped end of string into a gullet on the backside of the blade.

6. Place one string line up against the backside of the blade and one string line up against the front side of the blade. Holding the string ends in one hand, tension the lines out toward the front pointer rod.



Figure 6: String Line against Blade

7. Cap in between the tensioned string lines.

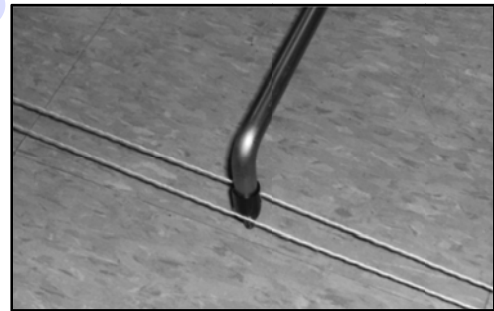

Figure 7: Pointer Cap between String Lines

8. Retighten both front pointer frame screws to secure the pointer rod.
9. Lift the front pointer frame off of the floor when the cutting task is complete.
10. Re-tension the pointer lanyard, and then place the lanyard into the cable cleat to secure the front pointer.

Rear Pointers

The rear pointer rods act as guides when cutting.

Adjusting the Rear Pointers



Figure 8: Rear Pointer Rod

Loosen the screw on the back of the frame edge to adjust the rear pointer rod's length and to move the pointer up or down, and then retighten the screw to secure.

Battery

**WARNING**

Ignitable explosive gases are emitted from the battery. DO NOT expose the battery to sparks or open flames, and keep the area around the battery well-ventilated.



**CAUTION**

Use a proper battery tester, such as a voltmeter, to test the battery strength. Use protective eyewear or a face shield, and avoid contact with the skin when handling a battery.



The saw contains a charged battery with one positive battery cable lead and one negative battery cable lead.

Diamond Blades

**WARNING**

DO NOT exceed the blade's maximum recommended speed when cutting. Excessive blade speeds can cause blade breakage, resulting in serious injuries and/or death.



Using the proper blade (size and type) preserves the blade and improves cutting and operator efficiency, resulting in lower costs. Refer to www.discount-equipment.com for a list of different blade types and additional blade information.

Inspecting the Blade

Inspect each blade prior to installation and discard all damaged blades. Inspect all blades for:

- Cracks, nicks, and dents.
- A damaged and/or deformed arbor (center hole).
- Darkness and/or discoloration near edge of blade.
- A deformed blade circumference.
- Segment loss and/or segment cracks.
- Core wear.
- Bending.
- Uneven side-widths.

Blade Speed

Refer to the CC6571 or CC6571-3 RPM Chart, the blade, or the blade packaging information for the recommended blade speeds when cutting. DO NOT exceed the maximum recommended blade speed. DO NOT use a blade for cutting that requires a lower speed than the minimum blade shaft speed.

CC6571 RPM CHART							
BLADE SIZE	BLADE RPM	BLADESHAFT SHEAVE	ENGINE SHEAVE	ENGINE RPM	BELT SIZE	FLANGE SIZE	MAX CUT DEPTH
14"	2,700	4"	4"	2,700	3VX570	4-1/2"	4-1/2"
20"	2,400	4.5"	4"	2,700	3VX580	4-1/2"	7-1/2"
26"	1,950	4.5"	4"	2,200	3VX580	4-1/2"	10-1/2"
30"	1,700	6"	4"	2,550	3VX600	6"	11-3/4"
36"	1,400	6"	4"	2,100	3VX600	6"	14-3/4"
42"	1,200	6"	4"	1,800	3VX600	6"	17-3/4"

Figure 9: CC6571 RPM Chart

CC6571-3 SPEED RPM CHART				
BLADE SIZE	BLADE RPM	GEAR POSITION	ENGINE RPM	MAX CUT DEPTH
14"	2,700	H (High)	2,700	3-3/4"
20"	2,550	H (High)	2,550	6-3/4"
26"	1,775	M (Medium)	2,700	9-3/4"
30"	1,675	M (Medium)	2,550	11-3/4"
36"	1,175	L (Low)	2,700	14-3/4"
42"	1,100	L (Low)	2,550	17-3/4"

Figure 10: CC6571-3 RPM Chart

Installing the Blade

! WARNING

DO NOT install a blade with the engine running.

Failure to properly secure the outer flange and blade may cause parts to loosen or fall off of the saw.



! CAUTION

Wear gloves and be alert to the surrounding environment when handling blades.

Use the 15/16" combination wrench that comes with the saw when installing/removing a blade. Apply force to the opposite end of the wrench and tighten the bolt to 125 ft-lb (169.5 Nm) to properly secure the outer flange and blade. This measurement can be verified with a torque wrench.

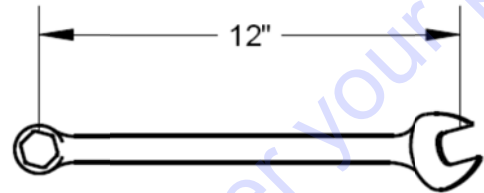

Figure 11: Wrench

Install the blade on either the right or left side of the saw; utilize the most appropriate side for the cutting task. Adjust the engine governor setting, as necessary, and install the appropriate blade shaft sheave, blade drive belts, and flanges when changing the blade size. **Changing the blade size requires assistance from technical support. Contact technical support prior to running the saw.** Refer to the RPM Chart posted on the saw, or in the Diamond Products' Parts List for additional information.

Remove Mounted Blade Guard

Left Side of Saw with 26" to 42" Guards

1. Remove the blade guard or insert lock pin (attached to blade guard) through the wide rear hinge knuckle to gain access to the blade flanges.

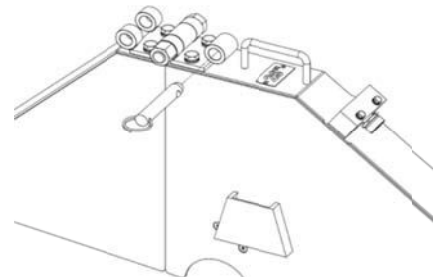

Figure 12: Lock Pin through Rear Hinge

2. Lift up the front half of the blade guard until the front hinge knuckles contact this lock pin. (Note: This prevents the front half of the guard from

contacting the engine DPF canister.) Secure by using second lock pin located on belt guard.



Figure 13: Front Hinge Knuckle Contacts Lock Pin

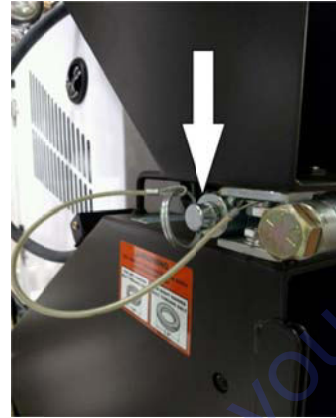

Figure 15: Blade Guard Locking Pin

Remove Outer Blade Flange

Warning: Front half of blade guard must be secured in this upright position!

3. Secure front half of blade guard by positioning ring of first lock pin to allow second lock pin to insert through this ring and continue on through the front 2 hinge knuckles.

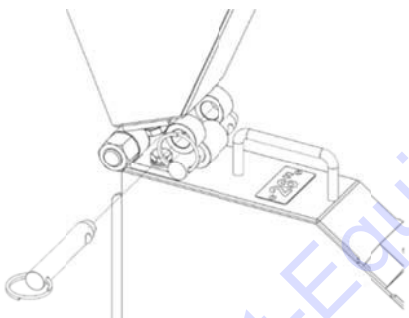

Figure 14: Second Lock Pin through Ring of First



Figure 16: Blade Flanges Together

1. Remove the blade shaft bolt using the wrench. Turn the bolt clockwise (left-hand threads) on the right side of the saw, and counterclockwise (right-hand threads) on the left side of the saw.
2. Remove the bolt and wedge lock washer, and carefully pull the outer flange out of the inner flange alignment pin hole and blade shaft.

Right Side of Saw and Left Side (less than 26" to 42") Mounted Blade Guards

1. Remove the blade guard or pivot the front of the guard 180° (fully upward) to gain access to the blade flanges. Secure with pin.

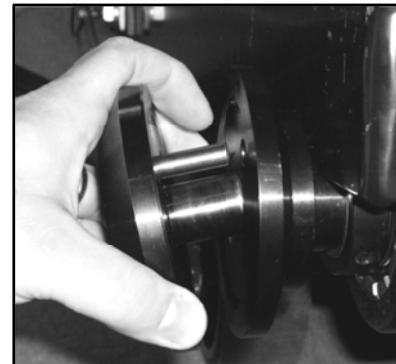

Figure 17: Blade Flanges Separated

3. Inspect the bolt, outer flange, inner flange, and inner flange alignment pin hole for visible damages and clean, repair, or replace or as necessary.
4. Select the correct blade type for the cutting task and inspect the blade for visible damages.
5. Raise the saw slightly to provide room to install the blade.
6. Place the blade next to the inner flange. Always point the arrow printed on the blade in the direction of the blade shaft's rotation when installing the blade.
7. Align and fit the outer flange alignment pin and shaft through the blade holes, and into the blade shaft and inner flange alignment pin hole.

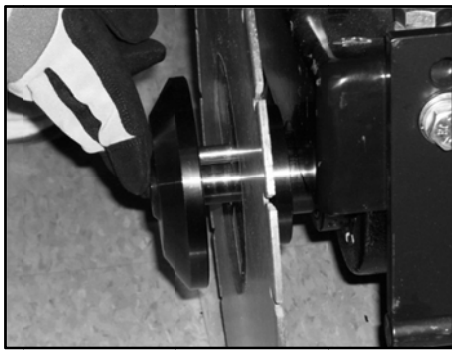

Figure 18: Inserting the Outer Flange

8. Slightly rotate the outer flange and blade backward to eliminate backlash (looseness) between parts.
9. Place the wedge lock washer onto the blade shaft bolt and insert the bolt into the blade shaft.
10. Tighten the bolt by hand as much as possible, and slowly lower the blade until it just touches the ground's surface.
11. Tighten the bolt, using the wrench, to 125 ft-lb (169.5 Nm) to properly secure the outer flange and blade. This measurement can be verified with a torque wrench.

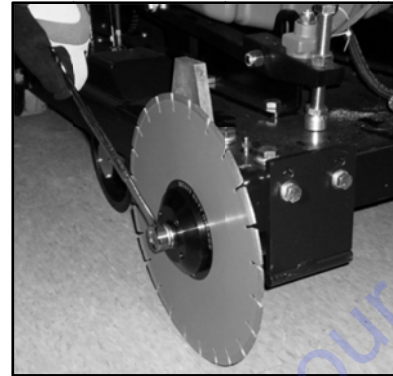



Figure 19: Tightening the Bolt

12. Reattach the blade guard or pivot the front of the guard down and over the blade to secure.

Removing the Blade

! CAUTION
 Always let the blade cool prior to removing or replacing blades when dry cutting.



1. Remove the blade guard or pivot the front of the guard 180° (fully upward, secure with pin) to gain access to the blade flanges.
2. Slowly lower the blade until it just touches the ground's surface.
3. Remove the blade shaft bolt and wedge lock washer from the blade shaft.
4. Carefully pull the outer flange out of the inner flange alignment pin hole and blade shaft, and then remove the blade. Place the blade in the appropriate storage location.
5. Inspect the bolt, outer flange, inner flange, and inner flange alignment pin hole for visible damages and clean, repair, or replace as necessary.
6. Align and fit the outer flange alignment pin and shaft into the blade shaft and inner flange alignment pin hole.
7. Place the wedge lock washer onto the blade shaft bolt and insert the bolt into the blade shaft.
8. Tighten the bolt by hand to secure the inner and outer flange together.
9. Reattach the blade guard or pivot the front of the guard down and over the blade to secure.

Blade Guard

! WARNING

DO NOT operate the saw with the blade guard raised or removed.
DO NOT remove the blade guard with the engine running.
Blade exposure when cutting should not exceed 180°.
Always pivot the front of the blade guard 180° (fully upward) and secure with pin so the guard does not swing down unexpectedly, causing serious injuries.

The blade guard shields the blade and must always be in place when operating the saw. Be sure to use a guard that matches the blade size.

Installing the Blade Guard

1. Regularly inspect the blade guard water tubes for cuts, slurry, and/or debris. Clean them using a wire brush or replace the tubes as necessary.
2. Place the tapered mount from one side of the blade guard down onto the tapered blade guard mount on the frame base.

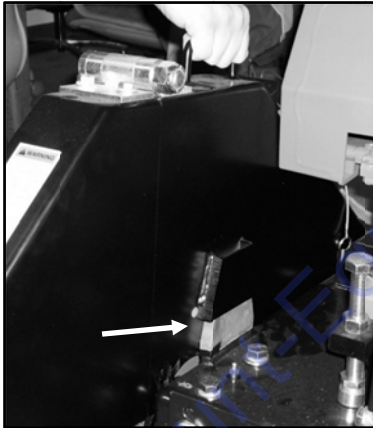

Figure 20: Lowering the Guard

3. Insert the lock pin, connected to the lanyard, into the tapered blade guard mount hole.
4. For the 36-42" blade guards; place the blade guard cap screw through the hole on the rear side (facing away from the saw) of the blade guard, and then tighten the screw into the threaded hole on the side of the frame base.

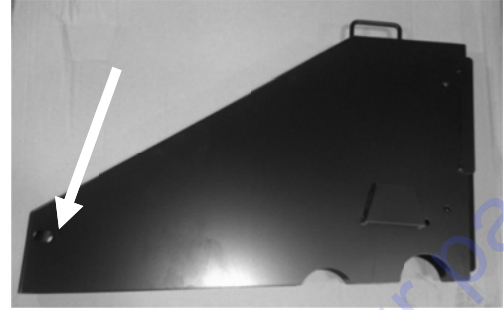

Figure 21: Blade Guard Cap Screw Hole

5. Connect one end of the water supply hose to the water valve and the other end to the blade guard hose fitting.

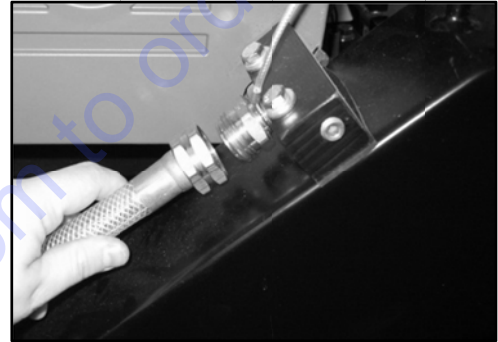

Figure 22: Blade Guard Hose Fitting

Removing the Blade Guard

1. Disconnect the water supply hose from the blade guard hose fitting.
2. Remove the lock pin from the tapered blade guard mount hole.
3. For the 36-42" blade guard; remove the blade guard cap screw from the threaded hole on the side of the frame base and from the blade guard.
4. Use the handle on the blade guard to rock the guard back and forth while lifting the guard off of the tapered blade guard mount.

Flange Guard

Installing the Flange Guard

1. Remove the lock pin from the tapered blade guard mount hole.



Figure 23: Lock Pin

2. The backside of the flange guard has two tapered mounts. Place the tapered mount (that best fits the flange guard over the blade flange) down onto the tapered blade guard mount.
3. Insert the lock pin into the tapered blade guard mount hole to secure the flange guard.

Removing the Flange Guard

1. Remove the lock pin from the tapered blade guard mount hole.
2. Lift the flange guard off of the tapered blade guard mount.

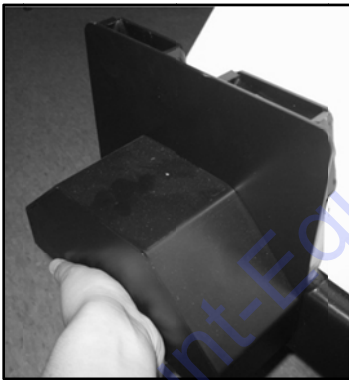

Figure 24: Flange Guard

3. Reinsert the lock pin into the tapered blade guard mount hole.

Water Supply

The water supply cools the blade and minimizes dust when cutting. *Note: Always test the water supply for adequate pressure and flow before cutting.*

Using the Water Supply

1. Connect the water source hose to the horizontal hose fitting on the left side of the saw.
2. Connect the water supply hose to the vertical hose fitting on the right or left side of the saw, depending on the cutting task.
3. Connect the other end of the water supply hose to the blade guard hose fitting on the same side of the saw. *Note: Disconnect and reconnect the hose when moving the blade guard to the opposite side of the saw.*
4. Turn on the water valve to start the water flow and turn off the water valve to stop the water flow. The water flow between these two points increases/decreases based on the valve's position. *Note: Turn on the water just before cutting to avoid wasting water.*
5. Disconnect the water supply hose from the blade guard hose fitting when the cutting job is complete.

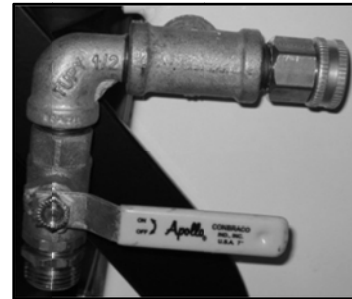

Figure 25: Left Water Valve

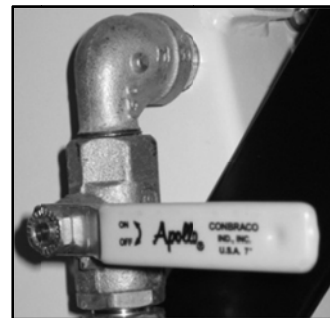

Figure 26: Right Water Valve

Water Safety Switch

The water safety switch (optional item) turns the engine off when the system detects insufficient

water pressure. Turn on the switch just before cutting to activate the safety feature. **Note:** *This feature does not detect clogged water hoses. Check the hoses regularly and clean as necessary.*

Water Pump

The water pump (optional item) pumps water from the water source hose to the saw blade.

1. Turn on the water pump switch to start the pump. DO NOT start the water pump until just before cutting. DO NOT leave the water pump on when the cutting task is complete to avoid draining the battery.
2. Turn off the water pump switch to stop the pump.

Control Grip

Two control grip pushbuttons raise and lower the saw. **Note:** *The saw can be raised and lowered with the engine off.*



Figure 27: Control Grip

Raising the Saw

Press the control grip's left pushbutton to raise the saw and release to stop. **Note:** *Raise the blade when maneuvering the saw to provide proper clearance between the blade and the ground.*

Lowering the Saw

Press the control grip's right pushbutton to lower the saw and release to stop.

Lowering Speed

Option 1: The lowering speed metering valve (optional item) changes the saw's lowering speed. Turn the valve counterclockwise to increase the

lowering speed and clockwise to decrease the lowering speed.

Option 2: Turn the engine off, remove the hydraulic pump cover plate, and adjust the flow control valve on the hydraulic pump to change the saw's lowering speed.

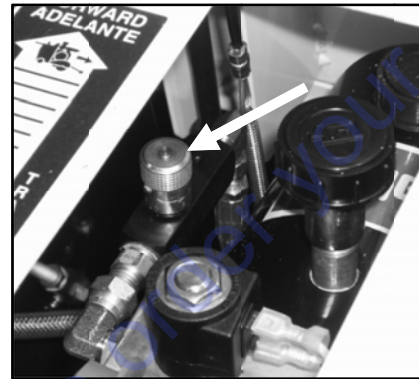

Figure 28: Flow Control Valve

Speed Control Lever

The speed control lever places the saw in neutral (no movement), forward, or reverse. **Note:** *The engine must be running and the transmission must be engaged to move the saw using the speed control lever, which should be in Neutral when starting the engine.* Press the emergency stop button to immediately stop the engine as necessary.



Figure 29: Speed Control Lever

Forward Control

Push the speed control lever forward to the desired traveling speed. The maximum speed the saw will move forward, at full throttle, is 200 ft. /min.

Reverse Control

Pull the speed control lever backward to the desired traveling speed. The maximum speed the saw will move in reverse, at full throttle, is 200 ft./min.

Neutral Control

Place the speed control lever at *Neutral* to stop the saw from moving forward or backward. DO NOT assume at any time that the transmission will act as a brake in neutral.

Transmission

Disengage the transmission prior to starting the engine to prevent unnecessary saw movement. When the transmission is disengaged a green icon in the letter D will light up on the display panel. The engine must run at half throttle or greater for proper transmission efficiency when maneuvering the saw with power.



Figure 30: Transmission Lever

Engaging the Transmission

1. Place the speed control lever at *Neutral*.
2. Start the engine.
3. Slide the transmission engagement lever over and out of the *Disengage* slot, and up and into the *Engage* slot. The disengaged icon on the display panel will turn off.

Disengaging the Transmission

1. Place the speed control lever at *Neutral*.
2. Slide the transmission engagement lever over and out of the *Engage* slot, and down and into the *Disengage* slot. When the transmission is

disengaged a green icon in the letter D will light up on the display panel.

Shifting Three Speed Transmission

! CAUTION
Do not attempt to shift transmission when motor is running.

1. Stop engine.
2. Disengage the transmission.
3. Open access door to expose transmission lever.

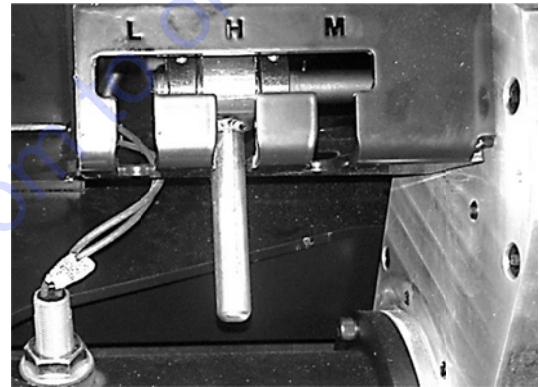

Figure 31: Transmission Lever

4. Using wrench rotate blade shaft one flat either direction until lever engages into desired slot in shift gate

You will need to rotate the output shaft **BY HAND** to complete this motion.

5. Drop shift lever into desired shift gate slot. From left to right, Low, High, Medium marked L, H, and M.

Fuel System

! WARNING
DO NOT operate the saw with a fuel leak.
DO NOT fuel the saw with the engine running.
DO NOT smoke or expose fuel to open flames when filling the fuel tank and/or working with fuel.



! CAUTION
Clean up spilled fuel prior to starting the engine.
If over filled fuel may seep out from the fuel cap vent when the saw is raised.

Adding Fuel

Check the fuel level daily and fill as necessary.

1. Lower the saw to the ground so it is level.
2. Stop the engine and let it cool down.
3. Remove the fuel tank cap.



Figure 32: Fuel Tank Cap

4. Fill the nine-gallon fuel tank with ultra-low sulfur diesel fuel only. Refer to the engine manual for a list of appropriate diesel fuels.
5. Replace the fuel tank cap and tighten to secure.

Cold Weather Fuel

Diesel fuel can become thick in cold weather, possibly resulting in a clogged fuel system and/or a less efficient engine. Refer to the engine manual for a list of appropriate diesel fuels in cold weather.

Storage

Fill the fuel tank to prevent condensation and contamination in the tank for shorter storage

periods. Drain the fuel tank and fuel lines for extended storage periods.

Display Panel

The display panel is a rugged CAN-based controller. This section explains the functions of the unit, describes the display screens and gives details about the configuration.

Turning the ignition switch to run or start will activate the display panel. A sequence of screens will display on the control panel. First you will see a notation in the upper left corner, “Booting”, followed by Diamond Products logo and then the gauge screen. If one or more of the emergency stop triggers are activated, the E-stop switch is active, coolant level is low, or back panel is open (on certain models) an emergency shutdown window will be displayed. Operator must clear these messages before engine can start.

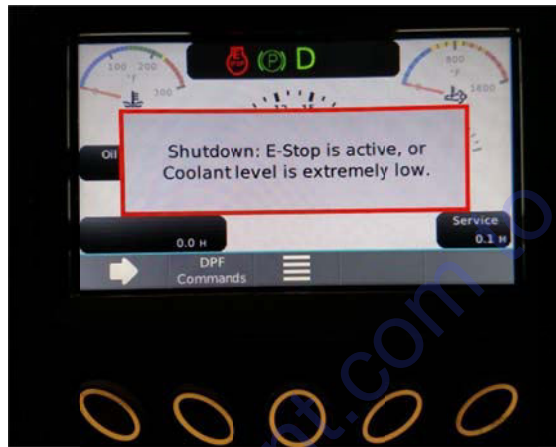





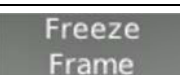





Figure 33: Display Panel with Emergency Shutdown Window

The Gauge Screen (Home) displays four dial gauges and three digital gauges.

Dial Gauge	Digital Gauge
<ul style="list-style-type: none">• Engine and Tachometer Speed/RPM• Engine Coolant Temperature• After Treatment 1 Diesel Particulate Filter Outlet Gas Temperature (Exhaust Temperature)• Electrical Potential Voltage	<ul style="list-style-type: none">• Oil Pressure – Lamp Only• Fuel Level – Lamp Only• Engine Total Hours of Operation• Service – Engine Hours Logged since Last Service Date







Soft Keys (Buttons)

The Soft Key choices are associated with the throttle source. These will appear on the bottom of the display screen and can be selected by pushing the button directly below the soft key.

Soft Key	Description
	DPF Commands – Displays the Diesel Particulate Filter (DPF) command to access the Un-inhibit Regen and Inhibit Regen
	Request Regen – Sends message to Engine Control Unit (ECU) to start regenerating the DPF when prompted by engine ECU
	Stop Regen – Sends message to ECU to stop regenerating the DPF (should not be used unless necessary)
	Freeze Frame – Requests the freeze frame data from the ECU when faults are present
	Main Menu – Two pages that list seven action items. Five are available to the operator: Gauges, Diagnostics, System Info, Lamp Info and User Settings. (Panel Configuration and Service are reserved for technical support)
	Down – Navigates the curser downward through a list
	Up – Navigates the curser upward through a list
	Select – Enters the action item next to the cursor in a list. Also used with the Main Menu soft key to get back to the Main Menu from any screen
	Deselect – Closes pop-up messages

Status Icons

The Status Icons are color coded and light up when communicating to the operator. Pay close attention to any Status Icons and color if it appears.

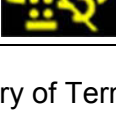
Status Icon	Description
	Check Engine – Yellow icon is visible if the controller receives a DM1 (Active Diagnostic Trouble Code) message with an amber lamp command.
	Check Engine – Red icon is visible if the controller receives a DM1 message with a red lamp command.
	Parking Brake Switch – Green icon displays when the parking brake is applied.
	Transmission Disengaged – Green icon displays when the transmission is disengaged.
	Emergency Stop Button – Red icon displays when emergency stop button is engaged.
	Engine Exhaust High Temperature Lamp – Red icon displays during active DPF regeneration when the DPF outlet temperature is greater than 450°C and post engine fuel injection is occurring.
	Diesel Particulate Filter Lamp Command – Red icon is: (1) On solid during regeneration (2) Blinking to request parked regeneration. Yellow Icon is on solid to request automatic active regeneration when regeneration is inhibited.
	DPF Regeneration set to Inhibit – Displays when the machine or the operator has inhibited regeneration.

Glossary of Terms and Acronyms

CAN – Controller Area Network
 DM1 – Diagnostic Message 1, Active Diagnostic Trouble Codes
 DM2 – Diagnostic Message 2, Previously Active Diagnostic Trouble Codes
 DM4 – Freeze Frame Parameters
 DPF – Diesel Particulate Filter
 DTC – Diagnostic Trouble Code
 ECU – Engine Control Unit
 FMI – Failure Mode Identifier
 PGN – Parameter Group Number
 SPN – Suspect Parameter Number

Main Menu

The Main Menu is the default gauge screen (Home). There are three soft key options available from the Main Menu:

1. Arrow
2. DPF Commands
3. Main Menu Soft Key (☰).



Figure 34: Gauge Screen (Main Menu)

Arrow

Selecting the soft key under the Arrow will display the Engine and Tachometer RPM and the DPF Outlet Gas Temperature gauge screen.

The RPM gauge displays engine RPM with the red arrow (arrow #1) and the blade RPM with the red line pointer (arrow #2).



Figure 35: RPM Gauge Indicator Arrows

To return to Main Menu select the soft key below the Arrow or the soft key below Main Menu then using the up and down arrows place cursor on Gauges and select the soft key under (👁).

DPF Commands

Select the soft key under DPF Commands and the soft key options will display three soft key options:

- Return
- Main Menu
- Inhibit Regen (default) or Un-inhibit Regen.

(**Note:** The saw will default to auto regen mode. Therefore, when starting the saw Inhibit Regen will display.)



Figure 36 DPF Command Display

1. Return – Select the soft key under Return to take you back to the Main Menu.
2. Main Menu – Select the soft key under the main menu icon, then using the up and down arrows place the cursor on Gauges and select the soft key under () to take you back to the main gauge screen.
3. Inhibit Regen – Select to temporarily turn off the default auto regen and place the saw in Inhibit Regen status. The DPF will remain in Inhibit Regen status until the engine is shutdown. The next time the engine starts the DPF will default back auto.

A yellow warning window will display letting you know you are temporarily inhibiting the DPF regeneration. Select the soft key X to close the window.

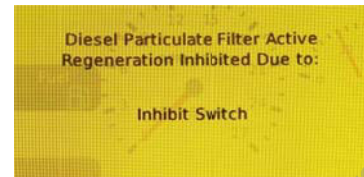

Figure 37 DPF Regeneration Inhibited

Main Menu Action Items

Press the Main Menu () soft key to view the menu action list. Scroll through the Main Menu action list on two screens, using the Up/Down soft keys to maneuver the cursor to the action item you want, then press the soft key under the circle ().

1. Gauges (Main Menu default screen)
2. Diagnostics
3. System Information
4. Lamp Information
5. User Settings
6. Panel Configuration (Password Required)
7. Service (Password Required)

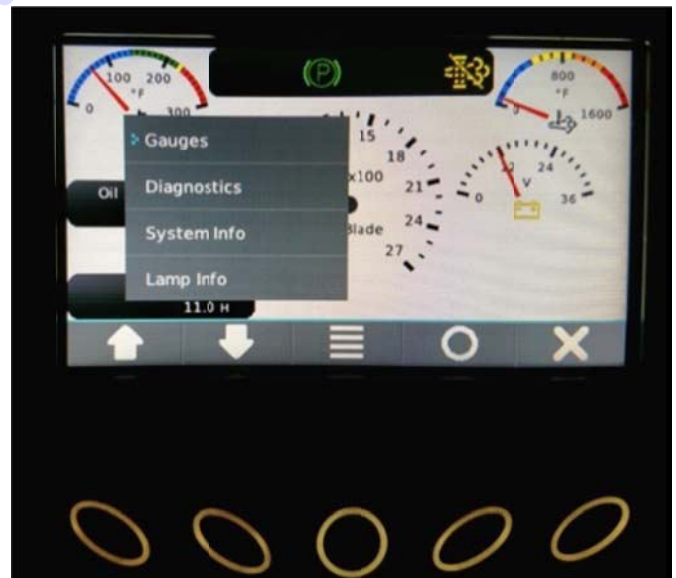

Figure 38: Main Menu Action Items – Screen 1

TO PURCHASE THIS PRODUCT PLEASE CONTACT US



**Equipment Financing and
Extended Warranties Available**



**Discount-Equipment.com is your online resource for
commercial and industrial quality parts and equipment sales.**

561-964-4949

visit us on line @ www.discount-equipment.com

Select an option below to find your Equipment

Search by Manufacturer

Search by Product Type

Request a Quote

We sell worldwide for the brands: Genie, Terex, JLG, MultiQuip, Mikasa, Essick, Whiteman, Mayco, Toro Stone, Diamond Products, Generac Magnum, Airman, Haulotte, Barreto, Power Blanket, Nifty Lift, Atlas Copco, Chicago Pneumatic, Allmand, Miller Curber, Skyjack, Lull, Skytrak, Tsurumi, Husquvarna Target, Stow, Wacker, Sakai, Mi-T-M, Sullair, Basic, Dynapac, MBW, Weber, Bartell, Bennar Newman, Haulotte, Ditch Runner, Menegotti, Morrison, Contec, Buddy, Crown, Edco, Wyco, Bomag, Laymor, EZ Trench, Bil-Jax, F.S. Curtis, Gehl Pavers, Heli, Honda, ICS/PowerGrit, IHI, Partner, Imer, Clipper, MMD, Koshin, Rice, CH&E, General Equipment, Amida, Coleman, NAC, Gradall, Square Shooter, Kent, Stanley, Tamco, Toku, Hatz, Kohler, Robin, Wisconsin, Northrock, Oztec, Toker TK, Rol-Air, APT, Wylie, Ingersoll Rand / Doosan, Innovatech, Con X, Ammann, Mecalac, Makinex, Smith Surface Prep, Small Line, Wanco, Yanmar



Figure 39: Main Menu Action Items – Screen 2

Gauges

Returns screen to Main Menu

Diagnostics

The screen displays the following items:

- Active Diagnostics
- Logged Diagnostics



Figure 40: Active or Logged Diagnostics

Active Diagnostics

Use the UP/DOWN soft keys and stop the cursor next to the action item Active Diagnostics. Press to select (⊙) soft key.

The screen displays active warnings or faults from the ECU. Each diagnostic is shown with the appropriate Suspect Parameter Number (SPN) and Failure Mode Indicator (FMI), Text Description (if available) and the ID/Name of the device that transmitted the DM1 message.

Press the UP/DOWN soft keys to reach the next diagnostic in the list.



Figure 41: Active Diagnostics Screen

Logged Diagnostics

Use the UP/DOWN soft keys, and stop the cursor next to the action item Logged Diagnostics. Press to select (⊙) soft key. The screen displays the controller requests DM2 (stored trouble codes, not active), warning or faults from the ECU. Each diagnostic is shown with the appropriate information:

- Suspect Parameter Number (**SPN**)
- Failure Mode Indicator (**FMI**)
- Text Description (if available)
- ID/Name of the device that transmitted the DM1 message



Figure 42: Logged Diagnostics

Note: Select the Freeze Frame Button to request the freeze frame data from the ECU when faults are present.

System Information

Scroll through the Menu list using the UP/DOWN soft keys, and stop the cursor next to the action item System Info. Press to select (Ⓞ) soft key. The screen displays the following items:

- Engine Model
- Engine Serial Number
- ECU Software ID
- Fuel Rate
- Time Since Last Active Regen
- File Name of Installed Software

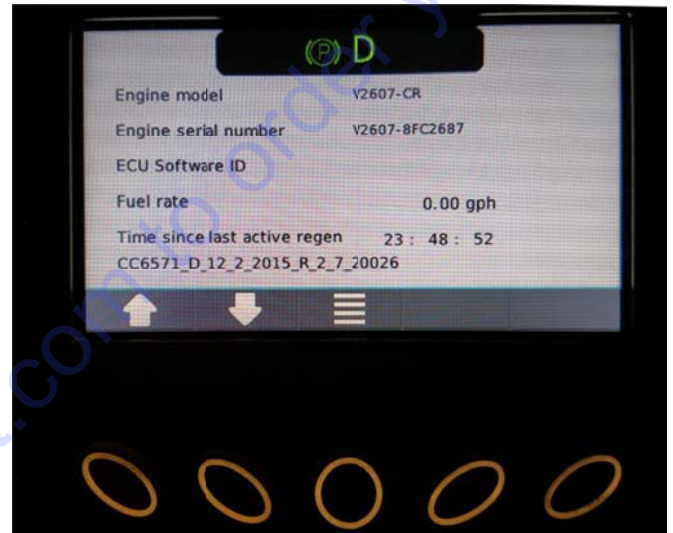

Figure 43: System Info Screen

Press the UP/DOWN soft keys to display a screen with application and configuration information.

Lamp Information

Scroll through the Menu list using the UP/DOWN soft keys, and stop the cursor next to the action item Lamp Info. Press to select (OK) soft key.

This screen shows the Diesel Particulate Filter (DPF) Lamp symbols and provides a description and cautionary information for each symbol. Use the UP/DOWN soft keys to scroll to each symbol.



Figure 44: High Exhaust Temperature Due to DPF Regeneration Symbol Screen



Figure 46: Inhibiting DPF Regeneration Screen



Figure 45: DPF Needs to Regenerate Screen



Figure 47: Parked Regeneration Overview Screen

User Settings

Scroll through the Menu list using the UP/DOWN soft keys, and stop the cursor next to the action item **User Settings** - Press to select (⊙) soft key. The screen displays the following action items:

- Colors
- Brightness
- Language
- Units

Screen Color

Using the UP/DOWN soft keys stop the cursor next to the action item, Colors. Set your preference for day or night vision by using the +/- soft keys. To exit the screen select the Main Menu (☰) soft key and then select the (⊙) soft key.



Figure 48: Night Setting Preference Screen



Figure 49: Day Setting Preference Screen

Screen Brightness

Using the UP/DOWN soft keys stop the cursor next to the action item **Brightness**. Set the brightness of the backlight by using the +/- soft keys. To exit the screen select the Main Menu (☰) soft key and then select (⊙) soft key.



Figure 50: Screen Brightness

Language

Using the UP/DOWN soft keys stop the cursor next to the action item, **Language**. Set your language preference using the +/- soft keys.

- English
- French
- German
- Spanish
- Italian
- Japanese

To exit this screen, select the Main Menu (☰) soft key and then select (⊙) soft key.

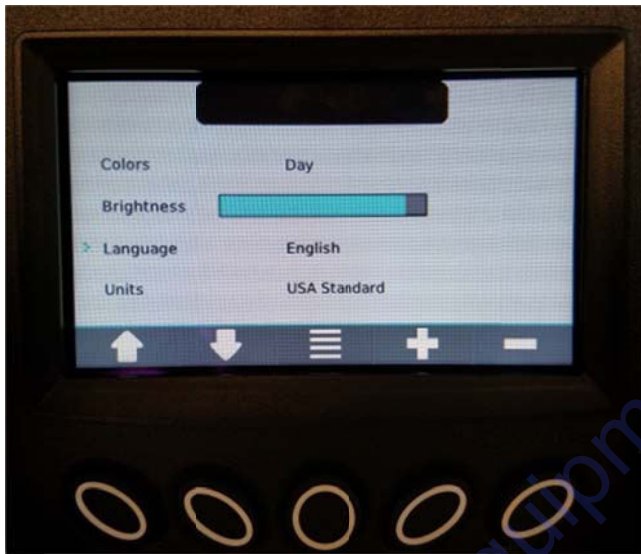

Figure 51: Set Language Preference Screen

Units

Using the UP/DOWN soft keys stop the cursor next to the action item, **Units**. Set your unit preference using the +/- soft keys. To exit the screen select the Main Menu (☰) soft key and then Select (⊙) soft key.

- USA Standard
- Metric kPa
- Metric Bar

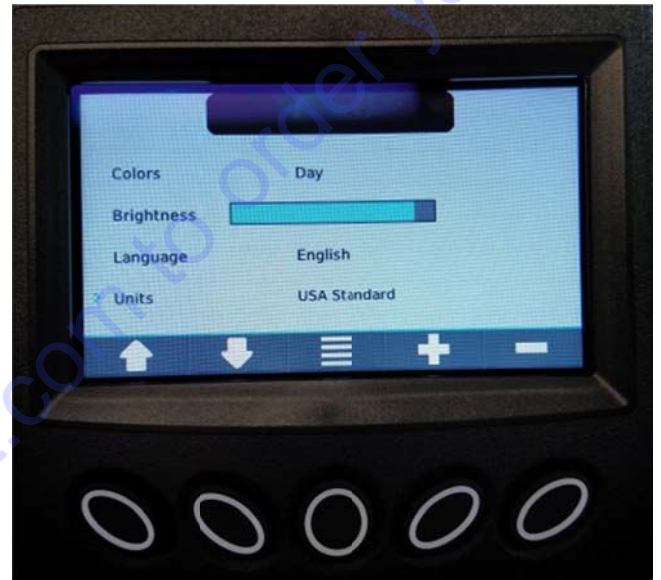

Figure 52: Set Unit Preferences Screen

Automatic Shutdown

There are two faults the engine communicates to the display screen to initiate a shutdown. The two faults from the ECU are displayed on the display screen as P0093 and P1274 to the operator. The engine is shutdown for safety reasons. Contact Discount-equipment

Regeneration

Passive Regeneration

Occurs when the temperature of the exhaust is high enough to naturally burn off at least some of the particulates (soot) captured by the DPF. Most normal use of the saw where the engine is operated under full load will cause exhaust temperatures high enough to produce passive regen, preventing soot buildup. No action required from operator.

CAUTION - ACTIVE REGENERATION will cause the exhaust temperatures to be extremely high. Ensure exhaust will not come into contact with combustible materials.

Active Regeneration

The CC6571 and CC6571-3 are factory set DPF Un-inhibited. If the system detects the exhaust temperatures are insufficient to passively keep the DPF from clogging with particulates, it will initiate active regeneration. The engine controls inject diesel fuel directly into the DPF to increase temperature to burn off, i.e. clean, the soot captured in the filter. This should occur infrequently, but will happen more often if the engine is allowed to idle excessively (longer than five minutes) or sawing is lightly loaded. Failure to change oil at recommended intervals can also contribute to excessive soot buildup. It is not unusual to see excessive smoke being emitted for the tailpipe during regeneration. It is recommended to let the regeneration complete automatically but if it needs to be interrupted turn the ignition to Stop. Operator needs to ensure exhaust will not come into contact with combustible materials.

During active regeneration the display panel will show the red status icon, Engine Exhaust High Temperature Lamp.



Engine Exhaust High Temperature Lamp – Red icon displays during active DPF regeneration when the DPF outlet temperature is greater than 450°C and post engine fuel injection is occurring

CAUTION - Performing a PARKED REGENERATION will cause the exhaust temperatures to be extremely high. Ensure exhaust will not come into contact with combustible materials.

Parked Regeneration

The machine is in an operating condition such that the DPF can regenerate.

Parked Regeneration Ready	
Action	Description
Cancel Regen	Communicates with the engine that regeneration is not wanted by the operator or is unsafe at this time.
Regen Mode Inhibit	Communicates with the engine that regeneration is not wanted or is unsafe to regenerate at this time.
Request Regen	Communicates with the engine that regeneration is desired by the operator and is safe at this time.

The display will show a message in a blue pop-up once all conditions allowing a parked regeneration to occur are met:

- Regen Levels must be at or above the appropriate level set in the ECU to allow for a parked regeneration.
- Park/Disengage switch must be on. Placing the equipment in park/disengage will activate a switch the display panel is monitoring then transmits to the engine ECU which will allow for a parked regeneration.
- Throttle control of the engine must be at its rest state with no throttle applied.
- DPF Command Inhibit Regen must be turned off to allow for a parked regeneration.
- Parking brake must be on.
- Move machine to a safe location.

Regeneration Screen Examples

The operator may experience a pop-up Regen Caution message on the controller screen. Messages require an active response by the Operator so it is important the Operator reads the entire pop-up message. Some messages require using the UP/DOWN soft keys to maneuver through the entire message. See section on Regeneration Levels for more examples.



Figure 53 Yellow Regeneration Caution Single Screen Example



Figure 54 Orange Regen Caution Screen 1 Example of message that requires down soft key.



Figure 55 Orange Regen Caution Screen 2

Cancel Parked Regeneration.

Click on the (**X**) soft key. This action cancels the regeneration process, removes the pop-up and takes the operator back to the Gauge Screen.

Note: The machine must be in park and neutral with a DPF level of 3 or higher to perform a Parked Regeneration.

! WARNING: If the Diesel Particulate Soot Level reaches **Regen Level 4** (red) due to inhibiting regeneration, the engine should be shutdown and a qualified engine or OEM service technician will be required to perform regeneration. This is noted on the display screen and in the example in section, Regeneration Message Levels.

CAUTION - Exhaust temperatures will be extremely high. Ensure exhaust will not come into contact with combustible materials.

Request Parked Regeneration:

1. Move the machine to a safe location.
2. Put the machine in park/disengage.
3. Return the engine to low idle speed.
4. Apply the parking brake.
5. Un-inhibit regeneration. If needed, display's factory default is set to un-inhibited.
6. The blue message will appear. Using the UP/DOWN soft keys, maneuver through the entire message and follow the instructional steps.
7. Press the Request Regen (Request Regen) soft key to start the Parked Regeneration.

During the regeneration, the engine speed will increase and there may be noticeable sound difference.

The following blue parked regeneration message screens will be displayed.

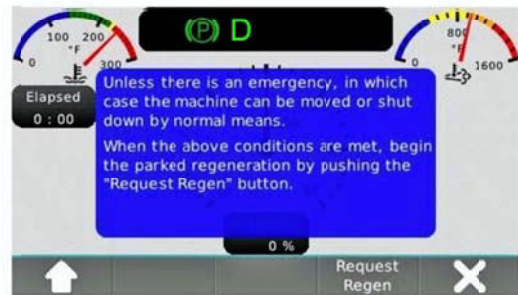
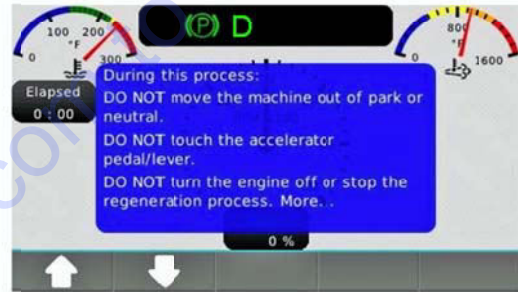



Figure 56 Three Blue Parked Regeneration Message Screens

CAUTION DO NOT attempt to operate the unit, change engine RPM or move from Park/Disengage while regeneration is occurring. This will abort the regeneration process and require you to start the process over.

Once the Parked Regeneration has started it can be shutdown by pressing the Stop Regen () soft key.

However, **DO NOT** shut down unless it is absolutely necessary.

 **CAUTION** - Continue to monitor surrounding areas during the process. If unsafe conditions develop, shut the unit off immediately.



Figure 57: Stop Regen Soft Key

Parked Regeneration is complete when the controller screen shows the following green pop-up message. Click on the () soft key to remove the pop-up message. The machine can return to normal usage.

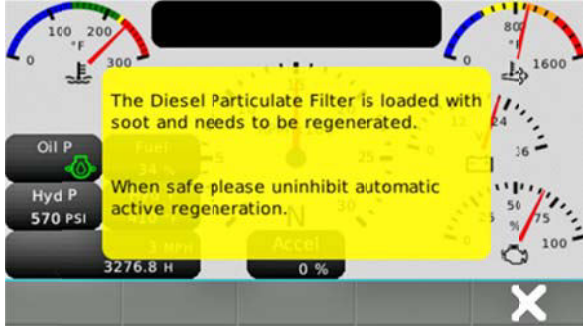

Figure 58: Parked Regeneration Complete Message Screen

Regeneration Message Levels

Please pay attention to all messages on the controller for the safety of personnel and to prevent engine and property damage if DPF regeneration is needed.

Regen Level 1 (Yellow)



Regen Level 3 (Red)

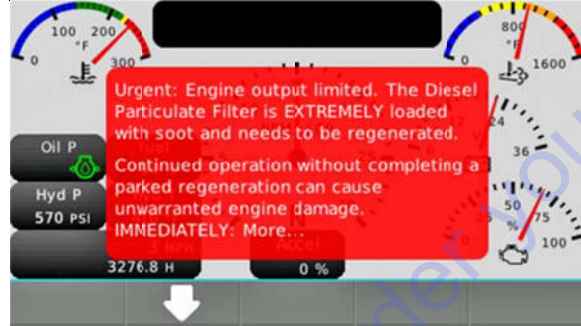

Regen Level 2 (Orange)

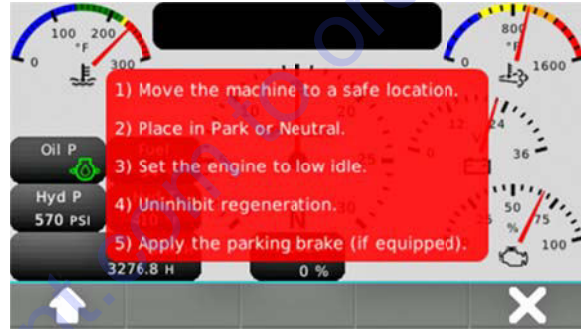
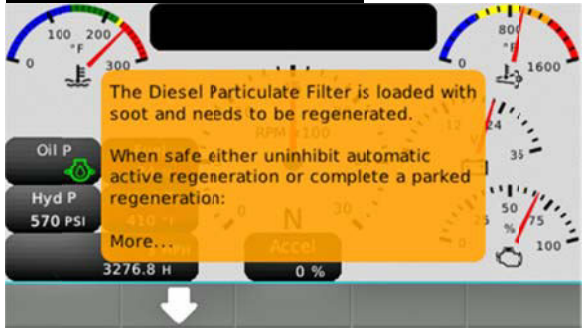

Regen Level 4 (Red)

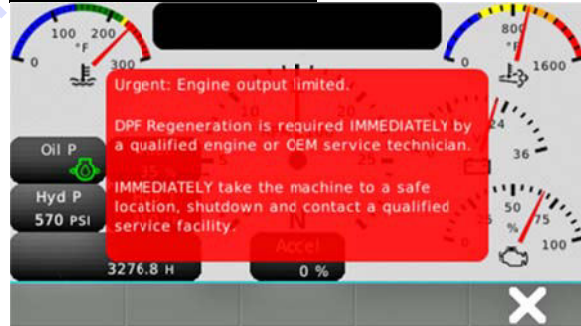

Regen Complete (Green)

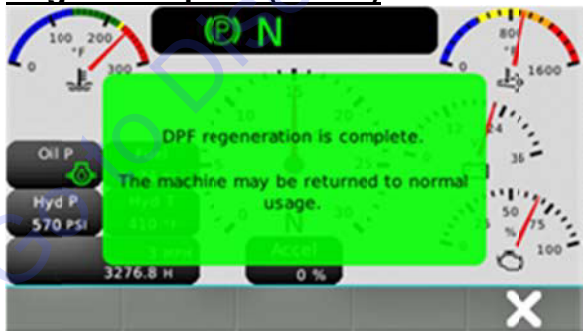

Regen Level 5 (Red)

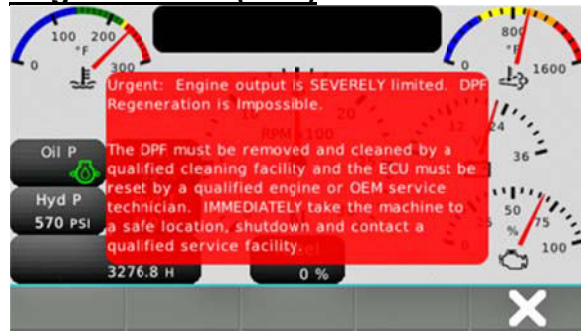

Engine

! WARNING

- DO NOT expose yourself or anyone else to the direct line of the blade when operating the saw.
- DO NOT leave the engine running unattended.
- Operate the saw in well-ventilated areas. Concentrated engine exhaust can cause loss of consciousness and/or death.
- Avoid excessive idling to prevent carbon/coking build up and DPF plugging.



Tasks Prior to Starting the Engine

Complete the tasks listed below prior to starting the engine:

- Fill fuel tank, check engine oil and coolant levels.
- Turn off water valves.
- Turn off water safety switch.
- Turn off water pump switch.
- Place speed control lever at *Neutral*.
- Disengage transmission.
- Pull up on emergency stop button and select the soft key under the X on the display panel.
- Remove all tools from work area.

Ignition Switch



Figure 59: Ignition Switch

- *Stop* - turns off the engine.
- *Run* - creates power, but does not start the engine.
- *Start* - turns on the engine. DO NOT engage for a long time to avoid overheating or damaging the starter. Note: If the engine does not catch or start at 10 seconds after key is turned to Start, wait for another 30 seconds and then begin again. DO NOT allow the starter motor to run continuously for more than 20 seconds. Refer to the engine manual if the engine does not start after two attempts.

Starting the Engine

! WARNING

DO NOT use any other starter substances or starter fluids when starting the engine using the glow plug (e.g., starter fluid sprayed into the air filter). These materials are extremely flammable and explosive, and can melt parts or possibly explode when used together to start the engine.



1. To start the engine insert the key into the ignition, turn the key to Run and wait until the main display screen is displayed.

Note: Wait to start, preheating Message: When the ambient temperature is below the threshold set within the ECU requiring a preheat condition, a message pop-up will appear on the screen warning the user to “Wait to start, preheating.” This message is sent over CAN from the engine to alert the operator not to start the engine. This message pop-up will disappear when the engine is preheated and is ready to start.

2. A sequence of screens will display on the control panel. First you will see a notation in the upper left corner, Booting..., next the Diamond Products logo displays and lastly

the gauge screen is displayed. Note: If a yellow warning window indicating the “Diesel Particulate Filter Active Regeneration Inhibited Due to: Inhibit Switch” is displayed, press the soft key under the X to close the window. This will only display if saw has had factory DPF setting of un-inhibit changed to inhibit.



Figure 60: Yellow Warning Window

- Then turn the key to *Start*, and release the key when the engine starts. *Note: If the engine does not catch or start at 10 seconds after key is turned to Start, wait for another 30 seconds and then begin again. DO NOT allow the starter motor to run continuously for more than 20 seconds. Refer to the engine manual if the engine does not start after two attempts.*

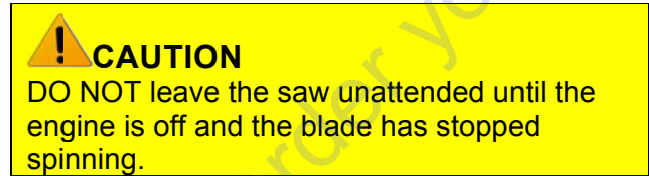

Figure 61: Display Screen

- Increase the engine to half throttle and let the engine warm up without load until the coolant temperature reaches over

- Increase the engine to full throttle. Adjust the throttle as necessary when cutting for maximum efficiency. **DO NOT** exceed the maximum recommended blade RPM when operating the saw. (Refer to the Blade Speed section in this manual for correct RPM.)

Stopping the Engine



- Place the speed control lever at *Neutral*.
- Raise the blade from the cut.
- Turn off the water pump switch if in use.
- Turn off the water safety switch.
- Turn off the water valve.
- Decrease the engine speed to idle for several minutes. For turbocharged engines, idle the engine for approximately 5 minutes.
- Turn the key to *Stop* and remove the key.

Concrete Cutting

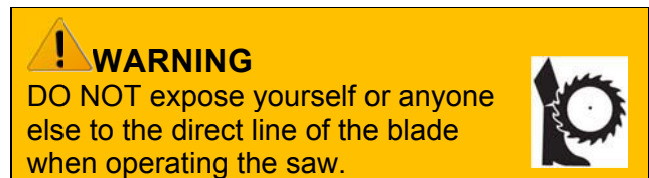

Helpful Hints Prior to Cutting

Keep the following things in mind for greater efficiency when cutting:
 Use just enough handle pressure to guide the saw on the cutting line. **DO NOT** forcibly direct (twist) the saw from side to side when cutting.
 Avoid sawing excessively deep to preserve the blade and reduce sawing costs.
 Moving too quickly when cutting may stall the saw, or may cause the blade to climb out from the cut. If the saw stalls at any time, move the speed control lever to *Neutral* and raise the blade from the cut to restart the engine.

DO NOT lower the blade too quickly or move the saw forward too quickly when finishing a partial-cut to avoid forcing the blade into the concrete.

Tasks Prior to Cutting

Complete the following tasks prior to cutting:

- ✓ Raise the blade to provide proper clearance between the blade and the ground when maneuvering the saw.
- ✓ Align the front pointer with the blade.
- ✓ Clearly mark the cutting line.
- ✓ The work area should not contain buried or embedded electrical, gas, or water lines.
- ✓ Turn off all electricity, gas, and water in and around the work area prior to cutting.

Making a Cut

1. Turn on the water valve.
2. Turn on the water safety switch feature, if available. Check the water pressure if the engine stops.
3. Turn on the water pump switch if necessary.
4. Align the blade and pointers with the cutting line.
5. Lower the blade to touch the cutting surface.
6. Move the cutting depth indicator to zero.



Figure 62: Cutting Depth Indicator

7. Plunge the blade into the concrete until the indicator displays the desired cutting depth. To maintain a particular depth when cutting, turn the depth stop knob clockwise until resistance is felt. The blade should not lower any further.
8. Push the speed control lever forward to reach the desired traveling speed for

maximum efficiency. Raise and lower the blade as necessary, paying attention to the cutting depth indicator. When using the depth stop, raise the blade from the cut to repeat the depth in another area as necessary.

Adjusting the Depth Stop

Turn the depth stop knob counterclockwise to increase the cutting depth, or turn the depth stop knob clockwise to decrease the cutting depth. The depth stop knob will stop turning when the saw has reached its maximum depth.



Figure 63: Depth Stop

Continuing a Partial-Cut

1. Maneuver the saw to the correct location.
2. Align the blade with the previous cut and plunge the blade back into the concrete. DO NOT move forward until the blade is properly aligned within the cut.
3. Push the speed control lever forward to reach the desired traveling speed for maximum efficiency.

Finishing a Cut

1. Place the speed control lever at *Neutral*.
2. Raise the blade from the cut (high enough for proper ground clearance).

Lighting

The spot light (optional item) illuminates the area for the operator as necessary.

Spot Light

A mounting bracket secures the spot light to the frame upright's right side.

- a. Loosen the lock knobs to adjust the light bar and retighten them to secure the light.

- b. Turn the spot light switch on and off as necessary.

Parking Brake

The parking brake stops the saw from moving forward or backward unintentionally, and is helpful on steeper slopes and hills. DO NOT assume at any time that the transmission will act as a brake when at *Neutral*.



Figure 64: Parking Brake

Engaging the Parking Brake

Slide the brake lever over and out of the *Disengage* slot and down and into the *Engage* slot. Engaging the parking brake will light up the green letter P on the display panel.

Disengaging the Parking Brake

Slide the brake lever over and out of the *Engage* slot and up and into the *Disengage* slot. Green letter P icon on the display panel will go out.

Maintaining the CC6571 and CC6571-3

Failure to read and comply with the maintenance instructions provided in this manual prior to performing maintenance may result in serious injuries and/or death, and may harm the saw. DO NOT attempt to perform maintenance on the saw if you are not properly trained for it, or are not supervised by an experienced person.

Refer to the CC6571 and CC6571-3 Parts' Lists for additional information and part diagrams when performing maintenance tasks. Refer to the engine manual and manufacturer as the primary source for all safety, operations, and maintenance instructions for the engine. Contact the saw and/or engine manufacturer with any additional questions.

Remove all necessary guards and access panels prior to servicing the saw. Replace prior to operating.

Maintenance Overview

Complete the following maintenance tasks as required. DO NOT delay maintenance! Print the Daily Maintenance Task Chart from Appendix B to keep track of maintenance tasks completed.

Daily and/or Regularly

- Inspect belts daily for tension and wear and replace and/or re-tension as necessary.
- Inspect saw for damages.
- Tighten loose nuts and bolts.
- Check fuel level and fill as necessary.
- Check engine oil level (15W-40 API CJ-4 ONLY) and fill as necessary.
- Check hydraulic oil level and fill as necessary.
- Check coolant level
- Remove slurry and debris from radiator.
- Remove slurry and debris from cooling fans.
- Look for fluid leaks.
- Re-tension rear drive chain as necessary.
- Check oil level in oil expansion tank and fill as necessary.
- Check air filter indicator.

50 Hours

- Change engine oil, only use 15W-40 API CJ-4 (or higher), after first 50 hours.
- Replace oil filter cartridge after first 50 hours.
- Drain of water separator

500 Hours

- Change engine oil, only use 15W-40 API CJ-4 (or higher).
- Replace oil filter cartridge.
- Replace in-line fuel filter.
- Replace fuel filter cartridge.
- Cleaning of water separator.
- Check battery, battery cables, and cable connectors and clean as necessary.
- Replace outer primary air filter.
- Replace inner safety filter.
- Change oil bath blade shaft oil.

Note: Refer to the engine/motor manual and manufacturer for a full maintenance schedule and additional maintenance information.

Handlebars

The handlebars generally require little or no maintenance and, when used correctly, should remain in good condition. Inspect the handlebars occasionally for bending, unusual cracks, and/or breakage. Replace them immediately when damaged.

Part Lubrication

 **WARNING**
DO NOT grease parts with the engine running unless stated otherwise.



Lubricating parts on schedule increases the saw's efficiency and life. Use NLGI No. 2 premium lithium-based grease when lubricating parts.

Front Axle

Lubricate the front axle grease fitting every 40 hours of operation. Lubricate both pillow block bearing grease fittings every 40 hours of operation.

Rear Axle

Lubricate both pillow block bearing grease fittings every 40 hours of operation.

PTO

Add three pumps of grease to PTO every 25 hours. Use high temperature, extreme pressure, Lithium based grease.

Inner Blade Flange



Figure 65: Inner Flange

Installing the Inner Blade Flange

1. Check the inner flange for damages and clean or replace as necessary.
2. Remove the setscrew from the back of the inner flange using an Allen wrench.
3. Place the inner flange onto the indented portion of the blade shaft.
4. Apply Loctite 262 (red) or an equivalent to the setscrew threads.
5. Place the setscrew into the inner flange setscrew hole and tighten it down to the blade shaft key to secure the inner flange.

Removing the Inner Blade Flange

1. Remove the setscrew from the back of the inner flange using an Allen wrench.
2. Remove the inner flange from the blade shaft.
3. Check the inner flange for damages and clean or replace as necessary.
4. Place the setscrew into the inner flange setscrew hole and tighten to secure.

Rear Wheels

Inspect the rear wheels regularly for damages or wear and replace as necessary.

1. Unscrew the trantorque bushing and remove one of the rear wheels.

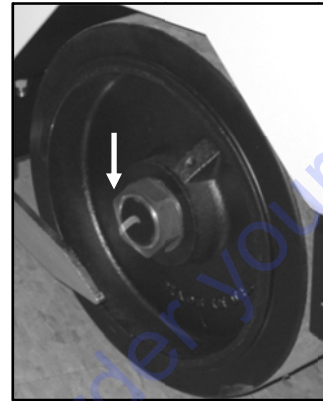

Figure 66: Trantorque Bushing

2. Place the new wheel onto the rear axle.
3. Place the trantorque bushing into the wheel hole and tighten the bushing to 175 ft-lb (237 Nm). *Note: Failure to properly tighten the bushing may cause the wheel to fall off the saw.*
4. Repeat steps 1–3 to replace the second wheel.

Battery

! WARNING

Ignitable explosive gases are emitted from the battery. DO NOT expose the battery to sparks or open flames, and keep the area around the battery well-ventilated. Disconnect the battery when performing maintenance.



! CAUTION

Use a proper battery tester, such as a voltmeter, to test the battery strength. Use protective eyewear or a face shield, and avoid contact with the skin when handling a battery.

Battery Type

12 Volt, Group 24

Servicing the Battery

1. Remove the battery brace lock nuts and battery brace.



Figure 67: Battery and Brace

2. Remove the negative battery boot and disconnect the negative battery cable lead from the negative battery terminal.
3. Remove the positive battery boot and disconnect the positive battery cable lead from the positive battery terminal.
4. Slide the battery off the battery platform, keeping it level.
5. When replacing the battery, place a new battery onto the battery platform, keeping it level. Bring the old battery to a recycling facility; many battery retailers also accept old batteries.
6. When cleaning the battery, inspect its terminals, clamps, and cables for damages and corrosion. Clean the terminals and clamps using a wire brush, or use another approved technique for cleaning. Use acid-free, acid-resistant grease to grease the battery clamps and terminals.
7. Reconnect the positive battery cable lead to the positive battery terminal and replace the battery boot.
8. Reconnect the negative battery cable lead to the negative battery terminal and replace the battery boot.
9. Fit the battery support brace over the battery and retighten the nuts to secure the brace.

Electrical System

! WARNING
DO NOT perform maintenance on the electrical system without first disconnecting the battery. Always use the correct size fuses (amps) to prevent fires.



Fuse Panel

The fuse panel is located behind the instrument panel. Replace fuses as necessary.



Figure 68: Fuse Panel

Relays and Circuit Breakers

The relay switches and circuit breaker are located behind the switch plate. The circuit breaker should reset itself during an overload. If the breaker continually turns on and off, disconnect the battery to determine the cause of the overload.



Figure 69: Circuit Breaker and Relays

Magnetic Sensor

The magnetic sensor transfers the blade RPM to the blade tachometer/hour meter. If the blade tachometer/hour meter remains at zero when operating the saw, the magnetic sensor needs to be adjusted or replaced.



Figure 70 Single Speed Magnetic Sensor

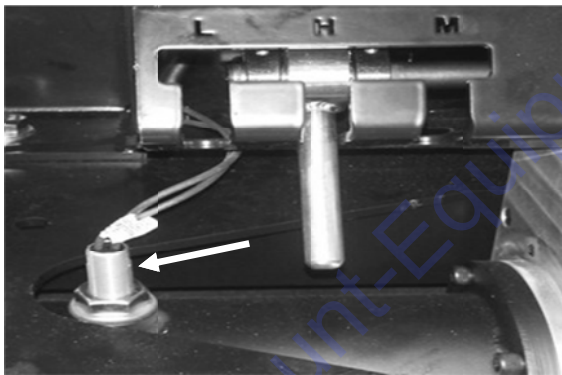

Figure 71 Three Speed Magnetic Sensor

Adjusting the Magnetic Sensor

1. Loosen the jam nut on the magnetic sensor.
2. Turn the magnetic sensor clockwise to screw the sensor in until it lightly touches the tachometer gear mounted on blade shaft.
3. Turn the sensor counterclockwise 1/8th of a turn.
4. Retighten the jam nut down to the frame base to secure the sensor.

Replacing the Magnetic Sensor

1. Disconnect the battery.
2. Disconnect the magnetic sensor's two-wire connector.
3. Loosen the jam nut on the magnetic sensor, and turn the sensor counterclockwise to remove the sensor.
4. Loosen the jam nut on the new magnetic sensor so it sits near the upper part of the sensor.
5. Place the sensor into the magnetic sensor hole on the frame base.
6. Turn the magnetic sensor clockwise to screw the sensor in until it lightly touches the tachometer gear mounted on blade shaft.
7. Turn the sensor counterclockwise exactly 1/8th of a turn.
8. Screw the jam nut down to the frame base to secure the sensor.
9. Connect the new magnetic sensor's two-wire connector.
10. Reconnect the battery.

Air Cleaner

Refer to the engine manual as the primary source for information on the air cleaner.

1. Clean the evacuator valve daily when used in a dusty place. This will get rid of large particles of dust and dirt.
2. Wipe the inside air cleaner clean with cloth if it is dirty or wet.
3. Avoid touching the primary element except when cleaning.
4. When dry dust adheres to the element, blow compressed air from the inside turning the element. Pressure of compressed air must be under 205kPa (2.1kgf/cm², 30psi).
5. Replace the primary element every year or every 6 cleanings. If stained heavily, replace sooner. Replace secondary element when you replace the primary.
6. The secondary element should be removed only if it is to be replaced.
7. To protect the engine, do not remove the secondary element in servicing the primary element.

Restriction Indicator



Figure 72: Restriction Indicator

1. Service the air cleaner when the restriction indicator turns red.
2. Press the restriction indicator reset button on the top of the indicator to reset the unit after the air cleaner has been serviced.

Rubber Dust Ejector Boot

The rubber dust ejector boot valve ejects debris and water when operating the saw. Occasionally inspect and clean the ejector boot.

Press inward on both sides of the ejector boot near the valve opening to release debris and water, and clean the valve opening as necessary.



Figure 73: Rubber Dust Ejector Boot

Cleaning/Replacing the Outer Primary Filter

Service the outer primary filter according to the restriction indicator service bar. Replace the filter annually. DO NOT over-service or under-service

the filter. DO NOT operate the saw without the filter installed.

1. Pull out the tab on the air cleaner's end cover.



Figure 74: End Cover Tab

2. Turn the end cover clockwise to unlock the cover and pull the end cover away from the air cleaner.
3. Pull the outer primary filter out of the air cleaner and inspect it for damages. Replace as necessary.
4. Move away from the saw and clean the filter from the inside out. Use dry compressed air to clean the filter (a maximum of 70 psi or 5 bar), or lightly tap or wash the filter out. Let the filter dry completely after washing. DO NOT damage the filter when cleaning.
5. Inspect the inside of the air cleaner and the end cover for debris, and wipe them down with a damp cloth as necessary. DO NOT use compressed air to blow out the inside of the air cleaner. DO NOT allow dust to enter the air intake tube when cleaning or replacing parts.
6. Place the filter into the air cleaner (over the inner safety filter) and gently push the filter into the unit until it feels secure.

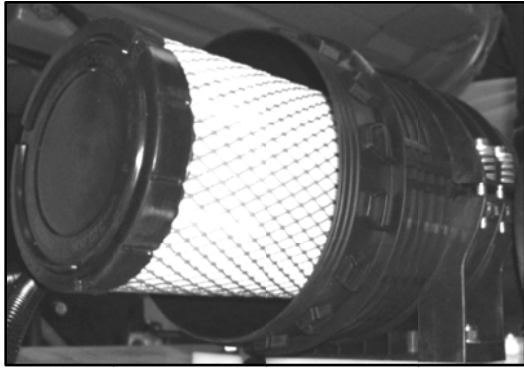

Figure 75: Outer Primary Filter

7. Place the end cover tightly up against the ridge at the end of the air cleaner.
8. Turn the end cover counterclockwise to lock the cover onto the air cleaner.
9. Push the tab in on the air cleaner's end cover to secure.

Replacing the Inner Safety Filter

DO NOT clean the inner safety filter. Replace it after five service cleanings, or approximately one year, or if there are damages. DO NOT operate the saw without the filter installed.

1. Pull the tab out on the air cleaner's end cover.
2. Turn the end cover clockwise to unlock the cover and pull the end cover away from the air cleaner.
3. Pull the outer primary filter and the inner safety filter out of the air cleaner. Inspect the outer primary filter for damages and replace as necessary.
4. Inspect the inside of the air cleaner and the end cover for debris, and wipe them down with a damp cloth as necessary. DO NOT use compressed air to blow out the inside of the air cleaner. DO NOT allow dust to enter the air intake tube when cleaning or replacing parts.
5. Insert a new inner safety filter into the air cleaner and gently push the filter into the unit until it feels secure.

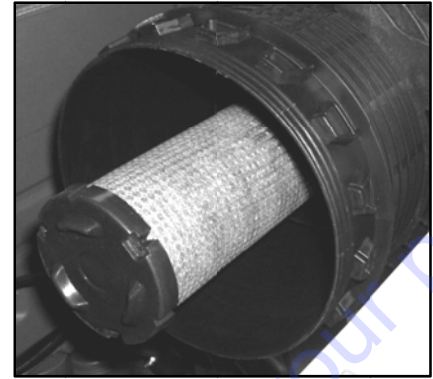

Figure 76: Inner Safety Filter

6. Place the outer primary filter into the air cleaner (over the inner safety filter) and gently push the filter into the unit until it feels secure.
7. Place the end cover tightly up against the ridge at the end of the air cleaner.
8. Turn the end cover counterclockwise to lock the cover onto the air cleaner.
9. Push the tab in on the air cleaner's end cover to secure.

Speed Control Lever

When the speed control lever is out of sync with the saw's movement; for example, if the saw moves forward when the lever is at *Neutral* adjustments are needed.

Adjusting the Speed Control Lever

1. Identify the linkage assembly connected to the speed control lever.
2. Adjust the threaded nuts on the threaded linkage assembly shaft.

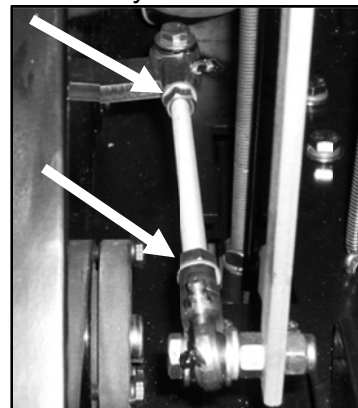

Figure 77: Linkage Assembly Nuts

3. Remove tools from the area. Start the engine to check the speed control lever for accuracy.
4. Turn the engine off and readjust the threaded nuts as necessary.
5. Adjust the cap screw at the speed control lever's pivot point to change the amount of friction felt when moving the speed control lever.

Drive Alignment

Adjust the rear drive, as necessary, when the saw leads more to one side when cutting.

Adjusting the Rear Drive

1. Turn the engine off and let the saw cool down.
2. Loosen the two left rear axle pillow block bearing bolts. DO NOT remove them.

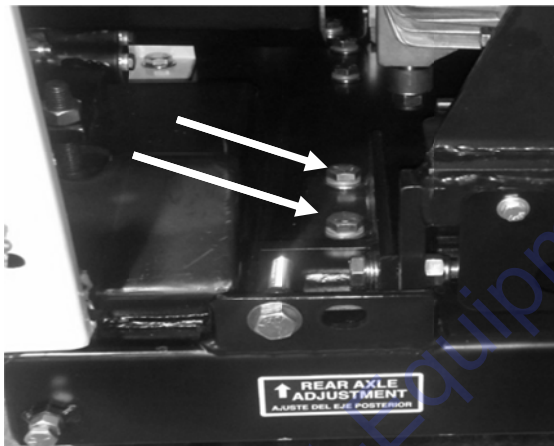

Figure 78: Rear Axle Pillow Block Bearing Bolts

3. Turn the rear axle adjustment bolt on the back of the frame base counterclockwise if the saw leads more toward the right, or clockwise if the saw leads more toward the left. DO NOT force adjustments.



Figure 79: Rear Axle Adjustment Bolt

4. Retighten the pillow block bearing bolts to secure the alignment and readjust as necessary.

Oil Bath Blade Shaft /Oil Expansion Tank

The oil expansion tank supplies oil to the oil bath blade shaft. Add oil up to the full cold line on the expansion tank as necessary. Change the oil bath blade shaft oil annually (500 hours).

Changing the Oil - Single Speed

1. Lower the saw to the floor so it is level.
2. Place an oil tray underneath the blade shaft's magnetic oil drain plug.
3. Remove the oil drain plug to drain the oil.
4. Replace the plug when the oil is drained.
5. Remove the casing vent line by unscrewing the 3/8" pipe fitting on the top of the casing.
6. Add an automatic transmission fluid (ATF) or an equivalent into the housing until full.
7. Replace the casing vent line.

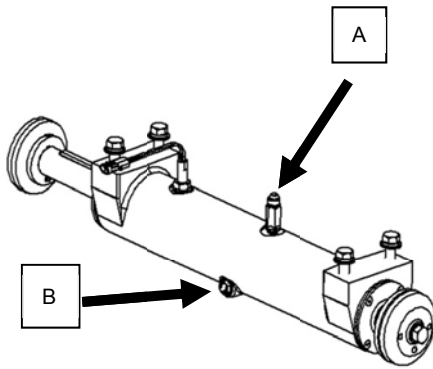

Figure 80 Single Speed Blade Shaft Assembly
 A – Casing vent line
 B – Oil drain plug

8. Add automatic transmission fluid into the expansion tank up to the Full Cold line.



Figure 81 Expansion Tank Cold Line

9. Discard the used transmission fluid according to city, state, and federal regulations.

Changing Oil - Three Speed

1. Raise saw to maximum angle for better drainage.
2. Place an oil pan beneath the 3-speed transmission casing.
3. Using a 3/8" hex key wrench, remove the 1/2" casing drain plug located on the lower right rear of the 3-speed casing.

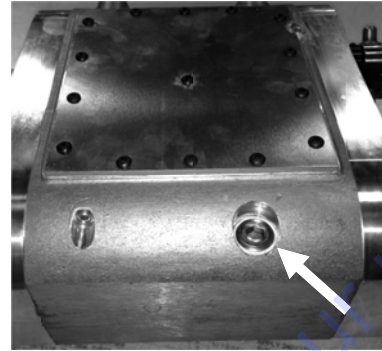

Figure 82: 1/2" Casing Drain Plug

4. Remove the 3/8" overflow pipe plug from the right hand side cover of the transmission.



Figure 83: 3/8" Overflow Pipe Plug

5. Flush the casing by pouring SAE 75W-90 synthetic gear oil or equivalent in the top of the expansion tank until clean oil is discharged through the casing drain plug.



Figure 84: Expansion Tank

6. Replace the 1/2" casing drain plug.

7. Continue filling the expansion tank with the SAE 75W-90 synthetic gear oil or equivalent up to the level of the overflow pipe plug.
8. Replace the overflow plug.
9. Remove oil pan from beneath the saw.
10. Lower saw to horizontal position
11. Expansion Tank should not have oil in reservoir.
12. Discard the used transmission fluid according to city, state, and federal regulations.

Draining Heat Exchanger – Freezing Temps

To avoid water freezing in heat exchanger and potentially causing housing cracks it is necessary to drain the Heat Exchanger when not in use for extended periods in freezing ambient temperatures.

1. Shut off the water source to the transmission.
2. Ensure proper drainage of water from transmission prior to proceeding.
3. Using a 3/16" hex key wrench, remove both 1/8" NPT plugs located on the bottom of the 3-speed casing.
4. Replace the 1/8" NPT plugs once the water has been drained out.

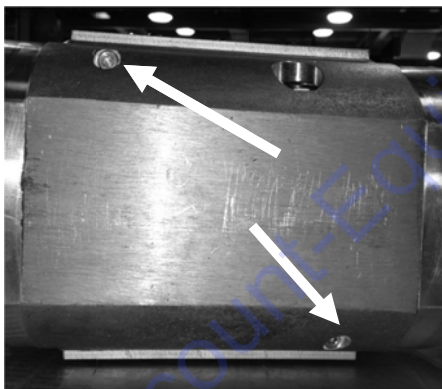

Figure 85 Drainage Plugs

Hydraulic System

! WARNING

Turn the engine off prior to performing maintenance on the hydraulic system. Lower the saw to the floor so it is level to release the pressurized hydraulic fluid in the hydraulic system prior to performing maintenance on the hydraulic system.

Always place a piece of cardboard or paper up against hydraulic components, or use a leak detection fluid to check for hydraulic fluid leaks. Keep all body parts away from leaks and/or areas that may eject hydraulic fluid. Pressurized hydraulic fluid can penetrate the skin, causing serious injuries. Seek medical attention immediately!



Adding Hydraulic Fluid

Check the hydraulic fluid level regularly and add fluid as necessary.

1. Remove the hydraulic pump cover plate.
2. Lower the saw to the ground so it is level (to provide an accurate fluid reading).
3. Remove the breather cap on the top of the hydraulic pump unit.



Figure 86: Breather Cap

4. Add ATF as necessary. *Note: Filling the oil up to the opening of the pipe will cause fluid to leak from the cap when lowering the saw. Fill the oil to just below where the pipe*

begins to extend out from the hydraulic pump unit to prevent spills.

Rear Drive Transmission

Cooling Fan

Remove the fan guard and wipe down or use compressed air to clean debris and slurry from the transmission cooling fan. The transmission oil will not properly cool if the fan is clogged with concrete dust and debris.

Adding Oil

The hydraulic pump unit supplies oil to the transmission. Check the oil level daily and/or regularly and add ATF, according to the instructions in the section, as necessary.

Adjusting the Rear Drive Chain

Regularly inspect the rear drive chain and tighten as necessary. Regularly lubricate the rear drive chain with oil to increase chain life.

1. Remove the chain guard.
2. Loosen the four transmission lock nuts securing the transmission to the transmission platform.
3. Loosen the setscrew hex nut at the midpoint of the transmission platform.

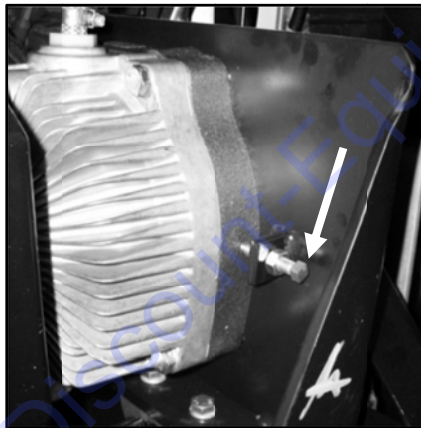

Figure 87: Transmission Setscrew

4. Turn the setscrew clockwise to push the transmission forward in the platform slots. Leave a little bit of slack in the chain, and DO NOT over-tighten it.
5. Retighten the hex nut to secure the transmission setscrew.

6. Retighten the transmission lock nuts to secure the transmission to the transmission platform.
7. Replace the chain guard and secure.

Belt System

! WARNING

Turn the engine off prior to performing belt maintenance.



! CAUTION

Always let the belts cool down prior to performing belt maintenance.

Blade Drive Belts

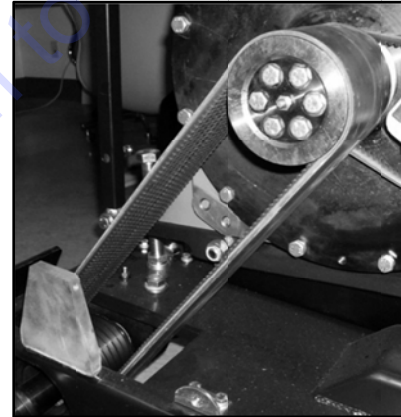

Figure 88: Blade Drive Belts

Belt Tension Setting

Refer to the manufacturer's belt tensioning. DO NOT exceed the manufacturer's tension setting. *Note: Over-tensioning the belts may damage the power take-off (PTO). Under-tensioning the belts may cause shorter belt life and/or poor saw performance. Squealing belts indicate looseness.*

Testing the Belt Tension

Test the blade drive belt tension on a daily basis using the method listed below. Touch the sonic tension meter sensor (can be ordered through Diamond Products) to the midpoint of the longest belt section and strum the belt. Adjust the belt tension as necessary.

Adjusting the Blade Drive Belts

Single Speed

1. Inspect the belts for fraying, stress cracks, and/or breakage and replace immediately if there are damages.
2. Test the belt tension. Proceed to step 3 if the belts need tensioning. Operate the saw as needed if no tension adjustments are required.
3. Locate the engine guide on the right side of the saw. Loosen both hex head cap screws.

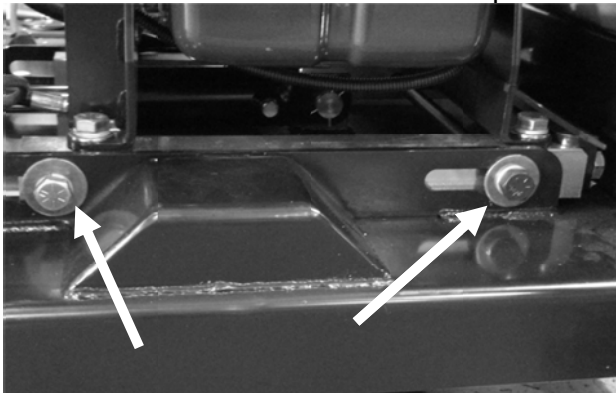

Figure 89: Engine Guide Cap Screws

4. Locate the belt tensioner lead screw on the front of the saw frame.

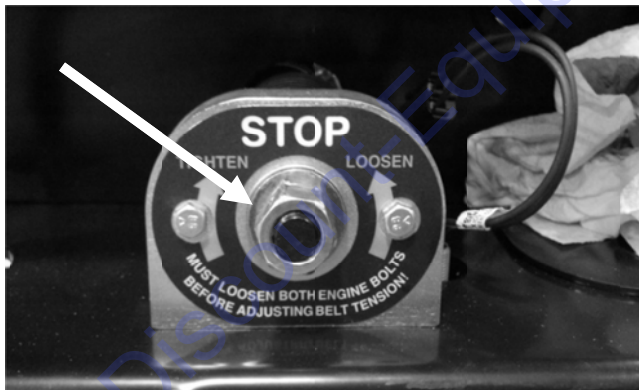

Figure 90: Belt Tensioner Lead Screw

5. Adjust the tension lead screw. Turn the bolt clockwise to tighten the belts, counter clockwise to loosen. Test the belt tension and readjust the tension bolt as necessary. DO NOT exceed the manufacturer's belt tension setting.

6. Once the blade drive belts are tightened properly, retighten the cap screws located on the right side of the saw on the engine guide.

Three Speed

1. Inspect the belts for fraying, stress cracks, and/or breakage and replace immediately if there are damages.
2. Test the belt tension. Proceed to step 3 if the belts need tensioning. Operate the saw as needed if no tension adjustments are required.
3. Locate the belt guard on the left side of the saw. Loosen and remove the seven hex head cap screw and bolts located on the side and front of saw. Remove belt guard.

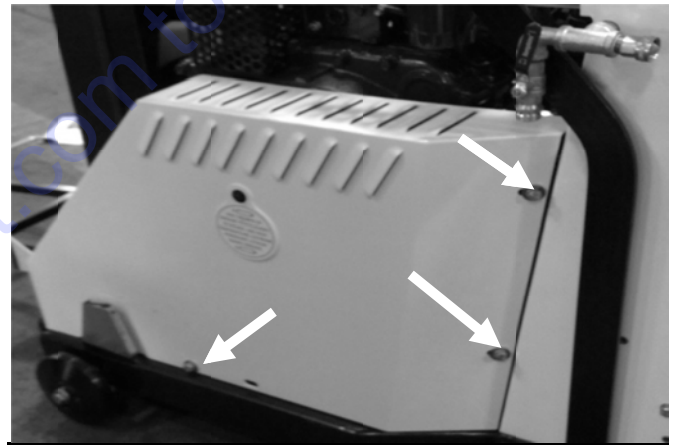

Figure 91: Belt Guard Bolts – Side (3)

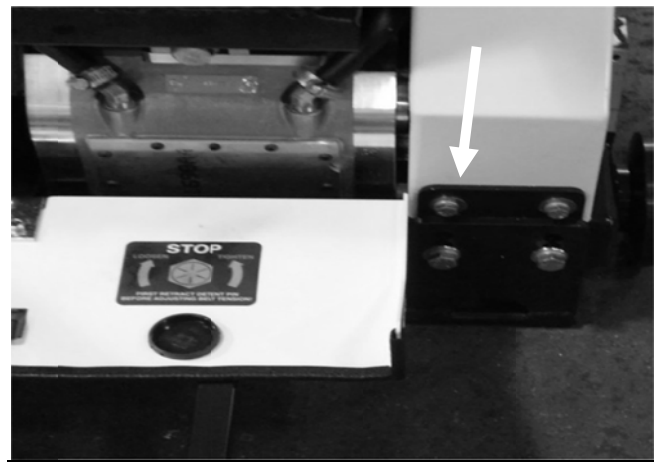

Figure 92: Belt Guard Bolts – Front (4)

4. Locate detent pin in front of the saw. Retract pin by pulling outward and turning 90° to lock open.

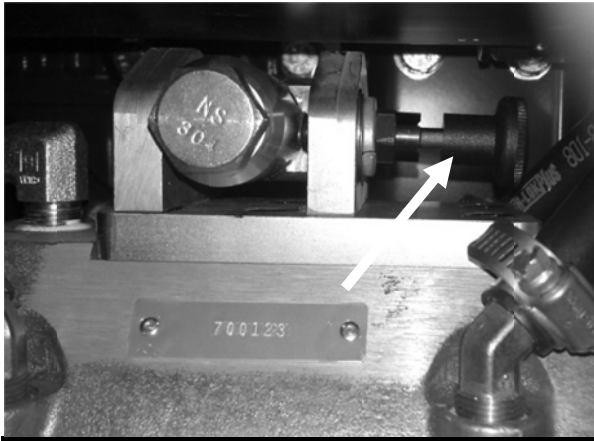

Figure 93: Detent Pin

5. Locate the belt tensioner lead screw on the front of the saw frame. To loosen the belts turn the lead screw clockwise. This will allow the gear box to tilt back. To tighten the belts turn the lead screw counter clockwise. Test the belt tension and readjust the tension bolt as necessary. DO NOT exceed the manufacturer's belt tension setting.

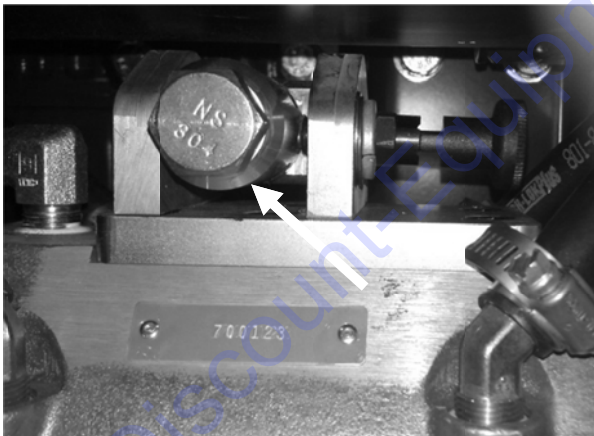

Figure 94: Belt Tensioner Lead Screw

6. Once the blade drive belts are tightened properly, lock the detent pin. Turn detent pin until it snaps back into place.
7. Replace belt guard and retighten the seven hex head cap screw and bolts.

Replacing the Blade Drive Belts

Single Speed

1. Locate the belt guard on the left side of the saw. Loosen and remove the seven hex head cap screw and bolts located on the side and rear of saw. Remove belt guard.
2. Locate the engine guide on the right side of the saw. Loosen the hex head cap screws.
3. Locate the belt tensioner lead screw on the front of the saw frame.
4. Turning the lead screw counter clockwise will loosen the tension on the belts.
5. Remove the belts from the PTO sheave and from the blade shaft sheave.
6. Loop and align the new belts (one at a time) around the grooves on the blade shaft sheave, and then pull them upward and loop and align them around the grooves near the end of the PTO sheave.
7. Adjust the lead screw by turning the bolt clockwise to tighten the belts. Test the belt tension and readjust the lead screw as necessary. DO NOT exceed the manufacturer's belt tension setting.
8. Once the blade drive belts are tightened properly, retighten the cap screws located on the right side of the saw on the engine guide.

Three Speed

1. Locate the belt guard on the left side of the saw. Loosen and remove the seven hex head cap screw and bolts located on the side and front of saw. Remove guard.
2. Locate detent pin in front of the saw. Retract pin by pulling outward and turning to lock open.
3. Locate the belt tensioner lead screw on the front of the saw frame. To loosen the belts turn the lead screw clockwise. This will allow the gear box to tilt back releasing belt tension for ease in removing and replacing belts. To tighten the belts turn the lead screw counter clockwise. Test the belt tension and readjust the tension bolt as necessary. DO NOT exceed the manufacturer's belt tension setting.

4. Once the blade drive belts are tightened properly, lock the detent pin. Turn detent pin until it snaps back into place.
5. Replace belt guard and retighten the seven hex head cap screw and bolts.

Primary Transmission V-Belt

Inspect the V-belt regularly for fraying, stress cracks, and/or breakage and replace immediately if there are damages.

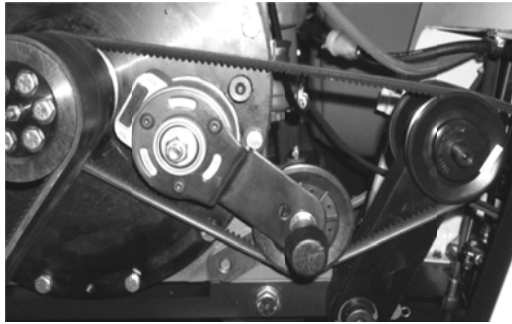

Figure 95: Primary Transmission V-Belt

Replacing the Primary Transmission V-Belt

1. Remove the blade drive belts from the PTO sheave.
2. Pull the rotary tensioner knob up and hold it in place to create slack in the V-belt.
3. Remove the V-belt from the rotary tensioner idler pulley, the front transmission jackshaft pulley, and the PTO sheave.
4. Release the rotary tensioner knob.
5. Pull the rotary tensioner knob up and loop the new V-belt around the individual groove at the back of the PTO sheave.
6. Loop the upper V-belt section around the front transmission jackshaft pulley, and loop the lower V-belt section under the rotary tensioner idler pulley.
7. Release the rotary tensioner knob to tension the V-belt.
8. Retighten the blade drive belts.

Secondary Transmission V-Belt

Inspect the V-belt regularly for fraying, stress cracks, and/or breakage and replace immediately if there are damages.

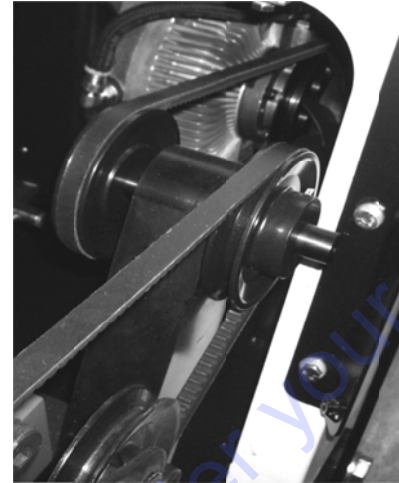

Figure 96: Secondary Transmission V-Belt

Replacing the Secondary Transmission V-Belt

1. Remove the transmission fan guard.
2. Pull the rotary tensioner knob up and hold it in place to create slack in the V-belt.
3. Remove the V-belt from the rear transmission jackshaft pulley and release the tensioner knob.
4. Remove the V-belt from the transmission pulley.
5. Loop and align the new V-belt around the transmission pulley, and then pull the belt forward toward the transmission jackshaft.
6. Pull the rotary tensioner knob up and hold it in place. Loop and align the V-belt around the rear transmission jackshaft pulley.
7. Release the rotary tensioner knob to tension the secondary transmission V-belt.
8. Replace the transmission fan guard.

Engine V-Belt

Refer to the engine manual for maintenance information on the engine V-belt.

Rotary Tensioner

Adjusting the Rotary Tensioner

1. Remove Belt Guard
2. Engage the transmission.
3. Pull the rotary tensioner knob up, remove the belt from the rotary tensioner idler pulley, and release the knob. The tensioner arm should hang down in the 6:00 position.
4. Turn the rotary tensioner knob counterclockwise until a light spring pressure is felt. Using a marker, draw a line

across the tensioner housing and base. This is the zero-reference line.

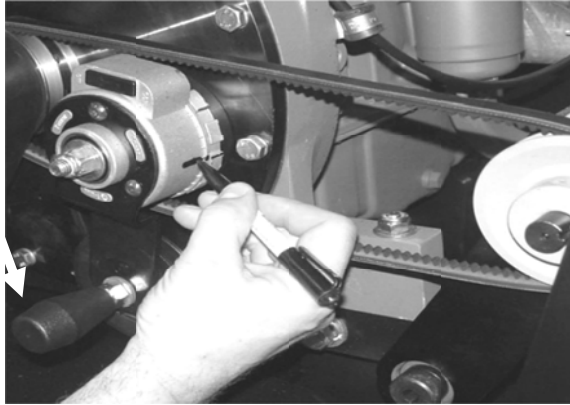

Figure 97: Zero-Reference Line

5. The tensioner base is made up of lugs and notches. The lugs equal 20° of rotation and represent the raised sections on the base. The notches equal 10° of rotation and represent the lowered sections on the base. Draw a new line on the tensioner base only, 40° from the zero-reference line in a counterclockwise direction.
6. Pull the rotary tensioner knob up, place the belt around the rotary tensioner idler pulley, and release the knob. The zero-reference line on the tensioner housing should line up with the 40° line on the tensioner base.
7. If the lines match up, skip to step 11. If the lines DO NOT match up, determine the direction of rotation (clockwise if the 40° line is to the left of the zero-reference line, and counterclockwise if the 40° line is to the right of the zero-reference line), and estimate the number of degrees the rotary tensioner should move for proper alignment.
8. Pull the rotary tensioner knob up and remove the belt from the rotary tensioner idler pulley.
9. Holding the rotary tensioner together, slightly loosen the rotary tensioner lock nut and rotate the tensioner in the direction and the exact number of degrees determined from step 7.
10. Retighten the lock nut and repeat step 6. Repeat steps 7–9 to readjust the tensioner as necessary.

11. Check all screws for tightness before operating the saw.
12. Replace the belt guard.

Replacing the Rotary Tensioner

1. Remove the rotary tensioner flat washer and lock nut.
2. Pull the rotary tensioner away from the rotary tensioner spacer and off of the hex head cap screw.
3. Remove the rotary tensioner spacer from the hex head cap screw.
4. Remove the hex head cap screw from the back of the inner ring support, which is a part of the PTO assembly. Dispose of the old rotary tensioner and parts properly.
5. Place the new hex head cap screw through the $\frac{3}{4}$ " hole on the backside of the inner ring support. Rotate the cap screw to properly fit the head of the screw below the inner ring support's surface.
6. Place the rotary tensioner spacer onto the hex head cap screw on the front side of the inner ring support.
7. Place the rotary tensioner onto the hex head cap screw and push it up against the rotary tensioner spacer.
8. Rotate the rotary tensioner so the tensioner arm hangs down in the 6:00 position.
9. Place the flat washer and then the lock nut onto the rotary tensioner, and tighten the nut to secure the unit.

Engine



WARNING

Let the engine cool down prior to performing maintenance.



Always refer to the engine operator's manual as the primary source for information on the engine, including maintenance and servicing!

Engine Cooling System

Inspect and clean the engine cooling system regularly depending on the level of concrete dust and debris at work sites. Failure to clean and monitor the engine cooling system will result in higher operating temperatures.

Radiator



Figure 1: Radiator

1. **Check level of coolant before every operation.** Coolant will last for one day's work if filled all the way up before operation start.
2. Check for any dust and dirt between radiator fins and tube, wash away with running water.
3. Refer to your engine manual for radiator maintenance.

Cooling Fan



Figure 2: Cooling Fan

1. Blow compressed air around the fan to remove slurry and debris.
2. Ensure fan is clear of debris and able to rotate freely.

In-Line Fuel Filter

Replace the in-line fuel filter every 250 to 500 hours depending on the amount of sediment in the filter.

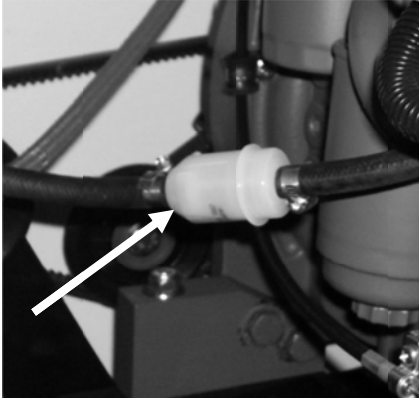

Figure 100 In-Line Fuel Filter

Replacing the In-Line Fuel Filter

1. Turn off the engine.
2. Lower the saw so the engine is level.
3. Place a drainage tray below the fuel hoses and in-line fuel filter.
4. Remove the clamps, one on each side of the in-line fuel filter, from the hoses. Excess fuel may release from the hoses.
5. Point the arrow on the new filter toward the engine and place the rear hose onto the rear end of the filter. Push the hose tightly up against the edge of the filter.
6. Place one hose clamp next to the filter (on the rear hose) and tighten the clamp to secure the hose and filter.
7. Place the front hose onto the front end of the filter. Push the hose tightly up against the edge of the filter.
8. Place one hose clamp next to the filter (on the front hose) and tighten the clamp to secure the hose and filter.
9. Dispose of the used fuel and filter according to city, state, and federal regulations.

Oil and Fuel Lines

Regularly check the oil and fuel lines for damages and/or leaks and service as necessary. Refer to engine operator's manual.

Storing

Complete the tasks listed below prior to storing the saw for longer time frames:

- Lower the saw completely to remove strain on the lifting mechanism.
- Turn off all switches and controls.
- Remove the battery from the saw and store it in a proper location, out of reach for children.
- Drain the fuel tank and fuel lines.
- Disconnect the water supply hose, open both water valves, and blow compressed air through the horizontal hose fitting on the left water valve to drain water from the saw.
- Use a wire brush to clean the blade guard water tubes and rinse them out with a hose.
- Refer to the engine manual for information on proper engine care when storing the saw.
- Clean the saw and store it in a dry area, out of reach from children.

Disposal

Properly dispose of the saw when it's no longer repairable, and/or contains safety hazards not worth repairing and/or maintaining. Complete the tasks listed below to properly dispose of the saw when discontinuing usage:

- Drain all fluids from the saw and dispose according to city, state, and federal regulations.
- Remove the battery from the saw and bring it to a recycling facility. Many battery retailers accept old batteries as well.
- Secure the saw in a truck/trailer and transport it to a salvage yard for appropriate disposal.

References

Appendix A

Model and Serial Numbers

Record the saw's serial number below for future reference and customer service purposes.

Serial Number	
---------------	--

Record the engine's model and serial numbers below for future reference and customer service purposes.

Model Number	
Serial Number	

Go to Discount-Equipment.com to order your parts

Appendix B

Daily Maintenance Task Chart

Table 3: Daily Maintenance Task Chart							
Date							
1.	Inspect belts daily for tension and wear and replace and/or re-tension as necessary.						
2.	Inspect saw for damages.						
3.	Tighten loose nuts and bolts.						
4.	Check fuel level and fill as necessary.						
5.	Check engine oil level and fill as necessary.						
6.	Check hydraulic oil level and fill as necessary.						
7.	Remove slurry and debris from cooling fans.						
8.	Remove slurry and debris from radiator.						
9.	Look for fluid leaks.						
10.	Re-tension rear drive chain as necessary.						
11.	Check oil level in oil expansion tank and fill as necessary.						
12.	Check radiator coolant level and fill as necessary.						
13.	Check air filter indicator.						

Appendix C

Troubleshooting

Table 4: Troubleshooting		
Symptom	Problem	Solution
a. Engine will not start.	Emergency stop button activated?	Pull up on emergency stop button.
	Optional water safety switch <i>On</i> ?	Set water safety switch to <i>Off</i> .
	Out of fuel?	Check for fuel in tank.
	Fuel filter or fuel lines clogged?	Replace fuel filter or fuel lines.
	Air in fuel lines?	Bleed fuel lines.
	Weak or worn-out battery?	Test, charge, or replace battery.
	Faulty battery connection?	Inspect, clean, and tighten battery cables.
	Main circuit breaker tripped?	Check wiring for short.
	Cold weather conditions?	Pre-heat engine with glow plug.
	Engine malfunction?	Refer to engine manual.
b. Saw will not raise.	Defective solenoid start switch?	Check and replace solenoid on hydraulic pump unit.
	Worn-out battery?	Test, charge, or replace battery.
	Defective raise button?	Check and replace raise button.
c. Saw will not lower.	Debris in lowering valve stem?	Remove, inspect, and clean valve stem.
	Defective valve coil?	Check for magnetism of valve stem when activated.
	Defective lowering button?	Check and replace lowering button.
d. Saw lowers too slow/too fast.	Improper lowering speed setting?	Adjust flow control valve knob on hydraulic pump unit.
e. Saw will not completely lower.	Depth stop set?	Turn depth stop knob counterclockwise until it stops.
	Skid plates in wrong set of holes?	Use bottom set of holes with 4-1/2" blade flanges.
	Front axle maximum cutting depth set wrong?	Adjust front axle maximum depth stop bolt.

Table 5: Troubleshooting (cont.)

Symptom	Problem	Solution
f. Blade does not cut straight.	Misaligned rear axle?	Adjust rear axle alignment.
	Excessive force applied while sawing?	Reduce forward speed.
	Wrong blade for application?	Contact Discount-equipment.
g. Short belt life.	Loose belts causing slippage?	Check belt tension on a regular basis.
	Sheaves misaligned?	Use straightedge to check blade shaft sheave alignment.
	Worn sheave grooves?	Check for groove wear and replace as needed.
	Belts contacting pavement?	Inspect and replace worn front skid plates.
	Belts contacting pavement?	Adjust front axle maximum depth stop bolt for belt clearance.
	Mismatched belt set?	Replace with new set of matched belts. DO NOT mix old and new belts.
	Overheating of PTO?	Check belt tension. Lubricate PTO every 25 hours.

Appendix D

Additional Resources

1. Discount-equipment (**www.discount-equipment.com**)
 - *CC6571 Concrete Saw Parts List, Ohio 2015*
 - *CC6571-3 Concrete Saw Parts List, Ohio, 2015*
 - *A Guide for Professional Concrete Cutters*
 - *Training Manual – Introduction to Diamond Blades, Bits, and Equipment*
 - *Diamond Products' Equipment Catalog*
 - *Discount-equipment Website (www.discount-equipment.com)*
2. Kubota (**<http://www.kubotaengine.com>**)
 - *Operation Manual 2012*
 - *Operator's Manual, Kubota Diesel Engine V2607-CR-TE4, Code No. 1J500-8915-3.*
3. Concrete Sawing and Drilling Association (**www.csda.org**)
The CSDA has many helpful concrete cutting publications available to members and non-members.
4. Association of Equipment Manufacturers (**www.aem.org**)
The AEM has a variety of safety and technical manuals available for various types of equipment, along with a list of industry-standardized safety symbols.
5. Occupational Safety & Health Administration (OSHA) (**www.osha.gov/**)
OSHA provides information on work-related safety and health practices.
6. The National Institute for Occupational Safety and Health (NIOSH) (**www.cdc.gov/NIOSH/**)
NIOSH provides information on work-related safety and health practices.

EQUIPMENT AND PARTS WARRANTY

Discount-equipment warrants all equipment sold by it against defects in workmanship or materials for a period of one (1) year from the date of shipment to Customer.

The responsibility of Discount-equipment under this Warranty is limited to replacement or repair of defective parts, of such parts as shall appear to us upon inspection at such parts, to have been defective in material or workmanship, with expense for transportation and labor borne by Customer.

In no event shall Discount-equipment be liable for consequential or incidental damages arising out of the failure of any Product to operate properly.

Integral units such as engines, electric motors, batteries, transmissions, etc., are excluded from this Warranty and are subject to the prime manufacturer's warranty.

**THIS WARRANTY IS IN LIEU OF ALL OTHER WARRANTIES,
EXPRESSED OR IMPLIED, AND ALL SUCH OTHER WARRANTIES ARE
HEREBY DISCLAIMED.**



TO PURCHASE THIS PRODUCT PLEASE CONTACT US



**Equipment Financing and
Extended Warranties Available**



**Discount-Equipment.com is your online resource for
commercial and industrial quality parts and equipment sales.**

561-964-4949

visit us on line @ www.discount-equipment.com

Select an option below to find your Equipment

Search by Manufacturer

Search by Product Type

Request a Quote

We sell worldwide for the brands: Genie, Terex, JLG, MultiQuip, Mikasa, Essick, Whiteman, Mayco, Toro Stone, Diamond Products, Generac Magnum, Airman, Haulotte, Barreto, Power Blanket, Nifty Lift, Atlas Copco, Chicago Pneumatic, Allmand, Miller Curber, Skyjack, Lull, Skytrak, Tsurumi, Husquvarna Target, Stow, Wacker, Sakai, Mi-T-M, Sullair, Basic, Dynapac, MBW, Weber, Bartell, Bennar Newman, Haulotte, Ditch Runner, Menegotti, Morrison, Contec, Buddy, Crown, Edco, Wyco, Bomag, Laymor, EZ Trench, Bil-Jax, F.S. Curtis, Gehl Pavers, Heli, Honda, ICS/PowerGrit, IHI, Partner, Imer, Clipper, MMD, Koshin, Rice, CH&E, General Equipment, Amida, Coleman, NAC, Gradall, Square Shooter, Kent, Stanley, Tamco, Toku, Hatz, Kohler, Robin, Wisconsin, Northrock, Oztec, Toker TK, Rol-Air, APT, Wylie, Ingersoll Rand / Doosan, Innovatech, Con X, Ammann, Mecalac, Makinex, Smith Surface Prep, Small Line, Wanco, Yanmar