



**CONCRETE SAW
OPERATOR'S MANUAL**

CC9074DK DEEP CUT

March 2019

Part #: 1802703

TO PURCHASE THIS PRODUCT PLEASE CONTACT US



**Equipment Financing and
Extended Warranties Available**



**Discount-Equipment.com is your online resource for
commercial and industrial quality parts and equipment sales.**

561-964-4949

visit us on line @ www.discount-equipment.com

Select an option below to find your Equipment

Search by Manufacturer

Search by Product Type

Request a Quote

We sell worldwide for the brands: Genie, Terex, JLG, MultiQuip, Mikasa, Essick, Whiteman, Mayco, Toro Stone, Diamond Products, Generac Magnum, Airman, Haulotte, Barreto, Power Blanket, Nifty Lift, Atlas Copco, Chicago Pneumatic, Allmand, Miller Curber, Skyjack, Lull, Skytrak, Tsurumi, Husquvarna Target, Stow, Wacker, Sakai, Mi-T-M, Sullair, Basic, Dynapac, MBW, Weber, Bartell, Bennar Newman, Haulotte, Ditch Runner, Menegotti, Morrison, Contec, Buddy, Crown, Edco, Wyco, Bomag, Laymor, EZ Trench, Bil-Jax, F.S. Curtis, Gehl Pavers, Heli, Honda, ICS/PowerGrit, IHI, Partner, Imer, Clipper, MMD, Koshin, Rice, CH&E, General Equipment, Amida, Coleman, NAC, Gradall, Square Shooter, Kent, Stanley, Tamco, Toku, Hatz, Kohler, Robin, Wisconsin, Northrock, Oztec, Toker TK, Rol-Air, APT, Wylie, Ingersoll Rand / Doosan, Innovatech, Con X, Ammann, Mecalac, Makinex, Smith Surface Prep, Small Line, Wanco, Yanmar

TABLE OF CONTENTS

Table of Contents

Introduction	7
CC9074DK Deep Cut Controls	8
CC9074DK Deep Cut Dimensions	10
CC9074DK Deep Cut Specifications	11
Safety	12
Safety Alerts	12
Proposition 65	12
Spark Arrester Requirement	12
Respiratory Hazards	12
General Safety	13
Battery and Electrical Safety	14
Blade Safety	14
Blade Guard Safety	14
Fuel Safety	15
Engine Safety	15
Cutting Safety	15
Hydraulic Safety	16
Belt Safety	16
Transporting Safety	16
Lifting Safety	16
Display Panel Controller	17
Controller Features	17
Flat Screen Display	17
Soft Key Commands	17
Function Keys	18
Menu Key	18
Enter Key	18
Soft Key Command Operations	18
MENU Key Operations	19
Display Features (Home Screen)	23
Operation	25
Home Screen	25
Blade Speed	25
Engine Torque	25
Engine Speed	25
Operating	26
General Operating Precautions	26
Emergency Stop	26
Activating the Emergency Stop	26
Deactivating the Emergency Stop	26
Handlebars	26
Adjusting the Handlebars	27
Speed Control Lever	27
Control Grip Pushbuttons	27
Blade Lowering Speed	28
Moving the Machine Forward / Reverse with the Engine Running	28
Moving the Machine with the Engine Off	28
Bogie Wheel	28
Bogie Wheel - Locked Sideways Motion	28
Bogie Wheel - Free Wheel Motion	29
Fuel System	29
Adding Fuel	29

TABLE OF CONTENTS

Blade Guard	29
Installing the Blade Guard	30
Removing the Blade Guard	30
Slurry Shield	31
Flange Guard	31
Installing the Flange Guard	31
Removing the Flange Guard	31
Diamond Blades	31
Inspecting the Blade	31
Blade Speed	31
Wrench	31
Installing the Blade	32
Removing the Blade	33
Optional Blade Arbor Configurations	34
Engine	34
Tasks Prior to Starting the Engine	35
Starting the Engine	35
Stopping the Engine	35
Control Panel Display	35
Normal Operation	35
Water Supply	36
Using the Water Supply	36
Water Pump	36
Cutting	36
Cutting Guides	36
Adjusting the Front Pointer	36
Adjusting the Rear Pointer(s)	37
Straight Line Cutting	37
Helpful Hints Prior to Cutting	37
Tasks Prior to Cutting	37
Making a Cut without Using the Blade Depth Stop	37
Making a Cut Using the Blade Depth Stop	38
Continuing a Partial-Cut	38
Finishing a Cut	38
Drive Alignment	39
Adjusting the Drive Alignment	39
Footrest	39
Weight Kit (Optional)	39
Spotlight	39
LED Light Bar	39
Tie-Downs	39
Maintenance	40
General	40
Maintenance Tools	40
Pre Maintenance Preparations	40
Rear Cover Screen	40
Removal of Rear Cover Screen	40
Installing the Rear Cover Screen	40
General Cleaning	40
Cleaning Techniques	40
Radiator	41
Control Panel	41
Display Screen and Camera Lens	41
Engine	41

TABLE OF CONTENTS

Part Lubrication	41
Post Cleaning	41
Service Schedule	42
Daily Service	43
Check Engine Oil Level	43
Check Fuel Level	43
Hydraulic System	43
Check Hydraulic Fluid Level for Hydro Pump Assembly	44
Adding Fluid to the Hydraulic Lift Pump	44
Check Radiator Coolant Level	44
Check and Clean Blade Guard Spray Tubes	45
Lubricate the Blade Shaft Bearings	45
Check Air Cleaner Restriction Indicator	45
25 Hour Service	46
Inspect Belts	46
Lubricate the PTO	46
50 Hour Service	46
Drain the Fuel/Water Separator Filter	46
Lubricate the Hydraulic Cylinder Pivot Pin	46
Lubricate Front Axle Bearings	47
Lubricate the Jackshaft Bearings	47
Lubricate the Bogie Wheel	47
250 Hour Service	47
Clean the Air Cleaner Element	47
Replace Engine Oil and Filter	48
500 Hour Service	49
Replace Hydraulic Oil and Filter	49
Replace the Fuel/Water Separator Filter	49
Replace the Fuel Filter	50
Replacing the Outer Primary and Inner Safety Filters	51
1000 Service Hours	51
Replace Radiator Coolant	51
1500 Service Hours	52
Replace the Oil Separator Element	52
Regular Maintenance	52
Converting Blade Setup	52
Jackshaft Drive Belt Sheaves	52
Removing the Jackshaft Drive Belt Sheave	52
Installing the Jackshaft Drive Belt Sheave	53
Installing the Jackshaft Drive Belts	54
Blade Drive Belts	54
Tensioning the Blade Drive Belts	54
Engine	55
Engine Control Unit (ECU)	55
Battery	55
Battery Type	56
Servicing the Battery	56
Electrical System	56
Fuses	56
Replacing Fuses	56
Speed Control Lever	56
Adjusting Speed Control Cable	56
Adjusting the Lever Tension	57
Adjusting the Spring Plungers	57

TABLE OF CONTENTS

Inner Blade Flange	57
Installing the Inner Blade Flange.....	58
Removing the Inner Blade Flange.....	58
Maximum Cutting Depth Stop Bolts.....	58
Handlebar Lock Cylinder	58
Removing the Lock Cylinder	58
Connecting the Lock Cylinder	59
Lifting and Transporting.....	59
Lifting.....	59
Transporting.....	60
Storing	60
Disposal.....	60
Engine Regeneration.....	60
Passive Regeneration.....	60
Active Regeneration.....	61
Parked Regeneration	61
Requesting a Parked Regeneration	62
Appendix A	64
Model and Serial Numbers.....	64
Appendix B	65
Troubleshooting	65
Appendix C	67
CC9074DK Deep Cut RPM Chart.....	67
CC9074DK Deep Cut Blade Size Conversion Chart.....	67
Appendix D	68
Additional Resources	68

To order go to Discount-Equipment.com

INTRODUCTION

Introduction

Welcome to the Diamond Products family and thank you for choosing Diamond Products equipment. At Diamond Products we are driven to ensure you are completely satisfied with your product and continually strive to improve our product line so that we can offer you the best possible equipment in the industry.

This operator's manual is a critical document that provides pertinent information regarding the safety, operation, maintenance, and care of your new equipment. Keep this manual available at all times. Operate the equipment and all of its components according to this manual. Failure to comply with and understand the following safety, operation and maintenance instructions can result in serious injuries and/or death. All operators must be properly trained or supervised by experienced personnel prior to using this saw and should understand the risks and hazards involved. Diamond Products discourages improper or unintended equipment usage and cannot be held liable for any resulting damages.

Equipment modifications should be made by Diamond Products to ensure safety and design. Any modifications made by the owner(s) are not the responsibility of Diamond Products and void all equipment warranties if a problem arises as a result of the modification.

Refer to the Diamond Products Parts List for additional information and part diagrams. Refer to the engine manual and manufacturer as the primary source for all safety, operations, and maintenance instructions regarding the engine. Prior to operating, record the saw's serial number, and the engine's model and serial numbers in Appendix A.

INTRODUCTION

CC9074DK Deep Cut Controls

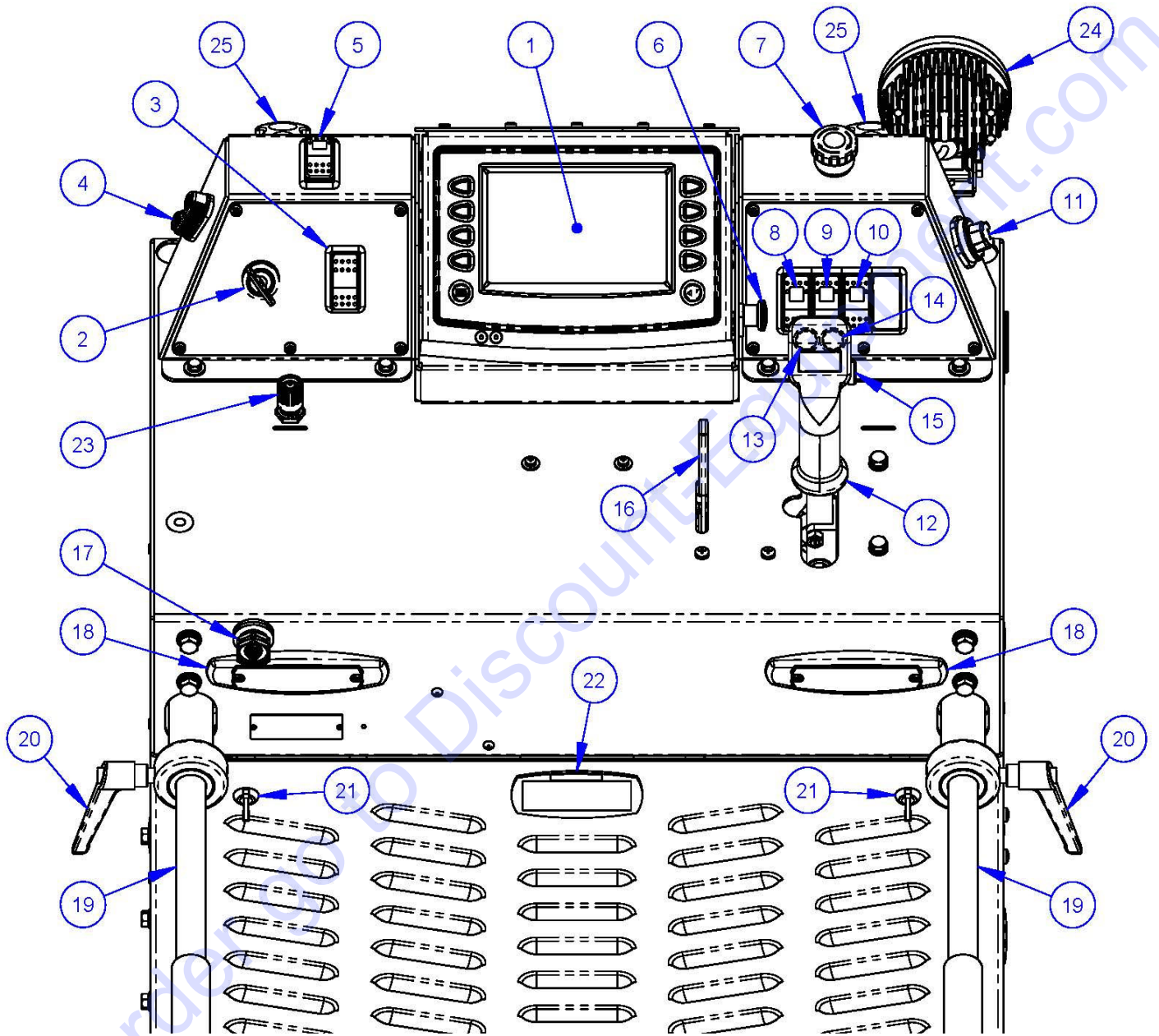

INTRODUCTION

1. **Engine Display Panel** – Monitors and displays various engine and machine parameters.
2. **Ignition Switch** – Starts the engine and provides power to certain components.
3. **Engine Throttle Switch** – Increases and decreases engine/blade speed (RPM).
4. **Rope Cleat** – Secures front pointer rope.
5. **Free Wheel Switch** – Disengages the transmission to allow for manual forward and reverse movement of the saw.
6. **Display Lock, Spring Plunger** – Locks the controller display in the open/closed position.
7. **Emergency Stop Button** – Stops the engine.
8. **Spotlight Switch** – Activates spotlight.
9. **Light Bar Switch** – Activates light bar.
10. **Water Pump Switch (Optional)** – Activates water pump.
11. **USB Port Connection** - Allows for program updates.
12. **Speed Control Lever** – Forward, reverse, and neutral control.
13. **Saw Raise Pushbutton** – Activates hydraulic pump to raise saw.
14. **Saw Lower Pushbutton** – Bleeds hydraulic pressure from lift cylinder to lower saw.
15. **Tilt Handlebar Pushbutton** – Allows adjustment of handlebars up or down to desired angle.
16. **Water On/Off Control Valve** - Turns water flow, to the saw blade, on and off.
17. **Water Inlet Hose Connection** – Attachment point for water supply.
18. **LED Marker Light** – Illuminates when machine is on.
19. **Handlebar** – Allows for operator control of saw.
20. **Handlebar Lock Lever** – Locks the handlebar extension in place.
21. **Rear Cover Screen Latch** – Allows for removal of rear cover screen for servicing.
22. **Rear Cover Screen Pull Handle** – Allows for easy handling of rear cover screen.
23. **Blade Lowering Speed Valve** – Controls the lowering speed of the saw.
24. **Spot Light** – Provides area lighting.
25. **Spot Light Adjustment Knob** – Allows for positioning of spot light.

INTRODUCTION

CC9074DK Deep Cut Dimensions

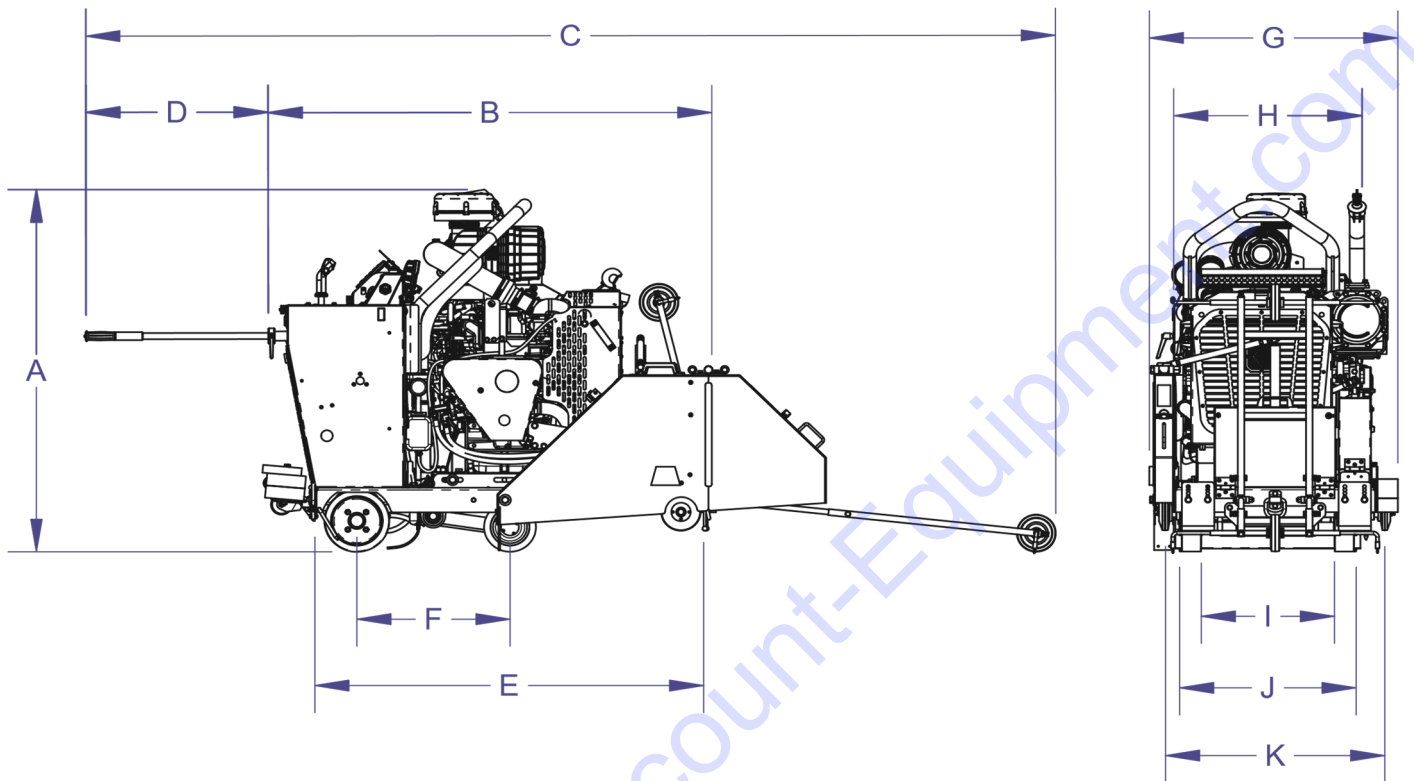

CC9074 Deep Cut Dimensions		Inches	Millimeters
A	Saw Height	58-1/2	1486
B	Saw Length - Min.	69	1753
C	Saw Length - Max.	150	3810
D	Handle Extension - Max.	28	711
E	Frame Length	60	1524
F	Wheel Base Length	23-3/4	603
G	Saw Width	38-1/4	972
H	Rear Frame Width	29	737
I	Front Wheels Inside Width	20-1/2	521
J	Rear Wheels Outside Width	27-1/4	692
K	Inner Flange to Inner Flange Width	33-3/4	857
-	Blade Raise Height - Max.	32	813

INTRODUCTION

CC9074DK Deep Cut Specifications

Saw Model	CC9074DC-36	CC9074DC-42	CC9074DC-48	CC9074DC-54	CC9074DC-60
Blade Guard Capacity	36" (900mm)	42" (1000mm)	48" (1200mm)	54" (1400mm)	60" (1500mm)
Blade Cutting Depth Max	15"	17.5"	20"	22.5"	25"
Blade Shaft Speed	1400 rpm	1150 rpm	1000 rpm	870 rpm	800 rpm
Blade Flange Size	6" OD	7" OD	8" OD	9" OD	10" OD
Operating Weight	2,478 lbs.	2,500 lbs.	2,533 lbs.	2,823 lbs.	2,864 lbs.
Crated Weight	2,578 lbs.	2,600 lbs.	2,633 lbs.	2,923 lbs.	2,964 lbs.
Blade Guard Weight Only	63 lbs.	72 lbs.	94 lbs.	170 lbs.	200 lbs.
Rear Weight Kit Only	NA	NA	NA	200 lbs.	200 lbs.
Engine Model	Kubota V3307-CR-TE4B				
Emission Regulation	EPA-CARB Tier 4 Final / EU Stage III B				
Engine Type	4 cylinder, liquid cooled, turbo diesel				
Engine Max Power	74.3 hp @ 2600 rpm (Kubota rating)				
Peak Torque	195.5 Ft-Lbs (265 Nm) @ 1500 rpm				
Aftertreatment Device	Diesel particulate filter (DPF) + Diesel oxidation catalyst (DOC)				
Engine Air Filtration	Dry dual element with spinner pre-cleaner and restriction indicator				
Battery	12 Volt (950 CCA) group size 31				
Starter / Alternator	Electric 4hp (3kW) / 90 Amp				
Fuel Type	Ultra low sulfur diesel (Cetane 45 min)				
Fuel Tank	9 Gallon (34 Liter) with electronic fuel level indication				
Engine Oil	SAE 15W-40 API class CJ-4 (3 Gallon/11.3 Liter)				
Radiator Coolant	50/50 Pre-mixed (3 Gallon/11.3 Liter)				
Wheel Motor Pump Fluid	SAE 15W-40 (2 Liter capacity)				
Saw Lift Pump Fluid	SAE 15W-40 (2 Liter capacity)				
Lubrication Type	NLGI #2 Lithium grease				
Blade Arbor Size	1" Diameter with drive pin				
Blade Flange Style	Quick disconnect				
Blade Shaft Size	1-3/4" OD with left/right side blade mounting				
Blade Shaft Bearings	3 Pillow blocks with spherical roller bearings				
Blade Shaft Drive	Engine: 10 Kevlar V-Belts (3VX) to Jackshaft: 20 Kevlar V-Belts (3VX)				
Blade Coolant	Dual stainless steel multi-jet spray tubes				
Blade Guard Attachment	Slip-on tapered spade with rear bolt and top quick connect brace				
Blade Raise and Lower	Electro-hydraulic power unit with push button control				
Blade Lowering Speed	Adjustable panel mounted flow control valve				
Blade Depth Control	Electronic depth indicator and depth stop				
Blade Alignment	Telescoping front/rear/left/right pointers with tracking adjustment				
Axle Size (Front/Rear)	Front: 1" OD straight / Rear: 1" OD tapered				
Front Wheels	8" x 3" with 1" poly tread (sealed ball bearings)				
Rear Wheels	10" x 3" with 1" poly tread (quick disconnect lug nuts)				
Fifth Wheel	3-1/4" x 2" poly tread swivel lock caster				
Travel Speed	0-220 FPM (2.5 mph) forward/reverse				
Rear Wheel Transmission	Hydrostatic pump with push/pull cable control				
Rear Wheel Drive	Hydraulic wheel motors with freewheel for pushing				
Parking Brake	Automatic hydraulic lock at stop position				
Handle Bar Adjustment	Variable extension with quick lock variable 30° angle range				
Safety Alerts	Emergency stop, blade overspeed, neutral start				

SAFETY PRECAUTIONS

Safety

Operate the equipment and all of its components according to this manual. Failure to comply with and understand the following safety, operation and maintenance instructions can result in serious injuries and/or death. All operators must be properly trained or supervised by experienced personnel prior to using this saw and should understand the risks and hazards involved. Diamond Products discourages improper or unintended equipment usage and cannot be held liable for any resulting damages.

Equipment modifications should be made by Diamond Products to ensure safety and design. Any modifications made by the owner(s) are not the responsibility of Diamond Products and void all equipment warranties if a problem arises as a result of the modification.

Refer to the Diamond Products Parts List for additional information and part diagrams. Refer to the engine manual and manufacturer as the primary source for all safety, operations, and maintenance instructions regarding the engine. Prior to operating, record the saw's serial number, and the engine's model and serial numbers in Appendix A.

Notice: The information in this manual may be updated at any time!

Safety Alerts



DANGER

Serious injuries and/or death will occur if these instructions are not followed.



WARNING

Serious injuries and/or death could occur if these instructions are not followed.



CAUTION

Mild and/or moderate injuries could occur if these instructions are not followed.

Proposition 65



PROPOSITION 65

WARNING: This product produces gasoline or diesel engine exhaust, which is known to the state of California to cause cancer, birth defects or other reproductive harm. For more information go to:

WWW.P65WARNINGS.CA.GOV

Spark Arrester Requirement



WARNING

In the State of California it is a violation of section 4442 or 4443 to use or operate the engine on any forest-covered, brush-covered, or grass-covered land unless the engine is equipped with a spark arrester, as defined in section 4442, maintained in effective, working order or the engine is constructed, equipped, and maintained for the prevention of fire pursuant to section 4443.

Respiratory Hazards



WARNING

Concrete cutting produces dust and fumes known to cause illness, death, cancer, respiratory disease, birth defects, and/or other reproductive harm. Safety protection techniques include, but are not limited to:

- Wearing gloves.
- Wearing safety goggles or a face shield.
- Using approved respirators.
- Washing work clothes daily.
- Using water when wet cutting to minimize dust.
- Washing the hands and face prior to eating/drinking.

For additional safety and self-protection information contact your employer, the Occupational Safety and Health Administration (OSHA), and/or The National Institute for Occupational Safety and Health (NIOSH).

SAFETY PRECAUTIONS

General Safety

- Read and understand all safety, operations, and maintenance instructions provided in this manual prior to operating or servicing the saw.
- Keep equipment components clean and free of slurry, concrete dust, and debris.
- Inspect water hoses prior to operating the equipment. Clean, repair, or replace damaged components.
- Raise the equipment to a proper height for access when working underneath the equipment. Use chocks to block the wheels, and fit blocks or jacks under the frame edges.



WARNING

Do NOT work on equipment using the hydraulic lift system to keep the equipment in the raised position for maintenance or repair. Accidental loss of hydraulic pressure could cause the equipment to drop suddenly, resulting in serious injury or death.

- When using a jack to raise the equipment, place the jack against a solid, flat area under the frame base to properly support the equipment.
- Repair the equipment immediately when a problem arises.
- Replace equipment decals if unreadable.
- Dispose of all hazardous waste materials according to city, state, and federal regulations.
- Always have a phone nearby, and locate the nearest fire extinguisher and first aid kit prior to operating the equipment.
- Operate the equipment wearing flame resistant clothing.
- Always wear safety glasses when removing retaining rings.
- Underage or non-trained personnel should not operate the equipment.
- Keep all body parts away from rotating machinery.
- Replace all guards and access panels (unless stated otherwise) prior to operating the equipment.
- Always pivot front of blade guard fully closed to avoid serious injuries.

DO NOT:

- Assume the equipment will remain still when in neutral or when parking/stopping the equipment on a slope. Chock the wheels to help prevent unnecessary movement.
- Drop equipment, supplies, tools, etc., when handling to help prevent injuries.
- Lift and carry equipment, supplies, tools, etc., that are too heavy and/or cannot be lifted easily.

- Operate the equipment without using the appropriate safety equipment required for the work task.



- Operate or service the equipment with any clothing, hair, or accessories that can snag in the machinery, which could lead to serious injuries or death!
- Operate the equipment using attachments not associated with or recommended for the equipment.
- Operate the equipment around combustible materials.
- Operate the equipment with anyone near the work area or within the direct line of the blade.
- Operate the equipment until all unnecessary materials have been removed from the work area.
- Operate the equipment with loose nuts, screws, and bolts.
- Operate the equipment when ill or fatigued.
- Operate the equipment under the influence of drugs and/or alcohol.
- Operate the equipment on steep slopes.
- Cut concrete with guards and access panels removed.
- Grease the equipment with the engine running.
- Touch hot components when operating the equipment.
- Leave the equipment unattended until the engine is off and the blade has stopped.
- Place the equipment into storage until it has cooled down.
- Service the equipment until it has cooled down.
- Service the equipment with the engine running.

SAFETY PRECAUTIONS

Battery and Electrical Safety

- Ignitable explosive gases are emitted from the battery. DO NOT expose the battery to sparks or open flames. 
- Keep the area around the battery well-ventilated.
- Keep the battery level when handling it.
- Use protective eyewear or a face shield, and avoid contact with the skin when handling/servicing the battery.
- Use a proper battery tester when testing the battery strength.
- Always be sure to connect the battery cables to the proper terminal when reconnecting the cables.
- Occasionally inspect the battery, cables, clamps, and terminals for damages. Service components as necessary.
- Always keep the battery cable clamps away from the battery terminals when the battery is disconnected to avoid accidental connections while servicing.
- Immediately rinse your clothing, skin, or eyes with water if exposed to battery acid. Seek medical attention immediately!
- Disconnect the battery prior to servicing all equipment components (unless stated otherwise).
- Remove the battery when storing the equipment for longer periods.
- Always use the correct size fuses (amps) to prevent fires.

Blade Safety

- Always use reinforced abrasive blades or steel-centered diamond blades.
- Never use a wet cutting blade without an adequate water supply to properly lubricate the blade.
- Inspect all blades prior to usage and discard damaged blades.
- DO NOT install or remove a blade with the engine running.
- Keep all body parts away from rotating blades.
- Inspect the blade flanges for damages, wear, and cleanliness. Clean or replace dirty/damaged components immediately.

- DO NOT expose yourself or anyone else to the direct line of the blade when operating the equipment.



- Always use an appropriate size blade and the correct blade type based on the cutting task and the type of material being cut.
- The blade must always fit snug on the blade shaft, outer flange, and/or inner flange.
- Wear gloves and be alert to the surrounding environment when handling blades.
- When installing the blade, always point the arrow printed on the blade in the direction of the blade shaft's rotation.
- DO NOT exceed the blade's maximum recommended speed when cutting. Excessive blade speeds can cause blade breakage, resulting in serious injuries and/or death!
- DO NOT use damaged blades when cutting to avoid harming yourself, others, or the equipment.
- DO NOT use a blade for cutting that requires a lower speed than the blade shaft speed.
- Always tighten the blade shaft bolt/screw as directed to properly secure the outer flange and blade. Failure to properly secure the outer flange and blade may cause parts to loosen or fall off the equipment, resulting in serious injuries or death!
- Let the blade cool prior to removal when dry cutting (applicable models).

Blade Guard Safety

- DO NOT operate the equipment with the blade guard raised or removed.
- Blade exposure should not exceed 180° while cutting.
- When pivoting the front of the blade guard, raise/lower it cautiously and slowly to avoid serious injuries.
- DO NOT pivot the blade guard front up or down when installing/removing very large blades. Attempting to pivot the front of a heavy guard when the guard is positioned higher up for blade installation/removal makes the guard difficult to lift and/or lower. In this situation, install/remove the blade guard front instead of pivoting it.

SAFETY PRECAUTIONS

- Always pivot the front of the blade guard 180° (fully upward) so the guard does not swing down unexpectedly, causing serious injuries.



- Always secure the pivoted section of the blade guard using the detent pin (guards 26" and up).
- Use extreme caution when installing/removing parts of a guard or the entire guard as guards can be extremely heavy and may require installation/removal at moderate heights.
- DO NOT install or remove the blade guard with the engine running.
- Always use a blade guard that corresponds with the blade size.
- Inspect the blade guard and water tubes prior to starting the equipment. Clean or replace dirty/damaged components immediately.

Fuel Safety

- Always use caution when refueling.
- Store all fuel in appropriate safety containers.
- DO NOT operate the equipment with a fuel leak.
- DO NOT fuel the equipment with the engine running.
- Let the engine cool prior to adding fuel.
- Refer to the engine manual for recommended fuels.
- Always use appropriate fuels in cold weather.
- Move the equipment away from the refueling area prior to starting the engine.

- DO NOT smoke or expose fuel to open flames when filling the fuel tank or working with fuel.



- Clean up any spilled fuel prior to starting the engine.
- Drain the fuel tank and fuel lines when storing the equipment for longer periods of time. Refer to the engine manual for additional recommendations.

Engine Safety

- Refer to the engine manual as the primary source for engine safety.
- Always know how to turn off the engine quickly for emergency purposes.

- Make sure the equipment is in neutral when starting the engine.
- Fill the fuel tank and check the oil level prior to starting the engine.

- Keep all body parts away from rotating equipment parts with the engine in operation.



- DO NOT start the engine without the air filter(s) installed.
- DO NOT allow dust to enter the air intake tube when cleaning/replacing air filter(s).
- Replace damaged components immediately that may allow dust to enter the engine.
- DO NOT leave the engine running unattended.

- Always operate the equipment in well-ventilated areas. Concentrated engine exhaust can cause loss of consciousness and/or death.



- DO NOT touch the engine/muffler assembly with the engine running, and always let them cool down prior to touching or servicing the equipment.
- Handle hot oil carefully when changing the oil.
- Let the engine cool prior to removing pressurized caps (applicable models).
- DO NOT use any starter substances or starter fluids (e.g., starter fluid sprayed into the air filter) when starting the engine using a glow plug (applicable models). These materials are extremely flammable and explosive, and can melt parts or possibly explode when used to help start the engine.

Cutting Safety

- The direct work area should not contain buried or embedded electrical, gas, or water lines that could be damaged and/or cause personal injury while cutting.
- Turn off all electricity, gas, and water around the direct work area prior to cutting.
- Inspect the work area to ensure nothing will impede full control of the machine at all times.
- DO NOT expose yourself or anyone else to the direct line of the blade when operating the equipment.

SAFETY PRECAUTIONS

- DO NOT allow any person, animal, and/or objects in and around the work area while cutting.
- DO NOT install a blade on the machine until it is in the cutting area.
- Ensure the work area is adequately illuminated to ensure safe operation of the machine.

Hydraulic Safety

- Turn off the engine prior to servicing hydraulic components.
- Lower the equipment completely prior to servicing to decrease the hydraulic pressure in the lines.
- Always make sure any hydraulic components being serviced are not supporting the weight of other equipment components. If a particular component is under pressure when connection points are loosened, oil may spray out forcefully.

- Always place a piece of cardboard or paper up against hydraulic components, or use a leak detection fluid to check for hydraulic fluid leaks. Keep all body parts away from leaks and/or areas that may eject hydraulic fluid. Pressurized hydraulic fluid can penetrate the skin, causing serious injuries. Seek medical attention immediately!



Belt Safety

- Turn off the engine and let the belts cool down prior to servicing them.
- Regularly inspect the belts for fraying, stress cracks, and/or breakage and replace immediately when damaged. Always check the belt alignment prior to operating the equipment.
- Use extreme caution when working with belts and rotating machine parts to avoid entanglement.
- Over-tensioning belts may reduce the life of the gearbox bearings. Under-tensioning belts may cause slippage, shorter belt life, and/or poor equipment performance.
- Squealing belts indicate looseness.
- DO NOT use old and new belts together on the same sheave.

Transporting Safety

- Remove the blade prior to transporting the equipment.
- Make sure the truck/trailer is in good, working condition and sufficient to transport the load. DO NOT tow the equipment behind a vehicle.
- Close the fuel shutoff valve (applicable models) when transporting.
- Drain the fuel tank when transporting long distances.
- Use heavy-duty ramps that will support the weight of the equipment and yourself when loading or unloading.
- Raise the equipment to avoid damaging components while moving up and down ramps.

- Use extreme caution when guiding the equipment up and down ramps. Slowly drive the equipment forward down the ramp. Slowly back the equipment in reverse up the ramp. Avoid standing directly downhill from the equipment to prevent machine rollover.



- Place the equipment in neutral and turn off the engine once the equipment is loaded in the truck/trailer.
- Chock the wheels and secure the saw in the truck/trailer prior to transporting.
- Refer to the Discount-equipment for additional transportation recommendations.

Lifting Safety

- Move yourself and all others away from the lifting area when hoisting the saw to prevent being crushed.



- Secure the appropriate hoisting cables, straps, and/or chains to the saw's designated lift points prior to hoisting.
- Never use the tie-down brackets (applicable models) to lift the saw.
- DO NOT attempt to lift the saw irresponsibly and/or improperly.

DISPLAY PANEL

Display Panel Controller

The display panel is a rugged Controller Area Network or CAN. This is a means of linking all of the electronic systems within the saw together allowing them to communicate with each other. This section explains the functions of the unit, describes the display screens and gives details about the configuration.

Controller Features

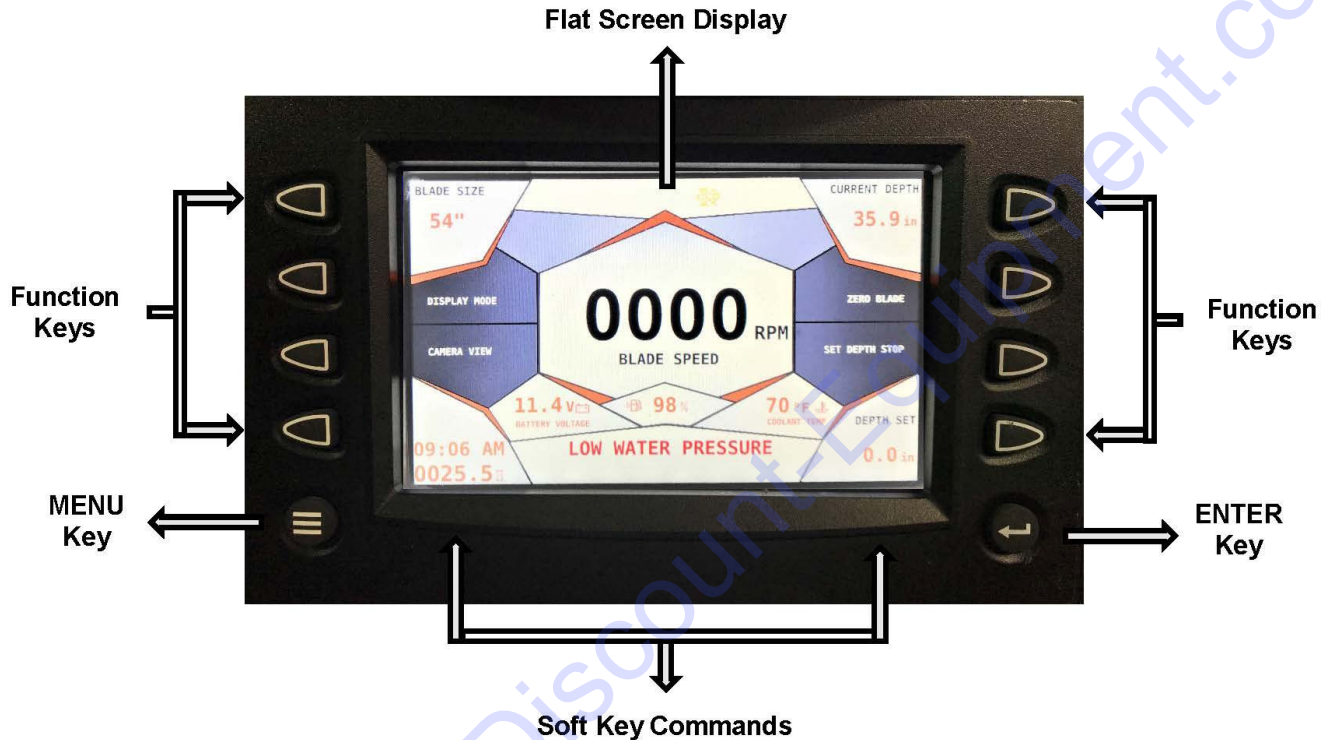

Flat Screen Display

A color screen displays the “Home” screen, gauges, soft key commands, and fault messages, as well as menu options for setup and configuration.

Soft Key Commands

Columns of vertical commands may be located to the left and/or right of the display. They will change according to the options available for the screen being displayed.

There are a total of five soft key commands associated with this application. Three on the left side of the display and two on the right side of the display.

<u>Left Side</u>	<u>Right Side</u>
Blade Size	No Function
Display Mode	Zero Blade / Clear Zero
Camera View	Set Depth Stop / Clear Depth Stop
No Function	No Function

DISPLAY PANEL

Function Keys

The function keys correspond to the soft key commands and allow selections to be made accordingly.

Menu Key

Pressing the **MENU** key displays the list of four available menu options:

- Gauge Display
- Engine Diagnostics
- User Settings
- Utilities

Enter Key

This feature is used when uploading new programs to the controller.

Soft Key Command Operations



There are four basic icons associated with the soft key commands. These icons allow for the navigation through the sub-menus, selection of commands, or deselection of commands. These icons are shown below:

<u>ICON</u>	<u>Description</u>
↓	Down – Navigates the cursor downward through a list
↑	Up – Navigates the cursor upward through a list
✓	Select – Enters the action item highlighted in a list.
✗	Deselect – Closes the current screen and returns to either the previous menu or the Home screen

Blade Size – Pressing the function key to the left of this soft key command will toggle between the “Home” screen and the “Blade Size Selection” screen.

DISPLAY PANEL

Display Mode - Pressing the function key to the left of this soft key command will toggle between the three dynamic “Home” screens:

- Blade Speed
- Engine Torque
- Engine Speed

Camera View - Pressing the function key to the left of this soft key command will turn on the front mounted camera to display the cutting area on the display screen.

Zero Blade/Clear Zero - Pressing the function key to the right of this soft key command will set a zero benchmark set point to allow for accurate cutting depth indication. It will also clear any set points when pressed a second time.

Set/Clear Depth Stop - Pressing the function key to the right of this soft key command allows the operator to set a designated stopping point for the blade within a cut. It will also clear any set points when pressed a second time.

MENU Key Operations

Pressing the MENU key will result in the four “Main Menu” options appearing on the display screen. The four options associated with the MENU key are:

1. Gauge Display
2. Engine Diagnostics
3. User Settings
4. Utilities

“**Gauge Display**” option - By pressing the associated function key for either the  or  icon, the display will return to the “Home” screen.

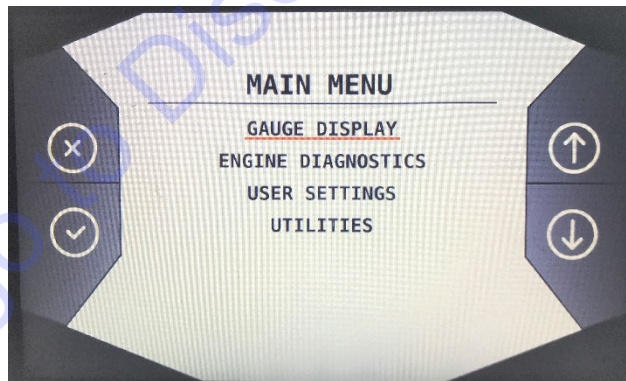

“**Engine Diagnostics**” option – This function allows access to three sub-menus that can be toggled between using the arrow keys on the right side of the controller.



DISPLAY PANEL

1. Recall Active Faults

- a) Opens a screen showing current active fault codes. If more than one code is active, the operator can toggle between the fault code boxes using the arrow keys on the right side of the screen.

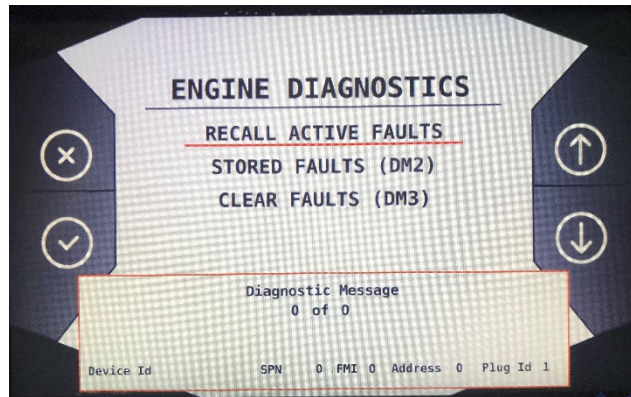

2. Stored Faults (DM2)

- a) Opens a screen of stored fault codes.

ENGINE DIAGNOSTICS						Status OK
Source DM2.Heade...	Plug DM2.He...	SPN DM2.He...	FMI DM...	Count DM...		
Description DM2.Header.Description			Correction DM2.Header.Correction			
Source	Plug	SPN	FMI	Count	Description	
DM2.T...	DM2.T...	DM2.T...	D...	D...	DM2.Table.Description.1	
DM2.T...	DM2.T...	DM2.T...	D...	D...	DM2.Table.Description.2	
DM2.T...	DM2.T...	DM2.T...	D...	D...	DM2.Table.Description.3	
DM2.T...	DM2.T...	DM2.T...	D...	D...	DM2.Table.Description.4	
DM2.T...	DM2.T...	DM2.T...	D...	D...	DM2.Table.Description.5	
DM2.T...	DM2.T...	DM2.T...	D...	D...	DM2.Table.Description.6	
DM2.T...	DM2.T...	DM2.T...	D...	D...	DM2.Table.Description.7	
DM2.T...	DM2.T...	DM2.T...	D...	D...	DM2.Table.Description.8	
DM2.T...	DM2.T...	DM2.T...	D...	D...	DM2.Table.Description.9	
DM2.T...	DM2.T...	DM2.T...	D...	D...	DM2.Table.Description.10	

3. Clear Faults (DM3)

- a) Allows the user to clear all stored fault codes.

DISPLAY PANEL

“User Settings” option – This function allows the operator to change some parametric settings. The yellow Up and Down arrows on the left allow you to move the cursor through the options. While the cursor is highlighting an option that can be changed, gray Up and Down arrows will appear on the right side of the display. Use the gray arrows to change the option setting. Once the options are set, press the Menu key to save and close the user settings.

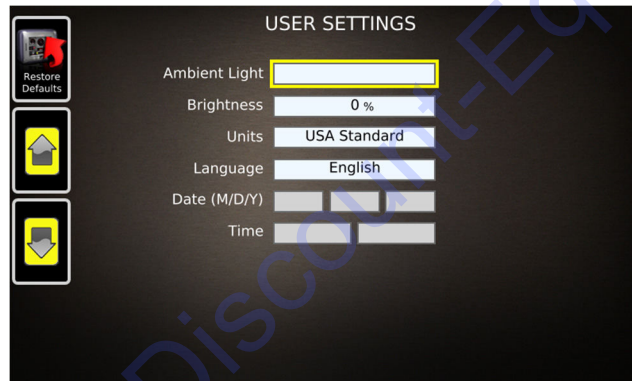
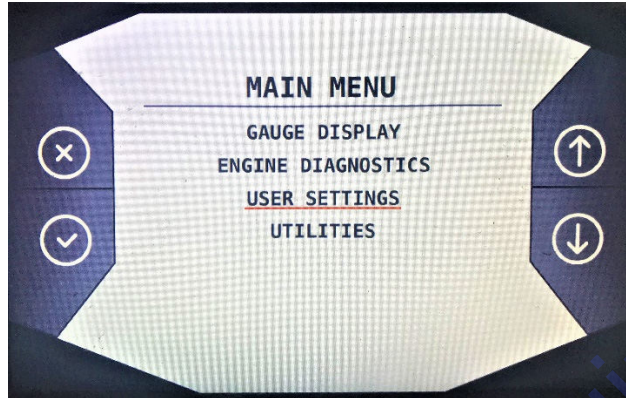

The following settings can be changed by the operator:

1. Brightness (%)
2. Units
 - a) USA Standard
 - b) Metric Bar
 - c) Metric KPa
 - d) British Standard
3. Language
 - a) English
 - b) Spanish
 - c) French
4. Date (M/D/YY)
5. Time

DISPLAY PANEL

“Utilities” option_ This function allows access to three sub-menus that can be toggled through using the arrow keys on the right side of the screen.

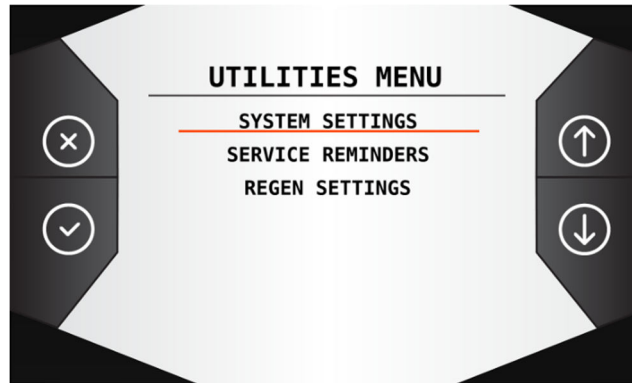

1. System Settings.

a) This is strictly an informational screen providing current program data.

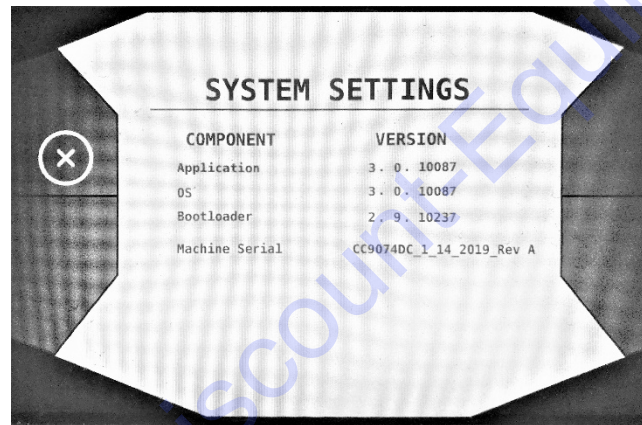

2. Service Reminders

a) This function will show the five critical service reminders with their interval periods, the time when the next service is due, and how many hours are remaining until that time. This screen allows for editing the interval or turning it off. See the Maintenance section of this manual for additional information regarding maintenance schedules.

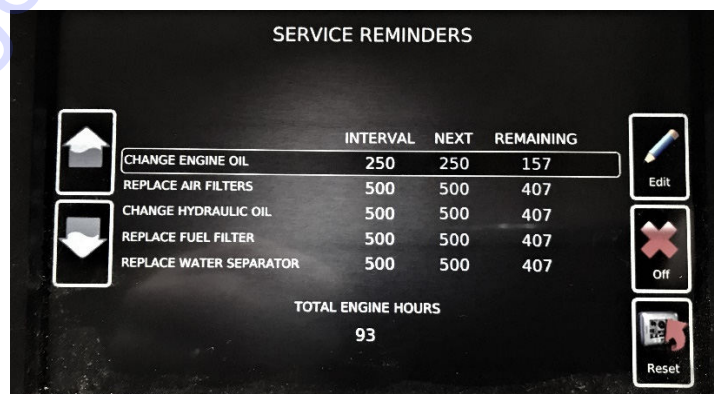

DISPLAY PANEL

3. Regen Settings

- a) This menu will display a screen showing the Diesel Particulate Filter (DPF) regeneration choices available. The machine is factory set to allow for un-inhibited regenerations of the DPF. It can be set to inhibit the regeneration process by selecting the option. There is also an option to request a regeneration from this menu. See the Maintenance section of this manual for additional information regarding the DPF regeneration process.



Display Features (Home Screen)

During engine operation, all essential parameters are monitored from the “Home” screen through a series of displays and gauges. There are two displays associated with the “Home” screen:

- Status Display - Located at the top center of the display screen
- Fault Message Display - Located at the bottom center of the display





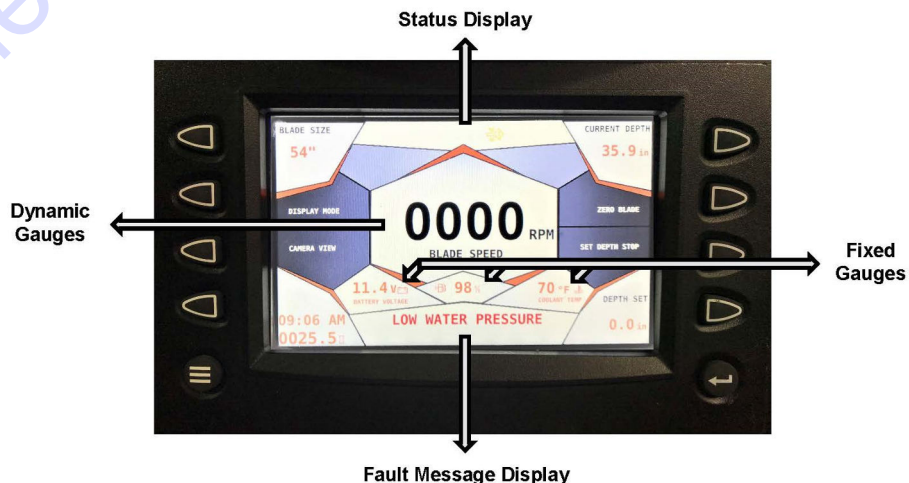





There are six digital gauge displays associated with the “Home” screen. Three are fixed gauges and three are dynamic gauges:

- Fixed Gauges – Located above the fault message display.
 1. Battery Voltage (V)
 2. Fuel Tank Level (%)
 3. Coolant Temperature (°F / °C)
- Dynamic Gauges – Large gauge located in the middle of the display. Only one gauge appears at a time. The individual gauges are toggled through the use of the “Display Mode” function key.
 1. Blade Speed (RPM)
 2. Engine Torque (ft-lbs / Nm)
 3. Engine Speed (RPM)

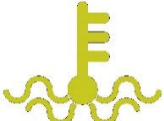

DISPLAY PANEL

The status display shows various color coded status icons that will light up when communicating the operator. Pay close attention to the status icons and color if they appear.

Status Icon	Description
	Parking Brake Switch – Green icon displays when the parking brake is applied.
	Low Fuel Level – Red icon will display when fuel level is low.
	Low Battery Voltage – Orange icon will display when battery voltage is low.
	Maintenance Required – Black icon will display when a required maintenance milestone is reached.
	Active Fault – Red icon is visible if the controller receives a DM1 message with a red lamp command.
	Engine Exhaust High Temperature Lamp – Red icon displays during active DPF regeneration when the DPF outlet temperature is greater than 450°C/842°F and post engine fuel injection is occurring.
	DPF Regeneration set to Inhibit – Yellow icon displays when the machine or the operator has inhibited regeneration.
	Regeneration Needed – Yellow icon will display solid to request an automatic regeneration when regeneration is set to inhibited. Icon will become red when regeneration is required.
	High Coolant Temperature – Yellow icon will display solid when the coolant temperature rises above normal.
	Neutral – Green icon displays when the transmission is in neutral.

The fault message display shows descriptive indication of any current fault conditions associated with the saw.

DISPLAY PANEL

Operation

Turning the ignition key switch to *ON* will activate a sequence of screens on the display. First, the Diamond Products logo will appear followed by the “Blade Size Selection” screen. It is important to have the correct blade size selected for the installed drive configuration on the machine. Not having the proper blade size selected for the installed drive configuration will result in reduced cutting efficiency or serious bodily injury. Refer to the RPM and Blade Size Conversion Charts located in Appendix C at the end of this manual.



To select the proper blade size scroll through the available blade sizes using the arrow keys (↑ ↓) on the right side of the display. Once the proper size is selected press the Select button (✓) on the left side of the display, this will save the blade size and open up the Home screen. If the proper size is already showing on the screen, press the Deselect button (✕) to toggle to the Home screen.

Home Screen

Once the blade size has been selected, the “Home Screen” will be displayed. There are three dynamic gauges that can be toggled through.

Blade Speed

This gauge shows the actual blade shaft speed that is being output by the shaft tach gear assembly. The blade speed limit is based on the blade size selected by the operator and is programmed into the controller to prevent an over-speed condition with the blade. If the blade speed indication is lost, the blade shaft speed limit will be based on the factory set engine speed for the blade size setup originally ordered.

Engine Torque

This gauge will display the engine torque, in either foot pounds or newton meters (ft-lb or Nm) depending upon the units selected by the operator.

Engine Speed

This gauge will display the engine speed in RPM as output from the engine control unit (ECU). This speed is limited to the original factory setting based on the initial blade size ordered.

Operating

General Operating Precautions

- Prior to operating the machine, read the operator's manual thoroughly and ensure that you understand the safe and proper operation of the machine.
- Use approved personal protective equipment at all times while operating the machine.
- Ensure that there is firefighting equipment and a first aid kit nearby while operating the machine.
- Ensure the cutting area is free of obstructions, people, and or animals prior to operating the machine.
- Always operate the machine from the operator's position at the rear of the machine between the handlebars.
- Do not stand in front or behind the blade path while the engine is running.

Emergency Stop

If an emergency condition should arise, the machine is equipped with an emergency stop button located on the top of the right side switch box assembly. The emergency stop places the machine into safe mode allowing the operator to address the emergency condition.

NOTE: Only use the emergency stop in an emergency condition. Do not use it to stop the machine during normal operations.

Activating the Emergency Stop

To activate the emergency stop, press down on the emergency stop button. The engine will shut off and the display panel will indicate that the emergency stop is active.

Deactivating the Emergency Stop

Prior to deactivating the emergency stop, ensure that the machine is back into a safe operating condition. Then turn the emergency stop button clockwise until it springs back into position. The machine can now be restarted.



Emergency Stop

Handlebars

The handlebars help to guide and maneuver the saw. During transporting of the saw, the handlebars can be placed in the storage tubes to save on space. When the handlebars are removed for operation, ensure the handlebar plug assembly is inserted into the storage tube to minimize water and slurry buildup. Place the handlebars in the desired position for better leverage when lifting and steering. To maneuver the saw forward or backward, turn on the *Free Wheel* switch and move the saw as desired.

NOTE: The free wheel component only works with the ignition key at ON position.



Handlebar Storage



Handlebar Plug Assembly



Handlebar, Operating Position

Adjusting the Handlebars

1. Loosen the handlebar adjusting lever.
2. Move the handlebar forward or backward to adjust the length and retighten the adjusting lever to secure.

NOTE: Maintain a minimum of 6" of handlebar into the handlebar tube at all times.

3. Press the *Tilt Handlebar* pushbutton, located on the side of the control grip, and move the handlebar up or down to adjust the angle.

NOTE: The button only works with the ignition key at the ON position.

4. To reposition adjustment lever, pull out and move to desired lever position.

Speed Control Lever

The speed control lever is a part of an electro-mechanical assembly that allows the operator to raise and lower the machine, adjust the tilt of the handlebars, move the machine in a forward or reverse direction, or place the machine in *STOP/PARK*.

Control Grip Pushbuttons

The control grip pushbuttons only work with the ignition key at *ON* or with the engine running.



Control Grip Pushbuttons

1. Press the *Raise* (left) pushbutton to raise the saw and blade, and release to stop.

NOTE: Always raise the blade when maneuvering the saw to provide proper clearance between the blade and the ground.

2. Press the *Lower* (right) pushbutton to lower the saw and blade, and release to stop.
3. Press the *Tilt Handlebar* (side) pushbutton and move the handlebar up or down to adjust the angle.

Blade Lowering Speed

Turn the *Blade Lowering Speed* valve counterclockwise to increase the blade's lowering speed and clockwise to decrease the blade's lowering speed.

NOTE: The valve does not adjust the blade's raising speed which is not adjustable.



Blade Lowering Speed Valve

Moving the Machine Forward / Reverse with the Engine Running

NOTE: Prior to moving the machine, read and understand the "Starting the engine and Stopping the engine" section of this manual.

The speed control lever will only move the saw in a forward or reverse direction when the engine is running.

1. Turn the ignition switch to the *ON* position.
2. On the display panel, verify the blade size and then open the main screen.
3. Raise the machine by pressing the *Raise (Left)* pushbutton on the control grip until the blade clears the pavement.
4. Place the speed control lever in the *STOP* position.
5. Turn the ignition switch to the *START* position until the engine starts, then release the switch. The key will return to the *ON* position.
6. Take the speed control lever out of the *STOP* position and slowly push it forward to move the machine forward, or to the rear to move the machine in reverse.

NOTE: The machine's speed will increase as the lever is moved farther in either the forward or reverse direction.

7. To stop the forward or reverse motion, place the speed control lever in the mid-position and/or into the *STOP* position.

Moving the Machine with the Engine Off

1. Turn the ignition switch to the *ON* position.
2. Raise the machine by pressing the *Raise (Left)* pushbutton on the control grip until the blade clears the pavement.
3. Place the speed control lever in the *STOP* position.
4. Turn the free wheel switch (located on the top of the left side control box assembly) to the *ON* position.

WARNING

Do not turn on the free wheel switch or attempt to manually push the machine while it is on a grade or slope. The operator could lose control of the machine causing serious injury to the operator or damage to the machine.

WARNING

Do not tow the machine when the free wheel switch is on. This could result in damage to the transmission

5. The machine can now be moved manually by standing in the operator's position and pushing the saw while keeping a firm grip on the handlebars.

Bogie Wheel

A bogie wheel is provided on the rear of the saw to assist with maneuvering the saw while it is in the fully raised position. There are two positions that the wheel will normally operate in:

- Locked sideways motion
- Free wheel motion

Bogie Wheel - Locked Sideways Motion

To lock the wheel for side to side movement:

1. Fully pull the ring on the detent pin.
2. Rotate the pin until the ring is vertical to the ground.
3. Rotate the wheel to either the right or left side position.
4. Release the pin in the locking slot of the pin assembly.



Bogie Wheel – Locked Sideways Position

Bogie Wheel - Free Wheel Motion

To unlock the bogie wheel and allow it to move freely:

1. Fully pull the ring on the detent pin.
2. Rotate the pin until the ring is horizontal to the ground.
3. Release the pin in the locked open slot of the pin assembly.

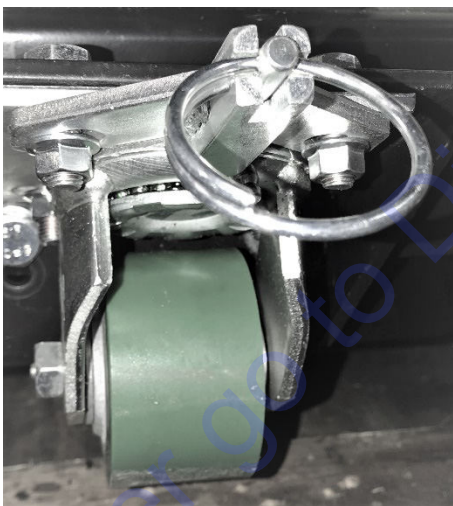

Bogie Wheel – Locked in Free Motion Position

WARNING

Keep feet clear. When the saw is raised on any inclined surface, the bogie wheel must be locked in a perpendicular position (3 or 9 o'clock) to the rear wheels to prevent the saw from rolling towards or away from the operator.

Fuel System

WARNING

Always use caution when refueling. DO NOT operate the saw with a fuel leak. DO NOT fuel the saw with the engine running. DO NOT smoke or expose fuel to open flames when filling the fuel tank or working with fuel.



CAUTION

Clean up any spilled fuel prior to starting the engine. Fuel may seep out from the fuel cap vent (applicable models) when raising the saw if the fuel tank is overfilled.

Adding Fuel

1. Lower the saw to level the frame.
2. Turn off the engine and let the saw cool down.
3. Remove the fuel tank cap.
4. Fill the fuel tank with ultra-low sulfur diesel fuel only. DO NOT overfill the tank for expansion purposes. Refer to the engine manual for additional information.
5. Replace the fuel tank cap and secure.

Blade Guard

WARNING

DO NOT operate the saw with the blade guard raised or removed. DO NOT remove the blade guard with the engine running. Blade exposure should not exceed 180° while cutting.

Always pivot the front of the blade guard 180° (fully upward) so the guard does not swing down unexpectedly, which may cause serious injuries.



Always secure the pivoted section of the blade guard using the detent pin (guards 26" and up).

When pivoting the front of the blade guard, raise/lower it cautiously and slowly to avoid serious injuries.

The blade guard shields the blade and must always be in place when operating the saw. Blade guards generally stay in place at all times, except for when changing to another guard size or when using the guard on the opposite side of the saw. Regularly inspect the blade guard, the guard post assembly and water tubes. Clean, repair, or replace dirty or damaged components immediately.

NOTE: Always use a guard size that matches the blade size. Refer to Appendix C.

Installing the Blade Guard

Always install the blade guard with the blade off the saw.

1. Holding the blade guard handle, face the front of the blade guard forward and fit the tapered mount on the side of the guard onto the tapered mount on the frame.



Frame Base Tapered Mount

2. Insert the lock pin through the hole on the tapered frame mount to secure the guard.
3. For guards 36" and larger, place a lock washer and then a flat washer onto the blade guard screw. Fit the screw through the slot near the back of the guard and through the hole on the frame base, and secure the guard to the frame using the provided wrench.
4. Connect the water supply hose to the blade guard.

NOTE: For 42" and larger blade guards there is a guard post assembly that can be used to stabilize the guard during operation. The following steps outline the connection process:

1. Attach one end of the quick disconnect rod to the guard post using the spring activated ball joint quick disconnect and the ball stud located on the guard post.
2. Attach the other spring activated ball joint quick disconnect to the ball stud on the blade guard.

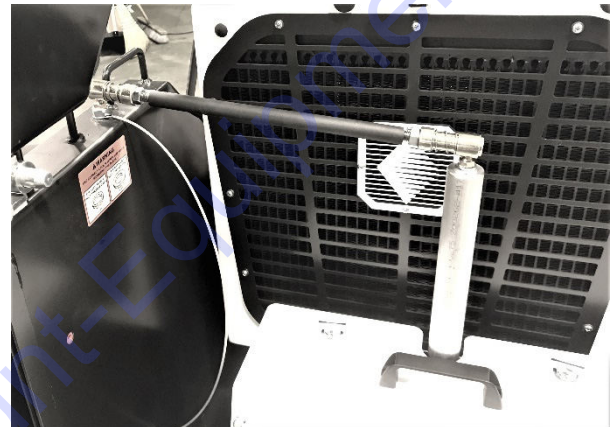

Guard Post Assembly

Removing the Blade Guard

Always remove the blade guard with the blade off the saw.

! WARNING

When removing a guard 48" or larger, use a hoist to avoid serious injury.

1. Disconnect the water supply hose from the blade guard.
2. Remove the rear bolt from the blade guard and frame base.
3. Remove the lock pin from the tapered frame mount.
4. If the guard post is attached, disconnect it from the blade guard.
5. Use the handle on the blade guard to rock the guard back and forth while lifting the guard off the tapered frame mount.

Slurry Shield

A slurry shield is provided on the right rear side of the saw. The shield can be flip down while cutting to minimize slurry back spray or flip up flush against the upright when not in use.



Slurry Shield

Flange Guard

Install the flange guard over the blade flange that is not in use.

Installing the Flange Guard

1. Fit the tapered mount on the back of the flange guard onto the tapered mount on the frame.
2. Insert the lock pin through the hole on the tapered frame mount to secure the guard.



Flange Guard Installed

Removing the Flange Guard

1. Remove the lock pin from the tapered frame mount.
2. Remove the flange guard from the tapered frame mount.

Diamond Blades



WARNING

DO NOT exceed the blade's maximum recommended speed when cutting.

Excessive blade speeds can cause blade breakage, resulting in serious injuries and/or death.

DO NOT use damaged blades when cutting to avoid harming yourself, others, or the saw.



Using the proper blade (size and type) preserves the blade and improves efficiency, resulting in lower costs. Refer to the Association of Equipment Manufacturers (AEM) safety brochure for diamond blades and www.discount-equipment.com for additional blade information.

Inspecting the Blade

Inspect each blade prior to installation and discard all damaged blades. Inspect the blades for:

- Cracks, nicks, and dents
- A damaged/deformed arbor (center hole)
- Darkness/discoloration near edge of blade
- A deformed blade circumference
- Segment loss/cracks
- Core wear
- Bending
- Uneven side-widths

Blade Speed

Refer to the CC9074 Deep Cut RPM Chart, located in Appendix C at the end of this manual, the blade, or the blade packaging information for the recommended blade speeds when cutting. DO NOT exceed the maximum recommended blade speed. DO NOT use a blade for cutting that requires a lower speed than the minimum blade shaft speed.

Wrench

Use the wrench provided when installing or removing a blade. Apply force to the opposite end of the wrench and tighten the blade shaft bolt/screw to 125 ft-lb (170 Nm) minimum to secure the outer flange and blade.

OPERATING

NOTE: 125 ft-lb is equivalent to applying 125 pounds at the end of a 12" wrench.

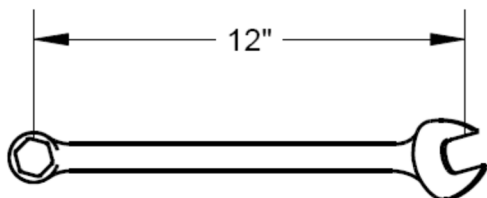

Wrench

Installing the Blade

WARNING

DO NOT install a blade with the engine running.

Failure to properly secure the outer flange and blade may cause parts to loosen or fall off the saw, resulting in serious injuries or death!

DO NOT pivot the front of the blade guard up or down when installing very large blades. Attempting to pivot the front of a heavy guard when the guard is positioned higher up for blade installation makes the guard difficult to lift and/or lower. In this situation, remove the blade guard front instead of pivoting it.

Always secure the pivoted section of the blade guard using the detent pin.



CAUTION

Wear gloves and be alert to the surrounding environment when handling blades.

NOTE: When changing blade sizes, ensure to adjust and/or change all necessary belt drive components in accordance with the CC9074 Parts List.

The blade can be installed on the right or left side of the saw. Install the blade on the side preferred or most appropriate for the cutting task.

1. Select a blade size and type. Remember to check the blade for damages and discard as necessary.
2. Remove the detent pin from the front guard and pivot the front of the blade guard 180° (fully upward) to gain access to the blade flanges. For larger, heavier guards that are

positioned too high up and are unsafe to pivot, remove the lock nut and bolt from the center of the guard hinge. Remove the front of the guard.

NOTE: Have a second trained operator hold the guard in place while removing the hinge bolt and nut.



Detent Pin

3. On the pivoted guards, insert the detent pin through the interlocking barrels on the top of the guard to secure the front of the guard as shown above.

WARNING

Failure to fully pivot and secure the front of the guard may cause serious injuries.

4. Remove the blade shaft bolt using the provided wrench.

NOTE: Clockwise loosens on right side, counterclockwise loosens on left side (when viewed from the operating position) using the provided wrench.

5. Carefully remove the outer flange. Inspect the flange assembly and clean or replace dirty/damaged components.
6. Align and fit the outer flange and flange pin through the blade.
7. Place the blade and outer flange into the alignment hole and blade arbor of the inner flange. For large blades, carefully roll the blade up to the inner flange. Adjust the height of the saw to align the flange and blade arbor.

NOTE: Point the arrow stamped on the blade in the direction of the blade shaft's rotation.

NOTE: The outer flange should fit snug with the blade, inner flange, and blade shaft.

8. Slightly rotate the outer flange and blade in the opposite direction of the blade rotation to eliminate backlash (looseness) between parts.
9. Place the wedge lock washer onto the blade shaft bolt and insert the bolt into the blade shaft through the center of the outer flange.
10. Tighten the bolt by hand. Slowly lower the saw, if necessary, until the blade just touches the ground.
11. Tighten the bolt again, using the wrench, to 125 ft-lb (170 Nm) minimum to secure the outer flange and blade.
12. Remove the detent pin from the guard hinge and pivot the front of the guard down over the blade to secure.
13. If replacing the front of the guard, fit the front and back of the blade guard together. Place the bolt through the center of the guard hinge and tighten the lock nut to the other end of the hinge bolt to secure the guard together.

NOTE: Have a second trained operator hold the guard in place while replacing the hinge bolt and nut.

Removing the Blade



CAUTION



DO NOT remove a blade with the engine running.

DO NOT pivot the front of the blade guard up or down when removing very large blades. Attempting to pivot the front of a heavy guard when the guard is positioned higher up for blade removal makes the guard difficult to lift and/or lower. In this situation, remove the blade guard front instead of pivoting it.

Always secure the pivoted section of the blade guard using the detent pin (guards 26" and up).

1. Remove the detent pin from the front guard and pivot the front of the blade guard 180° (fully upward) to gain access to the blade. For guards 48" or larger, remove the lock nut and bolt from the center of the guard hinge. Remove the front of the guard.

NOTE: Have a second trained operator hold the guard in place while removing the hinge bolt and nut.

2. On the pivoted guards, insert the detent pin through the interlocking barrels on the top of the guard to secure the front of the guard.



WARNING

Failure to fully pivot and secure the front of the guard may cause serious injuries.

3. Slowly lower the saw, if necessary, until the blade just touches the ground.
4. Remove the blade shaft bolt using the provided wrench.
5. Carefully remove the outer flange and blade. Place the blade in an appropriate storage location.

NOTE: If the outer flange is difficult to remove, tighten screws into two of the holes on the outer flange to help separate the outer flange from the blade.

6. Inspect the flange assembly and clean or replace dirty/damaged components.
7. Carefully fit the outer flange back into the inner flange and blade shaft.
8. Place the wedge lock washer onto the blade shaft bolt and insert the bolt into the blade shaft through the center of the outer flange.
9. Retighten the blade shaft bolt to secure the flanges.
10. Remove the detent pin (guards 26" and up) from the guard hinge and pivot the front of the guard down over the blade flanges to secure.
11. If replacing the front of the guard, fit the front and back of the blade guard together. Place the bolt through the center of the guard hinge and tighten the lock nut to the other end of the hinge screw to secure the guard together.

NOTE: Have a second trained operator hold the guard in place while replacing the hinge bolt and nut.

Optional Blade Arbor Configurations

Three additional blade arbor configurations are available on the CC9074DK Deep Cut saw.

- Louie Arbor
- Storm Arbor
- Roger Arbor

The “Louie” arbor configuration is provided on all flanges 7” and larger. It consists of a series of four dowel pin holes located on a Ø3” bolt circle around the blade flange bolt. There are eight dowel pins provided in the tool storage case located on the fuel tank to use for this option.

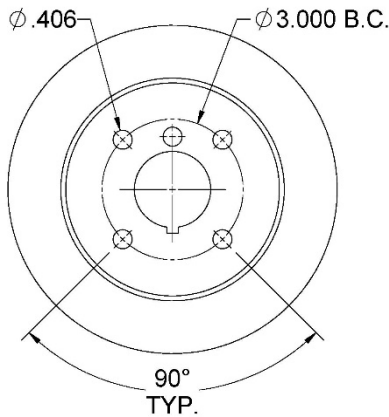

“Louie Arbor”

The “Storm” arbor configuration is provided on all flanges 8” and larger. It consists of six $3/8$ ”-16 bolt holes located on a $\phi 4-1/2$ ” bolt circle around the blade flange bolt. There are twelve $3/8$ ”-16 flat head cap screws and a hex key provided in the tool storage case located on the fuel tank to use for this option.

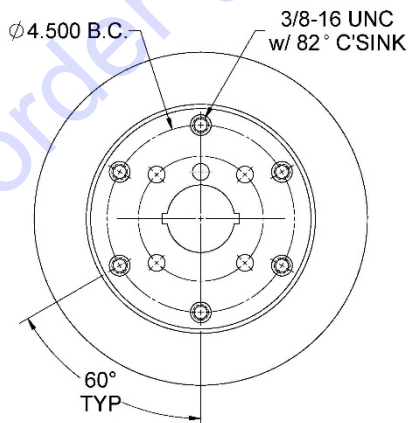

“Storm Arbor”

The “Roger” arbor configuration is provided on all flanges 9” and larger. It is the same as the “Storm” arbor except, the $3/8$ ”-16 holes are located on a $\phi 6$ ” bolt circle around the blade flange bolt. There are twelve $3/8$ ”-16 flat head cap screws and a hex key provided in the tool storage case located on the fuel tank to use for this option.

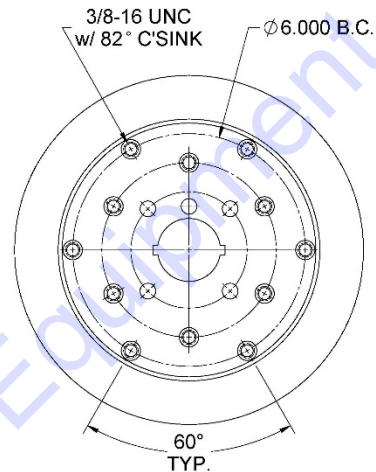

“Roger Arbor”

When using any of the optional blade arbor configurations, a $\phi 1$ ” arbor pin is available to assist with installation of the blade. The arbor pin is provided in the tool storage case located on the fuel tank. The arbor pin is placed into the center blade shaft hole and the blade is placed on it. The pin will allow the operator to align the blade while securing with the screws using the optional “Storm” or “Roger” arbor configurations. To remove the arbor pin, thread the flange bolt halfway into the pin and manually pull the pin out.

Engine

⚠ WARNING

Operate the saw in well-ventilated areas. Concentrated engine exhaust can cause loss of consciousness and/or death.

DO NOT touch the engine/muffler with the engine running, and always let them cool down prior to touching or servicing the saw.

DO NOT leave the saw unattended while the engine is running.



Tasks Prior to Starting the Engine

Complete the tasks listed below prior to starting the engine to ensure a safe start:

- Check fluids and fill to appropriate levels.
- Turn off controls and switches.
- Remove tools from area.

The engine **will not** start unless the following tasks are completed:

- Place speed control lever to the *STOP/PARK* position.
- Pull up emergency stop button.
- All emergency stop triggers are cleared:
 - 1) E-Stop active
 - 2) Low coolant level

Starting the Engine

Notice: In an emergency, press the emergency stop button to immediately stop the engine and any saw movement!

1. Insert the key into the ignition and turn it to the *ON* position and wait for the display screen to energize.

NOTE: While the display screen is energizing, the glow plug is preheating. If the glow plug requires more preheat time the following pop-up message will appear: "Wait to start, preheating".

2. Once the display screen is energized and there are no pop-up messages, turn the key to the *START* position and release when the engine starts.

NOTE: If the engine does not start within 10 seconds, turn off the key and try again approximately 30 seconds later. Refer to the engine manual for troubleshooting recommendations after several failed attempts.

3. Let the engine warm up. Check all warning lights and turn off the engine immediately if there are any problems prior to operating the saw.
4. Increase/decrease the engine/blade speed by pressing the throttle switch up or down as needed.

Stopping the Engine



DO NOT leave the saw unattended until the engine is off and the blade has stopped spinning.

1. Place the speed control lever to the *STOP* position and raise the blade from the cut.
2. Turn off all controls, switches, and water.
3. Decrease the engine speed to idle for five minutes to cool down the engine after full load operation.
4. Turn the ignition key to the *STOP* position and remove the key.

Control Panel Display

Normal Operation

The control panel display can either open for normal operation or closed when the machine is not being operated. Both the opening and closing of the control panel display is done by manual rotation.

To manually rotate the control panel display open, complete the following steps:

1. Pull the mini spring plunger from the side of the control display panel and rotate the knob until it locks in place.
2. Manually rotate the display screen to the open position.
3. Rotate the spring plunger knob until it inserts into the hole on the display panel.

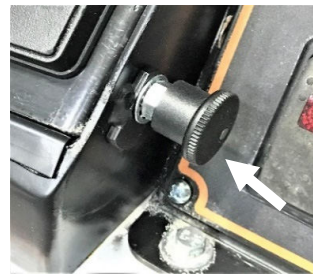

Mini Spring Plunger

To manually rotate the control panel display closed, complete the following steps:

1. Pull the mini spring plunger from the side of the control display panel and rotate the knob until it locks in place.
2. Manually rotate the control panel display to the shut position.
3. Rotate the mini spring plunger until it inserts into the hole on the display panel.

TO PURCHASE THIS PRODUCT PLEASE CONTACT US



**Equipment Financing and
Extended Warranties Available**



**Discount-Equipment.com is your online resource for
commercial and industrial quality parts and equipment sales.**

561-964-4949

visit us on line @ www.discount-equipment.com

Select an option below to find your Equipment

Search by Manufacturer

Search by Product Type

Request a Quote

We sell worldwide for the brands: Genie, Terex, JLG, MultiQuip, Mikasa, Essick, Whiteman, Mayco, Toro Stone, Diamond Products, Generac Magnum, Airman, Haulotte, Barreto, Power Blanket, Nifty Lift, Atlas Copco, Chicago Pneumatic, Allmand, Miller Curber, Skyjack, Lull, Skytrak, Tsurumi, Husquvarna Target, Stow, Wacker, Sakai, Mi-T-M, Sullair, Basic, Dynapac, MBW, Weber, Bartell, Bennar Newman, Haulotte, Ditch Runner, Menegotti, Morrison, Contec, Buddy, Crown, Edco, Wyco, Bomag, Laymor, EZ Trench, Bil-Jax, F.S. Curtis, Gehl Pavers, Heli, Honda, ICS/PowerGrit, IHI, Partner, Imer, Clipper, MMD, Koshin, Rice, CH&E, General Equipment, Amida, Coleman, NAC, Gradall, Square Shooter, Kent, Stanley, Tamco, Toku, Hatz, Kohler, Robin, Wisconsin, Northrock, Oztec, Toker TK, Rol-Air, APT, Wylie, Ingersoll Rand / Doosan, Innovatech, Con X, Ammann, Mecalac, Makinex, Smith Surface Prep, Small Line, Wanco, Yanmar

Water Supply

The water supply directs cooling water to the fuel cooler and blade and minimizes dust when cutting.

Using the Water Supply

The saw is equipped with an “Automatic Water System” (AWS). A solenoid valve in the system works in conjunction with the “Zero Blade” option on the control panel. When the saw blade is “zeroed” at the pavement surface, the solenoid valve will allow water to flow when the blade is lowered into a cut. When the blade is raised out of the cut and the blade passes the “zero” point, the water flow will automatically shut off.

1. Connect the water source hose to the water supply hose connection on the rear of the saw.



Water Supply Hose Connection

2. Connect water supply hose (72”) extending from the front of the upright assembly to the manifold on the blade guard.
3. Move the water valve lever on the control panel forward to start the flow of water to the AWS. When finished cutting, shut off water supply to the blade guard by pulling the valve to the OFF position, shut off water supply at source and remove source hose from the saw.

NOTE: When using AWS, adjust the water valve lever to meter the water flow. AWS will automatically turn the water on/off when the blade enters or exits the cut.



Water Control Valve

4. During cold weather, drain water from the lines in accordance with the maintenance section of this manual.

Water Pump

The water pump (optional item) directs water from the water source hose to the saw blade.

1. Ensure all water supply lines are connected.
2. Ensure that the water valve located on the control panel is in the “OFF” position.
3. Turn on the water pump switch to start the pump. DO NOT start the water pump until just before cutting. DO NOT leave the water pump on when the cutting task is complete to avoid draining the battery.
4. Push the water valve to the “ON” position.
5. When cutting is complete, move the water valve to the “OFF” position.
6. Turn off the water pump switch OFF to stop the pump.

Cutting

Cutting Guides

Use the cutting guides as needed to help follow the cutting line. Always check the cutting guides for proper alignment with the blade prior to cutting.

Adjusting the Front Pointer

1. Remove the lanyard from the cable cleat.
2. Lower the front pointer frame to the ground.
3. Loosen both front pointer frame screws.
4. Divide an 8–10 ft. piece of string in half.
5. Place the looped end of string into a gullet on the backside of the blade.

6. Place one string line up against the backside of the blade and one string line up against the front side of the blade. Holding the string ends in one hand, tension the lines out toward the front pointer rod.

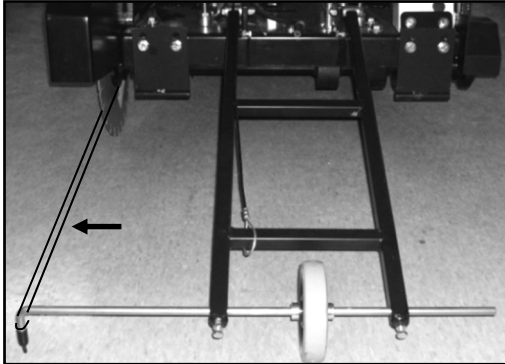

Tensioned String Line

7. Adjust the pointer rod to place the tip between the tensioned string lines.
8. Retighten both front pointer frame screws.
9. Lift the frame off the ground when finished.
10. Tension the lanyard and secure it to the cable cleat.

Adjusting the Rear Pointer(s)

1. Loosen the rear pointer nut and screw on the back of the frame base.
2. Adjust the orientation/extension of the rear pointer rod and retighten the screw and nut to secure.

Straight Line Cutting

⚠ WARNING

DO NOT expose yourself or anyone else to the direct line of the blade when operating the saw.

The direct work area should not contain buried or embedded electrical, gas, or water lines that could be damaged and/or cause personal injury while cutting.

NOTE: Always raise the blade to provide proper clearance between the blade and the pavement when maneuvering the saw.

Helpful Hints Prior to Cutting

Keep the following in mind for better efficiency while cutting:

- Use just enough handle pressure to guide the saw down the cutting line. DO NOT forcibly direct (twist) the saw from side to side when cutting. DO NOT jam, cock, or wedge the blade in a cut.
- Moving too quickly when cutting may stall the saw, or may cause the blade to climb out from the cut. If the saw stalls while cutting, put the saw in neutral and raise the blade from the cut to restart the engine.
- Avoid sawing excessively deep to preserve the blade and reduce sawing costs.
- DO NOT lower the blade too quickly or move the saw forward too quickly when finishing a partial-cut to avoid forcing the blade into the concrete.
- Always have a proper water flow when cutting for maximum blade efficiency. Using too much water when cutting will make the slurry look clear. Not using enough water will make the slurry look thick and pasty.
- Refer to the Diamond Products' Guide for Professional Concrete Cutters for additional cutting tips and information.

Tasks Prior to Cutting

Complete the following tasks prior to cutting:

- Ensure the blade size is correct for the belt drive configuration.
- Align the cutting guide(s) with the blade.
- Clearly mark the cutting line.
- Turn off all electricity, gas, and water around the direct work area.

Making a Cut without Using the Blade Depth Stop

1. Align the blade and cutting guide(s) with the cut line.
2. Turn on the water and adjust the water flow by pushing the water valve handle forward.
3. Start the engine and allow to idle briefly before going to full power.
4. Lower the blade to just above the cutting surface and zero the blade by pressing the "Zero Blade" button on the display panel.

5. Slowly lower the blade into the surface to no more than 2" deep. Make the initial pass across the entire cutting line using the most effective travel speed. If the blade is coming up out of the cut, decrease travel speed and/or feed depth. **DO NOT CUT FULL DEPTH IN ONE PASS.**
6. If you are cutting more than 2" deep, you can finish the job in less time and effort by step cutting in 2" increments. Cut a 2" depth on the initial pass, 4" depth on the second and so on. On repeated passes, the blade will tend to follow the previous cut.
7. Raise the blade out of the cut and reposition the saw at the start of the cut line. DO NOT move backwards with the blade in a previous cut.
8. At the start of the cut line, lower the blade back into the cut and make a second, deeper pass across the entire cutting line.
9. Continue the step-cut process to reach the maximum depth. DO NOT cut any deeper than required.
6. If you are cutting more than 2" deep, you can finish the job in less time and effort by step cutting in 2" increments. Cut a 2" depth on the initial pass, 4" depth on the second and so on. On repeated passes, the blade will tend to follow the previous cut.
7. Raise the blade out of the cut and reposition the saw at the start of the cut. DO NOT move backwards with the blade in a previous cut.
8. Press the "Clear Depth Stop" button on the display panel to reset the depth stop to zero.
9. Slowly lower the blade into the cut until the desired depth is reached and then press the "Set Depth Stop" button on the control panel.
10. Continue the step-cut process using the depth stop to reach the maximum depth. DO NOT cut any deeper than required.

Continuing a Partial-Cut

1. Maneuver the saw to the desired location.
2. Align the blade with the previous cut and slowly lower the blade back into the concrete. Use extreme caution to make sure the blade is perfectly aligned within the cut. DO NOT continue cutting until the blade is aligned within the cut!
3. Continue the step-cut process (using the blade depth stop if preferred) to reach the maximum depth. DO NOT cut any deeper than required.

Finishing a Cut

1. Place the speed control lever at *Stop*.
2. Raise the blade from the cut (provide proper ground clearance).
3. Turn off the water control valve.
4. Always operate the engine briefly at idle speed before stopping it.

Making a Cut Using the Blade Depth Stop

1. Align the blade and cutting guide(s) with the cut line.
2. Turn on the water and adjust the water flow by pushing the water valve handle forward.
3. Start the engine and allow to idle briefly before going to full power.
4. Lower the blade to just above the cutting surface and zero the blade by pressing the "Zero Blade" button on the display panel.
5. Slowly lower the blade into the surface to no more than 2" deep and press the "Set Depth Stop" button on the display panel. Make the initial pass across the entire cutting line using the most effective travel speed. If the blade is coming up out of the cut, decrease travel speed and/or feed depth. **DO NOT CUT FULL DEPTH IN ONE PASS.**

OPERATING

Drive Alignment

Adjusting the Drive Alignment

Adjust the rear axle when the saw's drive alignment is off (saw will not cut in a straight line).

1. Turn the tap bolt clockwise using the provided wrench to adjust the drive alignment toward the right, or counterclockwise to adjust the drive alignment toward the left.



Adjustment Bolt

Footrest

Use the footrest, if desired, to add body weight to the rear of the saw and improve the rear wheel traction when cutting.



Footrest

Weight Kit (Optional)

The weight kit (optional) adds 200 Lbs. to the saw to improve the rear wheel traction when cutting. (Refer to the CC9074 Deep Cut Parts List manual)

NOTE: The weight kit is a standard feature on the 54" and 60" blade saw.

Spotlight

1. Loosen both spotlight bar lock knobs and slide the spotlight bar from side-to-side to adjust the length of the bar.
2. Tighten the lock knobs to secure.
3. Turn the spotlight switch on or off as needed for additional lighting.



Spotlight

LED Light Bar

1. Loosen both light bar bolts and adjust the light angle from 0° to 30° in the downward direction.
2. Tighten the bolts to secure.
3. Turn the light bar switch on or off as needed for additional area lighting.

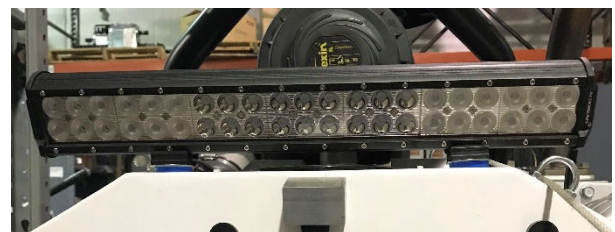

Light Bar

Tie-Downs

Use the tie-downs (two at the back and one at the front end of the saw) when securing the saw in a truck/trailer for transportation. DO NOT over-tighten a chain/rope to the front end tie-down, which may bend the frame and damage the saw

Maintenance

General

Failure to read and comply with the maintenance instructions provided in this manual prior to performing maintenance may result in serious injuries and/or death, and may harm the saw. DO NOT attempt to perform maintenance on the saw if you are not properly trained for it, or are not supervised by an experienced person.

Refer to the CC9074DK Parts List for additional information and part diagrams when performing maintenance tasks. Refer to the engine manual and manufacturer as the primary source for all safety, operations, and maintenance instructions for the engine. Contact Discount-equipment with any additional questions.

Remove all necessary guards and access panels prior to servicing the saw. Replace prior to operating.

Maintenance Tools

Tools critical for the maintenance of the machine are provided with the machine and located on the inside of the upright. A wrench holder tube is provided on the left hand side and contains ratcheting 15/16" wrench and a belt tensioning tool. A 3/8" hex head L-Key is provided on the right side of the upright.

Pre Maintenance Preparations

- Ensure the saw is in a safe area to conduct maintenance.
- Maintain proper cleanliness of the work area to minimize personnel injury or equipment damage.
- Ensure the saw is sufficiently cool to conduct any maintenance.
- Remove the cutting blade prior to starting any maintenance.
- Place the saw on a level surface with the engine turned off and the emergency stop activated.
- Ensure there is adequate lighting in the work area to ensure safety.
- Ensure all equipment and tools required for the maintenance task are staged and available for use.

- Prior to any maintenance being performed, know the locations of all safety equipment such as fire extinguishers, first aid kits, etc.
- All maintenance shall be performed by qualified personnel only.

Rear Cover Screen

The rear cover screen is a versatile component in regards to maintenance of the machine. It can be opened to gain access to components within the upright assembly. Or if additional access is required, it can be quickly removed.

Removal of Rear Cover Screen

1. Rotate the door latches on the cover screen clockwise and pull back on the screen.
2. When the screen is clear of obstructions, slide it to the right to release it from the lift off hinges.

Installing the Rear Cover Screen

1. Lower the cover screen down until the top and bottom half of the hinges align.
2. Slide the screen to the left to connect the hinge assemblies.
3. Push up on the screen and rotate the door latches counterclockwise to secure.

General Cleaning

The saw must be cleaned after each use and prior to conducting any maintenance. Ensure that the saw is cool prior to cleaning. Ensure affected electrical equipment is properly covered or de-energized and the display box is closed prior to cleaning with water or air.

Cleaning Techniques

Various cleaning options can be utilized depending on the type of cleaning required. High pressure washers and a mild detergent will work the best. Compressed air and low pressure water can also be utilized where required.



CAUTION

Care must be taken when using high pressure water and compressed air to conduct any maintenance or cleaning. High pressure water and compressed air can cause injury to personnel or damage to equipment if not used properly.

Radiator

Ensure that the radiator is cool prior to cleaning. Use compressed air to clean the radiator fins being careful not to damage the fins. A mild detergent with low pressure water can also be used to degrease the radiator.

NOTE: Damaged radiator fins can and will diminish the cooling capacity of the radiator.

Control Panel

Do not spray water on the control panel to clean. Use a damp cloth or compressed air to clean electrical components. Dry the control panel after cleaning.

Display Screen and Camera Lens

Do not spray water on the display screen or the camera lens to clean. Use a damp cloth to wipe it clean and dry the screen with a lint free cloth.

Engine

Use a mild detergent and water to clean the engine. Do not spray water forcefully on the engine to prevent damage to components.

NOTE: Do not spray water into the exhaust pipe or air filter.

Part Lubrication

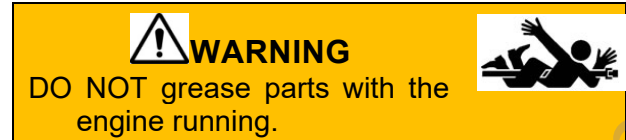

Lubricate all necessary parts on schedule for maximum saw efficiency. Occasionally lubricate controls, cables, hinges, latches, and linkages with a spray lubricant when movement becomes stiff and/or sluggish. Use one to two full pumps of NLGI No. 2 premium, lithium-based grease when lubricating all grease fittings.

NOTE: Use more grease on bearing grease fittings if they are too hot to touch after completing work.

Post Cleaning

- Lubricate the machine as required.
- Dry all electrical components using compressed air.
- Do not start the machine until it has had time to thoroughly dry.

MAINTENANCE

Service Schedule

The service schedule is based primarily on the standard operating time of the machine. The frequency of the maintenance tasks can be increased based on the working environments of the machine.

Task	Cycle						
	Daily	25 Hrs.	50 Hrs.	250 Hrs.	500 Hrs.	1000 Hrs.	1500 Hrs.
Visually inspect saw for damage and repair as necessary	X						
Wipe down and clean all components for dust, debris, and slurry	X						
Check that all safety guards are in place and in good operating condition	X						
Check for loose or frayed wiring. Repair/replace as necessary	X						
Check for loose nuts and bolts and retighten	X						
Inspect all hoses and clamps for damage, leaks, or looseness and repair/replace as necessary	X						
Check engine oil level	X						
Check fuel level	X						
Check hydraulic fluid level	X						
Check radiator coolant level	X						
Check and clean blade guard water spray tubes	X						
Lubricate blade shaft bearings (End of work day)	X						
Check air cleaner restriction indicator	X						
Inspect all belts for tension or wear and re-tension or replace as necessary		X					
Lubricate PTO bearings		X					
Drain water from fuel/water separator filter			X ¹				
Lubricate hydraulic cylinder pivot pin			X				
Lubricate front axle pivot bearings			X				
Lubricate jackshaft bearings			X				
Lubricate bogie wheel			X				
Clean air cleaner element				X ²			
Replace engine oil and filter				X ³			
Clean water inlet strainer				X			
Replace hydraulic oil and filter element					X ³		
Replace water separator filter					X ⁴		
Replace fuel filter					X		
Replace primary and safety air filters					X		
Replace radiator coolant						X	
Replace oil separator filter							X

1 - Service as required

2 - Clean more often if operating in dusty conditions

3 - Initially change at 50 operating hours

4 - Or 1 year whichever occurs first

Daily Service

Check Engine Oil Level

Prior to checking the engine oil level, ensure that there is no blade installed on the saw and that the saw frame is in a level position.

1. Remove the engine oil dipstick from the starter side of the engine. (Between the engine and saw upright assembly)



Engine Oil Dipstick

2. Check the oil level on the dipstick. The level should be between the two round marks.

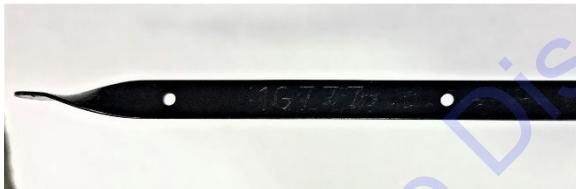

Engine Oil Level Indicators

3. If the level is low, remove the engine oil fill cap located on the left side of the saw just below and to the rear of the diesel particulate filter (DPF).



Engine Oil Fill Cap

4. Add oil until the level is correct.
5. Replace the engine oil fill cap.

Check Fuel Level

Prior to checking the fuel level, ensure that there is no blade installed on the saw and that the saw frame is in a level position.

1. With the ignition switch in the ON position, scroll through the display until the Home screen appears. The fuel level gauge will be displayed in the lower center of the control display.
2. If fuel level is low, remove the fuel tank fill cap located on the left side of the upright assembly.



Fuel Tank Fill Cap

3. Fill the fuel tank with ultra-low sulfur diesel fuel only.

Hydraulic System

! WARNING

Always place a piece of cardboard or paper up against hydraulic components, or use a leak detection fluid to check for hydraulic fluid leaks. Keep all body parts away from leaks and/or areas that may eject hydraulic fluid. Pressurized hydraulic fluid can penetrate the skin, causing serious injuries. Seek medical attention immediately!



Always make sure any hydraulic components being serviced are not supporting the weight of other saw components. If a particular component is under pressure when connections points are loosened, oil may spray out forcefully.

Inspect all hydraulic hoses and fittings daily for leaks. Remember to use cardboard or a piece of paper when checking for leaks and replace damaged components immediately.

Check Hydraulic Fluid Level for Hydro Pump Assembly

Prior to checking the hydraulic fluid level, ensure that there is no blade installed on the saw and the saw frame is in a level position.

1. Check the hydro pump reservoir tank level.

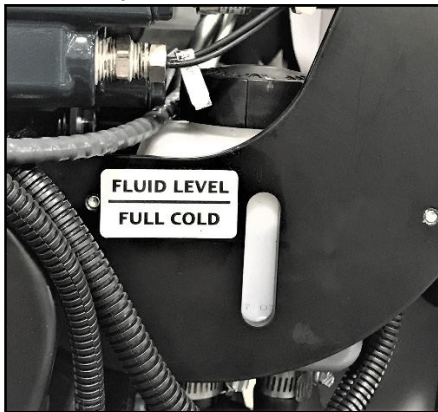

Hydro Pump Reservoir Tank

2. If the level is below the “Cold Full” line then, remove the reservoir tank cap.
3. Add SAE 15W-40 oil to the reservoir tank fill line. DO NOT overfill as fluid will leak out from the reservoir cap.
4. Replace the cap and tighten to secure.

Adding Fluid to the Hydraulic Lift Pump



Hydraulic Lift Pump Breather Cap

Check the fluid daily and add fluid to the pump as necessary.

1. Lower the saw to level the frame.
2. Unlatch and lower the rear cover screen.
3. Remove the hydraulic pump breather cap.
4. Remove the hydraulic pump fill access plug on the upper right side of the upright assembly.



Hydraulic Pump Fill Access Cover

5. Using a funnel with flexible hose, add SAE15W-40 oil or an equivalent to just below where the fill port extends into the hydraulic pump. Do not overfill, as this will cause oil leakage through the breather cap when raising the saw.
6. Replace the breather cap and retighten to secure.
7. Close the rear cover screen and latch to secure.
8. Replace the hydraulic pump fill access plug.

Check Radiator Coolant Level

Prior to checking the radiator coolant level, ensure that there is no blade installed on the saw and the saw frame is in a level position.

1. Remove the radiator access cover plate by unscrewing it from the top of the front radiator shroud.



Radiator Access Cover



CAUTION

Remove the radiator cap only when it feels cool to the touch, and always open it slowly to relieve any built up pressure.

2. Slowly remove the radiator cap. Check that the coolant level is up to the overflow hole inside the filler neck.
3. If it is below the filler neck, add a 50/50 mix of water and antifreeze until it reaches that point.
4. Replace the radiator cap and retighten to secure.
5. Re-install the radiator access cover plate.

Check and Clean Blade Guard Spray Tubes

1. Raise the front of the blade guard and pin it in place using the hinge detent pin.
2. Connect a water supply source to the water manifold on the blade guard.
3. Turn the water supply on and verify that water is spraying from all spray tube holes.
4. If any clogged holes are detected, shut off water source and dislodge any debris that is clogging the hole(s).
5. Turn water on to verify all spray tubes are clear.
6. Shut off water supply and disconnect from the water manifold.
7. Pull the detent pin on the blade guard hinge and lower the front of the guard back down.
8. Replace detent pin.

Lubricate the Blade Shaft Bearings

At the end of each work day, lubricate the three front blade shaft bearings.

1. Unlatch the jackshaft guard and lower it down to expose the front of the frame base assembly.
2. Add no more than two pumps of bearing grease into each of the three blade shaft bearing grease fittings.

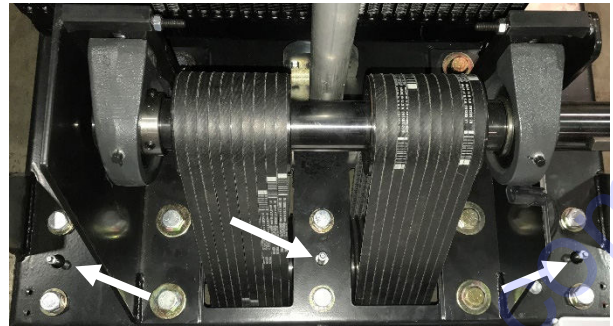

Grease Fittings – Blade Shaft Bearings

3. Raise the jackshaft cover back into position and latch to secure.

Check Air Cleaner Restriction Indicator

1. Check the restriction indicator located on the outlet to the air cleaner.
2. If the indicator is red, clean the air cleaner primary filter in accordance with the “Cleaning the Outer Primary Filter” procedure.



Restriction Indicator

3. Ensure the rubber dust ejector boot valve is clean by pressing inward on both sides of the ejector boot near the valve opening to release dust and debris, and clean the valve opening as necessary.



Rubber Dust Ejector Boot

25 Hour Service

Inspect Belts

Inspect all belts daily for tension or wear. Re-tension or replace as required in accordance with the “Jackshaft Drive Belts” and “Blade Drive Belts” sections located in the “Regular Maintenance” section of this manual.

Lubricate the PTO

1. Swing the cover plate on the belt guard away enough to expose the front face of the PTO.
2. Add three pumps of grease to the PTO using the grease fitting located on the PTO face.

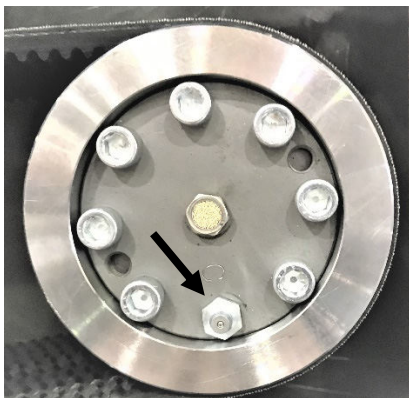

PTO Grease Fitting

50 Hour Service

Drain the Fuel/Water Separator Filter

Inspect the fuel/water separator and drain as necessary. The unit is located on the left side of the saw near the engine starter on the CC9074DK.

1. Locate the drainage cap on the underside of the fuel/water separator.
2. Loosen the cap only enough to allow water to be discharged from drainage tube. *Do not remove the cap.*

3. When no more water is discharged, re-tighten the drainage cap.



Fuel/Water Separator

Lubricate the Hydraulic Cylinder Pivot Pin

1. Ensure the saw is parallel to the ground.
2. Add one pump of grease into the hydraulic cylinder pivot pin grease fitting located at the back of the front axle assembly.

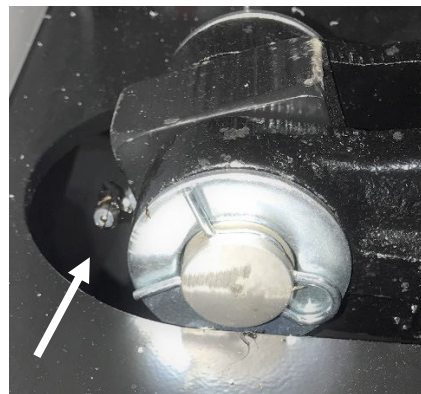

Pivot Pin Grease Fitting

Lubricate Front Axle Bearings

1. Raise the saw to the full up position.
2. Add no more than two pumps of grease to each of the two front axle bearings grease fittings located under the frame base on both the left and right side.

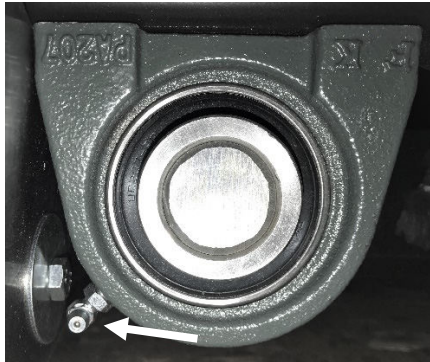

Front Axle Bearing Grease Fitting

Lubricate the Jackshaft Bearings

1. Unlatch the jackshaft guard and lower it down to expose the front of the frame base assembly.
2. Add no more than two pumps of bearing grease into each of the two jackshaft bearing grease fittings.

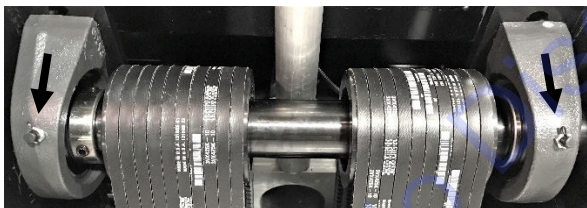

Jackshaft Bearing Grease Fittings

3. Raise the jackshaft cover back into position and latch to secure.

Lubricate the Bogie Wheel

The bogie wheel has two locations for adding grease. The first is on the wheel axle located on the side of the wheel. The second location is on the caster bracket on the back of the wheel.

1. Add one pump of grease to both grease fittings located on the bogie wheel.



Bogie Wheel Grease Fittings

250 Hour Service

Clean the Air Cleaner Element

⚠ WARNING
DO NOT operate the saw without the filter installed

1. Empty the rubber dust ejector boot by pressing inward on both sides of the ejector boot. This will release any large particles of dust or dirt.
2. Pull out the tab on the air cleaner housing end cover.



End Cover Tab

3. Turn the end cover counter-clockwise to unlock and pull the cover away from the main air cleaner housing.
4. Pull the outer primary filter out of the air cleaner and inspect it for damages. Replace as necessary. To protect the engine, DO NOT pull out the inner safety filter.



Outer Primary Filter

5. Move away from the saw and clean the filter from the inside out. Use dry compressed air to clean the filter (a maximum of 30 psi or 2.1 bar) and rotate it while cleaning.
6. Inspect the inside of the air cleaner housing and the end cover for debris, and wipe them down with a damp cloth as necessary. DO NOT use compressed air to blow out the inside of the air cleaner housing. DO NOT allow dust to enter the air intake tube when cleaning or replacing parts.
7. Place the filter into the air cleaner housing (over the inner safety filter) and gently push the filter into the unit until it feels secure.
8. Place the end cover tightly up against the ridge at the end of the air cleaner housing.
9. Turn the end cover clockwise to lock the cover onto the air cleaner housing, making sure the dust ejector boot is in the vertical position.
10. Push the tab in on the air cleaner housing end cover to secure.
11. Press the restriction indicator reset button on the restriction indicator after the unit has been cleaned.

Replace Engine Oil and Filter

- Refer to Engine Operator's Manual for oil specifications and capacities.
- Refer to Engine Manual for Oil Filter Specifications.
- Be sure the engine is turned off and sufficiently cooled down prior to draining the engine oil



Oil Drain Hose

1. Level saw frame and place drain pan beneath drain hose located on the right side of the saw.

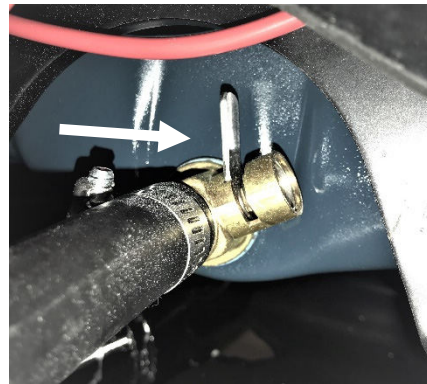

Oil Drain Valve

2. Remove red plastic drain plug and open drain valve on side of oil pan.
3. Drain oil completely
4. Remove the oil filter located on the starter side of the engine using a filter wrench.
5. Dispose of the oil and filter in accordance with city, state and federal regulations.
6. Shut oil drain valve and replace red plastic drain plug.
7. Install a new filter on the engine. Lubricate the rubber gasket on the filter with a film of oil prior to installing it.

8. Tighten the filter only hand tight.
9. Remove the engine oil fill cap.



Engine Oil Fill Cap

10. Place a funnel with a flexible hose end into the oil fill tube on the engine.
11. Add oil in accordance with the manufacturer's specifications and capacities.
12. Replace the engine oil fill cap.

500 Hour Service

Replace Hydraulic Oil and Filter

1. Level the saw and place a drain pan under the hydraulic filter located on the left side of the engine.
2. Loosen the hose clamp on the inlet hose to the filter head.



Hydraulic Oil Filter and Hose Clamp

3. Remove the hose and allow the hydraulic fluid to drain into the drain pan.

4. Remove the filter using a filter wrench.
5. Dispose of the oil and filter in accordance with city, state and federal regulations.
6. Completely fill the new filter with SAE 15W-40 oil and add a thin film of oil to the gasket on the filter.
7. Screw the new filter into the filter head until the gasket is seated. Then turn the filter 1/2 turn by hand to secure.
8. Reinstall the inlet hose to the filter head and tighten the hose clamp securely.
9. Remove the reservoir tank cap.
10. Add SAE 15W-40 oil to the reservoir tank up to the "Cold Full" line. DO NOT overfill as fluid will leak out from the reservoir cap.
11. Replace the cap and tighten to secure.

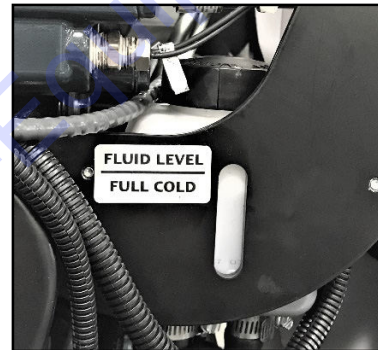

Hydro Pump Reservoir Tank

12. Check the system for leaks and ensure proper pressure by turning the ignition switch to START and release when the engine starts.

NOTE: If the engine does not start within 10 seconds, turn off the key and try again approximately 30 seconds later. Refer to the engine manual for troubleshooting recommendations after several failed attempts

Replace the Fuel/Water Separator Filter

Replace the fuel/water separator filter periodically to prevent wear on the fuel pump due to dirt in the fuel.

1. Ensure the engine is turned OFF and the saw frame is level.
2. Place a container under the fuel/water separator filter.

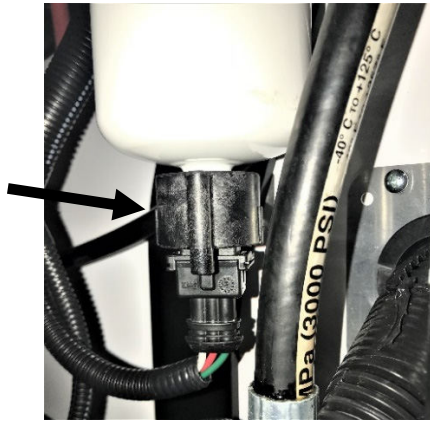

Drainage Cap/Switch Assembly

3. Disconnect the sensor wire from the bottom of the switch assembly.
4. Rotate the cap just enough to drain the water and fuel in the filter.
5. When all water and fuel has been drained from the filter, unscrew the drainage cap/switch assembly from the bottom of the filter.
6. Remove the filter using a filter wrench.
7. Apply a thin film of oil on the gasket for the new filter.
8. Screw the new filter on by hand until it touches the filter head, then turn it 3/4 of a turn to tighten. DO NOT use a wrench to tighten the filter.
9. Reinstall the drainage cap/switch assembly on the bottom of the filter.
10. Reconnect the sensor wire to the drainage cap/switch assembly.

Replace the Fuel Filter

1. Ensure the engine is turned OFF.
2. Locate the fuel filter on the lower starter side of the engine.



Fuel Filter

3. Use a filter wrench to remove the filter.
4. Dispose of the fuel and filter in accordance with city, state and federal regulations.
5. Apply a thin film of fuel on the gasket of the filter.
6. Screw the filter onto the filter head until the gasket seats, then turn the filter 1/2 turn by hand to secure.
7. Crack open the vent screw located on the filter head of the fuel filter assembly.



Fuel Filter Vent Screw

8. Press the manual priming pump located on the top of the fuel/water separator 3 – 4 times to prime the fuel system.



Manual Priming Pump

9. Turn the ignition switch to the ON position. The electronic fuel pump will energize and build up fuel pressure.
10. When fuel begins to escape from the fuel filter vent, turn the ignition switch to STOP.
11. Tighten the fuel filter vent.
12. The fuel system is now vented and ready for operation.

Replacing the Outer Primary and Inner Safety Filters

1. Pull out the tab on the air cleaner housing end cover.



End Cover Tab

2. Turn the end cover counter-clockwise to unlock and pull the cover away from the main air cleaner housing.
3. Remove the outer primary and inner safety filters from the air cleaner housing.

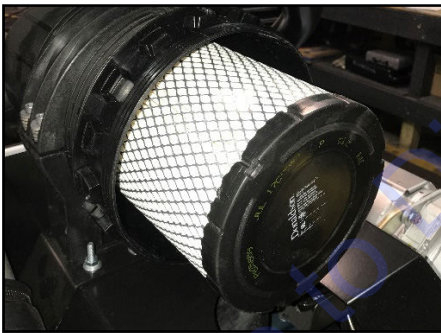

Outer Primary Filter



Inner Safety Filter

4. Inspect the inside of the air cleaner housing and the end cover for debris, and wipe them down with a damp cloth as

necessary. DO NOT use compressed air to blow out the inside of the air cleaner housing. DO NOT allow dust to enter the air intake tube when cleaning or replacing parts.

5. Place the new inner safety filter into the air cleaner housing until it is fully seated.
6. Place the new outer safety filter into the air filter housing over the inner safety filter and gently push the filter into the unit until it feels secure.
7. Place the end cover tightly up against the ridge at the end of the air cleaner housing.
8. Turn the end cover clockwise to lock the cover onto the air cleaner housing, making sure the dust ejector boot is in the vertical position.
9. Push the tab in on the air cleaner housing end cover to secure.
10. Press the restriction indicator reset button on the restriction indicator after the unit has been cleaned.

1000 Service Hours

Replace Radiator Coolant

Ensure the engine is turned OFF and cooled down prior to replacing the radiator coolant

1. Unbolt the four cap screws attaching the front radiator shroud to the radiator and remove the shroud.
2. Place a drain pan under the radiator drain valve.



Front Radiator Shroud

3. Slowly remove the radiator cap.

CAUTION

Remove the radiator cap only when it feels cool to the touch, and always open it slowly to relieve any built up pressure.

4. Open the drain valve handle and drain the fluid completely. Dispose of the used fluid according to city, state, and federal regulations.
5. Close the drain valve handle.



Radiator Drain Valve

6. Add a 50/50 mix of water and anti-freeze through the fill port until the fluid reaches the overflow hole inside the filler neck.
7. Replace the radiator cap and retighten to secure.
8. Reinstall the radiator shroud.
9. Remove the coolant recovery tank cap.



Coolant Recovery Tank

10. Add a 50/50 mix of water and anti-freeze to the "Cold Full" line.
11. Replace the coolant recovery tank cap.

1500 Service Hours

Replace the Oil Separator Element

Ensure the engine is turned OFF prior to changing the oil separator element.

1. Locate the oil separator on the upper backside of the engine in front of the upright assembly.



Oil Separator Cap

2. Unscrew the cap from the oil separator body.
3. Remove the separator element and gasket.
4. Wipe oil and grease from the gasket area.
5. Fit a new gasket and separator element into position.
6. Reinstall the cap.

Regular Maintenance

Converting Blade Setup

When changing blade setups, the jackshaft sheave, belts, flanges, and skid plates must be changed out in accordance with the RPM and Blade Size Conversion Charts located in Appendix C at the end of this manual.

Jackshaft Drive Belt Sheaves

WARNING

Turn off the engine prior to servicing any belts and sheaves. Use extreme caution when working with rotating machine parts to avoid entanglement.



CAUTION

Let the belts cool down prior to servicing them.

Removing the Jackshaft Drive Belt Sheave

1. Loosen the two engine rail bolts located on the right side of the saw.

MAINTENANCE



Engine Rail Bolts

2. Unlatch and lower the front jackshaft belt cover.
3. From the front of the saw, using the belt tensioner tool (provided in the tool holder assembly located on the left inside of the upright), turn the lead screw counter-clockwise. This will pull the engine forward and loosen the drive belts.



Belt Tensioner Lead Screw

4. Unlatch and open the front belt cover and remove the rear belt cover
5. Remove the matched set of drive belts from the PTO and jackshaft drive sheaves.

NOTE: If removing a tapered bushing, continue to step 6. For quick disconnect (QD) bushings, skip to step 8.

6. Remove both setscrews from the sheave.

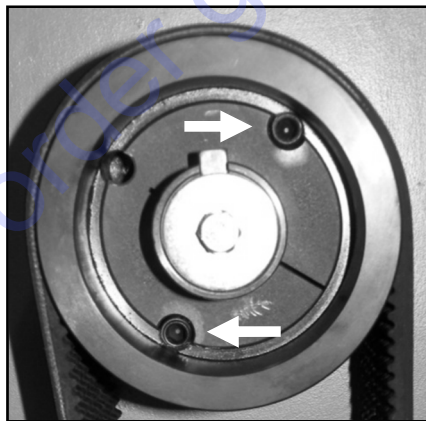

Tapered Bushing with Setscrews

7. Place one of the removed setscrews into the third setscrew hole (in line with slot) on the bushing. Using an Allen wrench or hex key, tighten the setscrew into the hole to separate the sheave from the bushing.
8. Remove the sheave from the bushing.
9. For the QD style bushing, use a socket wrench and remove all three cap screws from the bushing.

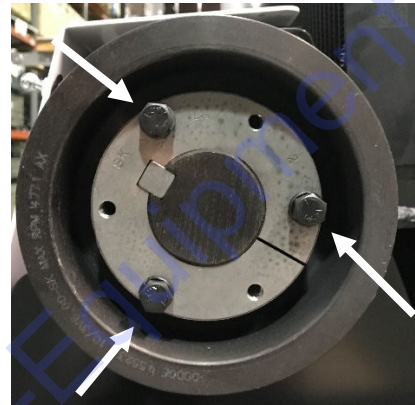

QD Bushing with Cap Screws

10. Place the three cap screws into the threaded holes on the bushing. Using a 1/2" socket wrench, tighten the cap screws into the holes to separate the sheave from the bushing.
11. Remove the setscrew above the key using an Allen wrench or hex key if replacing the QD bushing.

Installing the Jackshaft Drive Belt Sheave

1. If needed, unlatch and open the front belt cover and remove the rear belt cover.
2. Fit the appropriate size sheave onto each bushing. *Refer to the RPM and Blade Size Conversion charts in Appendix C at the end of this manual and the CC9074DK Parts List for additional information.*
3. On the PTO sheave, place a straightedge against the edge of sheave. Adjust the jackshaft drive sheave to align with the edge of the PTO sheave.



Jackshaft Sheave Alignment

- For a sheave using a tapered bushing, place two setscrews into the setscrew holes (in line with each other) on the jackshaft drive sheave and tighten the setscrews to secure.

NOTE: Make sure both sheaves are properly aligned prior to securing.

- For a sheave using a QD bushing, move the jackshaft sheave away from the bushing just enough to tighten the setscrew onto the shaft key. Place the three cap screws into the unthreaded holes of the sheave. Using a socket wrench, tighten the cap screws into the QD bushing to secure.

- NOTE: Make sure both sheaves are properly aligned prior to securing.*

Installing the Jackshaft Drive Belts

- Ensure the two engine rail bolts, located on the right side of the saw, are loose.
- Ensure the engine is in the full forward position by turning the belt tensioner lead screw counter-clockwise using the belt tensioner tool provided.
- Install a matched set (10 belts) of belts onto the PTO and jackshaft drive sheaves.
- Turn the belt tensioner lead screw in a clockwise direction to tension the belts. Test the belt tension and readjust the lead screw as necessary. DO NOT exceed the manufacturer's tension settings.
- Retighten the engine rail bolts on the right side of the saw.

- Re-install, close and latch all belt guards.

Blade Drive Belts

! WARNING

Turn off the engine prior to servicing the belts. Use extreme caution when working with belts and rotating machine parts to avoid entanglement.

! CAUTION

Let the belts cool down prior to servicing them.

Inspect all belts daily for fraying, stress cracks, and/or breakage and replace immediately when damaged. Always re-tension new belts after the first two to four hours of use. DO NOT exceed the manufacturer's recommended belt tension settings when tensioning belts.

NOTE: Over-tensioning belts may reduce the life of the bearings. Under-tensioning belts may cause slippage, shorter belt life, and/or poor saw performance. Squealing belts indicate looseness.

Tensioning the Blade Drive Belts

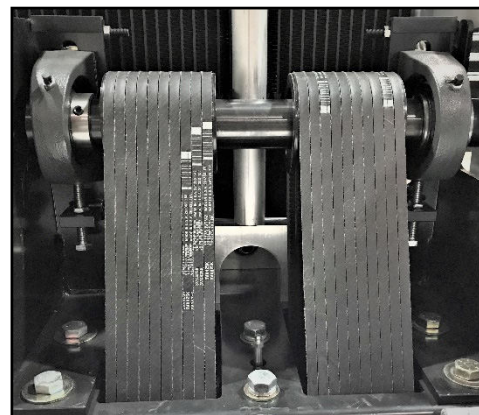

Blade Drive Belts

- Unlatch and lower the front jackshaft belt cover.
- Test the belt tension.
- Slightly loosen the four pillow block bearing mounting bolts.
- Loosen the jam nut on each of the two blade drive belt tension bolts.

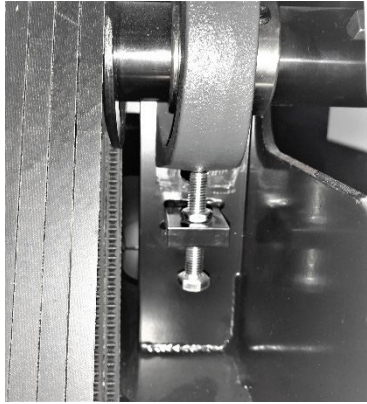

Blade Drive Belt Tensioning Bolt and Jam Nut

5. Turn both blade drive tension bolts equally to tighten the belts. Test the belt tension and readjust the bolts as necessary. **DO NOT** exceed the manufacturer's tension settings.
6. Tighten the jam nut on both blade drive belt tension bolts down to the jackshaft mounts.
7. Retighten the four pillow block bearing mounting bolts.

Engine



WARNING



Let the engine cool down prior to servicing the saw.
DO NOT service the saw with the engine running (unless stated otherwise).

Refer to the engine manual and manufacturer for a full engine maintenance schedule and additional engine maintenance information.

Engine Control Unit (ECU)

The engine is equipped with an engine control unit (ECU). The ECU monitors various engine parameters to ensure optimal engine performance and efficiency.



Warning

Never weld on the machine with the ECU connected to the wire harness.

Battery



WARNING

Ignitable explosive gases are emitted from the battery. **DO NOT** expose the battery to sparks or open flames, and keep the area around the battery well-ventilated.

Disconnect the battery prior to servicing the saw (unless stated otherwise).
 Always keep the battery cable clamps away from the battery terminals when the battery is disconnected to avoid accidental connections while servicing.



Always be sure to connect the battery cables to the proper terminal when reconnecting.





CAUTION

Use a proper battery tester when testing the battery strength.
 Use protective eyewear or a face shield and avoid contact with the skin when handling/servicing the battery.

The saw contains a charged battery with one positive cable lead and one negative cable lead.



Battery – CC9074DK

Battery Type

12 Volt, Group Size 31

Servicing the Battery

1. Disconnect the negative cable lead from the negative terminal.
- NOTE: Always disconnect the negative cable first.*
2. Disconnect the positive cable lead from the positive terminal.
 3. Unsecure the battery from the hold-down bracket by removing the two ratchet knobs from the battery hold-down tie rods and lift the hold-down bracket lid off.
 4. Carefully remove the battery from the battery box.
 5. When replacing the battery, carefully place a new battery into the battery box. Bring the old battery to a recycling facility; many battery retailers also accept old batteries.
 6. When cleaning the battery, inspect the terminals, clamps, and cables for damages and corrosion. Clean the terminals and clamps using a wire brush, or use another approved technique for cleaning. Use acid-free, acid-resistant grease to grease the battery clamps and terminals. Carefully place the battery back into the battery box.
 7. Reconnect the positive cable lead to the positive battery terminal.

NOTE: Always reconnect the positive cable first.

8. Reconnect the negative cable lead to the negative battery terminal.
9. Re-secure the battery to the hold-down bracket by removing the hold-down battery lid over the two tie rod bolts and tighten it using the two ratchet knobs.

Electrical System



WARNING

Disconnect the battery when servicing the electrical system unless stated otherwise.

Always use the correct size fuses (amps) to prevent fires.



Fuses

The fuses are located in the power block assembly which can be accessed by removing the dash panel on the switch box assembly.

Inspect all fuses if switches or controls are not working properly and replace as necessary. If fuses are failing frequently, determine the cause and repair immediately.

Replacing Fuses

The fuses used on this machine are smart glow fuses. They have an LED indicator light that will illuminate if the fuse is blown.

1. Ensure the ignition switch is in the *STOP* position.
2. Remove the dash plate from the switch box assembly (top right hand side of control panel).
3. Remove cover from fuse box.
4. Turn the ignition switch to the *ON* position.
5. Remove and replace any illuminated blown fuses.



WARNING

Never replace a fuse with a larger amperage fuse. This could lead to equipment damage or personal injury.

Speed Control Lever

Adjusting Speed Control Cable

The forward and reverse functions of the speed control system are set at the factory. If additional adjustment is needed, there are two locations to accomplish this action. The first is at the front of the saw behind the radiator fan. The cable has two jam nuts located on the cable to adjust the cable length as necessary. The second location is inside the upright where the control cable connects to the speed control lever. There are two jam nuts at this end of the cable for adjustment as well.

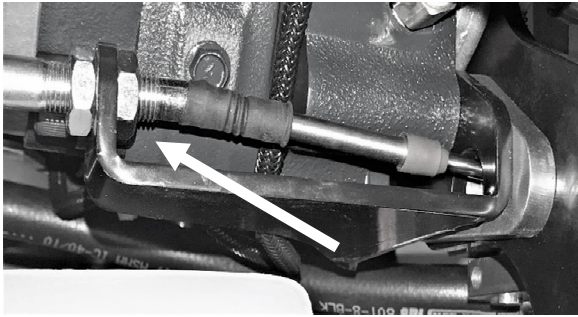

Front Speed Cable Adjustment

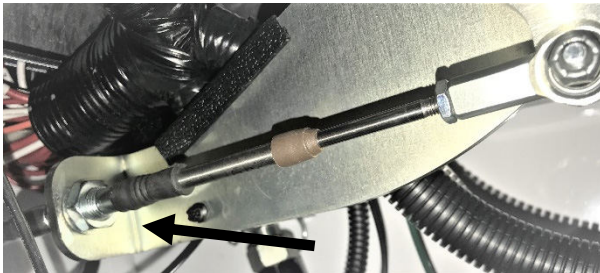

Rear Speed Cable Adjustment

Adjusting the Lever Tension

Adjust the tension felt in the speed control lever, when moving the lever forward and backward, to the desired setting as necessary.

1. Open the rear cover screen.
2. Remove the grease cap from the pivot housing.
3. Loosen the jam nut on the opposite side of the speed control frame using the provided wrench.

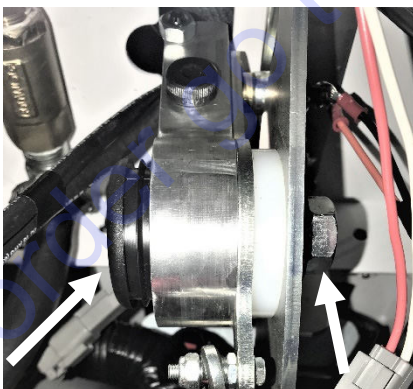

Grease Cap and Jam Nut

4. Use the hex wrench, located inside the upright on the right hand side panel, to adjust the shoulder screw.
5. Retighten the jam nut.
6. Move the speed control lever forward and backward to test the lever tension.

Readjust the shoulder screw/jam nut if desired.

7. Secure the grease cap to the pivot housing.
8. Close the rear cover screen and latch.

Adjusting the Spring Plungers

Adjust the spring plungers if the speed control lever feels floppy or loose when moving the lever forward and backward, or when the lever is hard to place into or out of the *STOP/PARK* position.

1. Loosen both hex nuts from the speed control tube.

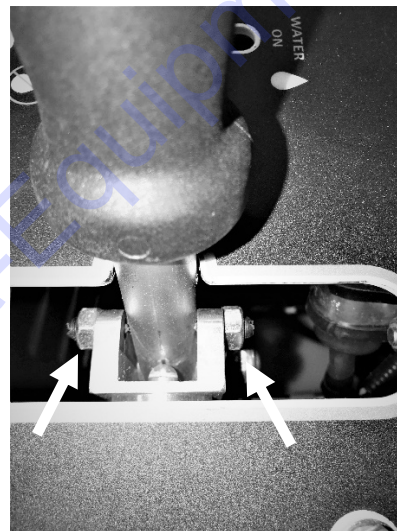

Spring Plunger Hex Nuts

2. Screw the spring plungers slightly out to let the speed control lever move easily into and out of the *STOP/PARK* position. Screw the spring plungers in slightly, to let the speed control lever move forward and backward firmly in the forward/reverse slot.
3. Retighten both hex nuts to secure.

Inner Blade Flange

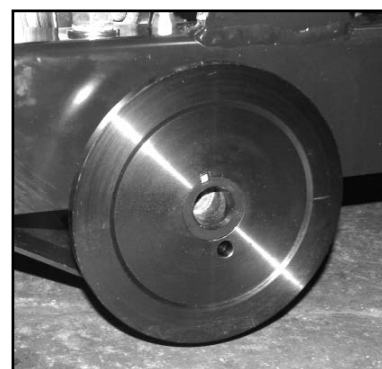

Inner Flange

Installing the Inner Blade Flange

1. Inspect the inner flange for damages. Clean or replace damaged components as necessary.
2. Align the flange with the blade shaft key and place the flange onto the blade shaft.
3. Apply Loctite 262 (red) or an equivalent to the setscrew threads.
4. Tighten the setscrew(s) into the back of the inner flange to secure.

Removing the Inner Blade Flange

1. Remove the setscrew(s) from the back of the inner flange using an Allen wrench.
2. Carefully remove the flange from the blade shaft.

Maximum Cutting Depth Stop Bolts

Always adjust the maximum cutting depth stop bolts when changing to a larger flange size to avoid damaging the blade flanges.

1. Raise the saw to gain access to the maximum cutting depth stop bolts underneath the frame base.

 **WARNING**

Raise the saw to a proper height for access when working underneath the saw. Use chocks to block the wheels, and fit blocks or jacks under the frame edges at the front and back of the frame.



2. Loosen the jam nut on both bolts.
3. Turn the bolts counterclockwise to decrease the maximum cutting depth, or turn the bolts clockwise to increase the maximum cutting depth.

NOTE: Both bolts must be the same length when finished.

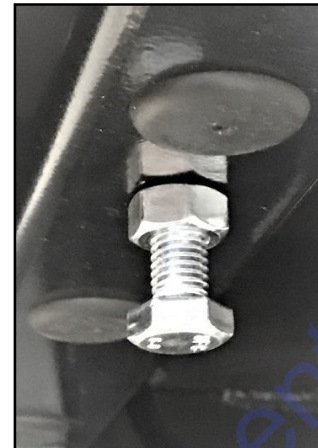

Maximum Depth Stop Bolt

4. Bottom out the jam nut on each bolt with the frame base to secure the bolts.
5. Remove all tools from the area and lower the saw completely. The blade flanges must be at least 1/4" from the ground to prevent component damage.
6. Readjust the depth bolts as necessary.

NOTE: Make sure both skid plates on the front of the saw are in the correct set of holes in order to lower the saw completely (refer to Appendix C).

Handlebar Lock Cylinder

The handlebar lock cylinder must be serviced by Diamond Products if the handlebars can be moved up or down in excess amounts when locked in place (movement may feel sluggish). Send the entire assembly to Diamond Products to be recharged or pressurized.

Removing the Lock Cylinder

1. Open the rear cover screen.
2. Remove the round 1-5/8" hole plug located on the lower right hand side of the upright assembly.



Cylinder Pin Access Plug

3. Disconnect the two wires from the solenoid block valve located on the cylinder.



Solenoid Block Wires

4. Remove the lower hairpin cotter and push the clevis pin through the access hole on the upright assembly.



Lower Hairpin Cotter and Clevis Pin

5. Holding the cylinder, remove the upper hairpin cotter and clevis pin from the handlebar tube.



Upper Hairpin Cotter and Clevis Pin

6. Remove the entire assembly from the saw.

Connecting the Lock Cylinder

1. Open the rear cover screen.
2. Remove the round 1-5/8" hole plug located on the lower right hand side of the upright assembly.
3. Fit the cylinder into the cylinder rod end mount and isolator mount tube.
4. Fit the upper clevis pin through the cylinder rod end mount and cylinder rod end. Secure in place with the hairpin cotter.
5. Fit the second clevis pin through the access hole in the upright into the isolator mount tube and cylinder block. Secure in place with the hairpin cotter.
6. Connect the two wires to the solenoid block valve.

Lifting and Transporting

Lifting



Always use a strap to lift the machine. Ensure the strap is rated high enough to handle the load.

1. Ensure the work area is clear of any obstructions and all personnel are at a safe distance prior to lifting the machine.
2. Ensure the engine is *OFF* and the frame is level to the ground prior to lifting.
3. Using a properly rated strap, place the strap around the frame lift point.

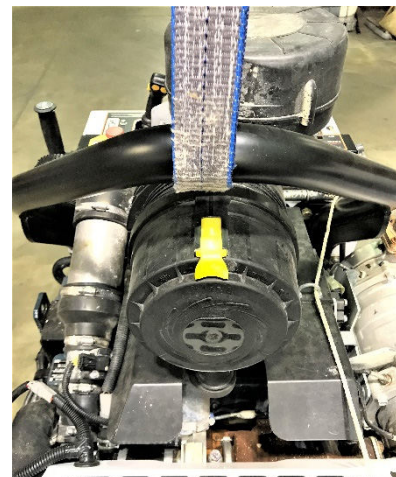

Lifting Point with Strap

Transporting

Always secure the machine using the three tie down D-rings to avoid damage during transport. The rings are located on the frame base, one in front and two at the rear.

NOTE: Never tow the machine as this may cause damage to the drive components.

Storing

Complete the tasks listed below prior to storing the saw for longer time frames:

- Drain the water lines/hoses and blow out with air.
- Turn off all switches and controls.
- Lower the saw completely to remove strain on the lifting mechanism.
- Clean and wipe down the saw to remove dust, debris, and slurry from saw components (especially fans).
- Remove the battery and store in a proper location, out of reach from children.
- Refer to the engine manual for all engine and fuel recommendations prior to storing.
- Store the saw in a dry area, protected from outdoor elements and out of reach from children.

Disposal

Dispose of the saw when it's no longer repairable, and/or contains safety hazards not worth repairing or maintaining. Complete the tasks listed below when discontinuing usage:

- Drain all fluids and dispose of according to city, state, and federal regulations.
- Remove the battery and bring to a recycling facility; many battery retailers also accept old batteries.
- Transport the saw to a salvage yard or recycling facility.

Engine Regeneration

The engine is installed with a Diesel Particulate Filter (DPF). A DPF is a device designed to remove diesel particulate matter or soot from the exhaust gas of the diesel engine. This removal process is called a regeneration. There are three types of regeneration associated with the engine:

- Passive
- Active
- Parked

There are five status levels that correspond to each particular regeneration type:

- Level 1 - Passive regeneration
- Level 2 - Active regeneration
- Levels 3 & 4 - Parked regeneration
- Level 5 – Regeneration impossible

Passive Regeneration

Occurs when the temperature of the exhaust is high enough to naturally burn off at least some of the particulates (soot) captured by the DPF. Most normal use of the saw where the engine is operated under full load will cause exhaust temperatures high enough (above 300°C / 572°F) to produce passive regen, preventing soot buildup. There is no action required from operator and there is no effect on machine operation.

This type of regeneration corresponds to Level 1 status as long as the “Regen Settings” in the Utilities menu are set to “Uninhibit Regen” (default setting). If it is set on “Inhibit Regeneration” a yellow Level 1 pop-up message will appear on the control screen:

The Diesel Particulate Filter is loaded with soot and needs to be regenerated.

When safe please uninhibit automatic active regeneration.

Regeneration Level 1 Yellow Caution

When this pop-up message appears, the operator can choose one of two options:

1. Reset the “Regen Settings” in the Utilities menu to “Uninhibit Regen”. This will allow for a passive regeneration to occur without further action from the operator.
2. Cancel out of the regeneration process and return to the Home screen. This will not allow for a passive regeneration to occur and the DPF will continue to build up diesel particulate matter. No further action from the operator is required at this time.

Active Regeneration

The “Regen Settings” are set to “Unihabit Regen” (Default setting) in the Utilities menu. This will allow active regeneration to occur if the system detects the exhaust temperatures are insufficient to passively keep the DPF from clogging with particulates. The engine controls inject diesel fuel directly into the DPF to increase temperature to burn off, i.e. clean, the soot captured in the filter.

This should occur infrequently, but will happen more often if the engine is allowed to idle excessively (longer than five minutes) or sawing is lightly loaded. Failure to change oil at recommended intervals can also contribute to excessive soot buildup. It is not unusual to see excessive smoke being emitted from the tailpipe during regeneration. . Machine operation is NOT interrupted. It is recommended to let the regeneration complete automatically, typically 20 minutes, but if it needs to be interrupted turn the ignition to **STOP**.

 **CAUTION**

ACTIVE REGENERATION will cause the exhaust temperatures to be extremely high. Ensure exhaust will not come into contact with combustible materials

During active regeneration the display panel will show the red status icon, Engine Exhaust High Temperature Lamp.

This type of regeneration corresponds to Level 2 status. If the Regen Settings” in the Utilities menu are set to “Inhibit Regen” and a Level 1 pop-up message was cancelled, then a series of two orange Level 2 pop-up messages will appear on the control screen:

The Diesel Particulate Filter is loaded with soot and needs to be regenerated.

Whenever safe either uninhibit automatic active regeneration or complete a parked regeneration:

More...

**Regeneration Level 2 Orange Caution
Screen 1**

- 1) Move the machine to a safe location.
 - 2) Place in Park or Neutral.
 - 3) Set the engine to low idle.
 - 4) Uninhibit regeneration.
 - 5) Apply the parking brake (if equipped).

**Regeneration Level 2 Orange Caution
Screen 2**

When this pop-up message appears, the operator can choose one of three options:

1. Cancel out of the regeneration process and continue operations.
2. Change the “Regen Settings” in the Utilities menu to “Unihabit Regen” which will allow for an active regen to take place. The regeneration process will typically take 20 minutes to complete. This option will also allow for the continued use of the machine without any further action from the operator. *However, the operator must be aware that the exhaust temperatures will be extremely high.*
3. Move the machine to a safe location and conduct a Parked Regeneration. This option is recommended as long as time permits.

Parked Regeneration

When the diesel particulate levels in the DPF become too high, a red Level 3 pop-up message will appear on the control screen:

Urgent engine output limited. The Diesel Particulate Filter is **EXTREMELY** loaded with soot and needs to be regenerated.

Continued operation without completing a parked regeneration can cause unwarranted engine damage.

IMMEDIATELY: MORE....

**Regeneration Level 3 Red Caution
Screen 1**

- 1) Move the machine to a safe location.
- 2) Place in Park or Neutral.
- 3) Set the engine to low idle.
- 4) Uninhibit regeneration.
- 5) Apply the parking brake (if equipped).

Regeneration Level 3 Red Caution Screen 2

When this pop-up message appears, the operator can choose one of two options:

1. Cancel out of the regeneration process and continue operations.



WARNING

Continued operation at a Level 3 status may cause unwarranted engine damage

2. Move the machine to a safe area and conduct a parked regeneration. A parked regeneration will typically take 30 minutes to complete. It is strongly recommended to conduct a parked regeneration immediately to prevent possible engine damage.

If a regeneration is not conducted, a red Level 4 pop-up message will appear on the control screen:

Urgent engine output limited.

DPF regeneration is required IMMEDIATELY by a qualified engine or OEM service technician.

IMMEDIATELY take the machine to a safe location, shutdown and contact a qualified service facility.

Regeneration Level 4 Red Caution

If this Level 4 message appears, it is critical that the machine be taken to a safe area and shutdown. A DPF regeneration is required to be completed by a qualified engine or OEM service technician. Any further operation of the machine will result in a Level 5 status warning:

Urgent engine output is SEVERELY limited. DPF Regeneration is impossible.

The DPF must be removed and cleaned by a qualified cleaning facility and the ECU must be reset by a qualified engine or OEM service technician. IMMEDIATELY take the machine to a safe location, shutdown and contact a qualified service facility.

Regeneration Level 5 Red Caution

Once a Level 5 message is displayed, the machine must be taken to a safe area and shutdown. It will need to have the DPF removed and cleaned by a qualified cleaning facility and the ECU will need to be reset by a qualified engine or OEM technician.

Whenever a successful regeneration occurs, a green “Completed” pop-up message will appear on the control screen:

DPF regeneration is complete

The machine may be returned to normal usage.

Regeneration Complete

Requesting a Parked Regeneration



CAUTION

PARKED REGENERATION will cause the exhaust temperatures to be extremely high. Ensure exhaust will not come into contact with combustible materials



WARNING

If the DPF soot level reaches Regen Level 4 (Red) due to inhibiting regeneration, the engine should be shutdown and a qualified engine or OEM service technician will be required to perform a forced regeneration.

1. To conduct a parked regeneration of the DPF the following conditions must be met:
 - Machine is in a safe area with the speed control lever in the *STOP/PARK* position
 - Engine is in low idle
 - Regen setting must in set to “Uninhibit Regen”
2. Once these conditions are met, go to the Menu screen and choose “Utilities”
3. From the Utilities menu select “Regen Settings”
4. From the “Regen” menu select “Request Regen”
5. A series of three blue pop-up messages will appear on the control screen:

The DPF will now regenerate. This may take 20–40 minutes. The engine speed may increase during this process, this is normal.

The exhaust temperature may reach very high levels; ensure that proper safety measures are taken to avoid injuries and property damage. More...

Regeneration, Screen 1

During this process:

DO NOT move the machine out of park or neutral.

DO NOT touch the accelerator pedal/lever.

DO NOT turn the engine off or stop the regeneration process. More...

Regeneration, Screen 2

Unless there is an emergency, in which case the machine can be moved or shut down by normal means.

When the above conditions are met, begin the parked regeneration by pushing the “Request Regen” button.

Regeneration, Screen 3

6. Use the UP/DOWN arrows to maneuver through the screens until the “Request Regen” soft key appears.
7. Select “Request Regen” to begin the regeneration process.

NOTE: During the regeneration process, the engine speed will increase and there may be noticeable sound difference.



CAUTION

DO NOT attempt to operate the unit, change engine RPM or move from “Parked/Stop” while regeneration is occurring. This will abort the regeneration process and require to start the process over.

Once the process has started it can be shutdown by selecting the “Stop Regen” soft key. DO NOT shutdown unless it is

absolutely necessary. **CAUTION**

Continue to monitor the surrounding areas during the process. If unsafe conditions develop, shutdown the unit immediately.

The regeneration process will take approximately 20-30 minutes to complete. The following green pop-up message will appear on the control screen when the process is completed:

DPF regeneration is complete

The machine may be returned to normal usage.

Regeneration Complete

When this message appears, the machine can return to normal operation.

REFERENCES

Appendix A

Model and Serial Numbers

Record the saw's serial number below for future reference and customer service purposes.

Serial Number	
---------------	--

Record the engine's model and serial numbers below for future reference and customer service purposes.

Model Number	
Serial Number	

To order go to Discount-Equipment.com

REFERENCES

Appendix B Troubleshooting

Troubleshooting the CC9074 Deep Cut		
Symptom	Problem	Solution
1. Engine will not start.	Out of Fuel?	Fill fuel tank.
	Fuel lines clogged?	Unclog or replace fuel lines.
	Faulty battery connection?	Inspect, clean, and tighten battery cables.
	Engine malfunction?	Refer to engine manual.
	Bad fuse?	Check and replace bad fuses.
2. Engine will not start due to a shutdown condition indicated on display panel. <i>NOTE: All problems must be cleared before saw will restart.</i>	E-Stop is active.	Pull up emergency stop button.
	Coolant level is low.	Fill coolant system in accordance with this manual.
3. Saw will not raise.	Defective solenoid start switch?	Replace solenoid on hydraulic pump unit.
	Worn out battery?	Charge or replace battery.
	Defective raise button?	Replace raise button.
	Low hydraulic fluid?	Check hydraulic fluid level and fill as necessary.
4. Saw will not lower.	Debris in lowering valve stem?	Inspect and clean stem.
	Worn out battery?	Charge or replace battery
	Defective valve coil?	Check for magnetism of valve stem when activated.
	Defective lowering button?	Replace lowering button.
5. Saw will not lower completely.	Depth stop set?	Reset depth stop.
	Skid plates in wrong set of holes?	Adjust skid plates to correct set of mounting holes.
	Maximum cutting depth set incorrectly?	Adjust maximum cutting depth stop bolts.
6. Saw lowers too slow or too fast.	Improper lowering speed setting?	Adjust blade lowering speed valve.
7. Blade does not cut straight.	Drive alignment off?	Adjust rear axle adjustment bolt.
	Excessive force used when sawing?	Reduce forward speed. DO NOT twist blade from side to side.
	Wrong blade?	Contact Discount-equipment.

REFERENCES

8. Short belt life.	Loose belts causing slippage?	Check and adjust belt tension.
	Sheaves misaligned?	Use straightedge to check blade shaft sheave alignment. Adjust as necessary.
	Worn sheave grooves?	Check for groove wear and replace sheaves when necessary.
	Mismatched belts?	Replace with matched set of belts. DO NOT use old and new belts together.
9. Blade Speed Indication is not displayed	Damaged shaft tach sensor?	Adjust or replace shaft tach sensor
	Shaft tach magnetic sensor harness disconnected?	Reconnect sensor harness

REFERENCES

Appendix C

CC9074DK Deep Cut RPM Chart

WARNING: Do not exceed blade speed (RPM) shown for each blade size.
Excessive blade speed could result in blade breakage and serious personal injury.

WARNING! NEVER EXCEED THE MAXIMUM RPM STAMPED ON THE BLADE! EXCESSIVE SPEED CAN CAUSE BLADE BREAKAGE RESULTING IN SERIOUS PERSONAL INJURY OR DEATH.

CC9074D DEEP CUT RPM CHART

BLADE SIZE	BLADE RPM	JACKSHAFT SHEAVE	ENGINE SHEAVE	ENGINE RPM	BELT SIZE	FLANGE SIZE	MAX CUT DEPTH
36"	1,400	5.00"	4.00"	2,600	3VX600	6"	15"
42"	1,150	6.00"	4.00"	2,600	3VX616	7"	17-1/2"
48"	1,000	6.90"	4.00"	2,600	3VX630	8"	20"
54"	870	8.00"	4.00"	2,600	3VX650	9"	22-1/2"
60"	800	8.00"	4.00"	2,400	3VX650	10"	25"

CC9074DK Deep Cut Blade Size Conversion Chart

WARNING: When changing blade size, use the chart below for selecting the correct items for the different configurations.

Model CC9074	36"	42"	48"	54"	60"
Blade Guard Assembly	6010958	6010960	6010962	6010614	6010616
Jackshaft Sheave (Sheave Size)	6017436 (5")	6013043 (6")	6013213 (6.9")	6013044 (8")	6013044 (8")
Drive Belts (Set of 10) (Belt Size)	2506132 (3VX600K)	2506133 (3VX616K)	2506134 (3VX630K)	2506135 (3VX650K)	2506135 (3VX650K)
Inner Flanges (2) (Flange Size)	6010038 (6")	6017230 (7")	6013017 (8")	6016252 (9")	6040039 (10")
Outer Flanges (2) (Flange Size)	6010039 (6")	6017231 (7")	6013018 (8")	6016253 (9")	6040040 (10")
Skid Plates (2) Mounting Holes	Bottom Set	1 Up from Bottom Set	Middle Set	1 Down from Top Set	Top Set

Appendix D

Additional Resources

1. Kubota (www.kubota.com)
 - *Operator's Manual Kubota Engine, V3307-CR-T-E4-B*
2. Discount-equipment (www.discount-equipment.com)
 - *CC9074 Deep Cut Concrete Saw Parts List; Ohio, 2010*
 - *A Guide for Professional Concrete Cutters*
 - *Training Manual – Introduction to Diamond Blades, Bits, and Equipment*
 - *Diamond Products' Equipment Catalog*
 - *Discount-equipment' Website (www.discount-equipment.com)*
3. Concrete Sawing and Drilling Association (www.cstda.org)
 - The CSDA has many helpful concrete cutting publications available to members and non-members.
4. Association of Equipment Manufacturers (www.aem.org)
 - The AEM has a variety of safety and technical manuals available for various types of equipment, along with a list of industry-standardized safety symbols.
5. Occupational Safety & Health Administration (OSHA) (www.osha.gov/)
 - OSHA provides information on work-related safety and health practices.
6. The National Institute for Occupational Safety and Health (NIOSH) (www.cdc.gov/NIOSH/)
 - NIOSH provides information on work-related safety and health practices.

EQUIPMENT AND PARTS WARRANTY

Discount-equipment warrants all equipment sold by it against defects in workmanship or materials for a period of one (1) year from the date of shipment to Customer.

The responsibility of Discount-equipment under this Warranty is limited to replacement or repair of defective parts, of such parts as shall appear to us upon inspection at such parts, to have been defective in material or workmanship, with expense for transportation and labor borne by Customer.

In no event shall Discount-equipment be liable for consequential or incidental damages arising out of the failure of any Product to operate properly.

Integral units such as engines, electric motors, batteries, transmissions, etc., are excluded from this Warranty and are subject to the prime manufacturer's warranty.

**THIS WARRANTY IS IN LIEU OF ALL OTHER WARRANTIES,
EXPRESSED OR IMPLIED, AND ALL SUCH OTHER WARRANTIES ARE
HEREBY DISCLAIMED.**



TO PURCHASE THIS PRODUCT PLEASE CONTACT US



**Equipment Financing and
Extended Warranties Available**



**Discount-Equipment.com is your online resource for
commercial and industrial quality parts and equipment sales.**

561-964-4949

visit us on line @ www.discount-equipment.com

Select an option below to find your Equipment

Search by Manufacturer

Search by Product Type

Request a Quote

We sell worldwide for the brands: Genie, Terex, JLG, MultiQuip, Mikasa, Essick, Whiteman, Mayco, Toro Stone, Diamond Products, Generac Magnum, Airman, Haulotte, Barreto, Power Blanket, Nifty Lift, Atlas Copco, Chicago Pneumatic, Allmand, Miller Curber, Skyjack, Lull, Skytrak, Tsurumi, Husquvarna Target, Stow, Wacker, Sakai, Mi-T-M, Sullair, Basic, Dynapac, MBW, Weber, Bartell, Bennar Newman, Haulotte, Ditch Runner, Menegotti, Morrison, Contec, Buddy, Crown, Edco, Wyco, Bomag, Laymor, EZ Trench, Bil-Jax, F.S. Curtis, Gehl Pavers, Heli, Honda, ICS/PowerGrit, IHI, Partner, Imer, Clipper, MMD, Koshin, Rice, CH&E, General Equipment, Amida, Coleman, NAC, Gradall, Square Shooter, Kent, Stanley, Tamco, Toku, Hatz, Kohler, Robin, Wisconsin, Northrock, Oztec, Toker TK, Rol-Air, APT, Wylie, Ingersoll Rand / Doosan, Innovatech, Con X, Ammann, Mecalac, Makinex, Smith Surface Prep, Small Line, Wanco, Yanmar