



**CONCRETE SAW
OPERATOR'S MANUAL**

CC5555GK-3

February 2019

Part #: 1802669

TO PURCHASE THIS PRODUCT PLEASE CONTACT US



**Equipment Financing and
Extended Warranties Available**



**Discount-Equipment.com is your online resource for
commercial and industrial quality parts and equipment sales.**

561-964-4949

visit us on line @ www.discount-equipment.com

Select an option below to find your Equipment

Search by Manufacturer

Search by Product Type

Request a Quote

We sell worldwide for the brands: Genie, Terex, JLG, MultiQuip, Mikasa, Essick, Whiteman, Mayco, Toro Stone, Diamond Products, Generac Magnum, Airman, Haulotte, Barreto, Power Blanket, Nifty Lift, Atlas Copco, Chicago Pneumatic, Allmand, Miller Curber, Skyjack, Lull, Skytrak, Tsurumi, Husquvarna Target, Stow, Wacker, Sakai, Mi-T-M, Sullair, Basic, Dynapac, MBW, Weber, Bartell, Bennar Newman, Haulotte, Ditch Runner, Menegotti, Morrison, Contec, Buddy, Crown, Edco, Wyco, Bomag, Laymor, EZ Trench, Bil-Jax, F.S. Curtis, Gehl Pavers, Heli, Honda, ICS/PowerGrit, IHI, Partner, Imer, Clipper, MMD, Koshin, Rice, CH&E, General Equipment, Amida, Coleman, NAC, Gradall, Square Shooter, Kent, Stanley, Tamco, Toku, Hatz, Kohler, Robin, Wisconsin, Northrock, Oztec, Toker TK, Rol-Air, APT, Wylie, Ingersoll Rand / Doosan, Innovatech, Con X, Ammann, Mecalac, Makinex, Smith Surface Prep, Small Line, Wanco, Yanmar

TABLE OF CONTENTS

Introduction	7
<i>CC5555GK-3 Controls</i>	8
<i>CC5555GK-3 Dimensions</i>	9
<i>CC5555GK-3 Specifications</i>	10
Safety	11
<i>Safety Alerts</i>	11
<i>Proposition 65</i>	11
<i>Spark Arrester Requirement</i>	11
<i>Respiratory Hazards</i>	11
<i>General Safety</i>	12
<i>Battery and Electrical Safety</i>	13
<i>Blade Safety</i>	13
<i>Blade Guard Safety</i>	13
<i>Fuel Safety</i>	14
<i>Engine Safety</i>	14
<i>Cutting Safety</i>	14
<i>Hydraulic Safety</i>	15
<i>Belt Safety</i>	15
<i>Transporting Safety</i>	15
<i>Lifting Safety</i>	15
Display Panel Controller	16
<i>Soft Keys (Buttons)</i>	17
<i>Status Icons</i>	18
<i>Main Gauge Screen</i>	19
<i>Dial Gauges</i>	19
<i>Digital Gauges</i>	20
<i>Soft Key Options</i>	20
<i>Main Menu Action Items</i>	20
<i>Gauges</i>	21
<i>User Settings</i>	22
<i>System Information</i>	24
<i>Panel Configuration</i>	24
<i>Service</i>	24
<i>Automatic Shutdown</i>	24
<i>Blade Depth Stop Setting</i>	24
<i>Depth Stop Set</i>	24
<i>Reset New Blade Depth Stop Setting</i>	25
<i>Clear All Blade Depth Stop Settings</i>	25
Operating the CC5555GK-3	26
<i>Handlebars</i>	26
<i>Adjusting the Handlebars</i>	26
<i>Front Pointer</i>	26
<i>Adjusting the Front Pointer</i>	26
<i>Rear Pointers</i>	27
<i>Adjusting the Rear Pointers</i>	27
<i>Battery</i>	27
<i>Diamond Blades</i>	27

TABLE OF CONTENTS

Inspecting the Blade	27
Blade Speed	28
Installing the Blade	28
Removing the Outer Blade Flange	28
Removing the Blade	29
<i>Blade Guard</i>	30
Installing the Blade Guard	30
Removing the Blade Guard	30
<i>Flange Guard</i>	31
Installing the Flange Guard	31
Removing the Flange Guard	31
<i>Water Supply</i>	31
Using the Water Supply.....	31
Water Pump.....	32
<i>Control Grip</i>	32
Raising the Saw.....	32
Lowering the Saw.....	32
Lowering Speed.....	32
<i>Speed Control Lever</i>	32
Forward Control.....	33
Reverse Control.....	33
<i>Free Wheel Control</i>	33
<i>Positraction</i>	33
<i>Shifting Three Speed Transmission</i>	33
<i>Adding Fuel</i>	33
<i>Unleaded Fuel</i>	34
<i>Storage</i>	34
<i>Engine</i>	34
Ignition Switch	34
Tasks Prior to Starting the Engine	34
Starting the Engine	35
Stopping the Engine	35
<i>Concrete Cutting</i>	35
Helpful Hints Prior to Cutting	35
Tasks Prior to Cutting	36
Making a Cut	36
Continuing a Partial-Cut	36
Finishing a Cut.....	36
<i>Lighting</i>	36
Spot Light	36
Maintenance	37
<i>General</i>	37
<i>Pre Maintenance Preparations</i>	37
<i>General Cleaning</i>	37
<i>Cleaning Techniques</i>	37
<i>Radiator</i>	37
<i>Control Panel</i>	37

TABLE OF CONTENTS

<i>Engine</i>	37
<i>Post Cleaning</i>	37
<i>Service Schedule</i>	38
<i>Daily Service</i>	39
Check Engine Oil Level	39
Check Fuel Level	39
Hydraulic System	40
Adding Hydraulic Fluid	40
Check Radiator Coolant Level	40
Check Air Cleaner Element	41
Draining the Gearbox Heat Exchanger – Freezing Temps	41
Draining Fuel Cooler – Freezing Temps	41
Draining the Optional Water Pump – Freezing Temps	42
<i>100 Hour Service</i>	43
Clean the Air Cleaner Element	43
<i>200 Hour Service</i>	43
Replace Engine Oil and Filter	43
<i>250 Hour Service</i>	44
Changing Oil - Three Speed Gearbox	44
<i>500 Hour Service</i>	45
Replacing the In-Line Fuel Filter	45
Replacing the Outer Primary and Inner Safety Filters	45
<i>1000 Hour Service</i>	46
Replace Radiator Coolant	46
<i>Handlebars</i>	47
<i>Part Lubrication</i>	47
Front Axle	47
Rear Axle	47
<i>Inner Blade Flange</i>	47
Installing the Inner Blade Flange	47
Removing the Inner Blade Flange	47
<i>Rear Wheels</i>	47
<i>Battery</i>	48
Battery Type	48
Servicing the Battery	48
<i>Electrical System</i>	48
Fuses and Relays	48
Circuit Breakers and Terminal Blocks	49
<i>Magnetic Sensor</i>	49
Adjusting the Magnetic Sensor	49
Replacing the Magnetic Sensor	49
<i>Speed Control Lever</i>	50
Adjusting the Speed Control Lever	50
<i>Optional Water Pump</i>	51
Cleaning the Inlet Strainer	51
<i>Belt System</i>	51
Blade Drive Belts	51

TABLE OF CONTENTS

Belt Tension Setting	51
Testing the Belt Tension.....	51
Adjusting the Blade Drive Belts	52
Replacing the Blade Drive Belts	53
<i>Primary Transmission V-Belt</i>	55
Replacing the Primary Transmission V-Belt	55
Secondary Transmission V-Belt	55
Replacing the Secondary Transmission V-Belt	55
<i>Rotary Tensioner</i>	56
Adjusting the Rotary Tensioner	56
<i>Rotary Position Sensor</i>	56
Calibrating the Rotary Position Sensor.....	56
<i>Storing</i>	56
<i>Disposal</i>	56
Appendix A	57
<i>Model and Serial Numbers</i>	57
Appendix B	58
<i>Troubleshooting</i>	58
Appendix C	60
<i>Additional Resources</i>	60

To order go to Discount-Equipment.com

Introduction

Welcome to the Diamond Products family and thank you for choosing Diamond Products equipment. At Diamond Products we are driven to ensure you are completely satisfied with your product and continually strive to improve our product line so that we can offer you the best possible equipment in the industry.

This operator's manual is a critical document that provides pertinent information regarding the safety, operation, maintenance, and care of your new equipment. Keep this manual available at all times. Operate the equipment and all of its components according to this manual. Failure to comply with and understand the following safety, operation and maintenance instructions can result in serious injuries and/or death. All operators must be properly trained or supervised by experienced personnel prior to using this saw and should understand the risks and hazards involved. Diamond Products discourages improper or unintended equipment usage and cannot be held liable for any resulting damages.

Equipment modifications should be made by Diamond Products to ensure safety and design. Any modifications made by the owner(s) are not the responsibility of Diamond Products and void all equipment warranties if a problem arises as a result of the modification.

Refer to the Diamond Products Parts List for additional information and part diagrams. Refer to the engine manual and manufacturer as the primary source for all safety, operations, and maintenance instructions regarding the engine. Prior to operating, record the saw's serial number, and the engine's model and serial numbers in Appendix A.

CC5555GK-3 Controls

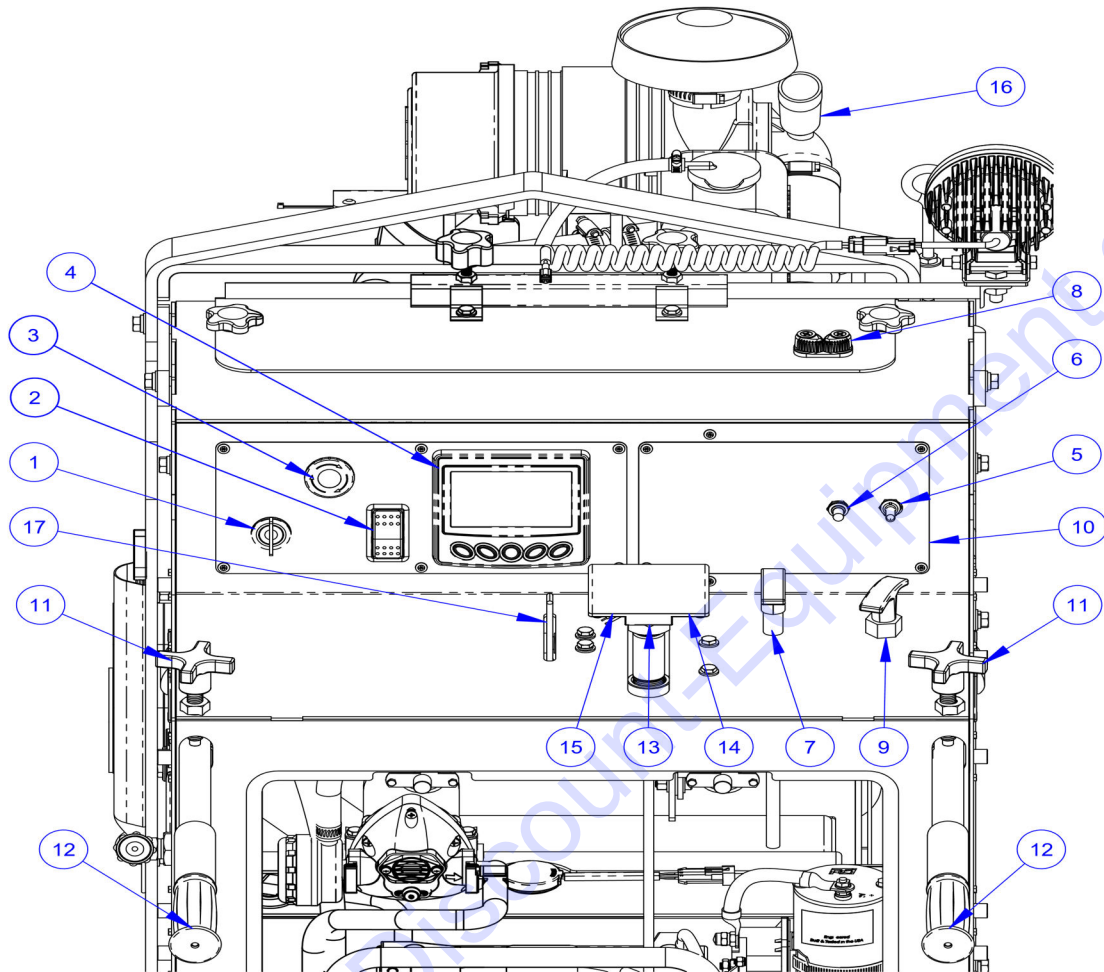

CC5555GK-3 Controls

1. **Ignition Switch** – Starts the engine and provides power to certain components.
2. **Engine Throttle Switch** – Increases and decreases engine/blade speed (RPM).
3. **Emergency Stop Button** – Stops the engine.
4. **Engine Display Panel** – Monitors and displays various engine and machine parameters.
5. **Water Pump Switch (Optional)** – Activates water pump.
6. **Spotlight Switch (Optional)** – Activates spotlight.
7. **Free Wheel Cable** – Engages and disengages the free wheel lever to move saw forward/backward.
8. **Cable Cleat** – Secures front pointer rope.
9. **Positraction Cable** – Engages/disengages the positraction to rear wheels.
10. **Fuse/Switch Panel Cover** – Allow access to fuse block assembly.
11. **Handlebar Lock Knob** – Locks the handlebar in position.
12. **Handlebar** – Allows for operator control of saw.
13. **Speed Control Lever** – Forward, reverse, and neutral control.
14. **Saw Lower Pushbutton** – Bleeds hydraulic pressure from lift cylinder to lower saw.
15. **Saw Raise Pushbutton** – Activates hydraulic pump to raise saw.
16. **Restriction Indicator** – Indicates when to service the air filter.
17. **Water On/Off Control Valve** - Turns water flow, to the saw blade, on and off.

INTRODUCTION

CC5555GK-3 Dimensions

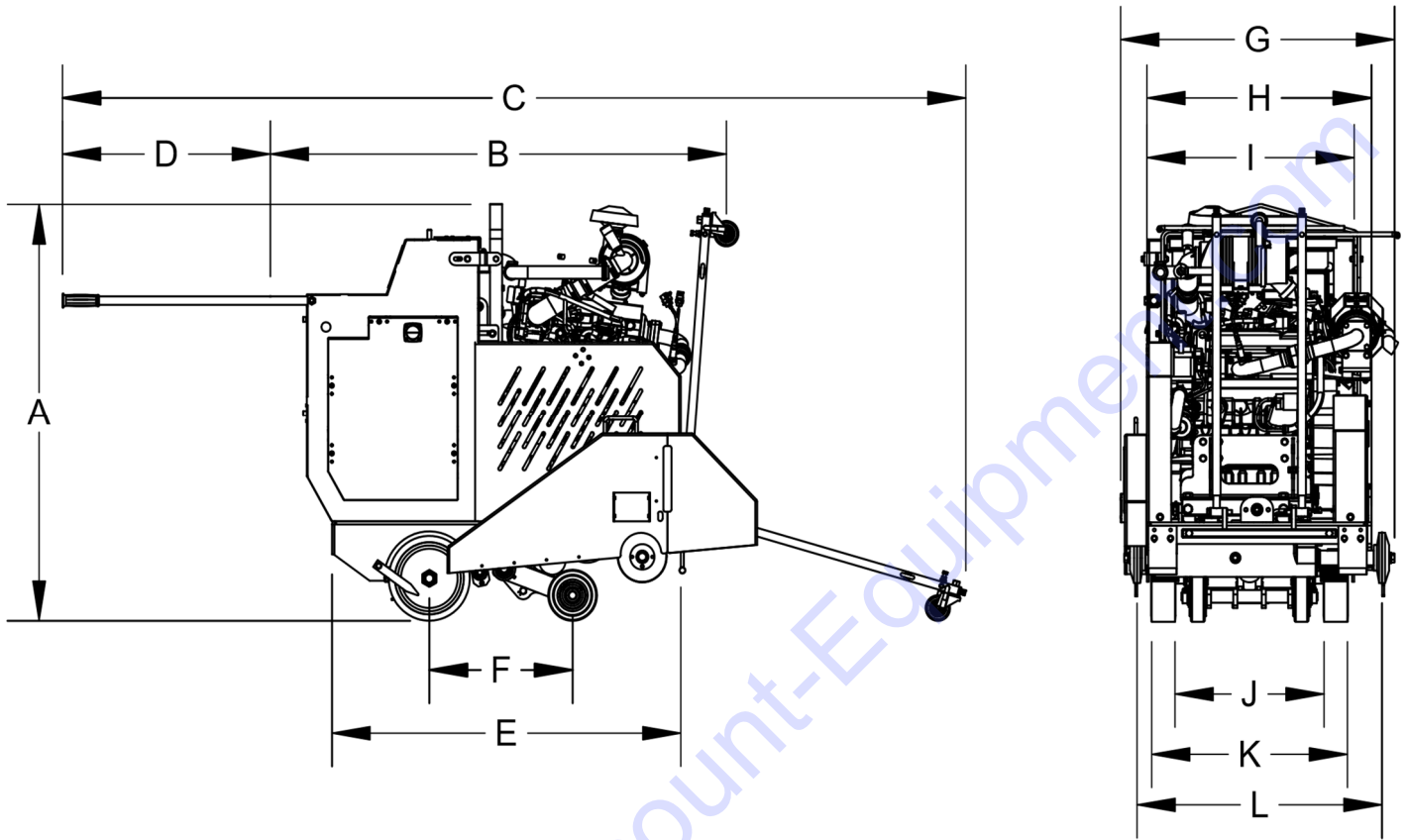

CC5555GK-3 Dimensions		Inches	Millimeters
A	Saw Height	49	1245
B	Saw Length – Minimum	51	1295
C	Saw Length – Maximum	111	2819
D	Handle Extension – Maximum	30	762
E	Frame Length	44	1118
F	Wheel Base Length	18-1/2	470
G	Saw Width	35	889
H	Frame Width (Front)	28	711
I	Frame Width (Rear)	25-1/2	648
J	Front Wheels Inside Width	18	457
K	Rear Wheels Outside Width	24	610
L	Inner Flange to Inner Flange Width	31-1/2	800

INTRODUCTION

CC5555GK-3 Specifications

Saw Specifications	
Maximum Cutting Depth	14-3/4" with 36" blade
Blade Shaft Diameter	2"
Arbor Diameter	1" with driven pin
Blade Shaft Bearings	Oil Filled
Blade Shaft Drive	7 V-Belts
Blade Mounting	Right or left
Blade Raise/Lower	Electro-hydraulic pump
Blade Coolant	Dual water tubes
Blade Guard Attachment	Slip-on
Front Wheel Dimensions	6" x 2" x 1"
Rear Wheel Dimensions	10" x 3" x 1-3/4"
Handlebars	Four-position tilt
Transmission	Eaton Model 7
Drive Speed	0-250 ft./min
Electric Start	Standard
Hour Meter	Standard
Amp Meter	Warning light
Fuel Capacity	5-1/2 gallons
Tachometer	Standard
Cutting Depth Indicator	Standard
Quick Disconnect Blade Flanges	Standard
Frame Lift	Standard
Quick Release Rear Wheels	Standard
Uncrated Weight <i>(add 100 lb. for crated weight)</i>	1,410 Lbs. - 1,450 Lbs.

Engine/Motor Specifications	
Manufacturer	Kubota
Model	WG1605
H.P. (HP / rpm)	55 / 3400 RPM
Fuel Type	Gasoline
Cylinders	4
Note: Refer to the engine manual for additional engine information and specifications.	

SAFETY PRECAUTIONS

Safety

Operate the equipment and all of its components according to this manual. Failure to comply with and understand the following safety, operation and maintenance instructions can result in serious injuries and/or death. All operators must be properly trained or supervised by experienced personnel prior to using this saw and should understand the risks and hazards involved. Diamond Products discourages improper or unintended equipment usage and cannot be held liable for any resulting damages.

Equipment modifications should be made by Diamond Products to ensure safety and design. Any modifications made by the owner(s) are not the responsibility of Diamond Products and void all equipment warranties if a problem arises as a result of the modification.

Refer to the Diamond Products Parts List for additional information and part diagrams. Refer to the engine manual and manufacturer as the primary source for all safety, operations, and maintenance instructions regarding the engine. Prior to operating, record the saw's serial number, and the engine's model and serial numbers in Appendix A.

Notice: The information in this manual may be updated at any time!

Safety Alerts



DANGER

Serious injuries and/or death will occur if these instructions are not followed.



WARNING

Serious injuries and/or death could occur if these instructions are not followed.



CAUTION

Mild and/or moderate injuries could occur if these instructions are not followed.

Proposition 65



PROPOSITION 65

WARNING: This product produces gasoline or diesel engine exhaust, which is known to the state of California to cause cancer, birth defects or other reproductive harm. For more information go to:
WWW.P65WARNINGS.CA.GOV

Spark Arrester Requirement



WARNING

In the State of California it is a violation of section 4442 or 4443 to use or operate the engine on any forest-covered, brush-covered, or grass-covered land unless the engine is equipped with a spark arrester, as defined in section 4442, maintained in effective, working order or the engine is constructed, equipped, and maintained for the prevention of fire pursuant to section 4443.

Respiratory Hazards



WARNING

Concrete cutting produces dust and fumes known to cause illness, death, cancer, respiratory disease, birth defects, and/or other reproductive harm. Safety protection techniques include, but are not limited to:

- Wearing gloves.
- Wearing safety goggles or a face shield.
- Using approved respirators.
- Washing work clothes daily.
- Using water when wet cutting to minimize dust.
- Washing the hands and face prior to eating/drinking.

For additional safety and self-protection information contact your employer, the Occupational Safety and Health Administration (OSHA), and/or The National Institute for Occupational Safety and Health (NIOSH).

SAFETY PRECAUTIONS

General Safety

- Read and understand all safety, operations, and maintenance instructions provided in this manual prior to operating or servicing the saw.
- Keep equipment components clean and free of slurry, concrete dust, and debris.
- Inspect water hoses prior to operating the equipment. Clean, repair, or replace damaged components.
- Raise the equipment to a proper height for access when working underneath the equipment. Use chocks to block the wheels, and fit blocks or jacks under the frame edges.



WARNING

Do NOT work on equipment using the hydraulic lift system to keep the equipment in the raised position for maintenance or repair. Accidental loss of hydraulic pressure could cause the equipment to drop suddenly, resulting in serious injury or death.

- When using a jack to raise the equipment, place the jack against a solid, flat area under the frame base to properly support the equipment.
- Repair the equipment immediately when a problem arises.
- Replace equipment decals if unreadable.
- Dispose of all hazardous waste materials according to city, state, and federal regulations.
- Always have a phone nearby, and locate the nearest fire extinguisher and first aid kit prior to operating the equipment.
- Operate the equipment wearing flame resistant clothing.
- Always wear safety glasses when removing retaining rings.
- Persons under the statutory age limit should not operate the equipment.
- Keep all body parts away from rotating machinery.
- Replace all guards and access panels (unless stated otherwise) prior to operating the equipment.
- Always pivot front of blade guard fully to avoid serious injuries.

DO NOT:

- Assume the equipment will remain still when in neutral or when parking/stopping the equipment on a slope. Chock the wheels to help prevent unnecessary movement.
- Drop equipment, supplies, tools, etc., when handling to help prevent injuries.
- Lift and carry equipment, supplies, tools, etc., that are too heavy and/or cannot be lifted easily.

- Operate the equipment without using the appropriate safety equipment required for the work task.



- Operate or service the equipment with any clothing, hair, or accessories that can snag in the machinery, which could lead to serious injuries or death!
- Operate the equipment using attachments not associated with or recommended for the equipment.
- Operate the equipment around combustible materials or fumes to prevent fires/explosions.
- Operate the equipment with anyone near the work area or within the direct line of the blade.
- Operate the equipment until all unnecessary materials have been removed from the work area.
- Operate the equipment with loose nuts, screws, and bolts.
- Operate the equipment when ill or fatigued.
- Operate the equipment under the influence of drugs and/or alcohol.
- Operate the equipment on steep slopes.
- Cut concrete with guards and access panels removed.
- Grease the equipment with the engine running.
- Touch hot components when operating the equipment.
- Leave the equipment unattended until the engine is off and the blade has stopped spinning.
- Place the equipment into storage until it has cooled down.
- Service the equipment until it has cooled down.
- Service the equipment with the engine running.

Battery and Electrical Safety

- Ignitable explosive gases are emitted from the battery. DO NOT expose the battery to sparks or open flames. 
- Keep the area around the battery well-ventilated.
- Keep the battery level when handling it.
- Use protective eyewear or a face shield, and avoid contact with the skin when handling/servicing the battery.
- Use a proper battery tester when testing the battery strength.
- Always be sure to connect the battery cables to the proper terminal when reconnecting the cables.
- Occasionally inspect the battery, cables, clamps, and terminals for damages. Service components as necessary.
- Always keep the battery cable clamps away from the battery terminals when the battery is disconnected to avoid accidental connections while servicing.
- Immediately rinse your clothing, skin, or eyes with water if exposed to battery acid. Seek medical attention immediately!
- Disconnect the battery prior to servicing all equipment components (unless stated otherwise).
- Remove the battery when storing the equipment for longer periods.
- Always use the correct size fuses (amps) to prevent fires.

Blade Safety

- Always use reinforced abrasive blades or steel-centered diamond blades.
- Never use a wet cutting blade without an adequate water supply to properly lubricate the blade.
- Inspect all blades prior to usage and discard damaged blades.
- DO NOT install or remove a blade with the engine running.
- Keep all body parts away from rotating blades.
- Inspect the blade flanges for damages, wear, and cleanliness. Clean or replace dirty/damaged components immediately.

- DO NOT expose yourself or anyone else to the direct line of the blade when operating the equipment. 

- Always use an appropriate size blade and the correct blade type based on the cutting task and the type of material being cut.
- The blade must always fit snug on the blade shaft, outer flange, and/or inner flange.
- Wear gloves and be alert to the surrounding environment when handling blades.
- When installing the blade, always point the arrow printed on the blade in the direction of the blade shaft's rotation.
- DO NOT exceed the blade's maximum recommended speed when cutting. Excessive blade speeds can cause blade breakage, resulting in serious injuries and/or death!
- DO NOT use damaged blades when cutting to avoid harming yourself, others, or the equipment.
- DO NOT use a blade for cutting that requires a lower speed than the blade shaft speed.
- Always tighten the blade shaft bolt/screw as directed to properly secure the outer flange and blade. Failure to properly secure the outer flange and blade may cause parts to loosen or fall off the equipment, resulting in serious injuries or death!
- Let the blade cool prior to removal when dry cutting (applicable models).

Blade Guard Safety

- DO NOT operate the equipment with the blade guard raised or removed.
- Blade exposure should not exceed 180° while cutting.
- When pivoting the front of the blade guard, raise/lower it cautiously and slowly to avoid serious injuries.
- DO NOT pivot the blade guard front up or down when installing/removing very large blades. Attempting to pivot the front of a heavy guard when the guard is positioned higher up for blade installation/removal makes the guard difficult to lift and/or lower. In this situation, install/remove the blade guard front instead of pivoting it.

SAFETY PRECAUTIONS

- Always pivot the front of the blade guard 180° (fully upward) so the guard does not swing down unexpectedly, causing serious injuries.



- Always secure the pivoted section of the blade guard using the detent pin (guards 26" and up).
- Use extreme caution when installing/removing parts of a guard or the entire guard as guards can be extremely heavy and may require installation/removal at moderate heights.
- DO NOT install or remove the blade guard with the engine running.
- Always use a blade guard that corresponds with the blade size.
- Inspect the blade guard and water tubes prior to starting the equipment. Clean or replace dirty/damaged components immediately.

Fuel Safety

- Always use caution when refueling.
- Store all fuel in appropriate safety containers.
- DO NOT operate the equipment with a fuel leak.
- DO NOT fuel the equipment with the engine running.
- Let the engine cool prior to adding fuel.
- Refer to the engine manual for recommended fuels.
- Always use appropriate fuels in cold weather.
- Move the equipment away from the refueling area prior to starting the engine.

- DO NOT smoke or expose fuel to open flames when filling the fuel tank or working with fuel.



- Clean up any spilled fuel prior to starting the engine.
- Drain the fuel tank and fuel lines when storing the equipment for longer periods of time. Refer to the engine manual for additional recommendations.

Engine Safety

- Refer to the engine manual as the primary source for engine safety.
- Always know how to turn off the engine quickly for emergency purposes.

- Make sure the equipment is in neutral when starting the engine.
- Fill the fuel tank and check the oil level prior to starting the engine.

- Keep all body parts away from rotating equipment parts with the engine operating.



- DO NOT start the engine without the air filter(s) installed.
- DO NOT allow dust to enter the air intake tube when cleaning/replacing air filter(s).
- Replace damaged components immediately that may allow dust to enter the engine.
- DO NOT leave the engine running unattended.

- Always operate the equipment in well-ventilated areas. Concentrated engine exhaust can cause loss of consciousness and/or death.



- DO NOT touch the engine/muffler assembly with the engine running, and always let them cool down prior to touching or servicing the equipment.
- Handle hot oil carefully when changing the oil.
- Let the engine cool prior to removing pressurized caps (applicable models).
- DO NOT use any starter substances or starter fluids (e.g., starter fluid sprayed into the air filter) when starting the engine using a glow plug (applicable models). These materials are extremely flammable and explosive, and can melt parts or possibly explode when used to help start the engine.

Cutting Safety

- The direct work area should not contain buried or embedded electrical, gas, or water lines that could be damaged and/or cause personal injury while cutting.
- Turn off all electricity, gas, and water around the direct work area prior to cutting.
- Inspect the work area to ensure nothing will impede full control of the machine at all times.
- DO NOT expose yourself or anyone else to the direct line of the blade when operating the equipment.

SAFETY PRECAUTIONS

- DO NOT allow any person, animal, and/or objects in and around the work area while cutting.
- DO NOT install a blade on the machine until it is in the cutting area.
- Ensure the work area is adequately illuminated to ensure safe operation of the machine.

Hydraulic Safety

- Turn off the engine prior to servicing hydraulic components.
- Lower the equipment completely prior to servicing to decrease the hydraulic pressure in the lines.
- Always make sure any hydraulic components being serviced are not supporting the weight of other equipment components. If a particular component is under pressure when connection points are loosened, oil may spray out forcefully.

- Always place a piece of cardboard or paper up against hydraulic components, or use a leak detection fluid to check for hydraulic fluid leaks. Keep all body parts away from leaks and/or areas that may eject hydraulic fluid. Pressurized hydraulic fluid can penetrate the skin, causing serious injuries. Seek medical attention immediately!



Belt Safety

- Turn off the engine and let the belts cool down prior to servicing them.
- Regularly inspect the belts for fraying, stress cracks, and/or breakage and replace immediately when damaged. Always check the belt alignment prior to operating the equipment.
- Use extreme caution when working with belts and rotating machine parts to avoid entanglement.
- Over-tensioning belts may reduce the life of the gearbox bearings. Under-tensioning belts may cause slippage, shorter belt life, and/or poor equipment performance.
- Squealing belts indicate looseness.
- DO NOT use old and new belts together on the same sheave.

Transporting Safety

- Remove the blade prior to transporting the equipment.
- Make sure the truck/trailer is in good, working condition and sufficient to transport the load. DO NOT tow the equipment behind a vehicle.
- Close the fuel shutoff valve (applicable models) when transporting.
- Drain the fuel tank when transporting long distances.
- Use heavy-duty ramps that will support the weight of the equipment and yourself when loading or unloading.
- Raise the equipment to avoid damaging components while moving up and down ramps.

- Use extreme caution when guiding the equipment up and down ramps. Slowly drive the equipment forward down the ramp. Slowly back the equipment in reverse up the ramp. Avoid standing directly downhill from the equipment to prevent machine rollover.



- Place the equipment in neutral and turn off the engine once the equipment is loaded in the truck/trailer.
- Chock the wheels and secure the saw in the truck/trailer prior to transporting.
- Refer to the Department of Transportation (DOT) for additional transportation recommendations.

Lifting Safety

- Move yourself and all others away from the lifting area when hoisting the saw to prevent being crushed.



- Secure the appropriate hoisting cables, straps, and/or chains to the saw's designated lift points prior to hoisting.
- Never use the tie-down brackets (applicable models) to lift the saw.
- DO NOT attempt to lift the saw irresponsibly and/or improperly.

Display Panel Controller

The display panel is a rugged Controller Area Network or CAN. This is a means of linking all of the electronic systems within the saw together allowing them to communicate with each other. This manual explains the functions of the unit, describes the display screens and gives details about the configuration.

Turning the ignition switch to run or start will activate a sequence of screens on the display panel. First, you will see the Diamond Products logo and then the main gauge screen which is considered the home screen. If one or more of the emergency stop triggers are activated, E-stop switch is active, or coolant level is low, an emergency shutdown window will be displayed. Operator must clear these messages before engine can start.



Main Gauge Screen with Emergency Shutdown Window



Main Gauge Screen (Home Screen)











The Main Gauge Screen (Home) displays (3) dial gauges and (6) digital gauges.

Dial Gauge	Digital Gauge
Engine/Tachometer Speed (RPM)	Oil Pressure – Lamp Only (psi)
Engine Coolant Temperature (°F)	Fuel Level (%)
Electrical Potential Voltage (V)	Engine Hours – Total Operation (H)
	Engine Hours – Service (H)
	Blade Depth (in)
	Depth Set (in)

DISPLAY PANEL CONTROLLER



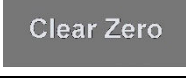



Soft Keys (Buttons)

The Soft Key choices provide different selection options. These will appear on the bottom of the display screen and can be selected by pushing the button directly below the soft key.

Soft Key	Description
	Freeze Frame – Requests the freeze frame data from the ECU when faults are present
	Main Menu – Two pages that list seven action items. Five are available to the operator: Gauges, Diagnostics, System Info, Lamp Info and User Settings. (Panel Configuration and Service are reserved for technical support)
	Down – Navigates the cursor downward through a list
	Up – Navigates the cursor upward through a list
	Select – Enters the action item next to the cursor in a list. Also used with the Main Menu soft key to get back to the Main Menu from any screen
	Deselect – Closes pop-up messages
	Plus – Increases a numerical selection
	Minus – Decreases a numerical selection
	Zero Blade – Sets the reference point for the blade depth setting
	Clear Zero – Clears the reference point for the blade depth setting
	Set Depth Stop – Sets the blade depth stop setting
	Clear Depth Set – Clears the blade depth stop setting

Status Icons

The Status Icons are color coded and light up when communicating to the operator. Pay close attention to any Status Icons and color if they appear.

Status Icon	Description
	Check Engine – Yellow icon is visible if the controller receives a DM1 (Active Diagnostic Trouble Code) message with an amber lamp command. Red icon is visible if the controller receives a DM1 message with a red lamp command.
	Emergency Stop Button – Red icon displays when emergency stop button is engaged.
	Oil Pressure – Red icon displays when oil pressure is low.
	Low Coolant Level Lamp – Red icon displays during active low coolant condition.
	Battery Voltage – Green icon will display for normal operations. Icon will become yellow when voltage level is low.
	Fuel Level – Green icon will display when fuel level is normal. Icon will become yellow when fuel level is low.

Glossary of Terms and Acronyms

- CAN – Controller Area Network
- DM1 – Diagnostic Message 1, Active Diagnostic Trouble Codes
- DM2 – Diagnostic Message 2, Previously Active Diagnostic Trouble Codes
- DM4 – Freeze Frame Parameters
- DTC – Diagnostic Trouble Code
- ECU – Engine Control Unit
- FMI – Failure Mode Identifier
- PGN – Parameter Group Number
- SPN – Suspect Parameter Number

Main Gauge Screen

The Main Gauge Screen is the default (Home) screen when the saw is turned on. There are three soft key options available from the Home screen:

1. Zero Blade / Clear Zero
2. Set Depth Stop / Clear Depth Stop
3. Main Menu Soft Key (☰).

There are three dial gauges displayed showing:

1. Engine/Tachometer Speed
2. Engine Coolant Temperature
3. Electrical Potential Voltage (Battery).

There are six digital gauges displayed showing:

1. Oil Pressure
2. Fuel Level
3. Engine Hours – Total Operation
4. Engine Hours – Service
5. Blade Depth
6. Depth Set



Main Gauge Screen (Home)

Dial Gauges

The three dial gauges on the home screen are as follows:

- Engine/Tachometer Speed – This dial indicates both the engine RPM as well as the blade shaft RPM. Engine RPM is indicated with a red arrowhead (#1) and the blade shaft RPM is indicated with a red line pointer (#2).

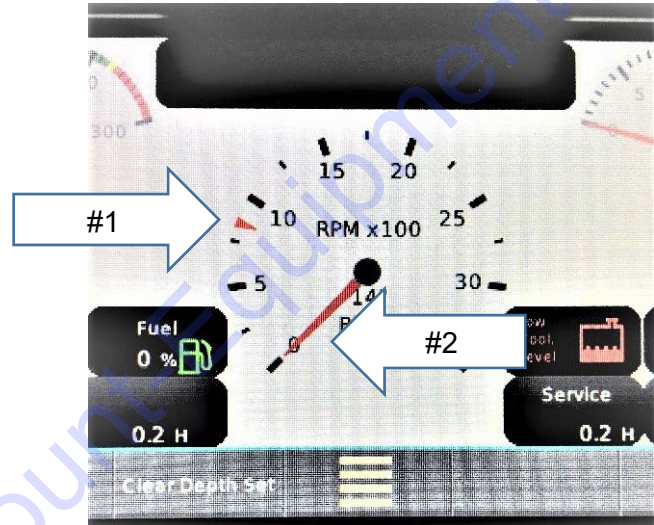

RPM Gauge Indicator Arrows

- Engine Coolant Temperature – This gauge indicates the coolant temperature, in degrees Fahrenheit, at the inlet of the engine's thermostat.
- Electrical Potential Voltage - This gauge indicates the actual battery voltage.

Digital Gauges

The six digital gauges on the home screen provide the following input:

- Oil Pressure – This gauge indicates the engine oil pressure in PSI.
- Fuel Level – This gauge indicates current fuel tank level in (%).
- Engine Hours, Total Operation – This gauge indicates the total hours that the engine has been in service.
- Engine Hours, Service – This gauge indicates the total number of hours between servicing of the saw. It can be reset to zero to track service requirements.
- Blade Depth – This gauge indicates how deep the blade has penetrated the concrete past the zero set point.
- Blade Depth Set - Indicates what the blade depth is set at. The saw will not travel any further until the depth set point is cleared using the soft key option.

Soft Key Options

The three soft key options on the home screen are as follows:

- Zero Blade / Clear Zero – This option allows the operator to set or zero the blade depth indication shown on the blade depth digital display.
- Set Depth Stop / Clear Depth Stop – This option allows the operator to set or clear the depth stop setting shown on the depth set digital display.
- Main Menu Soft Key (☰) – This option allows the operator to scroll through the main menu action items.

Main Menu Action Items

Press the Main Menu (☰) soft key to view the menu action list. Scroll through the Main Menu action list on two screens, using the Up/Down soft keys to maneuver the cursor to the action item you want, then press the Select (⊙) soft key.

1. Gauges (Main Menu default screen)
2. Diagnostics
3. User Settings
4. Panel Configuration (Password Required)
5. Service (Password Required)
6. System Information

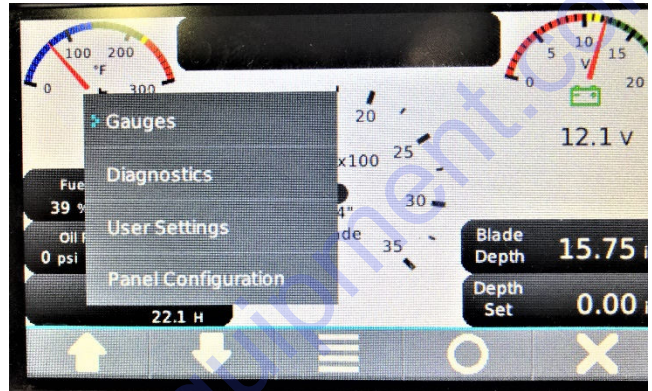

Main Menu Action Items – Screen 1

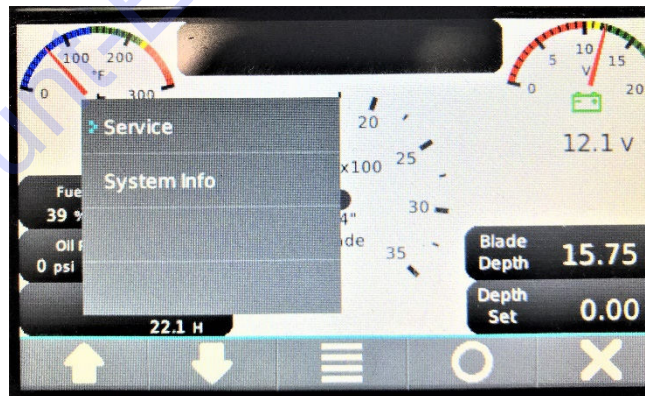

Main Menu Action Items – Screen 2

Gauges

Returns screen to Main Menu

Diagnostics

The screen displays the following items:

- Active Diagnostics
- Logged Diagnostics



Active or Logged Diagnostics

Uses the UP/DOWN soft keys and stop the cursor next to the action item Active Diagnostics.

Press the Select (●) soft key .The screen displays active warnings or faults from the ECU. Each diagnostic is shown with the appropriate Suspect Parameter Number (SPN) and Failure Mode Indicator (FMI), Text Description (if available) and the ID/Name of the device that transmitted the DM1 message.

Press the UP/DOWN soft keys to reach the next diagnostic in the list.



Active Diagnostics Screen

Logged Diagnostics

Use the UP/DOWN soft keys, and stop the cursor next to the action item Logged Diagnostics. Press the Select (●) soft key. The screen displays the controller requests DM2 (stored trouble codes, not active), warning or faults from the ECU. Each diagnostic is shown with the appropriate information:

- Suspect Parameter Number (**SPN**)
- Failure Mode Indicator (**FMI**)
- Text Description (if available)
- ID/Name of the device that transmitted the DM1 message



Logged Diagnostics

Note: Select the Freeze Frame Button to request the freeze frame data from the ECU when faults are present.

User Settings

Scroll through the Menu list using the UP/DOWN soft keys, and stop the cursor next to the action item **User Settings** - Press the Select (Ⓚ) soft key. The screen displays the following action items:

- Colors
- Brightness
- Language
- Units

Screen Color

Using the UP/DOWN soft keys stop the cursor next to the action item, Colors. Set your preference for day or night vision by using the +/- soft keys. To exit the screen select the Main Menu (≡) soft key and then the Select (Ⓚ) soft key.



Night Setting Preference Screen

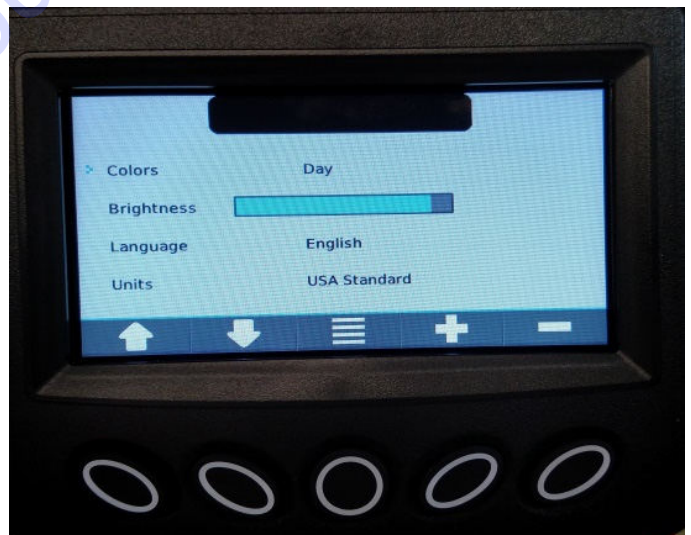

Day Setting Preference Screen

Screen Brightness

Using the UP/DOWN soft keys stop the cursor next to the action item **Brightness**. Set the brightness of the backlight by using the +/- soft keys. To exit the screen select the Main Menu (≡) soft key and then the Select (Ⓚ) soft key.

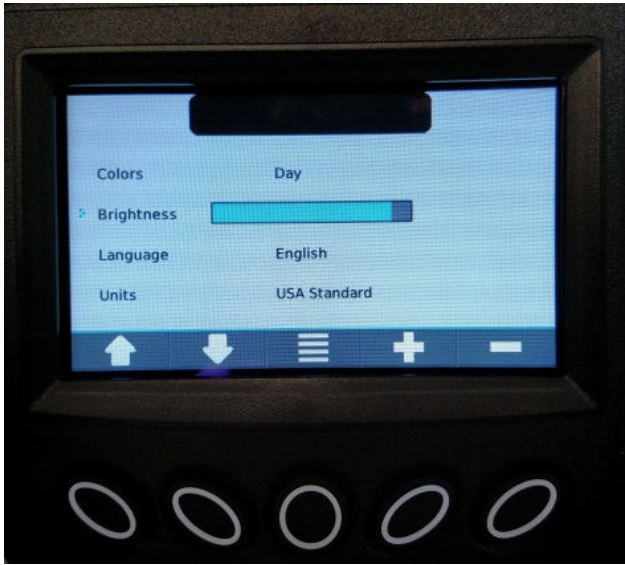

Screen Brightness

Language

Using the UP/DOWN soft keys stop the cursor next to the action item, **Language**. Set your language preference using the +/- soft keys.

- English
- French
- German
- Spanish
- Italian
- Japanese

To exit this screen, select the Main Menu (☰) soft key and then the Select (⊙) soft key.

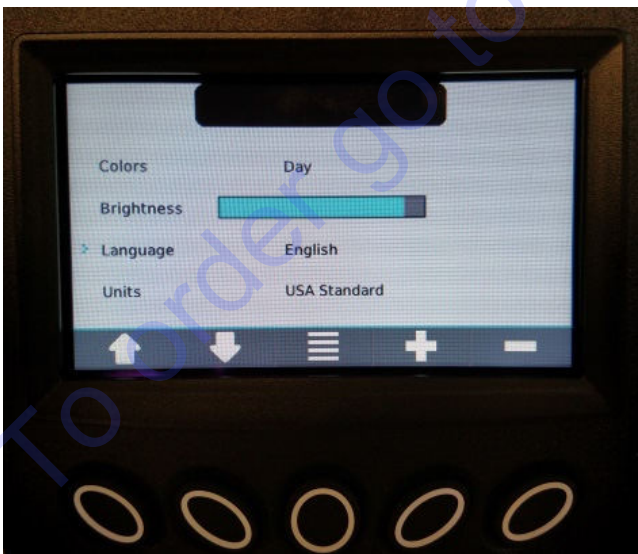

Figure 1: Set Language Preference Screen

Units

Using the UP/DOWN soft keys stop the cursor next to the action item, **Units**. Set your unit preference using the +/- soft keys. To exit the screen select the Main Menu (☰) soft key and then the Select (⊙) soft key.

- USA Standard
- Metric kPa
- Metric Bar

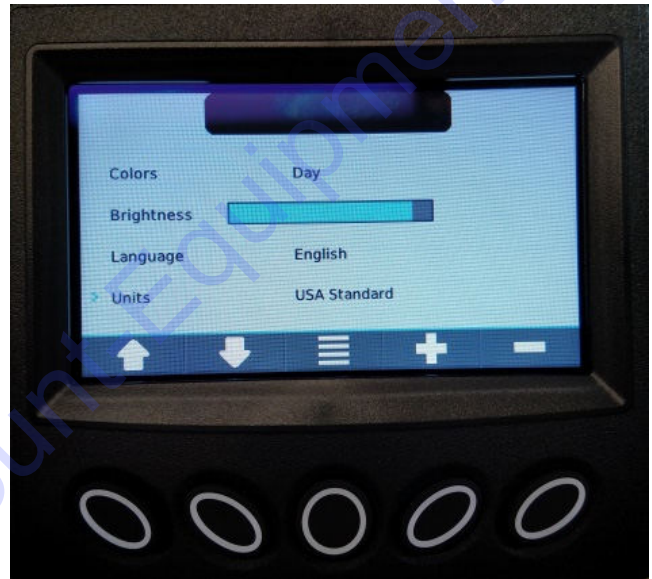

Figure 2: Set Unit Preferences Screen

System Information

Scroll through the Menu list using the UP/DOWN soft keys, and stop the cursor next to the action item System Info. Press the Select (⏏) soft key. The screen displays the following items:

- Engine Model
- Engine Serial Number
- ECU Software ID
- Fuel Rate
- File Name of Installed Software

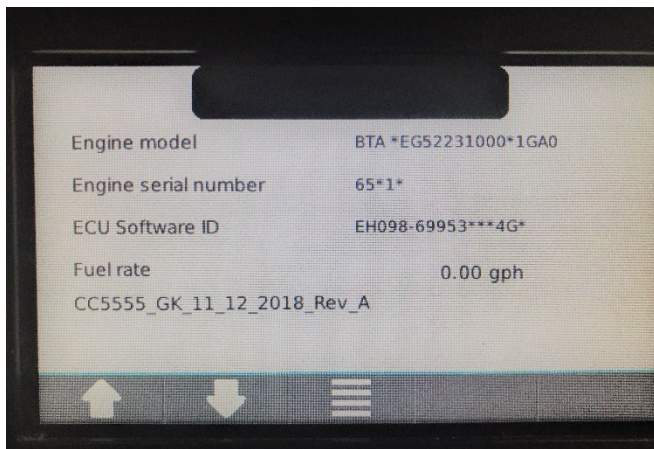

Figure 3: System Info Screen

Press the DOWN soft key to display component version information.

Panel Configuration

Password required.

Service

Password required.

Automatic Shutdown

There are two faults the engine communicates to the display screen to initiate a shutdown. The two faults from the ECU are displayed on the display screen as P0093 and P1274 to the operator. The engine is shutdown for safety reasons. Contact a qualified service facility if this occurs.

Blade Depth Stop Setting

1. Lower the saw until the blade touches the cutting surface.
2. Press the “Zero Blade / Clear Zero” soft key located on the lower left of the display panel until the digital “Blade Depth” gauge on the lower right of the display shows “0.00 in.”.
3. If the digital “Depth Set” gauge, located beneath the digital “Blade Depth” gauge is not set to 0.00 in., then press the “Clear Depth Set” soft key located to the left of the “Zero Blade” soft key.



Zero Blade

4. Lower the saw blade into the cut to the desired depth, then press the “Set Depth Stop” soft key to lock in the depth setting. The saw can now raise to the full up position but it will only lower down to the set depth.

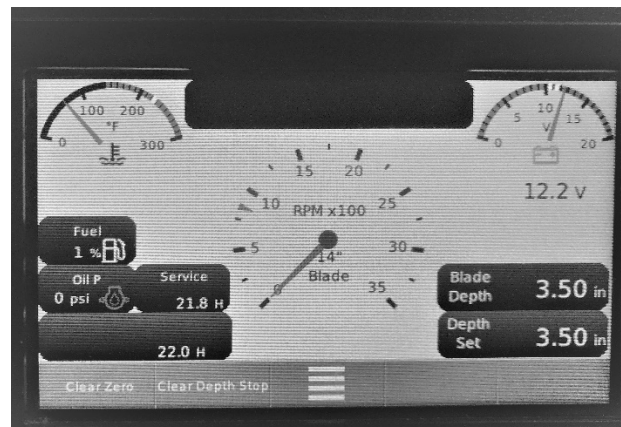

Depth Stop Set

Reset New Blade Depth Stop Setting

1. To clear the depth setting and reset to a new setting, press the “Clear Depth Stop” soft key. *DO NOT clear the zero setting.*
2. Lower the saw blade into the cut until the new desired depth is attained, then press the “Set Depth Stop” soft key. The depth stop is now set to the new depth setting.

Clear All Blade Depth Stop Settings

To clear all of the blade depth settings:

1. Press the “Clear Depth Stop” soft key.
2. Press the “Clear Zero” soft key.

All blade depth stop settings are now clear.

To order go to Discount-Equipment.com

Operating the CC5555GK-3

Handlebars

The handlebars help the operator guide and maneuver the saw.

Adjusting the Handlebars

1. Loosen both handle lock knobs.
2. Hold the handlebar grip and place the first handlebar into the handlebar opening below the handle lock knob. The handlebar fits through four different adjustment angles inside the handlebar opening (0°, 15°, 30°, and 45°). Place the handlebar at the desired angle.
3. Tighten the handle lock knob to secure the handlebar.

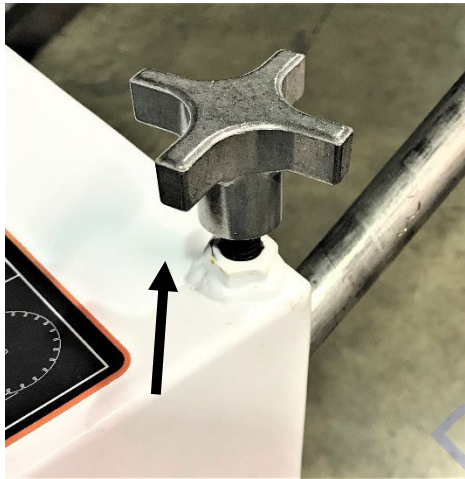

Handle Lock Knob and Handlebar

4. Repeat steps 2–3 to secure the second handlebar.

Front Pointer

The front pointer assembly helps the operator follow the cutting line.

Adjusting the Front Pointer

1. Remove the pointer lanyard from the cable cleat on the frame upright.
2. Lower the front pointer frame to the floor.
3. Loosen both front pointer frame screws.
4. Divide an 8–10 ft. piece of string in half.
5. Place the looped end of string into a gullet on the backside of the blade.
6. Place one string line up against the backside of the blade and one string line up against the

front side of the blade. Holding the string ends in one hand, tension the lines out toward the front pointer rod.

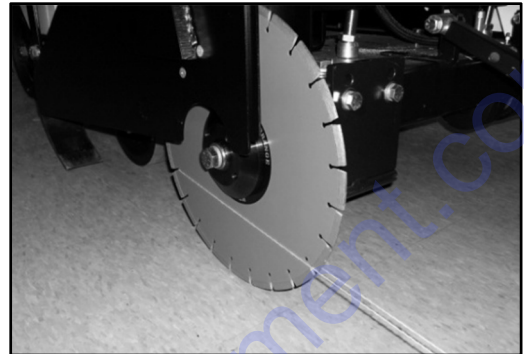

String Line against Blade

7. Place the cap of the pointer in between the tensioned string lines.

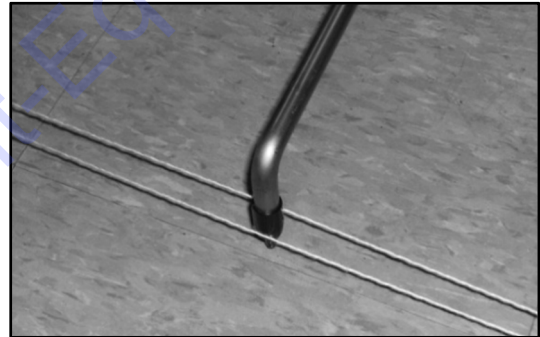

Pointer Cap between String Lines

8. Retighten both front pointer frame screws to secure the pointer rod.
9. Lift the front pointer frame off of the floor when the cutting task is complete.
10. Tension the pointer lanyard, and then place the lanyard into the cable cleat to secure the front pointer.

Rear Pointers

The rear pointer rods act as guides when cutting.

Adjusting the Rear Pointers



Rear Pointer

Loosen the rear pointer bolt and to move the pointer up or down, and then retighten the bolt to secure.

Battery

! WARNING

Ignitable explosive gases are emitted from the battery. DO NOT expose the battery to sparks or open flames, and keep the area around the battery well-ventilated.



! CAUTION

Use a proper battery tester, such as a voltmeter, to test the battery strength. Use protective eyewear or a face shield, and avoid contact with the skin when handling a battery.



The saw contains a charged battery with one positive battery cable lead and one negative battery cable lead.

Diamond Blades



! WARNING

DO NOT exceed the blade's maximum recommended speed when cutting. Excessive blade speeds can cause blade breakage, resulting in serious injuries and/or death.

Using the proper blade (size and type) preserves the blade and improves cutting and operator efficiency, resulting in lower costs. Refer to www.discount-equipment.com for a list of different blade types and additional blade information.

Inspecting the Blade

Inspect each blade prior to installation and discard all damaged blades. Inspect all blades for:

- Cracks, nicks, and dents.
- A damaged and/or deformed arbor (center hole).
- Darkness and/or discoloration near edge of blade.
- A deformed blade circumference.
- Segment loss and/or segment cracks.
- Core wear.
- Bending.
- Uneven side-widths.

Blade Speed

Refer to the CC5555GK-3 RPM Chart, the blade, or the blade packaging information for the recommended blade speeds when cutting. DO NOT exceed the maximum recommended blade speed. DO NOT use a blade for cutting that requires a lower speed than the minimum blade shaft speed.

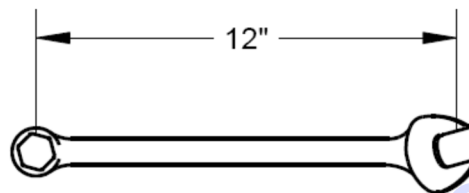

Figure 4: Wrench

CC5555 RPM CHART				
BLADE SIZE	BLADE RPM	GEAR POSITION	ENGINE RPM	MAX. CUT DEPTH
14"	3,400	H (High)	3,400	3-3/4"
16"	3,400	H (High)	3,400	4-3/4"
18"	2,235	M (Medium)	3,400	5-3/4"
20"	2,235	M (Medium)	3,400	6-3/4"
24"	2,235	M (Medium)	3,400	8-3/4"
26"	1,470	L (Low)	3,400	9-3/4"
30"	1,470	L (Low)	3,400	11-3/4"
36"	1,470	L (Low)	3,400	14-3/4"

Below the table are five small diagrams: 1. A circular diagram showing gear positions M, L, and H. 2. A diagram of a gear with a red arrow indicating rotation. 3. A diagram of a gear with a red arrow and the letters M, L, and H. 4. A diagram of a gear with a red arrow and a red 'X' indicating a warning. 5. A diagram of a gear with a red arrow and a red 'X' indicating a warning.

CC5555GK-3 RPM Chart

Install the blade on either the right or left side of the saw; utilize the most appropriate side for the cutting task. **Changing the blade size requires assistance from technical support. Contact technical support prior to running the saw.** Refer to the RPM & Gear Position chart posted on the saw, or in the Diamond Products' Parts List for additional information.

Removing the Outer Blade Flange

Installing the Blade

! WARNING

DO NOT install a blade with the engine running. Failure to properly secure the outer flange and blade may cause parts to loosen or fall off of the saw.

! CAUTION

Wear gloves and be alert to the surrounding environment when handling blades.

Use the 15/16" combination wrench that comes with the saw when installing/removing a blade. Apply force to the opposite end of the wrench and tighten the bolt to 125 ft-lb (169.5 Nm) to properly secure the outer flange and blade. This measurement can be verified with a torque wrench.



Blade Flanges Together

1. Remove the blade shaft bolt using the wrench. Turn the bolt clockwise (left-hand threads) on the right side of the saw, and counterclockwise (right-hand threads) on the left side of the saw.
2. Remove the bolt and wedge lock washer, and carefully pull the outer flange out of the inner flange alignment pin hole and blade shaft.

OPERATING



Blade Flanges Separated

3. Inspect the bolt, outer flange, inner flange, and inner flange alignment pin hole for visible damages and clean, repair, or replace as necessary.
4. Select the correct blade type for the cutting task and inspect the blade for visible damages.
5. Raise the saw slightly to provide room to install the blade.
6. Place the blade next to the inner flange. Always point the arrow printed on the blade in the direction of the blade shaft's rotation when installing the blade.
7. Align and fit the outer flange alignment pin and shaft through the blade holes, and into the blade shaft and inner flange alignment pin hole.

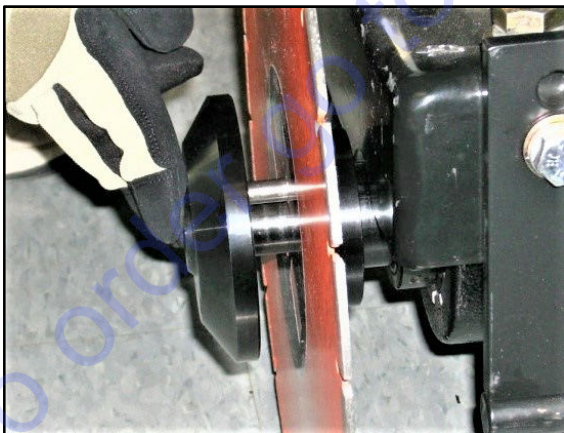

Inserting the Outer Flange

8. Slightly rotate the outer flange and blade backward to eliminate backlash (looseness) between parts.

9. Place the wedge lock washer onto the blade shaft bolt and insert the bolt into the blade shaft.
10. Tighten the bolt by hand as much as possible, and slowly lower the blade until it just touches the ground's surface.
11. Tighten the bolt, using the wrench, to 125 ft-lb (169.5 Nm) to properly secure the outer flange and blade. This measurement can be verified with a torque wrench.

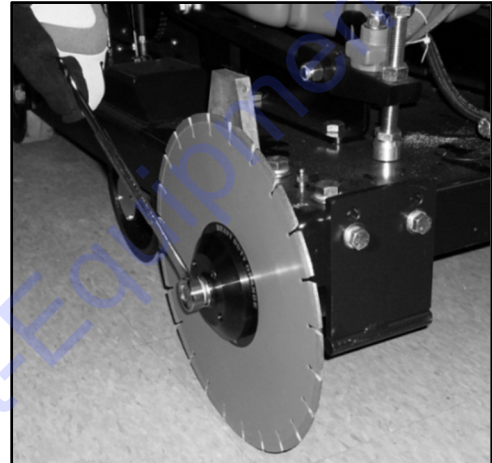

Tightening the Bolt

12. Reattach the blade guard or pivot the front of the guard down and over the blade to secure.

Removing the Blade

! CAUTION

Always let the blade cool prior to removing or replacing blades when dry cutting.



1. Remove the blade guard or pivot the front of the guard 180° (fully upward) to gain access to the blade flanges.
2. Slowly lower the blade until it just touches the ground's surface.
3. Remove the blade shaft bolt and wedge lock washer from the blade shaft.
4. Carefully pull the outer flange out of the inner flange alignment pin hole and blade shaft, and then remove the blade. Place the blade in the appropriate storage location.
5. Inspect the bolt, outer flange, inner flange, and inner flange alignment pin hole for visible damages and clean, repair, or replace as necessary.

OPERATING

- Align and fit the outer flange alignment pin and shaft into the blade shaft and inner flange alignment pin hole.
 - Place the wedge lock washer onto the blade shaft bolt and insert the bolt into the blade shaft.
 - Tighten the bolt by hand to secure the inner and outer flange together.
 - Reattach the blade guard or pivot the front of the guard down and over the blade to secure.
- Connect one end of the water supply hose to the gearbox and the other end to the blade guard hose fitting.

Blade Guard



WARNING

DO NOT operate the saw with the blade guard raised or removed.

DO NOT remove the blade guard with the engine running.

Blade exposure when cutting should not exceed 180°. Always pivot the front of the blade guard 180° (fully upward) and secure with pin so the guard does not swing down unexpectedly, causing serious injuries.

The blade guard shields the blade and must always be in place when operating the saw. Be sure to use a guard that matches the blade size.

Installing the Blade Guard

- Regularly inspect the blade guard water tubes for cuts, slurry, and/or debris. Clean or replace the tubes as necessary.
- Place the square mount from one side of the blade guard down onto the blade guard mount on the frame base and slide down until fully seated on the frame base.

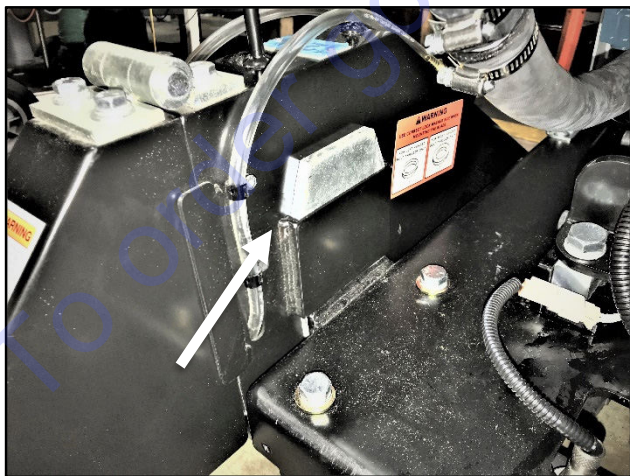

Lowering the Guard

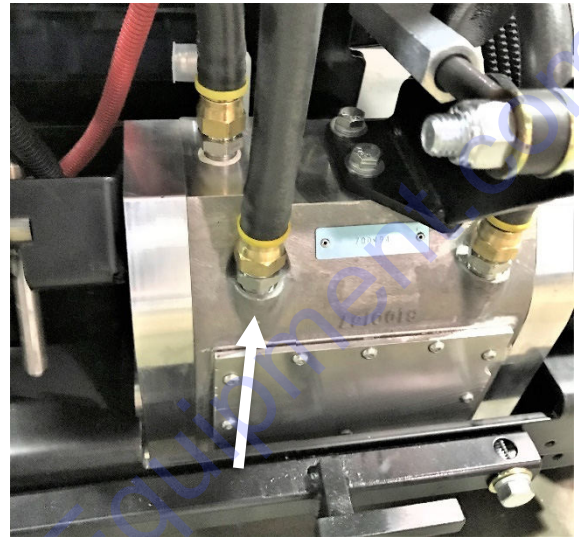

Water Supply from Gearbox

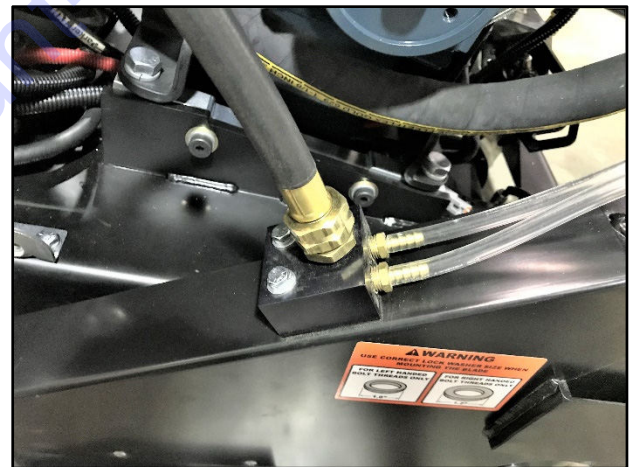

Blade Guard Hose Fitting

Removing the Blade Guard

- Disconnect the water supply hose from the blade guard hose fitting.
- Use the handle on the blade guard to rock the guard back and forth while lifting the guard off of the blade guard mount.

TO PURCHASE THIS PRODUCT PLEASE CONTACT US



**Equipment Financing and
Extended Warranties Available**



**Discount-Equipment.com is your online resource for
commercial and industrial quality parts and equipment sales.**

561-964-4949

visit us on line @ www.discount-equipment.com

Select an option below to find your Equipment

Search by Manufacturer

Search by Product Type

Request a Quote

We sell worldwide for the brands: Genie, Terex, JLG, MultiQuip, Mikasa, Essick, Whiteman, Mayco, Toro Stone, Diamond Products, Generac Magnum, Airman, Haulotte, Barreto, Power Blanket, Nifty Lift, Atlas Copco, Chicago Pneumatic, Allmand, Miller Curber, Skyjack, Lull, Skytrak, Tsurumi, Husquvarna Target, Stow, Wacker, Sakai, Mi-T-M, Sullair, Basic, Dynapac, MBW, Weber, Bartell, Bennar Newman, Haulotte, Ditch Runner, Menegotti, Morrison, Contec, Buddy, Crown, Edco, Wyco, Bomag, Laymor, EZ Trench, Bil-Jax, F.S. Curtis, Gehl Pavers, Heli, Honda, ICS/PowerGrit, IHI, Partner, Imer, Clipper, MMD, Koshin, Rice, CH&E, General Equipment, Amida, Coleman, NAC, Gradall, Square Shooter, Kent, Stanley, Tamco, Toku, Hatz, Kohler, Robin, Wisconsin, Northrock, Oztec, Toker TK, Rol-Air, APT, Wylie, Ingersoll Rand / Doosan, Innovatech, Con X, Ammann, Mecalac, Makinex, Smith Surface Prep, Small Line, Wanco, Yanmar

Flange Guard

Installing the Flange Guard

1. Place the square mount of the flange guard down onto the blade guard mount on the frame base and slide down until fully seated on the frame base.



Flange Guard

2. Turn the locking thumb screw clockwise to tighten the guard to the frame mount.

Removing the Flange Guard

1. Turn the locking thumb screw counter-clockwise to loosen.
2. Lift the flange guard off of the blade guard mount.

Water Supply

The water supply cools the blade and minimizes dust when cutting. *Note: Always test the water supply for adequate pressure and flow before cutting.*

Using the Water Supply

1. Connect the water source hose to the water supply fitting on the left side of the saw.



Water Supply Connection

2. Connect the water supply hose from the gearbox to the blade guard hose fitting. *Note: Disconnect and reconnect the hose when moving the blade guard to the opposite side of the saw.*
3. Push the water valve forward to start the water flow and pull the water valve backward to stop the water flow. The water flow between these two points increases/decreases based on the valve's position. *Note: Turn on the water just before cutting to avoid wasting water.*



Water Valve - ON



Water Valve - OFF

4. Disconnect the water supply hose from the blade guard hose fitting when the cutting job is complete.

Water Pump

The water pump (optional item) directs water from the water source hose to the saw blade.

1. Ensure all water supply lines are connected.
2. Ensure that the water valve located on the control panel is in the "OFF" position.
3. Turn on the water pump switch to start the pump. DO NOT start the water pump until just before cutting. DO NOT leave the water pump on when the cutting task is complete to avoid draining the battery.
4. Push the water valve to the "ON" position.
5. When cutting is complete, move the water valve to the "OFF" position.
6. Turn off the water pump switch to stop the pump.

Control Grip

Two control grip pushbuttons raise and lower the saw. *Note: The saw can be raised and lowered with the engine off.*



Control Grip

Raising the Saw

Press the control grip's left pushbutton to raise the saw and release to stop. *Note: Raise the blade when maneuvering the saw to provide proper clearance between the blade and the ground.*

Lowering the Saw

Press the control grip's right pushbutton to lower the saw and release to stop.

Lowering Speed

The lowering speed metering valve changes the saw's lowering speed. The valve is located inside the upright compartment on the right side of the saw. Turn the valve counter-clockwise to increase the lowering speed and clockwise to decrease the lowering speed.



Lowering Speed Metering Valve

Speed Control Lever

The speed control lever places the saw in forward, or reverse. *Note: The engine must be running and the free wheel engagement cable must be disengaged to move the saw using the speed control lever. When starting the engine, engage the free wheel cable to prevent the saw from moving. Press the emergency stop button to immediately stop the engine as necessary.*



Speed Control Lever

Forward Control

Push the speed control lever forward to the desired traveling speed. The maximum speed the saw will move forward, at full throttle, is 250 ft. /min.

Reverse Control

Pull the speed control lever backward to the desired traveling speed. The maximum speed the saw will move in reverse, at full throttle, is 250 ft. /min.

Free Wheel Control

Pull up on the free wheel engagement cable to stop the saw from moving forward or backward. **DO NOT** assume at any time that the transmission will act as a brake when the free wheel engagement is active.

Positraction

The positraction cable transmits power from the driving wheel of the differential to the driven wheel of the differential. Pull up on the positraction cable to engage the positraction and release the cable to disengage.

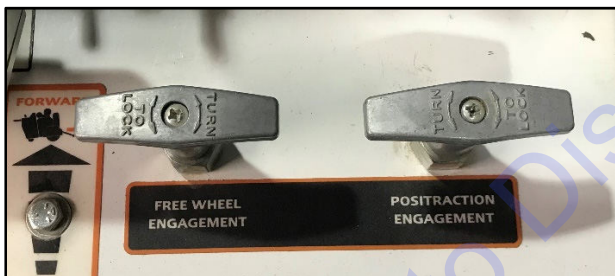

Free Wheel and Positraction Engagement

Shifting Three Speed Transmission

! CAUTION

Do not attempt to shift transmission when motor is running.

1. Stop engine.
2. Using wrench, rotate blade shaft one flat either direction until lever engages into desired slot in shift gate.

You will need to rotate the output shaft **BY HAND** to complete this motion.

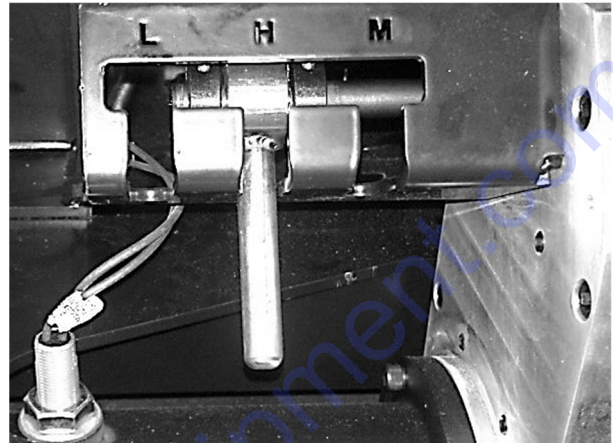

Transmission Lever

3. Drop shift lever into desired shift gate slot. From left to right, Low, High, Medium marked L, H, and M.

! WARNING

DO NOT operate the saw with a fuel leak.
DO NOT fuel the saw with the engine running.
DO NOT smoke or expose fuel to open flames when filling the fuel tank and/or working with fuel.

! CAUTION

Clean up spilled fuel prior to starting the engine.
If over filled fuel may seep out from the fuel cap vent when the saw is raised.

Adding Fuel

Check the fuel level daily and fill as necessary.

NOTE: When the fuel level in the tank reaches 5% capacity, the display panel will indicate “Low Fuel Pressure” and the fuel icon will flash yellow. When the fuel level in the tank reaches 0% the icon will flash red.

1. Lower the saw to the ground so it is level.
2. Stop the engine and let it cool down.
3. Open the fuel access panel door from the left side of the upright compartment.

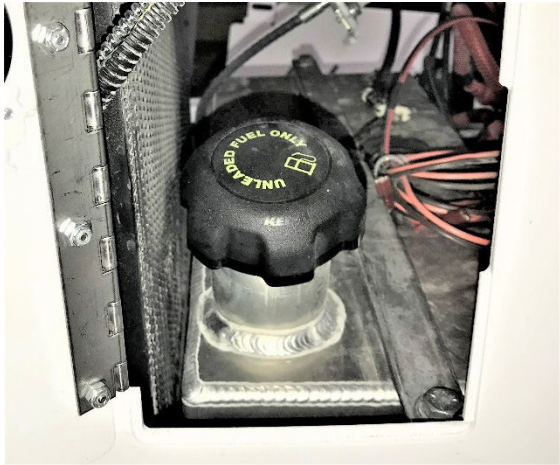

Fuel Tank Cap

4. Remove the fuel tank cap.
5. Fill the fuel tank with unleaded fuel only. Refer to the engine manual for a list of appropriate fuels.
6. Replace the fuel tank cap and tighten to secure.
7. Close and latch the fuel access panel door.

Unleaded Fuel

Lower ethanol fuel is strongly recommended, particularly for summer months. Refer to the engine manual for a list of appropriate unleaded fuels and acceptable additives, if any.

Storage

Fill the fuel tank to prevent condensation and contamination in the tank for shorter storage periods. Drain the fuel tank and fuel lines for extended storage periods

Engine

! WARNING

- *DO NOT expose yourself or anyone else to the direct line of the blade when operating the saw.*
- *DO NOT leave the engine running unattended.*
- *Operate the saw in well-ventilated areas. Concentrated engine exhaust can cause loss of consciousness and/or death.*



Ignition Switch



Ignition Switch

- *STOP* - turns off the engine.
- *ON* - Supplies power, but does not start the engine.
- *START* - turns on the engine. **DO NOT** engage for a long time to avoid overheating or damaging the starter.

Tasks Prior to Starting the Engine

Complete the tasks listed below prior to starting the engine:

- Fill fuel tank, check engine oil and coolant levels.
- Set proper blade size on the display panel.
- Set the required blade depth on the display panel.
- Turn off water valve.
- Turn off all optional accessories.
- Engage the free wheel lever
- Pull up on emergency stop button.
- Remove all tools from work area.

Starting the Engine

WARNING

DO NOT use any other starter substances or starter fluids when starting the engine (e.g., starter fluid sprayed into the air filter).

These materials are extremely flammable and explosive, and can melt parts or possibly explode when used together to start the engine.



1. To start the engine insert the key into the ignition, turn the key to ON and wait until the main gauge display screen is visible. A sequence of screens will display on the control panel. First you will see the Diamond Products logo display and then the main gauge screen is displayed.
2. Then turn the key to *START*, and release the key when the engine starts.

NOTE: *If the engine does not catch or start at 10 seconds after key is turned to START, wait for another 30 seconds and then begin again. DO NOT allow the starter motor to run continuously for more than 20 seconds. Refer to the engine manual if the engine does not start after two attempts.*

3. Increase the engine to half throttle, by pressing the throttle switch in the upward direction, and let the engine warm up without load until the coolant temperature reaches over 55C/131F.
4. Increase the engine to full throttle. Adjust the throttle as necessary when cutting for maximum efficiency. DO NOT exceed the maximum recommended blade RPM when operating the saw. (Refer to the Blade Speed section in this manual for correct RPM.)

Stopping the Engine

CAUTION

DO NOT leave the saw unattended until the engine is off and the blade has stopped spinning.

1. Raise the blade from the cut.
2. Move the saw to level ground.
3. Engage the free wheel lever by pulling up on the free wheel engagement cable.
4. Turn off the water pump switch if in use.
5. Turn off any optional accessories.
6. Decrease the engine speed to idle for several minutes by pressing the throttle switch in the downward direction. For turbocharged engines, idle the engine for approximately 5 minutes.
7. Turn the key to *Stop* and remove the key.

Concrete Cutting

WARNING

DO NOT expose yourself or anyone else to the direct line of the blade when operating the saw.



Helpful Hints Prior to Cutting

Keep the following things in mind for greater efficiency when cutting:

- Use just enough handle pressure to guide the saw on the cutting line. DO NOT forcibly direct (twist) the saw from side to side when cutting.
- Avoid sawing excessively deep to preserve the blade and reduce sawing costs.
- Moving too quickly when cutting may stall the saw, or may cause the blade to climb out from the cut. If the saw stalls at any time, engage the free wheel lever and raise the blade from the cut to restart the engine.
- DO NOT lower the blade too quickly or move the saw forward too quickly when finishing a partial-cut to avoid forcing the blade into the concrete.

Tasks Prior to Cutting

Complete the following tasks prior to cutting:

- Raise the blade to provide proper clearance between the blade and the ground when maneuvering the saw.
- Align the front pointer with the blade.
- Clearly mark the cutting line.
- The work area should not contain buried or embedded electrical, gas, or water lines.
- Turn off all electricity, gas, and water in and around the work area prior to cutting.

Making a Cut

1. Turn on the water pump if necessary.
2. Turn on the water valve.
3. Align the blade and pointers with the cutting line.
4. Lower the blade to touch the cutting surface.
5. Select the “Zero Blade” soft key button to zero the blade. The digital “Blade Depth” gauge on in the lower right corner of the display should read 0.00 in.
6. Start the saw normally and plunge the blade into the cutting surface until the desired depth is attained. *For all cuts, it is recommended to cut no deeper than 2”.* **DO NOT CUT FULL DEPTH IN ONE PASS.**
7. Select the “Set Depth Stop” soft key button to set the depth stop feature. The digital “Depth Set” gauge in the lower right corner of the display should read the chosen depth. The blade will now only lower into the cut to this set depth.
8. To clear the set depth, select the “Clear Depth Stop” soft key button. The saw can now be plunged further into the cut until the next desired depth is attained. Once the new depth is attained, select the “Set Depth Stop” soft key button to reset the depth to the new setting.

9. Push the speed control lever forward to reach the desired traveling speed for maximum efficiency. Raise and lower the blade as necessary, paying attention to the cutting depth indicator. When using the depth stop, raise the blade from the cut to repeat the depth in another area as necessary.

Continuing a Partial-Cut

1. Maneuver the saw to the correct location.
2. Align the blade with the previous cut and plunge the blade back into the concrete. **DO NOT** move forward until the blade is properly aligned within the cut.
3. Push the speed control lever forward to reach the desired traveling speed for maximum efficiency.

Finishing a Cut

1. Place the speed control lever at *Neutral*.
2. Raise the blade from the cut (high enough for proper ground clearance).

Lighting

The spot light (optional item) illuminates the area for the operator as necessary.

Spot Light

A mounting bracket secures the spot light to the radiator cover weldment on the upright assembly.

1. Loosen the lock knobs to adjust the light bar and retighten them to secure the light.
2. Turn the spot light switch on and off as necessary.

Maintenance

General

Failure to read and comply with the maintenance instructions provided in this manual prior to performing maintenance may result in serious injuries and/or death, and may harm the saw. DO NOT attempt to perform maintenance on the saw if you are not properly trained for it, or are not supervised by an experienced person.

Refer to the CC5555GK-3 Parts List for additional information and part diagrams when performing maintenance tasks. Refer to the engine manual and manufacturer as the primary source for all safety, operations, and maintenance instructions for the engine. Contact Discount-equipment with any additional questions.

Remove all necessary guards and access panels prior to servicing the saw. Replace prior to operating.

Pre Maintenance Preparations

- Ensure the saw is in a safe area to conduct maintenance.
- Maintain proper cleanliness of the work area to minimize personnel injury or equipment damage.
- Ensure the saw is sufficiently cool to conduct any maintenance.
- Remove the cutting blade prior to starting any maintenance.
- Place the saw on a level surface with the engine turned off and the emergency stop activated.
- Ensure there is adequate lighting in the work area to ensure safety.
- Ensure all equipment and tools required for the maintenance task are staged and available for use.
- Prior to any maintenance being performed, know the locations of all safety equipment such as fire extinguishers, first aid kits, etc.
- All maintenance shall be performed by qualified personnel only.

General Cleaning

The saw must be cleaned after each use and prior to conducting any maintenance. Ensure

that the saw is cool prior to cleaning. Ensure affected electrical equipment is properly covered or de-energized prior to cleaning with water or air.

Cleaning Techniques

Various cleaning options can be utilized depending on the type of cleaning required. High pressure washers and a mild detergent will work the best. Compressed air and low pressure water can also be utilized where required.



CAUTION

Care must be taken when using high pressure water and compressed air to conduct any maintenance or cleaning. High pressure water and compressed can cause injury to personnel or damage to equipment if not used properly.

Radiator

Ensure that the radiator is cool prior to cleaning. Use compressed air to clean the radiator fins being careful not to damage the fins. A mild detergent with low pressure water can also be used to degrease the radiator.

NOTE: Damaged radiator fins can and will diminish the cooling capacity of the radiator.

Control Panel

Do not spray water on the control panel to clean. Use a damp cloth or compressed air to clean electrical components. Dry the control panel after cleaning.

Engine

Use a mild detergent and water to clean the engine. Do not spray water forcefully on the engine to prevent damage to components.

NOTE: Do not spray water into the exhaust pipe or air filter.

Post Cleaning

- Lubricate the machine as required.
- Dry all electrical components using compressed air.
- Do not start the machine until it has had time to thoroughly dry.

MAINTENANCE

Service Schedule

The service schedule is based primarily on the standard operating time of the machine. The frequency of the maintenance tasks can be increased based on the working environments of the machine.

	Daily	100 Hrs.	200 Hrs.	250 Hrs.	500 Hrs.	1000 Hrs.
Visually inspect saw for damage and repair as necessary	X					
Wipe down and clean all components for dust, debris, and slurry	X					
Check that all safety guards are in place	X					
Check for loose or frayed wiring. Repair/replace as necessary	X					
Check for loose nuts and bolts and retighten	X					
Inspect all hoses for damage, leaks, or looseness and repair/replace as necessary	X					
Inspect all belts for tension or wear and re-tension or replace as necessary	X					
Check engine oil level	X					
Check fuel level	X					
Check hydraulic fluid level	X					
Check radiator coolant level	X					
Check air cleaner element	X					
Drain water from the 3-speed blade shaft gearbox, fuel cooler, and water pump	X ¹					
Clean air cleaner element		X ²				
Change engine oil and filter element			X ³			
Replace the 3-speed blade shaft gearbox fluid				X ⁴		
Replace fuel filter					X ⁵	
Replace the air cleaner element					X ⁵	
Replace radiator coolant						X

1 - Service as required

2 - Clean more often if operating in dusty conditions

3 - Initially change at 50 operating hours

4 - Initially change at 20 operating hours

5 - Or 1 year whichever occurs first

Daily Service

Check Engine Oil Level

Prior to checking the engine oil level, ensure that there is no blade installed on the saw and that the saw frame is in a level position.

1. Remove the engine oil dipstick from the rear of the engine. (Between the engine and saw upright assembly)



Engine Oil Dipstick

2. Check the oil level on the dipstick. The level should be between the two round marks.

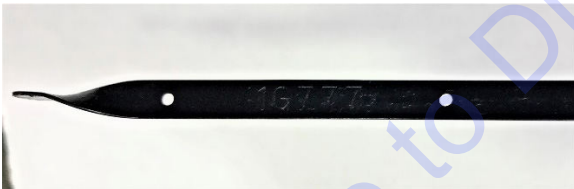

Engine Oil Level Indicators

3. If the level is low, remove the engine oil fill cap.



Engine Oil Fill Cap

4. Add oil until the level is correct.
5. Replace the engine oil fill cap.

Check Fuel Level

Prior to checking the fuel level, ensure that there is no blade installed on the saw and that the saw frame is in a level position.

1. Turn the ignition switch to the ON position and wait for the Home screen to appear. The fuel level gauge will be displayed on the display.
2. If fuel level is low, open the fuel access door on the left side of the upright assembly.



Fuel access Door

3. Remove the fuel tank fill cap

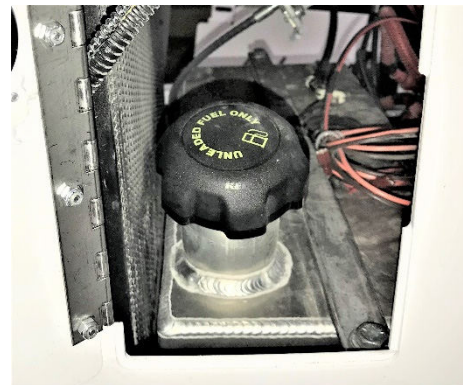

Fuel Tank Fill Cap

4. Fill the fuel tank with unleaded fuel only.

Hydraulic System

! WARNING

Turn the engine off prior to performing maintenance on the hydraulic system.



Lower the saw to the floor so it is level to release the pressurized hydraulic fluid in the hydraulic system prior to performing maintenance on the hydraulic system.

Always place a piece of cardboard or paper up against hydraulic components, or use a leak detection fluid to check for hydraulic fluid leaks. Keep all body parts away from leaks and/or areas that may eject hydraulic fluid. Pressurized hydraulic fluid can penetrate the skin, causing serious injuries. Seek medical attention immediately!

Always make sure any hydraulic components being serviced are not supporting the weight of other saw components. If a particular component is under pressure when connections points are loosened, oil may spray out forcefully.

Inspect all hydraulic hoses and fittings daily for leaks.

Adding Hydraulic Fluid

Check the hydraulic fluid level regularly and add fluid as necessary. If the hydraulic lift pump reservoir is below the halfway point in the tank, add hydraulic fluid.

1. Lower the saw to the ground so it is level (to provide an accurate fluid reading).
2. Remove the right side access panel from the upright to view the hydraulic pump reservoir tank.
3. If the tank is less than half full, remove the rear access panel from the upright assembly.
4. Remove the cap on the hydraulic pump reservoir.



Electro/Hydraulic Pump Reservoir Cap

5. Fill the reservoir to half full with 15W40 SAE motor oil.
6. Replace the cap on the reservoir.
7. Reinstall the rear access panel.
8. Reinstall the right side access panel.

Check Radiator Coolant Level

Prior to checking the radiator coolant level, ensure that there is no blade installed on the saw and the saw frame is in a level position.

1. Remove the radiator access cover by unscrewing the two hand lock knobs on the top of the upright assembly and pulling the cover up and off of the upright.

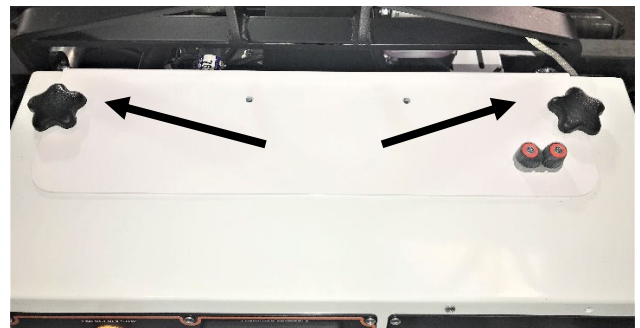

Radiator Access Cover Hand Lock Knobs

! CAUTION

Remove the radiator cap only when it feels cool to the touch, and always open it slowly to relieve any built up pressure.

2. Slowly remove the radiator cap. Check that the coolant level up to the overflow hole inside the filler neck.



Radiator Cap

3. If it is below the filler neck, add a 50/50 mix of water and antifreeze until it reaches that point.
4. Replace the radiator cap and retighten to secure.
5. Re-install the radiator access cover plate.

Check Air Cleaner Element

1. Check the restriction indicator located on the inlet to the air cleaner.
2. If the indicator is red, clean the air cleaner primary filter in accordance with the “Cleaning the Outer Primary Filter” procedure located in the “100 Hour Service” section of this manual.



Restriction Indicator

3. Ensure the rubber dust ejector boot valve is clean by pressing inward on both sides of the ejector boot near the valve opening to release debris and water, and clean the valve opening as necessary.



Rubber Dust Ejector Boot

Draining the Gearbox Heat Exchanger – Freezing Temps

To avoid water freezing in heat exchanger and potentially causing housing cracks it is necessary to drain the Heat Exchanger daily or when not in use for extended periods, in freezing ambient temperatures.

1. Shut off the water source to the transmission.
2. Using a 3/16” hex key wrench, remove both 1/8” NPT plugs located on the bottom of the 3-speed casing.
3. Replace the 1/8” NPT plugs once the water has been drained out.

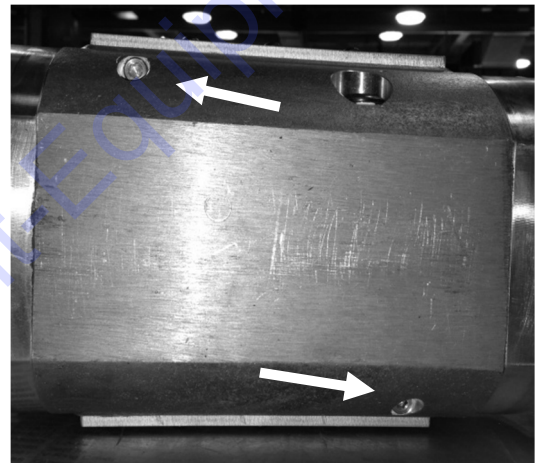

Drainage Plugs (View from bottom)

Draining Fuel Cooler – Freezing Temps

To avoid water freezing in the fuel cooler and causing damage, it is necessary to blow out the fuel cooler daily or when not in use for extended periods, in freezing ambient temperatures.

1. Shut off the water source to the water supply fitting located on the left side of the saw.
2. Disconnect the water supply hose to the 3-speed gearbox.

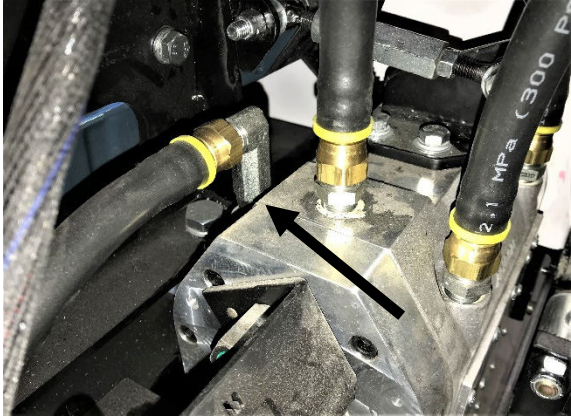

Water Supply to 3-Speed Gearbox

3. Disconnect the hose from the outlet of the water valve.



Water Valve Outlet Hose Connection

4. Using low pressure air, blow air through the fuel cooler until no water is present at the discharge of the water supply hose to the 3-speed gear box.
5. Reconnect all water lines.

Draining the Optional Water Pump – Freezing Temps

To avoid water freezing in the water pump and causing damage, it is necessary to blow out the water pump daily or when not in use for extended periods, in freezing ambient temperatures.

1. Shut off the water source to the water supply fitting located on the left side of the saw.
2. Disconnect the water supply hose to the 3-speed gearbox.
3. Push the water valve handle forward to the ON position.



Water Valve - ON

4. From the fuse/switch panel cover plate, turn the water pump to the ON position.

CAUTION
Do not allow the pump to operate dry for more than 15 minutes.

5. Allow the pump to run until no water is discharged from the water supply hose to the 3-speed gearbox.
6. Switch the pump OFF.
7. Pull the water valve handle back to the OFF position.
8. Reconnect the supply hose to the 3-speed gearbox.

100 Hour Service

Clean the Air Cleaner Element

 **WARNING**
DO NOT operate the saw without the filter installed

Service the outer primary filter according to the restriction indicator service bar. Replace the filter annually. DO NOT over-service or under-service the filter. DO NOT operate the saw without the filter installed.

1. Unlatch the two tabs on the air cleaner's end cover.



End Cover Tab

2. Pull the end cover off.
3. Pull the outer primary filter out of the air cleaner and inspect it for damages. Replace as necessary.
4. Move away from the saw and clean the filter from the inside out. Use dry compressed air to clean the filter (a maximum of 30 psi or 2.1 bar), or lightly tap or wash the filter out. Let the filter dry completely after washing. DO NOT damage the filter when cleaning.
5. Inspect the inside of the air cleaner and the end cover for debris, and wipe them down with a damp cloth as necessary. DO NOT use compressed air to blow out the inside of the air cleaner. DO NOT allow dust to enter the air intake tube when cleaning or replacing parts.
6. Place the filter into the air cleaner (over the inner safety filter) and gently push the filter into the unit until it feels secure.



Outer Primary Filter

7. Push the end cover tightly on the air cleaner.
8. Secure the two latches on the air cleaner's end cover to secure.

200 Hour Service

Replace Engine Oil and Filter

- Refer to Engine Operators manual for oil specifications and capacities.
- Refer to Engine Manual for Oil Filter Specifications.
- Be sure the engine is turned off and sufficiently cooled down prior to draining the engine oil

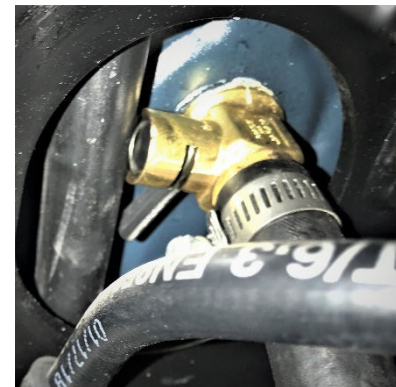

Oil Drain Valve and Hose

1. Level saw frame and locate the oil drain hose on the underside of the frame base. The hose is connected to the bottom of the sump.
2. Remove the red plug from the end of the hose.
3. Place a drain pan beneath drain hose.
4. Open the oil drain valve by pushing the valve lever forward and rotating it 45° downward.
5. Open the engine oil fill cap.
6. Drain oil completely.

7. Remove the oil filter located on the front of the engine using a filter wrench.
8. Dispose of the oil and filter in accordance with city, state and federal regulations.
9. Shut oil drain valve and replace red plastic drain plug.
10. Install a new filter on the engine. Lubricate the rubber gasket on the filter with a film of oil prior to installing it.
11. Tighten the filter only hand tight.

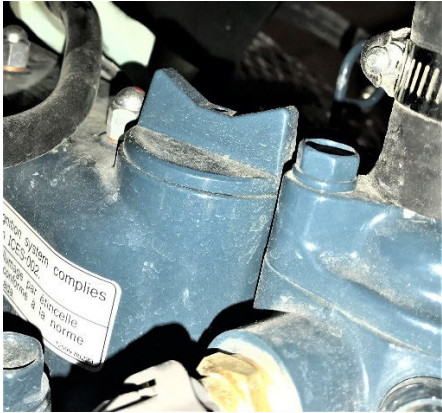

Engine Oil Fill Cap

12. Place a funnel with a flexible hose end into the oil fill tube on the engine.
13. Add oil in accordance with the manufacturer's specifications and capacities.
14. Replace the engine oil fill cap.

250 Hour Service

Changing Oil - Three Speed Gearbox

1. Raise saw to maximum angle for better drainage.
2. Place an oil pan beneath the 3-speed transmission casing.
3. Disconnect the expansion tank hose from the top of the gearbox.

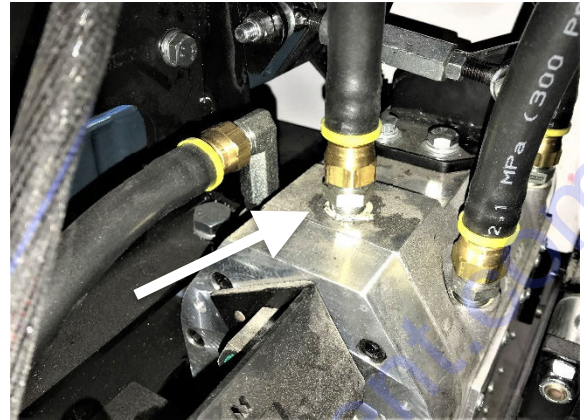

Expansion Tank Hose Connection

4. Using a 3/8" hex key wrench, remove the 1/2" casing drain plug located on the lower right rear of the 3-speed casing.

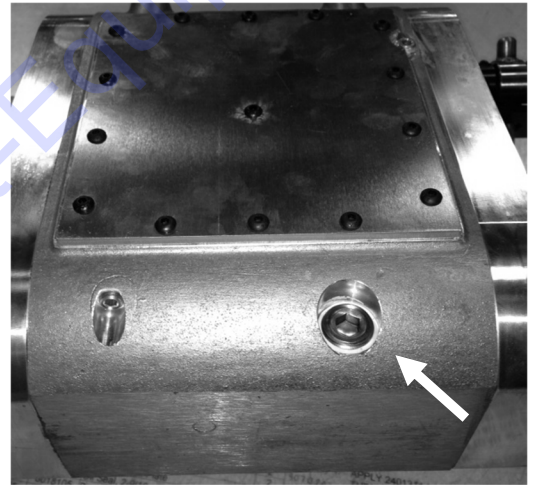

1/2" Casing Drain Plug

5. Flush the casing by pouring SAE 75W-90 synthetic gear oil or equivalent into the 3/8" fitting on the top of the gearbox until clean oil is discharged through the casing drain plug.
6. Replace the 1/2" casing drain plug.
7. Continue filling the gearbox with 3 quarts of SAE 75W-90 synthetic gear oil or equivalent.
8. Reconnect the expansion tank hose to the top of the gearbox.
9. Remove oil pan from beneath the saw.
10. Lower saw to horizontal position
11. Expansion Tank should not have oil in reservoir.
12. Discard the used transmission fluid according to city, state, and federal regulations.

500 Hour Service

Replacing the In-Line Fuel Filter

Replace the in-line fuel filter every 500 hours or yearly depending on the amount of sediment in the filter.

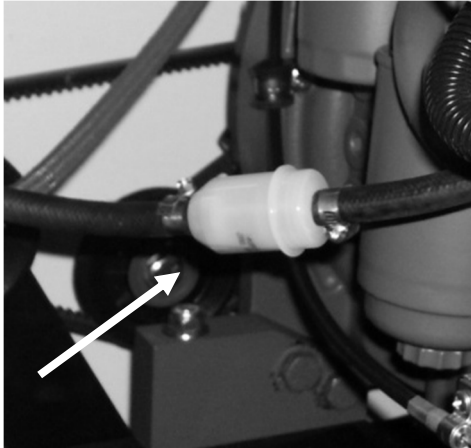

In-Line Fuel Filter

1. Turn off the engine.
2. Lower the saw so the engine is level.
3. Remove the right side access panel from the upright assembly.
4. Locate the fuel shutoff valve underneath the fuel tank and close the valve.
5. Remove the clamps, one on each side of the in-line fuel filter, from the hoses and remove the filter.

CAUTION: Excess fuel may release from the hoses.

6. Attach the new filter with the arrow pointing away from the shutoff valve and place the rear hose onto the rear end of the filter. Push the hose tightly up against the edge of the filter.
7. Place one hose clamp next to the filter (on the rear hose) and tighten the clamp to secure the hose and filter.
8. Place the front hose onto the front end of the filter. Push the hose tightly up against the edge of the filter.
9. Place one hose clamp next to the filter (on the front hose) and tighten the clamp to secure the hose and filter.

10. Open the fuel shutoff valve.
11. Reinstall the right side access panel onto the upright assembly.
12. Dispose of the used fuel and filter according to city, state, and federal regulations.

Replacing the Outer Primary and Inner Safety Filters

1. Pull out the tab on the air cleaner housing end cover.



End Cover Tab

2. Pull the cover away from the main air cleaner housing.
3. Remove the outer primary and inner safety filters from the air cleaner housing.

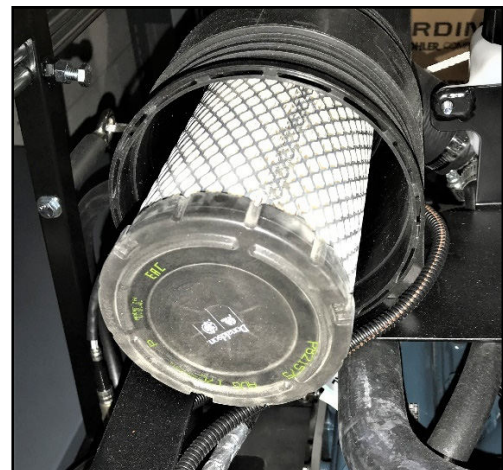

Outer Primary Filter



Inner Safety Filter

4. Inspect the inside of the air cleaner housing and the end cover for debris, and wipe them down with a damp cloth as necessary. DO NOT use compressed air to blow out the inside of the air cleaner housing. DO NOT allow dust to enter the air intake tube when cleaning or replacing parts.
5. Place the inner safety filter into the air cleaner housing until it is fully seated.
6. Place the outer safety filter into the air filter housing over the inner safety filter and gently push the filter into the unit until it feels secure.
7. Place the end cover tightly against the air cleaner housing.
8. Secure the two latches on the air cleaner's end to fasten.

1000 Hour Service

Replace Radiator Coolant

Ensure the engine is turned OFF and cooled down prior to replacing the radiator coolant

1. Remove the radiator access cover by unscrewing the two hand lock knobs on the top of the upright assembly and pulling the cover up and off of the upright.



Radiator Access Cover Hand Lock Knobs



CAUTION

Remove the radiator cap only when it feels cool to the touch, and always open it slowly to relieve any built up pressure.

2. Slowly remove the radiator cap.
3. Attach a hose with a 1/4" male thread fitting onto the petcock drain valve located on the lower front end of the radiator.



Radiator Petcock Drain Valve

4. Open the petcock drain valve and drain the coolant into an approved receptacle.
5. Loosen the clamp on the radiator overflow hose at the filler neck
6. Pull the hose off of the filler neck connection and drain the coolant from the overflow tank into an approved receptacle.
7. Re-attach the overflow hose to the filler neck and tighten the clamp.
8. Close the petcock drain valve when all coolant is drained from the radiator.
9. Remove the drain hose and fitting from the petcock drain valve.
10. Add a 50/50 mix of water and anti-freeze, as called out in the CC9074DK Parts List, through the fill port until the fluid reaches the overflow hole inside the filler neck.
11. Replace the radiator cap and retighten to secure.
12. Reinstall the radiator access cover.
13. Remove the coolant recovery tank cap.
14. Add a 50/50 mix of water and anti-freeze, as called out in the CC9074DK Parts List, to the "Cold Full" line.
15. Replace the coolant recovery tank cap.

Handlebars

The handlebars generally require little or no maintenance and, when used correctly, should remain in good condition. Inspect the handlebars occasionally for bending, unusual cracks, and/or breakage. Replace them immediately when damaged.

Part Lubrication



WARNING

DO NOT grease parts with the engine running unless stated otherwise.



Lubricating parts on schedule increases the saw's efficiency and life. Use NLGI No. 2 premium lithium-based grease when lubricating parts.

Front Axle

Lubricate the front axle grease fitting every 40 hours of operation. Lubricate both pillow block bearing grease fittings every 40 hours of operation.

Rear Axle

Lubricate both pillow block bearing grease fittings every 40 hours of operation.

Inner Blade Flange



Inner Flange

Installing the Inner Blade Flange

1. Check the inner flange for damages and clean or replace as necessary.
2. Remove the setscrew from the back of the inner flange using an Allen wrench.

3. Place the inner flange onto the indented portion of the blade shaft.
4. Apply Loctite 262 (red) or an equivalent to the setscrew threads.
5. Place the setscrew into the inner flange setscrew hole and tighten it down to the blade shaft key to secure the inner flange.

Removing the Inner Blade Flange

1. Remove the setscrew from the back of the inner flange using an Allen wrench.
2. Remove the inner flange from the blade shaft.
3. Check the inner flange for damages and clean or replace as necessary
4. Place the setscrew into the inner flange setscrew hole and tighten to secure.

Rear Wheels

Inspect the rear wheels regularly for damages or wear and replace as necessary.

1. Unscrew the transtorque bushing and remove one of the rear wheels.



Tran torque Bushing

2. Place the new wheel onto the rear axle.
3. Place the transtorque bushing into the wheel hole and tighten the bushing to 175 ft-lb (237 Nm). *Note: Failure to properly tighten the bushing may cause the wheel to fall off the saw.*
4. Repeat steps 1–3 to replace the second wheel.

Battery

WARNING

Ignitable explosive gases are emitted from the battery. DO NOT expose the battery to sparks or open flames, and keep the area around the battery well-ventilated.



Disconnect the battery when performing maintenance.

CAUTION

Use a proper battery tester, such as a voltmeter, to test the battery strength.

Use protective eyewear or a face shield, and avoid contact with the skin when handling a battery.

Battery Type

12 Volt AGM, Group 24

Servicing the Battery

1. Unbolt the two 5/16-18 x 2" hex head cap screws from the battery hold down bracket.
2. Remove the battery hold down bracket.

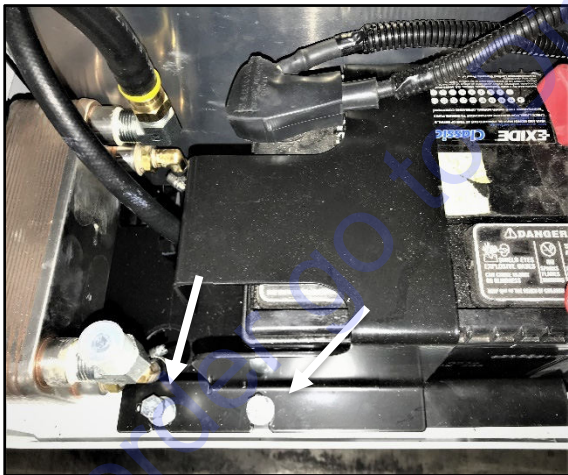

Battery Hold Down Bracket with Bolts

3. Remove the negative battery boot and disconnect the negative battery cable lead from the negative battery terminal.

4. Remove the positive battery boot and disconnect the positive battery cable lead from the positive battery terminal.
5. Pull the battery up off the battery platform, keeping it level.
6. When replacing the battery, place a new battery onto the battery platform, keeping it level. Bring the old battery to a recycling facility; many battery retailers also accept old batteries.
7. When cleaning the battery, inspect its terminals, clamps, and cables for damages and corrosion. Clean the terminals and clamps using a wire brush, or use another approved technique for cleaning. Use acid-free, acid-resistant grease to grease the battery clamps and terminals.
8. Reconnect the positive battery cable lead to the positive battery terminal and replace the battery boot.
9. Reconnect the negative battery cable lead to the negative battery terminal and replace the battery boot.
10. Replace the battery hold down bracket and secure using the two 5/16-18 x 2" hex head cap screws.

Electrical System

WARNING

DO NOT perform maintenance on the electrical system without first disconnecting the battery.

Always use the correct size fuses (amps) to prevent fires.



Fuses and Relays

The fuses and relay switches are located behind the fuse/switch panel cover plate in the fuse block assembly. (Refer to the CC5555GK-3 Controls Diagram on page 8)

Circuit Breakers and Terminal Blocks

There are two 50 amp circuit breakers associated with the CC5555GK-3. The first 50 amp breaker, for the cooling fan, is located inside the upright compartment on the right side of the saw. To access this breaker, remove the right side access panel. The second 50 amp breaker is for the ignition switch and is located behind the control panel. To access this breaker, remove the control panel cover.



Cooling Fan Circuit Breaker

There are two 6-position terminal blocks located behind the control panel. To access the blocks, remove the control panel cover.

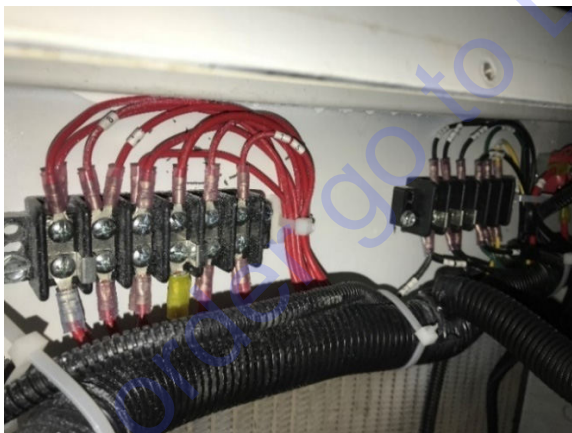

Terminal Blocks

Magnetic Sensor

The magnetic sensor transfers the blade RPM to the control panel display. If the blade tachometer/hour meter remains at zero when

operating the saw, the magnetic sensor needs to be adjusted or replaced.

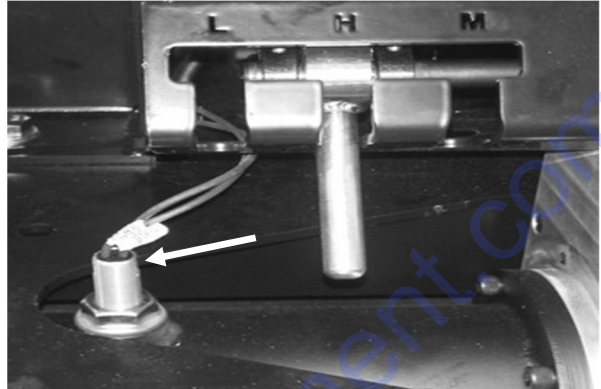

Three Speed Magnetic Sensor

Adjusting the Magnetic Sensor

1. Loosen the jam nut on the magnetic sensor.
2. Turn the magnetic sensor clockwise to screw the sensor in until it lightly touches the tachometer gear mounted on blade shaft.
3. Turn the sensor counterclockwise 1/8th of a turn.
4. Retighten the jam nut down to the frame base to secure the sensor.

Replacing the Magnetic Sensor

1. Disconnect the battery.
2. Disconnect the magnetic sensor's two-wire connector.
3. Loosen the jam nut on the magnetic sensor, and turn the sensor counterclockwise to remove the sensor.
4. Loosen the jam nut on the new magnetic sensor so it sits near the upper part of the sensor.
5. Place the sensor into the magnetic sensor hole on the frame base.
6. Turn the magnetic sensor clockwise to screw the sensor in until it lightly touches the tachometer gear mounted on blade shaft.
7. Turn the sensor counterclockwise exactly 1/8th of a turn.
8. Screw the jam nut down to the frame base to secure the sensor.
9. Connect the new magnetic sensor's two-wire connector.
10. Reconnect the battery.

Speed Control Lever

When the speed control lever is out of sync with the saw's movement; for example, if the saw moves forward when the lever is at *Neutral* adjustments are needed.

Adjusting the Speed Control Lever

1. With saw running, move the speed control lever forward or reverse until the saw does not move. This will place the shift lever, attached to the differential assembly, in the NEUTRAL position
2. Turn the ignition key to the OFF position.
3. Identify the two linkage assemblies, one connected to the shift lever and the other attached to the speed control lever weldment.

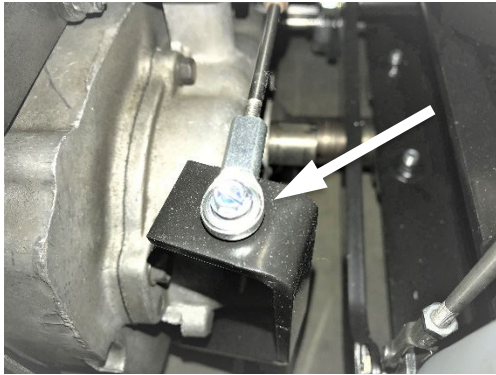

Shift Lever Linkage

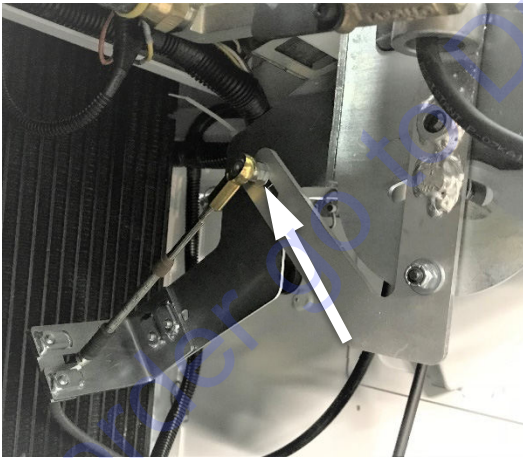

Speed Control Lever Linkage

4. Without moving the speed control lever, disconnect the ball joint linkage from the speed control lever weldment.
5. Move the speed control handle into the neutral position.



Speed Control Lever

6. Adjust the threaded nuts on the threaded linkage assembly shaft as required to reconnect the ball joint linkage to the speed control lever weldment. The weldment is slotted to allow for adjustments.
7. If additional adjustment is required, disconnect the battery and remove it and the battery tray.
8. Disconnect the ball joint linkage at the shift lever and adjust the threaded linkage as necessary to allow for reconnection to the shift lever.
9. Replace the battery tray and battery.
10. Reconnect the battery.
11. Remove tools from the area. Start the engine to check the speed control lever for accuracy.
12. Turn the engine off and readjust the threaded nuts as necessary.
13. Adjust the ball nose plunger at the speed control lever's pivot point to change the amount of friction felt when moving the speed control lever.

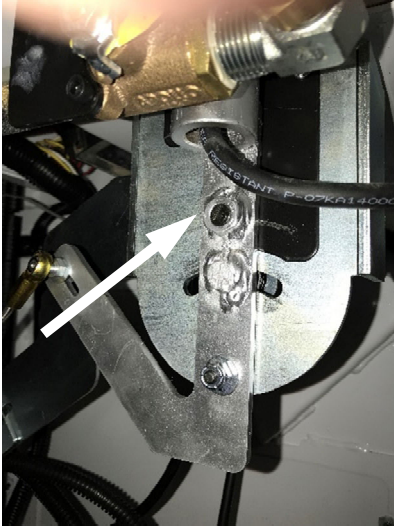

Ball Nose Plunger

Optional Water Pump

Cleaning the Inlet Strainer

When using the optional water pump, the pump inlet strainer must be cleaned out on an as needed basis.

1. Unscrew the clear cap on the inlet strainer.
2. Remove the strainer screen and gently rinse with water to remove any debris.
3. Reinstall the screen and screw the clear cap back on the strainer.

Belt System

! WARNING
Turn the engine off prior to performing belt maintenance.



! CAUTION
Always let the belts cool down prior to performing belt maintenance.

Blade Drive Belts



Blade Drive Belts

Belt Tension Setting

Refer to the manufacturer's belt tensioning. DO NOT exceed the manufacturer's tension setting. *Note: Over-tensioning the belts may damage the power take-off (PTO). Under-tensioning the belts may cause shorter belt life and/or poor saw performance. Squealing belts indicate looseness.*

Testing the Belt Tension

Test the blade drive belt tension on a daily basis using a sonic tension meter sensor (can be ordered through Diamond Products), in accordance with manufacturers specifications.

Adjusting the Blade Drive Belts

1. Inspect the belts for fraying, stress cracks, and/or breakage and replace immediately if there are damages.
2. Test the belt tension. Proceed to step 3 if the belts need tensioning. Operate the saw as needed if no tension adjustments are required.
3. Locate the PTO belt guard on the left side of the saw. Loosen and remove the six hex head cap screw and bolts located on the side and front of saw. Remove belt guard by sliding it forward.

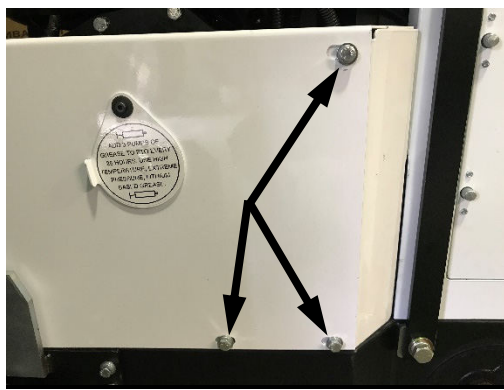

PTO Belt Guard Bolts – Side (3)

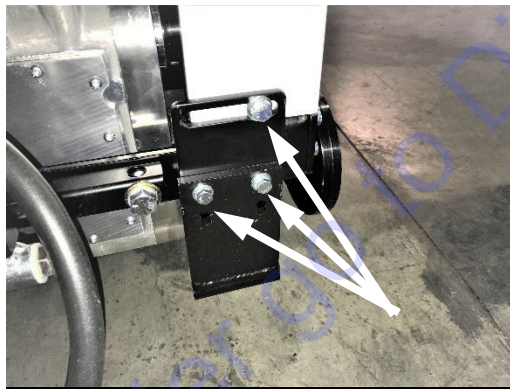

PTO Belt Guard Bolts – Front (3)

4. Locate the alternator belt guard on the right side of the saw. Release the front pointer rope from the cleat and pull it forward through the eyebolt on the guard. Loosen and remove the three hex head cap screws located on the side and front of the guard. Remove the alternator belt guard.



Alternator Belt Guard Bolts (Side)



Alternator Belt Guard Bolt (Front)

5. Locate the four bolts that attach the blade shaft assembly to the frame base. Loosen the bolts using a 3/4" wrench to allow for free rotational movement of the blade shaft assembly. **DO NOT** remove these bolts.

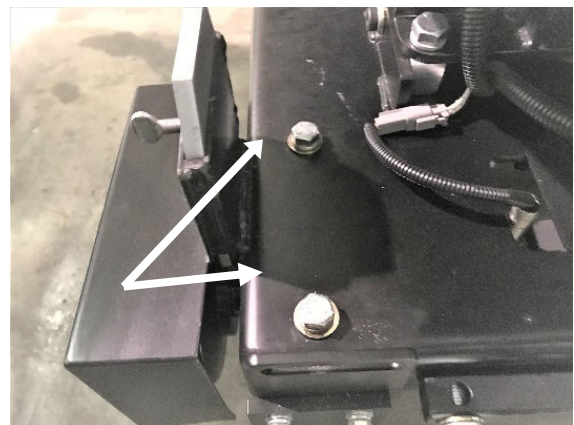

Blade Shaft Assembly Bolts - Right Side

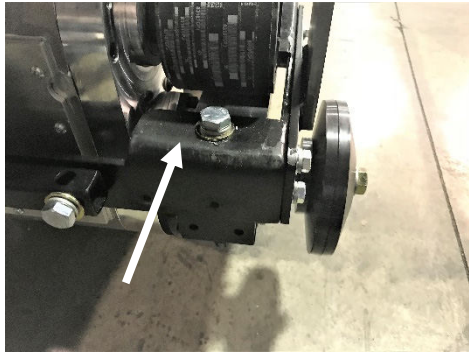

Front Blade Shaft Assembly Bolt - Left Side

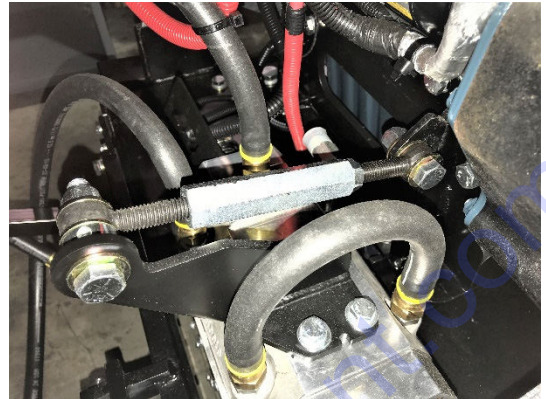

Turnbuckle Tensioning Assembly

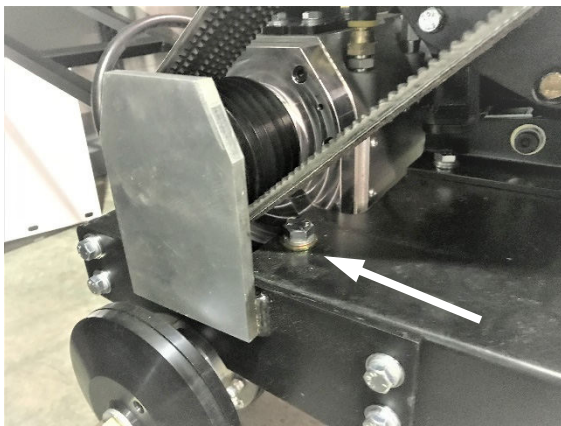

Rear Blade Shaft Assembly Bolt - Left Side

7. Once the blade drive belts are tightened properly, tighten the jam nut on the turnbuckle tensioning assembly.
8. Tighten the four hex head bolts that attach the blade shaft assembly to the frame.
9. Replace the PTO and alternator belt guards.

Replacing the Blade Drive Belts

1. Locate the PTO belt guard on the left side of the saw. Loosen and remove the six hex head cap screw and bolts located on the side and front of saw. Remove belt guard by sliding it forward.

6. Adjust the belt tension as follows:
 - Loosen the jam nut on the turnbuckle tensioning assembly using a 9/16" wrench.
 - To loosen the belts turn the coupling nut clockwise using a 3/4" wrench. This will allow the gear box to tilt back.
 - To tighten the belts turn the coupling nut counter-clockwise. This will allow the gearbox to tilt forward.
 - Test the belt tension and readjust the coupling nut as necessary. DO NOT exceed the manufacturer's belt tension setting.

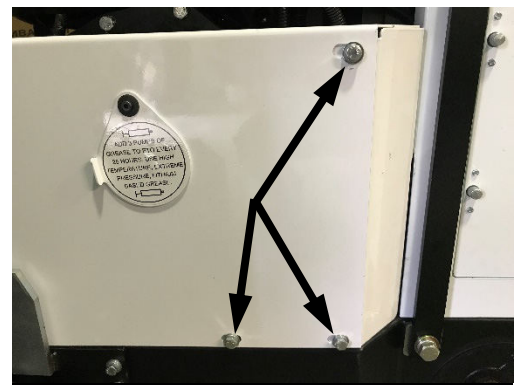

PTO Belt Guard Bolts – Side (3)

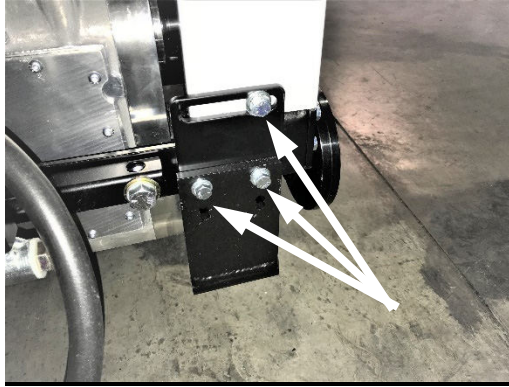

PTO Belt Guard Bolts – Front (3)

2. Locate the alternator belt guard on the right side of the saw. Release the front pointer rope from the cleat and pull it forward through the eyebolt on the guard. Loosen and remove the three hex head cap screws located on the side and front of the guard. Remove the alternator belt guard.

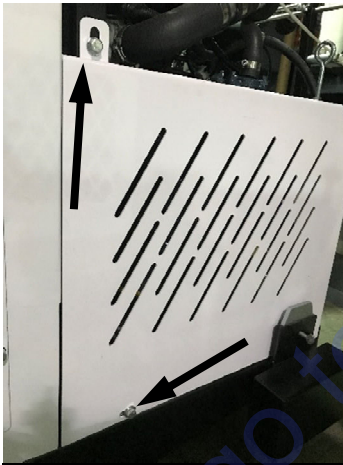

Alternator Belt Guard Bolts (Side)



Alternator Belt Guard Bolt (Front)

3. Locate the four bolts that attach the blade shaft assembly to the frame base. Loosen the bolts using a 3/4" wrench to allow for free rotational movement of the blade shaft assembly. DO NOT remove these bolts.

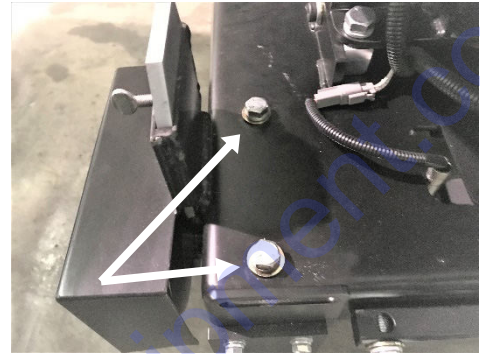

Blade Shaft Assembly Bolts - Right Side

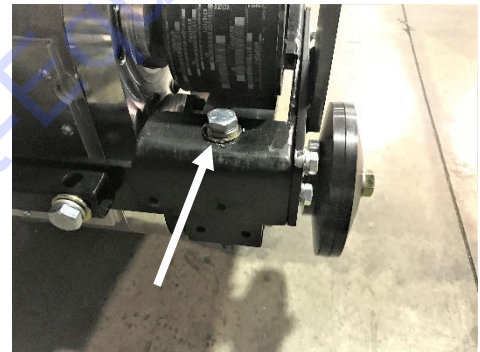

Front Blade Shaft Assembly Bolt - Left Side

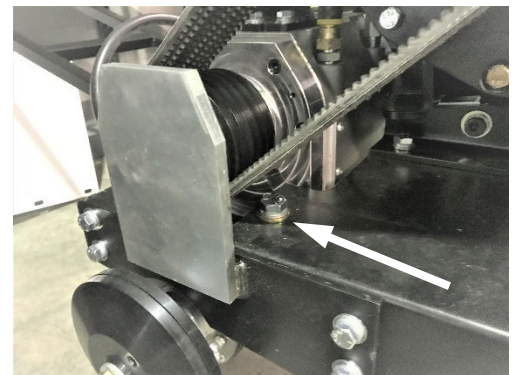

Rear Blade Shaft Assembly Bolt - Left Side

4. Loosen the jam nut on the turnbuckle tensioning assembly using a 9/16" wrench.
5. Turn the coupling nut on the turnbuckle tensioning assembly clockwise, using a 3/4" wrench.

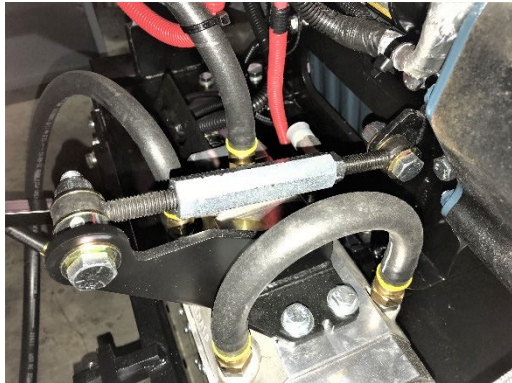

Turnbuckle Tensioning Assembly

6. Remove the drive belts and replace with new belts.
7. Turn the coupling nut on the turnbuckle tensioning assembly counter-clockwise to tension the drive belts.
8. Once the drive belts are tightened properly, tighten the jam nut on the turnbuckle tensioning assembly.
9. Tighten the four hex head bolts that attach the blade shaft assembly to the frame.
10. Re-tension the primary transmission belt as follows:
 - Place a 15/16" wrench on the hex nut in the rotary tensioner body and a 9/16" wrench on the mounting lock nut.
 - Using the wrench on the rotary tensioner body, apply pressure in the clockwise direction to apply tension and then tighten the mounting nut
11. Replace the PTO and alternator belt guards.

Primary Transmission V-Belt

Inspect the V-belt regularly for fraying, stress cracks, and/or breakage and replace immediately if there are damages.

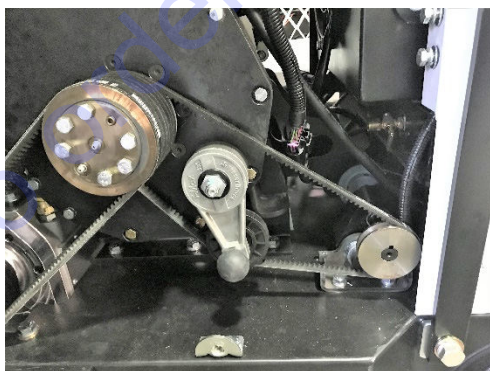

Figure 5: Primary Transmission V-Belt

Replacing the Primary Transmission V-Belt

1. Remove the tension from the rotary tensioner.
2. Remove the blade drive belts from the PTO sheave.
3. Remove the V-belt from the rotary tensioner idler pulley, the front transmission jackshaft pulley, and the PTO sheave.
4. Install a new primary transmission v-belt onto the PTO sheave, transmission jackshaft pulley, and the rotary tensioner pulley.
5. Re-tension the rotary tensioner.
6. Retighten the blade drive belts.

Secondary Transmission V-Belt

Inspect the V-belt regularly for fraying, stress cracks, and/or breakage and replace immediately if there are damages.



Secondary Transmission Belt

Replacing the Secondary Transmission V-Belt

1. Remove the tension from the rotary tensioner.
2. Remove the primary transmission V-belt from the rear transmission jackshaft pulley.
3. Remove the secondary transmission V-belt from the transmission pulley and jackshaft pulley.
4. Loop and align the new secondary transmission V-belt around the transmission pulley, and the jackshaft pulley.
5. Pull the jackshaft toward the front of the saw and place the primary transmission V-belt back on the jackshaft pulley.
6. Re-tension the rotary tensioner.

Rotary Tensioner

Adjusting the Rotary Tensioner

1. Remove PTO belt guard
2. Place a 15/16" wrench on the hex nut in the tensioner body and a 9/16" wrench on the mounting lock nut.
3. Loosen the mounting nut, then using the wrench on the tensioner body, apply pressure in the clockwise direction to apply tension to the belt.
4. Tighten the mounting nut.
5. Replace the PTO belt guard.

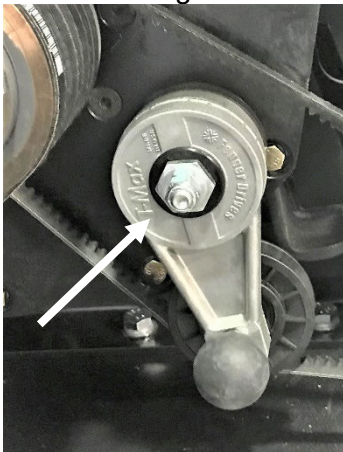

Rotary Tensioner, Body Nut & Mounting Nut

Rotary Position Sensor

Calibrating the Rotary Position Sensor

The depth stop accuracy has been designed and manufactured to fall within the CSDA allowable tolerance of +/- 1/2"; however, through wear of various components this accuracy may become compromised. It is required to recalibrate the depth stop/indicator every time a battery, blade, display, or sensor is changed (see sections xx) and recommended to do periodically for increased accuracy.

⚠️ WARNING

When using the depth stop on jobs where structural damage could result from excessive cutting depth, it is the sole responsibility of the operator to ensure blade depth accuracy and stop is adhered to and controlled accordingly.

1. Turn the ignition switch to the *ON* position.
2. Raise the saw to the full up position.

3. Press and hold the lower right soft key button of the display panel for approximately 10 seconds until the digital "Blade Depth" gauge indicates 0.00 in.
4. Turn the ignition switch to the *OFF* position.

Storing

Complete the tasks listed below prior to storing the saw for longer time frames:

- Lower the saw completely to remove strain on the lifting mechanism.
- Turn off all switches and controls.
- Remove the battery from the saw and store it in a proper location, out of reach of children.
- Drain the fuel tank and fuel lines.
- Disconnect the water supply hose, open both water valves, and blow compressed air through the horizontal hose fitting on the left water valve to drain water from the saw.
- Use compressed air to clean the blade guard water tubes and rinse them out with a hose.
- Refer to the engine manual for information on proper engine care when storing the saw.
- Clean the saw and store it in a dry area, out of reach from children.

Disposal

Properly dispose of the saw when it's no longer repairable, and/or contains safety hazards not worth repairing and/or maintaining. Complete the tasks listed below to properly dispose of the saw when discontinuing usage:

- Drain all fluids from the saw and dispose according to city, state, and federal regulations.
- Remove the battery from the saw and bring it to a recycling facility. Many battery retailers accept old batteries as well.
- Secure the saw in a truck/trailer and transport it to a salvage yard for appropriate disposal.

Appendix A

Model and Serial Numbers

Record the saw's serial number below for future reference and customer service purposes.

Serial Number	
---------------	--

Record the engine's model and serial numbers below for future reference and customer service purposes.

Model Number	
Serial Number	

To order go to Discount-Equipment.com

Appendix B
Troubleshooting

Table 1: Troubleshooting		
Symptom	Problem	Solution
a. Engine will not start.	Emergency stop button activated?	Pull up on emergency stop button.
	Out of fuel?	Check for fuel in tank.
	Fuel filter or fuel lines clogged?	Replace fuel filter or fuel lines.
	Air in fuel lines?	Bleed fuel lines.
	Weak or worn-out battery?	Test, charge, or replace battery.
	Faulty battery connection?	Inspect, clean, and tighten battery cables.
	Main circuit breaker tripped?	Check wiring for short.
	Engine malfunction?	Refer to engine manual.
	Fuel shutoff valve closed?	Open fuel shutoff valve
b. Saw will not raise.	Defective solenoid start switch?	Check and replace solenoid on hydraulic pump unit.
	Worn-out battery?	Test, charge, or replace battery.
	Defective raise button?	Check and replace raise button.
	Low hydraulic fluid?	Check hydraulic fluid and refill as necessary.
c. Saw will not lower.	Debris in lowering valve stem?	Remove, inspect, and clean valve stem.
	Defective valve coil?	Check for magnetism of valve stem when activated.
	Defective lowering button?	Check and replace lowering button.
d. Saw lowers too slow/too fast.	Improper lowering speed setting?	Adjust flow control valve knob on hydraulic pump unit.
e. Saw will not completely lower.	Depth stop set?	Reset or clear depth stop setting on control panel.
	Skid plates in wrong set of holes?	Use bottom set of holes with 4-1/2" blade flanges.

REFERENCES

Table 5: Troubleshooting (cont.)		
Symptom	Problem	Solution
f. Blade does not cut straight.	Misaligned rear axle?	Adjust rear axle alignment.
	Excessive force applied while sawing?	Reduce forward speed.
	Wrong blade for application?	Contact Discount-equipment.
g. Short belt life.	Loose belts causing slippage?	Check belt tension on a regular basis.
	Sheaves misaligned?	Use straightedge to check blade shaft sheave alignment.
	Worn sheave grooves?	Check for groove wear and replace as needed.
	Belts contacting pavement?	Inspect and replace worn front skid plates.
		Adjust front axle maximum depth stop bolt for belt clearance.
Overheating of PTO?	Check belt tension. Lubricate PTO every 25 hours.	

To order go to Discount-Equipment.com

Appendix C

Additional Resources

1. Discount-equipment (www.discount-equipment.com)
 - *CC5555GK-3 Concrete Saw Parts List, Ohio 2018*
 - *A Guide for Professional Concrete Cutters*
 - *Training Manual – Introduction to Diamond Blades, Bits, and Equipment*
 - *Diamond Products' Equipment Catalog*
 - *Discount-equipment' Website (www.discount-equipment.com)*
2. Kubota (www.kubotaengine.com)
 - *Operator's Manual, Kubota SI Engine WG1605-G-E3, Code No. EG523-8916-6.*
3. Concrete Sawing and Drilling Association (www.csda.org)
 - *The CSDA has many helpful concrete cutting publications available to members and non-members.*
4. Association of Equipment Manufacturers (www.aem.org)
 - *The AEM has a variety of safety and technical manuals available for various types of equipment, along with a list of industry-standardized safety symbols.*
5. Occupational Safety & Health Administration (OSHA) (www.osha.gov)
 - *OSHA provides information on work-related safety and health practices.*
6. The National Institute for Occupational Safety and Health (NIOSH) (www.cdc.gov/NIOSH/)
 - *NIOSH provides information on work-related safety and health practices.*

EQUIPMENT AND PARTS WARRANTY

Discount-equipment warrants all equipment sold by it against defects in workmanship or materials for a period of one (1) year from the date of shipment to Customer.

The responsibility of Discount-equipment under this Warranty is limited to replacement or repair of defective parts, of such parts as shall appear to us upon inspection at such parts, to have been defective in material or workmanship, with expense for transportation and labor borne by Customer.

In no event shall Discount-equipment be liable for consequential or incidental damages arising out of the failure of any Product to operate properly.

Integral units such as engines, electric motors, batteries, transmissions, etc., are excluded from this Warranty and are subject to the prime manufacturer's warranty.

**THIS WARRANTY IS IN LIEU OF ALL OTHER WARRANTIES,
EXPRESSED OR IMPLIED, AND ALL SUCH OTHER WARRANTIES ARE
HEREBY DISCLAIMED.**



TO PURCHASE THIS PRODUCT PLEASE CONTACT US



**Equipment Financing and
Extended Warranties Available**



**Discount-Equipment.com is your online resource for
commercial and industrial quality parts and equipment sales.**

561-964-4949

visit us on line @ www.discount-equipment.com

Select an option below to find your Equipment

Search by Manufacturer

Search by Product Type

Request a Quote

We sell worldwide for the brands: Genie, Terex, JLG, MultiQuip, Mikasa, Essick, Whiteman, Mayco, Toro Stone, Diamond Products, Generac Magnum, Airman, Haulotte, Barreto, Power Blanket, Nifty Lift, Atlas Copco, Chicago Pneumatic, Allmand, Miller Curber, Skyjack, Lull, Skytrak, Tsurumi, Husquvarna Target, Stow, Wacker, Sakai, Mi-T-M, Sullair, Basic, Dynapac, MBW, Weber, Bartell, Bennar Newman, Haulotte, Ditch Runner, Menegotti, Morrison, Contec, Buddy, Crown, Edco, Wyco, Bomag, Laymor, EZ Trench, Bil-Jax, F.S. Curtis, Gehl Pavers, Heli, Honda, ICS/PowerGrit, IHI, Partner, Imer, Clipper, MMD, Koshin, Rice, CH&E, General Equipment, Amida, Coleman, NAC, Gradall, Square Shooter, Kent, Stanley, Tamco, Toku, Hatz, Kohler, Robin, Wisconsin, Northrock, Oztec, Toker TK, Rol-Air, APT, Wylie, Ingersoll Rand / Doosan, Innovatech, Con X, Ammann, Mecalac, Makinex, Smith Surface Prep, Small Line, Wanco, Yanmar