



**CORE CUT  
OPERATOR'S MANUAL**

**CC5049D**

**TO PURCHASE THIS PRODUCT PLEASE CONTACT US**



**Equipment Financing and  
Extended Warranties Available**



**Discount-Equipment.com is your online resource for  
commercial and industrial quality parts and equipment sales.**

**561-964-4949**

**visit us on line @ [www.discount-equipment.com](http://www.discount-equipment.com)**

Select an option below to find your Equipment

**Search by Manufacturer**

**Search by Product Type**

**Request a Quote**

We sell worldwide for the brands: Genie, Terex, JLG, MultiQuip, Mikasa, Essick, Whiteman, Mayco, Toro Stone, Diamond Products, Generac Magnum, Airman, Haulotte, Barreto, Power Blanket, Nifty Lift, Atlas Copco, Chicago Pneumatic, Allmand, Miller Curber, Skyjack, Lull, Skytrak, Tsurumi, Husquvarna Target, Stow, Wacker, Sakai, Mi-T-M, Sullair, Basic, Dynapac, MBW, Weber, Bartell, Bennar Newman, Haulotte, Ditch Runner, Menegotti, Morrison, Contec, Buddy, Crown, Edco, Wyco, Bomag, Laymor, EZ Trench, Bil-Jax, F.S. Curtis, Gehl Pavers, Heli, Honda, ICS/PowerGrit, IHI, Partner, Imer, Clipper, MMD, Koshin, Rice, CH&E, General Equipment, Amida, Coleman, NAC, Gradall, Square Shooter, Kent, Stanley, Tamco, Toku, Hatz, Kohler, Robin, Wisconsin, Northrock, Oztec, Toker TK, Rol-Air, APT, Wylie, Ingersoll Rand / Doosan, Innovatech, Con X, Ammann, Mecalac, Makinex, Smith Surface Prep, Small Line, Wanco, Yanmar

## TABLE OF CONTENTS

### Table of Contents

Introduction .....	7
CC5049D Controls .....	8
CC5049D Dimensions .....	10
CC5049D Specifications .....	11
Safety .....	12
Safety Alerts .....	12
Proposition 65 .....	12
Spark Arrester Requirement .....	12
Respiratory Hazards .....	12
General Safety .....	13
Battery and Electrical Safety .....	14
Blade Safety .....	14
Blade Guard Safety .....	14
Fuel Safety .....	15
Engine Safety .....	15
Cutting Safety .....	15
Hydraulic Safety .....	16
Belt Safety .....	16
Transporting Safety .....	16
Lifting Safety .....	16
Display Panel Controller .....	17
Controller Features .....	17
Flat Screen Display .....	17
Function Keys .....	19
Soft Key Commands .....	19
Main Menu Key .....	20
Engine Diagnostics .....	21
User Settings .....	22
Utilities .....	23
Operation .....	24
Blade Size Selection .....	24
Zero the Blade .....	25
Set the Blade Depth Stop .....	25
Deactivate the Blade Depth Stop Setting .....	25
Operating .....	26
General Operating Precautions .....	26
Emergency Stop .....	26
Activating the Emergency Stop .....	26
Deactivating the Emergency Stop .....	26
Handlebars .....	26
Manually Adjusting the Handlebars .....	27
Adjusting the Power Tilt Handlebars (Optional) .....	27
Speed Control Lever .....	27
Control Grip Pushbuttons .....	27
Blade Lowering Speed .....	27
Moving the Machine Forward / Reverse with the Engine Running .....	28
Moving the Machine with the Engine Off .....	28

## TABLE OF CONTENTS

Bogie Wheel (Optional) .....	28
Bogie Wheel - Locked Sideways Motion .....	28
Bogie Wheel - Free Wheel Motion.....	29
Fuel System .....	29
Adding Fuel .....	29
Blade Guard .....	29
Installing the Blade Guard .....	29
Removing the Blade Guard .....	30
Slurry Shield (Optional) .....	30
Flange Guard .....	30
Installing the Flange Guard .....	30
Removing the Flange Guard .....	30
Diamond Blades .....	31
Inspecting the Blade .....	31
Blade Speed .....	31
Wrench .....	31
Installing the Blade .....	31
Removing the Blade .....	32
Engine .....	33
Tasks Prior to Starting the Engine .....	33
Starting the Engine .....	33
Stopping the Engine .....	33
Water Supply.....	34
Using the Water Supply.....	34
Water Pump (Optional).....	34
Automatic Water System (AWS) (Optional).....	34
Water Pressure Switch (Optional) .....	34
Cutting.....	34
Cutting Guides.....	34
Adjusting the Front Pointer .....	35
Adjusting the Rear Pointer(s) .....	35
Straight Line Cutting .....	35
Tasks Prior to Cutting .....	35
Making a Cut without Using the Blade Depth Stop.....	35
Making a Cut Using the Blade Depth Stop .....	36
Continuing a Partial-Cut .....	36
Finishing a Cut.....	36
Drive Alignment.....	37
Adjusting the Drive Alignment .....	37
Tie-Downs .....	37
Footrest (Optional) .....	37
Weight Bar (Optional).....	37
Spotlight (Optional) .....	37
LED Light Bar (Optional) .....	38
Heavy Duty Blade Shaft Bearing Upgrade (Optional).....	38
Oil Bath Blade Shaft Upgrade (Optional) .....	38
Maximum Capacity Battery Upgrade (Optional).....	38



## TABLE OF CONTENTS

Air Pre-Cleaner Upgrade (Optional).....	38
Onboard Blade Storage (Optional).....	38
Pointer Rope Recoil (Optional) .....	38
Maintenance .....	39
General .....	39
Maintenance Tools.....	39
Pre Maintenance Preparations.....	39
Rear Cover Screen .....	39
Removal of Rear Cover Screen.....	39
Installing the Rear Cover Screen.....	39
General Cleaning .....	39
Cleaning Techniques.....	39
Radiator .....	40
Control Panel.....	40
Display Screen .....	40
Engine .....	40
Part Lubrication .....	40
Post Cleaning.....	40
Service Schedule.....	41
Daily Service.....	42
Check Engine Oil Level.....	42
Check Fuel Level .....	42
Hydraulic System .....	42
Check Hydraulic Fluid Level for Hydro Pump Assembly .....	43
Adding Fluid to the Hydraulic Lift Pump .....	43
Check Radiator Coolant Level .....	43
Check and Clean Blade Guard Spray Tubes.....	44
Lubricate the Blade Shaft Bearings.....	44
Check Air Cleaner Restriction Indicator .....	44
25 Hour Service .....	44
Inspect Belts.....	44
Lubricate the PTO Bearings.....	45
50 Hour Service .....	45
Drain the Fuel/Water Separator Filter .....	45
Drain Water from the Fuel Filter.....	45
Lubricate the Hydraulic Cylinder Pivot Pin .....	45
Lubricate Front Axle Bearings.....	46
Lubricate the Optional Bogie Wheel.....	46
250 Hour Service .....	46
Clean the Air Cleaner Element.....	46
Replace Engine Oil and Filter .....	47
500 Hour Service .....	48
Replace Hydraulic Oil and Filter.....	48
Replace the Fuel/Water Separator Filter.....	48
Replace the Fuel Filter .....	49
Replacing the Outer Primary and Inner Safety Filters.....	49
1000 Service Hours .....	50
Replace Radiator Coolant.....	50
1500 Service Hours .....	51
Replace Engine Crankcase Breather Element.....	51

## TABLE OF CONTENTS

Regular Maintenance.....	51
Blade Drive Belts.....	51
Tensioning the Blade Drive Belts .....	51
Engine .....	52
Engine Control Module (ECM) .....	52
Battery .....	52
Battery Type.....	53
Servicing the Battery .....	53
Electrical System .....	53
Fuses .....	53
Replacing Fuses.....	53
Speed Control Lever.....	54
Adjusting Speed Control Cable .....	54
Adjusting the Lever Tension.....	54
Adjusting the Spring Plungers.....	54
Inner Blade Flange .....	55
Installing the Inner Blade Flange.....	55
Removing the Inner Blade Flange.....	55
Maximum Cutting Depth Stop Bolts.....	55
Handlebar Lock Cylinder (Optional).....	55
Removing the Lock Cylinder .....	56
Connecting the Lock Cylinder .....	56
Lifting and Transporting.....	56
Lifting.....	56
Transporting.....	57
Storing .....	57
Disposal.....	57
Appendix A .....	61
Troubleshooting .....	61
Appendix B .....	63
CC5049D RPM Chart.....	63
CC5049D Blade Size Conversion Chart .....	64
Appendix C .....	65
Additional Resources .....	65
Appendix D .....	66
Model and Serial Numbers.....	66

## INTRODUCTION

### **Introduction**

Welcome to the Diamond Products family and thank you for choosing Diamond Products equipment. At Diamond Products we are driven to ensure you are completely satisfied with your product and continually strive to improve our product line so that we can offer you the best possible equipment in the industry.

This operator's manual is a critical document that provides pertinent information regarding the safety, operation, maintenance, and care of your new equipment. Keep this manual available at all times. Operate the equipment and all of its components according to this manual. Failure to comply with and understand the following safety, operation and maintenance instructions can result in serious injuries and/or death. All operators must be properly trained or supervised by experienced personnel prior to using this saw and should understand the risks and hazards involved. Diamond Products discourages improper or unintended equipment usage and cannot be held liable for any resulting damages.

Equipment modifications should be made by Diamond Products to ensure safety and design. Any modifications made by the owner(s) are not the responsibility of Diamond Products and void all equipment warranties if a problem arises as a result of the modification.

Refer to the Diamond Products Parts List for additional information and part diagrams. Refer to the engine manual and manufacturer as the primary source for all safety, operations, and maintenance instructions regarding the engine. Prior to operating, record the saw's serial number, and the engine's model and serial numbers in Appendix D.

To order go to Discount-Equipment.com

# INTRODUCTION

## CC5049D Controls

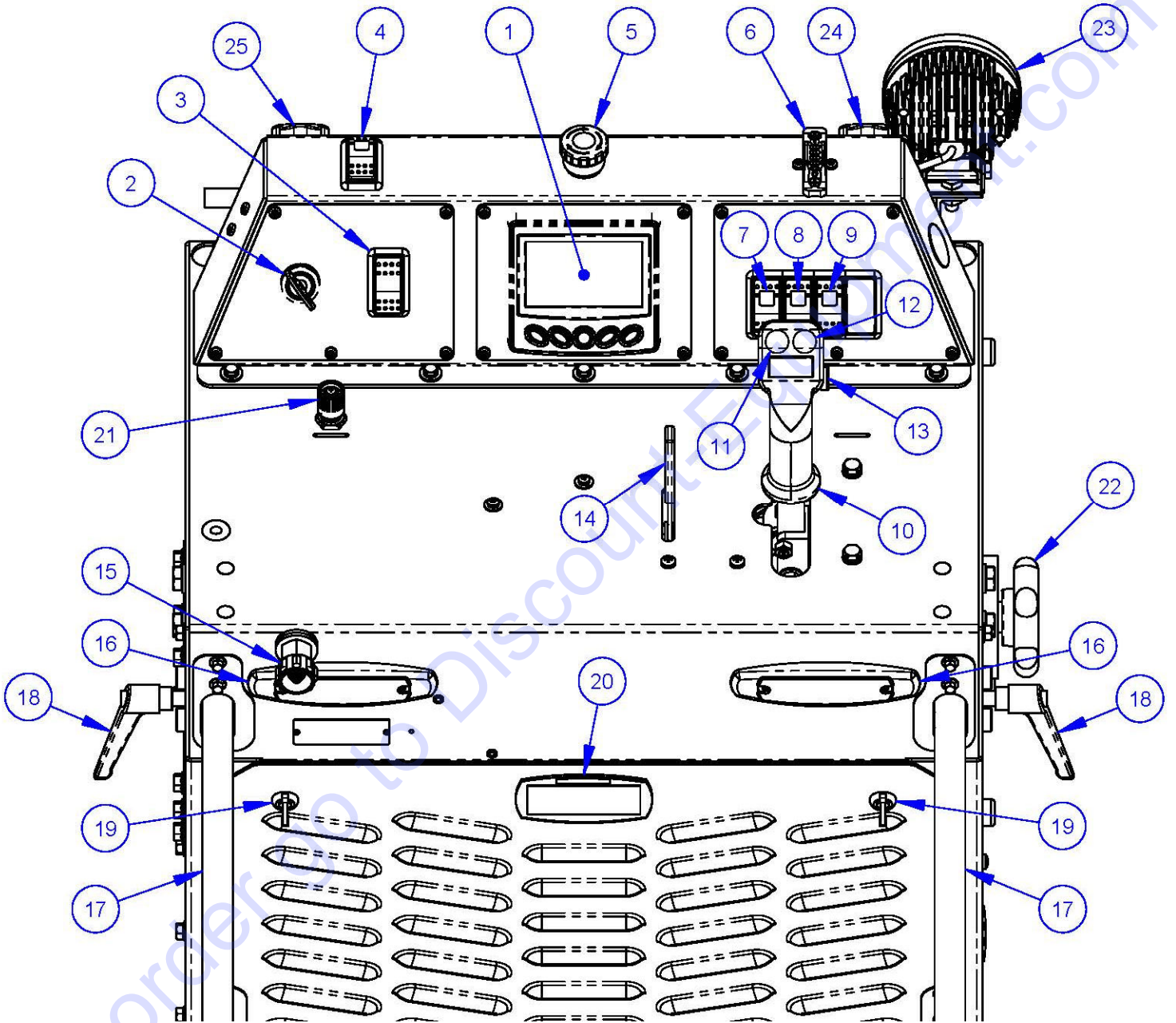

## INTRODUCTION

1. **Engine Display Panel** – Monitors and displays various engine and machine parameters.
2. **Ignition Switch** – Starts the engine and provides power to certain components.
3. **Engine Throttle Rocker Switch** – Increases and decreases engine/blade speed (RPM).
4. **Free Wheel Rocker Switch** – Disengages the transmission to allow for manual forward and reverse movement of the saw.
5. **Emergency Stop Button** – Stops the engine.
6. **Pointer Rope Cleat** – Secures front pointer rope.
7. **LED Spot Light Switch (Optional)** – Activates spotlight.
8. **LED Light Bar Switch (Optional)** – Activates light bar.
9. **Water Pump Switch (Optional)** – Activates water pump.
10. **Travel Speed Control Lever** – Forward, reverse, and neutral control.
11. **Saw Raise Push Button** – Activates hydraulic pump to raise saw.
12. **Saw Lower Push Button** – Bleeds hydraulic pressure from lift cylinder to lower saw.
13. **Tilt Handlebar Button (Optional)** – Allows adjustment of handlebars up or down to desired angle.
14. **Water On/Off Control Valve** - Turns water flow, to the saw blade, on and off.
15. **Water Inlet Attachment Fitting** – Attachment point for water supply.
16. **LED Marker Light (Optional)** – Illuminates when machine is on.
17. **Adjustable Handle Bar** – Allows for operator control of saw.
18. **Handle Bar Lock Lever** – Locks the handlebar extension in place.
19. **Rear Cover Screen Latch** – Allows for removal of rear cover screen for servicing.
20. **Rear Cover Screen Pull Handle** – Allows for easy handling of rear cover screen.
21. **Lowering Speed Control Valve** – Controls the lowering speed of the saw.
22. **Blade Storage Knob (Optional)** – Provides a storage location for blades up to 36”.
23. **LED Spot Light (Optional)** – Provides area lighting.
24. **Spot Light Adjustment Knob (Optional)** – Allows for positioning of spot light.

## INTRODUCTION

### CC5049D Dimensions

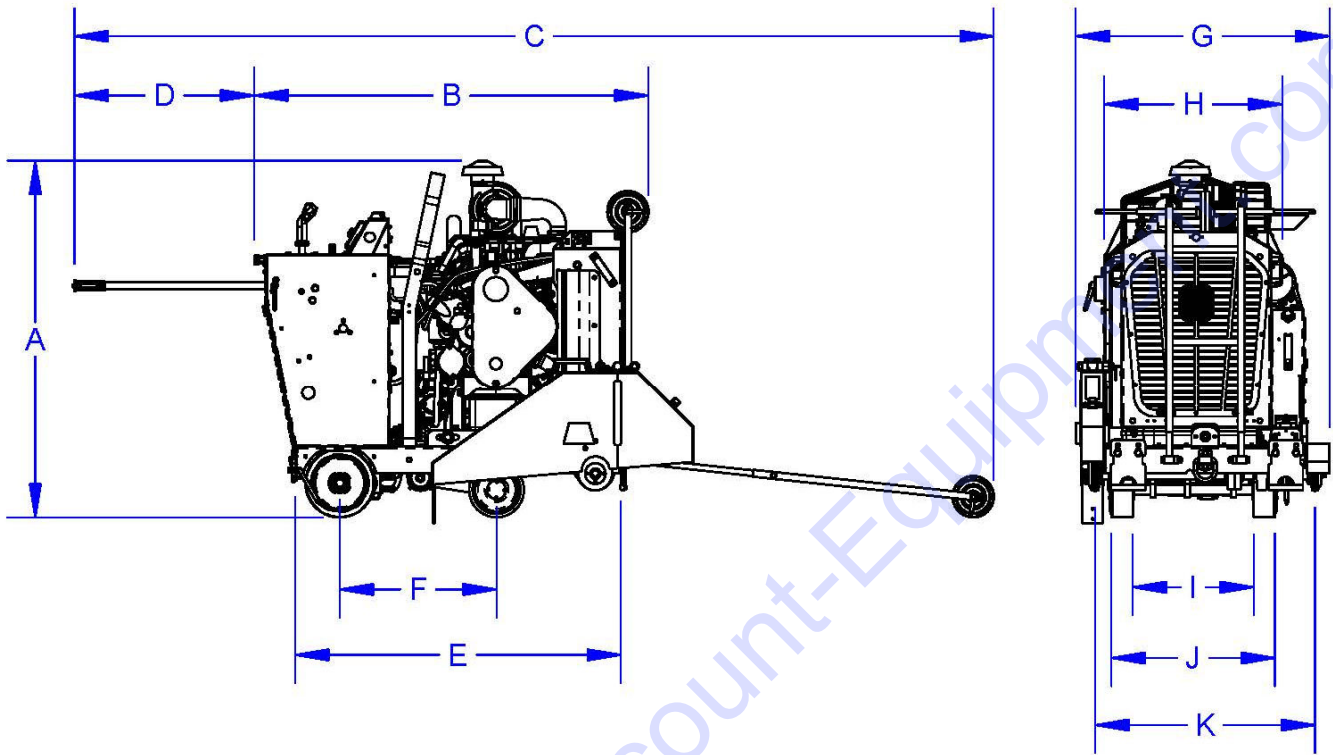

CC5049D Dimensions		Inches	Millimeters
A	Saw Height	52	1321
B	Saw Length - Min.	57-1/2	1461
C	Saw Length - Max.	134	3404
D	Handle Extension - Max.	28	711
E	Frame Length	47-1/2	1207
F	Wheel Base Length	23	584
G	Saw Width	37	940
H	Rear Frame Width	26	660
I	Front Wheels Inside Width	17-1/2	445
J	Rear Wheels Outside Width	24-1/4	622
K	Inner Flange to Inner Flange Width	32	813
-	Blade Raise Height - Max.	23	584



## INTRODUCTION

### CC5049D Specifications

Saw Model	CC5049-14	CC5049-20	CC5049-26	CC5049-30	CC5049-36	CC5049-42
Blade Guard Capacity	14"	20"	26"	30"	36"	42"
Blade Cutting Depth Max	4.75"	7.75"	10.5"	12.5"	15"	17.5"
Blade Shaft Speed	2800 rpm	2600 rpm	2000 rpm	1700 rpm	1400 rpm	1200 rpm
Blade Flange Size	4.5" OD	4.5" OD	5" OD	5" OD	6" OD	7" OD
Operating Weight*	1703 lbs.	1713 lbs.	1735 lbs.	1743 lbs.	1764 lbs.	1785 lbs.
Crated Weight	1758 lbs.	1768 lbs.	1790 lbs.	1798 lbs.	1819 lbs.	1840 lbs.
Blade Guard Weight Only	15 lbs.	25 lbs.	41 lbs.	49 lbs.	63 lbs.	72 lbs.
Engine Brand Model	CAT C2.2 (DIT)					
Emission Regulation	EPA-CARB Tier 4 Final / EU Stage III B					
Engine Type	2.2 liter, 4 cylinder, liquid cooled, turbo diesel					
Engine Max Power	48.8 hp @ 2800 rpm (CAT rating)					
Engine Peak Torque	122 Ft-Lbs (165 Nm) @ 1800 rpm					
Aftertreatment Device	Diesel Oxidation Catalyst (DOC)					
Engine Air Filtration	Dry dual element with restriction indicator					
Battery	12 Volt (600 CCA) group size 24					
Starter / Alternator	Electric 2.7hp (2kW) / 85 Amp					
Fuel Type	Ultra low sulfur diesel (Cetane 45 min)					
Fuel Tank	6.5 Gallon (24.6 Liter) with electronic low fuel level indication					
Engine Oil	SAE 15W-40 API class CJ-4 (2.8 Gallon/10.6 Liter)					
Radiator Coolant	50/50 Pre-mixed (3 Gallon/11.3 Liter)					
Wheel Motor Pump Fluid	SAE 15W-40 (2 Liter capacity)					
Saw Lift Pump Fluid	SAE 15W-40 (2 Liter capacity)					
Lubrication Type	NLGI #2 Lithium grease					
Blade Arbor Size	1" Diameter with drive pin					
Blade Flange Type	Quick disconnect					
Blade Shaft Size	1-3/4" OD with left/right side blade mounting					
Blade Shaft Bearings	2 Pillow blocks with greaseable ball bearings					
Blade Shaft Drive	8 V-Belts (3VX)					
Blade Coolant	Dual stainless steel multi-jet spray tubes					
Blade Guard Attachment	Slip-on tapered spade (with rear bolt for 36" and 42" guard size)					
Blade Raise and Lower	Electro-hydraulic power unit with push button control					
Blade Lowering Speed	Adjustable panel mounted flow control valve					
Blade Depth Control	Electronic depth indicator and depth stop					
Blade Alignment	Telescoping front/rear/left/right pointers with tracking adjustment					
Axle Size (Front/Rear)	Front: 1" OD / Rear: 1-1/4" OD					
Front Wheels	8" x 3" with 1/2" poly tread (sealed ball bearings)					
Rear Wheels	10" x 3" with 1" rubber tread (quick disconnect keyless bushing)					
Travel Speed	0-220 FPM (2.5 mph) forward/reverse					
Rear Wheel Transmission	Hydrostatic pump with push/pull cable control					
Rear Wheel Drive	Hydraulic wheel motor gear drive with freewheel for pushing					
Parking Brake	Automatic hydraulic lock at stop position					
Handle Bar Adjustment	3 position with variable extension					
Safety Alerts	Emergency stop, blade over-speed, neutral start					

\*With blade guard and full fuel tank - no blade

## SAFETY PRECAUTIONS

### Safety

Operate the equipment and all of its components according to this manual. Failure to comply with and understand the following safety, operation and maintenance instructions can result in serious injuries and/or death. All operators must be properly trained or supervised by experienced personnel prior to using this saw and should understand the risks and hazards involved. Diamond Products discourages improper or unintended equipment usage and cannot be held liable for any resulting damages.

Equipment modifications should be made by Diamond Products to ensure safety and design. Any modifications made by the owner(s) are not the responsibility of Diamond Products and void all equipment warranties if a problem arises as a result of the modification.

Refer to the Diamond Products Parts List for additional information and part diagrams. Refer to the engine manual and manufacturer as the primary source for all safety, operations, and maintenance instructions regarding the engine. Prior to operating, record the saw's serial number, and the engine's model and serial numbers in Appendix D.

**Notice: The information in this manual may be updated at any time!**

### **Safety Alerts**



#### **DANGER**

Serious injuries and/or death will occur if these instructions are not followed.



#### **WARNING**

Serious injuries and/or death could occur if these instructions are not followed.



#### **CAUTION**

Mild and/or moderate injuries could occur if these instructions are not followed.

### **Proposition 65**

#### **PROPOSITION 65**



**WARNING:** This product produces gasoline or diesel engine exhaust, which is known to the state of California to cause cancer, birth defects or other reproductive harm. For more information go to:  
**WWW.P65WARNINGS.CA.GOV**

### **Spark Arrester Requirement**



#### **WARNING**

In the State of California it is a violation of section 4442 or 4443 to use or operate the engine on any forest-covered, brush-covered, or grass-covered land unless the engine is equipped with a spark arrester, as defined in section 4442, maintained in effective, working order or the engine is constructed, equipped, and maintained for the prevention of fire pursuant to section 4443.

### **Respiratory Hazards**



#### **WARNING**

Concrete cutting produces dust and fumes known to cause illness, death, cancer, respiratory disease, birth defects, and/or other reproductive harm. Safety protection techniques include, but are not limited to:

- Wearing gloves.
- Wearing safety goggles or a face shield.
- Using approved respirators.
- Washing work clothes daily.
- Using water when wet cutting to minimize dust.
- Washing the hands and face prior to eating/drinking.

For additional safety and self-protection information contact your employer, the Occupational Safety and Health Administration (OSHA), and/or The National Institute for Occupational Safety and Health (NIOSH).



## SAFETY PRECAUTIONS

### General Safety

- Read and understand all safety, operations, and maintenance instructions provided in this manual prior to operating or servicing the saw.
- Keep equipment components clean and free of slurry, concrete dust, and debris.
- Inspect water hoses prior to operating the equipment. Clean, repair, or replace damaged components.
- Raise the equipment to a proper height for access when working underneath the equipment. Use chocks to block the wheels, and fit blocks or jacks under the frame edges.



### WARNING

Do NOT work on equipment using the hydraulic lift system to keep the equipment in the raised position for maintenance or repair. Accidental loss of hydraulic pressure could cause the equipment to drop suddenly, resulting in serious injury or death.

- When using a jack to raise the equipment, place the jack against a solid, flat area under the frame base to properly support the equipment.
- Repair the equipment immediately when a problem arises.
- Replace equipment decals if unreadable.
- Dispose of all hazardous waste materials according to city, state, and federal regulations.
- Always have a phone nearby, and locate the nearest fire extinguisher and first aid kit prior to operating the equipment.
- Operate the equipment wearing flame resistant clothing.
- Always wear safety glasses when removing retaining rings.
- Underage or non-trained personnel should not operate the equipment.
- Keep all body parts away from rotating machinery.
- Replace all guards and access panels (unless stated otherwise) prior to operating the equipment.
- Always pivot front of blade guard fully closed to avoid serious injuries.

### DO NOT:

- Assume the equipment will remain still when in neutral or when parking/stopping the equipment on a slope. Chock the wheels to help prevent unnecessary movement.
- Drop equipment, supplies, tools, etc., when handling to help prevent injuries.
- Lift and carry equipment, supplies, tools, etc., that are too heavy and/or cannot be lifted easily.

- Operate the equipment without using the appropriate safety equipment required for the work task.



- Operate or service the equipment with any clothing, hair, or accessories that can snag in the machinery, which could lead to serious injuries or death!
- Operate the equipment using attachments not associated with or recommended for the equipment.
- Operate the equipment around combustible materials.
- Operate the equipment with anyone near the work area or within the direct line of the blade.
- Operate the equipment until all unnecessary materials have been removed from the work area.
- Operate the equipment with loose nuts, screws, and bolts.
- Operate the equipment when ill or fatigued.
- Operate the equipment under the influence of drugs and/or alcohol.
- Operate the equipment on steep slopes.
- Cut concrete with guards and access panels removed.
- Grease the equipment with the engine running.
- Touch hot components when operating the equipment.
- Leave the equipment unattended until the engine is off and the blade has stopped.
- Place the equipment into storage until it has cooled down.
- Service the equipment until it has cooled down.
- Service the equipment with the engine running.

## SAFETY PRECAUTIONS

### Battery and Electrical Safety

- Ignitable explosive gases are emitted from the battery. DO NOT expose the battery to sparks or open flames. 
- Keep the area around the battery well-ventilated.
- Keep the battery level when handling it.
- Use protective eyewear or a face shield, and avoid contact with the skin when handling/servicing the battery.
- Use a proper battery tester when testing the battery strength.
- Always be sure to connect the battery cables to the proper terminal when reconnecting the cables.
- Occasionally inspect the battery, cables, clamps, and terminals for damages. Service components as necessary.
- Always keep the battery cable clamps away from the battery terminals when the battery is disconnected to avoid accidental connections while servicing.
- Immediately rinse your clothing, skin, or eyes with water if exposed to battery acid. Seek medical attention immediately!
- Disconnect the battery prior to servicing all equipment components (unless stated otherwise).
- Remove the battery when storing the equipment for longer periods.
- Always use the correct size fuses (amps) to prevent fires.

### Blade Safety

- Always use reinforced abrasive blades or steel-centered diamond blades.
- Never use a wet cutting blade without an adequate water supply to properly lubricate the blade.
- Inspect all blades prior to usage and discard damaged blades.
- DO NOT install or remove a blade with the engine running.
- Keep all body parts away from rotating blades.
- Inspect the blade flanges for damages, wear, and cleanliness. Clean or replace dirty/damaged components immediately.

- DO NOT expose yourself or anyone else to the direct line of the blade when operating the equipment.



- Always use an appropriate size blade and the correct blade type based on the cutting task and the type of material being cut.
- The blade must always fit snug on the blade shaft, outer flange, and/or inner flange.
- Wear gloves and be alert to the surrounding environment when handling blades.
- When installing the blade, always point the arrow printed on the blade in the direction of the blade shaft's rotation.
- DO NOT exceed the blade's maximum recommended speed when cutting. Excessive blade speeds can cause blade breakage, resulting in serious injuries and/or death!
- DO NOT use damaged blades when cutting to avoid harming yourself, others, or the equipment.
- DO NOT use a blade for cutting that requires a lower speed than the blade shaft speed.
- Always tighten the blade shaft bolt/screw as directed to properly secure the outer flange and blade. Failure to properly secure the outer flange and blade may cause parts to loosen or fall off the equipment, resulting in serious injuries or death!
- Let the blade cool prior to removal when dry cutting (applicable models).

### Blade Guard Safety

- DO NOT operate the equipment with the blade guard raised or removed.
- Blade exposure should not exceed 180° while cutting.
- When pivoting the front of the blade guard, raise/lower it cautiously and slowly to avoid serious injuries.
- DO NOT pivot the blade guard front up or down when installing/removing very large blades. Attempting to pivot the front of a heavy guard when the guard is positioned higher up for blade installation/removal makes the guard difficult to lift and/or lower. In this situation, install/remove the blade guard front instead of pivoting it.

## SAFETY PRECAUTIONS

- Always pivot the front of the blade guard 180° (fully upward) so the guard does not swing down unexpectedly, causing serious injuries.



- Always secure the front pivoted section of the blade guard using the detent pin (guards 26" and up).
- Use extreme caution when installing/removing parts of a guard or the entire guard as guards can be extremely heavy and may require installation/removal at moderate heights.
- DO NOT install or remove the blade guard with the engine running.
- Always use a blade guard that corresponds with the blade size.
- Inspect the blade guard and water tubes prior to starting the equipment. Clean or replace dirty/damaged components immediately.

### Fuel Safety

- Always use caution when refueling.
- Store all fuel in appropriate safety containers.
- DO NOT operate the equipment with a fuel leak.
- DO NOT fuel the equipment with the engine running.
- Let the engine cool prior to adding fuel.
- Refer to the engine manual for recommended fuels.
- Always use appropriate fuels in cold weather.
- Move the equipment away from the refueling area prior to starting the engine.

- DO NOT smoke or expose fuel to open flames when filling the fuel tank or working with fuel.



- Clean up any spilled fuel prior to starting the engine.
- Drain the fuel tank and fuel lines when storing the equipment for longer periods of time. Refer to the engine manual for additional recommendations.

### Engine Safety

- Refer to the engine manual as the primary source for engine safety.
- Always know how to turn off the engine quickly for emergency purposes.

- Make sure the equipment is in neutral when starting the engine.
- Fill the fuel tank and check the oil level prior to starting the engine.

- Keep all body parts away from rotating equipment parts with the engine in operation.



- DO NOT start the engine without the air filter(s) installed.
- DO NOT allow dust to enter the air intake tube when cleaning/replacing air filter(s).
- Replace damaged components immediately that may allow dust to enter the engine.
- DO NOT leave the engine running unattended.

- Always operate the equipment in well-ventilated areas. Concentrated engine exhaust can cause loss of consciousness and/or death.



- DO NOT touch the engine/muffler assembly with the engine running, and always let them cool down prior to touching or servicing the equipment.
- Handle hot oil carefully when changing the oil.
- Let the engine cool prior to removing pressurized caps (applicable models).
- DO NOT use any starter substances or starter fluids (e.g., starter fluid sprayed into the air filter) when starting the engine using a glow plug (applicable models). These materials are extremely flammable and explosive, and can melt parts or possibly explode when used to help start the engine.

### Cutting Safety

- The direct work area should not contain buried or embedded electrical, gas, or water lines that could be damaged and/or cause personal injury while cutting.
- Turn off all electricity, gas, and water around the direct work area prior to cutting.
- Inspect the work area to ensure nothing will impede full control of the machine at all times.
- DO NOT expose yourself or anyone else to the direct line of the blade when operating the equipment.

## SAFETY PRECAUTIONS

- DO NOT allow any person, animal, and/or objects in and around the work area while cutting.
- DO NOT install a blade on the machine until it is in the cutting area.
- Ensure the work area is adequately illuminated to ensure safe operation of the machine.

### Hydraulic Safety

- Turn off the engine prior to servicing hydraulic components.
- Lower the equipment completely prior to servicing to decrease the hydraulic pressure in the lines.
- Always make sure any hydraulic components being serviced are not supporting the weight of other equipment components. If a particular component is under pressure when connection points are loosened, oil may spray out forcefully.

- Always place a piece of cardboard or paper up against hydraulic components, or use a leak detection fluid to check for hydraulic fluid leaks. Keep all body parts away from leaks and/or areas that may eject hydraulic fluid. Pressurized hydraulic fluid can penetrate the skin, causing serious injuries. Seek medical attention immediately!



### Belt Safety

- Turn off the engine and let the belts cool down prior to servicing them.
- Regularly inspect the belts for fraying, stress cracks, and/or breakage and replace immediately when damaged. Always check the belt alignment prior to operating the equipment.
- Use extreme caution when working with belts and rotating machine parts to avoid entanglement.
- Over-tensioning belts may reduce the life of the blade shaft bearings. Under-tensioning belts may cause slippage, shorter belt life, and/or poor equipment performance.
- Squealing belts indicate looseness and must be tightened to proper tension specifications.
- DO NOT use old and new belts together on the same sheave.

### Transporting Safety

- Remove the blade prior to transporting the equipment.
- Make sure the truck/trailer is in good, working condition and sufficient to transport the load. DO NOT tow the equipment behind a vehicle.
- Close the fuel shutoff valve (applicable models) when transporting.
- Drain the fuel tank when transporting long distances.
- Use heavy-duty ramps that will support the weight of the equipment and yourself when loading or unloading.
- Raise the equipment to avoid damaging components while moving up and down ramps.

- Use extreme caution when guiding the equipment up and down ramps. Slowly drive the equipment forward down the ramp. Slowly back the equipment in reverse up the ramp. Avoid standing directly downhill from the equipment to prevent machine rollover.



- Place the equipment in neutral and turn off the engine once the equipment is loaded in the truck/trailer.
- Chock the wheels and secure the saw in the truck/trailer prior to transporting.
- Refer to the Department of Transportation (DOT) for additional transportation recommendations.

### Lifting Safety

- Move yourself and all others away from the lifting area when hoisting the saw to prevent being crushed.



- Secure the appropriate hoisting cables, straps, and/or chains to the saw's designated lift points prior to hoisting.
- Never use the tie-down brackets (applicable models) to lift the saw.
- DO NOT attempt to lift the saw irresponsibly and/or improperly.

## DISPLAY PANEL

### Display Panel Controller

The display panel is a rugged Controller Area Network or CAN. This is a means of linking all of the electronic systems within the saw together allowing them to communicate with each other. This section explains the functions of the unit, describes the display screens and gives details about the configuration.

### **Controller Features**



### **Flat Screen Display**

The flat screen displays the gauges, dashboard warning icons, soft key commands, fault messages, and menu options for setup and configuration.

There are a series of eight digital gauges, four on the left side of the display and four on the right. These gauges display current parameters associated with the saw.

<u><b>Left Side</b></u>	<u><b>Right Side</b></u>
Blade Size	Blade Depth
Battery Voltage	Engine Oil Pressure
Engine Coolant Temperature	Fuel Level
Actual Engine Hours	Blade Depth Stop Setting



## DISPLAY PANEL

There is a large digital gauge located in the center of the display. This gauge can be toggled through using the function keys to show blade speed, engine speed, and engine torque.



**Blade Speed Indication**



**Engine Speed Indication**



**Engine Torque Indication**

Directly above the large center gauge is the dashboard warning icon display area. When certain conditions arise, there are seven icons that will be displayed in this area.

	Parking Brake - Green icon will illuminate when the hydraulic parking brake is applied.
	Fuel Level – Red icon will illuminate when a low fuel level condition exists.
	Battery Voltage – Red icon will illuminate when a low battery voltage condition exists.
	Maintenance Required – Yellow icon will illuminate when a required maintenance milestone is reached.
	Oil Pressure – Red icon will illuminate when a low oil pressure condition exists.
	Coolant Temperature – Red icon will illuminate when a high coolant temperature condition exists.
<b>N</b>	Neutral – Green icon will illuminate when the transmission is in neutral.

Directly below the large center gauge is a clock. This area will also display any active fault conditions associated with the saw.

## DISPLAY PANEL

### Function Keys

When pressed, the function keys correspond to soft key commands and allow selections to be made accordingly. The soft key selections will appear at the bottom of the display.



Soft Key Commands

### Soft Key Commands

A horizontal row of commands located at the bottom of the display screen can be selected by pressing the function key directly below it. The soft key options associated with this saw are listed below:

Soft Key	Description
	Blade Size – Toggles to the blade size selection screen
	Parameter Screen Selection – Toggles between Engine Speed, Blade Speed, and Engine Torque digital gauges
	Main Menu – Toggles to the Main Menu screen that provides three options: <ul style="list-style-type: none"> <li>• Engine Diagnostics</li> <li>• User Settings</li> <li>• Utilities</li> </ul>
	Zero Blade – Sets the reference point for the blade depth setting
	Blade Depth Stop (Inactive) – Sets the blade depth stop setting
	Blade Depth Stop (Set) – Blade depth stop setting is active

## DISPLAY PANEL

Soft Key	Description
✓	Select – Enters the action item highlighted on the screen
←	Left Arrow – Moves cursor to the left
→	Right Arrow – Moves the cursor to the right
↑	Up Arrow – Moves the cursor up
↓	Down Arrow – Moves the cursor down
+	Plus – Increases a numerical selection
-	Minus – Decreases a numerical selection
↶	Return – Returns to previous screen
↷	Reset – Resets the service reminder hours on maintenance milestones when the maintenance is completed
🔍	Fault Information – Provides additional information regarding active/stored faults

### Main Menu Key

Pressing the **MENU** key displays the list of three available menu options:

- Engine Diagnostics
- User Settings
- Utilities





### Engine Diagnostics

The engine diagnostics screen displays the following items:

1. Recall Active Faults
2. Stored Faults



### Recall Active Faults

This screen displays active faults or warnings from the Electronic Control Unit (ECU). Each diagnostic is shown with the appropriate Suspect Parameter Number (SPN), Failure Mode Indicator (FMI), Text Description (if available) and the source of the device that transmitted the diagnostic message.



## DISPLAY PANEL

### Stored Faults

This screen displays the non-active faults or warning from the ECU. Each diagnostic is shown with the appropriate Suspect Parameter Number (SPN), Failure Mode Indicator (FMI), Text Description (if available) and the source of the device that transmitted the diagnostic message.



### **User Settings**

The user setting is a series of two screens that display the following items:

1. Brightness
2. Language
3. Units
4. Set Clock



### Brightness

This option allows the operator to increase or decrease the intensity of the backlighting as needed to clearly view the display screen.

## DISPLAY PANEL

### Language

This option allows the operator the ability to select the desired language utilized on the display. There are three languages choices:

- English
- Spanish
- French

### Units

This option allows the operator to choose between standard (US) and metric units.

### Set Clock

This option allows the operator to set and update (save setting) the time on the clock display. The clock will remain operational when the unit is turned off. Only when battery power has been lost will the clock need to be reset and updated.

### **Utilities**

The utilities screen displays the following items:

1. Service Reminders
2. System Information



### Service Reminders

This option is a series of two screens that show the five critical service reminders with the time in hours when the next service is due to be completed. When a service item is completed the time can be reset for the next service schedule. See the maintenance section of this manual for additional information regarding maintenance schedules.

## DISPLAY PANEL



### System Information

The system information screen is informational only. The screen displays the following settings:

1. Engine Make
2. Engine Model
3. Engine Serial Number
4. Rated Power
5. Rated Speed
6. Software Revision

### **Operation**

#### **Blade Size Selection**

When the ignition switch is turned to ON, the display will begin to boot up. The first screen to appear will be the "Blade Size Selection" screen. It is important to have the correct blade size selected for the installed blade on the machine. Not having the proper blade size selected for the installed blade will result in reduced cutting efficiency or serious bodily injury. Refer to the RPM and Blade Size Conversion Charts located in Appendix B at the end of this manual.



## DISPLAY PANEL

To select the proper blade size:

1. Scroll through the available blade sizes using the function keys associated with the right and left arrow soft key commands located on the lower right side of the display panel.
2. When the proper size appears on the screen, press the select function key (middle key) to accept the blade size and this will bring up the “Main” screen.

The blade size can also be selected from the “Main” screen by pressing the left function key associated with the “Blade Size” soft key command. When the key is pressed the “Blade Size Selection” screen will appear.

### Zero the Blade

Ensure that the saw is operating and all safety precautions are being followed.

1. Lower the saw blade to just above the cutting surface.
2. Press the second function key on the right until the top right hand gauge on the display shows 0.00 in.

The blade is now zeroed. When the blade is lowered into the cut, the gauge will increase incrementally in inches to show the depth of the cut.

### Set the Blade Depth Stop

Ensure that the saw is operating and all safety precautions are being followed.

1. Follow the “Zero the Blade: procedure listed above.
2. Lower the blade into the cut to the desired depth.
3. Press the function key farthest right on the display panel until the Blade “Depth Stop Active” icon appears on the right side of the soft key command area.



### Deactivate the Blade Depth Stop Setting

To deactivate the “Blade Depth Stop” setting, press the function key farthest right until the soft key command icon shows the “Blade Depth Stop” (Inactive) icon.

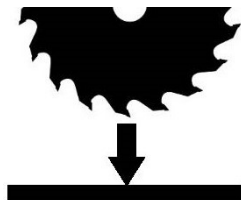



## Operating

### **General Operating Precautions**

- Prior to operating the machine, read the operator's manual thoroughly and ensure that you understand the safe and proper operation of the machine.
- Use approved personal protective equipment at all times while operating the machine.
- Ensure that there is firefighting equipment and a first aid kit nearby while operating the machine.
- Ensure the cutting area is free of obstructions, people, and or animals prior to operating the machine.
- Always operate the machine from the operator's position at the rear of the machine between the handlebars.
- Do not stand in front or behind the blade path while the engine is running.

### **Emergency Stop**

If an emergency condition should arise, the machine is equipped with an emergency stop button located on the top of the control panel. The emergency stop places the machine into safe mode allowing the operator to address the emergency condition.

*NOTE: Only use the emergency stop in an emergency condition. Do not use it to stop the machine during normal operations.*

### **Activating the Emergency Stop**

To activate the emergency stop, press down on the emergency stop button. The engine will shut off and the display panel will indicate that the emergency stop is active.

### **Deactivating the Emergency Stop**

Prior to deactivating the emergency stop, ensure that the machine is back into a safe operating condition. Then turn the emergency stop button clockwise until it springs back into position. The machine can now be restarted.



**Emergency Stop**

### **Handlebars**

The handlebars help to guide and maneuver the saw. During transporting of the saw, the handlebars should be placed in the storage tubes to save on space and prevent losing them. Place the handlebars in the desired position for better leverage when steering. To maneuver the saw forward or backward, turn on the *Free Wheel* switch and move the saw as desired.

*NOTE: The free wheel component only works with the ignition key at ON position.*



**Handlebar Storage**



**Handlebar, Operating Position**



**Free Wheel Switch**

### Manually Adjusting the Handlebars

1. Loosen both handle lock knobs.
2. Hold the handlebar grip and place the first handlebar into the handlebar opening below the handle lock knob. The handlebar fits through three different adjustment angles inside the handlebar opening (0°, 15°, and 30°). Place the handlebar at the desired angle.
3. Tighten the handle lock knob to secure the handlebar.
4. Repeat steps 2–3 to secure the second handlebar.

### Adjusting the Power Tilt Handlebars (Optional)

1. Loosen the handlebar adjusting lever.
2. Move the handlebar forward or backward to adjust the length and retighten the adjusting lever to secure.

**NOTE:** Maintain a minimum of 6" of handlebar into the handlebar tube at all times.

3. Press the *Tilt Handlebar* pushbutton, located on the side of the control grip, and move the handlebar up or down to adjust the angle.

**NOTE:** The button only works with the ignition key at the ON position.

4. To reposition adjustment lever, pull out and move to desired lever position.

### Speed Control Lever

The speed control lever is a part of an electro-hydraulic assembly that allows the operator to raise and lower the machine, move the machine in a forward or reverse direction, or place the machine in *STOP/PARK*.

### Control Grip Pushbuttons

The control grip pushbuttons only work with the ignition key at the *ON* position.



**Control Grip Pushbuttons**

1. Press the *Raise* (left) pushbutton to raise the saw and blade, and release to stop.

**NOTE:** Always raise the blade when maneuvering the saw to provide proper clearance between the blade and the ground.

2. Press the *Lower* (right) pushbutton to lower the saw and blade, and release to stop.

### Blade Lowering Speed

Turn the *Blade Lowering Speed* valve counterclockwise to increase the blade's lowering speed and clockwise to decrease the blade's lowering speed.

**NOTE:** The valve does not adjust the blade's raising speed which is not adjustable.



**Blade Lowering Speed Valve**

### Moving the Machine Forward / Reverse with the Engine Running

*NOTE: Prior to moving the machine, read and understand the "Starting the engine and Stopping the engine" section of this manual.*

The speed control lever will only move the saw in a forward or reverse direction when the engine is running.

1. Turn the ignition switch to the *ON* position.
2. On the display panel, verify the blade size and then open the main screen.
3. Raise the machine by pressing the *Raise* (Left) pushbutton on the control grip until the blade clears the pavement.
4. Place the speed control lever in the *STOP* position.
5. Turn the ignition switch to the *START* position until the engine starts, then release the switch. The key will return to the *ON* position.
6. Take the speed control lever out of the *STOP* position and slowly push it forward to move the machine forward, or to the rear to move the machine in reverse.

*NOTE: The machine's travel speed will increase as the lever is moved farther in either the forward or reverse direction.*

7. To stop the forward or reverse motion, place the speed control lever in the mid-position and/or into the *STOP* position.

### Moving the Machine with the Engine Off

1. Turn the ignition switch to the *ON* position.
2. Raise the machine by pressing the *Raise* (Left) pushbutton on the control grip until the blade clears the pavement.
3. Place the speed control lever in the *STOP* position.
4. Turn the free wheel switch (located on the top of the left side control box assembly) to the *ON* position.



### WARNING

Do not turn on the free wheel switch or attempt to manually push the machine while it is on a grade or slope. The operator could lose control of the machine causing serious injury to the operator or damage to the machine.



### WARNING

Do not tow the machine when the free wheel switch is on. This could result in damage to the transmission

5. The machine can now be moved manually by standing in the operator's position and pushing the saw while keeping a firm grip on the handlebars.

### **Bogie Wheel (Optional)**

An optional bogie wheel can be installed on the rear of the saw to assist with maneuvering the saw while it is in the fully raised position. There are two positions that the wheel will normally operate in:

- Locked sideways motion
- Free wheel motion

#### **Bogie Wheel - Locked Sideways Motion**

To lock the wheel for side to side movement:

1. Fully pull the ring on the detent pin.
2. Rotate the pin until the ring is vertical to the ground.
3. Rotate the wheel to either the right or left side position.
4. Release the pin in the locking slot of the pin assembly.



**Bogie Wheel – Locked Sideways Position**



## Bogie Wheel - Free Wheel Motion

To unlock the bogie wheel and allow it to move freely:

1. Fully pull the ring on the detent pin.
2. Rotate the pin until the ring is horizontal to the ground.
3. Release the pin in the locked open slot of the pin assembly.

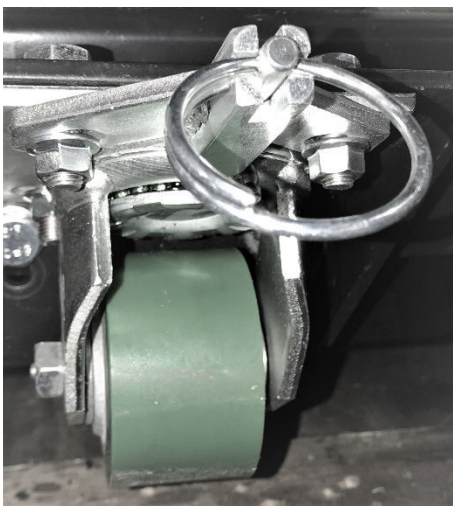

**Bogie Wheel – Locked in Free Motion Position**

### **WARNING**

Keep feet clear. When the saw is raised on any inclined surface, the bogie wheel must be locked in a perpendicular position (3 or 9 o'clock) to the rear wheels to prevent the saw from rolling towards or away from the operator.

## Fuel System

### **WARNING**

Always use caution when refueling.  
 DO NOT operate the saw with a fuel leak.  
 DO NOT fuel the saw with the engine running.  
 DO NOT smoke or expose fuel to open flames when filling the fuel tank or working with fuel.



### **CAUTION**

Clean up any spilled fuel prior to starting the engine.  
 Fuel may seep out from the fuel cap vent (applicable models) when raising the saw if the fuel tank is overfilled.

## Adding Fuel

1. Lower the saw to level the frame.
2. Turn off the engine and let the saw cool down.
3. Remove the fuel tank cap.
4. Fill the fuel tank with ultra-low sulfur diesel fuel only. DO NOT overfill the tank for expansion purposes. Refer to the engine manual for additional information.
5. Replace the fuel tank cap and secure.

## Blade Guard

### **WARNING**

DO NOT operate the saw with the blade guard raised or removed.  
 DO NOT remove the blade guard with the engine running.  
 Blade exposure should not exceed 180° while cutting.  
 Always pivot the front of the blade guard 180° (fully upward) so the guard does not swing down unexpectedly, which may cause serious injuries.  
 Always secure the front pivoted section of the blade guard using the detent pin (guards 26" and up).  
 When pivoting the front of the blade guard, raise/lower it cautiously and slowly to avoid serious injuries.



The blade guard shields the blade and must always be in place when operating the saw. Blade guards generally stay in place at all times, except for when changing to another guard size or when using the guard on the opposite side of the saw. Regularly inspect the blade guard, the guard mount and water tubes. Clean, repair, or replace dirty or damaged components immediately.

*NOTE: Always use a guard size that matches the blade size. Refer to Appendix B.*

## Installing the Blade Guard

Always install the blade guard with the blade off the saw.

1. Holding the blade guard handle, face the front of the blade guard forward and fit the tapered mount on the side of the guard onto the tapered mount on the frame.

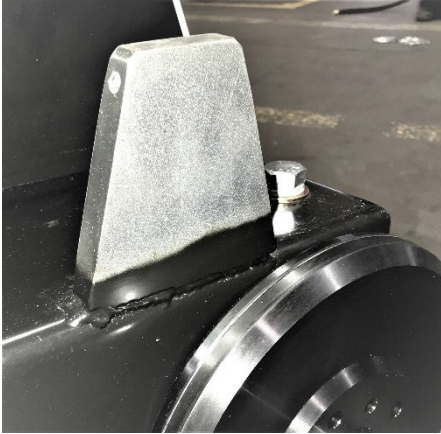

Frame Base Tapered Mount

2. Insert the lock pin through the hole on the tapered frame mount to secure the guard.
3. For guards 36" and larger, place a lock washer and then a flat washer onto the blade guard screw. Fit the screw through the slot near the back of the guard and through the hole on the frame base, and secure the guard to the frame using the provided wrench.
4. Connect the water supply hose to the blade guard.

**Removing the Blade Guard**

Always remove the blade guard with the blade off the saw.

 **WARNING**  
When removing a guard 48" or larger, use a hoist to avoid serious injury.

1. Disconnect the water supply hose from the blade guard.
2. Remove the rear bolt from the blade guard and frame base.
3. Remove the lock pin from the tapered frame mount.
4. Use the handle on the blade guard to rock the guard back and forth while lifting the guard off the tapered frame mount.

**Slurry Shield (Optional)**

An optional slurry shield can be installed on the right rear side of the saw. The shield can be flipped down while cutting to minimize slurry back spray or flipped up flush against the upright when not in use.



Slurry Shield

**Flange Guard**

Install the flange guard over the blade flange that is not in use.

**Installing the Flange Guard**

1. Fit the tapered mount on the back of the flange guard onto the tapered mount on the frame.
2. Insert the lock pin through the hole on the tapered frame mount to secure the guard.

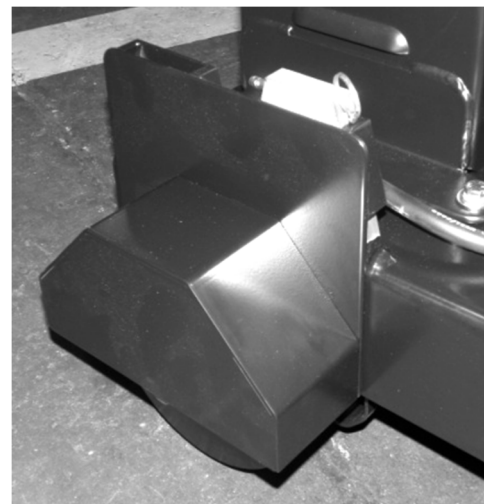

Flange Guard Installed

**Removing the Flange Guard**

1. Remove the lock pin from the tapered frame mount.
2. Remove the flange guard from the tapered frame mount.

### Diamond Blades

**⚠️ WARNING**

DO NOT exceed the blade's maximum recommended speed when cutting. Excessive blade speeds can cause blade breakage, resulting in serious injuries and/or death.

DO NOT use damaged blades when cutting to avoid harming yourself, others, or the saw.



Using the proper blade (size and type) preserves the blade and improves efficiency, resulting in lower costs. Refer to the Association of Equipment Manufacturers (AEM) safety brochure for diamond blades and [www.discount-equipment.com](http://www.discount-equipment.com) for additional blade information.

### Inspecting the Blade

Inspect each blade prior to installation and discard all damaged blades. Inspect the blades for:

- Cracks, nicks, and dents
- A damaged/deformed arbor (center hole)
- Darkness/discoloration near edge of blade
- A deformed blade circumference
- Segment loss/cracks
- Core wear
- Bending
- Uneven side-widths

### Blade Speed

Refer to the CC5049 RPM Chart, located in Appendix B at the end of this manual, the blade, or the blade packaging information for the recommended blade speeds when cutting. DO NOT exceed the maximum recommended blade speed. DO NOT use a blade for cutting that requires a lower speed than the minimum blade shaft speed.

### Wrench

Use the wrench provided when installing or removing a blade. Apply force to the opposite end of the wrench and tighten the blade shaft bolt/screw to 125 ft-lb (170 Nm) minimum to secure the outer flange and blade.

*NOTE: 125 ft-lb is equivalent to applying 125 pounds at the end of a 12" wrench.*

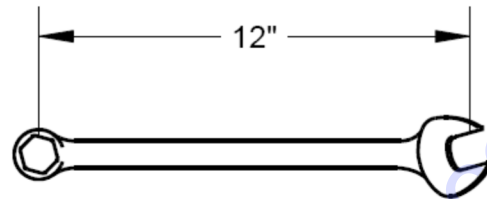

Wrench

### Installing the Blade

**⚠️ WARNING**

DO NOT install a blade with the engine running. Failure to properly secure the outer flange and blade may cause parts to loosen or fall off the saw, resulting in serious injuries or death!

DO NOT pivot the front of the blade guard up or down when installing very large blades. Attempting to pivot the front of a heavy guard when the guard is positioned higher up for blade installation makes the guard difficult to lift and/or lower. In this situation, remove the blade guard front instead of pivoting it.

Always secure the pivoted section of the blade guard using the detent pin.



**⚠️ CAUTION**

Wear gloves and be alert to the surrounding environment when handling blades.

*NOTE: When changing blade sizes, ensure to adjust and/or change all necessary belt drive components in accordance with the CC5049 Parts List.*

The blade can be installed on the right or left side of the saw. Install the blade on the side preferred or most appropriate for the cutting task.

1. Select a blade size and type. Remember to check the blade for damages and discard as necessary.
2. Pivot the front of the blade guard 180° (fully upward) to gain access to the blade flanges. For blade guards 26" and larger remove the detent pin from the front guard

prior to pivoting the front of the blade guard 180° (fully upward).

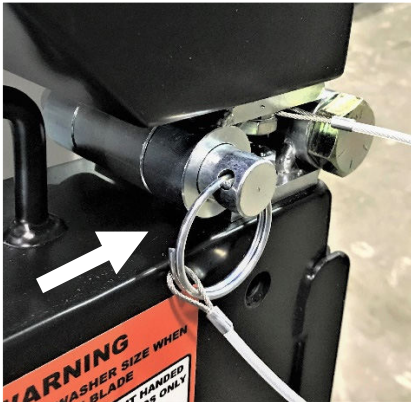

**Detent Pin (26" Blade Guards and Larger)**

3. On the pivoted guards, insert the detent pin through the interlocking barrels on the top of the guard to secure the front of the guard as shown above.



### WARNING

Failure to fully pivot and secure the front of the guard may cause serious injuries.

4. Remove the blade shaft bolt using the provided wrench.  
*NOTE: Clockwise loosens on right side, counterclockwise loosens on left side (when viewed from the operating position) using the provided wrench.*
5. Carefully remove the outer flange. Inspect the flange assembly and clean or replace dirty/damaged components.
6. Align and fit the outer flange and flange pin through the blade.
7. Place the blade and outer flange into the alignment hole and blade arbor of the inner flange. For large blades, carefully roll the blade up to the inner flange. Adjust the height of the saw to align the flange and blade arbor.

*NOTE: Point the arrow stamped on the blade in the direction of the blade shaft's rotation.*

*NOTE: The outer flange should fit snug with the blade, inner flange, and blade shaft.*

8. Slightly rotate the outer flange and blade in the opposite direction of the blade rotation to eliminate backlash (looseness) between parts.

9. Place the wedge lock washer onto the blade shaft bolt and insert the bolt into the blade shaft through the center of the outer flange.
10. Tighten the bolt by hand. Slowly lower the saw, if necessary, until the blade just touches the ground.
11. Tighten the bolt again, using the wrench, to 125 ft-lb (170 Nm) minimum to secure the outer flange and blade.
12. Remove the detent pin from the guard hinge and pivot the front of the guard down over the blade to secure.

### Removing the Blade



### CAUTION

DO NOT remove a blade with the engine running.



DO NOT pivot the front of the blade guard up or down when removing very large blades. Attempting to pivot the front of a heavy guard when the guard is positioned higher up for blade removal makes the guard difficult to lift and/or lower. In this situation, remove the blade guard front instead of pivoting it. Always secure the pivoted section of the blade guard using the detent pin (guards 26" and up).

1. Pivot the front of the blade guard 180° (fully upward) to gain access to the blade flanges. For blade guards 26" and larger remove the detent pin from the front guard prior to pivoting the front of the blade guard 180° (fully upward).



### WARNING

Failure to fully pivot and secure the front of the guard may cause serious injuries.

2. Slowly lower the saw, if necessary, until the blade just touches the ground.
3. Remove the blade shaft bolt using the provided wrench.
4. Carefully remove the outer flange and blade. Place the blade in an appropriate storage location.

*NOTE: An onboard blade storage arbor, for blades up to 36", is available as an option.*



**TO PURCHASE THIS PRODUCT PLEASE CONTACT US**



**Equipment Financing and  
Extended Warranties Available**



**Discount-Equipment.com is your online resource for  
commercial and industrial quality parts and equipment sales.**

**561-964-4949**

**visit us on line @ [www.discount-equipment.com](http://www.discount-equipment.com)**

Select an option below to find your Equipment

**Search by Manufacturer**

**Search by Product Type**

**Request a Quote**

We sell worldwide for the brands: Genie, Terex, JLG, MultiQuip, Mikasa, Essick, Whiteman, Mayco, Toro Stone, Diamond Products, Generac Magnum, Airman, Haulotte, Barreto, Power Blanket, Nifty Lift, Atlas Copco, Chicago Pneumatic, Allmand, Miller Curber, Skyjack, Lull, Skytrak, Tsurumi, Husquvarna Target, Stow, Wacker, Sakai, Mi-T-M, Sullair, Basic, Dynapac, MBW, Weber, Bartell, Bennar Newman, Haulotte, Ditch Runner, Menegotti, Morrison, Contec, Buddy, Crown, Edco, Wyco, Bomag, Laymor, EZ Trench, Bil-Jax, F.S. Curtis, Gehl Pavers, Heli, Honda, ICS/PowerGrit, IHI, Partner, Imer, Clipper, MMD, Koshin, Rice, CH&E, General Equipment, Amida, Coleman, NAC, Gradall, Square Shooter, Kent, Stanley, Tamco, Toku, Hatz, Kohler, Robin, Wisconsin, Northrock, Oztec, Toker TK, Rol-Air, APT, Wylie, Ingersoll Rand / Doosan, Innovatech, Con X, Ammann, Mecalac, Makinex, Smith Surface Prep, Small Line, Wanco, Yanmar

*NOTE: If the outer flange is difficult to remove, tighten screws into two of the holes on the outer flange to help separate the outer flange from the blade.*

5. Inspect the flange assembly and clean or replace dirty/damaged components.
6. Carefully fit the outer flange back into the inner flange and blade shaft.
7. Place the wedge lock washer onto the blade shaft bolt and insert the bolt into the blade shaft through the center of the outer flange.
8. Retighten the blade shaft bolt to secure the flanges.
9. Remove the detent pin (guards 26" and up) from the guard hinge and pivot the front of the guard down over the blade flanges to secure.

## Engine



### WARNING

Operate the saw in well-ventilated areas. Concentrated engine exhaust can cause loss of consciousness and/or death.

DO NOT touch the engine/muffler with the engine running, and always let them cool down prior to touching or servicing the saw.

DO NOT leave the saw unattended while the engine is running.



## Tasks Prior to Starting the Engine

Complete the tasks listed below prior to starting the engine to ensure a safe start:

- Check fluids and fill to appropriate levels.
- Turn off controls and switches.
- Remove tools from area.

The engine **will not** start unless the following tasks are completed:

- Place speed control lever to the **STOP/PARK** position.
- Pull up emergency stop button.
- All emergency stop triggers are cleared:
  - 1) E-Stop active
  - 2) Low coolant level

## Starting the Engine

**Note: In an emergency, press the emergency stop button to immediately stop the engine and any saw movement!**

1. Insert the key into the ignition and turn it to the **ON** position and wait for the display screen to energize.

*NOTE: While the display screen is energizing, the glow plug is preheating. If the glow plug requires more preheat time the following pop-up message will appear: "Wait to start, preheating".*

2. Once the display screen is energized and there are no pop-up messages, turn the key to the **START** position and release when the engine starts.

*NOTE: If the engine does not start within 10 seconds, turn the key to the OFF position and try again approximately 30 seconds later. Refer to the engine manual for troubleshooting recommendations after several failed attempts.*

3. Let the engine warm up. Check all warning lights and turn off the engine immediately if there are any problems prior to operating the saw.
4. Increase/decrease the engine/blade speed by pressing the throttle switch up or down as needed.

## Stopping the Engine



### CAUTION

DO NOT leave the saw unattended until the engine is off and the blade has stopped spinning.

1. Place the speed control lever to the **STOP** position and raise the blade from the cut.
2. Turn off all controls, switches, and water.
3. Decrease the engine speed to idle for five minutes to cool down the engine after full load operation.
4. Turn the ignition key to the **STOP** position and remove the key.

## Water Supply

The water supply directs cooling water to the fuel cooler and blade and minimizes dust when cutting.

### Using the Water Supply

1. Connect the water source hose to the water supply hose connection on the rear of the saw.

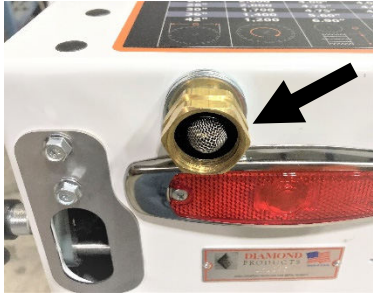

**Water Supply Hose Connection**

2. Connect water supply hose (64") extending from the rear of the upright assembly to the manifold on the blade guard.
3. Move the water valve lever on the control panel forward to start the flow of water to the blade. When finished cutting, shut off water supply to the blade guard by pulling the valve to the *OFF* position, shut off water supply at source and remove source hose from the saw.



**Water Control Valve**

4. During cold weather, drain water from the lines in accordance with the maintenance section of this manual.

## Water Pump (Optional)

The optional water pump directs water from the water source hose to the saw blade.

1. Ensure all water supply lines are connected.
2. Ensure that the water valve located on the control panel is in the *OFF* position.
3. Turn on the water pump switch to start the pump.

*NOTE: DO NOT start the water pump until just before cutting. DO NOT leave the water pump on when the cutting task is complete to avoid draining the battery.*

4. Push the water valve to the *ON* position.
5. When cutting is complete, move the water valve to the *OFF* position.
6. Turn the water pump switch to *OFF* to stop the pump.

## Automatic Water System (AWS) (Optional)

The automatic water system provides a solenoid in the water supply system that works in conjunction with the "Zero Blade" option on the control panel. When the saw blade is "zeroed" at the pavement surface, the solenoid valve will allow water to flow when the blade is lowered into a cut. When the blade is raised out of the cut and the blade passes the "zero" point, the water flow will automatically shut off.

*NOTE: When using AWS, adjust the water valve lever to meter the water flow. AWS will automatically turn the water on/off when the blade enters or exits the cut.*

## Water Pressure Switch (Optional)

The water pressure switch illuminates an icon on the display panel controller when the system detects insufficient water pressure.

## Cutting

### Cutting Guides

Use the cutting guides as needed to help follow the cutting line. Always check the cutting guides for proper alignment with the blade prior to cutting.

### Adjusting the Front Pointer

1. Remove the lanyard from the cable cleat.
2. Lower the front pointer frame to the ground.
3. Loosen both front pointer frame screws.
4. Divide an 8–10 ft. piece of string in half.
5. Place the looped end of string into a gullet on the backside of the blade.
6. Place one string line up against the backside of the blade and one string line up against the front side of the blade. Holding the string ends in one hand, tension the lines out toward the front pointer rod.

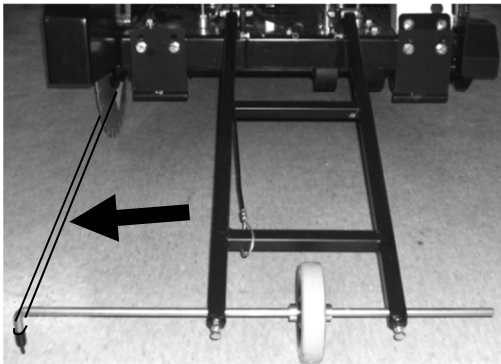

**Tensioned String Line**

7. Adjust the pointer rod to place the tip between the tensioned string lines.
8. Retighten both front pointer frame screws.
9. Lift the frame off the ground when finished.
10. Tension the lanyard and secure it to the cable cleat.

### Adjusting the Rear Pointer(s)

1. Loosen the rear pointer nut and screw on the back of the frame base.
2. Adjust the orientation/extension of the rear pointer rod and retighten the screw and nut to secure.

### Straight Line Cutting



#### **WARNING**

DO NOT expose yourself or anyone else to the direct line of the blade when operating the saw.

The direct work area should not contain buried or embedded electrical, gas, or water lines that could be damaged and/or cause personal injury while cutting.



*NOTE: Always raise the blade to provide proper clearance between the blade and the pavement when maneuvering the saw.*

### Helpful Hints Prior to Cutting

Keep the following in mind for better efficiency while cutting:

- Use just enough handle pressure to guide the saw down the cutting line. DO NOT forcibly direct (twist) the saw from side to side when cutting. DO NOT jam, cock, or wedge the blade in a cut.
- Moving too quickly when cutting may stall the saw, or may cause the blade to climb out from the cut. If the saw stalls while cutting, put the saw in neutral and raise the blade from the cut to restart the engine.
- Avoid sawing excessively deep to preserve the blade and reduce sawing costs.
- DO NOT lower the blade too quickly or move the saw forward too quickly when finishing a partial-cut to avoid forcing the blade into the concrete.
- Always have a proper water flow when cutting for maximum blade efficiency. Using too much water when cutting will make the slurry look clear. Not using enough water will make the slurry look thick and pasty.
- Refer to the Diamond Products' Guide for Professional Concrete Cutters for additional cutting tips and information.

### Tasks Prior to Cutting

Complete the following tasks prior to cutting:

- Ensure the blade size is correct for the belt drive configuration.
- Align the cutting guide(s) with the blade.
- Clearly mark the cutting line.
- Turn off all electricity, gas, and water around the direct work area.

### Making a Cut without Using the Blade Depth Stop

1. Align the blade and cutting guide(s) with the cut line.
2. Turn on the water and adjust the water flow by pushing the water valve handle forward.
3. Start the engine and allow to idle briefly before going to full power.



4. Lower the blade to just above the cutting surface and zero the blade by pressing the “Zero Blade” button on the display panel.
5. Slowly lower the blade into the surface to no more than 2” deep. Make the initial pass across the entire cutting line using the most effective travel speed. If the blade is coming up out of the cut, decrease travel speed and/or feed depth. **DO NOT CUT FULL DEPTH IN ONE PASS.**
6. If you are cutting more than 2” deep, you can finish the job in less time and effort by step cutting in 2” increments. Cut a 2” depth on the initial pass, 4” depth on the second and so on. On repeated passes, the blade will tend to follow the previous cut.
7. Raise the blade out of the cut and reposition the saw at the start of the cut line. DO NOT move backwards with the blade in a previous cut.
8. At the start of the cut line, lower the blade back into the cut and make a second, deeper pass across the entire cutting line.
9. Continue the step-cut process to reach the maximum depth. DO NOT cut any deeper than required.
6. If you are cutting more than 2” deep, you can finish the job in less time and effort by step cutting in 2” increments. Cut a 2” depth on the initial pass, 4” depth on the second and so on. On repeated passes, the blade will tend to follow the previous cut.
7. Raise the blade out of the cut and reposition the saw at the start of the cut. DO NOT move backwards with the blade in a previous cut.
8. Press the “Clear Depth Stop” button on the display panel to reset the depth stop to zero.
9. Slowly lower the blade into the cut until the desired depth is reached and then press the “Set Depth Stop” button on the control panel.
10. Continue the step-cut process using the depth stop to reach the maximum depth. DO NOT cut any deeper than required.

### Continuing a Partial-Cut

1. Maneuver the saw to the desired location.
2. Align the blade with the previous cut and slowly lower the blade back into the concrete. Use extreme caution to make sure the blade is perfectly aligned within the cut. DO NOT continue cutting until the blade is aligned within the cut!
3. Continue the step-cut process (using the blade depth stop if preferred) to reach the maximum depth. DO NOT cut any deeper than required.

### Finishing a Cut

1. Place the speed control lever at *Stop*.
2. Raise the blade from the cut (provide proper ground clearance).
3. Turn off the water control valve.
4. Always operate the engine briefly at idle speed before stopping it.

### Making a Cut Using the Blade Depth Stop

1. Align the blade and cutting guide(s) with the cut line.
2. Turn on the water and adjust the water flow by pushing the water valve handle forward.
3. Start the engine and allow to idle briefly before going to full power.
4. Lower the blade to just above the cutting surface and zero the blade by pressing the “Zero Blade” button on the display panel.
5. Slowly lower the blade into the surface to no more than 2” deep and press the “Set Depth Stop” button on the display panel. Make the initial pass across the entire cutting line using the most effective travel speed. If the blade is coming up out of the cut, decrease travel speed and/or feed depth. **DO NOT CUT FULL DEPTH IN ONE PASS.**

## Drive Alignment

### Adjusting the Drive Alignment

Adjust the rear axle when the saw's drive alignment is off (saw will not cut in a straight line).

1. Turn the tap bolt clockwise using the provided wrench to adjust the drive alignment toward the right, or counterclockwise to adjust the drive alignment toward the left.



Adjustment Bolt

### Tie-Downs

Use the tie-downs (one at the back and one at the front end of the saw) when securing the saw in a truck/trailer for transportation. DO NOT over-tighten a chain/rope to the front end tie-down, which may bend the frame and damage the saw.

### Footrest (Optional)

Use the footrest, if desired, to add body weight to the rear of the saw and improve the rear wheel traction when cutting.

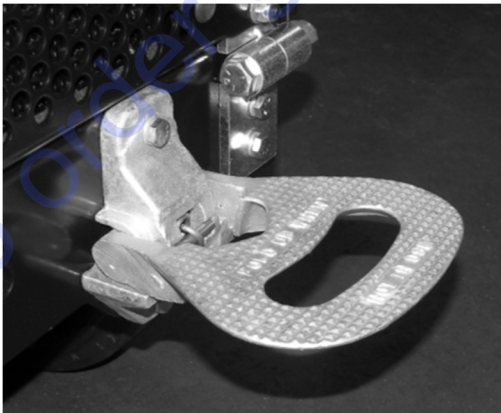

Footrest

### Weight Bar (Optional)

The weight bar (optional) adds 56 lb. to the rear of the saw to improve the rear wheel traction when cutting.

1. Attach the second footrest to the back of the frame base using the screws, washers, and lock nuts provided.
2. Rest the weight bar on top of both footrests.
3. Place a flat washer onto both cap screws. Fit the cap screws through the holes on top of the weight bar and through the slot on both footrests.
4. Place a fender washer onto each cap screw underneath the footrest and secure with a lock nut.
5. Remove the weight bar as necessary

### Spotlight (Optional)

1. Loosen both spotlight bar lock knobs and slide the spotlight bar from side-to-side to adjust the length of the bar.
2. Tighten the lock knobs to secure.
3. Turn the spotlight switch on or off as needed for additional lighting.



Spotlight

***LED Light Bar (Optional)***

1. Loosen both light bar bolts and adjust the light angle from 0° to 30° in the downward direction.
2. Tighten the bolts to secure.
3. Turn the light bar switch on or off as needed for additional area lighting.

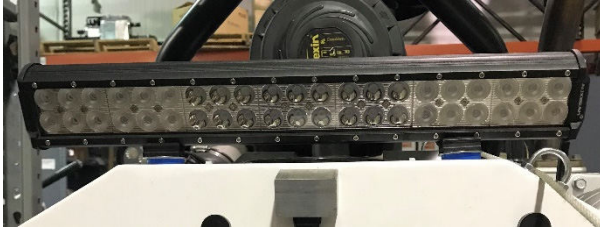

Light Bar

***Heavy Duty Blade Shaft Bearing Upgrade (Optional)***

Heavy duty, greaseable, double spherical roller bearings are an available option for the blade shaft bearings. For additional information contact Discount-equipment.

***Oil Bath Blade Shaft Upgrade (Optional)***

An oil bath blade shaft is an available option that provides maintenance free bearing lubrication. For additional information contact Discount-equipment.

***Maximum Capacity Battery Upgrade (Optional)***

A heavy-duty size 31 battery is an available option that provides greater cranking amps for increased reliability. For additional information contact Discount-equipment.

***Air Pre-Cleaner Upgrade (Optional)***

A high efficiency spinner style air pre-cleaner is an available option. For additional information contact Discount-equipment.

***Onboard Blade Storage (Optional)***

An optional arbor shaft that attaches to the side of the upright assembly is an available option to allow for storage and transportation of a blade up to 36". For additional information contact Discount-equipment.

***Pointer Rope Recoil (Optional)***

A front pointer rope recoil system is an available option that allows for the automatic retraction of the front pointer rope. For additional information contact Discount-equipment.

## **Maintenance**

### **General**

Failure to read and comply with the maintenance instructions provided in this manual prior to performing maintenance may result in serious injuries and/or death, and may harm the saw. DO NOT attempt to perform maintenance on the saw if you are not properly trained for it, or are not supervised by an experienced person.

Refer to the CC5049 Parts List for additional information and part diagrams when performing maintenance tasks. Refer to the engine manual and manufacturer as the primary source for all safety, operations, and maintenance instructions for the engine. Contact Discount-equipment.

Remove all necessary guards and access panels prior to servicing the saw. Replace prior to operating.

### **Maintenance Tools**

Tools critical for the maintenance of the machine are provided with the machine and located on the inside of the upright. A wrench holder is provided on the left hand side of the upright and contains a 15/16" wrench.

### **Pre Maintenance Preparations**

- Ensure the saw is in a safe area to conduct maintenance.
- Maintain proper cleanliness of the work area to minimize personal injury or equipment damage.
- Ensure the saw is sufficiently cool to conduct any maintenance.
- Remove the cutting blade prior to starting any maintenance.
- Place the saw on a level surface with the engine turned off and the emergency stop activated.
- Ensure there is adequate lighting in the work area to ensure safety.
- Ensure all equipment and tools required for the maintenance task are staged and available for use.

- Prior to any maintenance being performed, know the locations of all safety equipment such as fire extinguishers, first aid kits, etc.
- All maintenance shall be performed by qualified personnel only.

### **Rear Cover Screen**

The rear cover screen is a versatile component in regards to maintenance of the machine. It can be opened to gain access to components within the upright assembly. Or if additional access is required, it can be quickly removed.

### **Removal of Rear Cover Screen**

1. Rotate the door latches on the cover screen clockwise and pull back on the screen.
2. When the screen is clear of obstructions, lift it up and away from the saw.

### **Installing the Rear Cover Screen**

1. Lower the cover screen down in front of the pivot spacer tabs located on the frame base.
2. Push up on the screen and rotate the door latches counterclockwise to secure.

### **General Cleaning**

The saw must be cleaned after each use and prior to conducting any maintenance. Ensure that the saw is cool prior to cleaning. Ensure affected electrical equipment is properly covered or de-energized prior to cleaning with water or air.

### **Cleaning Techniques**

Various cleaning options can be utilized depending on the type of cleaning required. High pressure washers and a mild detergent will work the best. Compressed air and low pressure water can also be utilized where required.



### **CAUTION**

Care must be taken when using high pressure water and compressed air to conduct any maintenance or cleaning. High pressure water and compressed air can cause injury to personnel or damage to equipment if not used properly.

## Radiator

Ensure that the radiator is cool prior to cleaning. Use compressed air or a power washer, set at 25° or larger, to clean the radiator fins being careful not to damage the fins. A mild detergent with low pressure water can also be used to clean or degrease the radiator.

*NOTE: Plugged or damaged radiator fins can and will diminish the cooling capacity of the radiator.*

## Control Panel

Do not spray water on the control panel to clean. Use a damp cloth or compressed air to clean electrical components. Dry the control panel after cleaning.

## Display Screen

Do not spray water on the display screen to clean. Use a damp cloth to wipe it clean and dry the screen with a lint free cloth.

## Engine

Use a mild detergent and water to clean the engine. Do not spray water forcefully on the engine to prevent damage to components.

*NOTE: Do not spray water into the exhaust pipe or air filter.*

## Part Lubrication

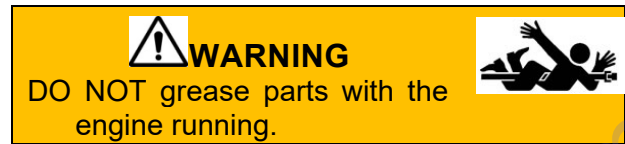

Lubricate all necessary parts on schedule for maximum saw efficiency. Occasionally lubricate controls, cables, hinges, latches, and linkages with a spray lubricant when movement becomes stiff and/or sluggish. Use one to two full pumps of NLGI No. 2 premium, lithium-based grease when lubricating all grease fittings.

*NOTE: Use more grease on bearing grease fittings if they are too hot to touch after completing work.*

## Post Cleaning

- Lubricate the machine as required.
- Dry all electrical components using compressed air.
- Do not start the machine until it has had time to thoroughly dry.



## MAINTENANCE

### Service Schedule

The service schedule is based primarily on the standard operating time of the machine. The frequency of the maintenance tasks can be increased based on the working environments of the machine.

Task	Cycle						
	Daily	25 Hrs.	50 Hrs.	250 Hrs.	500 Hrs.	1000 Hrs.	1500 Hrs.
Visually inspect saw for damage and repair as necessary	X						
Wipe down and clean all components for dust, debris, and slurry	X						
Check that all safety guards are in place and in good operating condition	X						
Check for loose or frayed wiring. Repair/replace as necessary	X						
Check for loose nuts and bolts and retighten	X						
Inspect all hoses and clamps for damage, leaks, or looseness and repair/replace as necessary	X						
Check engine oil level	X						
Check fuel level	X						
Check hydraulic fluid level	X						
Check radiator coolant level	X						
Check and clean blade guard water spray tubes	X						
Lubricate blade shaft bearings (End of work day)	X						
Check air cleaner restriction indicator	X						
Inspect all belts for tension or wear and re-tension or replace as necessary		X					
Lubricate PTO bearings		X					
Drain fuel/water separator filter			X <sup>1</sup>				
Drain water from fuel filter			X <sup>1</sup>				
Lubricate hydraulic cylinder pivot pin			X				
Lubricate front axle bearings			X				
Lubricate bogie wheel			X				
Clean air cleaner element				X <sup>2</sup>			
Replace engine oil and filter				X <sup>3</sup>			
Replace hydraulic oil and filter					X <sup>3</sup>		
Replace fuel/water separator filter					X <sup>4</sup>		
Replace fuel filter					X		
Replace primary and safety air filters					X		
Replace radiator coolant						X	
Replace engine crankcase breather element							X

1 - Service as required

2 - Clean more often if operating in dusty conditions

3 - Initially change at 50 operating hours

4 - Or 1 year whichever occurs first



**Daily Service**

**Check Engine Oil Level**

Prior to checking the engine oil level, ensure that there is no blade installed on the saw and that the saw frame is in a level position.

1. Remove the engine oil dipstick from the oil filter side of the engine. (Between the engine and saw upright assembly)

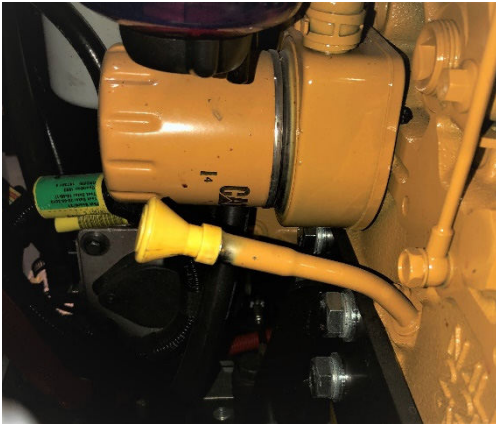

**Engine Oil Dipstick**

2. Check the oil level on the dipstick. The level should be between the two notches.



**Engine Oil Level Indicators**

3. If the level is low, remove the engine oil fill cap located on the right, rear side of the engine above the dipstick.

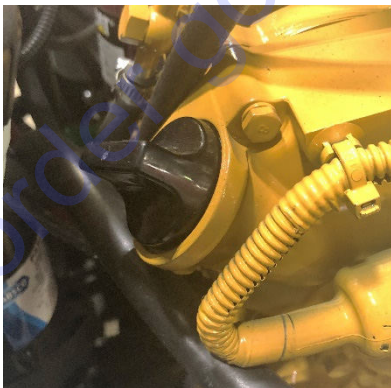

**Engine Oil Fill Cap**

4. Add oil until the level is correct on the dipstick.
5. Replace the engine oil fill cap.

**Check Fuel Level**

Prior to checking the fuel level, ensure that there is no blade installed on the saw and that the saw frame is in a level position.

1. With the ignition switch in the ON position, the Home screen will appear. The fuel level gauge will be displayed on the right side of the display.
2. If fuel level is low, remove the fuel tank fill cap located on the left side of the upright assembly.



**Fuel Tank Fill Cap**

3. Fill the fuel tank with ultra-low sulfur diesel fuel only.
4. Replace the fuel tank fill cap.

**Hydraulic System**

**! WARNING**

Always place a piece of cardboard or paper up against hydraulic components, or use a leak detection fluid to check for hydraulic fluid leaks. Keep all body parts away from leaks and/or areas that may eject hydraulic fluid. Pressurized hydraulic fluid can penetrate the skin, causing serious injuries. Seek medical attention immediately!



Always make sure any hydraulic components being serviced are not supporting the weight of other saw components. If a component is under pressure when connections points are loosened, oil may spray out forcefully.

Inspect all hydraulic hoses and fittings daily for leaks. Remember to use cardboard or a piece of paper when checking for leaks and replace damaged components immediately.

### Check Hydraulic Fluid Level for Hydro Pump Assembly

Prior to checking the hydraulic fluid level, ensure that there is no blade installed on the saw and the saw frame is in a level position.

1. Check the hydro pump reservoir tank level.

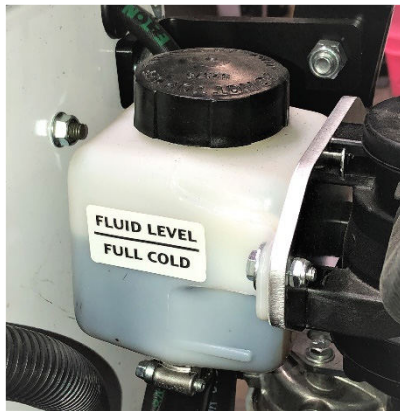

**Hydro Pump Reservoir Tank**

2. If the level is below the "Full Cold" line then, remove the reservoir tank cap.
3. Add SAE 15W-40 oil to the reservoir tank fill line. DO NOT overfill as fluid will leak out from the reservoir cap.
4. Replace the cap and tighten to secure.

### Adding Fluid to the Hydraulic Lift Pump



**Hydraulic Lift Pump Breather Cap**

Check the fluid daily and add fluid to the pump as necessary.

1. Lower the saw to level the frame.
2. Unlatch and lower the rear cover screen.

3. Remove the hydraulic pump breather cap.
4. Using a funnel with flexible hose, add SAE15W-40 oil or an equivalent to just below where the fill port extends into the hydraulic pump. Do not overfill, as this will cause oil leakage through the breather cap when raising the saw.
5. Replace the breather cap and retighten to secure.
6. Close the rear cover screen and latch to secure.
7. Replace the hydraulic pump fill access plug.

### Check Radiator Coolant Level

Prior to checking the radiator coolant level, ensure that there is no blade installed on the saw and the saw frame is in a level position.

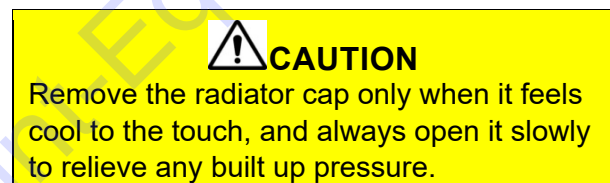

1. Slowly remove the radiator cap located through the radiator cap access on the top front of the radiator shroud.



**Radiator Cap Access**

2. Check that the coolant level is up to the overflow hole inside the filler neck.
3. If it is below the filler neck, add a 50/50 mix of water and antifreeze until it reaches that point.
4. Replace the radiator cap and retighten to secure.

***Check and Clean Blade Guard Spray Tubes***

1. Raise the front of the blade guard and pin it in place using the hinge detent pin if applicable.
2. Connect a water supply source to the water manifold on the blade guard.
3. Turn the water supply on and verify that water is spraying from all spray tube holes.
4. If any clogged holes are detected, shut off water source and dislodge any debris that is clogging the hole(s).
5. Turn water on to verify all spray tubes are clear.
6. Shut off water supply and disconnect from the water manifold.
7. Pull the detent pin on the blade guard hinge and lower the front of the guard back down.
8. Replace detent pin.

***Lubricate the Blade Shaft Bearings***

At the end of each work day, lubricate the two front blade shaft bearings. The bearings are located under the radiator at the front of the saw.

1. Add no more than two pumps of bearing grease into each of the two blade shaft bearing grease fittings.

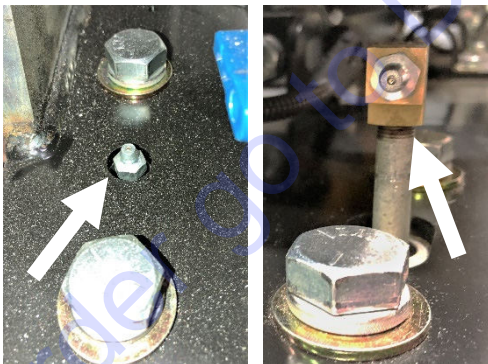

**Grease Fittings – Blade Shaft Bearings**

***Check Air Cleaner Restriction Indicator***

1. Check the restriction indicator located on the outlet of the air cleaner.
2. If the indicator is red, clean the air cleaner primary filter in accordance with the “Cleaning the Outer Primary Filter” procedure.



**Restriction Indicator**

3. Ensure the rubber dust ejector boot valve is clean by pressing inward on both sides of the ejector boot near the valve opening to release dust and debris, and clean the valve opening as necessary.

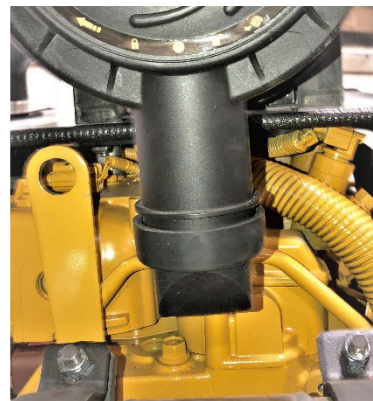

**Rubber Dust Ejector Boot**

**25 Hour Service**

***Inspect Belts***

Inspect all belts daily for tension or wear. Re-tension or replace as required in accordance with the “Blade Drive Belts” section located in the “Regular Maintenance” section of this manual.



**Lubricate the PTO Bearings**

1. Swing the cover plate on the belt guard away enough to expose the front face of the PTO.
2. Add three pumps of grease to the PTO using the grease fitting located on the PTO face.

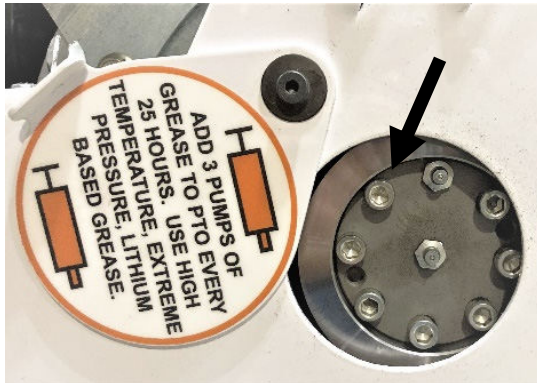

**PTO Grease Fitting**

**50 Hour Service**

**Drain the Fuel/Water Separator Filter**

Inspect the fuel/water separator filter and drain as necessary. The unit is located inside the upright at the rear of the saw.

1. Locate the drainage cap on the underside of the fuel/water separator.
2. Place a suitable container under the filter.
3. Loosen the cap only enough to allow water to be discharged from drainage tube. *Do not remove the cap.*
4. When no more water is discharged, re-tighten the drainage cap.



**Drainage Cap**

**Fuel/Water Separator Filter**

**Drain Water from the Fuel Filter**

Inspect the fuel filter and drain as necessary. The unit is located between the upright and the engine.

1. Locate the drainage cap on the underside of the fuel filter.
2. Place a suitable container under the filter.
3. Loosen the cap only enough to allow water to be discharged from drainage tube. *Do not remove the cap.*
4. When no more water is discharged, re-tighten the drainage cap.

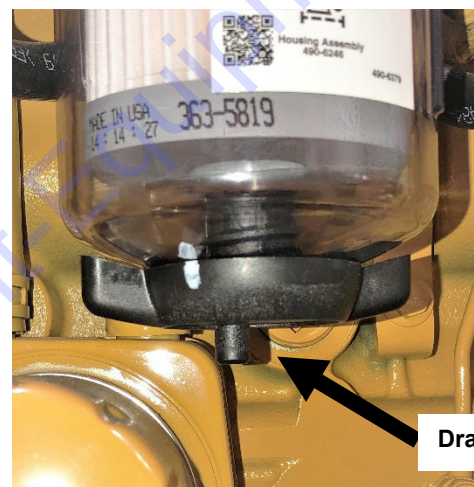

**Fuel Filter**

**Drainage Cap**

**Lubricate the Hydraulic Cylinder Pivot Pin**

1. Ensure the saw is parallel to the ground.
2. Add one pump of grease into the hydraulic cylinder pivot pin grease fitting located at the back of the front axle assembly.

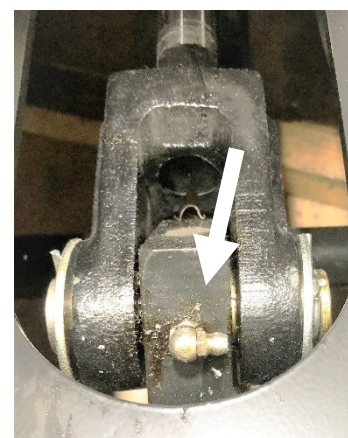

**Pivot Pin Grease Fitting**

***Lubricate Front Axle Bearings***

1. Raise the saw to the full up position.
2. Add no more than two pumps of grease to each of the two front axle bearings grease fittings located under the frame base on both the left and right side.

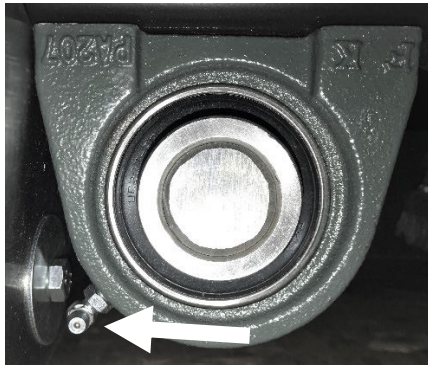

**Front Axle Bearing Grease Fitting**

***Lubricate the Optional Bogie Wheel***

The bogie wheel has two locations for adding grease. The first is on the wheel axle located on the side of the wheel. The second location is on the caster bracket on the back of the wheel.

1. Add one pump of grease to both grease fittings located on the bogie wheel.

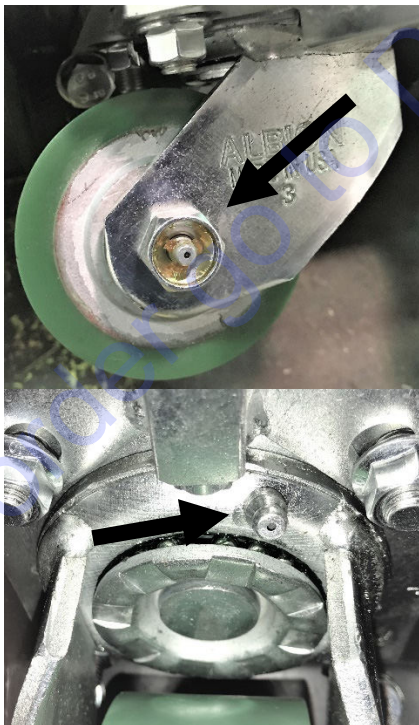

**Bogie Wheel Grease Fittings**

**250 Hour Service**

***Clean the Air Cleaner Element***

**⚠ WARNING**  
DO NOT operate the saw without the filter installed

1. Empty the rubber dust ejector boot by pressing inward on both sides of the ejector boot. This will release any large particles of dust or dirt.
2. Pull out the tab on the air cleaner housing end cover.



**End Cover Tab**

3. Turn the end cover counter-clockwise to unlock and pull the cover away from the main air cleaner housing.
4. Pull the outer primary filter out of the air cleaner and inspect it for damages. Replace as necessary. To protect the engine, DO NOT pull out the inner safety filter.



**Outer Primary Filter**



5. Move away from the saw and clean the filter from the inside out. Use dry compressed air to clean the filter (a maximum of 30 psi or 2.1 bar) and rotate it while cleaning.
6. Inspect the inside of the air cleaner housing and the end cover for debris, and wipe them down with a damp cloth as necessary. **DO NOT** use compressed air to blow out the inside of the air cleaner housing. **DO NOT** allow dust to enter the air intake tube when cleaning or replacing parts.
7. Place the filter into the air cleaner housing (over the inner safety filter) and gently push the filter into the unit until it feels secure.
8. Place the end cover tightly up against the ridge at the end of the air cleaner housing.
9. Turn the end cover clockwise to lock the cover onto the air cleaner housing, making sure the dust ejector boot is in the vertical position.
10. Push the tab in on the air cleaner housing end cover to secure.
11. Press the restriction indicator reset button on the restriction indicator after the unit has been cleaned.

**Replace Engine Oil and Filter**

- Refer to Engine Operator's Manual for oil and oil filter specifications and capacities.
1. Run the engine until it reaches normal operating temperature and then shut the engine OFF.

 **WARNING**  
DO NOT drain the oil with the engine running.

2. Raise the saw frame and place drain pan beneath drain hose located on the right side of the saw just in front of the upright assembly.



**Oil Drain Hose**

3. Remove the engine oil fill cap.

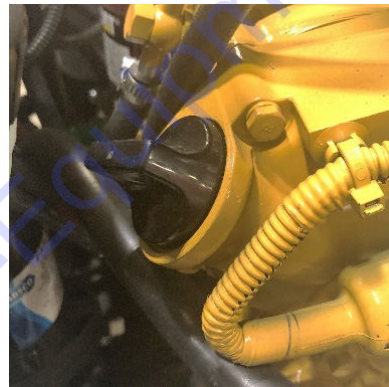

**Engine Oil Fill Cap**

4. Remove red plastic drain plug and open drain valve on side of oil pan.

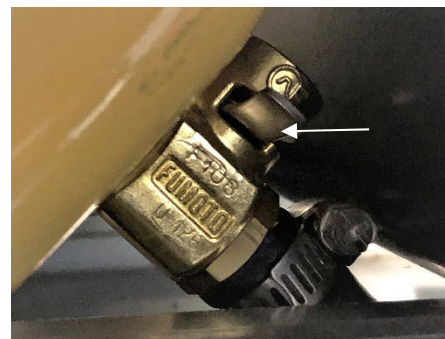

**Oil Drain Valve.**

5. Drain oil completely
6. Remove the oil filter located between the engine and the upright assembly using a filter wrench.
7. Dispose of the oil and filter in accordance with city, state and federal regulations.
8. Shut oil drain valve and replace red plastic drain plug.
9. Install a new filter on the engine. Lubricate the rubber gasket on the filter with a film of oil prior to installing it.
10. Tighten the filter only hand tight.



11. Place a funnel with a flexible hose end into the oil fill tube on the engine.
12. Add oil in accordance with the manufacturer's specifications and capacities.
13. Replace the engine oil fill cap.

**500 Hour Service**

**Replace Hydraulic Oil and Filter**

1. Level the saw and place a drain pan under the hydraulic filter located on the left side of the engine.
2. Loosen the hose clamp on the inlet hose to the filter head.



**Hydraulic Oil Filter**

3. Remove the hose and allow the hydraulic fluid to drain into the drain pan.
4. Remove the filter using a filter wrench.
5. Dispose of the oil and filter in accordance with city, state and federal regulations.
6. Completely fill the new filter with SAE 15W-40 oil and add a thin film of oil to the gasket on the filter.
7. Screw the new filter into the filter head until the gasket is seated. Then turn the filter 1/2 turn by hand to secure.
8. Reinstall the inlet hose to the filter head and tighten the hose clamp securely.
9. Remove the reservoir tank cap.
10. Add SAE 15W-40 oil to the reservoir tank up to the "Full Cold" line. DO NOT overfill as fluid will leak out from the reservoir cap.

11. Replace the cap and tighten to secure.



**Hydro Pump Reservoir Tank**

12. Check the system for leaks and ensure proper pressure by turning the ignition switch to START and release when the engine starts.

*NOTE: If the engine does not start within 10 seconds, turn off the key and try again approximately 30 seconds later. Refer to the engine manual for troubleshooting recommendations after several failed attempts*

**Replace the Fuel/Water Separator Filter**

Replace the fuel/water separator filter periodically to prevent wear on the fuel pump due to dirt in the fuel.

1. Ensure the engine is turned OFF and the saw frame is level.
2. Place a container under the fuel/water separator filter.

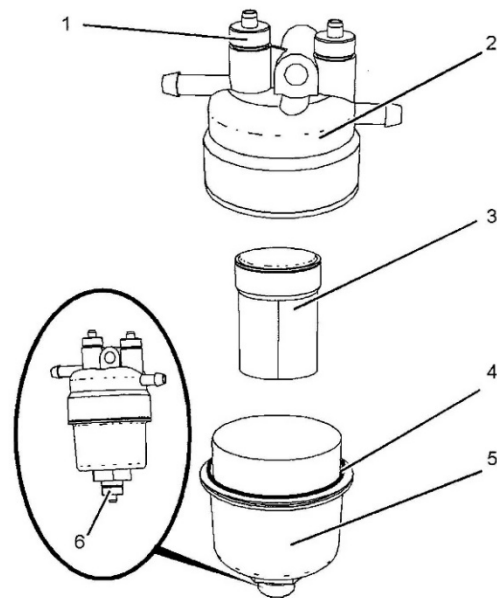

**Fuel/Water Separator Filter**

3. Open the drain valve (6) and open vent screw (1) and drain the filter. Close drain valve and vent screw when completed.

*NOTE: Use only hand pressure to tighten the drain and vent screws.*

4. Remove the filter bowl (5) from the filter base (2) and remove the filter element (3) and discard the filter element.
5. Remove the O-ring seal (4) and discard.
6. Ensure all components are clean and dry.
7. Install a new O-ring seal (4) and filter element (3).
8. Reinstall the filter bowl (5) to the filter base (2) and tighten to 88 Lbs.-in (10 Nm).

**Replace the Fuel Filter**

1. Ensure the engine is turned OFF and the saw frame is level.
2. Place a container under the fuel filter.

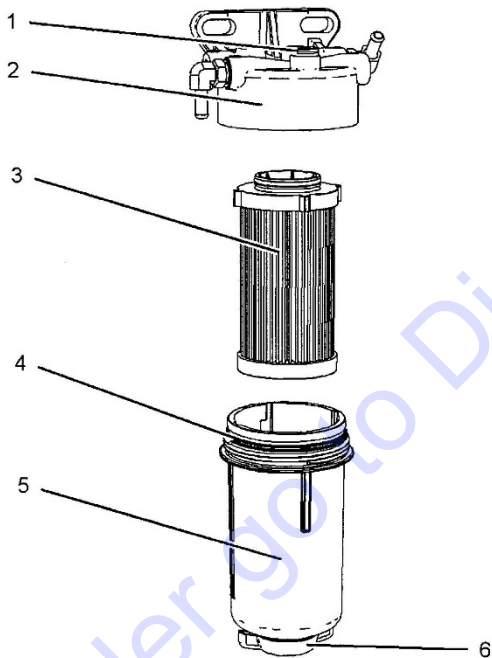

**Fuel Filter**

3. Open the drain valve (6) and if necessary, open the vent screw (1). Allow fuel to drain from the filter. Tighten the vent screw and close the drain valve.
4. Remove the filter bowl (5) from the filter base (2) using a suitable strap wrench.
5. Remove the filter element (3) and discard.
6. Remove the O-Ring seal (4) from the filter bowl and discard.
7. Ensure the filter bowl is clean and free from dirt.

8. Install a new O-ring seal (4) and filter element (3).
9. Reinstall the filter bowl (5) to the filter base (2) and hand tighten only.

**Replacing the Outer Primary and Inner Safety Filters**

1. Pull out the tab on the air cleaner housing end cover.



**End Cover Tab**

2. Turn the end cover counter-clockwise to unlock and pull the cover away from the main air cleaner housing.
3. Remove the outer primary and inner safety filters from the air cleaner housing.



**Outer Primary Filter**



**Inner Safety Filter**

4. Inspect the inside of the air cleaner housing and the end cover for debris, and wipe them down with a damp cloth as necessary. **DO NOT** use compressed air to blow out the inside of the air cleaner housing. **DO NOT** allow dust to enter the air intake tube when cleaning or replacing parts.
5. Place the new inner safety filter into the air cleaner housing until it is fully seated.
6. Place the new outer safety filter into the air filter housing over the inner safety filter and gently push the filter into the unit until it feels secure.
7. Place the end cover tightly up against the ridge at the end of the air cleaner housing.
8. Turn the end cover clockwise to lock the cover onto the air cleaner housing, making sure the dust ejector boot is in the vertical position.
9. Push the tab in on the air cleaner housing end cover to secure.
10. Press the restriction indicator reset button on the restriction indicator after the unit has been cleaned.

### **1000 Service Hours**

#### **Replace Radiator Coolant**

Ensure the engine is turned OFF and cooled down prior to replacing the radiator coolant.

1. Unbolt the three cap screws attaching the front radiator shroud to the radiator and remove the shroud.

2. Disconnect wire harness from the spotlight if installed.
3. Place a drain pan under the radiator drain valve.
4. Slowly remove the radiator cap.



Remove the radiator cap only when it feels cool to the touch, and always open it slowly to relieve any built up pressure.

5. Open the drain valve handle and drain the fluid completely. Dispose of the used fluid according to city, state, and federal regulations.
6. Close the drain valve handle.

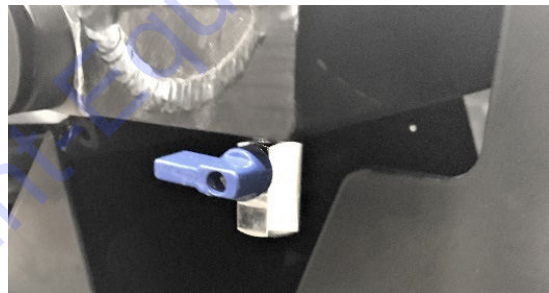

**Radiator Drain Valve**

7. Add a 50/50 mix of water and anti-freeze through the fill port until the fluid reaches the overflow hole inside the filler neck.
8. Replace the radiator cap and retighten to secure.
9. Reinstall the radiator shroud.
10. Remove the coolant recovery tank cap.



**Coolant Recovery Tank**



11. Add a 50/50 mix of water and anti-freeze to the “Cold Full” line.
12. Replace the coolant recovery tank cap.

### **1500 Service Hours**

#### **Replace Engine Crankcase Breather Element**

Refer to the engine manufacturer’s Operation and Maintenance manual for proper replacement parts.

1. Place a container under the breather assembly located behind the DOC next to the hydraulic overflow tank.



**Engine Crankcase Breather Assembly**

2. Remove the clip and hose from the lower cap.



**Clip and Hose Connected to Lower Cap**

3. Unscrew the cap from the main body and lower it down and out from the engine.
4. Remove the filter element and O-ring seal and discard.
5. Install a new O-ring seal onto the lower cap.
6. Install a new filter element into the cap.
7. Reinstall the cap assembly back onto the breather assembly.
8. Reattach the hose and clip onto the lower breather cap.
9. Remove the container and clean away any fluid around the breather assembly.

### **Regular Maintenance**

#### **Blade Drive Belts**



**WARNING**



Turn off the engine prior to servicing the belts. Use extreme caution when working with belts and rotating machine parts to avoid entanglement.



**CAUTION**

Let the belts cool down prior to servicing them.

Inspect all belts daily for fraying, stress cracks, and/or breakage and replace immediately when damaged. Always re-tension new belts after the first two to four hours of use. **DO NOT** exceed the manufacturer’s recommended belt tension settings when tensioning belts.

*NOTE: Over-tensioning belts may reduce the life of the bearings. Under-tensioning belts may cause slippage, shorter belt life, and/or poor saw performance. Squealing belts indicate looseness.*

#### **Tensioning the Blade Drive Belts**

1. Unlatch and lower the rear cover screen and retrieve the 15/16” wrench from inside the upright assembly on the left side.
2. Using the wrench, loosen the two engine clamp bolts located on the right side of the saw.



**Engine Clamp Bolts**

3. On the front of the saw, locate the belt tension assembly located beneath the radiator.



**Belt Tension Assembly**

4. Using the wrench, turn the tensioning nut clockwise to tighten the drive belts. DO NOT exceed the manufacturer's tension settings.
5. Retighten the two engine clamp bolts.

**Engine**

 **WARNING**

Let the engine cool down prior to servicing the saw. DO NOT service the saw with the engine running (unless stated otherwise).



Refer to the engine manual and manufacturer for a full engine maintenance schedule and additional engine maintenance information.

***Engine Control Module (ECM)***

The engine is equipped with an engine control module (ECM). The ECM monitors various engine parameters to ensure optimal engine performance and efficiency.

 **Warning**

Never weld on the machine with the ECM connected to the wire harness.

**Battery**

 **WARNING**

Ignitable explosive gases are emitted from the battery. DO NOT expose the battery to sparks or open flames, and keep the area around the battery well-ventilated.



Disconnect the battery prior to servicing the saw (unless stated otherwise).

Always keep the battery cable clamps away from the battery terminals when the battery is disconnected to avoid accidental connections while servicing.



Always be sure to connect the battery cables to the proper terminal when reconnecting.

 **CAUTION**

Use a proper battery tester when testing the battery strength.

Use protective eyewear or a face shield and avoid contact with the skin when handling/servicing the battery.

The saw contains a charged battery with one positive cable lead and one negative cable lead.



**Battery**



## Battery Type

12 Volt, Group Size 24

### Servicing the Battery

1. Disconnect the negative cable lead from the negative terminal.

*NOTE: Always disconnect the negative cable first.*

2. Disconnect the positive cable lead from the positive terminal.
3. Unsecure the battery from the hold-down bracket by removing the two ratchet knobs from the battery hold-down tie rods and lift the hold-down bracket lid off.
4. Carefully remove the battery from the battery box.
5. When replacing the battery, carefully place a new battery into the battery box. Bring the old battery to a recycling facility; many battery retailers also accept old batteries.
6. When cleaning the battery, inspect the terminals, clamps, and cables for damages and corrosion. Clean the terminals and clamps using a wire brush, or use another approved technique for cleaning. Use acid-free, acid-resistant grease to grease the battery clamps and terminals. Carefully place the battery back into the battery box.
7. Re-secure the battery to the hold-down bracket by removing the hold-down battery lid over the two tie rod bolts and tighten it using the two ratchet knobs.
8. Reconnect the positive cable lead to the positive battery terminal.

*NOTE: Always reconnect the positive cable first.*

9. Reconnect the negative cable lead to the negative battery terminal.

### Electrical System



#### WARNING

Disconnect the battery when servicing the electrical system unless stated otherwise. Always use the correct size fuses (amps) to prevent fires.



### Fuses

The fuses are located in the power block assembly which can be accessed by removing the right hand panel on the display dash assembly.

**Inspect all fuses if switches or controls are not working properly and replace as necessary. If fuses are failing frequently, determine the cause and repair immediately.**

### Replacing Fuses

The fuses used on this machine are smart glow fuses. They have an LED indicator light that will illuminate if the fuse is blown.

1. Ensure the ignition switch is in the *STOP* position.
2. Remove the dash plate from the switch box assembly (top right hand side of control panel).
3. Remove cover from fuse box.

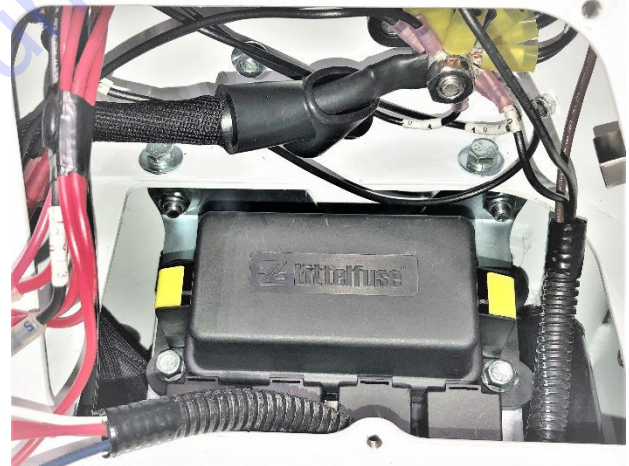

**Fuse Block**

4. Turn the ignition switch to the *ON* position.
5. Remove and replace any illuminated blown fuses.



#### WARNING

Never replace a fuse with a larger amperage fuse. This could lead to equipment damage or personal injury.

**Speed Control Lever**

**Adjusting Speed Control Cable**

The forward and reverse functions of the speed control system are set at the factory. If additional adjustment is needed, there are two locations to accomplish this action. The first is located between the upright assembly and engine on the left side of the saw. The cable connects to the hydro pump assembly control arm. The cable has two jam nuts located on the rear engine support to adjust the cable length as necessary. The second location is inside the upright where the control cable connects to the speed control lever. There are two jam nuts at this end of the cable for adjustment as well.

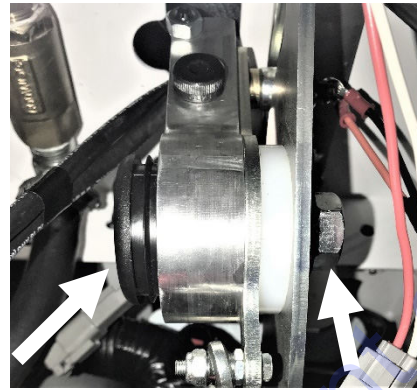

**Grease Cap and Jam Nut**

4. Use a 3/8" hex wrench to adjust the shoulder screw.
5. Retighten the jam nut.
6. Move the speed control lever forward and backward to test the lever tension. Readjust the shoulder screw/jam nut if desired.
7. Secure the grease cap to the pivot housing.
8. Close the rear cover screen and latch.

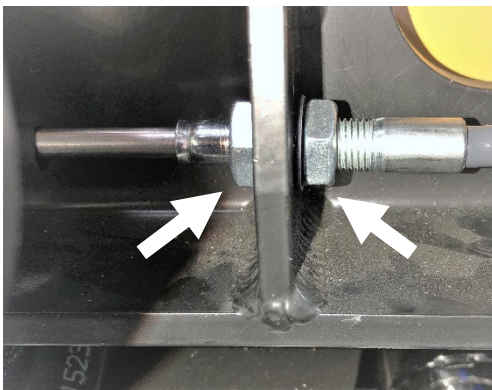

**Front Speed Cable Adjustment Nuts**

**Adjusting the Spring Plungers**

Adjust the spring plungers if the speed control lever feels floppy or loose when moving the lever forward and backward, or when the lever is hard to place into or out of the *STOP/PARK* position.

1. Loosen both hex nuts from the speed control tube.

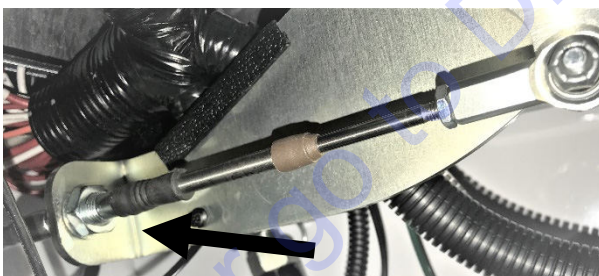

**Rear Speed Cable Adjustment**

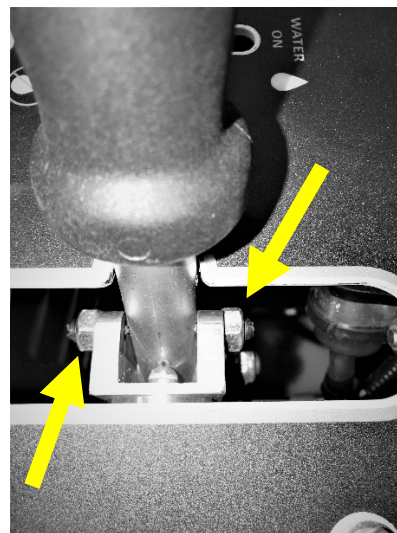

**Spring Plunger Hex Nuts**

**Adjusting the Lever Tension**

Adjust the tension felt in the speed control lever, when moving the lever forward and backward, to the desired setting as necessary.

1. Open the rear cover screen.
2. Remove the grease cap from the pivot housing.
3. Loosen the jam nut on the opposite side of the speed control frame using the provided wrench.

2. Screw the spring plungers slightly out to let the speed control lever move easily into and out of the *STOP/PARK* position. Screw the spring plungers in slightly, to let the speed control lever move firmly into and out of the *STOP/PARK* position.
3. Retighten both hex nuts to secure.

**Inner Blade Flange**

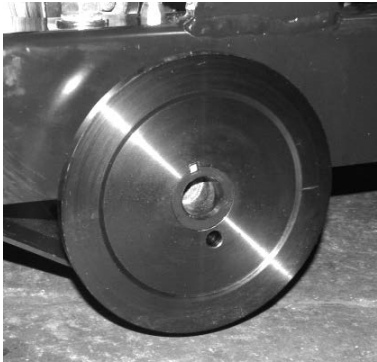

**Inner Flange**

**Installing the Inner Blade Flange**

1. Inspect the inner flange for damages. Clean or replace damaged components as necessary.
2. Align the flange with the blade shaft key and place the flange onto the blade shaft.
3. Apply Loctite 262 (red) or an equivalent to the setscrew threads.
4. Tighten the setscrew(s) into the back of the inner flange to secure.

**Removing the Inner Blade Flange**

1. Remove the setscrew(s) from the back of the inner flange using an Allen wrench.
2. Carefully remove the flange from the blade shaft.

**Maximum Cutting Depth Stop Bolts**

Always adjust the maximum cutting depth stop bolts when changing to a larger flange size to avoid damaging the blade flanges.

1. Raise the saw to gain access to the maximum cutting depth stop bolts underneath the frame base.

**WARNING**

Raise the saw to a proper height for access when working underneath the saw. Use chocks to block the wheels, and fit blocks or jacks under the frame edges at the front and back of the frame.

2. Loosen the jam nut on both bolts.
3. Turn the bolts counterclockwise to decrease the maximum cutting depth, or turn the bolts clockwise to increase the maximum cutting depth.

*NOTE: Both bolts must be the same length when finished.*

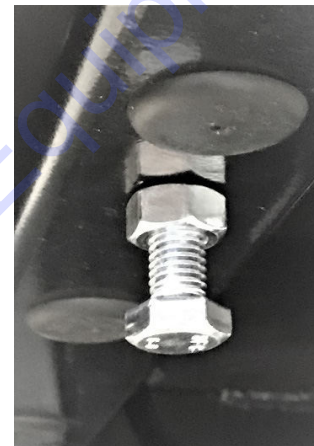

**Maximum Depth Stop Bolt**

4. Bottom out the jam nut on each bolt with the frame base to secure the bolts.
5. Remove all tools from the area and lower the saw completely. The blade flanges must be at least 1/4" from the ground to prevent component damage.
6. Readjust the depth stop bolts as necessary.

*NOTE: Make sure both skid plates on the front of the saw are in the correct set of holes in order to lower the saw completely (refer to Appendix B).*

**Handlebar Lock Cylinder (Optional)**

The handlebar lock cylinder must be serviced by Diamond Products if the handlebars can be moved up or down in excess amounts when locked in place (movement may feel sluggish). Send the entire assembly to Diamond Products to be recharged or pressurized.



**Removing the Lock Cylinder**

1. Open the rear cover screen.
2. Remove the round 1-5/8" hole plug located on the lower right hand side of the upright assembly.

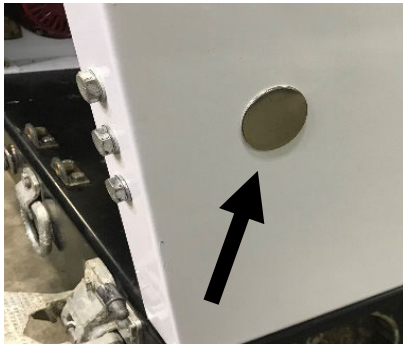

**Cylinder Pin Access Plug**

3. Disconnect the two wires from the solenoid block valve located on the cylinder.



**Solenoid Block Wires**

4. Remove the lower hairpin cotter and push the clevis pin through the access hole on the upright assembly.



**Lower Hairpin Cotter and Clevis Pin**

5. Holding the cylinder, remove the upper hairpin cotter and clevis pin from the handlebar tube.



**Upper Hairpin Cotter and Clevis Pin**

6. Remove the entire assembly from the saw.

**Connecting the Lock Cylinder**

1. Open the rear cover screen.
2. Remove the round 1-5/8" hole plug located on the lower right hand side of the upright assembly.
3. Fit the cylinder into the cylinder rod end mount and isolator mount tube.
4. Fit the upper clevis pin through the cylinder rod end mount and cylinder rod end. Secure in place with the hairpin cotter.
5. Fit the second clevis pin through the access hole in the upright into the isolator mount tube and cylinder block. Secure in place with the hairpin cotter.
6. Connect the two wires to the solenoid block valve.

**Lifting and Transporting**

**Lifting**

 **CAUTION**

Always use a strap to lift the machine. Ensure the strap is rated high enough to handle the load.

1. Ensure the work area is clear of any obstructions and all personnel are at a safe distance prior to lifting the machine.
2. Ensure the engine is *OFF* and the frame is level to the ground prior to lifting.
3. Using a properly rated strap, place the strap around the frame lift point.

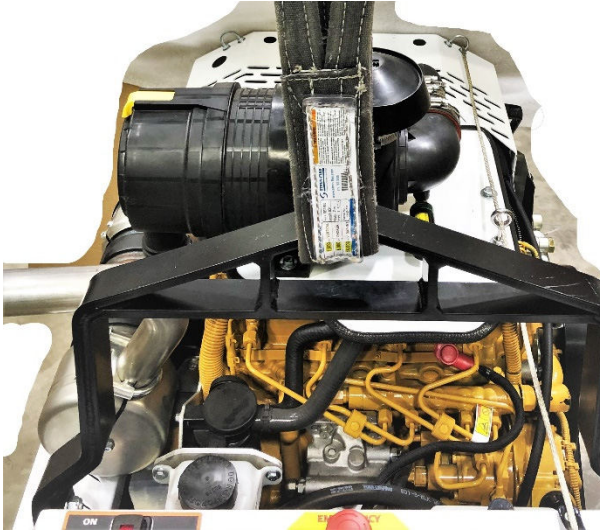

Lifting Point with Strap

### ***Transporting***

Always secure the machine using the two tie-down D-rings to avoid damage during transport. The rings are located on the frame base, one in front and one at the rear.

*NOTE: Never tow the machine as this may cause damage to the drive components.*

### **Storing**

Complete the tasks listed below prior to storing the saw for longer time frames:

- Drain the water lines/hoses and blow out with air.

- Turn off all switches and controls.
- Lower the saw completely to remove strain on the lifting mechanism.
- Clean and wipe down the saw to remove dust, debris, and slurry from saw components (especially fans).
- Remove the battery and store in a proper location, out of reach from children.
- Refer to the engine manual for all engine and fuel recommendations prior to storing.
- Store the saw in a dry area, protected from outdoor elements and out of reach from children.

### **Disposal**

Dispose of the saw when it's no longer repairable, and/or contains safety hazards not worth repairing or maintaining. Complete the tasks listed below when discontinuing usage:

- Drain all fluids and dispose of according to city, state, and federal regulations.
- Remove the battery and bring to a recycling facility; many battery retailers also accept old batteries.
- Transport the saw to a salvage yard or recycling facility.



## REFERENCES

### Appendix A Troubleshooting

<b>Troubleshooting the CC5049D</b>		
<b>Symptom</b>	<b>Problem</b>	<b>Solution</b>
1. Engine will not start.	Out of Fuel?	Fill fuel tank.
	Fuel lines or fuel filter clogged?	Unclog or replace fuel lines or fuel filter.
	Faulty battery connection?	Inspect, clean, and tighten battery cables.
	Engine malfunction?	Refer to engine manual.
	Bad fuse?	Check and replace bad fuses.
	Battery voltage low?	Recharge Battery.
	Speed control lever not in the <i>STOP/PARK</i> position?	Place speed control lever into the <i>STOP/PARK</i> position.
2. Engine will not start due to a shutdown condition indicated on display panel.  <i>NOTE: All problems must be cleared before saw will restart.</i>	E-Stop is active.	Pull up emergency stop button.
	Coolant level is low.	Fill coolant system in accordance with this manual.
3. Saw will not raise.	Defective solenoid start switch?	Replace solenoid on hydraulic pump unit.
	Worn out battery?	Charge or replace battery.
	Defective raise button?	Replace raise button.
	Low hydraulic fluid?	Check hydraulic fluid level and fill as necessary.
4. Saw will not lower.	Debris in lowering valve stem?	Inspect and clean stem.
	Worn out battery?	Charge or replace battery
	Defective valve coil?	Check for magnetism of valve stem when activated.
	Defective lowering button?	Replace lowering button.
5. Saw will not lower completely.	Depth stop set?	Reset depth stop.
	Skid plates in wrong set of holes?	Adjust skid plates to correct set of mounting holes.
	Maximum cutting depth set incorrectly?	Adjust maximum cutting depth stop bolts.
6. Saw lowers too slow or too fast.	Improper lowering speed setting?	Adjust blade lowering speed valve.
7. Blade does not cut straight.	Drive alignment off?	Adjust rear axle adjustment bolt.
	Excessive force used when sawing?	Reduce forward speed. DO NOT twist blade from side to side.
	Wrong blade?	Contact Discount-equipment.

## REFERENCES

8. Short belt life.	Loose belts causing slippage?	Check and adjust belt tension.
	Sheaves misaligned?	Use straightedge to check blade shaft sheave alignment. Adjust as necessary.
	Worn sheave grooves?	Check for groove wear and replace sheaves when necessary.
	Mismatched belts?	Replace with matched set of belts. DO NOT use old and new belts together.
9. Blade Speed Indication is not displayed	Damaged shaft tach sensor?	Adjust or replace shaft tach sensor
	Shaft tach magnetic sensor harness disconnected?	Reconnect sensor harness

**Appendix B**

**CC5049D RPM Chart**

**WARNING:** Do not exceed blade speed (RPM) shown for each blade size.  
Excessive blade speed could result in blade breakage and serious personal injury.

**BLADE LOWERING SPEED**  
SLOW (LENTO) / FAST (RÁPIDO)  
VELOCIDAD DE DESCENSO DEL DISCO

**CC5049D**  
49HP Front Pivot Walk Behind Saw  
Made in the U.S.A.

**DIAMOND PRODUCTS**  
**CORE CUT**  
Diamond Products Limited  
800-321-5336 diamondproducts.com

**ALWAYS WEAR PERSONAL PROTECTIVE EQUIPMENT**  
SIEMPRE USE EL EQUIPO DE PROTECCIÓN PERSONAL DURANTE EL FUNCIONAMIENTO DE MAQUINARIA

**WARNING / ADVERTENCIA**

- READ OWNERS MANUAL BEFORE OPERATING MACHINE / LEA EL MANUAL ANTES DE OPERAR LA MAQUINA
- USE ONLY IN WELL VENTILATED AREA / UTILIZAR ÚNICAMENTE EN LUGARES BIEN VENTILADOS
- ALL GUARDS MUST BE IN PLACE / TODAS LAS GUARDIAS DEBEN ESTAR EN SU LUGAR
- MACHINERY HAZARD / RIESGO - PARTES EN MOVIMIENTO

**WARNING! NEVER EXCEED THE MAXIMUM RPM STAMPED ON THE BLADE! EXCESSIVE SPEED CAN CAUSE BLADE BREAKAGE RESULTING IN SERIOUS PERSONAL INJURY OR DEATH.**

**CC5049 SINGLE SPEED RPM CHART**

BLADE SIZE	BLADE RPM	BLADE SHEAVE	ENGINE SHEAVE	ENGINE RPM	BELT SIZE	FLANGE SIZE	MAX CUT DEPTH
14"	2,800	4.00"	4.00"	2,800	3VX560	4.5"	4-3/4"
20"	2,600	4.00"	4.00"	2,600	3VX560	4.5"	7-3/4"
26"	2,000	4.75"	4.00"	2,375	3VX570	5"	10-1/2"
30"	1,700	4.75"	4.00"	2,020	3VX570	5"	12-1/2"
36"	1,400	5.60"	4.00"	1,960	3VX580	6"	15"
42"	1,200	6.90"	4.00"	2,070	3VX600	7"	17-1/2"

To order go to [www.diamondproducts.com](http://www.diamondproducts.com)

## REFERENCES

### CC5049D Blade Size Conversion Chart

**WARNING:** When changing blade size, use the chart below for selecting the correct items for the different configurations.

Model CC5049D	14"	20"	26"	30"	36"	42"
Blade Guard Assembly	6010950	6010952	6010954	6010956	6010958	6010960
Blade Shaft Sheave (Sheave Size)	6012102 (4")		6010834 (4.75")		6010175 (5.6")	6010289 (6.9")
Drive Belts (8) (Belt Size)	2500188 (3VX560)		2503849 (3VX570)		2503683 (3VX580)	2503684 (3VX600)
Inner Flanges (2) (Flange Size)	6010036 (4.5")		6010255 (5")		6010038 (6")	6017230 (7")
Outer Flanges (2) (Flange Size)	6010037 (4.5")		6047907 (5")		6010039 (6")	6017231 (7")
Skid Plates (2) Mounting Holes	Bottom Set		1 Up from Bottom Set		1 Down from Top Set	Top Set

### Appendix C

#### **Additional Resources**

1. Cat ([www.cat.com](http://www.cat.com))
  - *Operation and Maintenance Manual (C1.7 and C2.2 Industrial Engines)*
  
2. Discount-equipment ([www.discount-equipment.com](http://www.discount-equipment.com))
  - *CC5049 Concrete Saw Parts List*
  - *A Guide for Professional Concrete Cutters*
  - *Training Manual – Introduction to Diamond Blades, Bits, and Equipment*
  - *Diamond Products' Equipment Catalog*
  - *Discount-equipment' Website ([www.discount-equipment.com](http://www.discount-equipment.com))*
  
3. Concrete Sawing and Drilling Association ([www.csda.org](http://www.csda.org))
  - The CSDA has many helpful concrete cutting publications available to members and non-members.
  
4. Association of Equipment Manufacturers ([www.aem.org](http://www.aem.org))
  - The AEM has a variety of safety and technical manuals available for various types of equipment, along with a list of industry-standardized safety symbols.
  
5. Occupational Safety & Health Administration (OSHA) ([www.osha.gov/](http://www.osha.gov/))
  - OSHA provides information on work-related safety and health practices.
  
6. The National Institute for Occupational Safety and Health (NIOSH) ([www.cdc.gov/NIOSH/](http://www.cdc.gov/NIOSH/))
  - NIOSH provides information on work-related safety and health practices.



**Appendix D**

**Model and Serial Numbers**

Record the saw's serial number below for future reference and customer service purposes.

Serial Number	
---------------	--

Record the engine's model and serial numbers below for future reference and customer service purposes. <sup>(1)</sup>

Model Number	
Serial Number	

(1) Note: This information can be viewed on the display panel under the "System Information" menu.

## **EQUIPMENT AND PARTS WARRANTY**

Discount-equipment warrants all equipment sold by it against defects in workmanship or materials for a period of one (1) year from the date of shipment to Customer.

The responsibility of Discount-equipment under this Warranty is limited to replacement or repair of defective parts, of such parts as shall appear to us upon inspection at such parts, to have been defective in material or workmanship, with expense for transportation and labor borne by Customer.

In no event shall Discount-equipment be liable for consequential or incidental damages arising out of the failure of any Product to operate properly.

Integral units such as engines, electric motors, batteries, transmissions, etc., are excluded from this Warranty and are subject to the prime manufacturer's warranty.

**THIS WARRANTY IS IN LIEU OF ALL OTHER WARRANTIES,  
EXPRESSED OR IMPLIED, AND ALL SUCH OTHER WARRANTIES ARE  
HEREBY DISCLAIMED.**



**TO PURCHASE THIS PRODUCT PLEASE CONTACT US**



**Equipment Financing and  
Extended Warranties Available**



**Discount-Equipment.com is your online resource for  
commercial and industrial quality parts and equipment sales.**

**561-964-4949**

**visit us on line @ [www.discount-equipment.com](http://www.discount-equipment.com)**

Select an option below to find your Equipment

**Search by Manufacturer**

**Search by Product Type**

**Request a Quote**

We sell worldwide for the brands: Genie, Terex, JLG, MultiQuip, Mikasa, Essick, Whiteman, Mayco, Toro Stone, Diamond Products, Generac Magnum, Airman, Haulotte, Barreto, Power Blanket, Nifty Lift, Atlas Copco, Chicago Pneumatic, Allmand, Miller Curber, Skyjack, Lull, Skytrak, Tsurumi, Husquvarna Target, Stow, Wacker, Sakai, Mi-T-M, Sullair, Basic, Dynapac, MBW, Weber, Bartell, Bennar Newman, Haulotte, Ditch Runner, Menegotti, Morrison, Contec, Buddy, Crown, Edco, Wyco, Bomag, Laymor, EZ Trench, Bil-Jax, F.S. Curtis, Gehl Pavers, Heli, Honda, ICS/PowerGrit, IHI, Partner, Imer, Clipper, MMD, Koshin, Rice, CH&E, General Equipment, Amida, Coleman, NAC, Gradall, Square Shooter, Kent, Stanley, Tamco, Toku, Hatz, Kohler, Robin, Wisconsin, Northrock, Oztec, Toker TK, Rol-Air, APT, Wylie, Ingersoll Rand / Doosan, Innovatech, Con X, Ammann, Mecalac, Makinex, Smith Surface Prep, Small Line, Wanco, Yanmar