



**CONCRETE SAW
OPERATOR'S MANUAL**

CC3700E Series

May 2019

Part #: 1802695

TO PURCHASE THIS PRODUCT PLEASE CONTACT US



**Equipment Financing and
Extended Warranties Available**



**Discount-Equipment.com is your online resource for
commercial and industrial quality parts and equipment sales.**

561-964-4949

visit us on line @ www.discount-equipment.com

Select an option below to find your Equipment

Search by Manufacturer

Search by Product Type

Request a Quote

We sell worldwide for the brands: Genie, Terex, JLG, MultiQuip, Mikasa, Essick, Whiteman, Mayco, Toro Stone, Diamond Products, Generac Magnum, Airman, Haulotte, Barreto, Power Blanket, Nifty Lift, Atlas Copco, Chicago Pneumatic, Allmand, Miller Curber, Skyjack, Lull, Skytrak, Tsurumi, Husquvarna Target, Stow, Wacker, Sakai, Mi-T-M, Sullair, Basic, Dynapac, MBW, Weber, Bartell, Bennar Newman, Haulotte, Ditch Runner, Menegotti, Morrison, Contec, Buddy, Crown, Edco, Wyco, Bomag, Laymor, EZ Trench, Bil-Jax, F.S. Curtis, Gehl Pavers, Heli, Honda, ICS/PowerGrit, IHI, Partner, Imer, Clipper, MMD, Koshin, Rice, CH&E, General Equipment, Amida, Coleman, NAC, Gradall, Square Shooter, Kent, Stanley, Tamco, Toku, Hatz, Kohler, Robin, Wisconsin, Northrock, Oztec, Toker TK, Rol-Air, APT, Wylie, Ingersoll Rand / Doosan, Innovatech, Con X, Ammann, Mecalac, Makinex, Smith Surface Prep, Small Line, Wanco, Yanmar

CC3700E Recommended Power Cord Gauge - 3 Phase

Horsepower	Phase	Voltage	Amps	50ft Cord	100ft Cord	150ft Cord	200ft Cord	300ft Cord
25	3	230	58	#6	#4	#4	#2	N/A
25	3	460	29	#10	#10	#8	#8	#6
30	3	460	37	#8	#8	#8	#6	#4
40	3	460	48	#6	#6	#6	#6	#4

CC3700E Minimum Recommended Generator Sizes

Saw	H.P.	Phase	KW	Soft Start
CC3725E	25	3	50	30kw
CC3730E	30	3	60	40kw
CC3740E	40	3	80	60kw

NOTE: Electric saws do not ship with electric cord or pigtails

NOTE: 3-Phase powered saws do not include male electric connector for control box.

To order go to Discount-Equipment.com

TABLE OF CONTENTS

Table of Contents

Introduction	6
CC3700E Controls	7
CC3700E Dimensions	8
CC3700E Single Speed Specifications	9
CC3725E	9
CC3730E	10
CC3740E	11
CC3700E 3-Speed Specifications	12
CC3730E-3	12
CC3740E-3	13
Safety	14
Safety Alerts	14
Proposition 65	14
Respiratory Hazards	14
General Safety	15
Battery and Electrical Safety	16
Blade Safety	16
Blade Guard Safety	16
Cutting Safety	17
Hydraulic Safety	17
Belt Safety	17
Transporting Safety	18
Lifting Safety	18
Operating	19
General Operating Precautions	19
Handlebars	19
Adjusting the Handlebars	19
Control Grip Pushbuttons	19
Control Grip Pushbuttons	19
Blade Lowering Speed	20
Panel Mounted Speed Control Valve (Optional)	20
Speed Control Lever	21
Blade Guard	21
Installing the Blade Guard	21
Removing the Blade Guard	22
Flange Guard	22
Installing the Flange Guard	22
Removing the Flange Guard	22
Diamond Blades	22
Inspecting the Blade	23
Blade Speed	23
Single Speed Saws	23
3-Speed Saws	23
Shifting 3-Speed Gearbox Transmission	23
Wrench	23
Installing the Blade	24
Removing the Blade	25
Motor	25
Starter Box Assembly	25

TABLE OF CONTENTS

Optional Soft Start Box Assembly	25
DC Travel Drive Starter Box Assembly	26
Overload Protection.....	26
Tasks Prior to Starting the Motor.....	26
Starting the Motor.....	26
Stopping the Motor.....	26
Transmission Lever.....	26
Engaging the Transmission.....	26
Disengaging the Transmission.....	27
DC Travel Mode (Optional).....	27
Starting the DC Travel Option.....	27
Stopping the DC Travel Option.....	27
Water Supply.....	27
Single Speed Operation.....	27
Three Speed Operation.....	28
Water Pump (Optional).....	29
Cutting.....	29
Cutting Guides.....	29
Adjusting the Front Pointer.....	29
Adjusting the Rear Pointer(s).....	29
Straight Line Cutting.....	29
Helpful Hints Prior to Cutting.....	29
Tasks Prior to Cutting.....	30
Making a Cut without Using the Blade Depth Stop.....	30
Making a Cut Using the Blade Depth Stop.....	30
Continuing a Partial-Cut.....	31
Finishing a Cut.....	31
Drive Alignment.....	31
Adjusting the Drive Alignment.....	31
Spotlight.....	31
Parking Brake (Optional).....	31
Engaging the Parking Brake.....	31
Disengaging the Parking Brake.....	31
Maintenance.....	32
General.....	32
Pre Maintenance Preparations.....	32
Rear Cover Screen.....	32
General Cleaning.....	32
Cleaning Techniques.....	32
Control Panel.....	32
Motor.....	32
Part Lubrication.....	33
Post Cleaning.....	33
Service Schedule.....	34
Daily Service.....	35
Hydraulic System.....	35
Adding Fluid to the Hydraulic Lift Pump.....	35
Check and Clean Blade Guard Spray Tubes.....	35
Lubricate the Blade Shaft Bearings (Single Speed Saws Only).....	35
25 Hour Service.....	35

TABLE OF CONTENTS

Inspect Belts.....	35
50 Hour Service.....	36
Lubricate Front Axle Bearings.....	36
Regular Maintenance.....	36
Belt Tensioning.....	36
Tensioning the Drive Belts.....	36
Replacing the Drive Belts.....	36
Drive Belt Sheaves.....	36
Removing the Set Screw Style Sheave.....	37
Removing the Taper Style Sheave.....	37
Removing the Quick Disconnect (QD) Style Sheave.....	37
Installing the Set Screw Style Sheave.....	37
Installing the Taper Style Sheave.....	37
Installing the Quick Disconnect (QD) Style Sheave.....	37
Motor.....	37
Disconnecting the Power to the Motor.....	38
Battery.....	38
Battery Type.....	38
Servicing the Battery.....	38
Inner Blade Flange.....	39
Installing the Inner Blade Flange.....	39
Removing the Inner Blade Flange.....	39
Lifting and Transporting.....	39
Lifting.....	39
Transporting.....	39
Storing.....	39
Disposal.....	39
Appendix A.....	40
Troubleshooting.....	40
Appendix B.....	41
CC3700E Single Speed RPM Charts.....	41
CC3700E Single Speed Blade Size Conversion Charts.....	42
CC3700E 3-Speed RPM Charts.....	43
CC3700E 3-Speed Blade Size Conversion Charts.....	43
Appendix C.....	45
Additional Resources.....	45
Appendix D.....	46
Model and Serial Numbers.....	46

Introduction

Welcome to the Diamond Products family and thank you for choosing Diamond Products equipment. At Diamond Products we are driven to ensure you are completely satisfied with your product and continually strive to improve our product line so that we can offer you the best possible equipment in the industry.

This operator's manual is a critical document that provides pertinent information regarding the safety, operation, maintenance, and care of your new equipment. Keep this manual available at all times. Operate the equipment and all of its components according to this manual. Failure to comply with and understand the following safety, operation and maintenance instructions can result in serious injuries and/or death. All operators must be properly trained or supervised by experienced personnel prior to using this saw and should understand the risks and hazards involved. Diamond Products discourages improper or unintended equipment usage and cannot be held liable for any resulting damages.

Equipment modifications should be made by Diamond Products to ensure safety and design. Any modifications made by the owner(s) are not the responsibility of Diamond Products and void all equipment warranties if a problem arises as a result of the modification.

Refer to the Diamond Products Parts List for additional information and part diagrams. Refer to the motor manufacturer as the primary source for all safety, operations, and maintenance instructions regarding the motor. Prior to operating, record the saw's serial number, and the motor's model and serial numbers in Appendix D.

CC3700E Controls

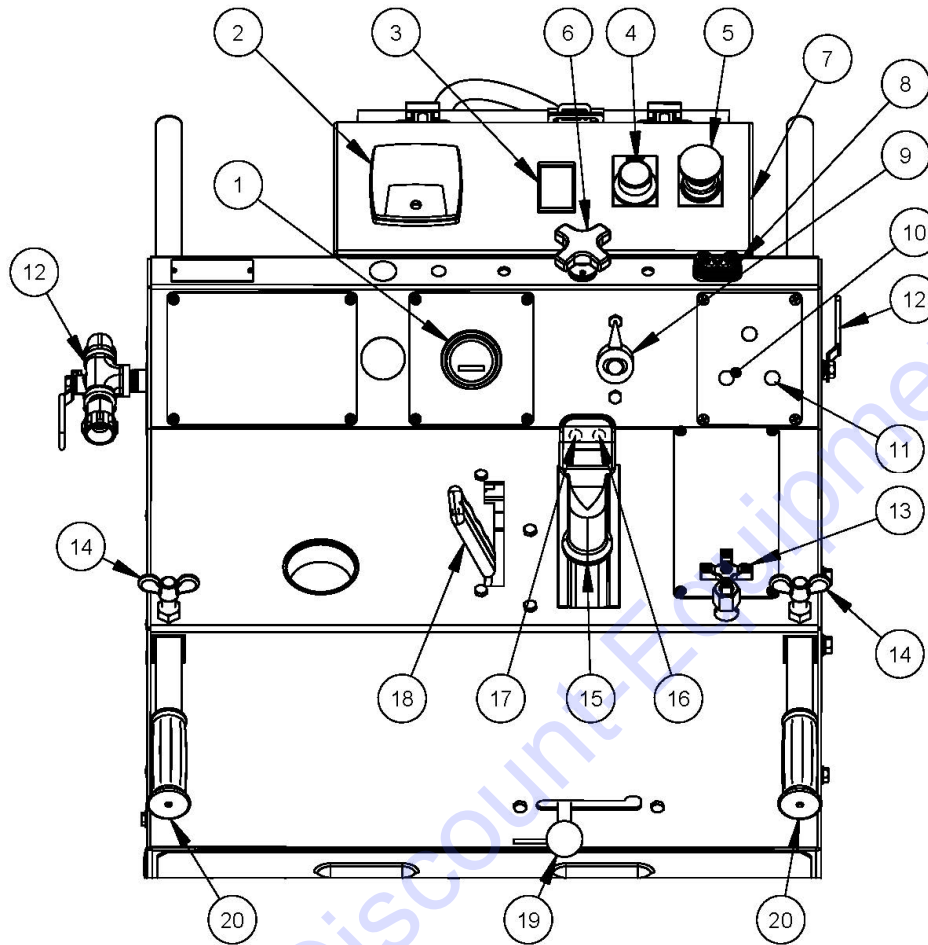

- | | |
|--|---|
| <ol style="list-style-type: none"> 1. Hour Meter – Analog gauge displays the blade shaft speed (RPM). Digital gauge displays the motor’s accumulated operational hours. 2. Amp Meter – Analog gauge displays the motor’s output amperage. 3. Battery Charge Ammeter – Analog gauge displays the battery current draw in amps. 4. Motor Start Button – Starts the motor. 5. Motor Stop Button – Shuts the motor off. 6. Depth Stop Knob – Allows operator to set the cutting depth. 7. DC Travel Switch (Optional) – Starts and stops the DC travel motor. 8. Pointer Rope Cleat 9. Cutting Depth Indicator – Displays the current depth of cut in inches. 10. Water Pump Switch (Optional) – Activate water pump. 11. Spotlight Switch (Optional) – Activates spotlight. | <ol style="list-style-type: none"> 12. Water Valve – Turns water flow on and off to the blade guard. 13. Blade Lowering Speed Valve (Optional) – Controls the lowering speed of the saw 14. Handlebar Locking Knobs – Locks the handlebars in place. 15. Speed Control Lever – Provides forward, reverse, and neutral control. 16. Saw Lower Pushbutton – Bleeds hydraulic pressure from the lift cylinder to lower the saw. 17. Saw Raise Pushbutton – Activates hydraulic pump to raise the saw. 18. Transmission Engagement Lever (Eaton Transmission) – Manually engages and disengages the transmission. 19. Transmission Engagement Lever (Sundstrand Transmission) – Manually engages and disengages the transmission. 20. Handlebar – Allows for manual maneuvering of the saw. |
|--|---|

CC3700E Dimensions

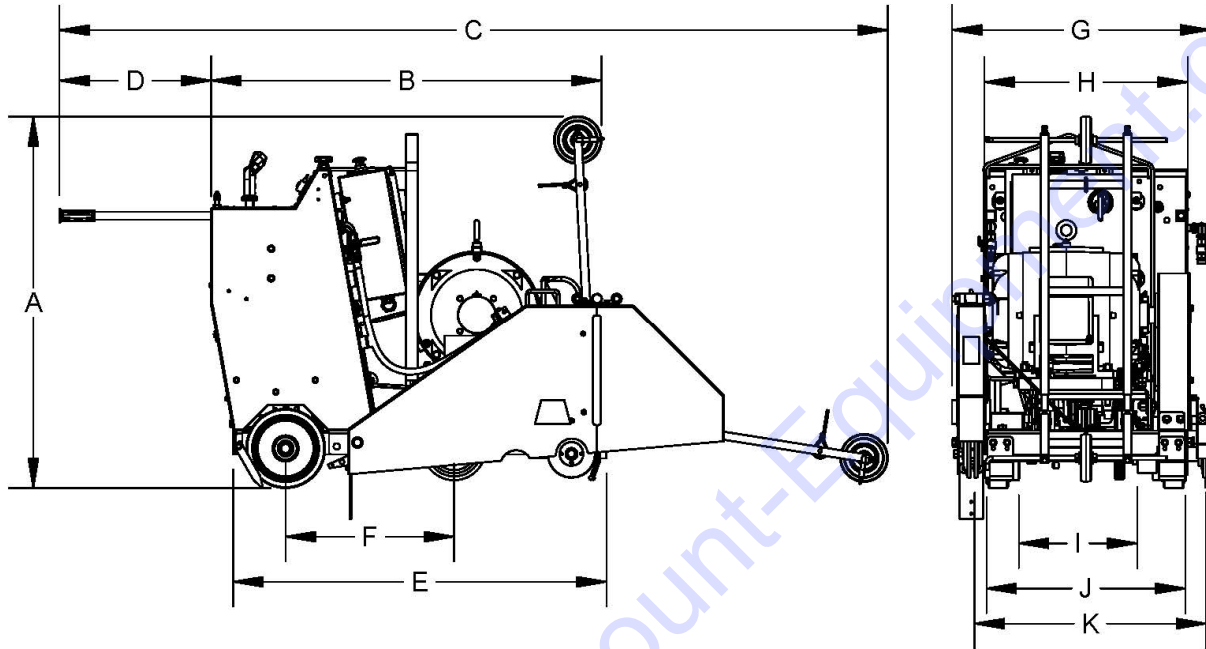

CC3700E Dimensions		Inches	Millimeters
A	Saw Height	47-1/4	1200
B	Saw Length - Min.	48-7/8	1241
C	Saw Length - Max.	116	2946
D	Handle Extension - Max.	24	610
E	Frame Length	46	1168
F	Wheel Base Length	21-3/8	543
G	Saw Width	32-3/4	832
H	Rear Frame Width	25-3/4	654
I	Front Wheels Inside Width	17	432
J	Rear Wheels Outside Width	25-1/4	641
K	Inner Flange to Inner Flange Width	29-3/8	746
-	Blade Raise Height - Max.	19	483

INTRODUCTION

CC3700E Single Speed Specifications

CC3725E

CC3725E Specifications					
Saw Model	CC3725E-14	CC3725E-20	CC3725E-26	CC3725E-30	CC3725E-36
Blade Guard Capacity	14" (350mm)	20" (500mm)	26" (700mm)	30" (800mm)	36" (900mm)
Blade Cutting Depth Max	4.75"	7.75"	10.75"	12"	15"
Blade Shaft Speed	3050 rpm	2350 rpm	1800 rpm	1550 rpm	1375 rpm
Blade Flange Size	4.5" OD	4.5" OD	4.5" OD	6" OD	6" OD
Motor Model	Leeson C284T17FB5C				
Rated Output Power	25 HP				
Rated Voltage	230/460/575 V				
Full Load Amps	58.5/29.3/23.6 A				
Rated Speed	1782 rpm (Leeson rating)				
Rated Frequency	60Hz.				
Phase	3				
Battery	12 Volt (630 CCA) group size 34				
Saw Lift Pump Fluid	Automatic Transmission Fluid (ATF); (2 Liter capacity)				
Lubrication Type	NLGI #2 Lithium grease				
Blade Arbor Size	1" Diameter with drive pin				
Blade Flange Style	Quick disconnect				
Blade Shaft Size	1-3/4" OD with left/right side blade mounting				
Blade Shaft Bearings	2 Pillow blocks with spherical roller bearings				
Blade Shaft Drive	Motor: 6 V-Belts (3VX500)				
Blade Coolant	Dual stainless steel multi-jet spray tubes				
Blade Guard Attachment	Slip-on tapered spade (with rear bolt for 36" guard)				
Blade Raise and Lower	Electro-hydraulic power unit with push button control				
Blade Lowering Speed	Flow control valve				
Blade Depth Control	Dial depth indicator and manual depth stop				
Blade Alignment	Telescoping front/rear/left/right pointers				
Axle Size (Front/Rear)	Front: 1" OD straight / Rear: 1.25" OD straight				
Front Wheels	8" x 3" with 1/2" poly tread (sealed ball bearings)				
Rear Wheels	10" x 3" with 2" poly tread (1-1/4" trantorque bushing)				
Travel Speed	0-200 FPM (2.25 mph) forward/reverse				
Rear Wheel Transmission	Eaton Model 10 transmission with chain drive				
Transmission Belt	Link Belt				
Rear Wheel Drive	Gear drive				
Parking Brake	Manual rear wheel friction (optional)				
Handle Bar Adjustment	Variable extension with dual 0° and 30° angle range				

INTRODUCTION

CC3730E

CC3730E Specifications					
Saw Model	CC3730E-14	CC3730E-20	CC3730E-26	CC3730E-30	CC3730E-36
Blade Guard Capacity	14" (350mm)	20" (500mm)	26" (700mm)	30" (800mm)	36" (900mm)
Blade Cutting Depth Max	4.75"	7.75"	10.75"	12"	15"
Blade Shaft Speed	3050 rpm	2350 rpm	1800 rpm	1550 rpm	1375 rpm
Blade Flange Size	4.5" OD	4.5" OD	4.5" OD	6" OD	6" OD
Motor Model	Baldor EM2535T-CI				
Rated Output Power	30 HP				
Rated Voltage	460 V				
Full Load Amps	39 A				
Rated Speed	1770 rpm (Baldor rating)				
Rated Frequency	60Hz.				
Phase	3				
Battery	12 Volt (630 CCA) group size 34				
Saw Lift Pump Fluid	Automatic Transmission Fluid (ATF); (2 Liter capacity)				
Lubrication Type	NLGI #2 Lithium grease				
Blade Arbor Size	1" Diameter with drive pin				
Blade Flange Style	Quick disconnect				
Blade Shaft Size	1-3/4" OD with left/right side blade mounting				
Blade Shaft Bearings	2 Pillow blocks with spherical roller bearings				
Blade Shaft Drive	Motor: 6 V-Belts (3VX500)				
Blade Coolant	Dual stainless steel multi-jet spray tubes				
Blade Guard Attachment	Slip-on tapered spade (with rear bolt for 36" guard)				
Blade Raise and Lower	Electro-hydraulic power unit with push button control				
Blade Lowering Speed	Flow control valve				
Blade Depth Control	Dial depth indicator and manual depth stop				
Blade Alignment	Telescoping front/rear/left/right pointers				
Axle Size (Front/Rear)	Front: 1" OD straight / Rear: 1.25" OD straight				
Front Wheels	8" x 3" with 1/2" poly tread (sealed ball bearings)				
Rear Wheels	10" x 3" with 2" poly tread (1-1/4" trantorque bushing)				
Travel Speed	0-200 FPM (2.25 mph) forward/reverse				
Rear Wheel Transmission	Eaton Model 10 transmission with chain drive				
Transmission Belt	Link Belt				
Rear Wheel Drive	Gear drive				
Parking Brake	Manual rear wheel friction (optional)				
Handle Bar Adjustment	Variable extension with dual 0° and 30° angle range				

INTRODUCTION

CC3740E

CC3740E Specifications				
Saw Model	CC3740E-20	CC3740E-26	CC3740E-30	CC3740E-36
Blade Guard Capacity	20" (500mm)	26" (700mm)	30" (800mm)	36" (900mm)
Blade Cutting Depth Max	7.75"	10.75"	12"	15"
Blade Shaft Speed	2500 rpm	2000 rpm	1700 rpm	1350 rpm
Blade Flange Size	4.5" OD	4.5" OD	6" OD	6" OD
Motor Model	Baldor EM2539T-CI			
Rated Output Power	40 HP			
Rated Voltage	460 V			
Full Load Amps	48 A			
Rated Speed	1770 rpm (Baldor rating)			
Rated Frequency	60Hz.			
Phase	3			
Battery	12 Volt (630 CCA) group size 34			
Saw Lift Pump Fluid	Automatic Transmission Fluid (ATF); (2 Liter capacity)			
Lubrication Type	NLGI #2 Lithium grease			
Blade Arbor Size	1" Diameter with drive pin			
Blade Flange Style	Quick disconnect			
Blade Shaft Size	1-3/4" OD with left/right side blade mounting			
Blade Shaft Bearings	2 Pillow blocks with spherical roller bearings			
Blade Shaft Drive	Motor: 6 V-Belts (3VX560)			
Blade Coolant	Dual stainless steel multi-jet spray tubes			
Blade Guard Attachment	Slip-on tapered spade (with rear bolt for 36" guard)			
Blade Raise and Lower	Electro-hydraulic power unit with push button control			
Blade Lowering Speed	Flow control valve			
Blade Depth Control	Dial depth indicator and manual depth stop			
Blade Alignment	Telescoping front/rear/left/right pointers			
Axle Size (Front/Rear)	Front: 1" OD straight / Rear: 1.25" OD straight			
Front Wheels	8" x 3" with 1/2" poly tread (sealed ball bearings)			
Rear Wheels	10" x 3" with 2" poly tread (1-1/4" trantorque bushing)			
Travel Speed	0-200 FPM (2.25 mph) forward/reverse			
Rear Wheel Transmission	Eaton Model 10 transmission with chain drive			
Transmission Belt	Link Belt			
Rear Wheel Drive	Gear drive			
Parking Brake	Manual rear wheel friction (optional)			
Handle Bar Adjustment	Variable extension with dual 0° and 30° angle range			

INTRODUCTION

CC3700E 3-Speed Specifications

CC3730E-3

Saw Model	CC3730E-3-14	CC3730E-3-20	CC3730E-3-26	CC3730E-3-30	CC3730E-3-36	CC3730E-3-42
Blade Guard Capacity	14" (350mm)	20" (500mm)	26" (700mm)	30" (800mm)	36" (900mm)	42" (1100mm)
Blade Cutting Depth Max	4"	7"	10"	12"	15"	18"
Blade Shaft Speed	2925 rpm	2520 rpm	1950 rpm	1680 rpm	1300 rpm	1120 rpm
Blade Flange Size	6" OD					
Motor Model	Baldor EM2535T-CI					
Rated Output Power	30 HP					
Rated Voltage	460/575 V					
Full Load Amps	39/29 A					
Rated Speed	1770 rpm (Baldor rating)					
Rated Frequency	60Hz.					
Phase	3					
Battery	12 Volt (630 CCA) group size 34					
3-Speed Gearbox Fluid	SAE 75W-90 Synthetic Gear Oil (3 qts.)					
Saw Lift Pump Fluid	Automatic Transmission Fluid (ATF); (2 Liter capacity)					
Lubrication Type	NLGI #2 Lithium grease					
Blade Arbor Size	1" Diameter with drive pin					
Blade Flange Style	Quick disconnect					
Blade Shaft Drive	(6) V-Belts (3VX464)	(6) V-Belts (3VX450)	(6) V-Belts (3VX464)	(6) V-Belts (3VX450)	(6) V-Belts (3VX464)	(6) V-Belts (3VX450)
Blade Coolant	Dual stainless steel multi-jet spray tubes					
Blade Guard Attachment	Slip-on tapered spade (with rear bolt for 36" & 42" guards)					
Blade Raise and Lower	Electro-hydraulic power unit with push button control					
Blade Lowering Speed	Flow control valve (panel mount optional)					
Blade Depth Control	Dial depth indicator and manual depth stop					
Blade Alignment	Telescoping front/rear/left/right pointers					
Axle Size (Front/Rear)	Front: 1" OD straight / Rear: 1.25" OD straight					
Front Wheels	8" x 3" with 1/2" poly tread (sealed ball bearings)					
Rear Wheels	10" x 3" with 2" poly tread (1-1/4" trantorque bushing)					
Travel Speed	0-200 FPM (2.25 mph) forward/reverse					
Rear Wheel Transmission	Eaton Model 11 transmission with belt drive					
Transmission Belt	(1) 3VX650	(1) 3VX630	(1) 3VX650	(1) 3VX630	(1) 3VX650	(1) 3VX630
Rear Wheel Drive	Chain drive					
Parking Brake	Manual rear wheel friction (optional)					
Handle Bar Adjustment	Variable extension with dual 0° and 30° angle range					

INTRODUCTION

CC3740E-3

Saw Model	CC3740E-3-14	CC3740E-3-20	CC3740E-3-26	CC3740E-3-30	CC3740E-3-36	CC3740E-3-42
Blade Guard Capacity	14" (350mm)	20" (500mm)	26" (700mm)	30" (800mm)	36" (900mm)	42" (1100mm)
Blade Cutting Depth Max	4"	7"	10"	12"	15"	18"
Blade Shaft Speed	2925 rpm	2520 rpm	1950 rpm	1680 rpm	1300 rpm	1120 rpm
Blade Flange Size	6" OD					
Motor Model	Baldor EM2539T-CI					
Rated Output Power	30 HP					
Rated Voltage	460/575 V					
Full Load Amps	48/37 A					
Rated Speed	1770 rpm (Baldor rating)					
Rated Frequency	60Hz.					
Phase	3					
Battery	12 Volt (630 CCA) group size 34					
3-Speed Gearbox Fluid	SAE 75W-90 Synthetic Gear Oil (3 qts.)					
Saw Lift Pump Fluid	Automatic Transmission Fluid (ATF); (2 Liter capacity)					
Lubrication Type	NLGI #2 Lithium grease					
Blade Arbor Size	1" Diameter with drive pin					
Blade Flange Style	Quick disconnect					
Blade Shaft Drive	(8) V-Belts (3VX475)	(8) V-Belts (3VX464)	(8) V-Belts (3VX475)	(8) V-Belts (3VX464)	(8) V-Belts (3VX475)	(8) V-Belts (3VX464)
Blade Coolant	Dual stainless steel multi-jet spray tubes					
Blade Guard Attachment	Slip-on tapered spade (with rear bolt for 36" & 42" guards)					
Blade Raise and Lower	Electro-hydraulic power unit with push button control					
Blade Lowering Speed	Flow control valve (panel mount optional)					
Blade Depth Control	Dial depth indicator and manual depth stop					
Blade Alignment	Telescoping front/rear/left/right pointers					
Axle Size (Front/Rear)	Front: 1" OD straight / Rear: 1.25" OD straight					
Front Wheels	8" x 3" with 1/2" poly tread (sealed ball bearings)					
Rear Wheels	10" x 3" with 2" poly tread (1-1/4" trantorque bushing)					
Travel Speed	0-200 FPM (2.25 mph) forward/reverse					
Rear Wheel Transmission	Eaton Model 11 transmission with belt drive					
Transmission Belt	(1) 3VX650	(1) 3VX630	(1) 3VX650	(1) 3VX630	(1) 3VX650	(1) 3VX630
Rear Wheel Drive	Chain drive					
Parking Brake	Manual rear wheel friction (optional)					
Handle Bar Adjustment	Variable extension with dual 0° and 30° angle range					

SAFETY PRECAUTIONS

Safety

Operate the equipment and all of its components according to this manual. Failure to comply with and understand the following safety, operation and maintenance instructions can result in serious injuries and/or death. All operators must be properly trained or supervised by experienced personnel prior to using this saw and should understand the risks and hazards involved. Diamond Products discourages improper or unintended equipment usage and cannot be held liable for any resulting damages.

Equipment modifications should be made by Diamond Products to ensure safety and design. Any modifications made by the owner(s) are not the responsibility of Diamond Products and void all equipment warranties if a problem arises as a result of the modification.

Refer to the Diamond Products Parts List for additional information and part diagrams. Refer to the motor manufacturer as the primary source for all safety, operations, and maintenance instructions regarding the motor. Prior to operating, record the saw's serial number, and the motor's model and serial numbers in Appendix D.

Notice: The information in this manual may be updated at any time!

Safety Alerts



DANGER

Serious injuries and/or death will occur if these instructions are not followed.



WARNING

Serious injuries and/or death could occur if these instructions are not followed.



CAUTION

Mild and/or moderate injuries could occur if these instructions are not followed.

Proposition 65

PROPOSITION 65



WARNING: Concrete cutting produces dust that can expose you to chemicals including Silica, crystalline (airborne particles of respirable size), which is known to the state of California to cause cancer. For more information go to:

WWW.P65WARNINGS.CA.GOV

Respiratory Hazards



WARNING

Concrete cutting produces dust and fumes known to cause illness, death, respiratory disease, birth defects, and/or other reproductive harm. Safety protection techniques include, but are not limited to:

- Wearing gloves.
- Wearing safety goggles or a face shield.
- Using approved respirators.
- Washing work clothes daily.
- Using water when wet cutting to minimize dust.
- Washing the hands and face prior to eating/drinking.

For additional safety and self-protection information contact your employer, the Occupational Safety and Health Administration (OSHA), and/or The National Institute for Occupational Safety and Health (NIOSH).

SAFETY PRECAUTIONS

General Safety

- Read and understand all safety, operations, and maintenance instructions provided in this manual prior to operating or servicing the saw.
- Keep equipment components clean and free of slurry, concrete dust, and debris.
- Inspect water hoses prior to operating the equipment. Clean, repair, or replace damaged components.
- Raise the equipment to a proper height for access when working underneath the equipment. Use chocks to block the wheels, and fit blocks or jacks under the frame edges.



WARNING

Do NOT work on equipment using the hydraulic lift system to keep the equipment in the raised position for maintenance or repair. Accidental loss of hydraulic pressure could cause the equipment to drop suddenly, resulting in serious injury or death.

- When using a jack to raise the equipment, place the jack against a solid, flat area under the frame base to properly support the equipment.
- Repair the equipment immediately when a problem arises.
- Replace equipment decals if unreadable.
- Dispose of all hazardous waste materials according to city, state, and federal regulations.
- Always have a phone nearby, and locate the nearest fire extinguisher and first aid kit prior to operating the equipment.
- Operate the equipment wearing flame resistant clothing.
- Always wear safety glasses when removing retaining rings.
- Underage or non-trained personnel should not operate the equipment.
- Keep all body parts away from rotating machinery.
- Replace all guards and access panels (unless stated otherwise) prior to operating the equipment.
- Always pivot front of blade guard fully closed to avoid serious injuries.

DO NOT:

- Assume the equipment will remain still when in neutral or when parking/stopping the equipment on a slope. Chock the wheels to help prevent unnecessary movement.
- Drop equipment, supplies, tools, etc., when handling to help prevent injuries.
- Lift and carry equipment, supplies, tools, etc., that are too heavy and/or cannot be lifted easily.

- Operate the equipment without using the appropriate safety equipment required for the work task.



- Operate or service the equipment with any clothing, hair, or accessories that can snag in the machinery, which could lead to serious injuries or death!
- Operate the equipment using attachments not associated with or recommended for the equipment.
- Operate the equipment around combustible materials.
- Operate the equipment with anyone near the work area or within the direct line of the blade.
- Operate the equipment until all unnecessary materials have been removed from the work area.
- Operate the equipment with loose nuts, screws, and bolts.
- Operate the equipment when ill or fatigued.
- Operate the equipment under the influence of drugs and/or alcohol.
- Operate the equipment on steep slopes.
- Cut concrete with guards and access panels removed.
- Grease the equipment with the motor running.
- Touch hot components when operating the equipment.
- Leave the equipment unattended until the motor is off and the blade has stopped.
- Place the equipment into storage until it has cooled down.
- Service the equipment until it has cooled down.
- Service the equipment with the motor running.

Battery and Electrical Safety

- Ignitable explosive gases are emitted from the battery. DO NOT expose the battery to sparks or open flames. 
- Keep the area around the battery well-ventilated.
- Keep the battery level when handling it.
- Use protective eyewear or a face shield, and avoid contact with the skin when handling/servicing the battery.
- Use a proper battery tester when testing the battery strength.
- Always be sure to connect the battery cables to the proper terminal when reconnecting the cables.
- Occasionally inspect the battery, cables, clamps, and terminals for damages. Service components as necessary.
- Always keep the battery cable clamps away from the battery terminals when the battery is disconnected to avoid accidental connections while servicing.
- Immediately rinse your clothing, skin, or eyes with water if exposed to battery acid. Seek medical attention immediately!
- Disconnect the battery prior to servicing all equipment components (unless stated otherwise).
- Remove the battery when storing the equipment for longer periods.
- Always use the correct size fuses (amps) to prevent fires.

Blade Safety

- Always use reinforced abrasive blades or steel-centered diamond blades.
- Never use a wet cutting blade without an adequate water supply to properly lubricate the blade.
- Inspect all blades prior to usage and discard damaged blades.
- DO NOT install or remove a blade with the motor running.
- Keep all body parts away from rotating blades.
- Inspect the blade flanges for damages, wear, and cleanliness. Clean or replace dirty/damaged components immediately.

- DO NOT expose yourself or anyone else to the direct line of the blade when operating the equipment.



- Always use an appropriate size blade and the correct blade type based on the cutting task and the type of material being cut.
- The blade must always fit snug on the blade shaft, outer flange, and/or inner flange.
- Wear gloves and be alert to the surrounding environment when handling blades.
- When installing the blade, always point the arrow printed on the blade in the direction of the blade shaft's rotation.
- DO NOT exceed the blade's maximum recommended speed when cutting. Excessive blade speeds can cause blade breakage, resulting in serious injuries and/or death!
- DO NOT use damaged blades when cutting to avoid harming yourself, others, or the equipment.
- DO NOT use a blade for cutting that requires a lower speed than the blade shaft speed.
- Always tighten the blade shaft bolt/screw as directed to properly secure the outer flange and blade. Failure to properly secure the outer flange and blade may cause parts to loosen or fall off the equipment, resulting in serious injuries or death!
- Let the blade cool prior to removal when dry cutting (applicable models).

Blade Guard Safety

- DO NOT operate the equipment with the blade guard raised or removed.
- Blade exposure should not exceed 180° while cutting.
- When pivoting the front of the blade guard, raise/lower it cautiously and slowly to avoid serious injuries.
- DO NOT pivot the blade guard front up or down when installing/removing very large blades. Attempting to pivot the front of a heavy guard when the guard is positioned higher up for blade installation/removal makes the guard difficult to lift and/or lower. In this situation, install/remove the blade guard front instead of pivoting it.

SAFETY PRECAUTIONS

- Always pivot the front of the blade guard 180° (fully upward) so the guard does not swing down unexpectedly, causing serious injuries.



- Always secure the pivoted section of the blade guard using the detent pin (guards 26" and up).
- Use extreme caution when installing/removing parts of a guard or the entire guard as guards can be extremely heavy and may require installation/removal at moderate heights.
- DO NOT install or remove the blade guard with the motor running.
- Always use a blade guard that corresponds with the blade size.
- Inspect the blade guard and water tubes prior to starting the equipment. Clean or replace dirty/damaged components immediately.

Cutting Safety

- The direct work area should not contain buried or embedded electrical, gas, or water lines that could be damaged and/or cause personal injury while cutting.
- Turn off all electricity, gas, and water around the direct work area prior to cutting.
- Inspect the work area to ensure nothing will impede full control of the machine at all times.
- DO NOT expose yourself or anyone else to the direct line of the blade when operating the equipment.
- DO NOT allow any person, animal, and/or objects in and around the work area while cutting.
- DO NOT install a blade on the machine until it is in the cutting area.
- Ensure the work area is adequately illuminated to ensure safe operation of the machine.

Hydraulic Safety

- Turn off the motor prior to servicing hydraulic components.
- Lower the equipment completely prior to servicing to decrease the hydraulic pressure in the lines.
- Always make sure any hydraulic components being serviced are not supporting the weight of other equipment components. If a particular component is under pressure when connection points are loosened, oil may spray out forcefully.

- Always place a piece of cardboard or paper up against hydraulic components, or use a leak detection fluid to check for hydraulic fluid leaks. Keep all body parts away from leaks and/or areas that may eject hydraulic fluid. Pressurized hydraulic fluid can penetrate the skin, causing serious injuries. Seek medical attention immediately!



Belt Safety

- Turn off the motor and let the belts cool down prior to servicing them.
- Regularly inspect the belts for fraying, stress cracks, and/or breakage and replace immediately when damaged. Always check the belt alignment prior to operating the equipment.
- Use extreme caution when working with belts and rotating machine parts to avoid entanglement.
- Over-tensioning belts may reduce the life of the gearbox bearings. Under-tensioning belts may cause slippage, shorter belt life, and/or poor equipment performance.
- Squealing belts indicate looseness.
- DO NOT use old and new belts together on the same sheave.

SAFETY PRECAUTIONS

Transporting Safety

- Remove the blade prior to transporting the equipment.
- Make sure the truck/trailer is in good, working condition and sufficient to transport the load. DO NOT tow the equipment behind a vehicle.
- Use heavy-duty ramps that will support the weight of the equipment and yourself when loading or unloading.
- Raise the equipment to avoid damaging components while moving up and down ramps.

- Use extreme caution when guiding the equipment up and down ramps. Slowly drive the equipment forward down the ramp. Slowly back the equipment in reverse up the ramp. Avoid standing directly downhill from the equipment to prevent machine rollover.



- Place the equipment in neutral and turn off the motor once the equipment is loaded in the truck/trailer.
- Chock the wheels and secure the saw in the truck/trailer prior to transporting.
- Refer to the Department of Transportation (DOT) for additional transportation recommendations.

Lifting Safety

- Move yourself and all others away from the lifting area when hoisting the saw to prevent being crushed.



- Secure the appropriate hoisting cables, straps, and/or chains to the saw's designated lift points prior to hoisting.
- Never use the tie-down brackets (applicable models) to lift the saw.
- DO NOT attempt to lift the saw irresponsibly and/or improperly.

Operating

General Operating Precautions

- Prior to operating the machine, read the operator's manual thoroughly and ensure that you understand the safe and proper operation of the machine.
- Use approved personal protective equipment at all times while operating the machine.
- Ensure that there is firefighting equipment and a first aid kit nearby while operating the machine.
- Ensure the cutting area is free of obstructions, people, and or animals prior to operating the machine.
- Always operate the machine from the operator's position at the rear of the machine between the handlebars.
- Do not stand in front or behind the blade path while the motor is running.

Handlebars

The handlebars help to guide and maneuver the saw.

Adjusting the Handlebars

1. Loosen both of the handlebar lock knobs.
2. Hold the handlebar grip and place the first handlebar into the handlebar opening below the handle lock knob. The handlebar can fit through two different angled pathways inside the handlebar opening. Select the handlebar angle that works best for the current task.
3. Move the handlebar forward or backward to adjust the length.

NOTE: Maintain a minimum of 6" of handlebar into the handlebar tube at all times.

4. Tighten the handlebar lock knob to secure the handlebar.

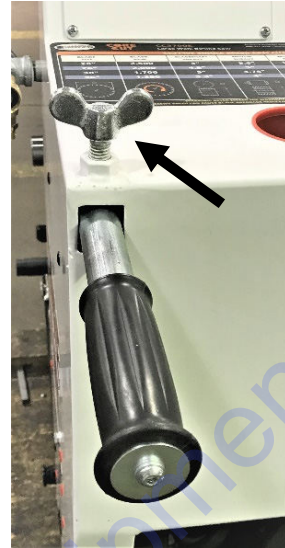

Handlebar and Lock Knob

5. Repeat steps 2 – 4 to secure the second handlebar. Adjust the handlebar orientation and length prior to operating the saw.

Control Grip Pushbuttons

The speed control lever pushbuttons allow the operator to raise and lower the machine.

Control Grip Pushbuttons

The control grip pushbuttons will work with the motor ON or OFF.



Control Grip Pushbuttons

OPERATING

1. Press the *Raise* (left) pushbutton to raise the saw and blade, and release to stop.

NOTE: Always raise the blade when maneuvering the saw to provide proper clearance between the blade and the ground.

2. Press the *Lower* (right) pushbutton to lower the saw and blade, and release to stop.

Blade Lowering Speed

The lowering speed of the saw can be adjusted using the flow control valve located near the hydraulic pump assembly inside the upright compartment. The flow control valve can be accessed through the hydraulic pump access plate.

1. Remove the four tap screws from the hydraulic pump access plate using a phillips head screwdriver and set aside.



Hydraulic Pump Cover Plate

2. The flow control valve can be accessed through the opening. Turn the knob clockwise to decrease the lowering speed or counterclockwise to increase the lowering speed.

NOTE: The valve does not adjust the blade's raising speed which is not adjustable.



Flow Control Valve

3. Once the lowering speed is set, replace the hydraulic pump cover and secure using the four tap screws.

Panel Mounted Speed Control Valve (Optional)

An optional panel mounted speed control valve is available to allow for lowering speed adjustment without having to remove the hydraulic pump cover

Turn the panel mounted valve handwheel, located on the lower right corner of the control panel, clockwise to decrease the blade's lowering speed and counterclockwise to increase the blade's lowering speed.

NOTE: The valve does not adjust the blade's raising speed which is not adjustable.



Blade Lowering Speed Valve (Optional)

Speed Control Lever

The speed control lever moves the saw forward and backward at up to 200 ft/min.



Speed Control Lever

Forward Control

Push the speed control lever forward to the desired travelling speed. The maximum forward speed the saw will move is approximately 200 ft./min.

Reverse Control

Pull the speed control lever backward to the desired travelling speed. The maximum reverse speed the saw will move is approximately 200 ft./min.

Blade Guard

WARNING

DO NOT operate the saw with the blade guard raised or removed.

DO NOT remove the blade guard with the motor running.

Blade exposure should not exceed 180° while cutting.

Always pivot the front of the blade guard 180° (fully upward) so the guard does not swing down unexpectedly, which may cause serious injuries.



Always secure the pivoted section of the blade guard using the detent pin (guards 26" and up).

When pivoting the front of the blade guard, raise/lower it cautiously and slowly to avoid serious injuries.

The blade guard shields the blade and must always be in place when operating the saw. Blade guards generally stay in place at all times, except for when changing to another guard size or when using the guard on the opposite side of the saw. Regularly inspect the blade guard and water tubes. Clean, repair, or replace dirty or damaged components immediately.

NOTE: Always use a guard size that matches the blade size. Refer to the parts list for additional information.

Installing the Blade Guard

Always install the blade guard with the blade off the saw.

1. Holding the blade guard handle, face the front of the blade guard forward and fit the tapered mount on the side of the guard onto the tapered mount on the frame.

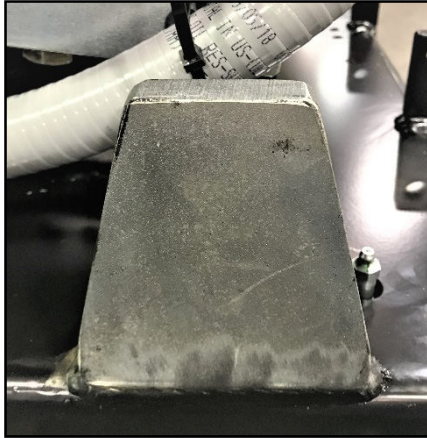

Frame Base Tapered Mount

2. Insert the lock pin through the hole on the tapered frame mount to secure the guard.
3. On the 30" and 36" guards (single speed saw only), secure the blade guard brace to the guard (near the top of guard) and to the frame base.
4. For guards 36" and larger, place a lock washer and then a flat washer onto the blade guard screw. Fit the screw through the slot near the back of the guard and through the hole on the frame base, and secure the guard to the frame using the provided wrench.
5. Connect the water supply hose to the blade guard water manifold.

Removing the Blade Guard

Always remove the blade guard with the blade off the saw.

1. Disconnect the water supply hose from the blade guard water manifold.
2. For guards 36" and larger, remove the rear bolt from the blade guard and frame base.
3. For 30" and 36" guards (single speed saw only), remove the blade guard brace.
4. Remove the lock pin from the tapered frame mount.
5. Use the handle on the blade guard to rock the guard back and forth while lifting the guard off the tapered frame mount.

Flange Guard

Install the flange guard over the blade flange that is not in use.

Installing the Flange Guard

1. Fit the tapered mount on the back of the flange guard onto the tapered mount on the frame.
2. Insert the lock pin through the hole on the tapered frame mount to secure the guard.



Flange Guard with Blade Shaft Bolt

3. Insert the blade shaft bolt that is not in use into the bolt retaining tube located on the top of the shaft guard.
4. Secure the bolt in place using the supplied wing nut.

Removing the Flange Guard

1. Remove the lock pin from the tapered frame mount.
2. Remove the flange guard from the tapered frame mount.
3. Reinstall the blade shaft bolt into the blade shaft.

Diamond Blades

⚠ WARNING

DO NOT exceed the blade's maximum recommended speed when cutting. Excessive blade speeds can cause blade breakage, resulting in serious injuries and/or death.

DO NOT use damaged blades when cutting to avoid harming yourself, others, or the saw.



OPERATING

Using the proper blade (size and type) preserves the blade and improves efficiency, resulting in lower costs. Refer to the Association of Equipment Manufacturers (AEM) safety brochure for diamond blades and www.discount-equipment.com for additional blade information.

Inspecting the Blade

Inspect each blade prior to installation and discard all damaged blades. Inspect the blades for:

- Cracks, nicks, and dents
- A damaged/deformed arbor (center hole)
- Darkness/discoloration near edge of blade
- A deformed blade circumference
- Segment loss/cracks
- Core wear
- Bending
- Uneven side-widths

Blade Speed

Refer to the RPM Charts (located in Appendix B at the end of this manual), the blade, or the blade packaging information for the recommended blade speeds when cutting. DO NOT exceed the maximum recommended blade speed. DO NOT use a blade for cutting that requires a lower speed than the minimum blade shaft speed.

Single Speed Saws

For all single speed saws, refer to the CC3700E Single Speed Parts List Manual for the proper belt drive configuration for all blade sizes.

3-Speed Saws

For all 3-speed saws, refer to the CC3700E-3 Parts List Manual for the proper belt drive configuration for all blade sizes.

Shifting 3-Speed Gearbox Transmission

Refer to the RPM Chart located in Appendix B at the end of this manual for the proper gear position of the 3-speed gearbox transmission for all blade sizes.



WARNING

DO NOT attempt to shift the 3-speed gearbox while the motor is running.

1. Stop the motor by pressing the STOP button located on the top of the starter box assembly.
2. Lift up on the gearbox shift lever and move it to the proper gear position slot. From left to right, Low, High, Medium marked L, H, and M.

NOTE: Using a wrench to rotate the blade shaft in either direction will help in moving the shift lever from side to side.

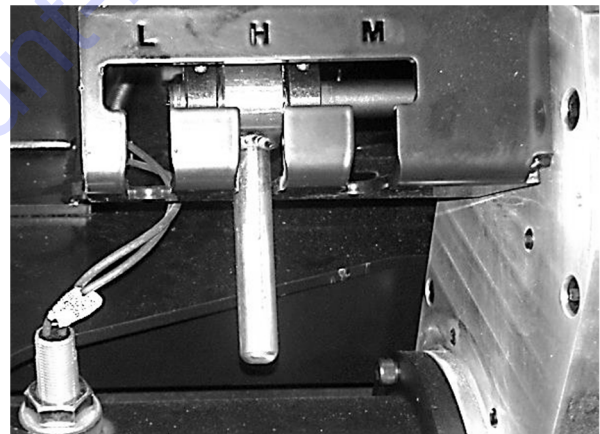

Gearbox Shift Lever

Wrench

Use the wrench provided when installing or removing a blade. Apply force to the opposite end of the wrench and tighten the blade shaft bolt/screw to 125 ft-lb (170 Nm) minimum to secure the outer flange and blade.

NOTE: 125 ft-lb is equivalent to applying 125 pounds at the end of a 12" wrench.

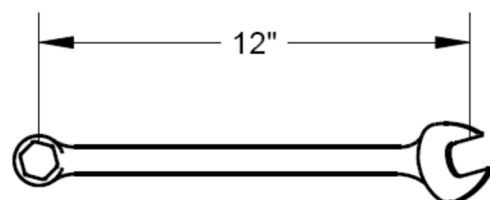

Wrench

Installing the Blade

WARNING

DO NOT install a blade with the motor running.

Failure to properly secure the outer flange and blade may cause parts to loosen or fall off the saw, resulting in serious injuries or death!

DO NOT pivot the front of the blade guard up or down when installing very large blades. Attempting to pivot the front of a heavy guard when the guard is positioned higher up for blade installation makes the guard difficult to lift and/or lower. In this situation, remove the blade guard front instead of pivoting it.

Always secure the pivoted section of the blade guard using the detent pin.

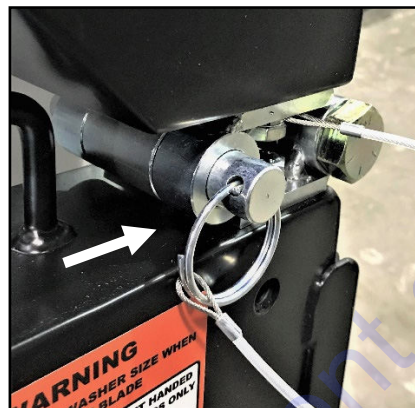

Detent Pin with Guard Fully Upward

3. On the pivoted guards, insert the detent pin through the interlocking barrels on the top of the guard to secure the front of the guard.

CAUTION

Wear gloves and be alert to the surrounding environment when handling blades.

WARNING

Failure to fully pivot and secure the front of the guard may cause serious injuries.

NOTE: When changing blade sizes, ensure to adjust and/or change all necessary belt drive components in accordance with the CC3725E/CC3730E/CC3740E or the CC3700E-3 Parts List.

The blade can be installed on the right or left side of the saw. Install the blade on the side preferred or most appropriate for the cutting task.

1. Select a blade size and type. Remember to check the blade for damages and discard as necessary.
2. Remove the detent pin (guards 26" and larger) from the front guard and pivot the front of the blade guard 180° (fully upward) to gain access to the blade flanges.

4. Remove the blade shaft bolt.
5. Carefully remove the outer flange. Inspect the flange assembly and clean or replace dirty/damaged components.
6. Align and fit the outer flange and flange pin through the blade.
7. Place the blade and outer flange into the alignment hole and blade arbor of the inner flange. For large blades, carefully roll the blade up to the inner flange. Adjust the height of the saw to align the flange and blade arbor.

NOTE: Point the arrow stamped on the blade in the direction of the blade shaft's rotation.

NOTE: The outer flange should fit snug with the blade, inner flange, and blade shaft.

TO PURCHASE THIS PRODUCT PLEASE CONTACT US



**Equipment Financing and
Extended Warranties Available**



**Discount-Equipment.com is your online resource for
commercial and industrial quality parts and equipment sales.**

561-964-4949

visit us on line @ www.discount-equipment.com

Select an option below to find your Equipment

Search by Manufacturer

Search by Product Type

Request a Quote

We sell worldwide for the brands: Genie, Terex, JLG, MultiQuip, Mikasa, Essick, Whiteman, Mayco, Toro Stone, Diamond Products, Generac Magnum, Airman, Haulotte, Barreto, Power Blanket, Nifty Lift, Atlas Copco, Chicago Pneumatic, Allmand, Miller Curber, Skyjack, Lull, Skytrak, Tsurumi, Husquvarna Target, Stow, Wacker, Sakai, Mi-T-M, Sullair, Basic, Dynapac, MBW, Weber, Bartell, Bennar Newman, Haulotte, Ditch Runner, Menegotti, Morrison, Contec, Buddy, Crown, Edco, Wyco, Bomag, Laymor, EZ Trench, Bil-Jax, F.S. Curtis, Gehl Pavers, Heli, Honda, ICS/PowerGrit, IHI, Partner, Imer, Clipper, MMD, Koshin, Rice, CH&E, General Equipment, Amida, Coleman, NAC, Gradall, Square Shooter, Kent, Stanley, Tamco, Toku, Hatz, Kohler, Robin, Wisconsin, Northrock, Oztec, Toker TK, Rol-Air, APT, Wylie, Ingersoll Rand / Doosan, Innovatech, Con X, Ammann, Mecalac, Makinex, Smith Surface Prep, Small Line, Wanco, Yanmar

9. Slightly rotate the outer flange and blade in the opposite direction of the blade rotation to eliminate backlash (looseness) between parts.
10. Place the wedge lock washer onto the blade shaft bolt and insert the bolt into the blade shaft through the center of the outer flange.
11. Tighten the bolt by hand. Slowly lower the saw, if necessary, until the blade just touches the ground.
12. Tighten the bolt again, using the wrench, to 125 ft-lb (170 Nm) minimum to secure the outer flange and blade.
13. Remove the detent pin from the guard hinge and pivot the front of the guard down over the blade to secure.

Removing the Blade



CAUTION



DO NOT remove a blade with the motor running.

DO NOT pivot the front of the blade guard up or down when removing very large blades. Attempting to pivot the front of a heavy guard when the guard is positioned higher up for blade removal makes the guard difficult to lift and/or lower. In this situation, remove the blade guard front instead of pivoting it.

Always secure the pivoted section of the blade guard using the detent pin (guards 26" and up).

1. Remove the detent pin (guards 26" and larger) from the guard hinge and pivot the front of the blade guard 180° (fully upward) to gain access to the blade
2. On the pivoted guards, insert the detent pin through the interlocking barrels on the top of the guard to secure the front of the guard.



WARNING

Failure to fully pivot and secure the front of the guard may cause serious injuries.

3. Slowly lower the saw, if necessary, until the blade just touches the ground.
4. Remove the blade shaft bolt using the wrench.
5. Carefully remove the outer flange and blade. Place the blade in an appropriate storage location.

NOTE: If the outer flange is difficult to remove, tighten screws into two of the holes on the outer flange to help separate the outer flange from the blade.

6. Inspect the flange assembly and clean or replace dirty/damaged components.
7. Carefully fit the outer flange back into the inner flange and/or blade shaft.
8. Place the wedge lock washer onto the blade shaft bolt and insert the bolt into the blade shaft through the center of the outer flange.
9. Retighten the blade shaft bolt to secure the flanges.
10. Remove the detent pin (guards 26" and larger) from the guard front and pivot the front of the guard down over the blade flanges to secure.

Motor

The CC3700E saw family has three horsepower options and two voltage options:

- 25HP, 30HP, and 40HP
- 230/460V and 575V

Starter Box Assembly

All motors are controlled through a starter box assembly. The starter box assembly allows the operator the ability to start and stop the motor, Disconnect the motor from the power source, and provides visual indication of battery charge and amperage.

Optional Soft Start Box Assembly

There is an optional soft start box available that provides the same controls as the standard starter box except that it reduces the load and torque in the power train during startup. This reduces the mechanical and electrical stresses on the saw to increase its effective lifespan.

DC Travel Drive Starter Box Assembly

An optional starter box is available for the DC travel drive option that provides the same controls as the standard with a few additional. There is selector switch to enable the DC travel motor. There is also an alarm that will sound when the saw is in the DC travel mode. (See “DC Travel Mode” section for further information)



WARNING

DO NOT leave the saw unattended while the motor is running.

Overload Protection

All starter box assemblies are equipped with current overload protection. The overload set points are based on the full load amps that are shown on the motor’s nameplate and are set, using a dial on the overload relay, by the OEM. The amp settings are listed in the table below.

HP	Voltage	Amp Setting
25	230	58.5
25	460	29.3
25	575	23.6
30	460	39
30	575	29
40	460	48
40	575	37



WARNING

DO NOT reset the overload set point to a higher am setting as tis may damage the motor.

Tasks Prior to Starting the Motor

Complete the tasks listed below prior to starting the motor to ensure a safe start:

- Turn off controls and switches.
- Remove tools from area.

Do Not start the motor unless the following tasks are completed:

- Place speed control lever to the STOP position.
- Pull up emergency stop button.
- Disengage the transmission.
- Move the motor disconnect switch, located on the starter box, to ON.

Starting the Motor

1. Press the START button locate on the top of the motor control box.
2. Allow the motor to come up to full operating speed.

Stopping the Motor

NOTE: In an emergency, press the STOP button to immediately stop the motor and any saw movement.



CAUTION

DO NOT leave the saw unattended until the motor is off and the blade has stopped spinning.

1. Place the speed control lever to the STOP position and raise the blade from the cut.
2. Turn off all controls, switches, and water.
3. Press the STOP button.
4. When the motor has stopped completely, pull the STOP button up to reset.

Transmission Lever

Disengage the transmission prior to starting the motor to prevent unnecessary saw movement.



Transmission Lever

Engaging the Transmission

1. Place the speed control lever into the STOP position.
2. Press the START button on the control box.

3. Move the transmission lever out of the DISENGAGE slot.
4. Push the lever forward and place it in the ENGAGE slot.

Disengaging the Transmission

1. Place the speed control lever into the STOP position.
2. Move the transmission lever out of the ENGAGE slot.
3. Pull the lever back and place it in the DISENGAGE slot.

DC Travel Mode (Optional)

The DC travel option is available to allow the operator to move the saw without having the blade spinning.

Starting the DC Travel Option

1. Ensure the motor is turned OFF.
2. Lift up on the STOP button located on the starter box
3. Place the speed control level in the STOP position.
4. Engage the transmission using the transmission lever.
5. Place the DC travel switch into the ENABLE position.



DC Travel Selector Switch and Alarm

6. Press the green START button located on the starter box.

NOTE: An alarm will sound alerting personnel that the saw is in the DC travel mode.

7. Push forward or pull back on the speed control lever to move the saw in the desired direction.

Stopping the DC Travel Option

1. Push down on the STOP button located on the starter box.
2. Place the speed control lever into the STOP position.
3. Place the DC travel switch to the OFF position.

Water Supply

The water supply directs cooling water to the blade and minimizes dust when cutting.

NOTE: Always test the water supply for adequate pressure and flow prior to cutting.

Single Speed Operation

There are two water flow control valves associated with the saw. One on the left side of the upright assembly and one on the right side. When cutting on the right side of the saw, ensure the left side water flow control valve is closed and when cutting on the left, ensure the right side water flow control valve is closed.



Water Supply Fitting and Left Water Flow Control Valve



Right Water Flow Control Valve

1. Ensure that the left and right water flow control valves are closed.
2. Connect the water source hose to the water supply fitting located on the left side of the saw.
3. Connect the blade guard supply hose to the water flow control valve.

OPERATING

NOTE: If cutting on the right side of the saw, attach the hose to the right side water flow control valve. If cutting on the left side of the saw, attach the hose to the left side water flow control valve.

4. Connect the other end of the blade guard supply hose to the blade guard water manifold.
5. Turn the water on from the source.
6. Slowly open the appropriate water flow control valve to begin flow to the blade guard. Continue opening the valve until adequate pressure and flow is attained.

NOTE: Open the water supply valve just prior to cutting.

7. The saw is now ready to begin cutting.
8. When cutting is complete, close the water flow control valve to stop the water flow.
9. Turn the water off at the source.
10. Disconnect the water source hose from the water supply fitting.

Three Speed Operation

There are two water flow control valves associated with the saw. One on the left side of the upright assembly and one on the right side. When cutting on the right side of the saw, ensure the left water flow control valve is closed and when cutting on the left, ensure the right water flow control valve is closed.



Water Supply Fitting and Left Water Flow Control Valve



Right Water Flow Control Valve

1. Ensure that the left and right water flow control valves are closed.
2. Connect the water source hose to the water supply fitting located on the left side of the saw.
3. Connect the 3-speed gearbox supply hose to the water flow control valve.

NOTE: If cutting on the right side of the saw, attach the hose to the right side water flow control valve. If cutting on the left side of the saw, attach the hose to the left side water flow control valve.

4. Connect the blade guard supply hose, from the 3-speed gearbox, to the blade guard water manifold.
5. Turn the water on from the source.
6. Slowly open the appropriate water flow control valve to begin flow to the blade guard. Continue opening the valve until adequate pressure and flow is attained.

NOTE: Open the water supply valve just prior to cutting.

7. The saw is now ready to begin cutting.
8. When cutting is complete, close the water flow control valve to stop the water flow.
9. Turn the water off at the source.
10. Disconnect the water source hose from the water supply fitting.

Water Pump (Optional)

The water pump directs cooling water to the blade and minimizes dust when cutting.

1. Ensure all water supply lines are connected.
2. Ensure that the water valve located on the control panel is in the “OFF” position.
3. Turn on the water pump switch to start the pump. **DO NOT** start the water pump until just before cutting. **DO NOT** leave the water pump on when the cutting task is complete to avoid draining the battery.
4. Push the water valve to the “ON” position. The water will not flow to the blade until the blade is zeroed and lowered into the cut.
5. When cutting is complete, move the water valve to the “OFF” position.
6. Turn off the water pump switch OFF to stop the pump.

Cutting

Cutting Guides

Use the cutting guides as needed to help follow the cutting line. Always check the cutting guides for proper alignment with the blade prior to cutting.

Adjusting the Front Pointer

1. Remove the lanyard from the cable cleat.
2. Lower the front pointer frame to the ground.
3. Loosen both front pointer frame screws.
4. Divide an 8–10 ft. piece of string in half.
5. Place the looped end of string into a gullet on the backside of the blade.
6. Place one string line up against the backside of the blade and one string line up against the front side of the blade. Holding the string ends in one hand, tension the lines out toward the front pointer rod.

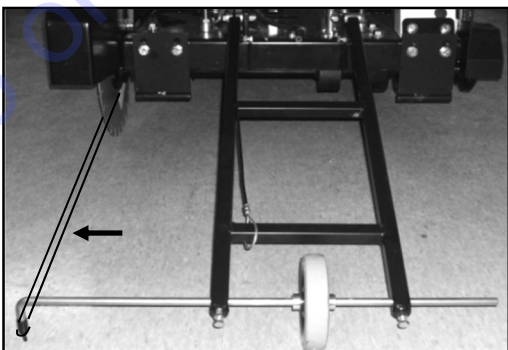

Tensioned String Line

7. Adjust the pointer rod to place the tip between the tensioned string lines.
8. Retighten both front pointer frame screws.
9. Lift the frame off the ground when finished.
10. Tension the lanyard and secure it to the cable cleat.

Adjusting the Rear Pointer(s)

1. Loosen the rear pointer nut and screw on the back of the frame base.
2. Adjust the orientation of the rear pointer rod and retighten the screw and nut to secure.

Straight Line Cutting



WARNING



DO NOT expose yourself or anyone else to the direct line of the blade when operating the saw. The direct work area should not contain buried or embedded electrical, gas, or water lines that could be damaged and/or cause personal injury while cutting.

NOTE: Always raise the blade to provide proper clearance between the blade and the pavement when maneuvering the saw.

Helpful Hints Prior to Cutting

Keep the following in mind for better efficiency while cutting:

- Use just enough handle pressure to guide the saw down the cutting line. **DO NOT** forcibly direct (twist) the saw from side to side when cutting. **DO NOT** jam, cock, or wedge the blade in a cut.
- Moving too quickly when cutting may stall the saw, or may cause the blade to climb out from the cut. If the saw stalls while cutting, put the saw in neutral and raise the blade from the cut to restart the motor.
- Avoid sawing excessively deep to preserve the blade and reduce sawing costs.
- **DO NOT** lower the blade too quickly or move the saw forward too quickly when finishing a partial-cut to avoid forcing the blade into the concrete.
- Always have a proper water flow when cutting for maximum blade efficiency. Using too much water when cutting will make the

slurry look clear. Not using enough water will make the slurry look thick and pasty.

- Refer to the Diamond Products' Guide for Professional Concrete Cutters for additional cutting tips and information.

Tasks Prior to Cutting

Complete the following tasks prior to cutting:

- Ensure the blade size is correct for the belt drive configuration.
- Align the cutting guide(s) with the blade.
- Clearly mark the cutting line.
- Turn off all electricity, gas, and water around the direct work area.

Making a Cut without Using the Blade Depth Stop

1. Align the blade and cutting guide(s) with the cut line.
2. Turn on the water and adjust the water flow by moving the water flow control valve handle in-line with the water hose.
3. Press the START button on the motor control box and allow the motor to come up to speed.
4. Lower the blade to just above the cutting surface and zero the blade by turning the cutting depth indicating dial on the control panel to 0".
5. Slowly lower the blade into the surface to no more than 2" deep. Make the initial pass across the entire cutting line using the most effective travel speed. If the blade is coming up out of the cut, decrease travel speed and/or feed depth. **DO NOT CUT FULL DEPTH IN ONE PASS.**
6. If you are cutting more than 2" deep, you can finish the job in less time and effort by step cutting in 2" increments. Cut a 2" depth on the initial pass, 4" depth on the second and so on. On repeated passes, the blade will tend to follow the previous cut.
7. Raise the blade out of the cut and reposition the saw at the start of the cut line. DO NOT move backwards with the blade in a previous cut.
8. At the start of the cut line, lower the blade back into the cut and make a second, deeper pass across the entire cutting line.

9. Continue the step-cut process to reach the maximum depth. DO NOT cut any deeper than required.

Making a Cut Using the Blade Depth Stop

1. Align the blade and cutting guide(s) with the cut line.
2. Turn on the water and adjust the water flow by moving the water flow control valve handle in-line with the water hose.
3. Press the START button on the motor control box and allow the motor to come up to speed.
4. Lower the blade to just above the cutting surface and zero the blade by turning the cutting depth indicating dial on the control panel to 0".
5. Slowly lower the blade into the surface to no more than 2" deep and turn the depth stop knob clockwise until resistance is felt, which means the cutting depth is set.
6. Make the initial pass across the entire cutting line using the most effective travel speed. If the blade is coming up out of the cut, decrease travel speed and/or feed depth. **DO NOT CUT FULL DEPTH IN ONE PASS.**
7. If you are cutting more than 2" deep, you can finish the job in less time and effort by step cutting in 2" increments. Cut a 2" depth on the initial pass, 4" depth on the second and so on. On repeated passes, the blade will tend to follow the previous cut.
8. Raise the blade out of the cut and reposition the saw at the start of the cut. DO NOT move backwards with the blade in a previous cut.
9. Turn the depth stop knob counter-clockwise to increase the cutting depth.
10. Slowly lower the blade into the cut until the desired depth is reached and then turn the depth stop control knob clockwise until resistance is felt.
11. Continue the step-cut process using the depth stop to reach the maximum depth. DO NOT cut any deeper than required.

Continuing a Partial-Cut

1. Maneuver the saw to the desired location.
2. Align the blade with the previous cut and slowly lower the blade back into the concrete. Use extreme caution to make sure the blade is perfectly aligned within the cut. DO NOT continue cutting until the blade is aligned within the cut!
3. Continue the step-cut process (using the blade depth stop if preferred) to reach the maximum depth. DO NOT cut any deeper than required.

Finishing a Cut

1. Place the speed control lever at **STOP**.
2. Raise the blade from the cut (provide proper ground clearance).
3. Turn off the water flow control valve.
4. Press the STOP button on the motor control box.

Drive Alignment

Adjusting the Drive Alignment

Adjust the rear axle when the saw's drive alignment is off (saw will not cut in a straight line).



Rear Axle Bearing Screws and Adjustment Bolt

1. Loosen the two left rear axle bearing screws.
2. Loosen the hex nut on the rear axle adjustment bolt.

3. Turn the adjustment bolt clockwise to adjust the drive alignment toward the left, or counterclockwise to adjust the drive alignment toward the right.
4. Retighten the hex nut on the adjustment bolt.
5. Retighten the two left rear axle bearing screws.

Spotlight

1. Loosen both spotlight bar lock knobs and slide the spotlight bar from side-to-side to adjust the length of the bar.
2. Tighten the lock knobs to secure.
3. Turn the spotlight switch on or off as needed for additional lighting.

Parking Brake (Optional)

The parking brake keeps the saw from moving forward or backward unintentionally and is generally used on steeper slopes and hills.

Engaging the Parking Brake

Slide the brake lever over and out of the DISENGAGE slot and down into the ENGAGE slot.

Disengaging the Parking Brake

Slide the brake lever over and out of the ENGAGE slot and up into the DISENGAGE slot.

Maintenance

General

Failure to read and comply with the maintenance instructions provided in this manual prior to performing maintenance may result in serious injuries and/or death, and may harm the saw. DO NOT attempt to perform maintenance on the saw if you are not properly trained for it, or are not supervised by an experienced person.

Refer to the CC3700 Parts List for additional information and part diagrams when performing maintenance tasks. Refer to the motor manufacturer as the primary source for all safety, operations, and maintenance instructions for the motor. Contact Discount-equipment with any additional questions.

Remove all necessary guards and access panels prior to servicing the saw. Replace prior to operating.

Pre Maintenance Preparations

- Ensure the saw is in a safe area to conduct maintenance.
- Maintain proper cleanliness of the work area to minimize personnel injury or equipment damage.
- Ensure the saw is sufficiently cool to conduct any maintenance.
- Remove the cutting blade prior to starting any maintenance.
- Place the saw on a level surface with the motor turned off and the disconnect switch in the OFF position.
- Ensure there is adequate lighting in the work area to ensure safety.
- Ensure all equipment and tools required for the maintenance task are staged and available for use.

- Prior to any maintenance being performed, know the locations of all safety equipment such as fire extinguishers, first aid kits, etc.
- All maintenance shall be performed by qualified personnel only.

Rear Cover Screen

The rear cover screen is a versatile component in regards to maintenance of the machine. It can be removed to gain access to components within the upright assembly.

General Cleaning

The saw must be cleaned after each use and prior to conducting any maintenance. Ensure that the saw is cool prior to cleaning. Ensure affected electrical equipment is properly covered or de-energized prior to cleaning with water or air.

Cleaning Techniques

Various cleaning options can be utilized depending on the type of cleaning required. High pressure washers and a mild detergent will work the best. Compressed air and low pressure water can also be utilized where required.



CAUTION
Care must be taken when using high pressure water and compressed air to conduct any maintenance or cleaning. High pressure water and compressed air can cause injury to personnel or damage to equipment if not used properly.

Control Panel

Do not spray water on the starter box panel to clean. Use a damp cloth or compressed air to clean electrical components. Dry the starter box panel after cleaning.

Motor

Use a mild detergent and water to clean the motor. Do not spray water forcefully on the motor to prevent damage to components.

Part Lubrication



Lubricate all necessary parts on schedule for maximum saw efficiency. Occasionally lubricate controls, cables, hinges, latches, and linkages with a spray lubricant when movement becomes stiff and/or sluggish. Use one to two full pumps of NLGI No. 2 premium, lithium-based grease when lubricating all grease fittings.

NOTE: Use more grease on bearing grease fittings if they are too hot to touch after completing work.

Post Cleaning

- Lubricate the machine as required.
- Dry all electrical components using compressed air.
- Do not start the machine until it has had time to thoroughly dry.

To order go to Discount-Equipment.com

MAINTENANCE

Service Schedule

The service schedule is based primarily on the standard operating time of the machine. The frequency of the maintenance tasks can be increased based on the working environments of the machine.

Task	Cycle		
	Daily	25 Hrs.	50 Hrs.
Visually inspect saw for damage and repair as necessary	X		
Wipe down and clean all components for dust, debris, and slurry	X		
Check that all safety guards are in place and in good operating condition	X		
Check for loose or frayed wiring. Repair/replace as necessary	X		
Check for loose nuts and bolts and retighten	X		
Inspect all hoses and clamps for damage, leaks, or looseness and repair/replace as necessary	X		
Check hydraulic fluid level	X		
Check and clean blade guard water spray tubes	X		
Lubricate blade shaft bearings (End of work day)	X ¹		
Inspect all belts for tension or wear and re-tension or replace as necessary		X	
Lubricate front axle pivot bearings			X

1 - Single speed saw

Daily Service

Hydraulic System

⚠️ WARNING

Always place a piece of cardboard or paper up against hydraulic components, or use a leak detection fluid to check for hydraulic fluid leaks. Keep all body parts away from leaks and/or areas that may eject hydraulic fluid. Pressurized hydraulic fluid can penetrate the skin, causing serious injuries. Seek medical attention immediately!

Always make sure any hydraulic components being serviced are not supporting the weight of other saw components. If a particular component is under pressure when connections points are loosened, oil may spray out forcefully.



Inspect all hydraulic hoses and fittings daily for leaks. Remember to use cardboard or a piece of paper when checking for leaks and replace damaged components immediately.

Adding Fluid to the Hydraulic Lift Pump

Check the fluid daily and add fluid to the pump as necessary.

1. Lower the saw to level the frame.
2. Remove the hydraulic pump cover plate.
3. Remove the hydraulic pump breather cap.
4. Using a funnel add Dexron 3 automatic transmission fluid or equivalent to just below where the fill port extends into the hydraulic pump. Do not overfill, as this will cause oil leakage through the breather cap when raising the saw.
5. Replace the breather cap and retighten to secure.
6. Replace the hydraulic pump cover plate.

Check and Clean Blade Guard Spray Tubes

1. Raise the front of the blade guard and pin it in place using the hinge detent pin.
2. Connect a water supply source to the water manifold on the blade guard.

3. Turn the water supply on and verify that water is spraying from all spray tube holes.
4. If any clogged holes are detected, shut off water source and dislodge any debris that is clogging the hole(s).
5. Turn water on to verify all spray tubes are clear.
6. Shut off water supply and disconnect from the water manifold.
7. Pull the detent pin on the blade guard hinge and lower the front of the guard back down.
8. Replace detent pin.

Lubricate the Blade Shaft Bearings (Single Speed Saws Only)

At the end of each work day, lubricate the two front blade shaft bearings (Single Speed Saws Only).

1. Locate the right and left blade shaft bearing grease fittings located on the frame base at the front of the saw.
2. Add no more than two pumps of bearing grease into each of the two blade shaft bearing grease fittings.



Right and Left Blade Shaft Bearing Grease Fittings

25 Hour Service

Inspect Belts

Inspect all belts daily or every 25 hours for tension or wear. Re-tension or replace as required in accordance with the “Blade Drive Belts” sections located in the “Regular Maintenance” section of this manual.

50 Hour Service

Lubricate Front Axle Bearings

1. Raise the saw to the full up position.
2. Add no more than two pumps of grease to each of the two front axle bearings grease fittings located under the frame base on both the left and right side.

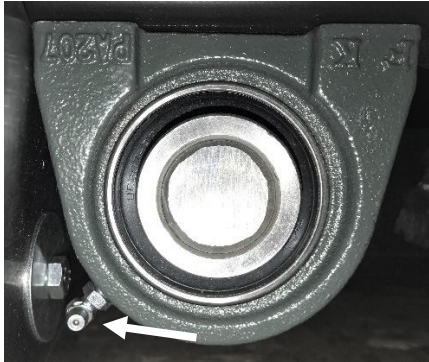

Front Axle Bearing Grease Fitting

Regular Maintenance

Belt Tensioning

Inspect all belts daily for fraying, stress cracks, and/or breakage and replace immediately when damaged. Always re-tension new belts after the first four hours of use. **DO NOT** exceed the manufacturer's recommended belt tension settings when tensioning belts.

NOTE: Over-tensioning belts may damage the motor. Under-tensioning belts may cause slippage, shorter belt life, and/or poor saw performance. Squealing belts indicate looseness.

Tensioning the Drive Belts

1. Loosen the four motor mount bolts.
2. Loosen the nut on both blade drive belt tension bolts.

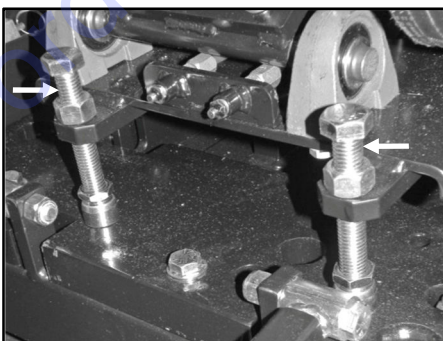

Belt Tension Bolt

3. Turn both blade drive belt tension bolts (large threaded bolts on motor base) clockwise equally to tighten the belts (if tensioning belts only. Test the belt tension and readjust the bolts as necessary.
4. Tighten the nut on both blade drive belt tension bolts.
5. Retighten the four motor mount bolts.

Replacing the Drive Belts

1. Loosen the four motor mount bolts.
2. Loosen the nut on both blade drive belt tension bolts.
3. Turn both blade drive belt tension bolts (large threaded bolts on motor base) counterclockwise to loosen the belts.

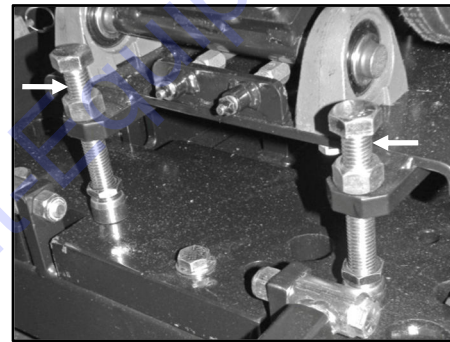

Belt Tension Bolt

4. Remove the belts from the motor and blade shaft sheaves.
5. Install and align a new belts around the motor and blade shaft sheaves.
6. Turn both blade drive belt tension bolts (large threaded bolts on motor base) clockwise equally to tighten the belts.
7. Test the belt tension and readjust the bolts as necessary.
8. Tighten the nut on both blade drive belt tension bolts.
9. Retighten the four motor mount bolts.

Drive Belt Sheaves

The motor and/or the blade shaft sheaves may need to be changed when changing the blade size. Refer to the *appropriate CC3700E Parts List manual* and the *RPM and Blade Size Conversions Charts* in Appendix B at the end of this manual for additional information.

NOTE: All belts must be removed prior to changing the sheaves.



WARNING

Disconnect power to the motor prior to servicing any belts and sheaves. Use extreme caution when working with rotating machine parts to avoid entanglement.



CAUTION

Let the belts cool down prior to servicing them.

Removing the Set Screw Style Sheave

1. Loosen the four set screws from the sheave, two on the key and two 120° from the keyway, using an Allen wrench or hex key.
2. Pull the sheave from the motor shaft.

Removing the Taper Style Sheave

1. Remove the two set screws from the sheave bushing.
2. Place one of the set screws into the third threaded hole (in line with the slot) on the bushing. Using an Allen wrench or hex key, tighten the set screw into the hole to separate the sheave from the bushing.
3. Remove the sheave from the bushing and pull the entire assembly from the motor shaft.

Removing the Quick Disconnect (QD) Style Sheave

1. Remove the three cap screws from the bushing using a socket wrench.
2. Place the three cap screws into the three threaded holes on the bushing. Tighten the cap screws using a socket wrench to separate the sheave from the bushing.
3. Remove the sheave from the bushing and pull the entire assembly from the motor shaft.

Installing the Set Screw Style Sheave

1. Fit the appropriate size sheave onto the motor shaft. *Refer to the RPM and Blade Size Conversion charts in Appendix B at the end of this manual and the appropriate CC3700E Parts List for additional information.*

2. Place a straight edge against the blade shaft sheave and the motor sheave to align the two sheaves.
3. On the set screw style sheave, tighten the four set screws.

Installing the Taper Style Sheave

1. Fit the appropriate size sheave onto the taper bushing. *Refer to the RPM and Blade Size Conversion charts in Appendix B at the end of this manual and the appropriate CC3700E Parts List for additional information.*
2. Place a straight edge against the blade shaft sheave and the motor sheave to align the two sheaves.
3. Place the two set screws into the set screw holes (in line with each other) and tighten the set screws to secure.

Installing the Quick Disconnect (QD) Style Sheave

1. Fit the appropriate size sheave onto the QD bushing. *Refer to the RPM and Blade Size Conversion charts in Appendix B at the end of this manual and the appropriate CC3700E Parts List for additional information.*
2. Place a straight edge against the blade shaft sheave and the motor sheave to align the two sheaves.
3. For the QD style bushing, move the sheave away from the bushing just enough to tighten the set screw onto the shaft key.
4. Place the three cap screws into the unthreaded holes of the sheave and tighten them into the QD bushing to secure.

Motor



WARNING

Let the motor cool down prior to servicing the saw.

DO NOT service the saw with the motor running (unless stated otherwise).



Refer to the motor manual and manufacturer for a full motor maintenance schedule and additional motor maintenance information.

Disconnecting the Power to the Motor

Whenever maintenance is being conducted on the saw, disconnect the power to the motor. There is a power disconnect switch located on the starter box door panel.

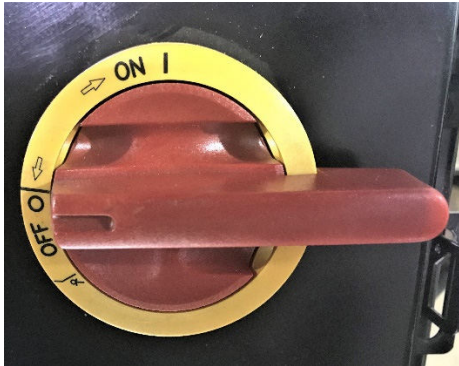

Power Disconnect Switch

To disconnect:

- Move the power disconnect lever to the OFF position.

To connect:

- Move the disconnect lever to the ON position

Battery



WARNING

Ignitable explosive gases are emitted from the battery. DO NOT expose the battery to sparks or open flames, and keep the area around the battery well-ventilated.



Disconnect the battery prior to servicing the saw (unless stated otherwise).

Always keep the battery cable clamps away from the battery terminals when the battery is disconnected to avoid accidental connections while servicing.



Always be sure to connect the battery cables to the proper terminal when reconnecting.



CAUTION

Use a proper battery tester when testing the battery strength.

Use protective eyewear or a face shield and avoid contact with the skin when handling/servicing the battery.

The saw contains a charged battery with one positive cable lead and one negative cable lead. To power the hydraulic lift pump. The battery can be accessed by removing the rear cover screen.



Battery

Battery Type

12 Volt, Group 34

Servicing the Battery

1. Disconnect the negative cable lead from the negative terminal.
- NOTE: Always disconnect the negative cable first.*
2. Disconnect the positive cable lead from the positive terminal.
 3. Unsecure the battery from the hold-down bracket by removing the two lock nuts from the battery hold-down tie rods and lift the hold-down bracket off.

4. Carefully remove the battery from the battery tray.
5. When replacing the battery, carefully place a new battery into the battery tray. Bring the old battery to a recycling facility; many battery retailers also accept old batteries.
6. When cleaning the battery, inspect the terminals, clamps, and cables for damages and corrosion. Clean the terminals and clamps using a wire brush, or use another approved technique for cleaning. Use acid-free, acid-resistant grease to grease the battery clamps and terminals. Carefully place the battery back into the battery.

7. Reconnect the positive cable lead to the positive battery terminal.

NOTE: Always reconnect the positive cable first.

8. Reconnect the negative cable lead to the negative battery terminal.
9. Re-secure the battery to the hold down top brace by reinstalling the lock nuts onto the two tie rod bolts and tighten them to secure.

Inner Blade Flange

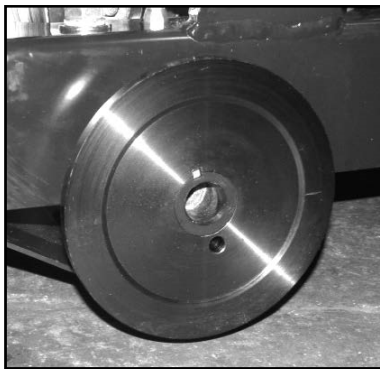

Inner Flange

Installing the Inner Blade Flange

1. Inspect the inner flange for damages. Clean or replace damaged components as necessary.
2. Align the flange with the blade shaft key and place the flange onto the blade shaft.
3. Apply Loctite 262 (red) or an equivalent to the setscrew threads.
4. Tighten the setscrew(s) into the back of the inner flange to secure.

Removing the Inner Blade Flange

1. Remove the setscrew(s) from the back of the inner flange using an Allen wrench.
2. Carefully remove the flange from the blade shaft.

Lifting and Transporting

Lifting



CAUTION

Always use a strap to lift the machine. Ensure the strap is rated high enough to handle the load.

1. Ensure the work area is clear of any obstructions and all personnel are at a safe distance prior to lifting the machine.
2. Using a properly rated strap, place the strap around the frame lift using a basket style hitch.
3. Slowly lift the machine only high enough to conduct the required work.

Transporting

Always secure the machine using tie down straps to avoid damage during transport.

NOTE: Never tow the machine as this may cause damage to the drive components.

Storing

Complete the tasks listed below prior to storing the saw for longer time frames:

- Turn off all switches and controls.
- Lower the saw completely to remove strain on the lifting mechanism.
- Clean and wipe down the saw to remove dust, debris, and slurry from saw components.
- Remove the battery and store in a proper location, out of reach from children.
- Refer to the motor manual for all motor recommendations prior to storing.
- Store the saw in a dry area, protected from outdoor elements and out of reach from children.

Disposal

Dispose of the saw when it's no longer repairable, and/or contains safety hazards not worth repairing or maintaining. Complete the tasks listed below when discontinuing usage:

- Remove the battery and bring to a recycling facility; many battery retailers also accept old batteries.
- Transport the saw to a salvage yard or recycling facility.

REFERENCES

Appendix A

Troubleshooting

Troubleshooting the CC9074 Deep Cut		
Symptom	Problem	Solution
1. Motor will not start.	Motor controller disconnect lever is OFF.	Switch disconnect lever to ON.
	Power source disconnected.	Connect power source.
	E-Stop is active.	Pull up emergency stop button.
2. Saw will not raise.	Worn out battery?	Charge or replace battery.
	Defective raise button?	Replace raise button.
	Low hydraulic fluid?	Check hydraulic fluid level and fill as necessary.
	Debris in lowering valve stem?	Inspect and clean stem.
3. Saw will not lower.	Worn out battery?	Charge or replace battery
	Defective valve coil?	Check for magnetism of valve stem when activated.
	Defective lowering button?	Replace lowering button.
	Depth stop set?	Reset depth stop.
4. Saw will not lower completely.	Skid plates in wrong set of holes?	Adjust skid plates to correct set of mounting holes.
5. Saw lowers too slow or too fast.	Improper lowering speed setting?	Adjust blade lowering speed valve.
6. Blade does not cut straight.	Drive alignment off?	Adjust rear axle adjustment bolt.
	Excessive force used when sawing?	Reduce forward speed. DO NOT twist blade from side to side.
	Wrong blade?	Contact Discount-equipment.
7. Short belt life.	Loose belts causing slippage?	Check and adjust belt tension.
	Sheaves misaligned?	Use straightedge to check blade shaft sheave alignment. Adjust as necessary.
	Worn sheave grooves?	Check for groove wear and replace sheaves when necessary.

REFERENCES

Appendix B

CC3700E Single Speed RPM Charts

WARNING: Do not exceed blade speed (RPM) shown for each blade size.
Excessive blade speed could result in blade breakage and serious personal injury.



CORE CUT







CC3700E
Large Walk Behind Saw

Diamond Products Limited
800-321-5336 - www.diamondproducts.com

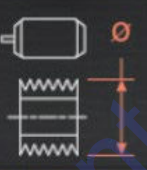

CC3725E / CC3730E SINGLE SPEED RPM CHART

BLADE SIZE	BLADE RPM	BLADESHAFT SHEAVE	MOTOR SHEAVE	MOTOR RPM	FLANGE SIZE	MAX CUT DEPTH
14"	3,050	3.12"	5.30"	1,800	4-1/2"	4-1/2"
20"	2,350	3.65"	4.75"	1,800	4-1/2"	7-1/2"
26"	1,800	4.12"	4.12"	1,800	4-1/2"	10-1/2"
30"	1,550	4.75"	4.12"	1,800	6"	11-3/4"
36"	1,375	4.75"	3.65"	1,800	6"	14-3/4"

WARNING! NEVER EXCEED THE MAXIMUM RPM STAMPED ON BLADE!
 EXCESSIVE SPEED CAN CAUSE BLADE BREAKAGE RESULTING IN SERIOUS PERSONAL INJURY OR DEATH.



CORE CUT







CC3700E
Large Walk Behind Saw

Diamond Products Limited
800-321-5336 - www.diamondproducts.com

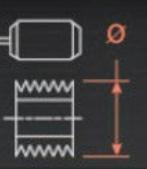

CC3740E SINGLE SPEED RPM CHART

BLADE SIZE	BLADE RPM	BLADESHAFT SHEAVE	MOTOR SHEAVE	MOTOR RPM	FLANGE SIZE	MAX CUT DEPTH
20"	2,500	4"	5.6"	1,800	4-1/2"	7-1/2"
26"	2,000	4.5"	5"	1,800	4-1/2"	10-1/2"
30"	1,700	5"	4.75"	1,800	6"	11-3/4"
36"	1,350	5.3"	4"	1,800	6"	14-3/4"

WARNING! NEVER EXCEED THE MAXIMUM RPM STAMPED ON BLADE!
 EXCESSIVE SPEED CAN CAUSE BLADE BREAKAGE RESULTING IN SERIOUS PERSONAL INJURY OR DEATH.

REFERENCES

CC3700E Single Speed Blade Size Conversion Charts

WARNING: When changing blade size, use the chart below for selecting the correct items for the different configurations.

CC3725E & CC3730E	14"	20"	26"	30"	36"
Blade Guard Assembly	6010950	6010952	6010954	6010956	6010958
Motor Sheave (Sheave Size)	6011093 (5.3") Taper Style	6011094 (4.75") Taper Style	6012024 (4.12") Set Screw Style	6012024 (4.12") Set Screw Style	6012056 (3.65") Set Screw Style
Blade Shaft Sheave (Sheave Size)	6012005 (3.12") Set Screw Style	6011009 (3.65") Set Screw Style	6011010 (4.12") Set Screw Style	6012052 (4.75") Taper Style	6012052 (4.75") Taper Style
Drive Belts (Size)	2500371 (3VX500)	2500371 (3VX500)	2500371 (3VX500)	2500371 (3VX500)	2500371 (3VX500)
Inner Flanges (2) (Flange Size)	6010036 (4.5")	6010036 (4.5")	6010036 (4.5")	6010038 (6")	6010038 (6")
Outer Flanges (1) (Flange Size)	6010037 (4.5")	6010037 (4.5")	6010037 (4.5")	6010039 (6")	6010039 (6")

CC3740E	20"	26"	30"	36"
Blade Guard Assembly	6010952	6010954	6010956	6010958
Motor Sheave (Sheave Size)	6010291 (5.6") QD Style	6010293 (5") Taper Style	6010295 (4.75") Taper Style	6012176 (4") Taper Style
Blade Shaft Sheave (Sheave Size)	6012012 (4") Taper Style	6010547 (4.5") Taper Style	6012062 (5") Taper Style	6012053 (5.3") QD Style
Drive Belts (Size)	2500188 (3VX560)	2500188 (3VX560)	2500188 (3VX560)	2500188 (3VX560)
Inner Flanges (2) (Flange Size)	6010036 (4.5")	6010036 (4.5")	6010038 (6")	6010038 (6")
Outer Flanges (1) (Flange Size)	6010037 (4.5")	6010037 (4.5")	6010039 (6")	6010039 (6")

REFERENCES

CC3700E 3-Speed RPM Charts

WARNING: Do not exceed blade speed (RPM) shown for each blade size.
Excessive blade speed could result in blade breakage and serious personal injury.

CORE CUT CC3700E Large Walk Behind Saw <small>Diamond Products Limited 800-321-5336 - www.diamondproducts.com</small> 					
CC3700E 3-SPEED RPM CHART					
BLADE SIZE	BLADE RPM	GEAR POSITION	MOTOR SHEAVE	MOTOR RPM	MAX CUT DEPTH
14"	2,925	H (high)	6.5"	1,800	3-3/4"
20"	2,520	H (high)	5.6"	1,800	6-3/4"
26"	1,950	M (med)	6.5"	1,800	9-3/4"
30"	1,680	M (med)	5.6"	1,800	11-3/4"
36"	1,300	L (low)	6.5"	1,800	14-3/4"
42"	1,120	L (low)	5.6"	1,800	17-3/4"

WARNING! NEVER EXCEED THE MAXIMUM RPM STAMPED ON BLADE!
EXCESSIVE SPEED CAN CAUSE BLADE BREAKAGE RESULTING IN SERIOUS PERSONAL INJURY OR DEATH.

CC3700E 3-Speed Blade Size Conversion Charts

WARNING: When changing blade size, use the chart below for selecting the correct items for the different configurations.

CC3730E-3	14"	20"	26"	30"	36"	42"
Blade Guard Assembly	6010950	6010952	6010954	6010956	6010958	6010960
Motor Sheave (Sheave Size)	2503755 (6.5")	2500172 (5.6")	2503755 (6.5")	2500172 (5.6")	2503755 (6.5")	2500172 (5.6")
Motor Sheave Bushing (Bushing Size)	2500932 (1.88") QD Style	2500932 (1.88") QD Style	2500932 (1.88") QD Style	2500932 (1.88") QD Style	2500932 (1.88") QD Style	2500932 (1.88") QD Style
Blade Shaft Sheave (Sheave Size)	6045158 (4")	6045158 (4")	6045158 (4")	6045158 (4")	6045158 (4")	6045158 (4")
Blade Shaft Sheave Bushing (Bushing Size)	2503811 (1.5") Taper Style	2503811 (1.5") Taper Style	2503811 (1.5") Taper Style	2503811 (1.5") Taper Style	2503811 (1.5") Taper Style	2503811 (1.5") Taper Style
Drive Belts (Size)	2503185 (3VX464)	2500794 (3VX450)	2503185 (3VX464)	2500794 (3VX450)	2503185 (3VX464)	2500794 (3VX450)
Inner Flanges (2) (Flange Size)	6010038 (6")	6010038 (6")	6010038 (6")	6010038 (6")	6010038 (6")	6010038 (6")
Outer Flanges (1) (Flange Size)	6010039 (6")	6010039 (6")	6010039 (6")	6010039 (6")	6010039 (6")	6010039 (6")

REFERENCES

CC3740E-3	14"	20"	26"	30"	36"	42"
Blade Guard Assembly	6010950	6010952	6010954	6010956	6010958	6010960
Motor Sheave (Sheave Size)	2501902 (6.5")	2500209 (5.6")	2501902 (6.5")	2500209 (5.6")	2501902 (6.5")	2500209 (5.6")
Motor Sheave Bushing (Bushing Size)	2500934 (2.13") QD Style	2500934 (2.13") QD Style	2500934 (2.13") QD Style	2500934 (2.13") QD Style	2500934 (2.13") QD Style	2500934 (2.13") QD Style
Blade Shaft Sheave (Sheave Size)	2501382 (4")	2501382 (4")	2501382 (4")	2501382 (4")	2501382 (4")	2501382 (4")
Blade Shaft Sheave Bushing (Bushing Size)	2503811 (1.5") Taper Style	2503811 (1.5") Taper Style	2503811 (1.5") Taper Style	2503811 (1.5") Taper Style	2503811 (1.5") Taper Style	2503811 (1.5") Taper Style
Drive Belts (Size)	2500298 (3VX475)	2503185 (3VX464)	2500298 (3VX475)	2503185 (3VX464)	2500298 (3VX475)	2503185 (3VX464)
Inner Flanges (2) (Flange Size)	6010038 (6")	6010038 (6")	6010038 (6")	6010038 (6")	6010038 (6")	6010038 (6")
Outer Flanges (1) (Flange Size)	6010039 (6")	6010039 (6")	6010039 (6")	6010039 (6")	6010039 (6")	6010039 (6")

Appendix C

Additional Resources

1. Discount-equipment (www.discount-equipment.com)
 - *CC3725E, CC3730E, CC3740E Saw Parts List; #1800774*
 - *CC3700E-3 Saw Parts List; Ohio; #1801948*
 - *A Guide for Professional Concrete Cutters*
 - *Training Manual – Introduction to Diamond Blades, Bits, and Equipment*
 - *Diamond Products' Equipment Catalog*
 - *Discount-equipment' Website (www.discount-equipment.com)*
2. Concrete Sawing and Drilling Association (www.csda.org)
 - The CSDA has many helpful concrete cutting publications available to members and non-members.
3. Association of Equipment Manufacturers (www.aem.org)
 - The AEM has a variety of safety and technical manuals available for various types of equipment, along with a list of industry-standardized safety symbols.
4. Occupational Safety & Health Administration (OSHA) (www.osha.gov/)
 - OSHA provides information on work-related safety and health practices.
5. The National Institute for Occupational Safety and Health (NIOSH) (www.cdc.gov/NIOSH/)
 - NIOSH provides information on work-related safety and health practices.

Appendix D

Model and Serial Numbers

Record the saw's serial number below for future reference and customer service purposes.

Serial Number	
---------------	--

Record the motor's model and serial numbers below for future reference and customer service purposes.

Model Number	
Serial Number	

To order go to Discount-Equipment.com

EQUIPMENT AND PARTS WARRANTY

Discount-equipment warrants all equipment sold by it against defects in workmanship or materials for a period of one (1) year from the date of shipment to Customer.

The responsibility of Discount-equipment under this Warranty is limited to replacement or repair of defective parts, of such parts as shall appear to us upon inspection at such parts, to have been defective in material or workmanship, with expense for transportation and labor borne by Customer.

In no event shall Discount-equipment be liable for consequential or incidental damages arising out of the failure of any Product to operate properly.

Integral units such as engines, electric motors, batteries, transmissions, etc., are excluded from this Warranty and are subject to the prime manufacturer's warranty.

**THIS WARRANTY IS IN LIEU OF ALL OTHER WARRANTIES,
EXPRESSED OR IMPLIED, AND ALL SUCH OTHER WARRANTIES ARE
HEREBY DISCLAIMED.**



TO PURCHASE THIS PRODUCT PLEASE CONTACT US



**Equipment Financing and
Extended Warranties Available**



**Discount-Equipment.com is your online resource for
commercial and industrial quality parts and equipment sales.**

561-964-4949

visit us on line @ www.discount-equipment.com

Select an option below to find your Equipment

Search by Manufacturer

Search by Product Type

Request a Quote

We sell worldwide for the brands: Genie, Terex, JLG, MultiQuip, Mikasa, Essick, Whiteman, Mayco, Toro Stone, Diamond Products, Generac Magnum, Airman, Haulotte, Barreto, Power Blanket, Nifty Lift, Atlas Copco, Chicago Pneumatic, Allmand, Miller Curber, Skyjack, Lull, Skytrak, Tsurumi, Husquvarna Target, Stow, Wacker, Sakai, Mi-T-M, Sullair, Basic, Dynapac, MBW, Weber, Bartell, Bennar Newman, Haulotte, Ditch Runner, Menegotti, Morrison, Contec, Buddy, Crown, Edco, Wyco, Bomag, Laymor, EZ Trench, Bil-Jax, F.S. Curtis, Gehl Pavers, Heli, Honda, ICS/PowerGrit, IHI, Partner, Imer, Clipper, MMD, Koshin, Rice, CH&E, General Equipment, Amida, Coleman, NAC, Gradall, Square Shooter, Kent, Stanley, Tamco, Toku, Hatz, Kohler, Robin, Wisconsin, Northrock, Oztec, Toker TK, Rol-Air, APT, Wylie, Ingersoll Rand / Doosan, Innovatech, Con X, Ammann, Mecalac, Makinex, Smith Surface Prep, Small Line, Wanco, Yanmar