

Operator's Safety and Service

MVP Plate Compactors

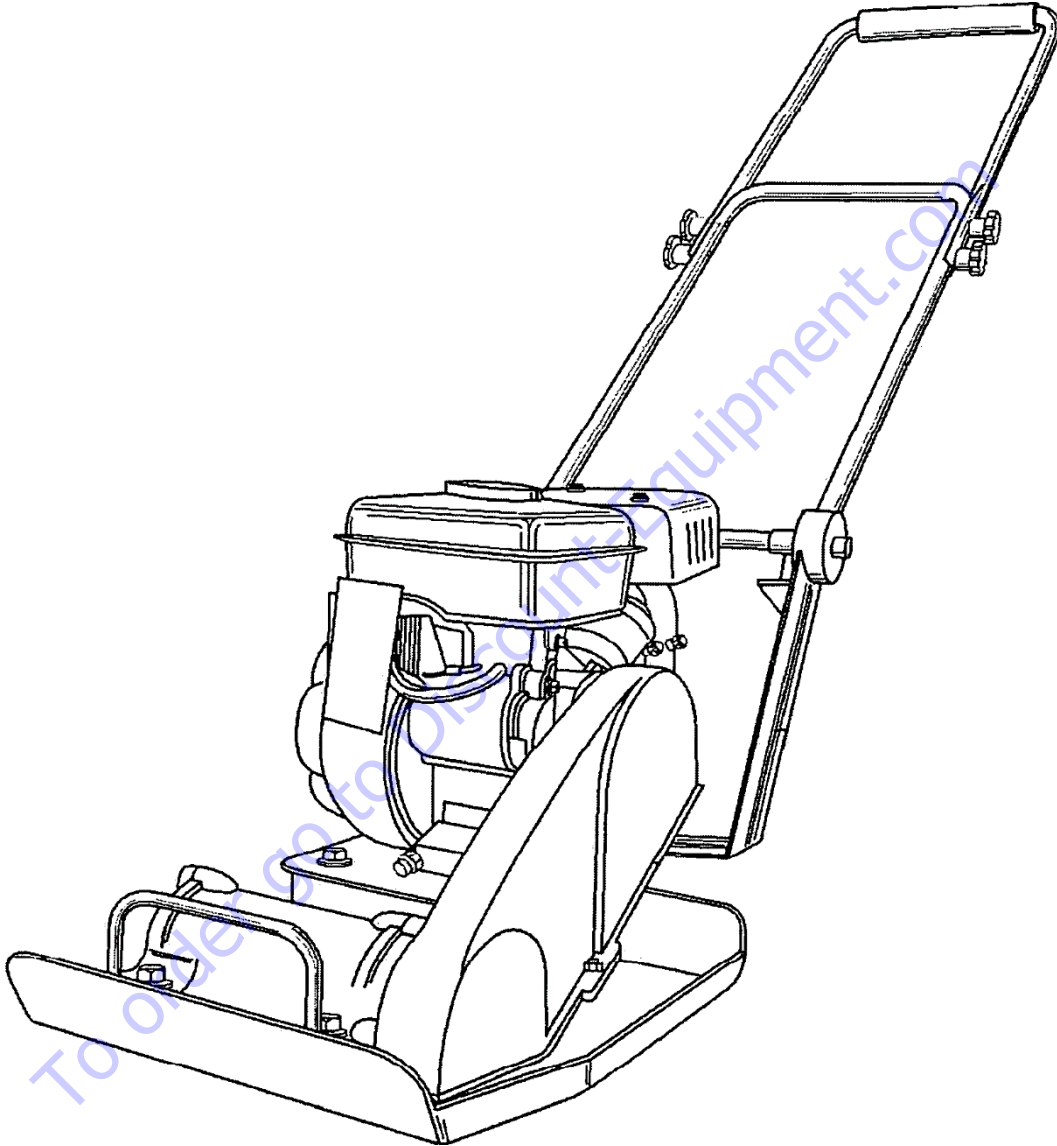

MVP60/MVP90

MVP95/MVP125

It is the OWNER'S RESPONSIBILITY to communicate information on the
SAFE USE and OPERATION of this machine to the operators.

TO PURCHASE THIS PRODUCT PLEASE CONTACT US



**Equipment Financing and
Extended Warranties Available**



**Discount-Equipment.com is your online resource for
commercial and industrial quality parts and equipment sales.**

561-964-4949

visit us on line @ www.discount-equipment.com

Select an option below to find your Equipment

Search by Manufacturer

Search by Product Type

Request a Quote

We sell worldwide for the brands: Genie, Terex, JLG, MultiQuip, Mikasa, Essick, Whiteman, Mayco, Toro Stone, Diamond Products, Generac Magnum, Airman, Haulotte, Barreto, Power Blanket, Nifty Lift, Atlas Copco, Chicago Pneumatic, Allmand, Miller Curber, Skyjack, Lull, Skytrak, Tsurumi, Husquvarna Target, Stow, Wacker, Sakai, Mi-T-M, Sullair, Basic, Dynapac, MBW, Weber, Bartell, Bennar Newman, Haulotte, Ditch Runner, Menegotti, Morrison, Contec, Buddy, Crown, Edco, Wyco, Bomag, Laymor, EZ Trench, Bil-Jax, F.S. Curtis, Gehl Pavers, Heli, Honda, ICS/PowerGrit, IHI, Partner, Imer, Clipper, MMD, Koshin, Rice, CH&E, General Equipment, Amida, Coleman, NAC, Gradall, Square Shooter, Kent, Stanley, Tamco, Toku, Hatz, Kohler, Robin, Wisconsin, Northrock, Oztec, Toker TK, Rol-Air, APT, Wylie, Ingersoll Rand / Doosan, Innovatech, Con X, Ammann, Mecalac, Makinex, Smith Surface Prep, Small Line, Wanco, Yanmar

TABLE OF CONTENTS

1.Serial Number Location.....	3
2.Parts Ordering Procedure	3
3.Operating Instructions	4
4.Safety Precaution	5
5.Safety Notice & Decals	6
6.Before Operating.....	6
7.Operation Instruction.....	7
8.Adding Fluids & Towing	8
9.Service Instructions	10
10.Maintenance Schedule	11
11.Replacements.....	12
12.Equipment General Specs	13
13.Troubleshooting.....	14
14.Torque Chart	15
15.Warranty	16
16.Warehouse Locations.....	18
17.Additional Notes	19
1.Parts List Breakdown.....	Attachment

1. SERIAL NUMBER LOCATION

The model/serial number decal is located on the shroud assembly (cowl).



(Write model number)



(Write serial number)

The unit year of manufacturing can be determined by its serial number. So, keep this information handy at all times, use your unit serial number when ordering parts.

This Unit warranty is stated in this Operational and Safety manual on page 16. Failure to return warranty registration card renders the warranty null and void.

An engine owner's manual is also attached to every unit. Engine parts must be order from any authorized HONDA dealer, or other if different than HONDA. Refer to the engine owner's manual lo learn about specifications and part identification.

2. PARTS ORDERING PROCEDURE:

Please go to www.discount-equipment.com for more information on ordering parts.

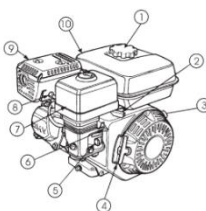

All HONDA warranties and parts ordering must be through your Honda dealers.

3. OPERATING INSTRUCTIONS

This Operation manual contains only standard parts. Variations of these parts as well as other special accessories are not included. Contact your local distributor for assistance in identifying parts not included in this manual.

ASSEMBLY INSTRUCTIONS

1. Remove the machine and all components from its shipping crate. You will see:
 - Preassembled Plate Compactor w/ water kit (if applies)

Note: All installation hardware must be inserted into its respective location on the unit, reference parts breakdown for more details if needed.



Warning: failure to use proper lifting equipment could cause equipment to fall and cause serious injury.

2. If Plate is shipped regular, using appropriated equipment, bring the unit to the ground from its shipping pallet. Plates can be lifted by hand by 2 or more people.

PRE-START-UP INSPECTION

1. The following Pre-start-up inspection must be performed before the start of each work session or after every four hours of use, whichever is first. If any fault is discovered, the compactor must not be used until the fault is rectified.
2. Thoroughly inspect the compactor for signs of damage. Check components are present and secure. Pay special attention to the belt drive safety guard fitted between the engine and the vibrator unit.
3. Check the engine oil level and top up as necessary.
4. Check the engine fuel level and top up as necessary.

4. SAFETY PRECAUTIONS

READ AND STUDY THE FOLLOWING SAFETY INFORMATION BEFORE ATTEMPTING TO OPERATE THIS EQUIPMENT. IN ADDITION, ENSURE THAT EVERY INDIVIDUAL WHO OPERATES OR WORKS WITH THIS EQUIPMENT IS FAMILIAR WITH THESE SAFETY PRECAUTIONS.

WARNING - LETHAL EXHAUST GAS!

An internal combustion engine discharges carbon monoxide, which is a poisonous and odorless invisible gas. Death or serious illness may result if inhaled. Operate only in an area with good ventilation.

NEVER IN A CONFINED AREA!

WARNING - DANGEROUS FUELS!

Use extreme caution when storing, handling and using fuels - they are highly volatile and explosive in the vapor state. Do not add fuel while engine is running. Stop and cool the engine before adding fuel.

DO NOT SMOKE WHEN REFUELING!

SAFETY GUARDS

It is the owner's responsibility to ensure **ALL GUARDS AND SHIELDS** are in place and in working order.

IGNITION SYSTEMS

Breakerless magneto and batteries ignition systems **CAN CAUSE SEVERE ELECTRICAL SHOCKS**, avoid contact with these components or their wiring.

SAFE DRESS

DO NOT WEAR loose clothing, rings, wristwatches, etc., near machinery.

NOISE PROTECTION

Wear O.S.H.A. specified hearing protection devices.

FOOT PROTECTION

Wear O.S.H.A. specified steel tip safety shoes.

HEAD PROTECTION

Wear O.S.H.A. specified safety helmets.

EYE PROTECTION

Wear O.S.H.A. specified eyes shields, safety glasses, and sweat bands.

DUST PROTECTION

Wear O.S.H.A. specified dust mask or respirator.

OPERATOR

Keep children and bystanders off and away from the equipment.

For details on safety rules and regulations in the United States, contact your local Occupational Safety and Health Administration (O.S.H.A.) office. Equipment operated in other countries must be operated and serviced in accordance and compliance with any and all safety requirements of such country. The publication of these safety precautions is done for your information does not by the publication of these precautions, imply or in any way represent that these are the sum of all dangers present near equipment. If you are operating this unit it is your responsibility to ensure that such operation is in full accordance with all applicable safety requirements and codes. All requirements of the United States Federal Occupational Safety and Health Administration Act must be met when operated in areas that are under the jurisdiction of that United States Department.

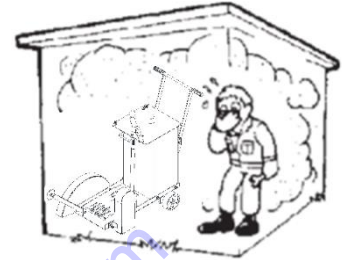

5. SAFETY NOTICE & DECALS



The "SAFETY ALERT SYMBOL" is used to call attention to items or operations that may be dangerous to those operating or working with this equipment. These symbols can be found throughout the manual and on the unit itself. Please read these warnings and cautions carefully.

READ SAFETY DECALS CAREFULLY

Carefully read and follow all safety decals. Keep them in good conditions. If they become aged, replace as required. If repainting, **REPLACE ALL** decals. Decals are available from your authorized Distributors. Decals are not shown to scale.

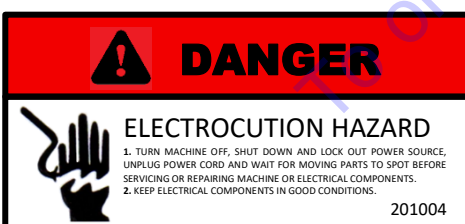
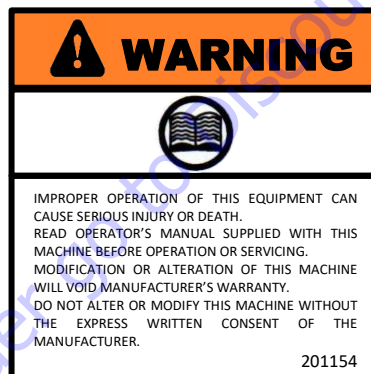
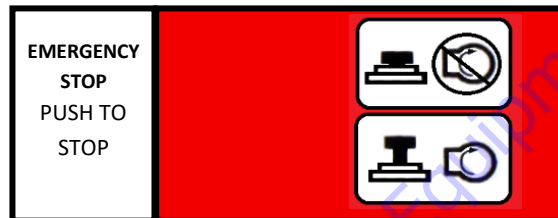

6. BEFORE OPERATING

Thoroughly inspect the compactor for signs of damage. Check components are present and secure. Pay special attention to the belt drive safety guard fitted between the engine and the vibrator unit.

2. Check the engine oil level and top up as necessary.
3. Check the engine fuel level and top up as necessary.
4. Check for fuel and oil leaks

- **REMEMBER!** It is the owner's responsibility to communicate information on the safe use and proper operation of this unit to the operators.
- Before operating, review SAFETY PRECAUTIONS on this manual.
- Familiarize yourself with the operation of the unit and confirm that all controls function properly BEFORE starting engine.
- Locate the killing switch and assure you know how to STOP the unit.
- Make sure hands, feet, and clothing are at a safe distance from any moveable parts prior to starting.
- Shrouds and grids are provided to protect the operator or structures in close proximity to rotating hot engine parts. It is the **RESPONSABILITY OF THE OPERATOR** to see that they are properly secured.
- OIL LEVEL - Check the oil level in the engine. For more information see "Lubrication" under the engine "Owner's Manual" the "Maintenance" section of this manual. **All units come without oil on ENGINE. Running an engine without lubrication may damage this unit.**
- AIR CLEANER - Check to ensure elements are in good condition and properly installed.
- Review every decal with the OPERATOR.
- FUEL SUPPLY – Engines require an automotive grade of clean, fresh, unleaded or regular gasoline. **All units come WITHOUT gasoline, oil or any other fluid.**
- FUEL FILTER - Check to ensure element is in good condition... Replace if it is clogged or damaged.
- LUBRICATION POINTS - Grease bearings and shafts daily.
- POSITION – The only operating position for this equipment is between the handle bars at the rear of the unit. If the operator must leave this position the engine must be shut down.
- SPECTATORS – Keep all personnel/spectators away from unit while using.

7. OPERATION INSTRUCTIONS

IMPORTANT

Engine warranty is void if the engine is run without oil.

Prior to starting engine, make sure all guards are in place and secured.

Check Gas engine

1. The motor is controlled by an ON/OFF switch or push button is mounted on the motor below the fuel tank. Open the fuel tap by moving the fuel ON/OFF lever fully to the right.
2. If starting the engine from cold, set the choke ON by moving the choke lever fully to the left. If restarting a warm engine, the choke is usually not required. However, if the engine has cooled to a degree, partial choke may be required.

3. Turn the engine ON/OFF switch clockwise to the "1" position.
 4. Set the throttle to the idle position by moving the throttle lever fully to the right. Do not start the engine on full throttle, as the compactor will vibrate as soon as the engine starts.
 5. Taking a firm hold of the control handle with one hand, grasp the recoil starter
 6. handle with the other. Pull the recoil starter until engine resistance is felt, then
 7. let starter return.
 8. Taking care not to pull the starter's cope fully out, pull the starter handle briskly.
 9. Repeat until the engine fires.
 10. Once the engine fires gradually, set the choke lever to the OFF position by
 11. Moving it to the right.
 12. If the engine fails to fire after several attempts, follow the trouble-shooting guide on Honda Manual.
 13. To stop the engine, set the throttle to idle and turn the engine ON /OFF switch anticlockwise to the "0" position.
 14. Turn the fuel off.
- NOTE:** Tension of the drive belt is adjustable, loosen the four nuts on the bolts which secure the motor to the base plate. Adjust the set screws which bear against the motor crankcase to achieve the required belt tension. Ensure that the four nuts and the set screw locknuts are tightened after adjustment.

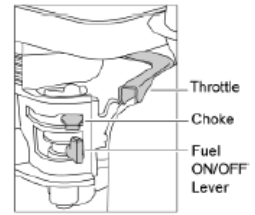

OPERATING

MVP60, MVP90 and MVP95 are best suited to the compaction of bituminous and granular materials e.g. granular soils such as silt and clay are best compacted using the impact force produced by a vibrating rammer.

Where possible the site should be graded and leveled before commencing compaction.

Correct moisture content in soil is vital to proper compaction. Water acts as a lubricant to help slide soil particles together.

Too little moisture means inadequate compaction; too much moisture leaves water-filled voids that weaken the soil's load-bearing ability.

Compaction of dry materials will be facilitated by moistening with a water hose fitted with a sprinkler.

Excessive watering or water content will cause the machine to stall.

The optional water tank kit is recommended when the machine is used on bituminous surfaces as the water film prevents a buildup of material on the underside of the plate.

Use unleaded grade petrol and ensure that the fuel is free from contamination.

The vibratory motion provides a self-propelling action. Position the handle at the opposite end of the machine to the vibrator.

For more information on starting and correct operating procedures of the motor, refer to the motor operation manual supplied with the unit.

Increase the motor speed to the maximum setting using the hand throttle lever, before commencing compacting. The machine should be controlled by grasping the handle with both hands and applying restraint to control the forward motion.

Steer the machine by moving the handle sideways to the right or left.

ALWAYS maintain good footing so that you do not slip and lose control when starting or operating the machine.

If the optional water tank is fitted, the flow rate can be controlled by adjusting the cock in the supply hose to sprinkler bar. Inspect the water hose and its connections to ensure that they do not leak.

8. ADDING FLUIDS & TRANSPORTATION

GAS ENGINE

1. Move the engagement lever to the "IDLER" position.
2. Close the fuel valve.
3. Add oil and/or gas to continue operation / Drain oil if need oil change.
4. MVP60 and MVP95 use 200ml of 10/30 oil. The filler is located on the right bottom side of the case
5. MVP125 uses 500 ml of 10/30 oil. The filler is located on the front left of case.



STOP THE ENGINE BEFORE:

1. Adding fuel/Oil.
2. Leaving equipment unattended for any amount of time.
3. Making any repairs or adjustments to the unit.
4. Transportation.

IF LIFTING/LOWERING EQUIPMENT ALWAYS:

1. Stop the engine or electric motor (if applies)
2. Remove wheel kits (If applies)
3. Secure any other hardware on the unit.
4. Make sure you use appropriated lifting equipment rated to lift the unit. Have in mind the equipment weight.
5. Do not position yourself where you could possibly be pinched / caught between unit and some other obstacle.

TRANSPORTATION

1. Move Unit on the jobsite by hand pushing unit using the optional wheel kit (Trolley). Wheel kit is used for short distance transportation.
2. If not using a wheel kit, use lifting point when lifting machine. Make sure lifting device has enough capacity to hold machine (see identification plate on machine for weight).
3. Do not push plate in ground or plate damage can occur.

STORING

1. Drain fuel tank.
2. Clean shaft and bearings. Coat parts with grease.
3. Lube all bearings
4. Inspect the rubber anti vibration mounts for wear or deterioration
5. Empty water system to avoid corrosion, inspect the water hose and its connections to ensure that they do not leak.
6. Clean all moving parts with WD-40 lubricant.
7. Clean the underside of the plate regularly to prevent a buildup of material.
8. Cover unit for weather protection.

9. SERVICE INSTRUCTIONS

1. Never service or lubricate the unit engine while running.
2. After servicing the unit, restore and fasten all guards, shields, and covers to their original positions.
3. Never drain oil into the ground, into open streams, or down sewage drains.
4. To make sure your plate compactor is always in good working condition before using, carry out the maintenance inspection in accordance with the Maintenance Schedule.

ENGINE

See engine owner's manual maintenance schedule.

AIR FILTER

1. The air filter element should be cleaned because a clogged air cleaner can cause poor engine starting, lack of power and shorten engine life substantially.
2. To clean or replace air filter loosen the wing nut on the air filter housing, Remove the cover and take out air filter cartridge. If only cleaning of the air filter is desired blow through the air filter cartridge from the inside, moving a jet of dry compressed air up and down until all dust is removed.

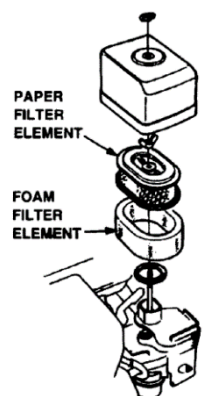

REPLACING/REINSTALLING V-BELT

1. **NEVER** attempt to check the V-belt with the engine running. Severe injury can occur if your hand gets caught between the V-belt and the clutch. Always use safety gloves.

2. After 200 hours of operation, remove the upper belt cover to check the V-belt tension. Tension is proper if the belt bends about 10mm when depressed strongly with finger between shafts. Loose or worn V-belts reduces power transmission efficiency, causing weak compaction and reduces the life of the belt itself.

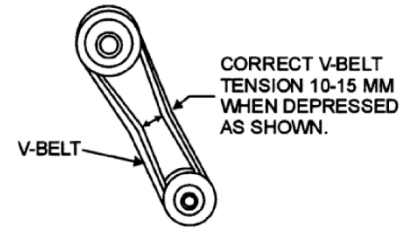

3. Whenever the compactor's vibration becomes weak or lost during normal operation regardless of operation hours, check the V-belt and clutch immediately.

4. Remove the upper and lower belt covers. Engage an offset wrench (13mm) or the like to vibrator pulley (lower) fastening bolt. Engage waste cloth or the like at midway of V-belt on the left side and while pulling it back strongly, rotate the offset wrench clockwise so that the V-belt will come off.

5. Engage V-belt to lower vibrator pulley and push the V-belt to left side of upper clutch and, in the same manner as in removal, rotate offset wrench clockwise so that the V-belt goes back on.

CLUTCH

1. Check the clutch simultaneously with V-belt checking. With belt removed, check outer drum of the clutch for seizure and "V" groove for wear or damage with your eyes. Clean the "V" groove as necessary. Wear of lining or shoe should be checked with running check. If the shoe is worn, power transmission becomes deficient and slipping will result.

10. MAINTENANCE SCHEDULE



IMPORTANT NOTICE



**THESE INSPECTION INTERVALS ARE FOR OPERATION UNDER NORMAL CONDITIONS.
ADJUST YOUR INSPECTION INTERVALS BASED ON THE NUMBER HOURS PLATE
COMPACTOR IS IN USE, AND PARTICULAR WORKING CONDITIONS.**

1. Check all hardware after the first 5 hours of use. Check for loose screws including tightness.
2. Check oil daily. Look after leakage of fuel or oil.
3. Change oil after 5 (five) hours of use and every 25 hours after first change. Refer to engine manual for oil grades.
4. Remove soil and clean the bottom of compaction plate.
5. For wheel kit, Grease wheels (4) weekly. Use high quality gun grease, Kendall "SHP High temp" or equal.

6. Clean air filter and foam pre-cleaner daily. More often if dry cutting. Always use foam element pre-cleaner over paper cartridge. Never run engine with clogged or missing air filter.
7. Tension of the drive belt is adjustable, loosen the four nuts on the bolts which secure the motor to the base plate. Adjust the set screws which bear against the motor crankcase to achieve the required belt tension. Ensure that the four nuts and the set screw locknuts are tightened after adjustment.
- 8. FUEL PIPING AND CONNECTIONS SHOULD BE REPLACED EVERY 2 YEARS.**
9. Follow the maintenance schedule.

	<i>Maintenance</i>	<i>Each use</i>	<i>Every 20 hours</i>	<i>Every 50 hours</i>	<i>Every 100 hours</i>	<i>Yearly</i>
Engine	Refer to engine operator/owner manual	X				X
Air Cleaner	Refer to engine operator/owner manual	X				X
Oil	Oil change & Leakage		X			
Bearings	Grease Arbor Shaft Bearings	X				X
V-Belts	Check for excessive wear		X			X
V-Belt Clutch	V-belt (clutch) check				X	X
Hardware	Check and tighten check torque diag.		X	X		X
Wheels	Grease wheels and check wear	X				X
Damage	Broken parts or Damage				X	
Vibrator Oil	Vibrator motor Oil check & leakage				X	
Vibrator Oil Replacement	Vibrator motor Oil replacement				X	X

11. REPLACEMENT

Parts

Engine Components

V-Belts

Centrifugal Clutch

Rubber Stoppers

Hardware

Safety Decals

Tolerance or Replacement Cycle

- ✓ Refer to your engine manufacturer's Owner's Manual
- ✓ Replace if stretched to the point that the idler clutch does not work properly. Replace the V-belts if they are cracked or torn.
- ✓ Grease/lubricated Centrifugal clutch yearly.
- ✓ Inspect the rubber anti vibration mounts for wear or deterioration.
- ✓ Re-torque all bolts after the first eight hours of operation and check hardware every 25 hours. Replace any worn or damaged hardware as needed. Replacement hardware should be grade 5 and zinc plated.
- ✓ Replace if they become aged, damaged or cannot be easily read.

12. EQUIPMENT SPECS

MODEL	MVP60	MVP90	MVP95	MVP125
Centrifugal Force lbf (KN)	2360.5 lbf (10.5)	3380 lbf (15)	2922 lbf (13)	5620 lbf (25)
Exciter Speed (Frequency)	5600 VPM	5800 VPM	5500 VPM	4300 VPM
Compaction depth in (cm)	8 in (20)	10 in (25.4)	12 in (30)	12 in (30)
Max Forward ft./min	80ft./min	90ft./min	80ft./min	50ft./min
Fuel Consumption gal/hr.	-	.343 gal/hr.	-	-
Efficiency ft²/hr. (m²/hr.)	4800 ft ² /hr (450)	-	7100 ft ² /hr (660)	5400 ft ² /hr (500)
Water Tank Capacity	3.4 gal (13)	2.1 gal (8)	3.4 gal (13)	N/A
Plate Size in (cm)	14"x20" (36) x (50)	19"x21" (48)x(53)	20"x21" (50)x(53)	16"x25" (40)x(63.5)
Engine Power	GX160 Honda	GX160 Honda	GX160 Honda	GX160 Honda
Overall Length in (cm)	31" (80)	31" (80)	33" (83)	30" (76)
Overall Width in (cm)	16" (40)	20" (50)	20" (50)	16" (40)
Overall Height in (cm)	43" (108)	45" (114)	43" (108)	43" (108)
Operating Weight lbs. (Kg)	136 lbs. (62)	186 lbs. (84)	183 lbs. (83)	278 lbs. (126)
Compaction Direction	FWD Only	FWD Only	FWD Only	FWD & REV

MVP60

Ideal for sand, gravel and mixer soils in narrow trenches and along foundations, walls and abutments.

Foldable handle for easy transportation and storage.

Open plate provides self-cleaning

Optional wheels kit for easy transportation

Radius base plate for easy access to corners

Sealed belt cover to prevent sand and soil penetration

Heavy-duty shock mounts for vibration reduction into handles and engine

Throttle control available as an upgrade

MVP95

Ideal for most compaction jobs even brick paving with the optional rubber mat.

Standard with water system

Optional wheels kit for easy transportation

Ductile iron plate is provides life durability

Open plate provides self-cleaning

Easy removable water tank with built-in valve and no hose connection

Radius base plate for easy access to corners

Centrally located lifting eye for transportation

Sealed belt cover to prevent sand and soil penetration

Built-in wheels for easy transportation

Throttle control available as an upgrade

MVP125

Low maintenance design

Superior compaction on any direction forward and reverse

Ideal for sand, gravel and mixer soils in narrow trenches and along foundations, walls and abutments.

Easy-to-reach controls

large shock mounts for upper deck vibration reduction.

Wear-resistant base plates extend life, open design reduce dirt building.

Centrally located lifting eye for transportation.

Wrap around protection cage protects the plate from accidental job-site damage.

Heavy duty industrial throttle available as an upgrade

Transportation wheels kit available as an upgrade

13. TROUBLESHOOTING

SYMPTOM	POSSIBLE CAUSES	SOLUTION
Travel speed too low, and vibration is weak.	Engine speed too low?	Set engine speed to correct RPM.
	Clutch slips?	Check or replace clutch.
	V-belt slips?	Adjust or replace V-belt.
	Excessive oil in vibration?	Drain excess oil and fill to proper level.
	Malfunction in vibrator housing?	Check eccentric, gears and counter weights.
	Bearing Failure?	Replace Bearing.
	Insufficient engine output?	Check engine, compression etc.

SYMPTOM	POSSIBLE CAUSES	SOLUTION
Difficult to start, "fuel is available, but no SPARK at spark plug".	Spark plug bridging?	Check gap, insulation or replace spark plug.
	Carbon deposit on spark plug?	Clean or replace spark plug.
	Short circuit due to deficient spark plug insulation?	Check spark plug insulation, replace if worn.
	Improper spark plug gap?	Set to proper gap.
Difficult to start, "fuel is available, and SPARK is present at spark plug.	ON/OFF switch is shorted?	Check switch wiring, replace switch.
	Ignition coil defective?	Replace ignition coil.
	Improper spark gap, points dirty?	Set correct spark gap and clean points.
	Condenser insulation worn or short circuiting?	Replace condenser.
	Spark plug wire broken or short circuiting?	Replace defective spark plug wiring
Difficult to start, "fuel is available, spark is present and compression is normal"	Wrong fuel type?	Flush fuel system, and replace with correct type of fuel.
	Water or dust in fuel system?	Flush fuel system.
	Air cleaner dirty?	Clean or replace air cleaner.

SYMPTOM	POSSIBLE CAUSES	SOLUTION
Difficult to start, "fuel is available, spark is present and compression is low.	Suction/exhaust valve stuck or protruded?	Re-seat valves.
	Piston ring and/or cylinder worn?	Replace piston rings and or piston.
	Cylinder head and/or spark plug not tightened properly?	Torque cylinder head bolts and spark plug.
	Head gasket and/or spark plug gasket damaged?	Replace head and spark plug gaskets.
No fuel present at carburetor.	Fuel not available in fuel tank?	Fill with correct type of fuel.
	Fuel cock does not open properly?	Apply lubricant to loosen fuel cock level, replace if necessary.
	Fuel filter clogged?	Replace fuel filter.
	Fuel tank cap breather hole clogged?	Clean or replace fuel tank cap.
	Air in fuel line?	Bleed fuel line.
"Weak in power" compression is proper and does not mistier.	Air cleaner not clean?	Clean or replace air cleaner.
	Improper level in carburetor?	Check float adjustment, re-build carburetor.
	Defective Spark plug?	Clean or replace spark plug.
"Weak in power" compression is proper but mistier.	Water in fuel system?	Flush fuel system, and replace with correct type of fuel.
	Dirty spark plug?	Clean or replace spark plug.
	Ignition coil defective?	Replace ignition coil.
Engine overheats.	Spark plug heat value improper?	Replace with correct type of spark plug.
	Correct type of fuel?	Replace with correct type of fuel.
	Cooling fins dirty?	Clean cooling fins.
Rotational speed fluctuates.	Governor adjusted correctly?	Adjust governor.
	Governor spring defective?	Replace governor spring.
	Fuel flow restricted?	Check entire fuel system for leaks or clogs.
Recoil starter malfunction.	Recoil mechanism clogged with dust and dirt?	Clean recoil assembly with soap and water.
	Spiral spring loose?	Replace spiral spring.

14. TORQUE CHART

Material	6mm	8mm	10mm	12mm	14mm	16mm	18mm	20mm
4T	70	150	300	500	750	1100	1400	2000
6-8T	100	250	500	800	1300	2000	2700	3800
11T	150	400	800	1200	2000	2900	4200	5600
*	100 (6mm) 300-350 (8mm) 650-700 (10mm)							
*(In case counter-part is of aluminium)								
(Threads in use with this machine are all right handed)								
Material and quality of material is marked on each bolt, and screw.								

15. WARRANTY

THIS IS YOUR WARRANTY – PLEASE READ AND SAVE

1. **Crown Equip** warrants each new machine against any manufacturing defect in material and workmanship under normal use and service for a period of (1) one year. Warranty period begins on first day of use by end user. This first day of use is established by the date of a completed warranty card or a bill of sale to the end user.
2. **Crown Equip** units offer a Life time warranty on Bearings & Seals. The obligation under this warranty is limited to the replacement of parts at your **Crown Equip** factory branch or on an authorized **Crown Equip** distributor.
3. Machines altered or modified without a **Crown Equip** written consent may void this warranty policy immediately. Misuse, negligence, accidents or the operation of the machines in any other way that the recommended by **Crown Equip** operation procedures, will void this warranty policy. This warranty shall not apply to machines repaired by other than authorized **Crown Equip** branches or distributors.
4. The cost of transportation and other expenses related are not covered by this warranty.
5. Written authorization for the return of merchandise under warranty must be obtain from **Crown Equip** customer service contact. All equipment & parts returned may be sent with a signed RGA (Return Goods Authorization) for its follow up.
6. **Crown Equip** reserves the right to inspect and render the final decision on each warranty case.
7. **Crown Equip** reserves the right to improve or make product changes without incurring any obligation to update, refit or install on machines previously sold.
8. **Crown Equip** is not responsible for any liability, damage or injury directly or indirectly from the design, material or operation of its product.
9. The warranty letter must be returned to **Crown Equip** within 10 days after purchase/acquire, for a first use failure warranty claim.
10. Warranty request must be submitted in written within 30 days after machine failure to **Crown Equip** customer service.
11. THE FOREIGN WARRANTY IS EXPRESSLY IN LIEU OF ALL OTHER WARRANTIES, EXPRESSED OR IMPLIED, INCLUDING THE WARRANTIES OF MERCHANT ABILITY AND FITNESS FOR USE AND OF ALL OTHER OBLIGATION OR LIABILITIES ON OUR PART, AND WE NEITHER ASSUME NOR AUTHORIZE AINES, MOTOR AND THEIR COMPONENTS.NY OTHE RPERSON TO ASSUME FOR US ANY OF OUR PRODUCTS. LIKEWISE, THIS WARRANTY

Control #: _____ (Dealer's internal #)

Crown Equipment, Inc.

Limited Warranty Application

This warranty application must be filled in by the dealer/distributor at the time of the sale. Please Print

Crown Equipment Product Purchased at: _____ Phone (____) _____

Street Address: _____

City: _____ State: _____ Zip: _____

Model No.: _____ Customer Invoice: _____ Date: ___/___/___

16 DIGIT Serial No.: _____

Customer Name: _____ Phone: (____) _____

Street Address: _____

City: _____ State: _____ Zip: _____

Representative Signature: _____ Date: ___/___/___

Equipment's Owner Signature _____ Date: ___/___/___

Additional Notes: _____

Control #: _____



Crown Equipment

Customer Life Time

Warranty Application

***Dettach and keep on file**

(Check warranty policy for details)

Customer Signature

To order go to Discount-Equipment.com

TO PURCHASE THIS PRODUCT PLEASE CONTACT US



**Equipment Financing and
Extended Warranties Available**



**Discount-Equipment.com is your online resource for
commercial and industrial quality parts and equipment sales.**

561-964-4949

visit us on line @ www.discount-equipment.com

Select an option below to find your Equipment

Search by Manufacturer

Search by Product Type

Request a Quote

We sell worldwide for the brands: Genie, Terex, JLG, MultiQuip, Mikasa, Essick, Whiteman, Mayco, Toro Stone, Diamond Products, Generac Magnum, Airman, Haulotte, Barreto, Power Blanket, Nifty Lift, Atlas Copco, Chicago Pneumatic, Allmand, Miller Curber, Skyjack, Lull, Skytrak, Tsurumi, Husquvarna Target, Stow, Wacker, Sakai, Mi-T-M, Sullair, Basic, Dynapac, MBW, Weber, Bartell, Bennar Newman, Haulotte, Ditch Runner, Menegotti, Morrison, Contec, Buddy, Crown, Edco, Wyco, Bomag, Laymor, EZ Trench, Bil-Jax, F.S. Curtis, Gehl Pavers, Heli, Honda, ICS/PowerGrit, IHI, Partner, Imer, Clipper, MMD, Koshin, Rice, CH&E, General Equipment, Amida, Coleman, NAC, Gradall, Square Shooter, Kent, Stanley, Tamco, Toku, Hatz, Kohler, Robin, Wisconsin, Northrock, Oztec, Toker TK, Rol-Air, APT, Wylie, Ingersoll Rand / Doosan, Innovatech, Con X, Ammann, Mecalac, Makinex, Smith Surface Prep, Small Line, Wanco, Yanmar

16. WAREHOUSE LOCATIONS

We are at your service

We have established a network of reputable distributors with trained mechanics and full facilities for maintenance and rebuilt, and to carry an adequate stock parts in all areas of the country. Their sales engineers are available for professional consultation. If you cannot locate your nearest distributor contact our sales branch listed below so we can point you in the right direction.

CONTACT BY E-MAIL

SALES

www.Discount-Equipment.com

PARTS & SERVICE

www.Discount-Equipment.com

To order go to Discount-Equipment.com

