



[www.Discount-Equipment.com](http://www.Discount-Equipment.com)



Husqvarna, 2018-03-12

### **Safety and Operating Instructions**

Dear customer,

thank you for choosing a Husqvarna quality product. We hope that you will genuinely enjoy it. Please note that the enclosed manual contains Atlas Copco references.

The Husqvarna Group is vouching for the quality of this product.

If you have any questions, please do not hesitate to contact our local sales or service point.

Husqvarna AB  
561 82 Huskvarna, Sweden

**TO PURCHASE THIS PRODUCT PLEASE CONTACT US**



**Equipment Financing and  
Extended Warranties Available**



**Discount-Equipment.com is your online resource for  
commercial and industrial quality parts and equipment sales.**

**561-964-4949**

**visit us on line @ [www.discount-equipment.com](http://www.discount-equipment.com)**

Select an option below to find your Equipment

**Search by Manufacturer**

**Search by Product Type**

**Request a Quote**

We sell worldwide for the brands: Genie, Terex, JLG, MultiQuip, Mikasa, Essick, Whiteman, Mayco, Toro Stone, Diamond Products, Generac Magnum, Airman, Haulotte, Barreto, Power Blanket, Nifty Lift, Atlas Copco, Chicago Pneumatic, Allmand, Miller Curber, Skyjack, Lull, Skytrak, Tsurumi, Husquvarna Target, Stow, Wacker, Sakai, Mi-T-M, Sullair, Basic, Dynapac, MBW, Weber, Bartell, Bennar Newman, Haulotte, Ditch Runner, Menegotti, Morrison, Contec, Buddy, Crown, Edco, Wyco, Bomag, Laymor, EZ Trench, Bil-Jax, F.S. Curtis, Gehl Pavers, Heli, Honda, ICS/PowerGrit, IHI, Partner, Imer, Clipper, MMD, Koshin, Rice, CH&E, General Equipment, Amida, Coleman, NAC, Gradall, Square Shooter, Kent, Stanley, Tamco, Toku, Hatz, Kohler, Robin, Wisconsin, Northrock, Oztec, Toker TK, Rol-Air, APT, Wylie, Ingersoll Rand / Doosan, Innovatech, Con X, Ammann, Mecalac, Makinex, Smith Surface Prep, Small Line, Wanco, Yanmar

# SMART

---

## Safety and operating instructions

### Electronic poker

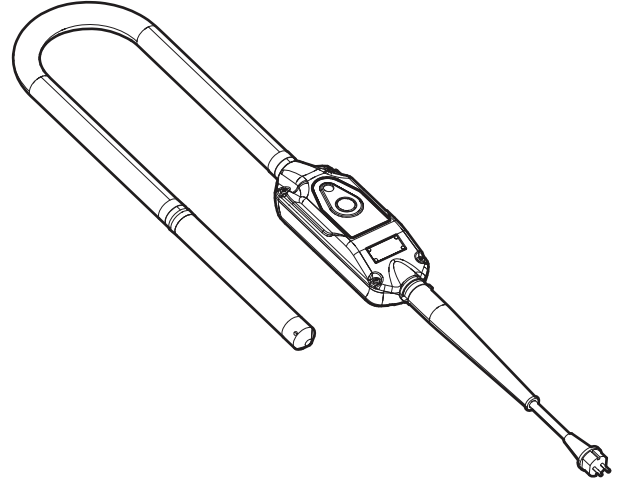

# Contents

|  |           |
|--|-----------|
| Introduction.....                                    | 5         |
| About the Safety and operating instructions.....     | 5         |
| <b>Safety instructions.....</b>                      | <b>6</b>  |
| <b>Safety signal words.....</b>                      | <b>6</b>  |
| <b>General power tools safety warnings.....</b>      | <b>6</b>  |
| .....  | 6         |
| <b>Work area safety.....</b>                         | <b>6</b>  |
| .....  | 6         |
| <b>Electrical safety.....</b>                        | <b>6</b>  |
| .....  | 6         |
| <b>Personal safety.....</b>                          | <b>7</b>  |
| .....  | 7         |
| <b>Power tool use and care.....</b>                  | <b>7</b>  |
| .....  | 7         |
| <b>Service.....</b>                                  | <b>7</b>  |
| .....  | 7         |
| <b>Working area.....</b>                             | <b>8</b>  |
| <b>Electrical safety.....</b>                        | <b>8</b>  |
| <b>Personal safety.....</b>                          | <b>8</b>  |
| Personal protective equipment.....                   | 8         |
| Drugs, alcohol or medication.....                    | 9         |
| <b>Operating, precautions.....</b>                   | <b>10</b> |
| <b>Maintenance, precautions.....</b>                 | <b>11</b> |
| <b>Storage.....</b>                                  | <b>11</b> |
| <b>Overview.....</b>                                 | <b>12</b> |
| <b>Design and function.....</b>                      | <b>12</b> |
| <b>Main parts.....</b>                               | <b>12</b> |
| <b>Labels.....</b>                                   | <b>12</b> |
| Data plate.....                                      | 12        |
| Wiring label.....                                    | 12        |
| Safety label.....                                    | 13        |
| <b>Operation.....</b>                                | <b>13</b> |
| <b>Preparations before vibrating.....</b>            | <b>13</b> |
| Vibrating.....                                       | 13        |
| Operation.....                                       | 13        |
| When taking a break.....                             | 13        |
| <b>Maintenance.....</b>                              | <b>14</b> |
| <b>Vibrating head.....</b>                           | <b>15</b> |
| <b>Connecting the vibrating head.....</b>            | <b>15</b> |
| <b>Vibrating element SMART28E.....</b>               | <b>15</b> |
| <b>Vibrating element SMART40, 48, 56 and 65.....</b> | <b>16</b> |
| <b>Disconnecting the vibrating head.....</b>         | <b>17</b> |
| <b>Storage.....</b>                                  | <b>17</b> |
| <b>Disposal.....</b>                                 | <b>17</b> |
| <b>Troubleshooting.....</b>                          | <b>18</b> |
| <b>Technical data.....</b>                           | <b>19</b> |
| <b>Machine data SMART 40 - SMART 65.....</b>         | <b>19</b> |
| <b>Machine data SMART 28E - SMART 56E.....</b>       | <b>19</b> |

---

|   |    |
|---|----|
| Noise and vibration declaration statement.....    | 19 |
| Noise data.....                                   | 20 |
| Weights and dimensions SMART 40 - SMART 65.....   | 20 |
| Weights and dimensions SMART 28E - SMART 56E..... | 20 |
| EC Declaration of Conformity.....                 | 21 |
| EC Declaration of Conformity .....                | 21 |

## Introduction

Thank you for choosing a product from Atlas Copco. Since 1873, we have been committed to finding new and better ways of fulfilling our customers' needs. Through the years, we have developed innovative and ergonomic product designs that have helped customers improve and rationalize their daily work.

Atlas Copco has a strong global sales and service network, consisting of customer centers and distributors worldwide. Our experts are highly trained professionals with extensive product knowledge and application experience. In all corners of the world, we can offer product support and expertise to ensure that our customers can work at maximum efficiency at all times.

For more information please visit: [www.atlascopco.com](http://www.atlascopco.com)

Construction Tools PC AB  
Box 703  
391 27 Kalmar  
Sweden

## About the Safety and operating instructions

The aim of the instructions is to provide you with knowledge of how to use the machine in an efficient, safe way. The instructions also give you advice and tell you how to perform regular maintenance on the machine.

Before using the machine for the first time you must read these instructions carefully and understand all of them.

## Safety instructions

To reduce the risk of serious injury or death to yourself or others, read and understand the Safety and operating instruction before installing, operating, repairing, maintaining, or changing accessories on the machine.

Post this Safety and operating instruction at work locations, provide copies to employees, and make sure that everyone reads the Safety and operating instruction before operating or servicing the machine. For professional use only.

In addition, the operator or the operator's employer must assess the specific risks that may be present as a result of each use of the machine.

Save all warnings and instructions for future reference.

## Safety signal words

The safety signal words Danger, Warning and Caution have the following meanings:

|                |  |
|----------------|--|
| <b>DANGER</b>  | Indicates a hazardous situation which, if not avoided, will result in death or serious injury.   |
| <b>WARNING</b> | Indicates a hazardous situation which, if not avoided, could result in death or serious injury.  |
| <b>CAUTION</b> | Indicates a hazardous situation which, if not avoided, could result in minor or moderate injury. |

## General power tools safety warnings

**▲ WARNING Read all safety warnings designated by the exclamation mark symbol and all instructions.**

Failure to follow the warnings and instructions may result in electric shock, fire and/or serious injury.

- ▶ Save all warnings and instructions for future reference.
- ▶ The term “power tool” in the warnings refers to your mains-operated (corded) power tool or battery-operated (cordless) power tool.

## Work area safety

**▲ WARNING General power tools safety warnings**

- ▶ Keep work area clean and well lit. Cluttered or dark areas invite accidents.
- ▶ Do not operate power tools in explosive atmospheres, such as in the presence of flammable liquids, gases or dust. Power tools create sparks which may ignite the dust or fumes.
- ▶ Keep children and bystanders away while operating a power tool. Distractions can cause you to lose control.

## Electrical safety

**▲ WARNING General power tools safety warnings**

- ▶ Power tool plugs must match the outlet. Never modify the plug in any way. Do not use any adapter plugs with earthed (grounded) power tools. Unmodified plugs and matching outlets will reduce risk of electric shock.
- ▶ Avoid body contact with earthed or grounded surfaces, such as pipes, radiators, ranges and refrigerators. There is an increased risk of electric shock if your body is earthed or grounded.
- ▶ Do not expose power tools to rain or wet conditions. Water entering a power tool will increase the risk of electric shock.
- ▶ Do not abuse the cord. Never use the cord for carrying, pulling or unplugging the power tool. Keep cord away from heat, oil, sharp edges or moving parts. Damaged or entangled cords increase the risk of electric shock.
- ▶ When operating a power tool outdoors, use an extension cord suitable for outdoor use. Use of a cord suitable for outdoor use reduces the risk of electric shock.
- ▶ If operating a power tool in a damp location is unavoidable, use a residual current device (RCD) protected supply. Use of an RCD reduces the risk of electric shock.

## Personal safety

---

### **▲ WARNING** General power tools safety warnings

- ▶ Stay alert, watch what you are doing and use common sense when operating a power tool. Do not use a power tool while you are tired or under the influence of drugs, alcohol or medication. A moment of inattention while operating power tools may result in serious personal injury.
- ▶ Use personal protective equipment. Always wear eye protection. Protective equipment such as dust mask, non-skid safety shoes, hard hat, or hearing protection used for appropriate conditions will reduce personal injuries.
- ▶ Prevent unintentional starting. Ensure the switch is in the off-position before connecting to power source and/or battery pack, picking up or carrying the tool. Carrying power tools with your finger on the switch or energising power tools that have the switch on invites accidents.
- ▶ Remove any adjusting key or wrench before turning the power tool on. A wrench or a key left attached to a rotating part of the power tool may result in personal injury.
- ▶ Do not overreach. Keep proper footing and balance at all times. This enables better control of the power tool in unexpected situations.
- ▶ Dress properly. Do not wear loose clothing or jewellery. Keep your hair, clothing and gloves away from moving parts. Loose clothes, jewellery or long hair can be caught in moving parts.
- ▶ If devices are provided for the connection of dust extraction and collection facilities, ensure these are connected and properly used. Use of dust collection can reduce dust-related hazards.

## Power tool use and care

---

### **▲ WARNING** General power tools safety warnings

- ▶ Do not force the power tool. Use the correct power tool for your application. The correct power tool will do the job better and safer at the rate for which it was designed.
- ▶ Do not use the power tool if the switch does not turn it on and off. Any power tool that cannot be controlled with the switch is dangerous and must be repaired.
- ▶ Disconnect the plug from the power source and/or the battery pack from the power tool before making any adjustments, changing accessories, or storing power tools. Such preventive safety measures reduce the risk of starting the power tool accidentally.
- ▶ Store idle power tools out of the reach of children and do not allow persons unfamiliar with the power tool or these instructions to operate the power tool. Power tools are dangerous in the hands of untrained users.
- ▶ Maintain power tools. Check for misalignment or binding of moving parts, breakage of parts and any other condition that may affect the power tool's operation. If damaged, have the power tool repaired before use. Many accidents are caused by poorly maintained power tools.
- ▶ Keep cutting tools sharp and clean. Properly maintained cutting tools with sharp cutting edges are less likely to bind and are easier to control.
- ▶ Use the power tool, accessories and tool bits etc. in accordance with these instructions, taking into account the working conditions and the work to be performed. Use of the power tool for operations different from those intended could result in a hazardous situation.

## Service

---

### **▲ WARNING** General power tools safety warnings

Have your power tool serviced by a qualified repair person using only identical replacement parts. This will ensure that the safety of the power tool is maintained.



## Working area

---

### ⚠ DANGER Explosion hazard

If a warm machine comes into contact with explosives, an explosion could occur. During operating with certain materials, sparks and ignition can occur. Explosions will lead to severe injuries or death.

- ▶ Never operate the machine in any explosive environment.
- ▶ Never use the machine near flammable materials, fumes or dust.
- ▶ Make sure that there are no undetected sources of gas or explosives.

### ⚠ WARNING Secure the working area

Cluttered benches and insufficient lighting can cause personal accidents and result in serious injuries.

- ▶ Keep the working area clean.
- ▶ Maintain adequate lighting in the working area.

Only qualified and trained persons may operate or maintain the machine. They must be physically able to handle the bulk, weight, and power of the machine. Always use your common sense and good judgement.

Keep bystanders, children, and visitors away while operating the machine. Distractions may cause loss of control.

## Electrical safety

---

### ⚠ DANGER Electrical hazard

There is a risk of electrical shocks from electrically powered machines which can lead to serious injuries or death.

- ▶ Avoid body contact with earthed (grounded) surfaces.
- ▶ Make sure that there are no concealed wires or other sources of electricity in the working area.
- ▶ Always check that the mains voltage corresponds with that stated on the data plate on the machine.

### ⚠ WARNING Electrical safety

There is a risk of electrical shock if the electrical cable is not treated correctly, if the machine is damaged or modified. This can lead to serious injuries or death.

- ▶ The electrical plug on the machine must match the socket.
- ▶ Never modify the electrical plug to match the socket.
- ▶ Do not use adapter plugs with earthed (grounded) machines.  
Unmodified plugs and matching sockets will reduce the risk of electrical shock.
- ▶ Never move the machine by dragging the electrical cable.
- ▶ Disconnect the cable only by pulling the plug, never pull the electrical cable.
- ▶ Make sure the electrical cable is not pinched in doors, fences or similar.
- ▶ Check that the electrical cable and cable plug are intact and in good condition.
- ▶ Never connect a damaged electrical cable to the machine.
- ▶ Never touch the electrical cable if it becomes damaged during the work. Disconnect the electrical cable plug from the socket.
- ▶ Always make sure that the electrical cable is kept away from water, oil and sharp edges.
- ▶ Do not expose the power tool to rain or wet conditions.  
If water enters the machine, there is an increased risk of electrical shock.
- ▶ Use a residual current device (RCD) protected supply, if the machine must be operated in a damp location.  
The use of an RCD reduces the risk of electrical shock.

## Personal safety

---

### Personal protective equipment

Always use approved protective equipment. Operators and all other persons in the working area must wear protective equipment, including at a minimum:

- Protective helmet
- Hearing protection
- Impact resistant eye protection with side protection
- Respiratory protection when appropriate

- Protective gloves
- Proper protective boots
- Appropriate work overall or similar clothing (not loose-fitting) that covers your arms and legs.

### Drugs, alcohol or medication

#### ▲ **WARNING** Drugs, alcohol or medication

Drugs, alcohol or medication may impair your judgment and powers of concentration. Poor reactions and incorrect assessments can lead to severe accidents or death.

- ▶ Never use the machine when you are tired or under the influence of drugs, alcohol or medication.
- ▶ No person who is under the influence of drugs, alcohol or medication may operate the machine.

#### ▲ **WARNING** Involuntary start

Involuntary start of the machine may cause injury.

- ▶ Keep your hands away from the start and stop device until you are ready to start the machine.
- ▶ Learn how the machine is switched off in the event of an emergency.

#### ▲ **WARNING** Slipping, tripping and falling hazards

There is a risk of slipping or tripping or falling, for example tripping on the hoses or on other objects. Slipping or tripping or falling can cause injury. To reduce this risk:

- ▶ Always make sure that no hose or other object is in your way or in any other person's way.
- ▶ Always make sure you are in a stable position with your feet as far apart as your shoulders width and keeping a balanced body weight.

#### ▲ **WARNING** Dust and fume hazard

Dusts and/or fumes generated or dispersed when using the machine may cause serious and permanent respiratory disease, illness, or other bodily injury (for example, silicosis or other irreversible lung disease that can be fatal, cancer, birth defects, and/or skin inflammation).

Some dusts and fumes created by compaction work contain substances known to the State of California and other authorities to cause respiratory disease, cancer, birth defects, or other reproductive harm. Some examples of such substances are:

- Crystalline silica, cement, and other masonry products.
- Arsenic and chromium from chemically-treated rubber.
- Lead from lead-based paints.

Dust and fumes in the air can be invisible to the naked eye, so do not rely on eye sight to determine if there is dust or fumes in the air.

To reduce the risk of exposure to dust and fumes, do all of the following:

- ▶ Perform site-specific risk assessment. The risk assessment must include dust and fumes created by the use of the machine and the potential for disturbing existing dust.
- ▶ Use proper engineering controls to minimize the amount of dust and fumes in the air and to minimize build-up on equipment, surfaces, clothing, and body parts. Examples of controls include: exhaust ventilation and dust collection systems, water sprays, and wet drilling. Control dusts and fumes at the source where possible. Make sure that controls are properly installed, maintained and correctly used.
- ▶ Wear, maintain and correctly use respiratory protection as instructed by your employer and as required by occupational health and safety regulations. The respiratory protection must be effective for the type of substance at issue (and if applicable, approved by relevant governmental authority).
- ▶ Work in a well ventilated area.
- ▶ If the machine has an exhaust, direct the exhaust so as to reduce disturbance of dust in a dust filled environment.
- ▶ Operate and maintain the machine as recommended in the operating and safety instructions
- ▶ Wear washable or disposable protective clothes at the worksite, and shower and change into clean clothes before leaving the worksite to reduce exposure of dust and fumes to yourself, other persons, cars, homes, and other areas.

- ▶ Avoid eating, drinking, and using tobacco products in areas where there is dust or fumes.
- ▶ Wash your hands and face thoroughly as soon as possible upon leaving the exposure area, and always before eating, drinking, using tobacco products, or making contact with other persons.
- ▶ Comply with all applicable laws and regulations, including occupational health and safety regulations.
- ▶ Participate in air monitoring, medical examination programs, and health and safety training programs provided by your employer or trade organizations and in accordance with occupational health and safety regulations and recommendations. Consult with physicians experienced in relevant occupational medicine.
- ▶ Work with your employer and trade organization to reduce dust and fume exposure at the worksite and to reduce the risks. Effective health and safety programs, policies and procedures for protecting workers and others against harmful exposure to dust and fumes must be established and implemented based on advice from health and safety experts. Consult with experts.

## Operating, precautions

### ▲ **WARNING** Incorrect usage

An incorrect use of the machine, accessories, and insertion tools/ cutting blades can result in serious injuries or a hazardous situation.

- ▶ Use the machine, accessories and tools in accordance with the safety instructions.
- ▶ Use the machine for what it is designed for, and in the way it is intended.
- ▶ Use the correct machine for the work that is going to be performed.
- ▶ Do not force the machine while operating.
- ▶ Take the working conditions into account.

### ▲ **WARNING** Broken power switch

The power switch does not control the machine. A broken power switch is dangerous and must be repaired.

- ▶ Do not use the machine if the power switch is broken and cannot be controlled.
- ▶ Maintain the power switch.

### ▲ **WARNING** Projectiles

Failure of the work piece, of accessories, or even of the machine itself may generate high velocity projectiles. During operating, splinters or other particles from the compacted material may become projectiles and cause personal injury by striking the operator or other persons. To reduce these risk:

- ▶ Use approved personal protective equipment and safety helmet, including impact resistant eye protection with side protection.
- ▶ Make sure that no unauthorised persons trespass into the working zone.
- ▶ Keep the workplace free from foreign objects.

### ▲ **WARNING** Unexpected movements

The machine is exposed to heavy strains during operation. If the machine breaks or gets stuck, there may be sudden and unexpected movement that can cause injuries.

- ▶ Always inspect the machine prior to use. Never use the machine if you suspect that it is damaged.
- ▶ Make sure that the handle is clean and free of grease and oil.
- ▶ Keep your feet away from the machine.
- ▶ Never sit on the machine.
- ▶ Never strike or abuse the machine.
- ▶ Pay attention and look at what you are doing.

**▲ WARNING Vibration hazards**

Normal and proper use of the machine exposes the operator to vibration. Regular and frequent exposure to vibration may cause, contribute to, or aggravate injury or disorders to the operator's fingers, hands, wrists, arms, shoulders and/or nerves and blood supply or other body parts, including debilitating and/or permanent injuries or disorders that may develop gradually over periods of weeks, months, or years. Such injuries or disorders may include damage to the blood circulatory system, damage to the nervous system, damage to joints, and possibly damage to other body structures.

If numbness, persistent recurring discomfort, burning sensation, stiffness, throbbing, tingling, pain, clumsiness, weakened grip, whitening of the skin, or other symptoms occur at any time, when operating the machine or when not operating the machine, stop operating the machine, tell your employer and seek medical attention. Continued use of the machine after the occurrence of any such symptom may increase the risk of symptoms becoming more severe and/or permanent.

Operate and maintain the machine as recommended in these instructions, to prevent an unnecessary increase in vibration.

The following may help to reduce exposure to vibration for the operator:

- ▶ If the machine has vibration absorbing handles, keep them in a central position, avoid pressing the handles into the end stops.
- ▶ Make sure that the machine is well-maintained and not worn out.
- ▶ Immediately stop working if the machine suddenly starts to vibrate strongly. Before resuming the work, find and remove the cause of the increased vibrations.
- ▶ Participate in health surveillance or monitoring, medical exams and training programs offered by your employer and when required by law.
- ▶ When working in cold conditions wear warm clothing and keep hands warm and dry.

See the "Noise and vibration declaration statement" for the machine, including the declared vibration values. This information can be found at the end of these Safety and operating instructions.

**▲ WARNING Noise hazard**

High noise levels can cause permanent and disabling hearing loss and other problems such as tinnitus (ringing, buzzing, whistling, or humming in the ears). To reduce risks and prevent an unnecessary increase in noise levels:

- ▶ Risk assessment of these hazards and implementation of appropriate controls is essential.
- ▶ Operate and maintain the machine as recommended in these instructions.
- ▶ If the machine has a silencer, check that it is in place and in good working condition.
- ▶ Always use hearing protection.

**▲ WARNING Accessory hazards**

Accidental engagement of accessories during maintenance or installation can cause serious injuries, when the power source is connected.

- ▶ Never inspect, clean, install, or remove accessories while the power source is connected.

## Maintenance, precautions

---

**▲ WARNING Machine modification**

Any machine modification may result in bodily injuries to yourself or others.

- ▶ Never modify the machine. Modified machines are not covered by warranty or product liability.
- ▶ Always use original parts and accessories.
- ▶ Change damaged parts immediately.
- ▶ Replace worn components in good time.

**▲ WARNING Damaged machine parts**

Lack of maintenance will result in damaged or worn parts that can cause accidents.

- ▶ Check the moving parts for misalignment or binding.
- ▶ Check the machine for broken or, in other ways, damaged parts.  
Damaged or worn parts can effect the operation of the machine.

## Storage

---

- ◆ Keep the machine in a safe place, out of the reach of children and locked up.

# Overview

To reduce the risk of serious injury or death to yourself or others, read the Safety instructions section found on the previous pages of this manual before operating the machine.

# Design and function

SMART is designed with a built in frequency converter combined with an electrical poker for concrete vibrating. No other use is permitted. The SMART's electronic components consist of resin moulded components, ensuring optimal protection. The assembly is located in an aluminium casing that also includes a start and stop switch. For professional use only.

# Main parts

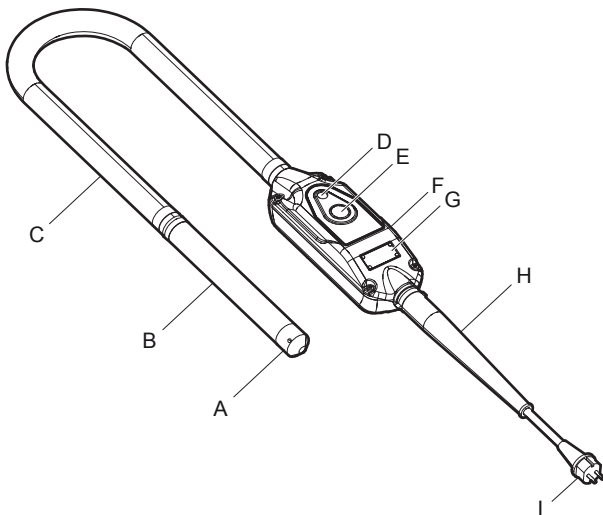

- A. End cap
- B. Vibrator
- C. Hose
- D. LED indicator
- E. ON/OFF switch
- F. Control unit
- G. Data plate
- H. Rubber sleeve
- I. Electric cable with power connector

# Labels

The machine is fitted with labels containing important information about personal safety and machine maintenance. The labels must be in such condition that they are easy to read. New labels can be ordered from the spare parts list.

## Data plate

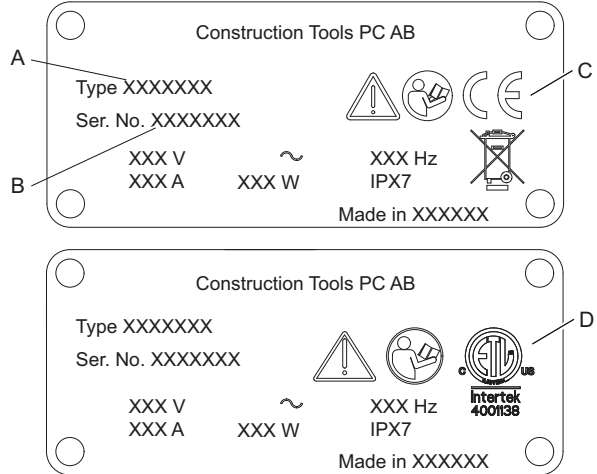

- A. Machine type.
- B. Product identification number.
- C. The CE symbol means that the machine is EC approved. See the EC Declaration of Conformity which is delivered with the machine for more information.
- D. The ETL symbol means that the machine is ETL certified.

## Wiring label

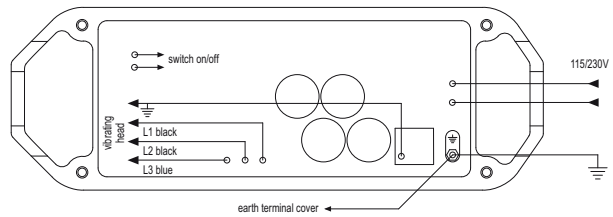

## Safety label



- ◆ Instruction manual. The operator must read the Safety and operating instructions before operating the machine.
- ◆ Use protective gloves.
- ◆ Use ear protectors.

## Operation

### Preparations before vibrating

**NOTICE** Only use the SMART poker with a residual current device (RCD) protected supply.

The SMART is an earthed class 1 device.

The RCD must have a protection for 16 amperes or greater.

The SMART is fitted with overheating protection. Avoid placing the device in direct sunlight, this could lead to possible stops.

### Vibrating

#### Operation

**NOTICE** The SMART28E is for laboratory purposes only, do not use for work site applications.

1. Connect the SMART to a suitable socket.
2. Start vibration by pressing the on/off switch.
3. The vibration starts after 1.5 seconds.
4. Stop vibration by pressing the on/off switch again.

**NOTICE** Never use the poker vibrator to move the concrete sideways.

1. Allow the vibrator to penetrate about 15 cm (6 in.) down into the nearest lower layer to ensure that the various layers merge well with each other.
2. Fill the concrete evenly in the form work in 30 - 50 cm (12 - 19 in.) layers.

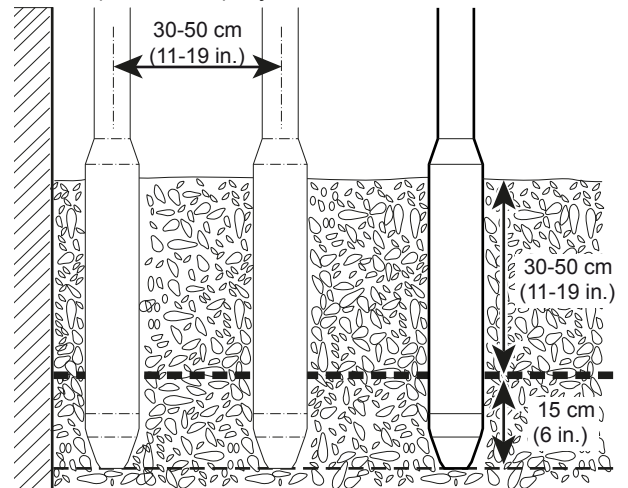

3. Insert the poker vibrator vertically at a distance of 8-10 times the tube diameter between insertions.
4. Vibrate systematically.
5. Slowly withdraw the vibrator to allow the concrete to refill the cavity left by the vibrator.
6. The concrete is thoroughly vibrated when the area around the vibrator turns shiny and no air bubbles rise to the surface. This will normally take about 10-20 seconds.

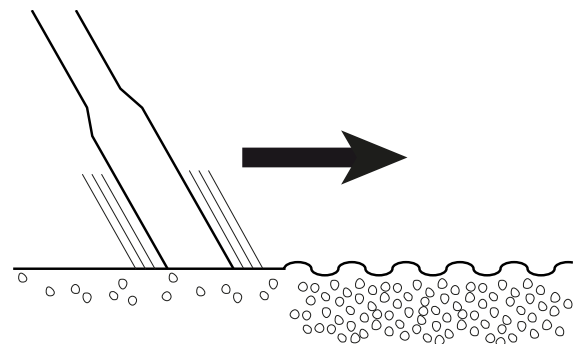

### When taking a break

- ◆ During all breaks you must place the machine in such a way that there is no risk for it to be unintentionally started. Make sure to place the machine on the ground, so that it can not fall.
- ◆ Switch off the power supply in the event of a longer break or when leaving the workplace.

# Maintenance

Regular maintenance is a basic requirement for the continued safe and efficient use of the machine. Follow the maintenance instructions carefully.

- ◆ Before starting maintenance on the machine, clean it in order to avoid exposure to hazardous substances. See “Dust and fume hazard”.
- ◆ Use only authorised parts. Any damage or malfunction caused by the use of unauthorised parts is not covered by warranty or product liability.
- ◆ When cleaning mechanical parts with solvent, comply with appropriate health and safety regulations and ensure there is satisfactory ventilation.
- ◆ For major service of the machine, contact the nearest authorised workshop.
- ◆ After each service, check that the machine's vibration level is normal. If not, contact the nearest authorised workshop.

The SMART is maintenance free, except for cleaning. The converter case must be clean to get the best cooling effect.

**NOTICE** The unit contains components which have dangerously high voltages. Wait 2 minutes before any dismantling is performed.

**NOTICE** Never use high-pressure water to clean the drive unit.

### Tripping of residual current device (RCD):

1. Inspect cable and plug, replace any damaged or defective parts.
2. If the problem remains, replace the converter.

### Problem with the converter:

1. Press the switch to stop the converter.
2. Wait 30 seconds.
3. Press the switch to start the converter. If the converter started again, it was overloaded due to a defective mechanical part or the poker got stuck in the steel reinforcement.

### Inefficient vibration:

1. With the machine unplugged and power removed, short circuit between phases on the poker side:  
Disconnect the wires from the converter to the vibrating head. Measure the resistance between phases on poker side. Compare the values with those stated on the poker with the table, see below. If the values are incorrect, inspect the wiring and the tube stator. Replace the defective part.
2. Short circuit between phases and ground (earth):  
Measure the resistance between each phase and the ground (earth). If the resistance is 10 Mega ohms or less, inspect the wiring and the stator tube. Replace the defective part.
3. Overload:  
Raise the poker from the concrete, measure the input current to the poker (see the table below for maximum values). The measurements are taken after two minutes. If the measured values do not correspond with the values stated in the table, dismantle the vibrator tube and check the mechanical parts. Replace the defective part. If the mechanical parts are correct, there is an overload in the converter. Check the input current to the poker when the poker is immersed in the concrete. Make sure that the current does not permanently exceed the ampere stated on the data plate.
4. Overheating: temperature of the converter casing is >60°C (140°F).  
This could be caused by overload or too high ambient temperature.  
Wait until the temperature of the casing has decreased by 10°C (50°F), then press the ON/OFF switch.

|                | Voltage, V | Stator resistance, Ohm | Input current*, A |
|----------------|------------|------------------------|-------------------|
| SMART 28E      | 230        | 36                     | 0.9               |
| SMART 40 / 40E | 230        | 26.50                  | 1.9               |
| SMART 40 / 40E | 115        | 6.60                   | 3.8               |
| SMART 48 / 48E | 230        | 9.30                   | 2.2               |
| SMART 48 / 48E | 115        | 2.40                   | 4.4               |
| SMART 56 / 56E | 230        | 5.60                   | 2.7               |
| SMART 56 / 56E | 115        | 1.50                   | 5.4               |
| SMART 65       | 230        | 2.60                   | 3.7               |

\* When the poker is raised out of the concrete.

## Vibrating head

The vibrating head is maintenance free and lubricated with oil. When replacing the vibrating head it must be lubricated with the right amount of oil. The end cap of the vibrating head is glued and must be tightened and glued in the right way.

### Lubrication

| SMART                               |           |            |           |             |           |
|-------------------------------------|-----------|------------|-----------|-------------|-----------|
| Vibrating head                      | 28E       | 40/40E     | 48/48E    | 56/56E      | 65        |
| Shell T46 oil, cm <sup>3</sup> (cl) | 10<br>(1) | 5<br>(0.5) | 10<br>(1) | 15<br>(1.5) | 20<br>(2) |

**NOTICE** Before fitting a new end cap, carefully clean the threads. Before gluing the parts together they must be perfectly dry with no oil or grease.

1. Apply four glue strings vertically over the end cap threads. Make sure that no glue comes inside the tube.
2. Tighten the end cap to the specified torque.
3. Let the glue polymerize for six hours before use.

| SMART |                |              |                       |        |        |        |        |
|-------|----------------|--------------|-----------------------|--------|--------|--------|--------|
|       | Vibrating head | Gluing       | Tightening torque, Nm |        |        |        |        |
|       |                |              | 28E                   | 40/40E | 48/48E | 56/56E | 65/65E |
| A     | End cap        | LOCTITE®243™ | 75                    | -      | -      | -      | -      |
| B     | Reducer        | LOCTITE®243™ | 120                   | -      | -      | -      | -      |
| C     | Screw          | LOCTITE®243™ | -                     | -      | -      | -      | -      |
| D     | End cap        | LOCTITE®638™ | -                     | 170    | 350    | 520    | 750    |
| E     | Screw          | -            | -                     | 5      | 8      | 8      | 20     |
| F     | Nipple         | LOCTITE®243™ | -                     | 120    | 200    | 250    | 250    |
| G     | Thrust screw   | LOCTITE®243™ | -                     | -      | -      | -      | -      |
| H     | Screw          | LOCTITE®243™ | -                     | -      | -      | -      | -      |

LOCTITE®243™, LOCTITE®638™ are a registered trademark of Henkel Corporation. 243, 638 is a trademark of Henkel Corporation.

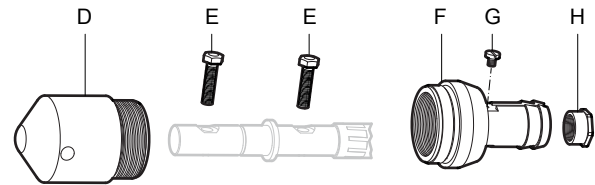
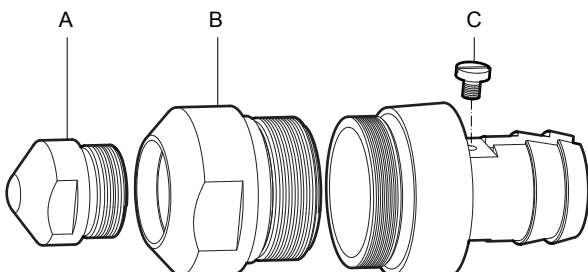

**NOTICE** Do not grease the inner shafts too extensively. Greasing too much can cause overload of the electric drive unit and trip the circuit breaker. Run the unit for two minutes continuously to distribute the grease in the flexible shaft before immersion in the concrete.

## Connecting the vibrating head

1. Connect the ground (earth) wire on the poker nipple. Use LOCTITE®243™ to glue the screw on the poker.
2. Use connectors and thermo-insulation to connect the wires to the poker stator.
3. Slide the red hose over the wires and place the hose close to the poker gland.
4. Fix the hose on the poker nipple by using a clamp.
5. Slide the wires inside the converter casing, through the gland.
6. Fasten the nut and fit the hose over the converter casing nipple and fix it with a clamp.
7. Use new connectors to connect the wires in the converter.
8. Fit the cover to the converter.

LOCTITE®243™ is a registered trademark of Henkel Corporation. 243 is a trademark of Henkel Corporation.

## Vibrating element SMART28E

### Disassembly



1. Unscrew the reducer (A) from the stator tube (B) (left hand thread). The stator is glued inside the tube.
2. Remove the complete tube (C) including the end cap from the stator tube (B).
3. Remove the spring washer (D).

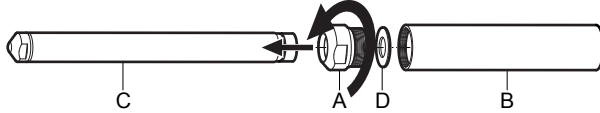

4. Slide and remove the rotor (G), the excenter (E) and the ball bearing (F).

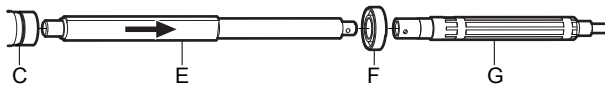

5. Unscrew the nut (H) (right hand thread), and remove the rubber gasket (I).
6. Unscrew the nipple (J) (right hand thread).

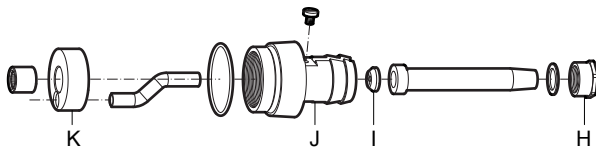

7. Use a suitable rod and a mallet to gently press the bearing holder (K) to remove the holder.

**Assembly**

1. Assemble the vibrating element in the reverse order. Clean all parts before the assembly.
2. Replace the damaged parts and the O-rings systematically.
3. Fill the vibrating element with oil. (See the section Lubrication for information about type and amount of oil.)

**Vibrating element SMART40, 48, 56 and 65**

**Disassembly**

1. Unscrew the end cap (A) from the stator tube (B) (left hand thread). The stator is glued inside the tube.

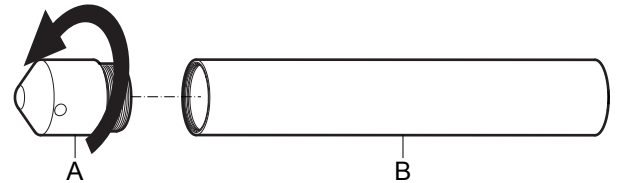

2. Unscrew the nut (C) (right hand thread), and remove the flexible sheathing (D) and the rubber gasket (E).
3. Unscrew the nipple (F) (right hand thread).

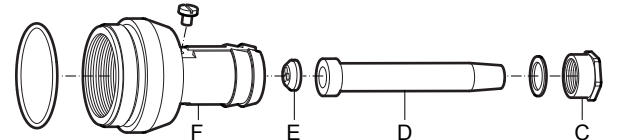

4. Use a suitable rod and a mallet to gently press the rotor (G) through the bearing holder (H). After the removal of the bearing holder (H), remove the eccentrics (I) and the eccentrics screws (J). The bearing (K) can be removed after the eccentrics have been removed.

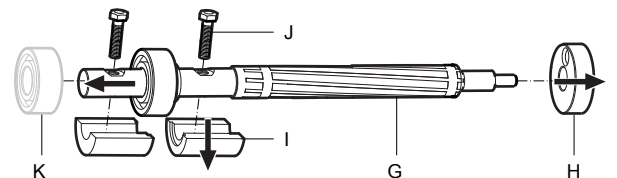

**Assembly**

1. Assemble the vibrating element in the reverse order. Clean all parts before the assembly.
2. Replace the damaged parts and the O-rings systematically.
3. Fill the vibrating element with oil. (See the section Lubrication for information about type and amount of oil.)

**NOTICE** Carefully clean the threads on the end cap and the tube before gluing with LOCTITE®638™ . The threads must be perfectly clean and contain no residues of oil or dust.

LOCTITE is a registered trademark of Henkel Corporation. 638 is a trademark of Henkel Corporation.

## Disconnecting the vibrating head

1. Disconnect the SMART from the power socket.
2. Cut the clamp that holds the wires on the converter side.
3. Remove the cover from the converter.
4. Cut the three connector wires and unscrew the ground (earth) wire.
5. Pull the hose from the converter side and unscrew the nut from the casing.
6. Put the vibrating element in a tube vice and clamp it.
7. Cut the clamp that holds the wires on the poker side, then pull the red hose until the connectors appear.
8. Cut the thermo-insulation and disconnect the terminals.
9. Disconnect the ground (earth) wire from the nipple.

The electronic and electrical devices may contain potentially hazardous substances. Do not dispose of them in the nature. Dispose them according to local laws and regulations for the country of use. According to the European directives RoHS 2011/65/EC and WEEE 2012/19/EC.

## Storage

- ◆ Clean the machine properly before storage, in order to avoid hazardous substances. See section "Dust and fume hazard".
- ◆ Always store the machine in a dry place.
- ◆ Keep the machine in a safe place, out of the reach of children and locked up.

## Disposal

A used machine must be treated and disposed in such way that the greatest possible portion of the material can be recycled and any negative influence on the environment is kept as low as possible, and in accordance with local restrictions.

Always send used filters and drained oil remnants to environmentally correct disposal.



# Troubleshooting

| Problem                           | Cause  | Solution   |
|-----------------------------------|--|--|
| The SMART stops during operation. | The RCD breaker has detected a fault.  | Check the cables or converter. Replace the cable or converter.                                 |
| The SMART stops during operation. | The SMART microprocessor has detected a fault.<br>The internal vibrator is overloaded (when operating in concrete or rebar). | Check for short circuit between the phases on the poker side.                                  |
|                                   |  | Check for short circuit between the phases and (ground) earth on the poker side.               |
|                                   |  | Overload.  |
|                                   |  | Overheating. This can occur when the temperature of the cover casing is too high >60°C (140°F) |

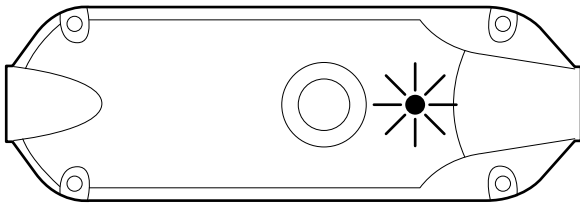

| LED status              | SMART status  | Action   |
|-------------------------|---|--|
| Steady green.           | No fault.<br>Connected to the power source.   | -  |
| Flashing green.         | Work in progress.<br>Limitation of current.   | Check if the vibrating head is blocked or overloaded.  |
| Flashing red.           | Converter box is overheating.<br>Vibrating head is overheating.   | Let the converter or vibrating head cool down for a few minutes then try to restart the poker.           |
| Flashing green and red. | Overvoltage or undervoltage.  | Check the voltage of the power source.   |
| Steady red.             | Overload.<br>Short circuit between phases.<br>Insulation fault in the vibrating head.<br>Internal problem in the converter. | Check the converter and vibrator head for damage. If necessary send the poker to an authorised workshop. |

## Technical data

### Machine data SMART 40 - SMART 65

|  | SMART          |                |                |                |
|--|----------------|----------------|----------------|----------------|
|  | 40             | 48             | 56             | 65             |
| Voltage, (V)   | 230<br>115     | 230<br>115     | 230<br>115     | 230            |
| Phases   | 1              | 1              | 1              | 1              |
| Frequency, (Hz)  | 50/60          | 50/60          | 50/60          | 50/60          |
| Power, (W)   | 400            | 920            | 1,170          | 1,800          |
| Amperage, (A) 230V/115V  | 2.5/5          | 4.5/9          | 6.4/12.8       | 10             |
| Protection   | IPX4           | IPX7           | IPX7           | IPX7           |
| Speed at full load, r.p.m.   | 12,000         | 12,000         | 12,000         | 12,000         |
| Cable length, m (ft)   | 15 (49.2)      | 15 (49.2)      | 15 (49.2)      | 15 (49.2)      |
| Weighted effective acceleration uncertainty (K) m/s <sup>2</sup> * | 3.81<br>(0.42) | 2.47<br>(0.44) | 5.87<br>(1.00) | 4.62<br>(0.66) |

\* Weighted effective acceleration measured in water at 2 meter (6.56 ft.) from the end of the poker according to EN ISO 5349.

### Machine data SMART 28E - SMART 56E

|  | SMART     |            |            |            |
|--|-----------|------------|------------|------------|
|  | 28E       | 40E        | 48E        | 56E        |
| Voltage, (V)   | 230       | 230<br>115 | 230<br>115 | 230<br>115 |
| Phases   | 1         | 1          | 1          | 1          |
| Frequency, (Hz)  | 50/60     | 50/60      | 50/60      | 50/60      |
| Power, (W)   | 260       | 400        | 920        | 1,170      |
| Amperage, (A)  | 1.3       | 2.5        | 4.5        | 6.4        |
| Protection   | IPX7      | IPX7       | IPX7       | IPX7       |
| Speed at full load, r.p.m.   | 12,000    | 12,000     | 12,000     | 12,000     |
| Cable length (plug to converter), m (ft)                           | 15 (49.2) | 15 (49.2)  | 15 (49.2)  | 15 (49.2)  |
| Cable length (converter to handle) 115V, m (ft)                    | 10 (32.8) | 10 (32.8)  | 10 (32.8)  | 10 (32.8)  |
| Cable length (converter to handle) 230V, m (ft)                    | 15 (49.2) | 15 (49.2)  | 15 (49.2)  | 15 (49.2)  |
| Weighted effective acceleration uncertainty (K) m/s <sup>2</sup> * | <2.5      | <2.5       | <2.5       | <2.5       |

\* Weighted effective acceleration measured in water at 2 meter (6.56 ft.) from the end of the poker according to EN ISO 5349.

## Noise and vibration declaration statement

Guaranteed sound power level **L<sub>wa</sub>** according to EN ISO 3744 in accordance with directive 2000/14/EC.

Sound pressure level **L<sub>pa</sub>** according to EN ISO 11203.

Vibration value determined according to Vib\_ISO - volume, EN ISO 5349-2. See table "Noise and vibration data" for the values etc.

These declared values were obtained by laboratory type testing in accordance with the stated directive or standards and are suitable for comparison with the declared values of other machines tested in accordance with the same directive or standards. These declared values are not suitable for use in risk assessments and values measured in individual work places may be higher. The actual exposure values and risk of harm experienced by an individual user are unique and depend upon the way the user works, in what material the

machine is used, as well as upon the exposure time and the physical condition of the user, and the condition of the machine.

We, Construction Tools PC AB, cannot be held liable for the consequences of using the declared values, instead of values reflecting the actual exposure, in an individual risk assessment in a work place situation over which we have no control.

This machine may cause hand-arm vibration syndrome if its use is not adequately managed. An EU guide to managing hand-arm vibration can be found at <http://www.humanvibration.com/humanvibration/EU/VIBGUIDE.html>

We recommend a programme of health surveillance to detect early symptoms which may relate to vibration exposure, so that management procedures can be modified to help prevent future impairment.

## Noise data

| Noise           |     |     |
|-----------------|-----|-----|
| Declared values |     |     |
| Sound pressure  |     |     |
| EN ISO 3744     |     |     |
| Type            | LpA | LwA |
| SMART 40        | 75  | 86  |
| SMART 48        | 80  | 91  |
| SMART 56        | 83  | 94  |
| SMART 65        | 88  | 99  |
| SMART 28E       | 85  | 96  |
| SMART 40E       | 75  | 86  |
| SMART 48E       | 80  | 91  |
| SMART 56E       | 83  | 94  |

Noise level measured in air at 1m from the poker according to EN ISO 3744. Uncertainty: ± 3dB

## Weights and dimensions SMART 40 - SMART 65

|  | SMART                                  |  |  |  |
|--|--|--|--|--|
|  | 40                                     | 48                                     | 56                                     | 65                                     |
| Converter weight, kg (lbs)                     | 2.8 (6.17)                             | 2.8 (6.17)                             | 2.8 (6.17)                             | 2.8 (6.17)                             |
| Operating weight, kg (lbs)                     | 13.1 (28.88)                           | 14.7 (32.40)                           | 15.9 (35.05)                           | 18.5 (40.78)                           |
| Dimensions of converter:<br>L x W x H mm (in.) | 300 x 103 x 80<br>(11.8 x 4.05 x 3.14) | 300 x 103 x 80<br>(11.8 x 4.05 x 3.14) | 300 x 103 x 80<br>(11.8 x 4.05 x 3.14) | 300 x 103 x 80<br>(11.8 x 4.05 x 3.14) |
| Tube diameter, mm (in.)                        | 40 (1.58)                              | 48 (1.90)                              | 56 (2.20)                              | 65 (2.56)                              |
| Tube length, m (ft)                            | 3.20 (10.49)                           | 3.50 (11.48)                           | 3.80 (12.46)                           | 4.10 (13.45)                           |
| Tube weight, kg (lbs)                          | 2.3 (5)                                | 3.9 (8.6)                              | 5.1 (11.2)                             | 7.7 (16.9)                             |

## Weights and dimensions SMART 28E - SMART 56E

|  | SMART                                  |  |  |  |
|--|--|--|--|--|
|  | 28E                                    | 40E                                    | 48E                                    | 56E                                    |
| Converter weight, kg (lbs)                     | 2.8 (6.17)                             | 2.8 (6.17)                             | 2.8 (6.17)                             | 2.8 (6.17)                             |
| Operating weight, kg (lbs)                     | 12 (26.40)                             | 12 (26.40)                             | 13.6 (29.98)                           | 14.8 (32.63)                           |
| Dimensions of converter:<br>L x W x H mm (in.) | 300 x 103 x 80<br>(11.8 x 4.05 x 3.14) | 300 x 103 x 80<br>(11.8 x 4.05 x 3.14) | 300 x 103 x 80<br>(11.8 x 4.05 x 3.14) | 300 x 103 x 80<br>(11.8 x 4.05 x 3.14) |
| Tube diameter, mm (in.)                        | 25/40 (0.98/1.58)                      | 40 (1.58)                              | 48 (1.90)                              | 56 (2.20)                              |
| Tube length, m (ft)                            | 2.39/2.11 (7.84/6.92)                  | 3.20 (10.49)                           | 3.50 (11.48)                           | 3.80 (12.46)                           |
| Tube weight, kg (lbs)                          | 2.4 (5.3)                              | 2.3 (5.0)                              | 4.2 (9.3)                              | 5.2 (11.5)                             |

# EC Declaration of Conformity

## EC Declaration of Conformity

We, Construction Tools PC AB, hereby declare that the machines listed below conform to the provisions of EC Directive 2006/42/EC (Machinery Directive), 2006/95/EC (Low voltage), 2004/108/EC (EMC), 2002/96/EC, 2011/65/EU RoHS 2, and the harmonised standards mentioned below.

| Type                 | Input power (kW) | Speed at full load (min-1) | Weight(kg) |
|----------------------|------------------|----------------------------|------------|
| Electronic poker 40  | 0.40             | 12,000                     | 13.1       |
| Electronic poker 48  | 0.92             | 12,000                     | 14.7       |
| Electronic poker 56  | 1.17             | 12,000                     | 15.9       |
| Electronic poker 65  | 1.80             | 12,000                     | 18.5       |
| Electronic poker 28E | 0.26             | 12,000                     | 12.0       |
| Electronic poker 40E | 0.40             | 12,000                     | 12.0       |
| Electronic poker 48E | 0.92             | 12,000                     | 13.6       |
| Electronic poker 56E | 1.17             | 12,000                     | 14.8       |

### Following harmonised standards were applied:

- ◆ EN 60745-1
- ◆ EN 60745-2-12:2006
- ◆ EN 12649

### Notified body involved for directive:

NoBo no.0038  
 Lloyd's Register Verification Limited  
 71 Fenchurch Street  
 London EC3M 4BS  
 United Kingdom

### Technical Documentation authorised representative:

Peter Karlsson  
 Construction Tools PC AB  
 Box 703  
 391 27 Kalmar  
 Sweden

### Vice President Design and Development:

Erik Sigfridsson

### Manufacturer:

Construction Tools PC AB  
 Box 703  
 391 27 Kalmar  
 Sweden

### Place and date:

Kalmar, 2016-04-15

**TO PURCHASE THIS PRODUCT PLEASE CONTACT US**



**Equipment Financing and  
Extended Warranties Available**



**Discount-Equipment.com is your online resource for  
commercial and industrial quality parts and equipment sales.**

**561-964-4949**

**visit us on line @ [www.discount-equipment.com](http://www.discount-equipment.com)**

Select an option below to find your Equipment

**Search by Manufacturer**

**Search by Product Type**

**Request a Quote**

We sell worldwide for the brands: Genie, Terex, JLG, MultiQuip, Mikasa, Essick, Whiteman, Mayco, Toro Stone, Diamond Products, Generac Magnum, Airman, Haulotte, Barreto, Power Blanket, Nifty Lift, Atlas Copco, Chicago Pneumatic, Allmand, Miller Curber, Skyjack, Lull, Skytrak, Tsurumi, Husquvarna Target, Stow, Wacker, Sakai, Mi-T-M, Sullair, Basic, Dynapac, MBW, Weber, Bartell, Bennar Newman, Haulotte, Ditch Runner, Menegotti, Morrison, Contec, Buddy, Crown, Edco, Wyco, Bomag, Laymor, EZ Trench, Bil-Jax, F.S. Curtis, Gehl Pavers, Heli, Honda, ICS/PowerGrit, IHI, Partner, Imer, Clipper, MMD, Koshin, Rice, CH&E, General Equipment, Amida, Coleman, NAC, Gradall, Square Shooter, Kent, Stanley, Tamco, Toku, Hatz, Kohler, Robin, Wisconsin, Northrock, Oztec, Toker TK, Rol-Air, APT, Wylie, Ingersoll Rand / Doosan, Innovatech, Con X, Ammann, Mecalac, Makinex, Smith Surface Prep, Small Line, Wanco, Yanmar



[www.Discount-Equipment.com](http://www.Discount-Equipment.com)

Any unauthorized use or copying of the contents or any part thereof is prohibited.  
This applies in particular to trademarks, model denominations, part numbers, and drawings.

© 2016 Construction Tools PC AB | No. 9800 1207 01d | 2016-06-21

**Atlas Copco**