

GENERAC®

MAGNUM

**GASEOUS GENERATOR
MGG155 • MGG210
OPERATING MANUAL**

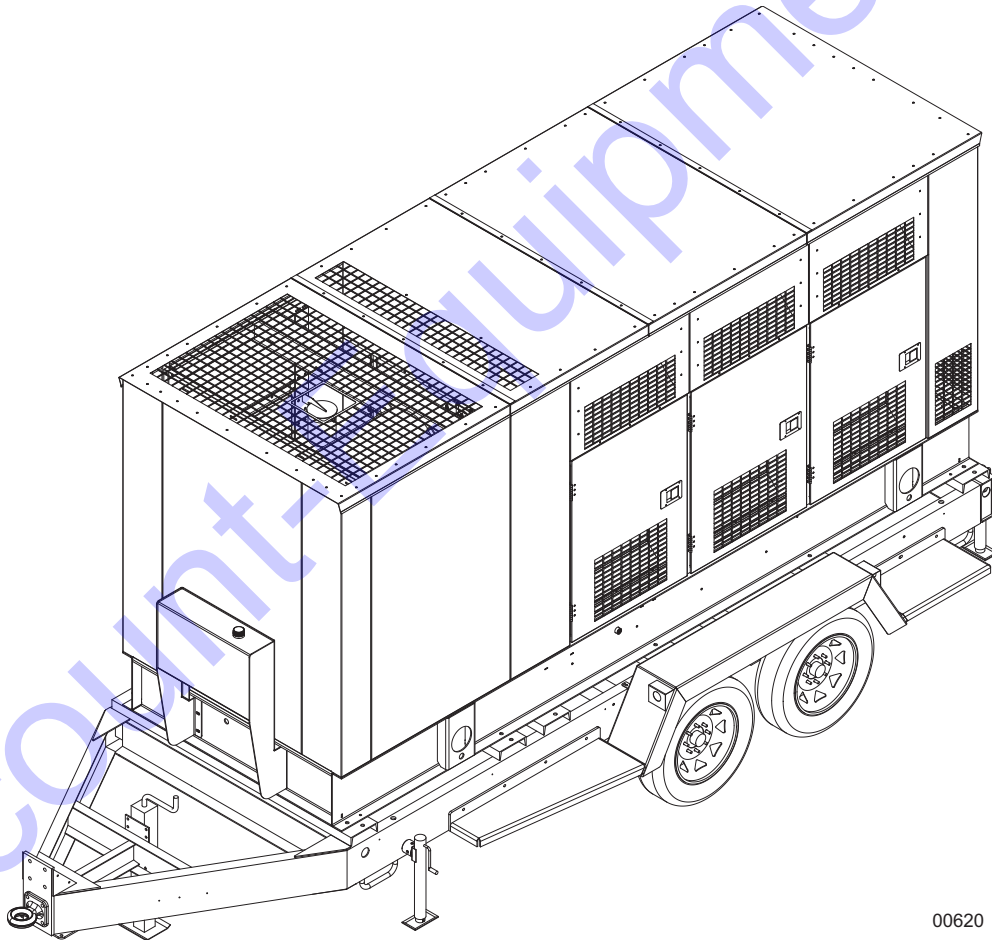

00620



www.discount-equipment.com

Discount Equipment

Discount-Equipment.com is your online resource for commercial and industrial quality parts and equipment sales.

Locations:

Florida (West Palm Beach): [561-964-4949](tel:561-964-4949)

Outside Florida TOLL FREE: [877-690-3101](tel:877-690-3101)

Need parts? Check out our website at www.discount-equipment.com

Can't find what you need?

Click on this link: <http://www.discount-equipment.com/category/5443-parts/> and fill out the request form.

Please have the machine model and serial number available in order to help us get you the correct parts. One of our experienced staff members will get back to you with a quote for the right part that your machine needs.

We sell worldwide for the brands: Genie, Terex, JLG, MultiQuip, Mayco, Toro/Stone, Diamond Products, Magnum, Airman, Mustang, Power Blanket, Nifty Lift, Atlas Copco, Chicago Pneumatic, Allmand Brothers, Essick, Miller Spreader, Skyjack, Lull, Skytrak, Tsurumi, Husquvarna/Target, Whiteman-Concrete/Mortar, Stow-Concrete/Mortar, Baldor, Wacker, Sakai, Snorkel, Upright, Mi-T-M, Sullair, Neal, Basic, Dynapac, MBW, Weber, Bartell, Bennar Newman, Haulotte, Ditch Runner, Blaw-Knox, Himoina, Best, Buddy, Crown, Edco, Wyco, Bomag, Laymor, Terremite, Barreto, EZ Trench, Takeuchi, Basic, Bil-Jax, Curtis, Gehl, Heli, Honda, ICS/PowerGrit, Puckett, Waldon, ASV, IHI, Partner, Imer, Clipper, MMD, Koshin, Rice, Gorman Rupp, CH&E, Cat Pumps, Comet, General Pump, Giant, AMida, Coleman, NAC, Gradall, Square Shooter, Kent, Stanley, Tamco, Toku, Hatz, Kohler, Robin, Wisconsin, Northrock, Oztec, Toker TK, Rol-Air, Small Line, Wanco, Yanmar

New Equipment - Used Equipment - Rental Equipment - Parts and Accessories

Discount Equipment

www.discount-equipment.com

561-964-4949

Sales: info@Discount-Equipment.com

Parts: wbparts@Discount-Equipment.com

⚠ WARNING

CALIFORNIA PROPOSITION 65 WARNING: Engine exhaust and some of its constituents are known to the state of California to cause cancer, birth defects, and other reproductive harm. (000004)

⚠ WARNING

CALIFORNIA PROPOSITION 65 WARNING: This product contains or emits chemicals known to the state of California to cause cancer, birth defects, and other reproductive harm. (000005)

⚠ WARNING

ENVIRONMENTAL HAZARD: Always recycle batteries at an official recycling center in accordance with all local law and regulations. Failure to do so could result in environmental damage, death or serious injury. (000228)

Introduction

This manual provides information and procedures to safely operate and maintain the Generac Mobile Products unit. For your own safety and protection from physical injury, carefully read, understand, and observe the safety instructions described in this manual. Keep a copy of this manual with the unit at all times. Additional copies are available from Generac Mobile Products. *The information contained in this manual was based on machines in production at the time of publication. Generac Mobile Products reserves the right to change any portion of this information without notice.*

Read all of the manuals included with the unit. Each manual details specific information regarding items such as setup, use and service requirements. An engine operator's manual provides detailed operation and maintenance procedures for the engine. Additional copies of the engine operator's manual are available from the engine manufacturer.

DO NOT MODIFY or use this equipment for any application other than for which it was designed.

Only a trained and licensed electrician should perform wiring and connections to unit. Wiring must be in compliance with National Electrical Code (NEC), state and local regulations, and Occupational Safety and Health Administration (OSHA) guidelines.

Engine Make: _____

Engine Serial Number: _____

Engine Model Number: _____

Generator Make: _____

Generator Model Number: _____

Generator Serial Number: _____

Unit Model Number: _____

Unit Serial Number: _____

Dealer Name: _____

Dealer Phone Number: _____

Table of Contents

Section 1 - Safety

Safety Notes	1
Operating Safety.....	1
Engine Safety	2
Service Safety	2
Towing Safety.....	3
Reporting Trailer Safety Defects	3

Section 2 - General Information

Specifications	5
Unit Dimensions	6
Engine Oil Recommendations	6
Coolant Recommendation	7
Unit Serial Number Locations	7
Component Locations.....	8
Unit Set Up	14
Well Site Approval	14
Fuel Connections.....	14
LP Liquid Connections (Liquid Withdrawal System).....	17
Valve and Fitting Pipe Equivalents	19
Electrical Connections	19
Dual Fuel System	20
Natural Gas (Well Gas) Fuel System	20
LP Liquid Withdrawal Fuel System.....	20
DC Fuses.....	20
Generator and Load Compatibility.....	20
Engine/Generator Protective Devices	21
Digital Controller	21
Setting the Clock	22

Section 3 - Operation

Prestart Checklist	23
Manually Starting the Unit	23
Natural Gas (Well Gas) Start Up	23
LP Liquid Start Up	24
Auto (Remote) Starting the Unit	24
Parallel Setup and Operation	24
Operation Checks.....	25
Overcrank Shutdown	25
Derating for Altitude.....	26
Generator Output Connections.....	26
Customer Convenience Receptacles	27
Main Circuit Breaker	28
Frame Ground Connection	28
Battery Disconnect Switch.....	28
Shutting Down the Unit.....	28
Emergency Stop Switch	29
Towing the Trailer	29

Section 4 - Maintenance

Emissions	31
Maintenance Tasks	31
Daily Walk Around Inspection.....	31
Check Fuel System	31
Check Engine Fluids.....	31
Changing the Oil.....	32

Adding Coolant.....	33
Integrated Electronic Pressure Regulator (IEPR) Maintenance and Inspection.....	33
Checking/Draining Oil Build-Up in the Vaporizer Regulator	34
Maintenance Schedule.....	34
Battery Inspection.....	36
Battery Replacement.....	37
Other Maintenance Checks.....	38
Jack Maintenance.....	39
Side-Wind Models	39
Top-Wind Models	39
Trailer Wheel Bearings.....	39
Section 5 - Troubleshooting	
Problems and Solutions.....	41
Section 6 - Wiring Diagrams	
AC Wiring - MGG155 (120V GCB).....	53
AC Wiring - MGG210 (120V GCB).....	54
AC Wiring - MGG155 (24V GCB).....	55
AC Wiring - MGG210 (24V GCB).....	56
DC Wiring - MGG155 (120V GCB).....	57
DC Wiring - MGG210 (120V GCB).....	58
DC Wiring - MGG155 (24V GCB).....	59
DC Wiring - MGG210 (24V GCB).....	60
CAN Parallel Communication Connection - MGG155 and MGG210	61

Section 1 - Safety

SAFETY NOTES



This is the safety alert symbol. It is used to alert you to potential personal injury hazards. Obey all safety messages that follow this symbol to avoid possible injury or death.

This manual contains DANGERS, WARNINGS, CAUTIONS, NOTICES and NOTES which must be followed to prevent the possibility of improper service, damage to the equipment, personal injury or death. The following formatting options will apply when calling the readers attention to the DANGERS, WARNINGS, CAUTIONS, NOTICES and NOTES.

▲ DANGER

INDICATES A HAZARDOUS SITUATION WHICH, IF NOT AVOIDED, WILL RESULT IN DEATH OR SERIOUS INJURY. (000001)

▲ WARNING

Indicates a hazardous situation which, if not avoided, could result in death or serious injury. (000002)

▲ CAUTION

Indicates a hazardous situation which, if not avoided, could result in minor or moderate injury. (000003)

NOTICE

Indicates a hazardous situation which, if not avoided, could result in property or equipment damage.

Note: Notes contain additional information important to a procedure and will be found within the regular text body of this manual.

OPERATING SAFETY



Before using the unit, be sure you read and understand all of the instructions. This equipment was designed for specific applications; **DO NOT** modify or use this equipment for any application other than which it was designed for. Equipment operated improperly or by untrained personnel can be dangerous. Read the operating instructions and familiarize yourself with the location and proper use of all instruments and controls. Inexperienced operators should receive instruction from someone familiar with the equipment before being allowed to operate or set up the unit. The following points should be practiced at all times:

- The area immediately surrounding the unit should be dry, clean, and free of debris.
- Position and operate the unit on a firm, level surface.
- **DO NOT** start a unit in need of repair.
- If the unit is equipped with a frame grounding stud, follow any local, state, and National Electrical Code (NEC) guidelines when connecting.
- **DO NOT** operate the unit on a combustible surface.
- **DO NOT** operate a unit while tired, distracted, or under the influence of drugs or alcohol.
- Keep all body parts, clothing and other loose items away from moving parts.
- All fuel types are potentially FLAMMABLE and/or EXPLOSIVE and should be handled with care. Comply with all laws regulating the storage and handling of fuels. Inspect the unit's fuel system frequently and correct any leaks immediately. Fuel supply lines must be properly installed, purged, and leak tested according to applicable fuel-gas codes before placing the equipment into service.

- **DO NOT** smoke around the unit.
- Shut the engine down if any of the following conditions exist during operation:
 1. Noticeable change in engine speed.
 2. Loss of electrical output.
 3. Equipment connected to the unit overheats.
 4. Sparking occurs.
 5. Engine misfires or there is excessive engine/generator vibration.
 6. Protective covers are loose or missing.
 7. If the ambient air temperature is above 120°F (49°C).

ENGINE SAFETY



Internal combustion engines present special hazards during operation and fueling. Failure to follow the safety guidelines described below could result in severe injury or death. Read and follow all safety warnings described in the engine operator's manual. A copy of this manual was supplied with the unit when it was shipped from the factory.

- **DO NOT** run engine indoors or in an area with poor ventilation unless exhaust hoses are used. Engine exhaust contains carbon monoxide, a deadly, odorless and colorless gas which, if inhaled, can cause nausea, fainting or death. Verify engine exhaust cannot seep into closed rooms or ventilation equipment.
- **DO NOT** touch or lean against hot exhaust pipes or engine components.
- **DO NOT** clean air filter with gasoline or other types of low flash point solvents.
- **DO NOT** operate the unit without a functional exhaust system.
- Prolonged exposure to sound levels in excess of 85 dB(A) can cause permanent hearing loss. Wear hearing protection when working around a running engine.
- Batteries contain sulfuric acid which can cause severe injury or death. Sulfuric acid can cause eye damage, burn flesh or eat holes in clothing. Protective eye wear and clothing are necessary when working on or around the battery. Always disconnect the negative (-) battery cable from the corresponding terminal before performing any service on the engine or other components.
- **DO NOT** remove the radiator cap while the engine is hot.
- Keep area around exhaust pipes and air ducts free of debris to reduce the chance of an accidental fire.

SERVICE SAFETY



All service work must be performed by qualified personnel who are familiar with the equipment. Only a qualified electrician should troubleshoot or repair electrical problems occurring in this equipment. Follow the safety guidelines described below to prevent hazardous situations which could result in severe injury or death.

- **DO NOT** wash the unit with high pressure hoses, power washers, or steam cleaners. Water may collect in the unit, causing damage to electrical parts.
- **ALWAYS** use extreme caution when servicing this unit in damp conditions. Do not service the unit if your skin or clothing is wet. Do not allow water to collect around the base of the unit.
- Replace all missing and hard to read decals. Decals provide important operating instructions and warn of dangers and hazards.
- **ALWAYS** turn the battery disconnect switch to the OFF position before performing any service on the engine, generator, or any other components. Remove the negative (-) battery cable from the corresponding terminal if the unit is to be stored or transported.

- **DO NOT** start the unit under load. The main circuit breaker must be in the open position (press the right I/O button on the controller) when starting the unit.

TOWING SAFETY



Towing a trailer requires care. Both the trailer and vehicle must be in good condition and securely fastened to each other to reduce the possibility of an accident. Some states require that large trailers be registered and licensed. Contact your local Department of Transportation office to check on license requirements for your particular unit.

- Verify the hitch and coupling on the towing vehicle are rated equal to, or greater than, the trailer's Gross Vehicle Weight Rating (GVWR).
- Check trailer tires for wear and proper inflation.
- **DO NOT** tow trailer using defective parts. Inspect the hitch and coupling for wear or damage.
- Verify the trailer hitch and the coupling are compatible and the coupling is securely fastened to the vehicle.
- Verify the directional and brake lights on the trailer are connected and working properly.
- See *Towing the Trailer*. Verify wheel lug nuts are present and tightened to the specified torque.
- Maximum recommended speed for highway towing is 45 mph (72 km/h). Recommended off-road towing speed is 10 mph (16 km/h).
- When towing, maintain extra space between vehicles and avoid soft shoulders, curbs and sudden lane changes. Practice turning, stopping and backing up in an area away from heavy traffic prior to transporting unit.
- Wipe the coupler clean and apply fresh grease each time the trailer is towed to eliminate squeaking.
- Connect safety chains in a crossing pattern under the tongue and **ATTACH THE BREAKAWAY CABLE TO THE REAR BUMPER OF THE TOWING VEHICLE**. Do not attach the cable to the trailer hitch.
- The trailer is equipped with hydraulic or electric surge brakes. Verify proper operation of the brakes by braking the vehicle at a slow speed before entering traffic. Both the trailer and the vehicle should brake smoothly. If the trailer seems to be pushing, check the level in the brake fluid reservoir, if equipped.

REPORTING TRAILER SAFETY DEFECTS

If you believe your trailer has a defect which could cause a crash or could cause injury or death, you should immediately inform the National Highway Traffic Safety Administration (NHTSA) in addition to notifying Generac Mobile Products LLC.

If NHTSA receives similar complaints, it may open an investigation; and if it finds that a safety defect exists in a group of vehicles, it may order a recall and remedy campaign. However, NHTSA cannot become involved in an individual problem between you, your Independent Authorized Service Dealer, or Generac Mobile Products LLC.

















To contact NHTSA, you may either call the Auto Safety Hotline toll-free at 1-888-327-4236 (TTY:1-800-424-9153), go to <http://www.safercar.gov>; or write to:

Administrator
NHTSA
1200 New Jersey Avenue S.E.
Washington, DC 20590

You can also obtain other information about motor vehicle safety from <http://www.safercar.gov>.

SAFETY SYMBOL SUMMARY

The safety and operating decals affixed to the unit provide important instructions and warn of dangers and hazards. Replace any missing or hard-to-read decals and use care when washing or cleaning the unit. Decal placement and part numbers can be found in the online parts manual at www.generacmobileproducts.com. Below is a summary of the intended meanings for the symbols used on the decals.

	Safety alert symbol; used to alert you to potential personal injury hazards.		No open flames.
	Unit electrical ground.		Dangerous voltage may be present.
	Wear protective gloves.		Use protective eyewear.
	Explosion hazard.		Lift here only.
	Fire hazard.		Read and understand the supplied operator's manual before operating unit.
	Burn/scald hazard; pressurized steam.		Belt/entanglement hazard; keep body parts clear of this area.
	Hot surface(s) nearby.		Fan hazard; keep body parts clear of this area.
	Engine starting/remote starting point.		Anchor/tie down point.
	Engine can start automatically.		

00844

Section 2 - General Information

SPECIFICATIONS

GENERAC MODEL	MGG155	MGG210
Engine		
Make/Brand.....	PSI.....	PSI.....
Model.....	D081TIC.....	D111TIC.....
Induction System.....	Turbo CAC.....	Turbo CAC.....
Horsepower - Prime - Natural Gas hp (kW)	239 (178).....	302 (225).....
Horsepower - Standby - LP Liquid hp (kW)	200 (149).....	272 (203).....
Operating Speed rpm	1800.....	1800.....
Displacement in³ (L)	494 (8.1).....	673 (11.0).....
Cylinders - qty.....	6.....	6.....
Spark plug gap in (mm)	0.015 (.4).....	0.015 (.4).....
Fuel Consumption (NG) - 100% load ft³/hr (m³/hr)	1092 (30.9).....	1431 (40.5).....
Fuel Consumption (NG) - 75% load ft³/hr (m³/hr)	858 (24.3).....	1112 (31.5).....
Fuel Consumption (NG) - 50% load ft³/hr (m³/hr)	625 (17.7).....	794 (22.5).....
Fuel Consumption (LP) - 100% load gal/hr (L/hr)	15.4 (58.3).....	19.2 (72.7).....
Fuel Consumption (LP) - 75% load gal/hr (L/hr)	11.8 (44.7).....	14.7 (55.6).....
Fuel Consumption (LP) - 50% load gal/hr (L/hr)	8.3 (31.4).....	10.2 (38.6).....
Battery		
Battery Type - Group Number.....	8D.....	8D.....
Battery Voltage (quantity per unit).....	12V (2).....	12V (2).....
Battery Voltage (series connection).....	24V.....	24V.....
Battery Rating.....	1100CCA.....	1100CCA.....
Generator		
Make/Brand.....	Stamford.....	Stamford.....
Model.....	UCI274E-311.....	UCI274G-311.....
Type, Insulation.....	Brushless, H.....	Brushless, H.....
See the data plate on the generator for rated watts, amperes, frequency, voltage, phase and other important information.		
Generator Set (Engine/Generator)		
3Ø - Continuous - Natural Gas kW (kVA)	100 (125).....	137 (171).....
3Ø - Standby - LP Liquid kW (kVA)	108 (135).....	139 (173).....
Amps - 3Ø Continuous - Natural Gas (480V/277) A	150.....	206.....
Amps - 3Ø Standby - Natural Gas (480V/277) A	214.....	278.....
Amps - 3Ø Standby - LP Liquid (480V/277) A	162.....	209.....
Frequency Hz	60.....	60.....
Power Factor.....	0.8.....	0.8.....
AC Distribution		
Circuit Breaker Size A	200.....	400.....
Voltage Regulation.....	Digital.....	Digital.....
Voltages Available 3Ø.....	480 (277/480).....	480 (277/480).....
Capacities		
Coolant (incl. engine) qt (L)	20 (18.9).....	22 (20.8).....
Oil (incl. filter) qt (L)	7.2 (6.81).....	7.6 (7.19).....
Weights		
Operating Weight, Skid Mounted lbs (kg)	7245 (3286).....	7290 (3307).....
Operating Weight, Trailer Mounted lbs (kg)	9645 (4375).....	9890 (4486).....
Trailer		
Number of Axles.....	2.....	2.....
Capacity - Axle Rating lbs (kg)	7000 (3175).....	7000 (3175).....
Tire Size in	16.....	16.....
Brakes - Standard.....	Electric.....	Electric.....
Hitch - Standard.....	3" lunette ring.....	3" lunette ring.....
Maximum Tire Pressure psi	80.....	80.....

Specifications are subject to change without notice.

Unit Dimensions

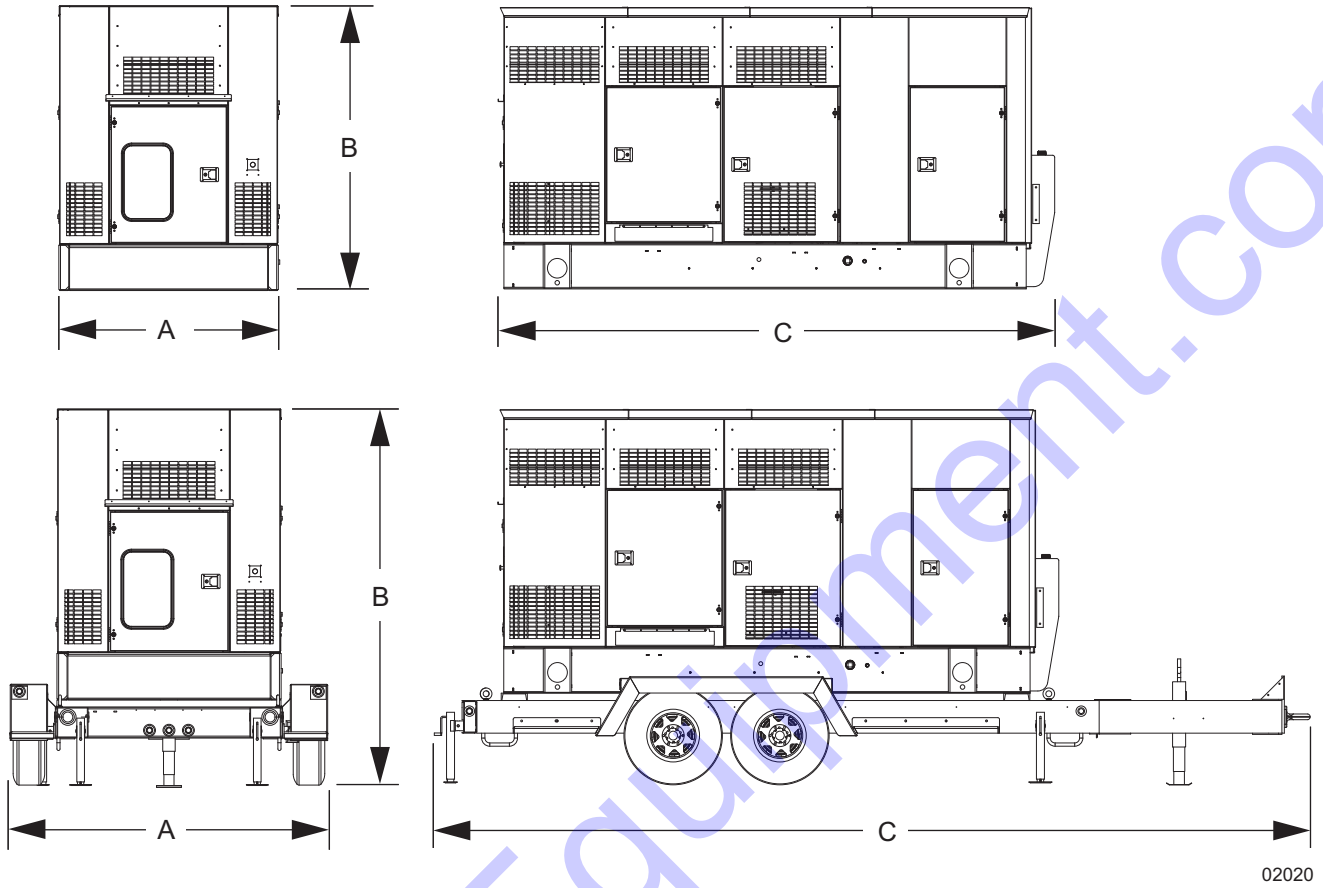

Figure 1 - Unit Dimensions

	A	B	C
MGG155 - Skid Mounted	66 in. (1.67 m)	92 in. (2.33 m)	169 in. (4.29 m)
MGG155 - Trailer Mounted	102 in. (2.59 m)	124 in. (3.15 m)	269 in. (6.83 m)
MGG210 - Skid Mounted	66 in. (1.67 m)	92 in. (2.33 m)	201 in. (5.10 m)
MGG210 - Trailer Mounted	102 in. (2.59 m)	124 in. (3.15 m)	269 in. (6.83 m)

Specifications are subject to change without notice.

Engine Oil Recommendations

To maintain the product warranty, the engine oil should be serviced in accordance with the recommendations of this manual. For your convenience, Generac Maintenance Kits are available that include engine oil, oil filter, air filter, spark plug(s), a shop towel and funnel. These kits can be obtained from an Independent Authorized Service Dealer (IASD).

The engine has been filled with factory engine oil of a grade recommended by the engine supplier. The manufacturer recommends an initial oil and filter change after the first 50 hours (or first three months) of service operation. Use a high quality detergent oil with an appropriate classification and viscosity for the engine type and ambient temperature conditions. See **Specifications** for oil capacity.

- SAE 15W-40 low ash
- API CD/CF or higher

Coolant Recommendation

See the OEM engine manual for coolant type. Normally a 50/50 mix of coolant and water is required. Coolant system capacity is listed in [Specifications](#).

⚠ DANGER

RISK OF POISONING. DO NOT USE MOUTH TO SIPHON COOLANT. DOING SO WILL RESULT IN DEATH OR SERIOUS INJURY. (000149)

⚠ WARNING

DO NOT open coolant system until engine has completely cooled. Doing so could result in serious injury. (000154)

⚠ CAUTION

Do not use any chromate base rust inhibitor with propylene glycol base antifreeze, boosters or additives. Doing so will cause overheating. (000165)

UNIT SERIAL NUMBER LOCATIONS

See [Figure 2](#) to locate the unit ID tag and Vehicle Identification Number (VIN) tag on the unit. Important information, such as the unit serial number, model number, VIN and tire loading information are found on these tags. Record the information from these tags so it is available if the tags are lost or damaged. When ordering parts or requesting assistance, you may be asked to provide this information.

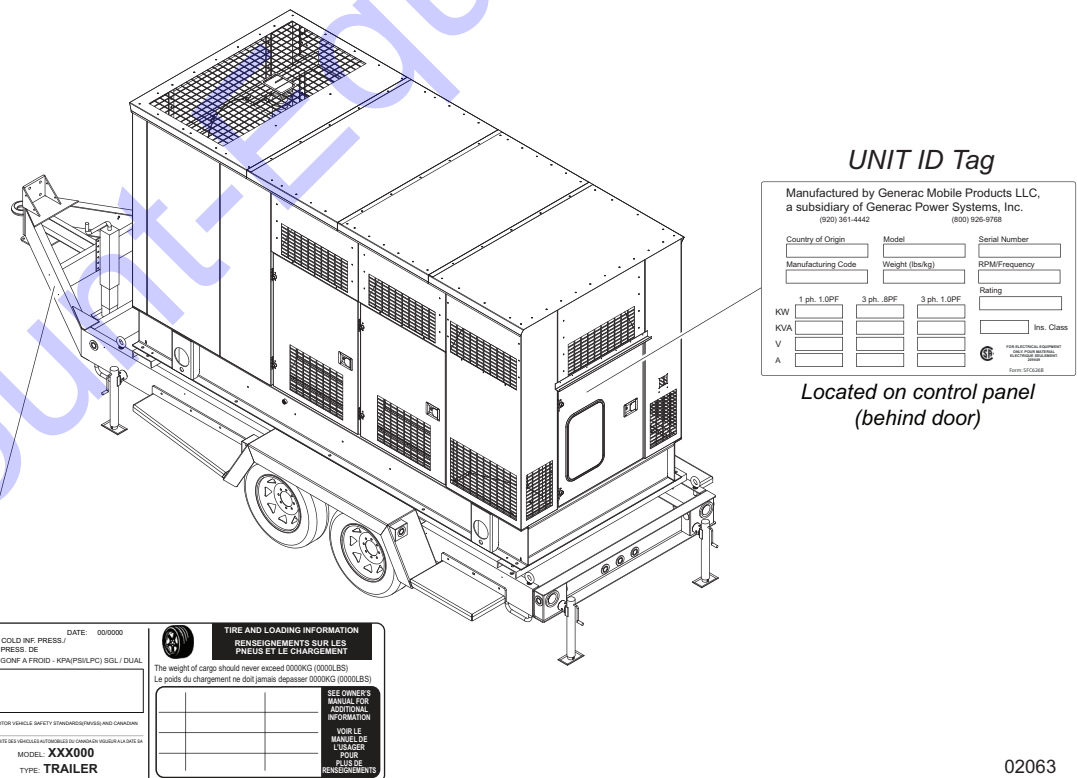
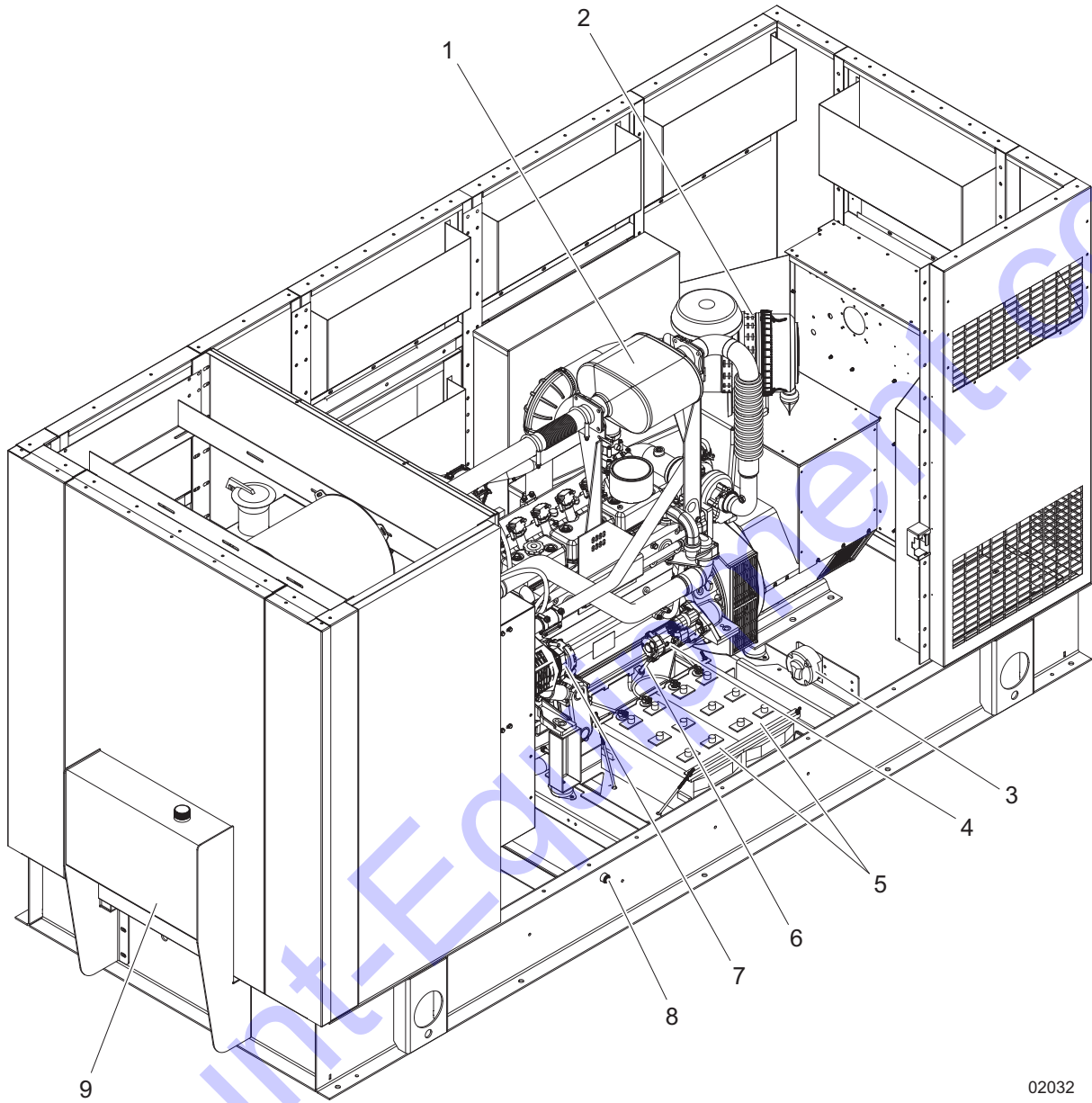

Figure 2 - Serial Number Locations

COMPONENT LOCATIONS



02032

Figure 3 - MGG155 - Left Side

- | | |
|------------------------------|------------------|
| 1. Catalyst exhaust muffler | 6. Dipstick |
| 2. Air filter | 7. Alternator |
| 3. Battery disconnect switch | 8. Coolant drain |
| 4. Starter | 9. Oil reservoir |
| 5. 12 volt batteries (2) | |

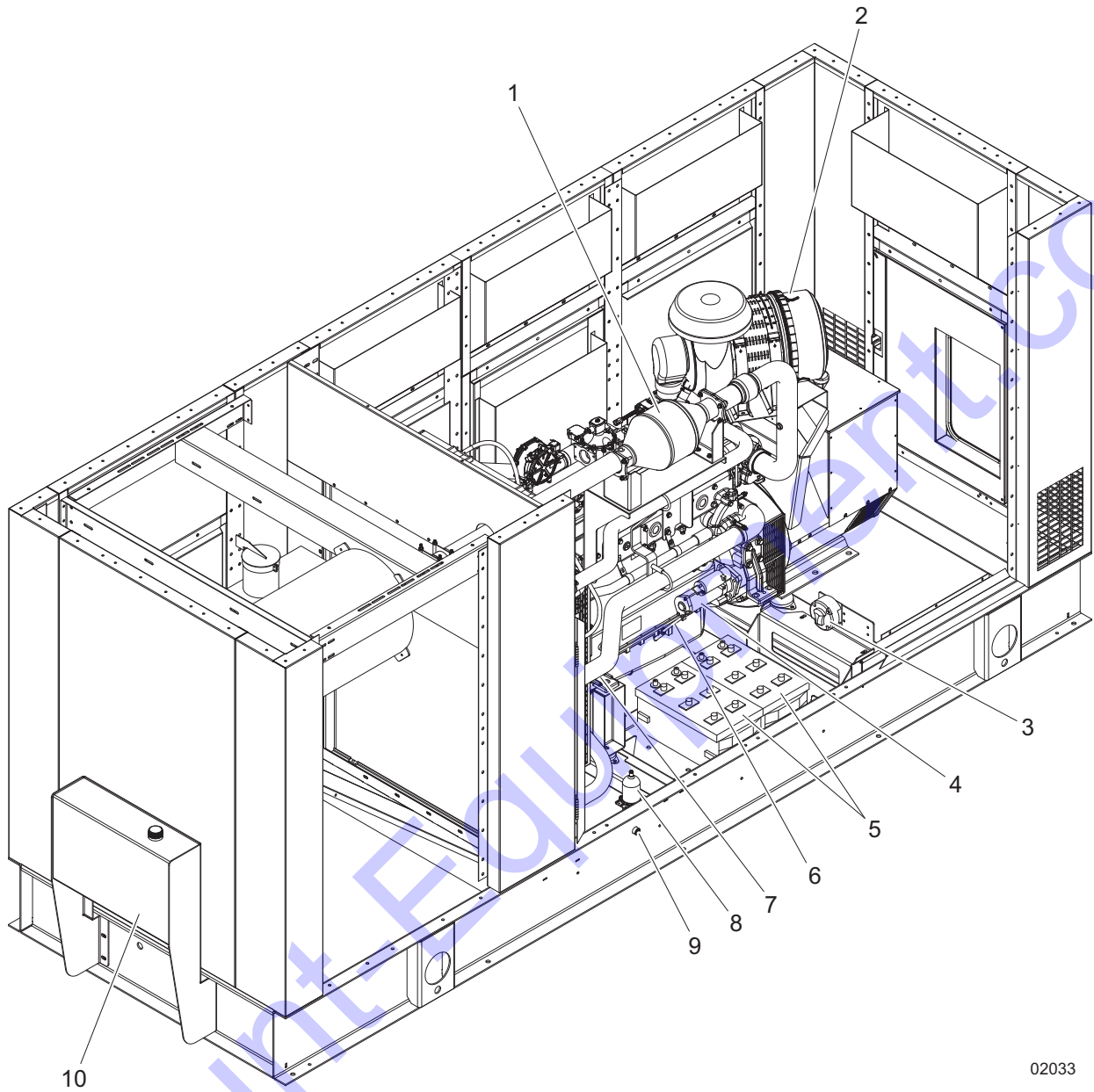

02033

Figure 4 - MGG210 - Left Side

- | | |
|------------------------------|-----------------------------|
| 1. Catalyst exhaust muffler | 6. Dipstick |
| 2. Air filter | 7. Alternator |
| 3. Battery disconnect switch | 8. Engine heater (optional) |
| 4. Starter motor | 9. Coolant drain |
| 5. 12 volt batteries (2) | 10. Oil reservoir |

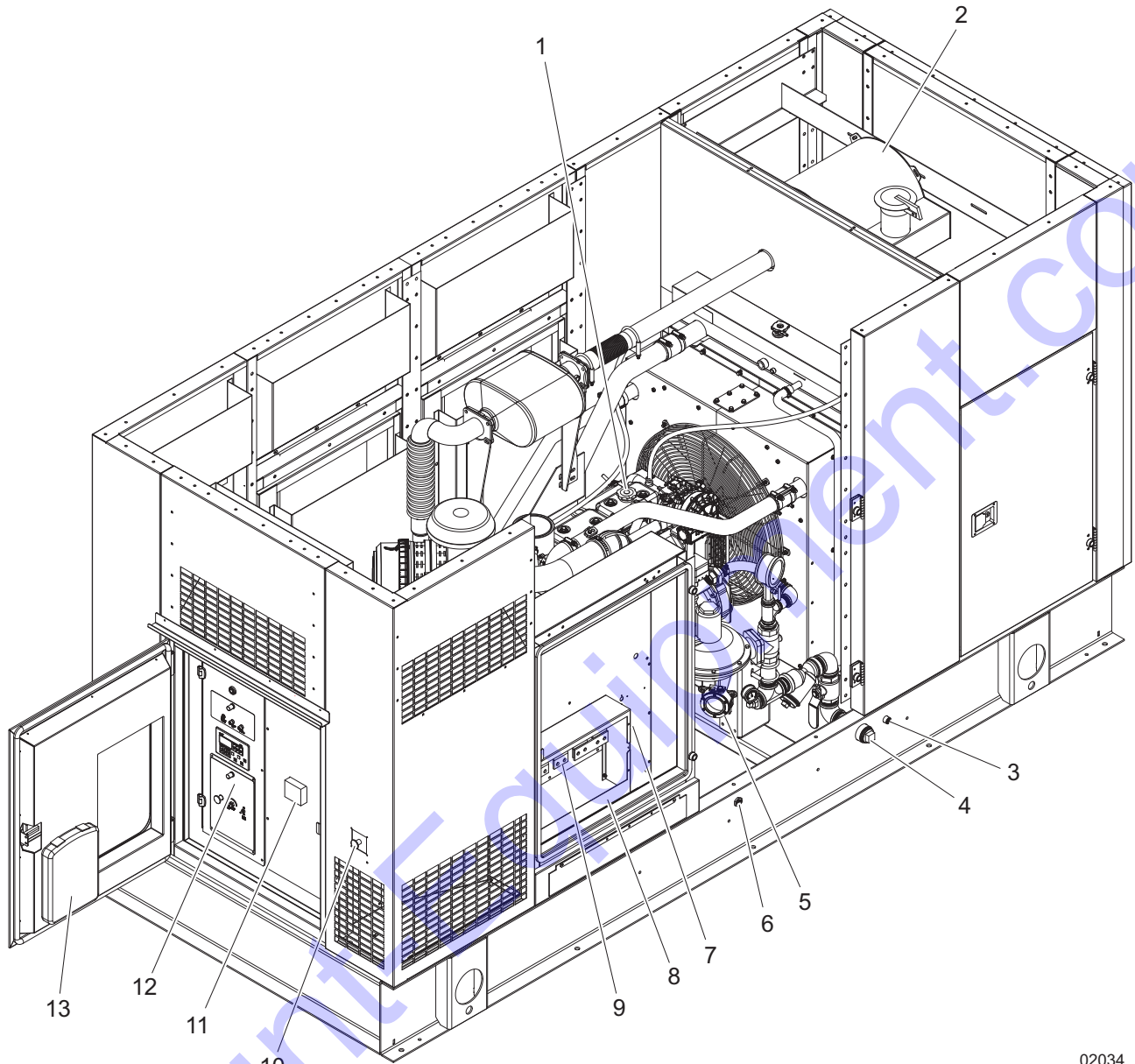

02034

Figure 5 - MGG155 and MGG210 - Right Side (MGG155 Shown)

- | | |
|-------------------------------------|---|
| 1. Oil fill cap | 8. Customer connection box |
| 2. Silencer | 9. Generator output connections |
| 3. LP (liquid) inlet | 10. Emergency stop switch |
| 4. Natural gas (well gas) inlet | 11. Main circuit breaker |
| 5. Oil level controller | 12. Control panel (see Figure 7) |
| 6. Oil drain | 13. Manual holder |
| 7. Customer convenience receptacles | |

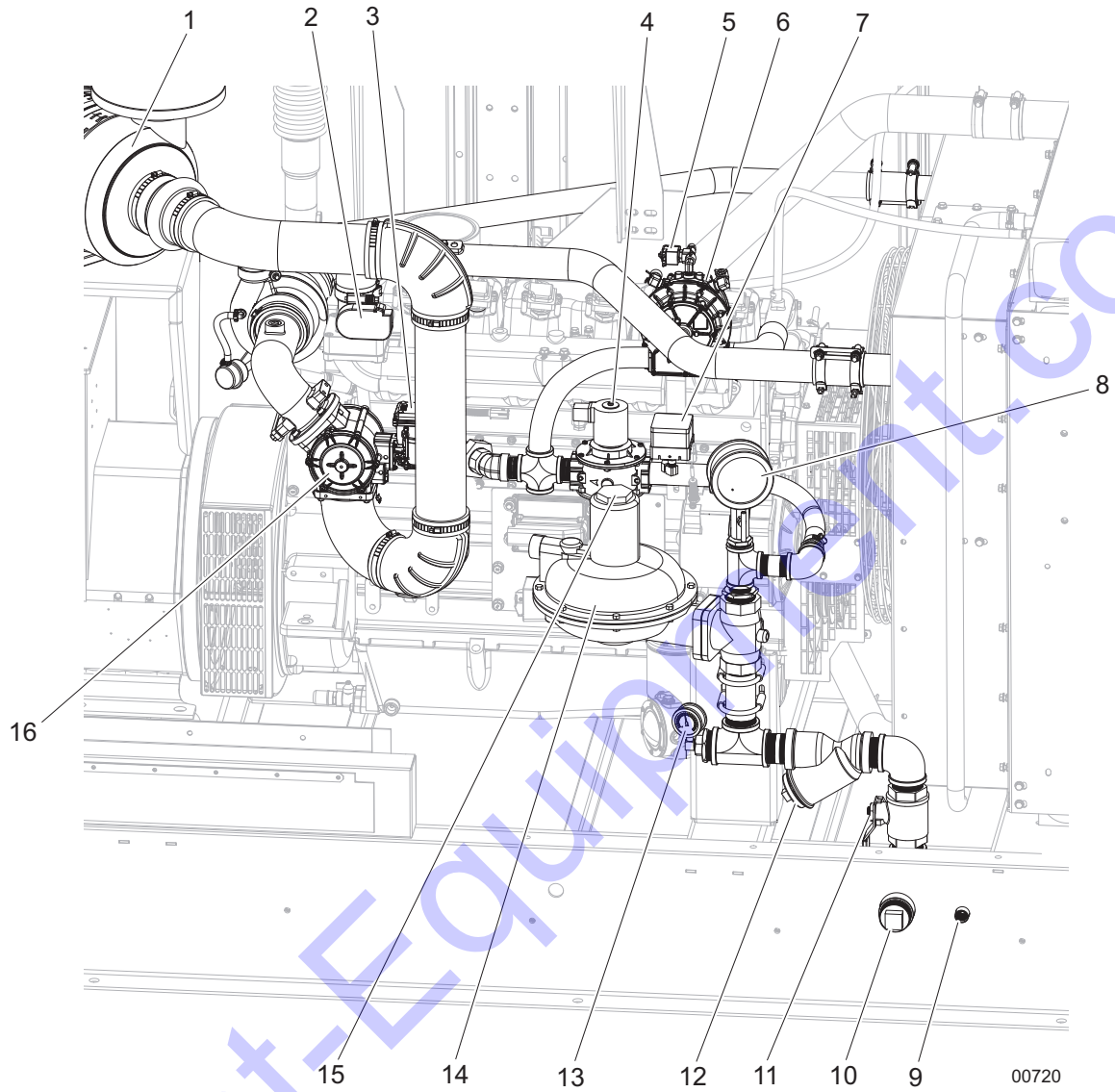
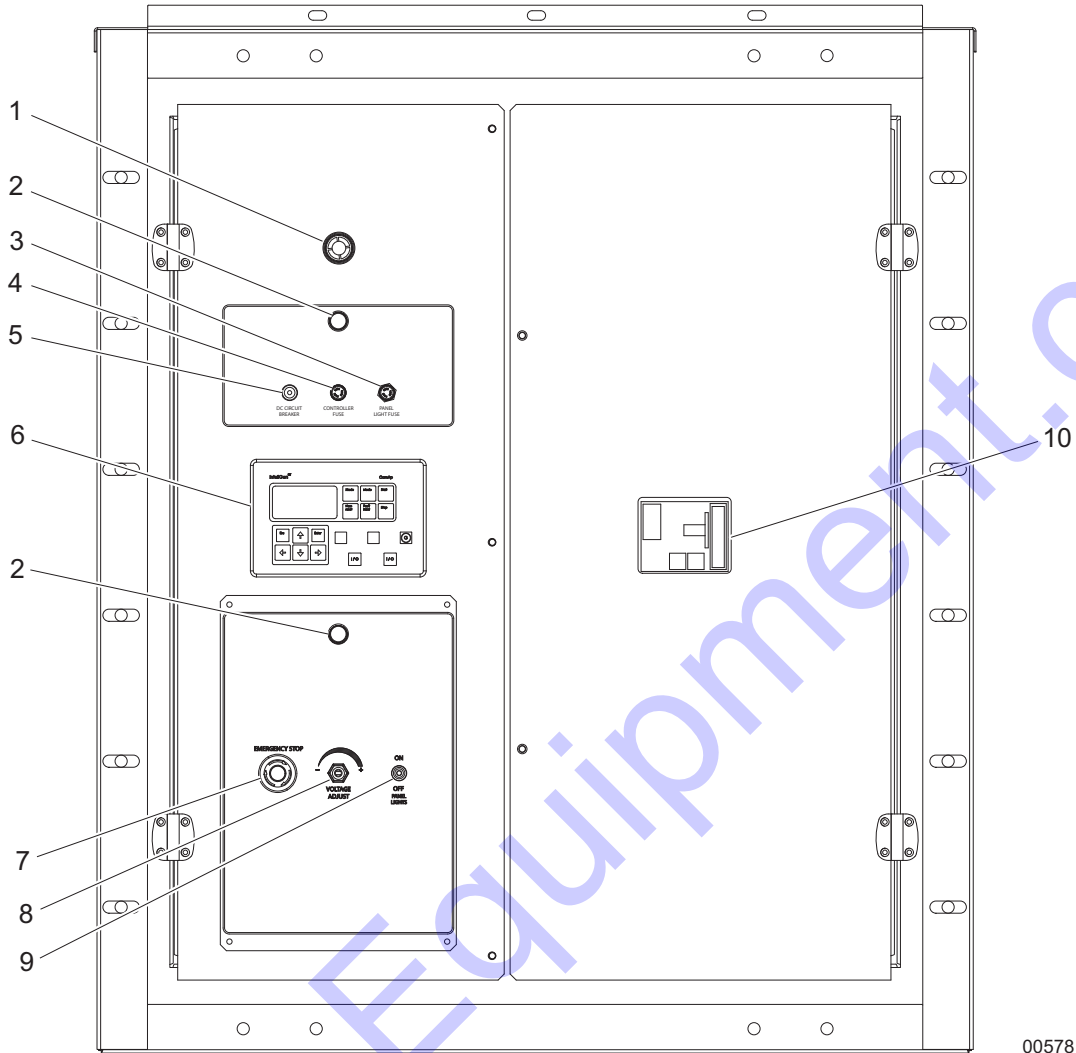

Figure 6 - Fuel System (MGG155 Shown)

- | | |
|---|-------------------------------------|
| 1. Air filter | 9. LP liquid inlet |
| 2. Electronic throttle control | 10. Natural gas (well gas) inlet |
| 3. Integrated electronic pressure regulator | 11. Manual ball valve (natural gas) |
| 4. Natural gas lock-off | 12. Strainer access |
| 5. LP liquid lock-off | 13. Pressure gauge (psi) |
| 6. Vaporizer | 14. Pressure regulator |
| 7. Pressure switch | 15. Access for regulator adjustment |
| 8. Pressure gauge (inch WC) | 16. Fuel/air mixer |

CONTROL PANEL



00578

Figure 7 - MGG155 and MGG210 Control Panel

- | | |
|---------------------------|---|
| 1. Alarm horn | 6. Digital controller |
| 2. Panel light | 7. Emergency stop switch (not on all units) |
| 3. Panel light fuse (10A) | 8. Voltage adjustment |
| 4. Controller fuse (5A) | 9. Panel lights switch |
| 5. DC circuit breaker | 10. Main circuit breaker |

ELECTRICAL PANEL

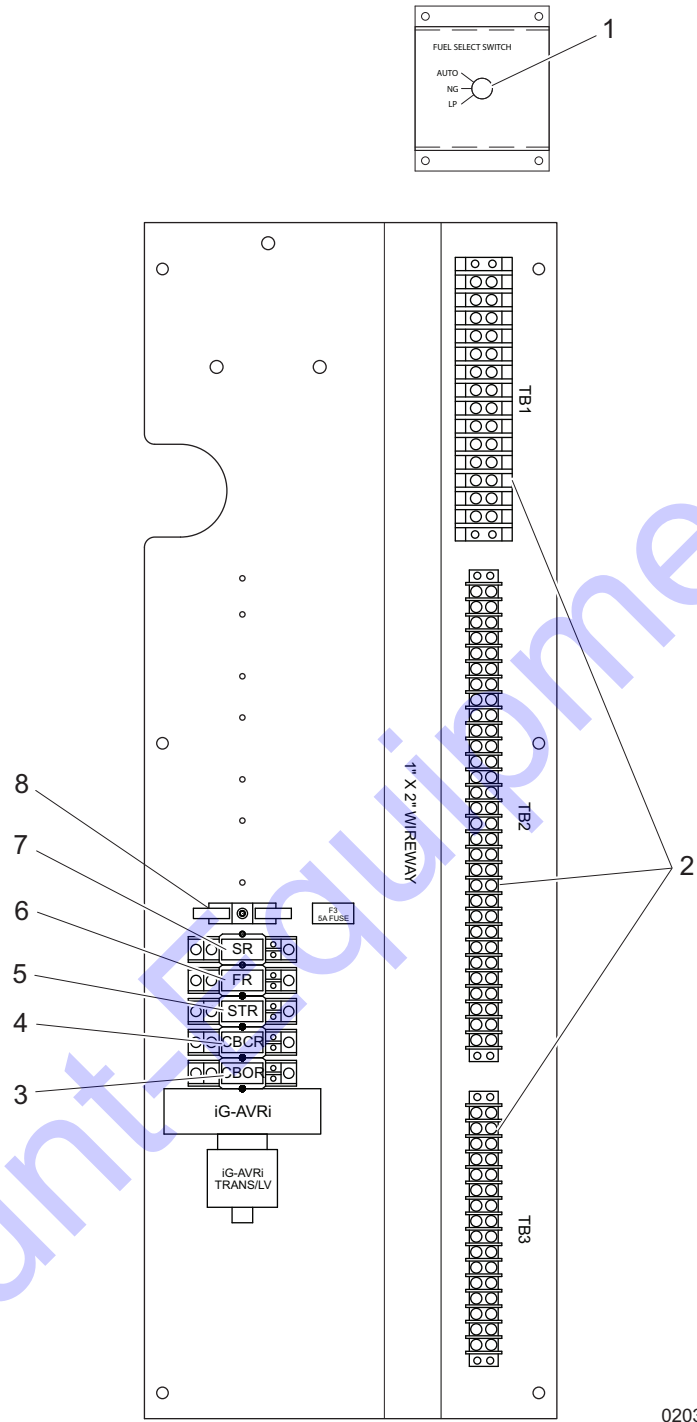

02031

Figure 8 - Electrical Panel (Located Behind Control Panel Door)

- | | |
|---------------------------------|-------------------------------|
| 1. Fuel select switch | 5. Shunt trip relay |
| 2. Terminal block (3) | 6. Fuel relay |
| 3. Circuit breaker open relay | 7. Starter relay |
| 4. Circuit breaker closed relay | 8. Relay protection fuse (5A) |

UNIT SET UP

This unit is designed to operate with natural gas or well gas as the primary fuel and LP liquid as the secondary fuel. For units operating on well site gas, a well test must be performed prior to installation of the unit.

Well Site Approval

A well gas chromatography analysis must be performed prior to installation of the unit. A copy of the test report must be sent to, and preapproved by, Generac Power Systems. If the unit is moved to a new location, a new well test must be performed. For more information, contact Generac Mobile Products Technical Support.

The unit should be installed, serviced, tested, adjusted, and otherwise prepared for use by an Independent Authorized Service Dealer. The owner is responsible for ensuring the unit emission control system meets all applicable state and local regulations.

▲ WARNING

Risk of Fire. Unit must be positioned in a manner that prevents combustible material accumulation underneath. Failure to do so could result in death or serious injury.
(000147)

Fuel Connections

Almost all operation problems are related to the installation techniques used. **DO NOT** guess, be sure pipe size is adequate for required flow rate. See [Table 1](#), [Table 2](#) and [Table 3](#).

Natural Gas Connections

Follow the steps below:

1. Before connecting the natural gas fuel line to the unit, apply pipe sealant to the NPT threads of the fitting at the end of the fuel line.

Note: Do not apply pipe sealant to the flared (flanged) end of the fitting.

2. Connect the fuel line to the two inch inlet, located on the right side of the unit's frame.
3. Be certain that all connections are sealed and no leaks are present. The installer must verify that all gas connections comply with all building codes.
4. Verify fuel supply pressure is adequate.

Purging the Natural Gas Fuel Line

After initial setup, it may be necessary to purge the natural gas fuel line before operating the unit. LP liquid must be available as a secondary fuel to perform this procedure.

1. Open the control door located at the back of the unit.
2. Remove the three screws securing the left control panel door. A Fuel Select switch is located behind the door. See [Figure 8](#).
3. Move the Fuel Select switch to the LP or AUTO position.

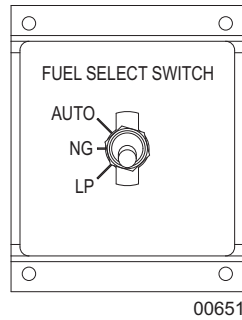

Figure 9 - Fuel Select Switch

4. Apply pipe sealant to the NPT threads of the pipe fitting at the end of the natural gas fuel line. Connect the fuel line to the two inch inlet located on the right side of the unit's frame.

Note: Do not apply pipe sealant to the flared (flanged) end of the fuel pipe.

5. Apply pipe sealant to the NPT threads of the pipe fitting at the end of the LP liquid fuel line. Connect the fuel line to the 1/2 inch inlet located on the right side of the unit's frame.
6. Be certain that all connections are sealed and no leaks are present. The installer must verify that all gas connections comply with all building codes.
7. Verify fuel supply pressure is adequate.

Formula Example:

If a unit has a 160 hp engine 60 feet from the supply, the engine needs 10,000 BTU/hr per hp to run efficiently. For natural gas fuel, there are 1015 BTU/ft³. From [Table 1](#), a 60 foot run requires a minimum 1 inch pipe at full engine load.

160 hp x 10,000 BTU/Hr per hp = 1,600,000 BTU's / per hour for proper operation

$$\frac{1,600,000}{1,015} = 1576 \text{ cubic feet per hour}$$

Note: The incoming pressure must be approximately 20 psi to unit.

Table 1 - Natural Gas Flow Rate (ft³ / m³ Per Hour) per Pipe Length

Pipe Length	Iron Pipe Size											
	1/2 in (1 cm)	3/4 in (2 cm)	1 in (3 cm)	1-1/4 in (3 cm)	1-1/2" (4 cm)	2 in (5 cm)	2-1/2 in (6 cm)	3 in (8 cm)	3-1/2 in (9 cm)	4 in (10 cm)	5 in (13 cm)	6 in (15 cm)
10 ft (3 m)	2,723 ft (830 m)	5,765 ft (1,757 m)	10,975 ft (3,345 m)	22,804 ft (6,951 m)	34,398 ft (10,485 m)	66,973 ft (20,413 m)	107,577 ft (32,789 m)	191,989 ft (58,518 m)	282,890 ft (86,225 m)	396,270 ft (120,783 m)	724,020 ft (220,681 m)	1,181,799 ft (360,212 m)
20 ft (6 m)	1,926 ft (587 m)	4,076 ft (1,242 m)	7,760 ft (2,365 m)	16,125 ft (4,915 m)	24,323 ft (7,414 m)	47,357 ft (14,434 m)	76,068 ft (23,186 m)	135,757 ft (41,379 m)	200,034 ft (60,970 m)	280,205 ft (85,406 m)	511,959 ft (156,045 m)	838,658 ft (255,623 m)
25 ft (8 m)	1,722 ft (525 m)	3,646 ft (1,111 m)	6,941 ft (2,116 m)	14,422 ft (4,396 m)	21,755 ft (6,631 m)	42,358 ft (12,911 m)	68,037 ft (20,738 m)	121,424 ft (37,010 m)	178,915 ft (54,533 m)	250,623 ft (76,390 m)	457,910 ft (139,571 m)	747,435 ft (227,818 m)
30 ft (9 m)	1,572 ft (479 m)	3,328 ft (1,014 m)	6,336 ft (1,931 m)	13,166 ft (4,013 m)	19,860 ft (6,053 m)	38,667 ft (11,786 m)	62,109 ft (18,931 m)	110,845 ft (33,786 m)	163,327 ft (49,782 m)	228,787 ft (69,734 m)	418,013 ft (127,410 m)	682,312 ft (207,969 m)
35 ft (11 m)	1,456 ft (444 m)	3,082 ft (939 m)	5,866 ft (1,788 m)	12,189 ft (3,715 m)	18,386 ft (5,604 m)	35,799 ft (10,912 m)	57,502 ft (17,527 m)	102,622 ft (31,279 m)	151,211 ft (46,089 m)	211,815 ft (64,561 m)	387,005 ft (117,959 m)	631,698 ft (192,542 m)
40 ft (12 m)	1,362 ft (415 m)	2,883 ft (879 m)	5,487 ft (1,672 m)	11,402 ft (3,475 m)	17,199 ft (5,242 m)	33,487 ft (10,207 m)	53,788 ft (16,395 m)	95,994 ft (29,259 m)	141,445 ft (43,112 m)	198,135 ft (60,392 m)	362,010 ft (110,341 m)	590,900 ft (180,106 m)
45 ft (14 m)	1,284 ft (391 m)	2,718 ft (828 m)	5,174 ft (1,577 m)	10,750 ft (3,277 m)	16,215 ft (4,942 m)	31,572 ft (9,623 m)	50,712 ft (15,457 m)	90,504 ft (27,586 m)	133,356 ft (40,647 m)	186,804 ft (56,938 m)	341,306 ft (104,030 m)	557,105 ft (169,806 m)
50 ft (15 m)	1,218 ft (371 m)	2,578 ft (786 m)	4,908 ft (1,496 m)	10,198 ft (3,108 m)	15,383 ft (4,689 m)	29,951 ft (9,129 m)	48,110 ft (14,664 m)	85,860 ft (26,170 m)	126,512 ft (38,561 m)	177,217 ft (54,016 m)	323,791 ft (98,692 m)	528,517 ft (161,092 m)
60 ft (18 m)	1,112 ft (339 m)	2,354 ft (717 m)	4,480 ft (1,366 m)	9,310 ft (2,838 m)	14,043 ft (4,280 m)	27,342 ft (8,334 m)	43,918 ft (13,386 m)	78,379 ft (23,890 m)	115,489 ft (35,201 m)	161,777 ft (49,310 m)	295,580 ft (90,093 m)	482,467 ft (147,056 m)
70 ft (21 m)	1,029 ft (314 m)	2,179 ft (664 m)	4,148 ft (1,264 m)	8,619 ft (2,627 m)	13,001 ft (3,963 m)	25,314 ft (7,716 m)	40,660 ft (12,393 m)	72,565 ft (22,118 m)	106,922 ft (32,590 m)	149,776 ft (46,652 m)	273,654 ft (83,410 m)	446,678 ft (136,148 m)
80 ft (24 m)	963 ft (294 m)	2,038 ft (621 m)	3,880 ft (1,183 m)	8,062 ft (2,457 m)	12,161 ft (3,707 m)	23,679 ft (7,217 m)	38,034 ft (11,593 m)	67,878 ft (20,689 m)	100,017 ft (30,485 m)	140,103 ft (42,703 m)	255,980 ft (78,023 m)	417,829 ft (127,354 m)
90 ft (27 m)	908 ft (277 m)	1,922 ft (586 m)	3,658 ft (1,115 m)	7,601 ft (2,317 m)	11,466 ft (3,495 m)	22,324 ft (6,804 m)	35,859 ft (10,930 m)	63,996 ft (19,506 m)	94,297 ft (28,742 m)	132,090 ft (40,261 m)	241,340 ft (73,560 m)	393,933 ft (120,071 m)
100 ft (30 m)	861 ft (262 m)	1,823 ft (556 m)	3,471 ft (1,058 m)	7,211 ft (2,198 m)	10,878 ft (3,316 m)	21,179 ft (6,455 m)	34,019 ft (10,369 m)	60,712 ft (18,505 m)	89,458 ft (27,267 m)	125,312 ft (38,195 m)	228,955 ft (69,785 m)	373,718 ft (113,909 m)
125 ft (38 m)	770 ft (235 m)	1,631 ft (497 m)	3,104 ft (946 m)	6,450 ft (1,966 m)	9,729 ft (2,965 m)	18,943 ft (5,774 m)	30,427 ft (9,274 m)	54,303 ft (16,552 m)	80,013 ft (24,388 m)	112,082 ft (34,163 m)	204,784 ft (62,418 m)	334,263 ft (101,883 m)
150 ft (46 m)	703 ft (214 m)	1,489 ft (454 m)	2,834 ft (864 m)	5,888 ft (1,795 m)	8,881 ft (2,707 m)	1,292 ft (394 m)	27,776 ft (8,466 m)	49,571 ft (15,109 m)	73,042 ft (22,263 m)	102,317 ft (31,186 m)	186,941 ft (56,980 m)	305,139 ft (93,006 m)
200 ft (61 m)	609 ft (186 m)	1,289 ft (393 m)	2,454 ft (748 m)	5,099 ft (1,554 m)	7,692 ft (2,345 m)	14,976 ft (4,565 m)	24,055 ft (7,332 m)	42,930 ft (13,085 m)	63,256 ft (19,280 m)	88,609 ft (27,008 m)	161,896 ft (49,346 m)	264,258 ft (80,546 m)
300 ft (91 m)	497 ft (151 m)	1,053 ft (321 m)	2,004 ft (611 m)	4,163 ft (1,269 m)	6,280 ft (1,914 m)	12,228 ft (3,727 m)	19,641 ft (5,987 m)	35,052 ft (10,684 m)	51,648 ft (15,742 m)	72,349 ft (22,052 m)	132,187 ft (40,291 m)	215,766 ft (65,765 m)
400 ft (122 m)	431 ft (131 m)	912 ft (278 m)	1,735 ft (529 m)	3,606 ft (1,099 m)	5,439 ft (1,658 m)	10,589 ft (3,228 m)	17,009 ft (5,184 m)	30,356 ft (9,253 m)	44,729 ft (13,633 m)	62,656 ft (19,098 m)	114,478 ft (34,893 m)	186,859 ft (56,955 m)
500 ft (152 m)	385 ft (117 m)	815 ft (248 m)	152 ft (46 m)	3,225 ft (983 m)	4,865 ft (1,483 m)	9,471 ft (2,887 m)	15,214 ft (4,637 m)	27,151 ft (8,276 m)	40,007 ft (12,194 m)	56,041 ft (17,081 m)	102,392 ft (31,209 m)	167,132 ft (50,942 m)
1,000 ft (305 m)	272 ft (83 m)	577 ft (176 m)	1097 ft (334 m)	2,280 ft (695 m)	3,440 ft (1,049 m)	6,697 ft (2,041 m)	10,758 ft (3,279 m)	19,199 ft (5,852 m)	28,289 ft (8,622 m)	39,627 ft (12,078 m)	72,402 ft (22,068 m)	118,180 ft (36,021 m)
1,500 ft (457 m)	222 ft (68 m)	471 ft (144 m)	896 ft (273 m)	1,862 ft (568 m)	2,809 ft (856 m)	5,468 ft (1,667 m)	8,784 ft (2,677 m)	15,676 ft (4,778 m)	23,098 ft (7,040 m)	32,355 ft (9,862 m)	59,116 ft (18,019 m)	96,493 ft (29,411 m)
2,000 ft (610 m)	193 ft (59 m)	408 ft (124 m)	776 ft (237 m)	1,612 ft (491 m)	2,432 ft (741 m)	4,736 ft (1,444 m)	7,607 ft (2,319 m)	13,576 ft (4,138 m)	20,003 ft (6,097 m)	28,021 ft (8,541 m)	51,196 ft (15,605 m)	83,566 ft (25,471 m)

LP Liquid Connections (Liquid Withdrawal System)

Use the following chart to determine the supply pipe size for LP liquid.

Formula Example:

If a unit has a 135 hp engine 80 feet from the supply, the engine needs 449 ft³/hr of LP vapor to run efficiently. For liquid propane vapor fuel, there is 2500 BTU/ft³. From [Table 2](#), an 80 foot run requires a minimum 1/4 inch pipe at full engine load.

$$2500 \text{ ft}^3/\text{hr} \times 449 \text{ ft}^3/\text{hr} = 1,122,500 \text{ BTU}/\text{ft}^3$$

$$\frac{449 \text{ ft}^3/\text{hr}}{36.39^*} = 12.33 \text{ gallons per hour}$$

*Cubic feet of vapor at 60°F (16°C) per gallon of liquid at 60°F (16°C).

Table 2 - LP Liquid Line Sizing Chart

Liquid Propane Flow	Iron Pipe Size													
	1/4 in (0.6 cm)		3/8 in (1 cm)		1/2 in (1 cm)		3/4 in (2 cm)		1 in (3 cm)		1-1/4 in (3 cm)		1-1/2 in (4 cm)	
	Schedule		Schedule		Schedule		Schedule		Schedule		Schedule		Schedule	
	40	80	40	80	40	80	40	80	40	80	40	80	40	80
	Distance													
10 gal/hr (38 L/hr)	729 ft (222 m)	416 ft (127 m)	-	-	-	-	-	-	-	-	-	-	-	-
15 gal/hr (57 L/hr)	324 ft (99 m)	185 ft (56 m)	-	-	-	-	-	-	-	-	-	-	-	-
20 gal/hr (76 L/hr)	182 ft (55 m)	104 ft (32 m)	825 ft (251 m)	521 ft (159 m)	-	-	-	-	-	-	-	-	-	-
40 gal/hr (151 L/hr)	46 ft (14 m)	26 ft (8 m)	205 ft (62 m)	129 ft (39 m)	745 ft (227 m)	504 ft (154 m)	-	-	-	-	-	-	-	-
60 gal/hr (227 L/hr)	20 ft (6 m)	11 ft (3 m)	92 ft (28 m)	58 ft (18 m)	331 ft (101 m)	224 ft (68 m)	-	-	-	-	-	-	-	-
80 gal/hr (303 L/hr)	11 ft (3 m)	6 ft (2 m)	51 ft (16 m)	32 ft (10 m)	187 ft (57 m)	127 ft (39 m)	735 ft (224 m)	537 ft (164 m)	-	-	-	-	-	-
100 gal/hr (379 L/hr)	7 ft (2 m)	4 ft (1 m)	33 ft (10 m)	21 ft (6 m)	119 ft (36 m)	81 ft (25 m)	470 ft (143 m)	343 ft (105 m)	-	-	-	-	-	-
120 gal/hr (454 L/hr)	-	-	23 ft (7 m)	15 ft (5 m)	83 ft (25 m)	56 ft (17 m)	326 ft (99 m)	238 ft (73 m)	-	-	-	-	-	-
140 gal/hr (530 L/hr)	-	-	15 ft (5 m)	9 ft (3 m)	61 ft (19 m)	41 ft (12 m)	240 ft (73 m)	175 ft (53 m)	813 ft (248 m)	618 ft (188 m)	-	-	-	-
160 gal/hr (606 L/hr)	-	-	13 ft (4 m)	8 ft (2 m)	47 ft (14 m)	32 ft (10 m)	184 ft (56 m)	134 ft (41 m)	623 ft (190 m)	473 ft (144 m)	-	-	-	-
180 gal/hr (681 L/hr)	-	-	-	-	37 ft (11 m)	25 ft (8 m)	145 ft (44 m)	106 ft (32 m)	491 ft (150 m)	373 ft (114 m)	-	-	-	-
200 gal/hr (757 L/hr)	-	-	-	-	30 ft (9 m)	20 ft (6 m)	118 ft (36 m)	86 ft (26 m)	399 ft (122 m)	303 ft (92 m)	-	-	-	-
240 gal/hr (908 L/hr)	-	-	-	-	21 ft (6 m)	14 ft (4 m)	81 ft (25 m)	59 ft (18 m)	277 ft (84 m)	211 ft (64 m)	-	-	-	-
280 gal/hr (1,060 L/hr)	-	-	-	-	15 ft (5 m)	10 ft (3 m)	60 ft (18 m)	44 ft (13 m)	204 ft (62 m)	155 ft (47 m)	-	-	-	-
300 gal/hr (1,136 L/hr)	-	-	-	-	13 ft (4 m)	9 ft (3 m)	52 ft (16 m)	38 ft (12 m)	177 ft (54 m)	135 ft (41 m)	785 ft (239 m)	623 ft (190 m)	-	-
350 gal/hr (1,325 L/hr)	-	-	-	-	-	-	38 ft (12 m)	28 ft (9 m)	130 ft (40 m)	99 ft (30 m)	578 ft (176 m)	459 ft (140 m)	-	-
400 gal/hr (1,514 L/hr)	-	-	-	-	-	-	30 ft (9 m)	22 ft (7 m)	99 ft (30 m)	75 ft (23 m)	433 ft (132 m)	344 ft (105 m)	980 ft (299 m)	794 ft (242 m)

How to use chart:

1. Having determined the required flow at point of use, locate this flow in the left hand column. If this falls between two figures, use the larger of the two.
2. Determine total length of piping required from source to point of use.

3. Read across chart from left (required flow) to right to find the total length which is equal to, or exceeds, the distance from source to use.
4. From this point, read up to find the correct size of pipe required.

Valve and Fitting Pipe Equivalents

Table 3 - Valve & Fitting Pipe Equivalents

Fitting	Equivalent Length Of Steel Pipe													
	Nominal Pipe Size (NPT)													
	3/4 in (2 cm)		1 in (3 cm)		1-1/4 in (3 cm)		1-1/2 in (4 cm)		2 in (5 cm)		2-1/2 in (6 cm)		3 in (8 cm)	
	Schedule		Schedule		Schedule		Schedule		Schedule		Schedule		Schedule	
	40	80	40	80	40	80	40	80	40	80	40	80	40	80
45° Screwed Elbow	1.2 ft (0.4 m)	0.9 ft (0.3 m)	1.3 ft (0.4 m)	1.2 ft (0.4 m)	1.7 ft (0.5 m)	1.5 ft (0.5 m)	2.0 ft (0.6 m)	1.8 ft (0.5 m)	2.6 ft (0.8 m)	2.4 ft (0.7 m)	3.0 ft (0.9 m)	2.8 ft (0.9 m)	3.8 ft (1.2 m)	3.7 ft (1.1 m)
90° Screwed Elbow	1.8 ft (0.5 m)	1.6 ft (0.5 m)	2.3 ft (0.7 m)	2.1 ft (0.6 m)	3.1 ft (0.9 m)	2.9 ft (0.9 m)	3.7 ft (1.1 m)	3.4 ft (1.0 m)	4.6 ft (1.4 m)	4.4 ft (1.3 m)	5.3 ft (1.6 m)	5.1 ft (1.6 m)	6.9 ft (2.1 m)	6.5 ft (2.0 m)
Screwed T Thru Run	1.4 ft (0.4 m)	1.3 ft (0.4 m)	1.7 ft (0.5 m)	1.6 ft (0.5 m)	2.4 ft (0.7 m)	2.3 ft (0.7 m)	2.8 ft (0.9 m)	2.6 ft (0.8 m)	3.6 ft (1.1 m)	3.3 ft (1.0 m)	4.2 ft (1.3 m)	4.0 ft (1.2 m)	5.4 ft (1.6 m)	5.0 ft (1.5 m)
Screwed T Thru Branch	4.6 ft (1.4 m)	4.0 ft (1.2 m)	5.6 ft (1.7 m)	5.3 ft (1.6 m)	7.9 ft (2.4 m)	7.3 ft (2.2 m)	9.3 ft (2.8 m)	8.6 ft (2.6 m)	12.0 ft (3.7 m)	11.0 ft (3.4 m)	15.0 ft (4.6 m)	14.0 ft (4.3 m)	17.0 ft (5.2 m)	16.0 ft (4.9 m)
Screwed Globe Valve*	14.0 ft (4.3 m)	10.0 ft (3.0 m)	21.0 ft (6.4 m)	16.0 ft (4.9 m)	24.0 ft (7.3 m)	19.0 ft (5.8 m)	39.0 ft (11.9 m)	27.0 ft (8.2 m)	42.0 ft (12.8 m)	34.5 ft (10.5 m)	24.0 ft (7.3 m)	20.0 ft (6.1 m)	46.0 ft (14.0 m)	39.0 ft (11.9 m)
Screwed Angel Valve*	11.0 ft (3.4 m)	8.0 ft (2.4 m)	13.0 ft (4.0 m)	10.0 ft (3.0 m)	10.5 ft (3.2 m)	8.5 ft (2.6 m)	20.0 ft (6.1 m)	16.0 ft (4.9 m)	32.0 ft (9.8 m)	26.5 ft (8.1 m)	7.5 ft (2.3 m)	6.0 ft (1.8 m)	19.0 ft (5.8 m)	16.0 ft (4.9 m)
Flanged Globe Valve*	-	-	-	-	-	-	30.0 ft (9.1 m)	24.0 ft (7.3 m)	4.10 ft (1.2 m)	34.0 ft (10.4 m)	-	-	46.0 ft (14.0 m)	39.0 ft (11.9 m)
Flanged Angle Valve*	-	-	-	-	-	-	12.0 ft (3.7 m)	10.0 ft (3.0 m)	14.5 ft (4.4 m)	12.0 ft (3.7 m)	-	-	19.0 ft (5.8 m)	16.0 ft (4.9 m)

* Reg O A7500 series valves.

Electrical Connections

Class 1 wiring methods must be used for field wiring connections to terminals of a class 2 circuit. It is the responsibility of the owner/operator to arrange for these procedures to be performed by a licensed electrical contractor and ensure conformance to all applicable codes, including local codes specific to your municipality/city/county and state. Wire size and insulation type should be as required by National Electrical Code (NEC), state and local regulations.

⚠ DANGER

ELECTROCUTION. NEVER CONNECT THIS UNIT TO THE ELECTRICAL SYSTEM OF ANY BUILDING UNLESS A LICENSED ELECTRICIAN HAS INSTALLED AN APPROVED TRANSFER SWITCH. FAILURE TO DO SO WILL RESULT IN DEATH OR SERIOUS INJURY. (000150)

⚠ WARNING

Only qualified service personnel may install, operate and maintain this equipment. Failure to follow proper installation requirements could result in death, serious injury, and damage to equipment or property. (000182)

⚠ DANGER

ELECTROCUTION. VERIFY ELECTRICAL SYSTEM IS PROPERLY GROUNDED BEFORE APPLYING POWER. FAILURE TO DO SO WILL RESULT IN DEATH OR SERIOUS INJURY. (000152)

DUAL FUEL SYSTEM

This unit is equipped with a dual fuel system. This type of fuel system allows the unit to run on either natural gas (primary) or LP liquid (secondary). In the event that the primary source becomes unavailable, the unit will automatically switch to the secondary source. It can do so while in operation.

Natural Gas (Well Gas) Fuel System

Natural gas is supplied from a utility supply line or well site in its vapor state through in-ground piping. The vapor enters the large fuel inlet located on the right side of the unit frame.

LP Liquid Withdrawal Fuel System

LP is supplied as a liquid in pressurized tanks. The liquid must be converted to its gaseous state before it is introduced into the engine carburetor. The unit is equipped with a vaporizer converter to accomplish this. The LP liquid enters the fuel system through the small fuel inlet located on the right side of the frame. As the liquid passes through the vaporizer, heated engine coolant is passed through the vaporizer to provide the necessary heat for conversion of the fuel from a liquid to a gaseous state.

⚠ DANGER

EXPLOSION AND FIRE. FUEL AND VAPORS ARE EXTREMELY FLAMMABLE AND EXPLOSIVE. ADD FUEL IN A WELL VENTILATED AREA. KEEP FIRE AND SPARK AWAY. FAILURE TO DO SO WILL RESULT IN DEATH OR SERIOUS INJURY. (000105)

IMPORTANT: THIS UNIT IS NOT DESIGNED TO OPERATE ON LP VAPOR. If your LP supply tank does not have a liquid withdrawal system, a licensed LP supply company will need to install the correct fitting to allow for it. For special fuel system configurations, contact Generac Mobile Products Technical Support.

DC FUSES

Located inside the control panel, the fuses protect the control panel wiring and components from damaging overload. For fuse location and identification, see [Figure 7](#).

GENERATOR AND LOAD COMPATIBILITY

This unit is a revolving field, alternating current type generator set. The generator is designed to supply electrical power for the operation of compatible electrical loads.

The generator must be fully compatible with the rated voltage, phase rotation, and frequency of the connected electrical loads. The generator, connected electrical devices, or both, can be damaged if voltage, phase, and frequency are not compatible.

See the data label affixed to the unit for rated AC voltage, wattage, amperage, number of phases, etc.

ENGINE/GENERATOR PROTECTIVE DEVICES

The unit may be required to operate for long periods of time without an operator on hand to monitor operating conditions. For this reason, the unit has numerous sensors to provide the control panel with the information it needs to protect both the engine and generator. The control panel is designed to shut down the engine if potentially damaging conditions occur. These conditions can include low oil pressure, high coolant temperature, low coolant level, engine overspeed, over or under voltage, over or under frequency, etc. These settings are configured at the factory and can be changed/adjusted by an Independent Authorized Service Dealer if required.

DIGITAL CONTROLLER

The generator leaves the factory with the controller warning set at 105% load and shutdown set at 110% load. The unit is equipped with a digital controller with paralleling capabilities. The paralleling feature allows the operator to synchronize multiple controllers and distribute the load between units. Contact Generac Mobile Products Technical Support for more information about this feature.

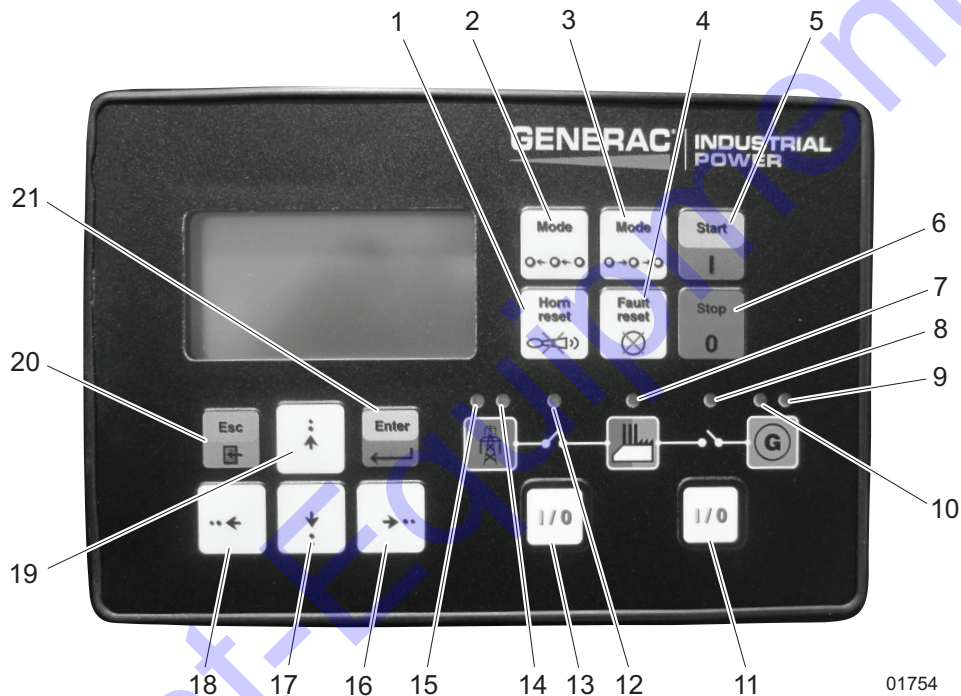

Figure 10 - Digital Controller Pushbuttons and LEDs

1. **Horn Reset:** Deactivates the horn (audible alarm).
2. **Mode ←:** Cycles backward through genset operation modes.
3. **Mode →:** Cycles forward through genset operation modes.
4. **Fault Reset:** Acknowledges faults and alarms.
5. **Start:** Starts the genset in manual (MAN) mode.
6. **Stop:** Stops the genset in manual (MAN) mode.
7. **Bus:** Green LED is on if bus voltage is present and within limits.
8. **GCB ON:** Green LED is on if generator circuit breaker feedback is active. Flashes during synchronizing.
9. **Genset Failure:** Red LED starts flashing when any failure occurs. After Fault Reset button is pressed, changes to steady light (if an alarm is still active) or is off (if no alarm is active).

10. **Gen Voltage Present:** Green LED is on if generator voltage is present and within limits.
11. **GCB ON (I)/OFF (O):** Opens and closes (synchronizes) the generator circuit breaker in manual MAN mode.
12. **MCB ON:** Green LED is on if the mains circuit breaker feedback is active. Flashes during reverse synchronizing (synchronizing of the loaded genset back to the restored mains).
13. **MCB ON (I)/OFF (O):** Opens and closes (synchronizes) the mains circuit breaker in manual MAN mode.
14. **Mains Voltage Present:** Green LED is on if voltage on the mains terminals is present (in SPI and SPtM). LED is not active in MINT, COX.
15. **Mains Failure:** Red LED starts flashing when the mains failure occurs and genset does not run, changes to steady light when the genset starts, and then turns off when the mains restores.
16. →: Moves history record displayed columns to the right, five percent increase of edited setpoint's value (step given by the setpoint range), go back from Alarm list.
17. ↓: Select the setpoint, select the screen, select history record or decrease setpoint value.
18. ←: Moves history record displayed columns to the left, five percent decrease of edited setpoint's value (step given by the setpoint range), view Alarm list from measurement screens.
19. ↑: Select the setpoint, select the screen, select history record or increase setpoint value.
20. **Esc:**

Where	Function
Measurement screens, Alarm list	Go to MENU screen
Setpoints screen	Go to Menu screen; within setpoint group, go to group list
Setpoint edit	Leave setpoint edit without changes
History screen	Go to Menu screen
FastEdit screen	FastEdit exit (to previous measurement screen) without changes
Language screen	Language screen exit (to Menu) without save

21. **Enter:**

Where	Function
Menu screen	Go to selected display group (Measurement CU, Measurement IO.)
Measurement screens, Alarm list	Go to FastEdit screen, hold Enter button for four seconds, then it is possible to adjust selected setpoint. (Typically Base load for standard SPtM.)
Setpoints screen	Go to selected setpoint group
Setpoint edit	Start setpoint edit/save changes
History screen	Go to the first column of the first history record
FastEdit screen	FastEdit exit (to previous measurement screen) with setpoint change
Language screen	Language screen exit (to Menu) and save selection

For more detailed controller information, see the controller operator guide included with the unit.

Setting the Clock

To set the clock on the digital controller, press Esc, then select Setpoints>Date/Time>Time. Press Enter. Use the up and down arrows to adjust the settings, then press Enter.

Section 3 - Operation

The operation of this unit should only be performed by an authorized operator; that is, someone who has been properly trained by an Independent Authorized Service Dealer. Contact your local Independent Authorized Service Dealer for assistance in training authorized operators. Read the operating manual thoroughly and understand all instructions before operating the equipment.

The following instructions assume that the unit has been properly set up, serviced, tested, adjusted, and otherwise prepared for use by an Independent Authorized Service Dealer. Read the safety information carefully before attempting to operate this equipment.

PRESTART CHECKLIST

When the initial installation is complete, these checks must be performed before starting the engine. These checks are not required before each start, only after the initial installation.

▲ CAUTION

Do not apply high voltage to windings in moisture-saturated conditions. Serious damage to genset and property can result. (000153)

Note: These precautions are extremely critical in locations such as seaboard installations and other high humidity areas. Some installations will be in environments that are much more corrosive than others.

- Verify battery disconnect switch is turned ON.
- Verify unit is positioned in a stable manner.
- Verify proper clearance on all sides and top of enclosure.
- Verify unit is a safe distance from any flammable or combustible material.
- Verify no load is connected to unit.
- Inspect the engine and genset and verify there are no loose wires or components. Tighten if necessary.
- Verify engine oil level is correct. See **Check Engine Fluids**.
- Verify engine coolant level is correct. See **Adding Coolant**.
- Verify the controller is in STOP mode by pressing the STOP button.
- Verify the fuel valve is open and the pressure and flow rate are correct.
- Remove all tools, rags, etc. from inside the unit enclosure. Close and secure all enclosure doors prior to starting the unit.

MANUALLY STARTING THE UNIT

This unit is designed to operate on Natural Gas (NG)/well gas or LP liquid. At oil well sites, LP liquid is typically used to start the unit until the pump jack brings the well gas (natural gas) up to the surface. The unit fuel system will detect when there is sufficient pressure to switch to natural gas as the primary fuel source.

Natural Gas (Well Gas) Start Up

If there is sufficient pressure in the well gas fuel line (10-20 psi [69-138 kPa]), the unit can be started directly on well gas. Follow the steps below:

1. Open the manual ball fuel valve located just inside the frame. See **Fuel System (MGG155 Shown)**.
2. Check for fuel leaks.
3. Press the START on the digital controller. The controller will sense the type of fuel entering the system and will display "ALI NG Fuel Select".

Note: If the unit will not start, verify the Fuel Select switch is set to NG or AUTO. See **Figure 9**.

LP Liquid Start Up

4. Open the LP liquid tank supply valve and the natural gas manual fuel valve (see [Figure 6](#) for location). If any leaks are detected, correct them immediately.
5. Press the START button on the digital controller.
6. When the natural gas pressure reaches 10-20 psi (69-138 kPa), move the Fuel Select switch to the NG position. (You may have to toggle the switch between NG and LP until the unit runs smoothly on NG.)
7. Move the switch to AUTO.

Note: It will not be necessary to purge the fuel lines after shutting the unit down for maintenance or service unless the fuel lines have been disconnected.

When the unit reaches operation speed, verify the voltage setting is correct and adjust if necessary. If the engine fails to start, see [Troubleshooting](#).

AUTO (REMOTE) STARTING THE UNIT

Connect the remote start contact to the remote start terminals on the terminal block (#12 and #34). Follow all NEC, state and local regulations.

Note: The bonding plate may need to be removed. See [Figure 12](#) for bonding plate location.

A ground connection is located next to the lugs. The generator neutral is bonded to ground when it is shipped from the factory. The bonding plate may need to be removed if the generator is used as a standby power source.

INSTALLATION SHOULD BE IN COMPLIANCE WITH THE NATIONAL ELECTRICAL CODE (NEC), STATE AND LOCAL REGULATIONS.

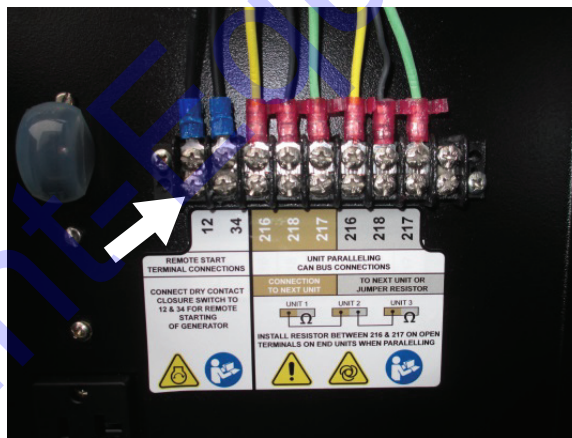

02022

Figure 11 - Terminal Block

PARALLEL SETUP AND OPERATION

The unit can be operated in parallel with other parallel-capable units. To ensure the units to be used in parallel are appropriate for the load, contact Generac Mobile Products Technical Support at 1-800-926-9768.

Before running units in parallel, make sure each unit is operating properly. Set up auto (remote) starting on each unit.

Paralleling Two Units

Using the provided CAN parallel cable, connect one end of the cable to the terminal block of the first unit and the other end to the terminal block of the second unit. Match each wire with the corresponding color wire connected to the terminal block; yellow to yellow, green to green, black (shield) to black. Connect the provided 120 ohm resistor

to the unused terminals on both units as shown on the decal located below the terminal blocks.

Paralleling More Than Two Units

To parallel more than two units, connect another CAN parallel cable from the unused terminal on the second unit (remove resistor, if necessary) to a terminal on the next unit. Continue chaining the parallel units. Connect the resistors to the unused terminals **on the first and last units in the series**.

Once the units are set up in parallel, they will share the load evenly during normal operation. If parallel units are in auto mode and one unit is shut down, the load will transfer to the remaining units on line. If all paralleled units are in manual mode, press the GCB (Generator Circuit Breaker) button on the controller, and the load gradually transitions to the other units.

Note: *When one or more units shut down, any remaining units will shut down if the increase in proportional load is greater than what the unit is rated for. Contact Generac Mobile Products Technical Support to verify the units to be used in parallel are appropriate for the planned load.*

OPERATION CHECKS

With the engine running, verify the following:

- Verify there are no fuel leaks. If a fuel leak is detected, stop the engine immediately by pressing STOP on the controller. Repair any fuel leaks before proceeding.
- Verify there are no coolant or oil leaks. If a leak is detected, stop the engine immediately and repair the leak before proceeding.
- Verify that operation is smooth. If belt squeals, vibrations or other sources of noise exist, stop the engine immediately and repair before proceeding.
- Verify correct voltage (line-to-line and line-to-neutral) at the genset.
- Verify phase rotation is the same as the attached equipment.
- Minor adjustment of the output voltage is made using the voltage adjust potentiometer on the control panel.

▲ WARNING

DO NOT open coolant system until engine has completely cooled. Doing so could result in serious injury. (000154)

- After the operational checks are made, stop the engine by pressing STOP on the controller, and wait for the engine to cool. When the engine is cool, check engine oil and coolant levels.

OVERCRANK SHUTDOWN

After a pre-specified duration of cranking, this function ends cranking if the engine has failed to start. The default settings are:

- The unit will attempt to start (crank) three times.
- Each crank cycle lasts 10-15 seconds, followed by a five second rest (to cool the starter).
- After three starting attempts, the controller alarm will sound and the LCD window on the controller will display "Start Fail Alarm".

ENGINE OIL REPLENISHMENT SYSTEM

This unit is equipped with an engine oil replenishment system. The system eliminates the need for frequent filling and checking of the crankcase. The system consists of a oil reservoir tank and an oil level regulator. The regulator is mounted so the centerline of the sight glass is at the same height as the level of the oil in the crankcase. When the engine oil level is low, the float will trigger the reservoir tank to send fresh oil to the crankcase. The regulator delivers only that amount of oil required to maintain a constant oil level in the crankcase. A fine mesh screen in the regulator provides protection against damage by contaminants and abrasive foreign matter.

The regulator is pre-set to the correct level at the factory and should not require adjustment. See [Check Engine Fluids](#) for more information.

DERATING FOR ALTITUDE

All units are subject to derating for altitude and temperature; this will reduce the available power for operating tools and accessories connected to the receptacles. Typical reductions in performance are a derate of -3% for every 1000 ft (305 m) above 1200 ft (366 m) above sea level and a derate of -1% per 10°F (-12°C) increase in ambient air temperature over 77°F (25°C).

GENERATOR OUTPUT CONNECTIONS

The unit is equipped with lug connections, located inside the customer connection box. The connection box is located behind the door on the right side of the unit. See [Figure 5](#). The lugs provide connection points for attachment of external loads to the generator.

▲ DANGER

RISK OF ELECTROCUTION. BEFORE ANY CONNECTIONS ARE MADE TO THE GENERATOR, VERIFY THE MAIN CIRCUIT BREAKER AND THE BATTERY DISCONNECT SWITCH ARE OFF (O). POTENTIALLY LETHAL VOLTAGES MAY BE PRESENT AT THE GENERATOR CONNECTION LUGS.

▲ WARNING

Only a trained and licensed electrician should perform wiring and connections to unit. Failure to follow proper installation requirements could result in death, serious injury, and damage to equipment or property. (000155)

Connections to the lugs should be made by running the power cables up through the opening in the bottom of the box. **DO NOT** make any connections directly to the lugs without routing the cables through the slot. Use a hex-wrench to tighten the cable connections.

The connection box door is equipped with a safety interlock switch that will trip the main circuit breaker and disable the voltage regulator if the door is opened while the unit is operating.

▲ DANGER

ELECTROCUTION. DO NOT DISABLE OR MODIFY THE CONNECTION BOX DOOR SAFETY SWITCH. DOING SO WILL RESULT IN DEATH OR SERIOUS INJURY. (000157)

A ground connection is located next to the lugs. The generator neutral is bonded to ground when it is shipped from the factory. The bonding plate may need to be removed if the generator is used as a standby power source.

INSTALLATION SHOULD BE IN COMPLIANCE WITH THE NATIONAL ELECTRICAL CODE (NEC), STATE AND LOCAL REGULATIONS.

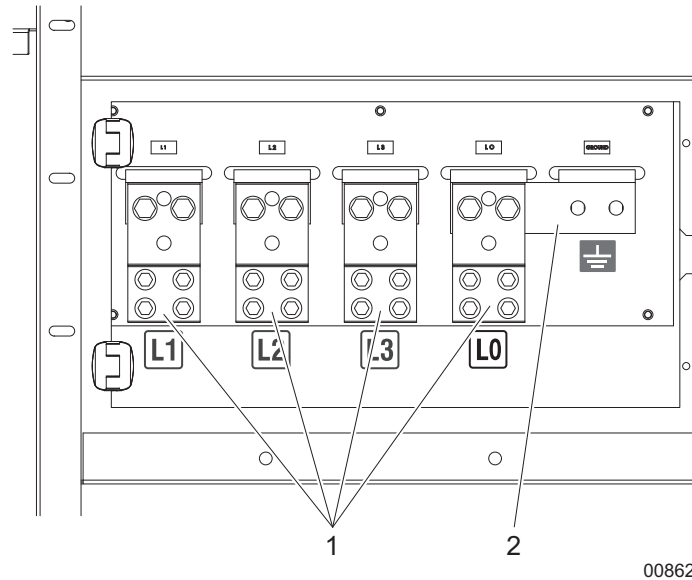

Figure 12 - Generator Output Connections

- 1. Connections lugs
- 2. Bonding plate

CUSTOMER CONVENIENCE RECEPTACLES

The unit is equipped with two 120V GFCI receptacles, located to the right of the customer connection box. These receptacles are not routed through the main circuit breaker. Each receptacle has its own circuit breaker, located directly above it.

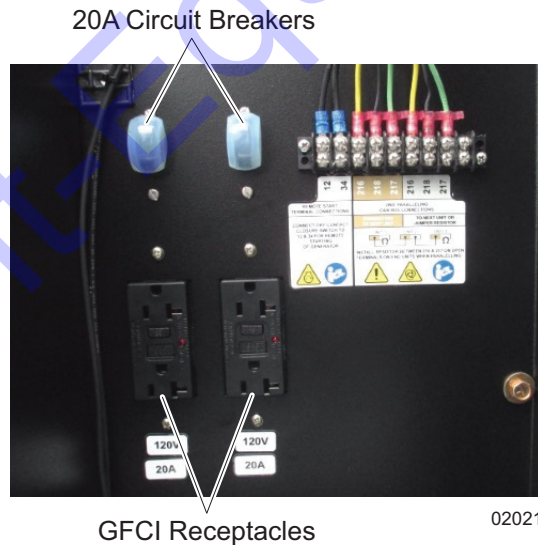

Figure 13 - 120V GFCI Receptacles

NOTICE

Power to the receptacles is available any time the generator is running, even if the main circuit breaker is OFF (O). **VERIFY ANY EQUIPMENT CONNECTED TO THE CONVENIENCE RECEPTACLES IS TURNED OFF BEFORE TURNING THE BREAKERS ON** and the output voltage is correct for the equipment that is connected to the receptacles. Improper voltage may cause equipment damage, property damage, or malfunction.

MAIN CIRCUIT BREAKER

When the main circuit breaker is OFF (O), power is interrupted between the bus connections and the generator. Once connections have been made to the bus bars and the generator has been started and allowed to reach normal operating temperature, the breaker may be switched ON (I).

The main circuit breaker will be tripped, disconnecting power to the bus connections, if any of the following conditions occur while the unit is running:

- Overload of the generator circuits to the bus connections. At 105% load, there will be an audible warning. At 110% load, the breaker opens and power will be disconnected.
- The customer connection box door is opened.
- The emergency stop switch is activated.

Verify any problems that cause the main circuit breaker to trip are corrected before returning the switch to ON (I).

Frame Ground Connection

Follow all NEC, state and local regulations pertaining to frame ground connections.

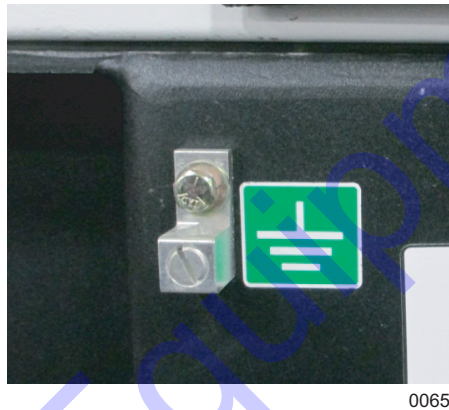

Figure 14 - Frame Ground Connection

Determine ground stud location and connect the ground wire to the “earth ground” terminal. This ground is the local reference ground to ground the unit frame only.

Battery Disconnect Switch

The unit is equipped with a battery disconnect switch which allows the operator to disconnect power from the batteries by turning the switch to OFF.

SHUTTING DOWN THE UNIT

1. Verify power to the load can be interrupted. There may be other procedures that must be done before shutting a unit down, depending on the application.
2. Open the Main Circuit Breaker (MCB) by pressing the right I/O button on the controller.
3. Allow the unit to cool down (running at no-load) for approximately five minutes to prevent damage to critical engine components.
4. Press STOP on the controller.
5. Turn the battery disconnect switch to OFF.

EMERGENCY STOP SWITCH

This unit is equipped with an emergency stop switch. The switch is located on the outside of the rear enclosure panel. See [Figure 5](#). Activate the switch by pressing the red button in until it locks down. This will stop the engine. The switch will remain locked until the button is pulled out.

⚠ CAUTION

Equipment Damage. The emergency stop switch is not to be used to power down the unit under normal operating circumstances. Doing so will result in equipment damage. (000246)

TOWING THE TRAILER

Note: See [Towing Safety](#) before towing a trailer.

1. Use the jack to raise or lower the trailer onto the hitch of the towing vehicle. Lock the hitch coupling and attach the safety chains or cables to the vehicle. Raise the jack foot completely.
2. Connect any trailer wiring to the tow vehicle. Check for proper operation of the directional and brake lights.
3. Make sure all doors are properly latched.
4. Check for proper inflation of the trailer tires. For maximum tire pressures, see [Specifications](#).
5. Check the wheel lugs. Tighten or replace any that are loose or missing. If a tire has been removed for axle service or replaced, tighten the lugs in the order shown to the following specifications:
 - a. First pass tighten to 20-25 ft-lbs (27-33 Nm).
 - b. Second pass tighten to 50-60 ft-lbs (67-81 Nm).
 - c. Third pass tighten to 90-120 ft-lbs (122-162 Nm).
6. Start all lug nuts by hand.

Note: After the first road use, repeat tightening procedure.

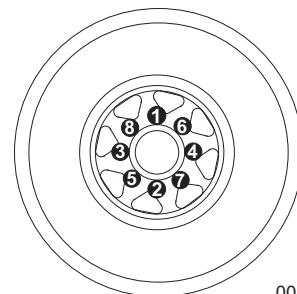

00670

Figure 15 - Lug Sequence

Section 4 - Maintenance

EMISSIONS

The United States Environmental Protection Agency (US EPA) (and California Air Resources Board (CARB), for engines/equipment certified to California standards) requires that this engine/equipment complies with exhaust and evaporative emissions standards. Locate the emissions compliance decal on the engine to determine applicable standards. For emissions warranty information, please reference the included emissions warranty. It is important to follow the maintenance specifications in the manual to ensure that the engine complies with the applicable emissions standards for the duration of the product's life.

MAINTENANCE TASKS

Regular maintenance will improve performance and extend engine/equipment life. Generac Mobile Products LLC recommends that all maintenance work be performed by an Independent Authorized Service Dealer (IASD). Regular maintenance, replacement or repair of the emissions control devices and systems may be performed by any repair shop or person of the owner's choosing. However, to obtain emissions control warranty service free of charge, the work must be performed by an IASD. See the emissions warranty.

Daily checks must be performed when the unit is operated continuously for extended periods of time. Daily checks and routine monthly checks can be performed by an authorized operator.

Normal maintenance service and replacement of parts is the responsibility of the owner and are not considered defects in materials or workmanship within the terms of the warranty. It is strongly recommended the equipment be periodically checked by an Independent Authorized Service Dealer.

Daily Walk Around Inspection

Look for conditions that could hinder performance or safety, such as (but not limited to) oil, coolant, gas (natural or LP) leakage, blocked vents, loose or missing hardware and electrical connections. Check for foreign matter blocking the vents and on top of the unit.

When the unit is not running:

- Visually inspect the fan belt for cracks, fraying and stretching. Verify the belt is properly seated in the pulley grooves. Every 750 hours, it is recommended the belt be removed and checked for wear. While the belt is removed, inspect pulleys and bearing. Rotate and feel for hard turning or unusual sounds.
- Coolant should be checked daily. Coolant should be visible in the sight glass located near the top of the radiator. See [Adding Coolant](#).
- Check electrical connectors, battery and battery disconnect switch connections, and ground points. Look for loose or missing hardware.
- Check all flexible rubber hoses for deterioration.

Check Fuel System

Check the fuel supply pressure. At the well fuel inlet, the well gas should be a minimum of 10 psi (69 kPa) and a maximum of 20 psi (138 kPa).

Check Engine Fluids

The following checks can be performed by a trained authorized operator. Observe all safety precautions outlined in [Safety](#).

Check Engine Oil Level

An authorized operator should check the engine oil level daily. The oil level should be maintained between the full and add marks on the engine dipstick. Recommended fluids are listed in [Engine Oil Recommendations](#).

Check the level on the oil level regulator sight glass. The oil level should be about halfway up the sight glass when the engine is running. If not, adjust the regulator height by loosening the two screws on the regulator bracket and slowly sliding the regulator along the slots until the oil is at the proper level. Tighten the screws.

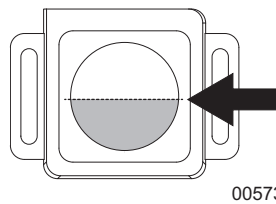

Figure 16 - Oil Level Sight Glass

This unit is equipped with an auxiliary engine oil reservoir. The level in the reservoir should be checked periodically and oil added as needed. Verify the reservoir valve is open to allow oil to drain into the oil level regulator. Close the valve before moving the unit.

To check the engine oil using the dipstick:

1. Locate the engine oil dipstick. See [Component Locations](#).
2. The most accurate oil level readings are measured when the engine is cold. If the engine was running, wait at least ten minutes before proceeding.
3. Remove the dipstick and wipe it dry with a clean, lint free cloth.
4. Slowly insert the clean dipstick into the tube. Visually confirm the dipstick is fully seated in the dipstick tube. A visual inspection is required because some dipsticks will require more effort than others to fully seat.
5. After ten seconds, remove the dipstick and look at the oil level on both sides. The lower of the two readings will be the correct oil level measurement.
6. Add oil (if necessary) to adjust the level. After adding or changing the oil, the engine should run for one minute before checking the oil level. Remember to wait ten minutes to allow the engine to cool and oil to fully drain into the oil pan.

Typical causes of inaccurate oil level readings:

- Reading the high level of the dipstick.
- Reading the dipstick before the oil fully drains into the oil pan.
- Inserting and removing the dipstick too quickly.
- The dipstick is not fully seated in the dipstick tube.

Changing the Oil

Note: When changing oil, it is not necessary to drain the oil from the reservoir.

1. Close the valve below the oil reservoir.
2. Place a container below the oil drain port, located on the left side of the skid frame. Remove the oil drain plug with an Allen head wrench.
3. Open the drain valve at the engine oil pan. Verify the oil level regulator valve is open.
4. Allow the oil to drain completely into the container.

5. Remove the oil filter and discard it. Make sure the old gasket did not separate from the filter and become stuck to the engine. If so, remove the gasket and discard it.
6. Before installing the new oil filter, lubricate the new gasket with a thin film of clean engine oil.
7. Install the new oil filter, turning one full turn after initial gasket contact.
8. Close the engine oil drain valve and reinstall the plug at the skid frame drain port.
9. Remove the oil fill cap on the engine valve cover and add fresh oil. See *Specifications* for oil capacities and *Engine Oil Recommendations* for oil type.
10. Verify the fuel level is between the Full and Add marks on the dipstick.
11. Open the oil reservoir valve.
12. Top off the oil in the reservoir.
13. There is no need to run the unit and verify the oil level. The filter will automatically fill up with oil and the oil switch will allow the proper amount of oil to feed the engine until full.

Adding Coolant

Visually check the coolant level in the sight glass located near the top of the radiator. If coolant is not visible, add coolant to the system. Let engine cool (not at operating temperature, not running), before adding coolant. Add a 50/50 mixture of the correct antifreeze and distilled or deionized water to the coolant system.

▲ DANGER

RISK OF POISONING. DO NOT USE MOUTH TO SIPHON COOLANT. DOING SO WILL RESULT IN DEATH OR SERIOUS INJURY. (000149)

▲ WARNING

DO NOT open coolant system until engine has completely cooled. Doing so could result in serious injury. (000154)

▲ CAUTION

Wash hands thoroughly after handling coolant. Do not store used antifreeze in an open container because animals are attracted to the smell and the taste of antifreeze even though it is poisonous.

▲ CAUTION

Do not use any chromate base rust inhibitor with propylene glycol base antifreeze, boosters or additives. Doing so will cause overheating. (000165)

Integrated Electronic Pressure Regulator (IEPR) Maintenance and Inspection

If the IEPR fails to operate or develops a leak, it should be repaired or replaced with the OEM recommended replacement parts. When inspecting the system, check for the following items:

- Check for any fuel leaks at the inlet and outlet fittings.
- Check for any fuel leaks in the IEPR body.
- Check the inlet and outlet fittings of the coolant supply lines for water leaks, if applicable.
- Verify the IEPR is securely mounted and the mounting bolts are tight.
- Check the IEPR for external damage.

- Check the IEPR electrical connection to verify the connector is seated and locked.

Checking/Draining Oil Build-Up in the Vaporizer Regulator

During the course of normal operation for LPG engines, oil or “heavy ends” may build inside the secondary chamber of the vaporizer regulator. These oil and heavy ends may be a result of poor fuel quality, contamination of the fuel, or regional variation of the fuel make up. A significant build up of oil can affect the performance of the secondary diaphragm response. It is recommended the oil be drained periodically. See the *Maintenance Schedule* for intervals. This is the minimum requirement to maintain the emission warranty.

We recommend the vaporizer regulator be drained at every engine oil change if contaminated or sub-standard fuel is suspected or known to have been used. Failure to follow this recommendation may be used to deny a warranty claim.

Note: *Draining the regulator when the engine is warm will help the oils to flow freely from the regulator.*

To drain the regulator, follow the steps below:

1. Verify the equipment is in a well-ventilated area and no external ignition sources are present.
2. Start the engine.
3. With the engine running, close the manual valve.
4. When the engine runs out of fuel, press STOP on the controller and turn the battery disconnect switch OFF.
5. Loosen the hose clamps at the inlet and outlet hoses on the regulator and remove the hoses.
6. Remove the regulator mounting bolts.
7. Place a small receptacle in the engine compartment under the regulator.
8. Rotate the regulator 90° so the outlet fitting is pointing down into the receptacle and drain the regulator.
9. Inspect the secondary chamber of the regulator for any large dried particles and remove.
10. Rotate the regulator back to its original position and reinstall the regulator mounting bolts.
11. Remove the receptacle. Dispose of any drained material in a safe and proper manner.
12. Install the fuel hoses.
13. Connect any other hoses removed during this procedure.
14. Slowly open the manual service valve.
15. Check for leaks at the inlet and outlet fittings using a soapy solution or an electronic leak detector. If leaks are detected, repair the leaks.
16. Check coolant line connection to verify no leaks are present.
17. Start engine.
18. Recheck for leaks at the regulator.

MAINTENANCE SCHEDULE

Periodic inspection, service, and maintenance of this unit is critical in ensuring its reliable operation. The following is the manufacturer’s recommended maintenance schedule. The maintenance items will need to be performed more frequently if the unit is used in severe applications (such as very high or very low ambient conditions or extremely dirty/dusty environments). Use the unit hour meter or calendar time, whichever occurs first, from the previous maintenance interval to determine the next required maintenance interval. Note that some checks are based on

hours of operation.

Follow all applicable safety and caution statements found in the unit operating manual or engine service/maintenance manual before performing any maintenance checks or service.

This maintenance schedule reflects the minimum tasks that need to be accomplished to verify the unit remains operational. Some of the tasks can be performed by an authorized operator and others must be performed by an Independent Authorized Service Dealer.

Note: An authorized operator is one who has been trained by an Independent Authorized Service Dealer in the proper operation and inspection of this unit.

Use the schedule in the following table as a guide for regular maintenance intervals. For additional maintenance information, see the OEM engine manual.

Table 4 - Basic Maintenance Schedule

Item	Daily	First 50 Hours (Break In Period)	Every 750 Hours	8000 Hours (Annually)
Walk Around Inspection	◆			
Check Oil Level	◆			
Check Coolant Level	◆			
Check Belts	◆			
Check Electrical Wiring	◆			
Inspect Radiator for Signs of Obstruction or Damage	◆			
Inspect Gas Piping and Hoses for Leaks and Damage	◆			
Sample Engine Oil		◆*	◆	◆
Change Oil, Replace Oil Filters		◆	◆	◆
Inspect/Replace Crankcase Ventilation Filters		◆	◆	◆
Check All Flex Hoses		◆	◆	◆
Check and Adjust Intake and Exhaust Valve Clearance		◆	◆	◆
Inspect Coolant Hoses		◆	◆	◆
Visually Inspect Air Filter (replace if necessary)		◆	◆	◆
Inspect Shutoff Valve for Leaks and Closing		◆	◆	◆
Check Engine Air Induction for Leaks		◆	◆	◆
Drain LPL Vaporizer Oil Build Up		◆	◆	◆
Inspect Exhaust/Catalyst		◆	◆	◆
Service Batteries			◆	
Replace Spark Plugs			◆	◆
Check Battery Connections and Disconnect Switch				◆
Lubricate Trailer Leveling Jacks				◆
Check Engine and Generator Mounts				◆
Drain, Flush and Refill Cooling System				◆
Replace Ignition Coils				◆

* Many factors, such as environmental conditions and type of oil used, can affect how often the engine oil should be changed. The oil should be sampled every 250 hours initially to determine if it will be necessary to change the oil more frequently than the scheduled 750 hours.

Battery Inspection

▲ WARNING

Explosion. Batteries emit explosive gases while charging. Keep fire and spark away. Wear protective gear when working with batteries. Failure to do so could result in death or serious injury. (000137a)

▲ WARNING

Explosion. Do not dispose of batteries in a fire. Batteries are explosive. Electrolyte solution can cause burns and blindness. If electrolyte contacts skin or eyes, flush with water and seek immediate medical attention. (000162)

▲ WARNING

Risk of burn. Do not open or mutilate batteries. Batteries contain electrolyte solution which can cause burns and blindness. If electrolyte contacts skin or eyes, flush with water and seek immediate medical attention. (000163a)

▲ WARNING

Accidental start-up. Disconnect the negative battery cable, then the positive battery cable when working on unit. Failure to do so could result in death or serious injury. (000130)

▲ WARNING

Vision loss. Eye protection is required to avoid spray from spark plug hole when cranking engine. Failure to do so could result in vision loss. (000181)

▲ WARNING

Environmental hazard. Always recycle batteries at an official recycling center in accordance with all local laws and regulations. Failure to do so could result in environmental damage, death or serious injury. (000228)

Every 750 hours, an Independent Authorized Service Dealer should inspect the battery system. At this time, the battery condition and state of charge should be checked using a battery load tester. The batteries should be recharged or replaced as required.

Battery service is to be performed or supervised by personnel knowledgeable of batteries and the required precautions. Keep unauthorized personnel away from batteries.

Observe the following precautions when working on batteries:

- Turn the battery disconnect switch to OFF.
- Remove the five amp controller fuse from the control panel.
- Remove watches, rings, necklaces and other metal objects.
- Wear rubber gloves and boots.
- Do not lay tools or metal parts on top of the battery.
- Use tools with insulated handles.
- Disconnect charging source prior to connecting or disconnecting battery terminals.

- Discharge static electricity before touching battery by first touching a grounded metal surface.
- **DO NOT** jump start batteries.

Note: Spilled electrolyte should immediately be washed down with a bicarbonate of soda solution consisting of one pound (500 grams) bicarbonate of soda (baking soda) to one gallon (four liters) of water for the average battery. Add this solution to the spill until foaming has ceased. The resulting liquid can be flushed with water.

▲ WARNING

Explosion. Batteries emit explosive gases while charging. Keep fire and spark away. Wear protective gear when working with batteries. Failure to do so could result in death or serious injury. (000137a)

Battery Replacement

When required, the batteries must be replaced with ones of equivalent size, voltage, and CCA (cold crank amp capacity). See [Specifications](#) or contact an Independent Authorized Service Dealer for proper battery sizing.

Note: A new battery must be filled with the proper electrolyte and be fully charged before installing.

Preliminary Instructions

1. Turn battery disconnect switch to OFF.
2. Remove all cables from the batteries, starting with the negative (ground) cable first.
3. Dispose of batteries in accordance with local regulations.

▲ WARNING

Environmental hazard. Always recycle batteries at an official recycling center in accordance with all local laws and regulations. Failure to do so could result in environmental damage, death or serious injury. (000228)

Installing the New Batteries

Connect the cables to the battery posts as follows:

1. Connect the positive battery cable (red boot) from the battery disconnect switch to the positive (POS or +) battery post of the battery closest to the front of the unit (battery farthest from battery disconnect switch).

2. Connect both batteries with a jumper cable, attaching the black booted end of the cable to the negative (NEG or -) post of the first battery (farthest from disconnect switch), and the red booted end to the positive (POS or +) post of the second battery.

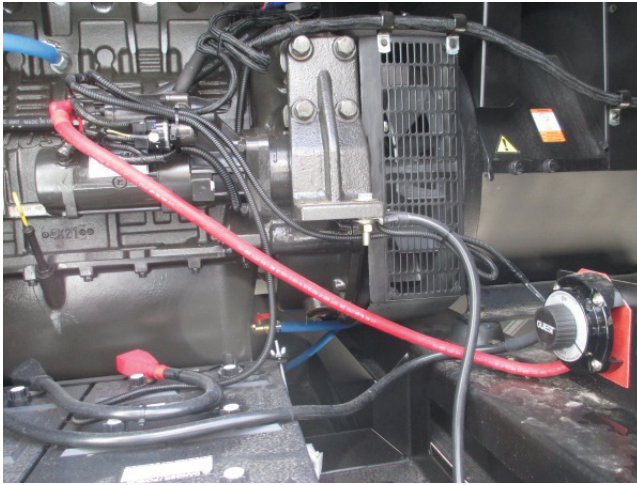

02035

Figure 17 - Battery Connections

3. Attach the black cable from the engine ground to the negative (NEG or -) post of the second battery.

⚠ CAUTION

Do not make battery connections in reverse. Doing so will result in equipment damage.
(000167)

Final Instructions

1. Install the five amp controller fuse in the control panel.
2. Turn the battery disconnect switch to ON.
3. See *Manually Starting the Unit*.

Other Maintenance Checks

The following inspections should be performed by a Independent Authorized Service Dealer, or a properly trained authorized operator. These maintenance items require a high level of experience and skill to evaluate and correct.

- Inspect engine accessory drive belts.
- Inspect hoses and connections.
- Inspect fuel supply system.
- Inspect exhaust system.
- Inspect exhaust pipe sleeve.

Note: All recommended service maintenance or repairs should be completed by an Independent Authorized Service Dealer to maintain the warranty status of a unit.

JACK MAINTENANCE

The following procedures should be performed annually.

Side-Wind Models

- The internal gearing and bushings of the jack must be kept lubricated. Apply a small amount of automotive grease to the internal gearing by removing the jack cover, or if equipped, use a needle nose applicator or standard grease gun on the lubrication point found on the side of the jack near the crank. Rotate the jack handle to distribute the grease evenly.
- A lightweight oil must be applied to the handle unit at both sides of the tube.
- If equipped, the axle bolt and nut assembly of the caster wheel must also be lubricated with the same lightweight oil.

Top-Wind Models

- Apply a lightweight oil to the screw stem.

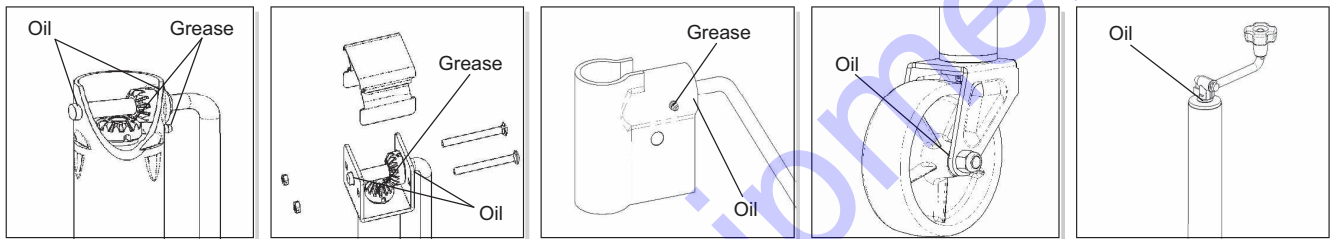

00243

Figure 18 - Lubrication Points

TRAILER WHEEL BEARINGS

The trailer axles are equipped with a grease fitting to allow lubrication of the wheel bearings without the need to disassemble the axle hub. To lubricate the axle bearings, remove the small rubber plug on the grease cap, attach a standard grease gun fitting to the grease fitting and pump grease into the fitting until new grease is visible around the nozzle of the grease gun. Use only a high quality grease made specifically for lubrication of wheel bearings. Wipe any excess grease from the hub with a clean cloth and replace the rubber plug when finished. The minimum recommended lubrication is every 12 months or 12,000 miles (19,312 km). More frequent lubrication may be required under extremely dusty or damp operating conditions.

Section 5 - Troubleshooting

Problems and Solutions

Some of the more common problems are listed in the table below. This information is intended to be a check or verification that simple causes can be located and fixed. It does not cover all types of problems. Procedures that require in-depth knowledge or skills (like flashing the field) should be referred to an authorized service department.

Table 5 - General Troubleshooting Guide

Problem	Possible Cause	Solution
Engine Cranks But Will Not Start	No fuel. Low oil level. Restricted air flow. No spark.	Check that fuel valves are open. Low Oil Pressure Shutdown activated. Replenish oil to full. Check/replace air filter. Check/replace spark plug(s).
Engine Will Not Crank (Electric Start)	Dead battery. Emergency stop is activated.	Remove batteries and trickle charge. Never jump start. Even if only one battery is bad, it is recommended that both batteries be replaced at the same time. Reset controller after an emergency stop.
Engine Starts But Will Not Run Smoothly	Fuel or ignition problem.	See OEM engine manual. Contact Generac Mobile Products Technical Support.
Engine Overheats	Excessive load. Debris or dirt buildup on engine/radiator.	Remove one or more electrical loads. Remove debris. Clean engine surfaces to allow cooling.
No Output Voltage	Circuit breaker tripped or failed. Internal failure of alternator. Idle switch on.	Reset circuit breaker or replace if required. Check electrical connections. Contact Generac Mobile Products Technical Support. Turn idle switch OFF.
High Output Voltage	Excessive speed.	Check engine for malfunction. Verify engine RPM. Check AVR adjustment.
Low Output Voltage	Wrong speed.	Check engine for malfunction. Verify engine RPM. Check AVR adjustment.
Electrical Shock When Frame Is Touched	Static charge. Grounded armature or field coil.	Ground unit frame at local reference ground. Contact service.
Mechanical Noise	Internal failure of alternator. Loose flexplate. Engine fan or belts issues.	Contact service. Tighten flexplate to flywheel and alternator shaft. Contact Generac Mobile Products Technical Support.

Table 6 - Digital Controller Troubleshooting Guide

Problem	Possible Cause	Solution
Controller Does Not Power Up Even With Correct DC Power Applied	Wiring mistake. Overload condition.	Check that there are no wiring errors/short circuits connected to the controller. Check breaker on the control panel. Check fuses on control panel.
LCD Display Cannot Be Viewed	Improper supply voltage. Improper contrast adjustment.	Check DC supply voltage at terminals B+ and B- (10-30VDC). Adjust LCD contrast for best display.
Controller Cannot Be "Reset"	Engine not stopped. Controller not in OFF mode.	Verify the engine is at a complete stop before trying to reset. Set the controller to OFF before trying to reset.
No "RUN" Output Signal	"Shutdown Faults" not reset. Engine speed not detected at cranking.	All shutdown faults must be reset (red shutdown LED must be OFF). Engine speed signal must be detected (speed signal green LED on) during cranking if the "run-output fail safe" feature is enabled. Verify correct magnetic pickup signal at cranking (2.0VAC min. during cranking).
Overspeed Shutdown Occurs At Normal Speed	Controller programmed values are wrong or controller has failed.	Verify the controller programmed values are correct for the number of flywheel teeth, nominal RPM, and overspeed set point percentage. Replace controller if failed.
Voltage Or Current Metering Is Incorrect	Controller programmed values are wrong. Ground is missing. Voltage sensing wiring mistake.	Verify the controller programmed values are correct for the voltage sensing PT ratio and/or current sensing CT ratio. Verify that the battery supply DC negative conductor is properly grounded to the engine block (i.e. to a common ground point). Verify the voltage sensing wiring connection to the controller matches power distribution type. NOTE: Standard direct voltage connection requires that the generator neutral is solidly grounded.
Engine Temperature Or Oil Pressure Display Is Incorrect	Failed engine sensor. Ground is missing.	Verify engine sensors. NOTE: Engine sensors must be factory supplied only. Verify that the battery supply DC negative conductor is properly grounded to the engine block (i.e. to a common ground point).
Engine Alarms Are On For High Engine Temperature Or Low Oil Pressure When Engine Is Operating Properly	Wrong temp or pressure calibration.	Verify the engine mounted senders have correct resistance values for corresponding input temperature or pressure. Verify calibration.
Keypad Buttons (Switches) Do Not Operate	Keypad not connected to controller.	Verify the interconnecting ribbon cable between the Lexan™ faceplate and main printed circuit board is correctly connected. Replace controller if failed.

Table 7 - Digital Controller Alarm Abbreviations

Abbreviation	Description
AI	Analog Input
AO	Analog Output
ATS	Automatic Transfer Switch (switches load to supplied bus (by mains or generators)
AVR	Automatic Voltage Regulator
BI	Binary Input
BO	Binary Output
BOC	Breaker Open Cool-down - protection type (see application manual for details)
BTB	Bus-Tie Breaker
CAN1	CAN bus for ComAp extension modules (e.g. IGS-PTM) and engine ECU connection
CAN2	CAN bus for communication between controllers and communication modules connection (e.g. I-LB+)
COX	Application for Complex Systems where actions are taken by a PLC and controller only follows orders => needs an external driver (cox)
CT	Current Transformer
ECU	Engine Electronic Control Unit
ESF	Engine Specific File
Forward Synchronisation	Synchronisation of unloaded genset to mains (GCB closing process)
FMI	Failure Mode Identifier
GC	Graphical Characters - option for additional support of one "graphical" language
GCB	Generator Circuit Breaker
CHP	Combined Heat Power - co-generation application, usually with gas engine
I-AOUT8	Extension module with 8 AO
I-CB	Communication Bridge - interfaces IS, IG/IS-NT, ID controllers and non-standard engine ECU
IG-AVRi	IG Automatic Voltage Regulator interface
IG-EE	InteliGen for Electronic Engines (HW optimized for connection to an engine equipped with ECU)
IG-EEC	InteliGen EE controller with extended communication possibilities + switchable sensing ranges of AC voltages and currents
IG-IB	IG-Internet Bridge - for internet/ethernet communication
IGL-RA15	Indication panel with LEDs signaling state of 15 BO
IG-NT	InteliGen New Technology genset controller
IG-NTC	InteliGen NT controller with extended communication possibilities + switchable sensing ranges of AC voltages and currents
IGS-NT-LSM+PMS	Dongle for IG-XX and IS-NT to enable Load Sharing and VAr sharing control loops and PMS
IGS-PTM	Extension module with 8 BI/BO, 4 AI and 1 AO
I-LB	Local Bridge – for direct and modem monitoring and control of multiple gensets

Table 7 - Digital Controller Alarm Abbreviations

Abbreviation	Description
IM-NT	InteliMains New Technology - Mains supervision controller; the same controller with a different SW configuration can work as a bus-tie synchronizer
I-RB	Relay Board
IS-AIN8	Extension module with 8 AI
IS-BIN8/16	Extension module with 8 BO and 16 BI
IS-NT	InteliSys New technology genset controller
IS-NT-BB	InteliSys New Technology Basic Box (without display)
KWP2000	Key Word Protocol of Scania S6 unit (for engine diagnostics)
LAI	Logical Analog Inputs (card in GenConfig which is used to assign source signal to controller Logical Analog Input functions, e.g. Oil press)
LBI	Logical Binary Inputs (card in GenConfig which is used to assign source signal to controller Logical Binary Input functions, e.g. Sys Start/Stop)
LS	Load Sharing - analog load sharing line to interconnect gensets on site (for island parallel or mains parallel operation of multiple gen-sets); IG/IS/IM-NT controllers use digital Load Sharing via the CAN2 bus
LSM	Load Sharing Module
LT	Option for Low Temperature modification (display equipped with heating foil)
MCB	Main Circuit Breaker
MGCB	Master Generator Circuit Breaker (sometimes used with multiple gensets in island parallel or mains parallel operation)
MINT	Multiple application with INTernal control loops - for multiple gensets in island parallel or mains parallel operation; Load Sharing and VAr Sharing controlled internally; PMS available
MP	Mains Protection
MultIsIOp	Multiple Island Operation (MCB is opened, GCB's are closed)
MultParOp	Multiple Parallel Operation (MCB is closed, GCB's are closed)
NPU	Mains protection relay (voltage, frequency, vector shift protections)
OC	Occurrence Count (number of fault occurrences transmitted in diagnostic frame from ECU)
OfL	Off load - protection type (see application manual for details)
PF	Power Factor
PGN	Parameter Group Number (see SAE J1939-71)
PMS	Power Management System - ensures optimization of running gensets on sites with multiple gen-sets; based on kW/kVA spinning reserve or on relative (%) load; no-master system ensures high reliability
Reverse synchronisation	Synchronisation of loaded genset to mains (MCB closing process)
RTC	Real Time Clock
SG	Speed Governor
SHAIN	SHared (virtual) Analog INput module

Table 7 - Digital Controller Alarm Abbreviations

Abbreviation	Description
SHAOUT	SHared (virtual) Analog OUTput module
SHBIN	SHared (virtual) Binary INput module
SHBOUT	SHared (virtual) Binary OUTput module
Soft load	Generator soft loading according to Load ramp loop setting
Soft unload	Generator soft unloading according to Load ramp loop setting
SPI	Single Parallel Island application - for single gensets in parallel with mains or in island operation; suitable for CHP applications; no MCB control
SPM	Single Prime Mover application - for single gensets without mains
SPN	Suspect Parameter Number (see SAE J1939-71)
SPtM	Single Parallel to Mains application - for single gensets in parallel with mains or in island operation, with AMF support; both MCB and GCB controlled
SSB	Single Stand-By application - for single gensets with mains and break transfer to mains
VPIO	Virtual periphery I/O module – internal “SW wires” linking binary outputs to inputs controllers via inter-controller CAN2
VS	VAr Sharing - ensures VAr sharing between gensets on site via the CAN2 bus (for island parallel or mains parallel operation of multiple gen-sets)
VT	Voltage Transformer
#	Setting of setpoints (with this character in front of them) is shared between controllers controllers via inter-controller CAN2

Table 8 - Digital Controller List of Alarms

NT Alarm/History Record	Description
ECU	Indication of error in communication with ECU. Check if the ECU is: - correctly connected to the CAN1 port of the controller (see ComAp Electronic Engines Support manual for information about ECU connection) - powered up - terminating resistors are properly connected - the CAN bus Low and High wires are not swapped
SHAIInCfgErr	Shared Analog module configuration error – i.e. more than one source module (SHAOUT) were configured (on the CAN2 bus). Make sure that only one SHAOUT x module is configured in controllers.
ECUDiagBlocked	Alarm is active when Comms settings: ECU diag = DISABLED . This setting means that ECU alarms are not displayed and considered by controller and this alarm is the setting notification.
Wrong config	Wrong controller configuration indication. Indicates that controller hardware doesn't support PLC used in configuration. To check it send the IDch and Dngl strings3 from controller Info screen 2 and archive to your technical support.

Table 8 - Digital Controller List of Alarms

NT Alarm/History Record	Description
RTCbatteryFlat	This warning message "RTCbatteryFlat" appears in Alarmlist when battery is close to be completely flat. If power supply cut comes when the RTC battery is flat, the statistic values, history and setpoints settings are lost. Send a controller to your distributor for battery exchange if the RTCbatteryFlat message is displayed.
Al/Hist. msg 1-165	Al/Hist. msg 1-16 activity indication (Al/Hist. msg means Alarm/History message). Al/Hist. msg can be used as a customized message for additional protection configured to any controller internal value. See GenConfig manual - Protections.
Batt volt	Indication of battery voltage protection activity. This protection is based on Analog protect : <i>Batt >V</i> , <i>Batt <V</i> , and <i>Batt volt del</i> setpoints. Check if engine alternator or independent battery charger works properly.
EarthFaultCurr	Indication of Earth fault current protection activity. This protection is based on Gener protect : <i>EarthFaultCurr</i> and <i>EthFltCurr del</i> setpoints. Setpoint <i>EarthFltCurrCT</i> from Basic settings group of setpoints is related to this protection too.
Gen V unbal	Generator voltage unbalance alarm is based on Gener protect : <i>Gen V unbal</i> and <i>Gen V unb del</i> setpoints. The voltage unbalance is calculated as a maximum difference between phase voltages.
Gen I unbal	Generator voltage unbalance alarm is based on Gener protect : <i>Gen V unbal</i> and <i>Gen V unb del</i> setpoints. The voltage unbalance is calculated as a maximum difference between phase voltages.
BusL I unbal	Left bus current asymmetry (unbalance) alarm is based on Gener protect : <i>BusL I unbal</i> and <i>BusL I unb del</i> setpoints. The current unbalance is calculated as a maximum difference between phase currents.
Mains V unbal	Mains voltage unbalance alarm is based on Mains protect : <i>Mains V unbal</i> and <i>MainsV unb del</i> setpoints. The voltage unbalance is calculated as a maximum difference between phase voltages.
Mains I unbal	Mains current asymmetry (unbalance) alarm is based on Mains protect : <i>Mains I unbal</i> and <i>Mains I unb del</i> setpoints. The current unbalance is calculated as a maximum difference between phase currents.
Bus V unbal	Bus voltage unbalance alarm is based on Gener protect (Bus protect) : <i>Bus V unbal</i> and <i>Bus V unb del</i> setpoints. The voltage unbalance is calculated as a maximum difference between phase voltages.
BusL V unbal	Left bus voltage unbalance alarm is based on BusL protect : <i>BusL V unbal</i> and <i>BusL V unb del</i> setpoints. The voltage unbalance is calculated as a maximum difference between phase voltages.
BusR V unbal	Right bus voltage unbalance alarm is based on BusR protect : <i>BusR V unbal</i> and <i>BusR V unb del</i> setpoints. The voltage unbalance is calculated as a maximum difference between phase voltages.
Dongle incom	Incompatible (usually missing) dongle indication. IGS-NT-LSM+PMS dongle (green one) is required if load sharing and power management functions are used in MINT, COX or COMBI application. Check a Reference Guide for information whether a dongle is required for requested functionality or not.
Emergency stop	Emergency stop activity indication. Check binary input with <i>Emergency stop</i> function.

Table 8 - Digital Controller List of Alarms

NT Alarm/History Record	Description
CAN2 bus empty	This alarm is active if controller doesn't "see" any other controllers on the CAN2 bus. Alarm activation can be enabled/disabled using setpoint Comm settings: CAN2empt-Detect . This setpoint should be set to DISABLED for single genset applications. Check Reg16/Reg32 strings to see which controllers are in the same group18.
ChrgAlternFail	Charger fail detection. This alarm means that voltage on the D+ terminal is lower than 80% of controller power supply voltage and it means that battery is no longer charged. Check function of engine alternator or independent battery charger.
Sd Stop fail	Engine stop fail indication. Stop fail means that engine does not reach "still engine" state within Engine params: Stop time . "Still engine" conditions: <ul style="list-style-type: none"> - Engine speed (RPM) = 0 and - AI: Oil press < <i>Starting POil</i> and - D+ terminal is not active and - BI: RunIndication 1 and 2 and 3 are not active and - Generator voltage < 15V (in all phases) and - Generator frequency = 0 Hz - if all these conditions are fulfilled, additional two second delay is used to confirm "still engine" state.
Overspeed	Genset over speed alarm is based on Engine protect: Overspeed setpoint setting.
Underspeed	Genset under speed alarm indication. Under speed limit is given by Engine params: Starting RPM , if the engine has already started (see Starting procedure description in Reference Guide).
Pickup fail	Pickup fail indication. Pickup fail means loss of RPM signal in running state ("engine running" state is active). "Engine running" conditions: <ul style="list-style-type: none"> - Engine speed > Engine params: Starting RPM or - AI: Oil press > <i>Starting POil</i> or - D+ terminal active (this condition is used only if Engine params: D+ function = ENABLED) or - BI: RunIndication 1 or 2 or 3 is active or - Generator voltage > 15V (in any phase) See <i>Speed pick-up input</i> section in the Technical data chapter in IGS-NT-x.y.-Installation Guide manual for information about requested pick-up signal parameters.
Sd BatteryFlat	Alarm is activated if controller "wakes up" after a start attempt which caused battery voltage drop (voltage drop below 6V) and consequently controller switch-off. ComAp I-LBA module may help to solve this problem, for information about this module, see IGS-NT-x.y.-Installation Guide manual.
WrnServiceTime	This alarm is activated when at least one of controller count down service timers Engine protect: Service time X has reached zero. It is necessary to set again a non-zero value to a corresponding setpoint to reset this alarm.
Not lubricated	This Alarm list message is active until the first lubrication cycle has been finished. See <i>Engine states</i> chapter in IGS-NT-x.y.-Reference Guide.
Start fail	This alarm is issued if genset start-up fails. It means that several crank attempts has been done (number of attempts is given by Engine params: Crank attempts) and engine did not start. For more information, see <i>Engine starting procedures</i> chapter in IGS-NT-x.y.-Reference Guide.

Table 8 - Digital Controller List of Alarms

NT Alarm/History Record	Description
Start blocking	This message means that a binary input with Startblocking function is active and engine start is blocked. If active, NotReady state is shown on the controller screen and the message appears in the Alarm list. As soon as input is deactivated, engine start is enabled again.
Wrn CylTemp1-32	Warning protection on AI Cylinder temperature 1-32 is active. Check corresponding setpoints in the Engine protect group.
Wrn MCB fail	MCB failure was detected. See <i>Circuit breakers operation sequence, GCB/MCB fail detection</i> chapter in IGS-NT-x.y-Reference Guide.
Stp GCB fail	GCB failure was detected. See <i>Circuit breakers operation sequence, GCB/MCB fail detection</i> chapter in IGS-NT-x.y-Reference Guide.
Wrn BTB fail	BTB failure was detected. See <i>Circuit breakers operation sequence, GCB/MCB fail detection</i> chapter in IGS-NT-x.y-Reference Guide. It applies to BTB breaker too.
Wrn MGCB fail	MGCB failure was detected. See <i>Circuit breakers operation sequence, GCB/MCB fail detection</i> chapter in IGS-NT-x.y-Reference Guide. It applies to MGCB breaker too.
Sd Oil press B	Engine shut-down was activated by binary input with "Oil press" function (see LBI card in GenConfig for information about source signal for this function).
Wrn RSync fail	Reverse synchronization failure indication, genset or group of gensets was not synchronized to mains within Sync/Load ctrl : <i>Sync timeout</i> time. Check setting of setpoints in the Sync/Load ctrl and Volt/PF ctrl groups. Frequency regulation loop, Angle regulation loop and Voltage regulation loop are active during synchronisation and you may need to adjust their setting. Actual state of synchronization is visible on the controller measurement screen with synchroscope where speed and voltage regulator's outputs, slip frequency and generator and mains voltages can be observed during the synchronization process.
Stp Sync fail	Synchronization failure indication (alarm Sync timeout is active), genset or group of gensets was not synchronized to mains/bus within Sync/Load ctrl : <i>Sync timeout</i> time. Check setting of setpoints in the Sync/Load ctrl and Volt/PF ctrl groups. Frequency regulation loop, Angle regulation loop and Voltage regulation loop are active during synchronisation and you may need to adjust their setting. Actual state of synchronization is visible on the controller measurement screen with synchroscope where speed and voltage regulators' outputs, slip frequency and generator and mains/bus voltages can be observed during the synchronization process.
Wrn Sync fail	Synchronization failure indication (alarm Sync timeout is active), genset or group of gensets was not synchronized to mains/bus within Sync/Load ctrl : <i>Sync timeout</i> time. Check setting of setpoints in the Sync/Load ctrl and Volt/PF ctrl groups. Frequency regulation loop, Angle regulation loop and Voltage regulation loop are active during synchronisation and you may need to adjust their setting. Actual state of synchronization is visible on the controller measurement screen with synchroscope where speed and voltage regulators' outputs, slip frequency and generator and mains/bus voltages can be observed during the synchronization process.
BOC L1, L2 or L3 under	Generator L1, L2 or L3 voltage was under the <i>Gen <V BOC</i> limit for <i>Gen V del</i> time. Undervoltage protections are based on Gener protect : <i>Gen <V BOC</i> and <i>Gen V del</i> setpoints. This alarm is issued if voltage protections are based on phase to neutral voltages. It means that Basic settings : <i>FixVoltProtSel</i> is set to PHASE-NEUTRAL.

Table 8 - Digital Controller List of Alarms

NT Alarm/History Record	Description
BOC L1, L2 or L3 over	Generator L1, L2 or L3 voltage was over the <i>Gen >V BOC</i> limit for <i>Gen V del</i> time. Overvoltage protections are based on Gener protect: Gen >V BOC and <i>Gen V del</i> setpoints. This alarm is issued if voltage protections are based on phase to neutral voltages. It means that Basic settings: FixVoltProtSel is set to PHASE-NEUTRAL.
Sd L1, L2 or L3 over	Generator L1, L2 or L3 voltage was over the <i>Gen >V SD</i> limit for <i>Gen V del</i> time. Overvoltage protections are based on Gener protect: Gen >V SD and <i>Gen V del</i> setpoints. This alarm is issued if voltage protections are based on phase to neutral voltages. It means that Basic settings: FixVoltProtSel is set to PHASE-NEUTRAL.
BOC L12, L23 or L31 under	Generator L12, L23 or L31 voltage was under the <i>Gen <V BOC</i> limit for <i>Gen V del</i> time. Undervoltage protections are based on Gener protect: Gen <V BOC and <i>Gen V del</i> setpoints. This alarm is issued if voltage protections are based on phase to phase voltages. It means that Basic settings: FixVoltProtSel is set to PHASE-PHASE.
BOC L12, L23 or L31 over	Generator L12, L23 or L31 voltage was over the <i>Gen >V BOC</i> limit for <i>Gen V del</i> time. Overvoltage protections are based on Gener protect: Gen >V BOC and <i>Gen V del</i> setpoints. This alarm is issued if voltage protections are based on phase to phase voltages. It means that Basic settings: FixVoltProtSel is set to PHASE-PHASE.
Sd L12, L23 or L31 over	Generator L12, L23 or L31 voltage was over the <i>Gen >V SD</i> limit for <i>Gen V del</i> time. Overvoltage protections are based on Gener protect: Gen >V SD and <i>Gen V del</i> setpoints. This alarm is issued if voltage protections are based on phase to phase voltages. It means that Basic settings: FixVoltProtSel is set to PHASE-PHASE.
BOC fgen under	Generator frequency was under the <i>Gen <f</i> limit for <i>Gen f del</i> time. Under frequency protection is based on Gener protect: Gen <f and <i>Gen f del</i> setpoints.
BOC fgen over	Generator frequency was over the <i>Gen >f</i> limit for <i>Gen f del</i> time. Over frequency protection is based on Gener protect: Gen <f and <i>Gen f del</i> setpoints.
BOC ReversePwr	This alarm is issued by the reverse power protection. This protection is based on Gener protect: Reverse power and <i>ReversePwr del</i> setpoints. This alarm means that either engine speed/power control does not work properly or generator current transformers (CT's) are connected in a wrong way.
MP L1, L2 or L3 under	Mains L1, L2 or L3 voltage was under the <i>Mains <V MP</i> limit for <i>Mains V del</i> time. Undervoltage protections are based on Mains protect: Mains <V MP and <i>Mains V del</i> setpoints. This alarm is issued if voltage protections are based on phase to neutral voltages. It means that Basic settings: FixVoltProtSel is set to PHASE-NEUTRAL.
MP L1, L2 or L3 over	Mains L1, L2 or L3 voltage was over the <i>Mains >V MP</i> limit for <i>Mains V del</i> time. Overvoltage protections are based on Mains protect: Mains >V MP and <i>Mains V del</i> setpoints. This alarm is issued if voltage protections are based on phase to neutral voltages. It means that Basic settings: FixVoltProtSel is set to PHASE-NEUTRAL.
MP L12, L23 or L31 under	Mains L12, L23 or L31 voltage was under the <i>Mains <V MP</i> limit for <i>Mains V del</i> time. Undervoltage protections are based on Mains protect: Mains <V MP and <i>Mains V del</i> setpoints. This alarm is issued if voltage protections are based on phase to phase voltages. It means that Basic settings: FixVoltProtSel is set to PHASE-PHASE.
MP L12, L23 or L31 over	Mains L12, L23 or L31 voltage was over the <i>Mains >V MP</i> limit for <i>Mains V del</i> time. Overvoltage protections are based on Mains protect: Mains >V MP and <i>Mains V del</i> setpoints. This alarm is issued if voltage protections are based on phase to phase voltages. It means that Basic settings: FixVoltProtSel is set to PHASE-PHASE.

Table 8 - Digital Controller List of Alarms

NT Alarm/History Record	Description
Mains Avg x >V	If the value of 10 min. average mains voltage of any phase (<i>Mains Avg V1, Mains Avg V2, Mains Avg V3</i>) exceed value given by setpoint <i>Mains Avg >V MP</i> (<i>Mains protect</i> group), the MCB is opened and message <i>Mains Avg x >V</i> appears in alarm list and history record. <i>BO Common MP</i> is activated (<i>x</i> indicates number of phase).
MP fmns under	Mains frequency was under the <i>Mains <f</i> limit for <i>Mains f del</i> time. Under frequency protection is based on Mains protect : <i>Mains <f</i> and <i>Mains f del</i> setpoints.
MP fmns over	Mains frequency was over the <i>Mains >f</i> limit for <i>Mains f del</i> time. Over frequency protection is based on Mains protect : <i>Mains >f</i> and <i>Mains f del</i> setpoints.
Bus meas error	Bus measurement error is issued if bus voltage is out of limits. For details, see description of the Gener protect : <i>BusMeasError</i> setpoint in IGS-NT-x.y-Reference Guide.
OfL StartBlick	This alarm indicates wrong setpoints setting that disables engine start or load takeover. Incorrect combination of ProcessControl : <i>Island enable; ParallelEnable; Synchro enable; MF start enable</i> setpoints setting is the reason why this alarm is issued. See <i>AUT mode</i> section of the <i>OFF-MAN-AUT mode</i> chapter in IGS-NT-x.y-Reference Guide for SPTM, SPI or COMBI application.
StartBlick	This alarm indicates wrong setpoints setting that disables start of gensets. Incorrect combination of ProcessControl : <i>Island enable; ParallelEnable; Synchro enable; MF start enable</i> setpoints setting is the reason why this alarm is issued. See <i>OFF-MAN-AUT mode</i> chapter in IM-NT-MCB-MGCB Reference Guide.
BOC IDMT	Indicates current IDMT protection activation. Current IDMT protection is inverse definite minimum time protection which is based on the generator current. Protection reaction time depends on overcurrent value. High overcurrent means short reaction time whereas low overcurrent means longer reaction time. Protection is based on setpoints Generator protect : <i>2Inom del</i> and Basic settings : <i>Nomin current</i> .
MPR Imains IDMT	Indicates current IDMT protection activation. Current IDMT protection is inverse definite minimum time protection which is based on the mains current. Protection reaction time depends on overcurrent value. High overcurrent means short reaction time whereas low overcurrent means longer reaction time. This protection is active if the <i>Mns2Inom prot</i> setpoint is set to ENABLED. Protection is based on setpoints Mains protect : <i>Mains2Inom del</i> and Basic settings : <i>Nomin current</i> .
BOR IbusL IDMT	Indicates current IDMT protection activation. Current IDMT protection is inverse definite minimum time protection which is based on the left bus current. Protection reaction time depends on overcurrent value. High overcurrent means short reaction time whereas low overcurrent means longer reaction time. This protection is active if the <i>BusL2Inom prot</i> setpoint is set to ENABLED. Protection is based on setpoints BusL protect : <i>BusL2Inom del</i> and Basic settings : <i>Nomin current</i> .
BOC ShortCurr	Generator short current protection was activated. Generator current was over Generator protect : <i>Ishort</i> level for <i>Ishort del.</i> time.
BOC Overload	Indicates overload IDMT protection activation. Overload IDMT protection is inverse definite minimum time protection which is based on the generator power. Protection reaction time depends on generator power value. High generator overload means short reaction time whereas low generator overload means longer reaction time. Protection is based on setpoints Generator protect : <i>OverldStrtEval</i> and <i>2POverldStEvDel</i> .

Table 8 - Digital Controller List of Alarms

NT Alarm/History Record	Description
MPR Pmains IDMT	Indicates overload IDMT protection activation. Overload IDMT protection is inverse definite minimum time protection which is based on the mains power. Protection reaction time depends on mains power value. High mains overload means short reaction time whereas low mains overload means longer reaction time. This protection is active if the <i>Mns2POvrdProt</i> setpoint is set to ENABLED. Protection is based on setpoints Mains protect : <i>OverldStrtEval</i> and <i>2POvrdStEvDel</i> .
BOR PbusL IDMT	Indicates overload IDMT protection activation. Overload IDMT protection is inverse definite minimum time protection which is based on the left bus power. Protection reaction time depends on the left bus power value. High left bus overload means short reaction time whereas low left bus overload means longer reaction time. This protection is active if the <i>BusL2POvrdProt</i> setpoint is set to ENABLED. Protection is based on setpoints BusL protect : <i>OverldStrtEval</i> and <i>2POvrdStEvDel</i> .
BOC NCB fail	NCB fail is detected if the <i>NeutralCB fdb</i> input doesn't follow <i>Neutral CB C/O</i> output within 400 ms.
Wrn BadPwrCfg	Power format is set differently in controllers which are part of the same control group. Check Power formats setting in GenConfig on the Miscellaneous card (available in the Advanced mode only).
WrnTstOnLdFail	This alarm is issued if the Test on load function is activated (by closing corresponding BI) and genset is not able to take over mains load completely (mains import = 0) within the Sync/Load ctrl : <i>Load ramp</i> time. Message "WrnTstOnLdFail" is recorded into controller history in case of this failure. It is either necessary to extend the <i>Load ramp</i> time or check engine speed regulation.
Wrn SpdRegLim	This alarm indicates that controller Speed governor output has reached its limit. Warning is issued if Speed governor output stays close to one of the limit values for more than two seconds. Close to one of the limits means that Speed governor output value is within <i>SpeedGovLowLim+0,2V</i> range or <i>SpeedGovHiLim-0,2V</i> range. This alarm gives you information that engine speed governor is either connected in a wrong way or one of the speed control related regulation loops6 is set in a wrong way. Warning is blocked if binary output functions SPEED up and SPEED down are configured. Refer also to <i>Sync/load control</i> .
Wrn VoltRegLim	This alarm indicates that controller AVRi output has reached its limit. Warning is issued if the AVRi output stays close to 0% or 100% limit for more than two seconds. Close to limit means that AVRi output value is either <2% or >98%. This alarm gives you information that generator voltage regulator is either connected in a wrong way or one of the voltage control related regulation loops is set in wrong way. Warning is blocked if binary output functions AVR up or AVR down are configured. Refer also to <i>Volt/PF control adjustment</i> chapter in an IGS-NT-x.y-Reference Guide.
G L neg8	Generator phase is inverted. Check generator phases connection, one of generator phases is connected the other way round (swap generator coil leads connection).
G ph+L neg8	Wrong generator phases sequence, additionally one phase is inverted.
G ph opposed8	Wrong generator phases sequence.
M L neg9	Mains phase is inverted. Check mains transformer phases connection, one of transformer phases is connected the other way round (swap transformer coil leads connection).
M ph+L neg9	Wrong mains phases sequence, additionally one phase is inverted.

Table 8 - Digital Controller List of Alarms

NT Alarm/History Record	Description
M ph opposed9	Wrong mains phases sequence.
B L neg13	Bus phase is inverted.
B ph+L neg13	Wrong bus phases sequence, additionally one phase is inverted.
B ph opposed13	Wrong bus phases sequence.
BL L neg12	Left bus phase is inverted.
BL ph+L neg12	Wrong left bus phases sequence, additionally one phase is inverted.
BL ph opposed	Wrong left bus phases sequence.
BR L neg	Right bus phase is inverted.
BR ph+L neg	Wrong right bus phases sequence, additionally one phase is inverted.
BR ph opposed	Wrong right bus phases sequence.
ActCallCH1Fail, CH2Fail, CH3-Fail	Indication of unsuccessful active call 1-3. See Inteli Communication Guide for information about active calls. See the IGS-NT-x.y-Reference Guide for description of setpoints which are part of the Act.calls/SMS group and are used for active call setup.
PassInsertBck	The break through password function can be ENABLED/DISABLED from the password management window in InteliMonitor (initial status is DISABLED). Warning " <i>PassInsertBck</i> " appears in the alarm list when the controller is blocked. The operator is not allowed to insert the password if the controller is blocked. The screen will display information that the controller is blocked and the time remaining until the end of the block. The controller is locked for five minutes when the password is wrongly entered six times (in case of next six wrong attempts [correct password was not inserted at all] for 30, 60, 120, 240 minutes). An <i>Incorrect password</i> message will appear in the history of the controller stating when the invalid password was used.

Section 6 - Wiring Diagrams

AC WIRING - MGG155 (120V GCB)

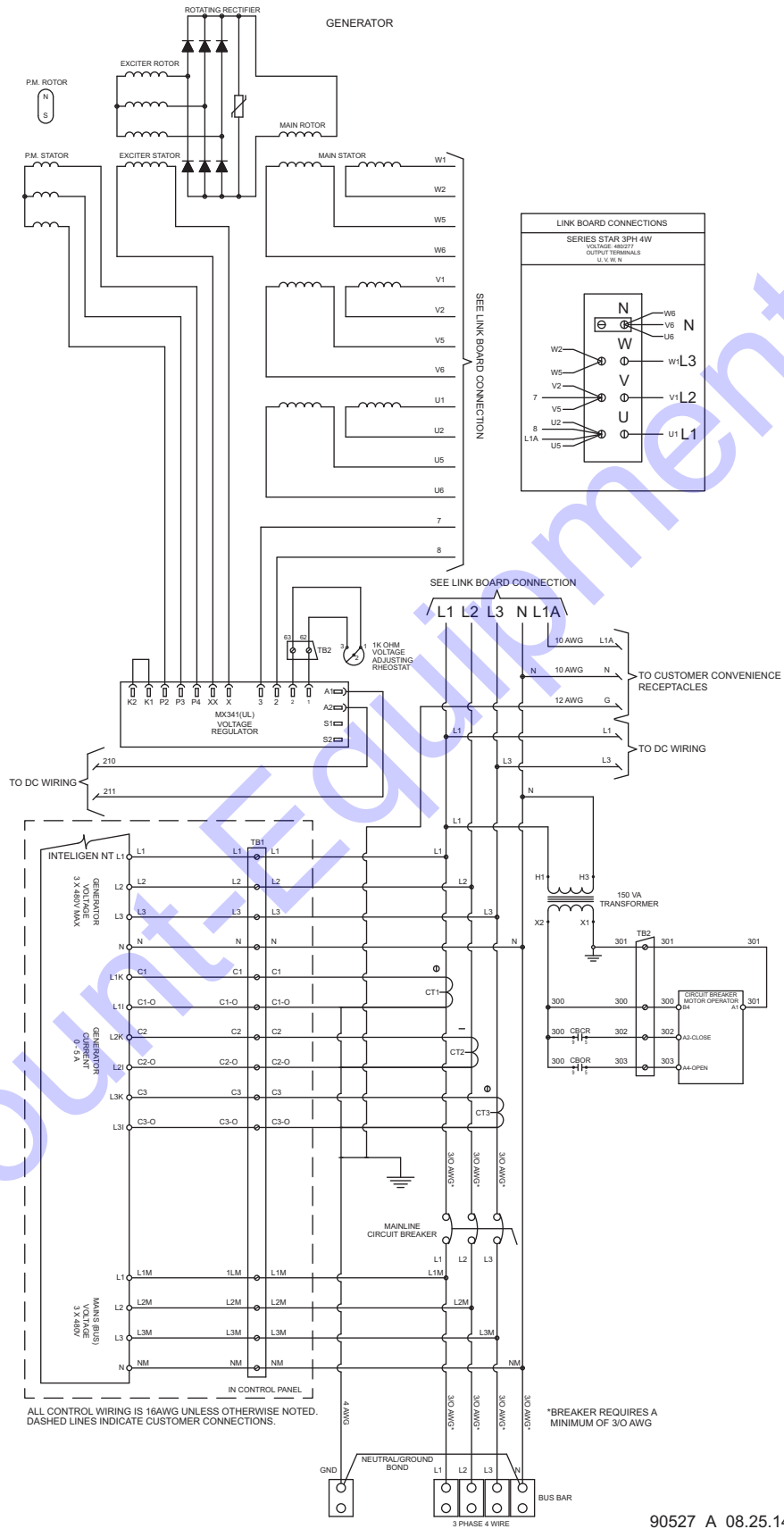

90527_A_08.25.14

AC WIRING - MGG210 (120V GCB)

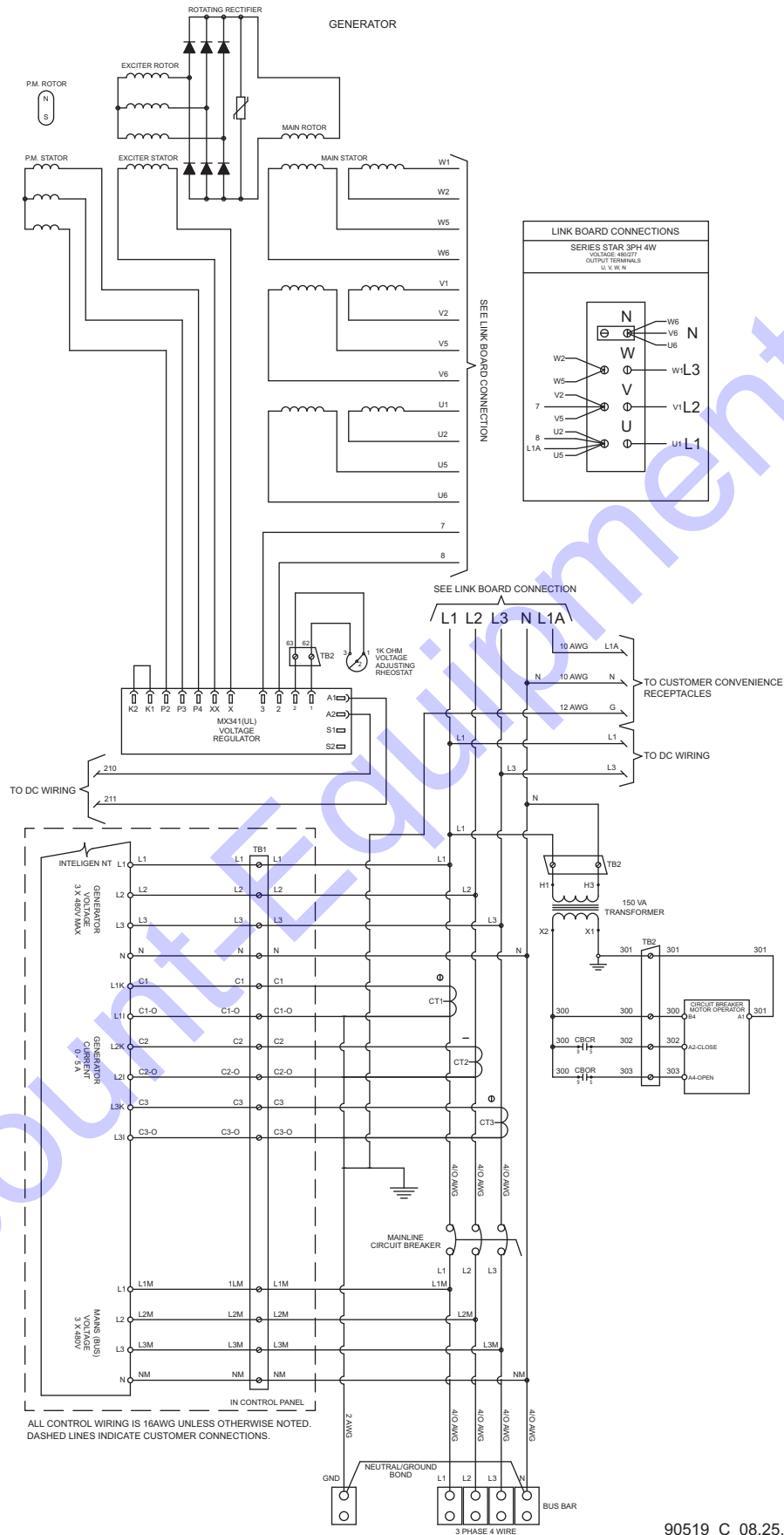

90519_C_08.25.14

AC WIRING - MGG155 (24V GCB)

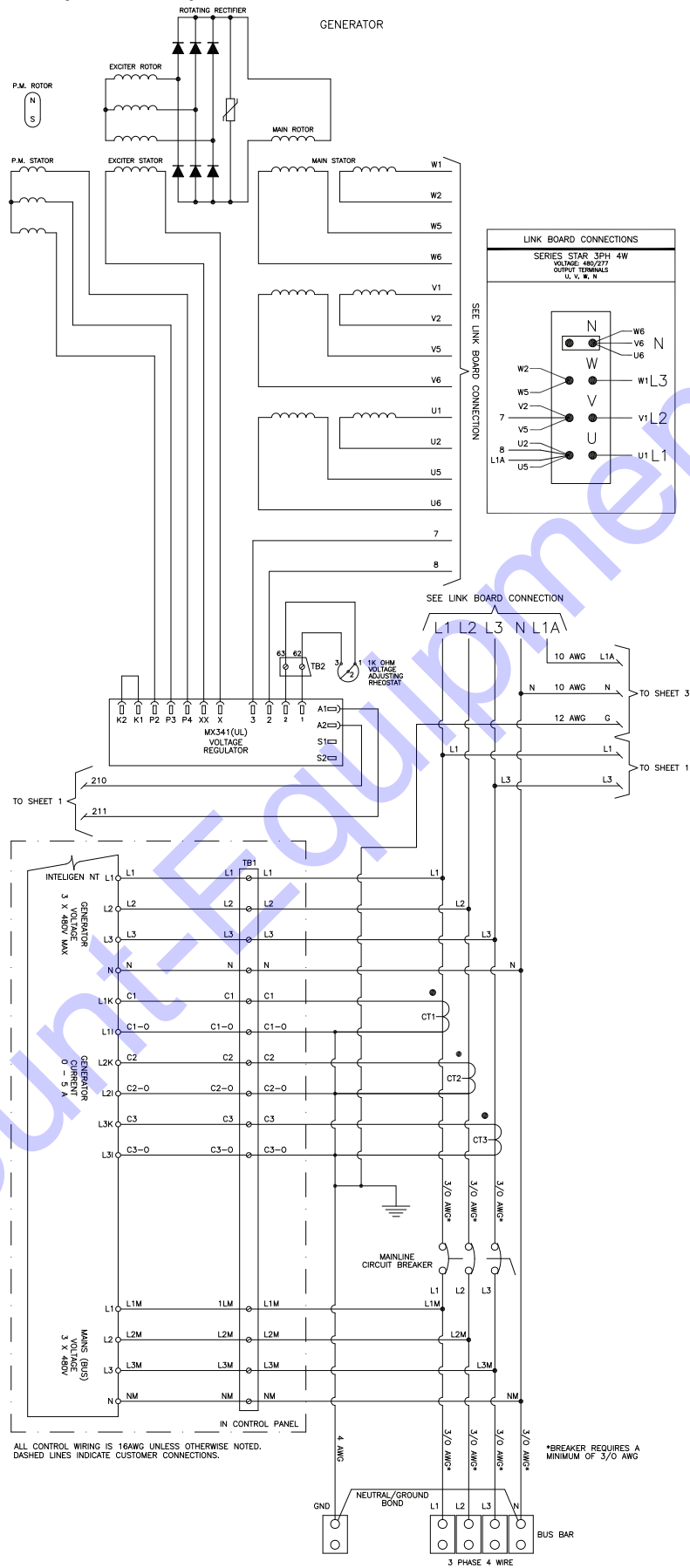

AC WIRING - MGG210 (24V GCB)

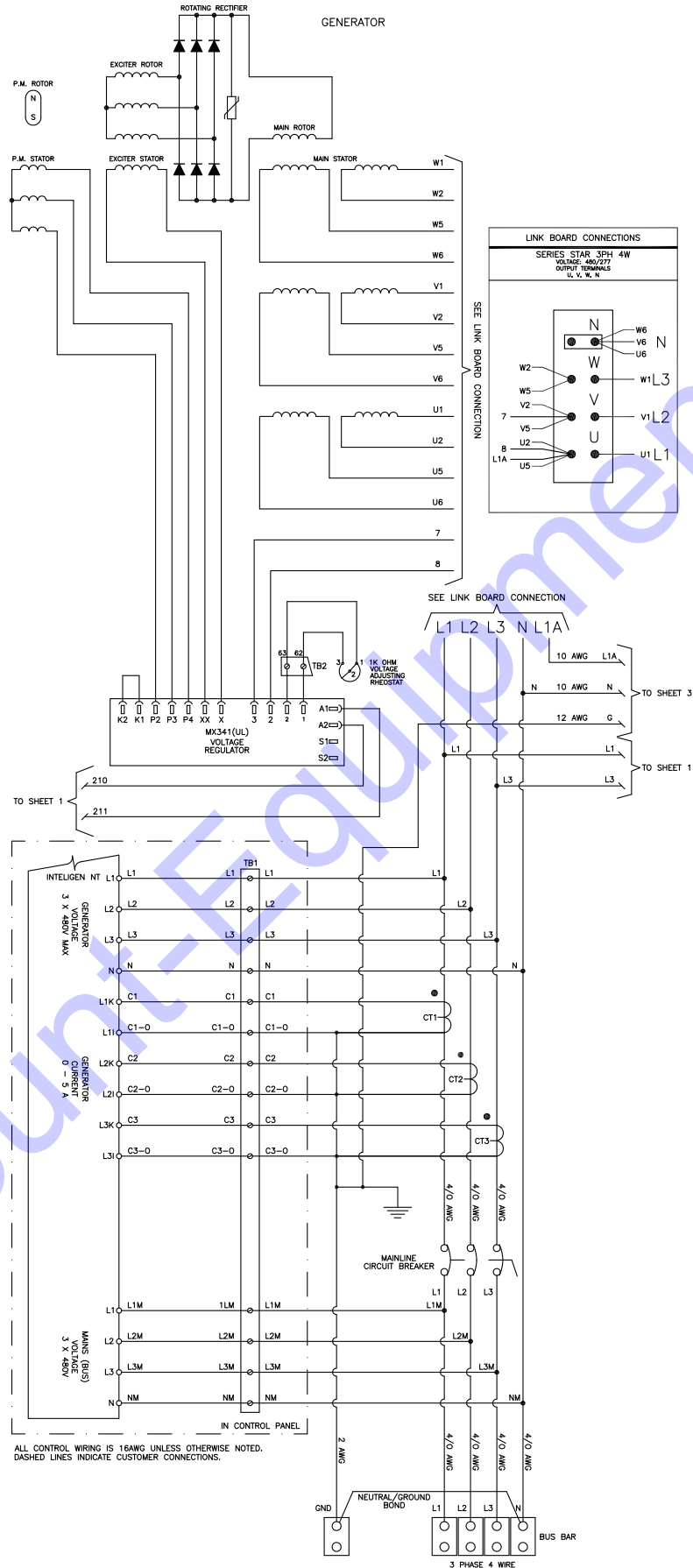

DC WIRING - MGG155 (120V GCB)

CONTROL BOX WIRING

ENGINE/OPTIONAL ACCESSORY WIRING

Legend

CPIC - CONTROL PANEL INTERFACE CONNECTOR 21 PIN
EIC - ENGINE INTERFACE CONNECTOR
SM - STARTER MOTOR
PL - PANEL LIGHT SWITCH
L1 - PANEL LIGHT 1
L2 - PANEL LIGHT 2
FSS - FUEL SELECT SWITCH
FS - FUEL SELECT SWITCH
OPEN=NG, CONNECTED=LP
24V LOCKOFF POWER
NG LOCK - LOCKOFF (NATURAL GAS)
LP LOCK - LOCKOFF (PROPANE)
SR - STARTER RELAY
FR - FUEL SOLENOID RELAY
STR - SHUNT TRIP RELAY
CBOR - CIRCUIT BREAKER CLOSED RELAY
CBOR - CIRCUIT BREAKER OPEN RELAY
FPS - FUEL PRESSURE SWITCH
LCLS - LOW COOLANT LEVEL SWITCH
ST - SHUNT TRIP

ALL WIRE IS 16 AWG UNLESS NOTED.
DASHED LINES INDICATE CUSTOMER CONNECTIONS.

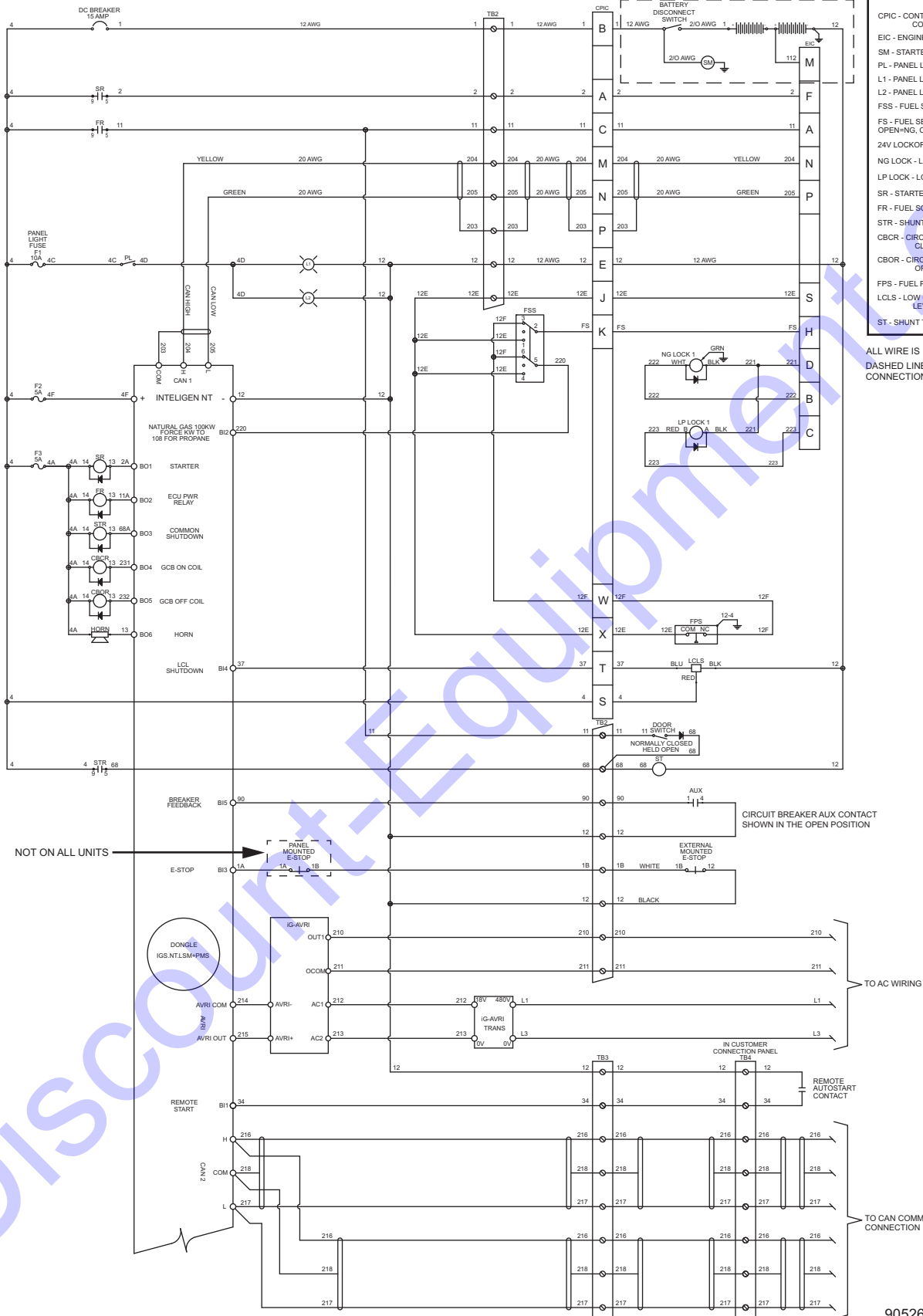

NOT ON ALL UNITS

90526_ORG_06.17.14

DC WIRING - MGG210 (120V GCB)

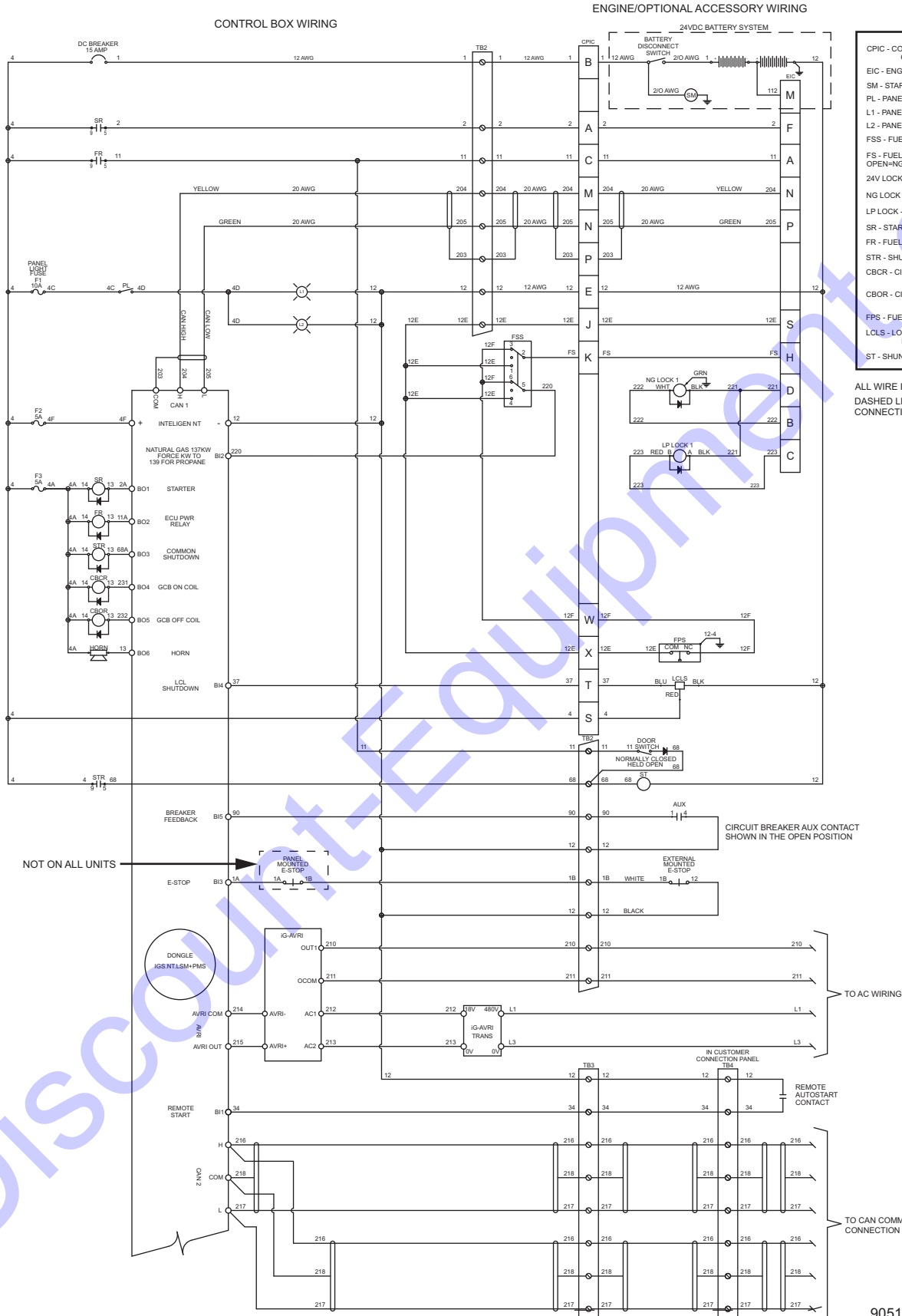

Legend

- CPIC - CONTROL PANEL INTERFACE CONNECTOR 21 PIN
- EIC - ENGINE INTERFACE CONNECTOR
- SM - STARTER MOTOR
- PL - PANEL LIGHT SWITCH
- L1 - PANEL LIGHT 1
- L2 - PANEL LIGHT 2
- FSS - FUEL SELECT SWITCH
- FS - FUEL SELECT OPEN-NG, CONNECTED-LP 24V LOCKOFF POWER
- NG LOCK - LOCKOFF (NATURAL GAS)
- LP LOCK - LOCKOFF (PROPANE)
- SR - STARTER RELAY
- FR - FUEL SOLENOID RELAY
- STR - SHUNT TRIP RELAY
- CBOR - CIRCUIT BREAKER CLOSED RELAY
- CBOR - CIRCUIT BREAKER OPEN RELAY
- FPS - FUEL PRESSURE SWITCH
- LCLS - LOW COOLANT LEVEL SWITCH
- ST - SHUNT TRIP

ALL WIRE IS 16 AWG UNLESS NOTED. DASHED LINES INDICATE CUSTOMER CONNECTIONS.

NOT ON ALL UNITS

90516_ORG_05.09.14

DC WIRING - MGG155 (24V GCB)

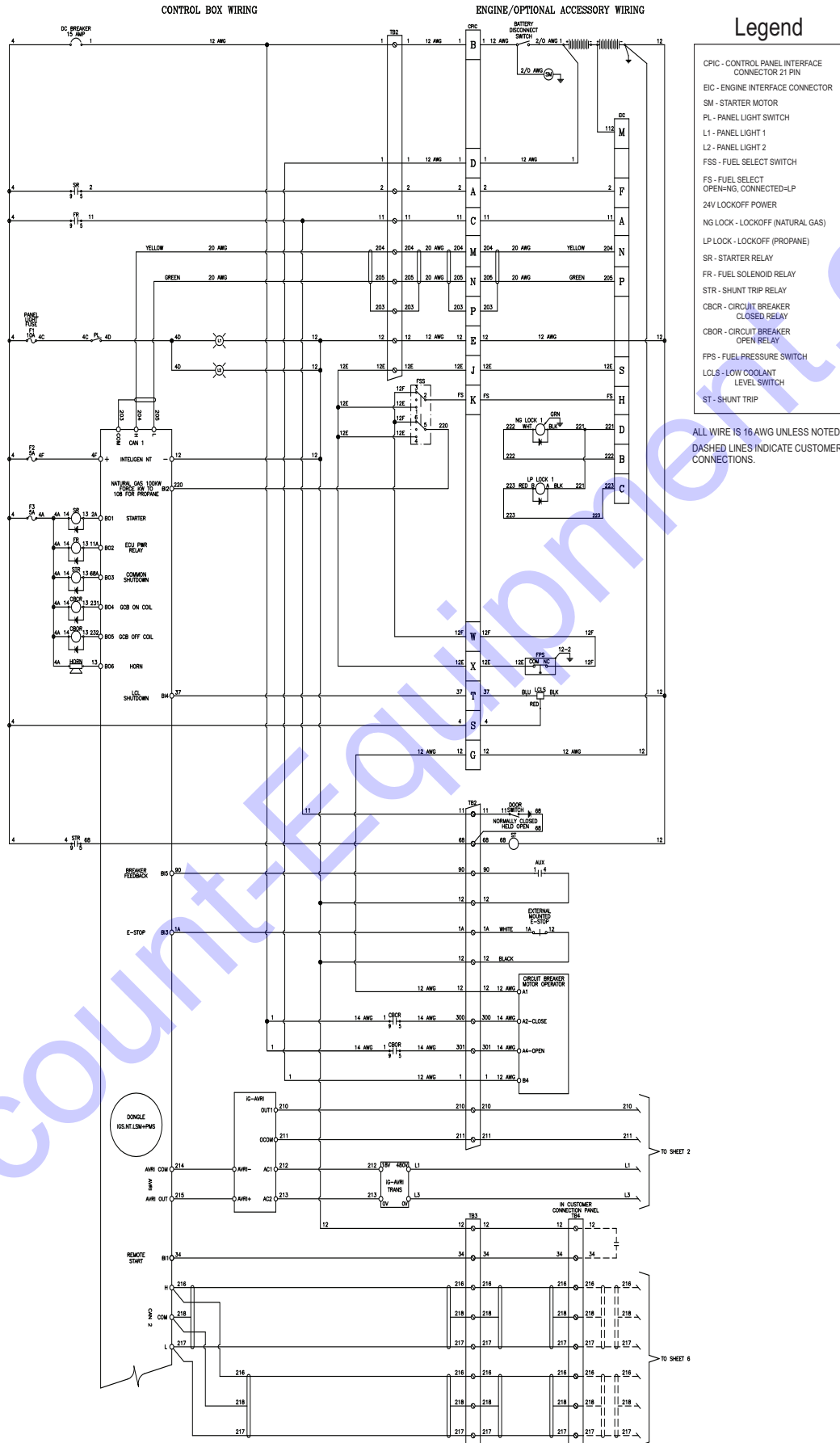

DC WIRING - MGG210 (24V GCB)

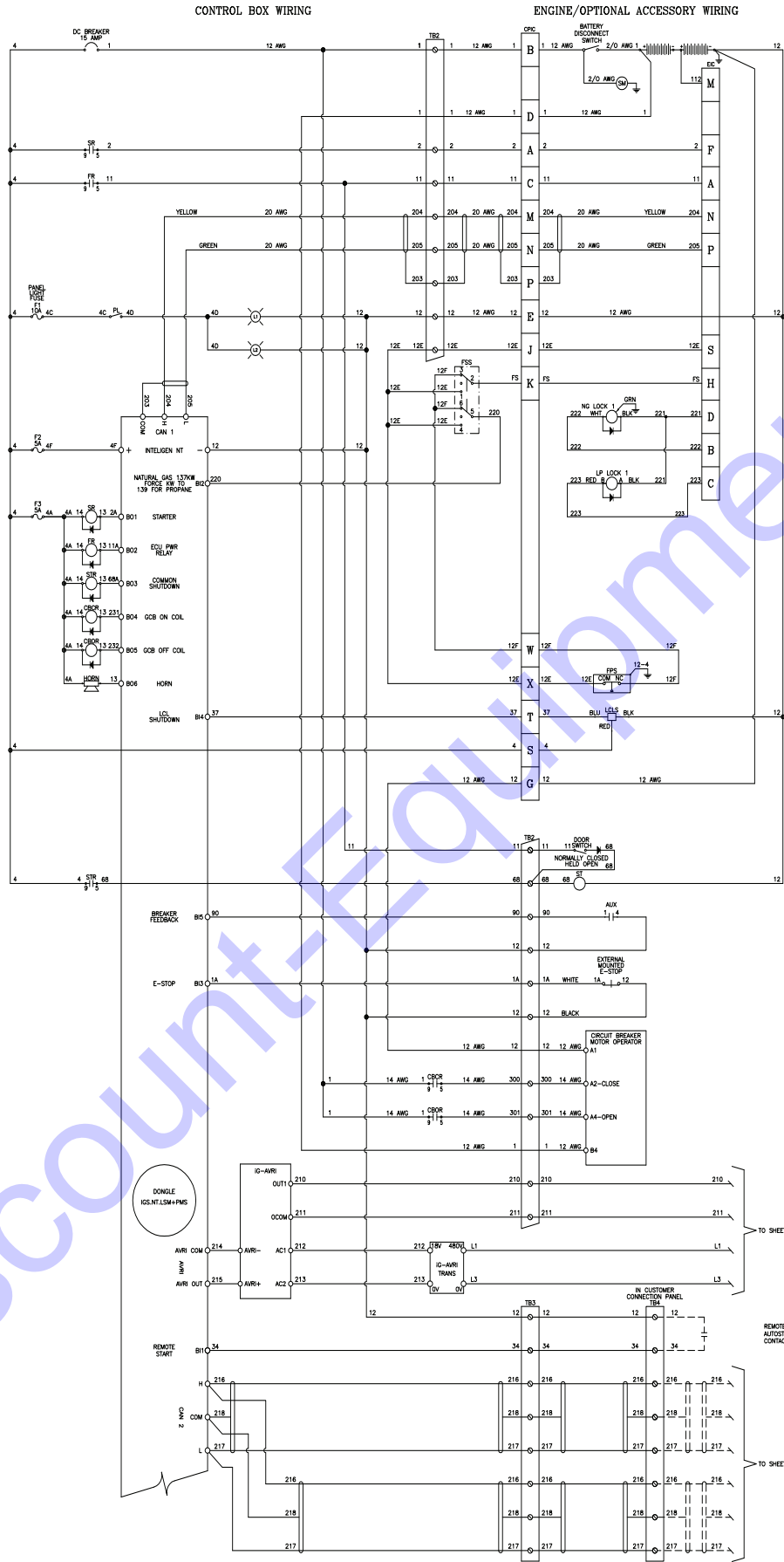

Legend

- CPIC - CONTROL PANEL INTERFACE CONNECTOR 21 PIN
- EIC - ENGINE INTERFACE CONNECTOR
- SM - STARTER MOTOR
- PL - PANEL LIGHT SWITCH
- L1 - PANEL LIGHT 1
- L2 - PANEL LIGHT 2
- FSS - FUEL SELECT SWITCH
- FS - FUEL SELECT OPENING CONNECTED-LP 24V LOCKOFF POWER
- NG LOCK - LOCKOFF (NATURAL GAS)
- LP LOCK - LOCKOFF (PROPANE)
- SR - STARTER RELAY
- FR - FUEL SOLENOID RELAY
- STR - SHUNT TRIP RELAY
- CBOR - CIRCUIT BREAKER OPEN RELAY
- CBOR - CIRCUIT BREAKER CLOSED RELAY
- FPS - FUEL PRESSURE SWITCH
- LCLS - LOW COOLANT LEVEL SWITCH
- ST - SHUNT TRIP

ALL WIRE IS 16 AWG UNLESS NOTED.
DASHED LINES INDICATE CUSTOMER CONNECTIONS.

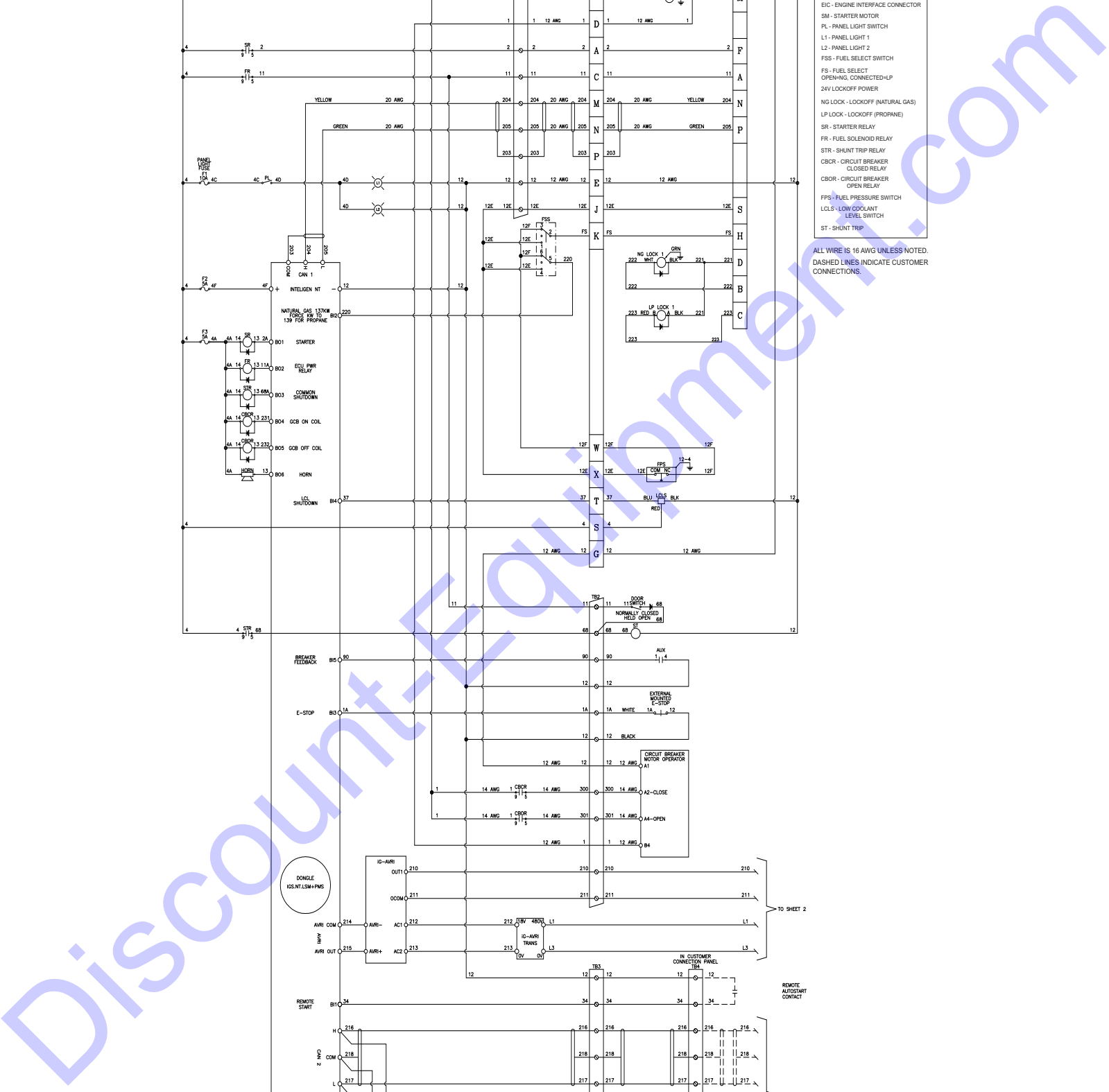

CUSTOMER CONVENIENCE RECEPTACLES - MGG155 AND MGG210

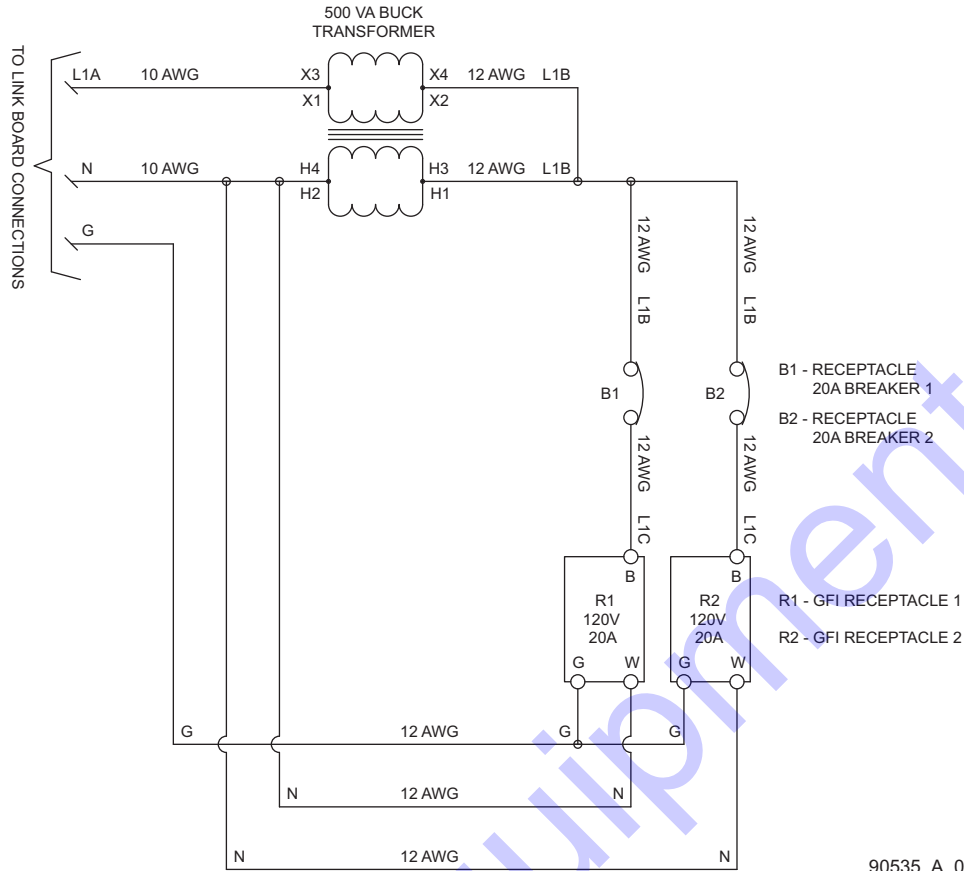

CAN PARALLEL COMMUNICATION CONNECTION - MGG155 AND MGG210

FIRST GENERATOR

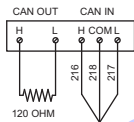

MIDDLE GENERATORS

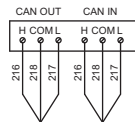

LAST GENERATOR

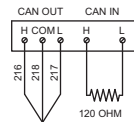

SINGLE GENERATOR

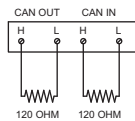

90534_ORG_06.13.14



www.discount-equipment.com

Discount-Equipment.com