

# 4S, S4S, 5S, 6S, 6SR, S6SR, 6PR, 8S, S8S, 8P, 10S, S10S, 12S & S12S

## OPERATOR'S MANUAL

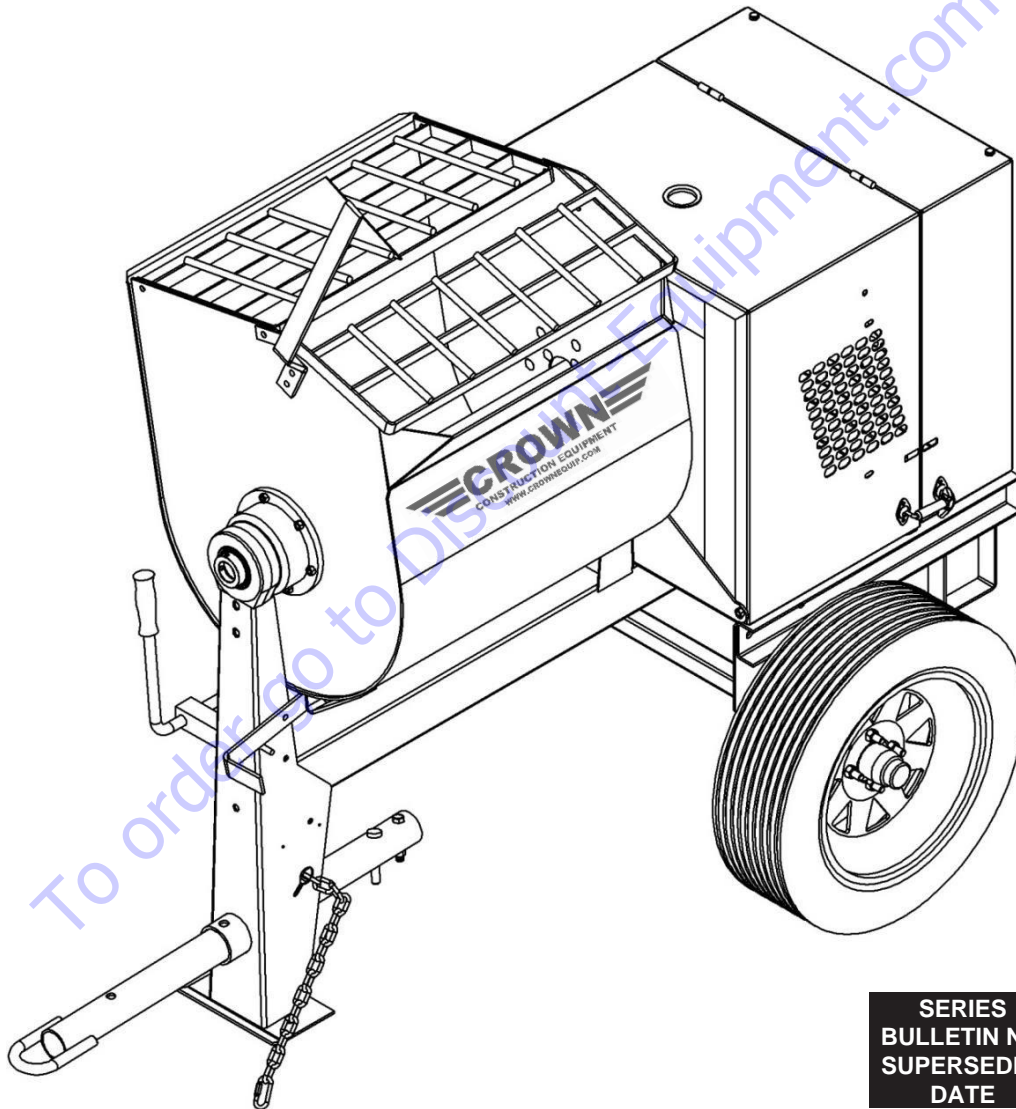

SERIES	MM - Mech
BULLETIN No.	200078-R04
SUPERSEDES	200078-R03
DATE	Apr 2020

**TO PURCHASE THIS PRODUCT PLEASE CONTACT US**



**Equipment Financing and  
Extended Warranties Available**



**Discount-Equipment.com is your online resource for  
commercial and industrial quality parts and equipment sales.**

**561-964-4949**

**visit us on line @ [www.discount-equipment.com](http://www.discount-equipment.com)**

Select an option below to find your Equipment

**Search by Manufacturer**

**Search by Product Type**

**Request a Quote**

We sell worldwide for the brands: Genie, Terex, JLG, MultiQuip, Mikasa, Essick, Whiteman, Mayco, Toro Stone, Diamond Products, Generac Magnum, Airman, Haulotte, Barreto, Power Blanket, Nifty Lift, Atlas Copco, Chicago Pneumatic, Allmand, Miller Curber, Skyjack, Lull, Skytrak, Tsurumi, Husquvarna Target, Stow, Wacker, Sakai, Mi-T-M, Sullair, Basic, Dynapac, MBW, Weber, Bartell, Bennar Newman, Haulotte, Ditch Runner, Menegotti, Morrison, Contec, Buddy, Crown, Edco, Wyco, Bomag, Laymor, EZ Trench, Bil-Jax, F.S. Curtis, Gehl Pavers, Heli, Honda, ICS/PowerGrit, IHI, Partner, Imer, Clipper, MMD, Koshin, Rice, CH&E, General Equipment, Amida, Coleman, NAC, Gradall, Square Shooter, Kent, Stanley, Tamco, Toku, Hatz, Kohler, Robin, Wisconsin, Northrock, Oztec, Toker TK, Rol-Air, APT, Wylie, Ingersoll Rand / Doosan, Innovatech, Con X, Ammann, Mecalac, Makinex, Smith Surface Prep, Small Line, Wanco, Yanmar

## CROWN'S CONDITIONS OF SALES & LIMITED WARRANTY

All sales made by Crown Construction Equipment Division of BTM Equipment are subject to these conditions unless otherwise agreed in writing with a duly authorized officer of Crown. In all cases of conflict between these conditions and the requirements of the purchase order, these conditions shall prevail.

(1) **SALES POLICY:** Nothing herein shall be construed as abridging the right of Crown to sell directly or indirectly to: (a) Federal, State or Provincial Governments or Agencies thereof, or to Agencies employing Federal, State or Provincial Government aid; (b) Purchasers who buy Crown's products for sale as integral or assembled parts of their products; (c) Firms operating on a national scale; (d) Any other class of purchaser to whom Crown may from time to time, elect to sell.

(2) **PRICES:** All prices are F.O.B. our warehouses, freight allowance as specified on Distributor Net Price Lists. The suggested list prices and discounts schedules are established by Crown and are intended to act as a guide for our distributors. Unless otherwise stated in writing, prices are subject to change without notice and will be applied as in effect at time of shipment.

(3) **(TERMS):** Unless otherwise agreed upon in writing by an officer of Crown, all invoices become due and payable net 30 days following the date in invoice. Interest at the maximum legal rate will be charged on all overdue accounts. Minimum net charge per invoice is \$75.00

(4) **CANCELLATION & CHANGES:** No orders or sales may be cancelled or changed without the consent of Crown. At Crown's option cancelled/changed orders are subject to payment of cancellation charges equal to all costs incurred by Crown up to the date of cancellation/change.

(5) **DELAYED DELIVERIES:** Crown shall not be liable for any delay of merchandise for any cause whatsoever.

(6) **CLAIMS:** All goods shall be deemed delivered to purchaser at the time they are placed in the hands of carrier and consigned to purchaser: loss, damage or destruction of any said merchandise is assumed by purchaser. No claims may be made for shortages unless made in writing within ten days from receipt of merchandise.

(7) **RETURN OF GOODS:** Written permission from Crown must be obtained before returning any merchandise. All transportation charges must be borne

by the purchaser. Credit for returned goods will be based on the original price paid, less 20%. Special parts or custom-built items cannot be returned for credit.

(8) **LIMITATION OF LIABILITY:** Crown's liability on any claim of any kind, including negligence, for any loss or damage arising out of, connected with, or resulting from contract, or the performance or breach thereof, or the design, manufacture, sale, delivery, resale, installation, technical direction of installation, inspection, repair, operation or use of any equipment covered by or furnished under contract shall in no case exceed the price paid by the purchaser for the equipment. Crown also disclaims all purchaser for the equipment. Crown also disclaims all liability, whether in contract, tort, warranty, or otherwise, to any party other than purchaser.

(9) All Price Lists, Catalogues and other material shall remain the property of Crown and are subject to return on demand. The Suggested List Prices are established by Crown and are intended to act as a guide. All shipping weights shown are approximate.

### LIMITED CROWN WARRANTY

For one year from date of purchase, Crown will replace or repair for the original purchaser, free of charge, any part or parts, found upon examination by any Crown Authorized Service Depot or by the Crown factory, to be defective in material or workmanship or both. Crown extends the warranty for the drum bearings and seals on plaster/mortar mixers to "Lifetime" and agrees to furnish, free of charge, the seals and bearings only upon receipt of the defective parts and evaluation at the factory. Equipment and accessories not manufactured by Crown are warranted only to the extent of the original manufacturer's warranty. All transportation charges on parts submitted for replacement or repair under this warranty must be borne by the purchaser. For warranty service contact your nearest Crown Authorized Service Depot.

THERE IS NO OTHER EXPRESS WARRANTY, IMPLIED WARRANTIES, INCLUDING THOSE OF MERCHANTABILITY AND FITNESS FOR A PARTICULAR PURPOSE ARE LIMITED TO ONE YEAR FROM PURCHASE AND TO THE EXTENT PERMITTED BY LAW. LIABILITY FOR CONSEQUENTIAL DAMAGES UNDER ANY AND ALL WARRANTIES ARE EXCLUDED TO THE EXTENT EXCLUSION IS PERMITTED BY LAW. (THIS WARRANTY IS AN ADDITION TO ANY STATUTORY WARRANTY.)

WARRANTY VOID IF PRODUCT NOT [REGISTERED ONLINE](#)

## TABLE OF CONTENTS

SECTION	DESCRIPTION	
	Proposition 65.....	5
1	Introduction.....	5
2	Safety .....	6
2.1	General Safety .....	7
2.2	Operating Safety .....	8
2.3	Maintenance Safety .....	8
2.4	Transport Safety .....	8
2.5	Tire Safety.....	9
2.6	Storage Safety .....	9
2.7	Refueling Safety.....	9
2.8	Electrical Safety .....	9
2.9	Safety Signs.....	9
2.10	Sign-Off Form .....	10
3	Safety Decals Location.....	11
4	Operation.....	14
4.1	To the New Operator or Owner.....	14
4.2	How the Machine Works .....	14
4.3	Pre-Operation Checklist.....	16
4.4	Pre-Start Procedures .....	17
4.5	Machine Break-In.....	17
4.6	Controls .....	17
4.7	Operating.....	20
4.8	Transporting .....	25
4.9	Storage .....	26
5	Service and Maintenance .....	27
5.1	Service.....	27
5.1.1	Fluids and Lubricants.....	27
5.1.2	Greasing.....	28
5.1.3	Servicing Intervals .....	28
5.1.4	Service Record .....	29
5.2	Maintenance .....	30
5.2.1	Engine Oil Changing .....	30
5.2.2	Engine Speed Setting .....	30
5.2.3	Air Cleaner Maintenance .....	31
5.2.4	Belt Tension and Alignment.....	31
5.2.5	Wiper Spacing and Replacement.....	32
5.2.6	Gearbox Oil Changing .....	32
6	Trouble Shooting.....	33
7	Specifications .....	34
7.1	Mechanical .....	35
7.2	Bolt Torque .....	36
8	Notes .....	37



# WARNING



## CALIFORNIA - Proposition 65 Warning

Engine exhaust and some of its constituents and some dust created by power sanding, sawing, grinding, drilling and other construction activities contains chemicals known to the State of California to cause cancer, birth defects and other reproductive harm.

Some examples of these chemicals are: -

Lead from lead-based paints  
Crystalline silica from bricks  
Cement and other masonry products  
Arsenic and chromium from chemically treated lumber

Your risk from these exposures varies, depending on how often you do this type of work. To reduce your exposure to these chemicals:

**ALWAYS** work in a well-ventilated area, and work with approved safety equipment, such as dust masks that are specially designed to filter out microscopic particles.

## 1 INTRODUCTION

Congratulations on your choice of a Crown Construction Equipment Mortar Mixer to complement your construction operation. This equipment has been designed and manufactured to meet the needs of a discriminating buyer for the efficient mixing of mortar or plaster.

Safe, efficient and trouble-free operation of your Crown Mortar Mixer requires that you and anyone else who will be operating or maintaining the Mixer, read and understand the Safety, Operation, Maintenance and Trouble Shooting information contained in the Operator's Manual.



This manual is applicable to all the Model 4S, 5S, S5S, 6S, 6SR, S6SR, 6PR, S8S, 8S, 8P, 10S, S10S, 12S and S12S Mortar Mixers built by Crown Construction Equipment. Use the Table of Contents or Index as a guide when searching for specific information.

Keep this manual handy for frequent reference and to pass on to new operators or owners. Call your Crown Construction Equipment distributor or dealer if you need assistance or information.

**OPERATOR ORIENTATION** - The directions left, right, front and rear, as mentioned throughout this manual, are as seen from behind the machine and facing in the direction of towing.

## 2 SAFETY

### SAFETY ALERT SYMBOLS

This Safety Alert symbol means  
**ATTENTION! BECOME ALERT!  
YOUR SAFETY IS INVOLVED!**



The Safety Alert symbol identifies important safety messages on the Crown Mortar Mixer and in the manual. When you see this symbol, be alert to the possibility of personal injury or death. Follow the instructions in the safety message.

Why is SAFETY important to you?

#### 3 Big Reasons

Accidents Disable and Kill  
Accidents Cost  
Accidents Can Be Avoided

**SIGNAL WORDS:** Note the use of the signal words DANGER, The Safety Alert symbol identifies important safety messages on the Crown Mortar Mixer and in the manual. When you see this symbol, be alert to the possibility of personal injury or death. Follow the instructions in the safety message. This Safety Alert symbol means ATTENTION! BECOME ALERT! YOUR SAFETY IS INVOLVED! WARNING and CAUTION with the safety messages. The appropriate signal word for each message has been selected using the following guide-lines:

**DANGER** - Indicates an imminently hazardous situation that, if not avoided, will result in death or serious injury. This signal word is to be limited to the most extreme situations, typically for machine components that, for functional purposes, cannot be guarded.

**WARNING** - Indicates a potentially hazardous situation that, if not avoided, could result in death or serious injury, and includes hazards that are exposed when guards are removed. It may also be used to alert against unsafe practices.

**CAUTION** - Indicates a potentially hazardous situation that, if not avoided, may result in minor or moderate injury. It may also be used to alert against unsafe practices.

#### SAFETY

YOU are responsible for the SAFE operation and maintenance of your Concrete Mixer. YOU must ensure that you and anyone else who is going to operate, maintain or work around the Concrete Mixer be familiar with the operating and maintenance procedures and related SAFETY information contained in this manual. This manual will take you step-by-step through your working day and alerts you to all good safety practices that should be adhered to while operating the Mixer.

Remember, YOU are the key to safety. Good safety practices not only protect you but also the people around you. Make these practices a working part of your safety program. Be certain that EVERYONE operating this equipment is familiar with the recommended operating and maintenance procedures and follows all the safety precautions. Most accidents can be prevented. Do not risk injury or death by ignoring good safety practices.

- (204) Mixer owners must give operating instructions to operators or employees before allowing them to operate the machine, and at least annually thereafter.
- (205) The most important safety device on this equipment is a SAFE operator. It is the operator's responsibility to read and understand ALL Safety and Operating instructions in the manual and to follow these. All accidents can be avoided.
- (206) A person who has not read and understood all operating and safety instructions is not qualified to operate the machine. An untrained operator exposes himself and bystanders to possible serious injury or death.
  - Do not modify the equipment in any way. Unauthorized modification may impair the function and/or safety and could affect the life of the equipment.

7. Stop engine, disconnect spark plug wire and wait for all moving parts to stop before servicing, adjusting, repairing or cleaning.

8. Wear appropriate hearing protection when operating for long periods of time.



9. Dust Hazard ~ Wear appropriate dust mask around this equipment.



10. Ventilation ~ Never operate any gas-powered equipment in a poorly ventilated or enclosed area. Avoid prolonged breathing of exhaust gases.



11. Hot Surface ~ Avoid contact with hot exhaust system and engine. Allow to cool before performing repairs or service.



## 2.1 GENERAL SAFETY

1. Read and understand the Operator's manual and all safety signs before operating, maintaining, adjusting, servicing or cleaning the Mixer.



2. Only trained competent persons shall operate the Mixer. An untrained operator is not qualified to operate the machine.

3. Have a first-aid kit available for use, should the need arise and know how to use it.



4. Do not allow riders when towing.

5. Have a fire extinguisher available for use should the need arise and know how to use it.



12. Electrocutation Hazard ~ Always use proper size grounded extension cord. Inspect all extension cords for cuts, frayed wire and broken connectors. Do not use cords if not in good condition.



6. Wear appropriate protective gear. This list includes, but is not limited to:

- A hard hat
- Protective boots with slip resistant soles
- Protective goggles
- Heavy gloves
- Hearing protection



7. Do not refuel the machine while smoking or when near open flame or sparks



## 2.2 OPERATING SAFETY

1. Understand the Operator's Manual & all safety signs before operating, servicing, adjusting, or cleaning the Mixer.
2. Do not allow riders on the machine during transport.
3. Install, close and secure all guards, shields and hoods before starting or operating.
4. Stop engine or motor, disconnect spark plug wire or unplug power cord, and wait for all moving parts to stop before servicing, adjusting, repairing, or cleaning.  
Clear the area of all bystanders before starting.
5. Keep hands, feet, hair and clothing away from moving parts.
6. Keep working area clean and dry to prevent slipping and tripping.
7. Do not run the mixer in an explosive atmosphere or in a poorly ventilated or enclosed area.
8. Wear appropriate hearing protection when operating for long periods of time.
9. Always attach safety chain when towing.
10. Do not exceed a safe travel speed when towing. Slow down for corners and when going over rough terrain.
11. Review safety instructions with all operators annually.

### Gas engine powered units:

- Do not place hands in the drum unless the engine is OFF and the spark plug wire is disconnected.
- Stay away from hot engine components during operation.
- Do not smoke when refueling gas engine. Electric motor- powered units:
- Do not place hands in the drum unless the motor is OFF and the power cord unplugged.
- Have a licensed electrician wire up and provide power to the motor.
- Only use a power cord that is grounded.
- Always use an electrical cord with the required power carrying capacity.

## 2.3 MAINTENANCE SAFETY

1. Review Operator's Manual and all safety items before working with, maintaining or operating the Mixer.
2. Stop engine or motor, disconnect spark plug wire or unplug power cord, and wait for all moving parts to stop before servicing, adjusting, repairing, or cleaning.
3. Follow good shop practices
  - Keep service area clean and dry.
  - Be sure electrical outlets and tools are properly grounded.
  - Use adequate light for the job.
4. Keep hands, feet, clothing and hair away from all moving and/or rotating parts.
5. Do not place hands in the drum unless the engine is off and the spark plug wire is disconnected or the power cord is unplugged.
6. Do not attempt any adjustment or maintenance to any system of the Mixer unless the power source is disabled.
7. Make sure that all guards, shields and hoods are properly installed and secured before operating the Mixer.
8. Securely support the machine using blocks or safety stands before working beneath it or changing tires.
9. Store & transfer gasoline, solvents, cleaners or any flammable liquids only in safety standard containers.





## 2.4 TRANSPORT SAFETY

1. Read and understand ALL the information in the Operator's Manual regarding procedures and SAFETY when operating the Mixer in the work- place and/or on the road.
2. Always travel at a safe speed. Use caution when making corners or on a rough surface.
3. Make sure all the lights and reflectors that are required by the local highway and transport authorities are in place, are clean and can be seen clearly by all overtaking and oncoming traffic.
4. Do not allow riders on any part of the machine during either road or highway travel.
5. Always use a safety chain between the Mixer and the towing vehicle when transporting.
6. Use a mechanical retainer through the ball hitch or clevis pin before transporting.
7. Ensure wheel nuts and axle hardware are tight.

## 2.5 TIRE SAFETY

1. Failure to follow proper procedures when mounting a tire on a wheel or rim can produce an explosion which may result in serious injury or death.
2. Do not attempt to mount a tire unless you have the proper equipment and experience to do the job.
3. Have a qualified tire dealer or repair service perform required tire maintenance.

## 2.6 STORAGE SAFETY

1. Store unit in an area away from human activity.
2. Do not permit children to play on or around the stored Mixer.

## 2.7 REFUELING SAFETY

1. Handle fuel with care. It is highly flammable.
2. Allow engine to cool for 5 minutes before re- fueling. Clean up spilled fuel before restarting engine.
3. Do not refuel the machine while smoking or when near open flame or sparks.
4. Always use an approved fuel container.
5. Fill fuel tank outdoors.
6. Prevent fires by keeping machine clean of accumulated trash, grease and debris.



## 2.8 ELECTRICAL SAFETY

1. Have a licensed electrician wire up and supply power to the electric motor.
2. Always use a grounded power cord with the re- quired capacity to carry the power to the motor.
3. Route the power cord out of the way or protect from damage.
4. Turn motor off, unplug power cord or turn off power at master panel and wait for all moving parts to stop before servicing, maintaining, adjusting or cleaning.
5. Keep all electrical components in good condition.

## 2.9 SAFETY SIGNS

1. Keep safety signs clean and legible at all times
2. Replace safety signs that are missing or have become illegible.
3. Replaced parts that displayed a safety sign should also display the current sign.
4. Safety signs are available from your Distributor or the factory.

**How to Install Safety Signs:**

- Be sure that the installation area is clean and dry.
- Decide on the exact position before you remove the backing papers.
- Remove the smallest portion of the split backing paper.
- Align the sign over the specified area and carefully press the small portion with the exposed sticky backing in place.
- Slowly peel back the remaining paper and carefully smooth the remaining portion of the sign in place.
- Small air pockets can be pierced with a pin and smoothed out using the piece of sign backing paper.

**2.10 SIGN-OFF FORM**

Crown Construction Equipment follows the general Safety Standards specified by the Society of Automotive Engineers (SAE) and the Occupational Safety and Health Administration (OSHA). Anyone who will be operating and/or maintaining the Crown Mortar Mixer must read and clearly understand ALL Safety, Operating and Maintenance information presented in this manual.

Do not operate or allow anyone else to operate this equipment until such information has been reviewed. Annually review this information before the season start-up.

Make these periodic reviews of SAFETY and OPERATION a standard practice for all of your equipment. We feel that an untrained operator is unqualified to operate this machine.

A sign-off sheet is provided for your record keeping to show that all personnel who will be working with the equipment have read and understand the information in the Operator’s Manual and have been instructed in the operation of the equipment.

DISTRIBUTOR INSPECTION REPORT	SAFETY
Tire Pressure Checked Wheel Bolts and All Fasteners Torqued Mixing Elements Turn Mixing Drum Pivots Drive Belt Tension & Pulley Alignment Drive Engagement Clutch Set Lubricate Machine Fill Engine Crankcase & Gearbox Check Fluid Levels Have Licensed Electrician Wire Motor & Provide Power	Safety Chain Attached All Decals Installed Review Operating And Safety Instructions

### 3. SAFETY DECALS LOCATIONS

The types of safety signs and locations on the equipment are shown in the illustration below. Good safety requires that you familiarize yourself with the various Safety Signs, the type of warning and the area, or particular function related to that area, that requires your SAFETY AWARENESS. Think SAFETY! Work SAFELY!

REMEMBER - If Safety Signs have been damaged, removed, become illegible or parts replaced without safety signs, new signs must be applied.

New safety signs are available from your authorized dealer.

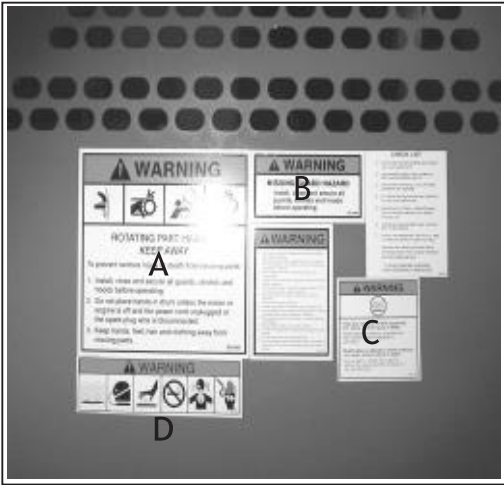

The illustration shows a panel with several safety decal locations labeled A, B, C, and D. Location A is a 'ROTATING PART HAZARD' sign. Location B is a 'MISSING GUARD HAZARD' sign. Location C is a 'WARNING' sign about improper operation. Location D is a 'WARNING' sign with multiple pictograms.

**A**

**WARNING**

**ROTATING PART HAZARD  
KEEP AWAY**

TO PREVENT SERIOUS INJURY OR DEATH ROTATING PARTS:

1. INSTALL, CLOSE AND SECURE ALL GUARDS, SHIELDS AND HOODS BEFORE OPERATING.
2. DO NOT PLACE HANDS IN DRUM UNLESS THE MOTOR OR ENGINE IS OFF AND THE POWER CORD UNPLUGGED OR THE KILL SWITCH ACTIVATED.
3. KEEP HANDS, FEET, HAIR AND LOOSE CLOTHES AWAY FROM MOVING PARTS.

201003

**B**

**WARNING**

**MISSING GUARD HAZARD**

INSTALL, CLOSE AND SECURE ALL GUARDS, SHIELDS AND HOODS BEFORE OPERATING.

**C**

**WARNING**



IMPROPER OPERATION OF THIS EQUIPMENT CAN CAUSE SERIOUS INJURY OR DEATH. READ OPERATOR'S MANUAL SUPPLIED WITH THIS MACHINE BEFORE OPERATION OR SERVICING. MODIFICATION OR ALTERATION OF THIS MACHINE WILL VOID MANUFACTURER'S WARRANTY. DO NOT ALTER OR MODIFY THIS MACHINE WITHOUT THE EXPRESS WRITTEN CONSENT OF THE MANUFACTURER.

201154

**D**

**WARNING**



201005

**E**

**CHECK LIST**

- CHECK AND TIGHTEN WHEN NECESSARY ALL NUTS AND BOLTS.
- CHECK MIXER PADDLE AND WIPERS ADJUSTMENTS AND TIGHTEN PADDLE BOLTS.
- GREASE ALL FITTINGS - GREASE DRUM SEALS TO AVOID DOWN TIME ON REPAIRS.
- CHECK BELT ADJUSTMENT AND TIGHTEN BELT IF NECESSARY.
- CHECK TIRE PRESSURE. INFLATE 12" AND 13" TO 30 PSI. 8" TIRES TO 45 PSI. WHEEL LUG TORQUE MUST BE 105 LBF.
- ENSURE THE DRUM LOCK AND HOOD FASTENER ARE IN LOCKED POSITION BEFORE TRANSPORTATION.

290791

E

**WARNING**



**ROTATING PART HAZARD  
KEEP AWAY**

TO PREVENT SERIOUS INJURY OR DEATH ROTATING PARTS:

- INSTALL, CLOSE AND SECURE ALL GUARDS, SHIELDS AND HOODS BEFORE OPERATING. DO NOT PLACE HANDS IN DRUM UNLESS THE MOTOR OR ENGINE IS OFF AND THE POWER CORD UNPLUGGED OR THE KILL SWITCH ACTIVATED.
- KEEP HANDS, FEET, HAIR AND LOOSE CLOTHES AWAY FROM MOVING PARTS.

201003



F

**WARNING**



**ROTATING PART HAZARD**

ALWAYS STAND CLEAR OF THE DUMP HANDLE WHEN MIXER IS IN OPERATION. ANY BINDING OF MATERIAL BETWEEN MIXER BLADES AND THE DRUM MAY CAUSE DRUM HANDLE TO QUICKLY MOVE TO THE CHARGE POSITION.

201157

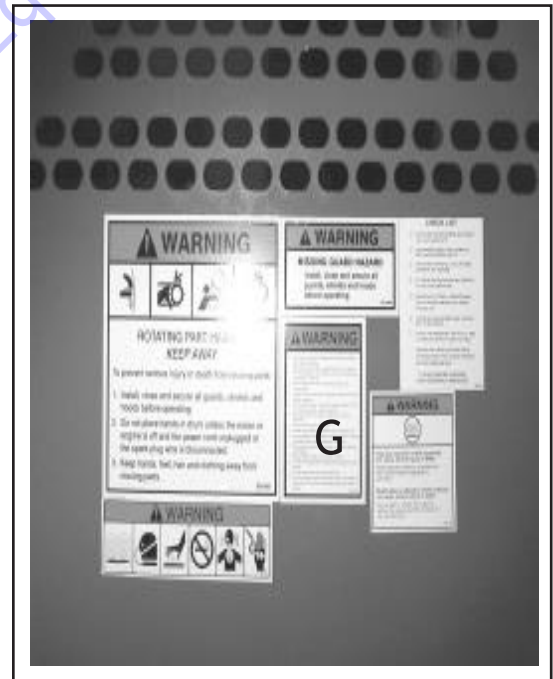

G

**WARNING**

- READ AND UNDERSTAND OPERATOR'S MANUAL AND SAFETY SIGNS BEFORE STARTING.
- STOP ENGINE, DISCONNECT SPARK PLUG WIRE AND WAIT FOR ALL MOVING PARTS TO STOP BEFORE SERVICING, MAINTAINING, ADJUSTING OR CLEANING.
- KEEP HANDS, FEET, HAIR OR CLOTHING AWAY FROM MOVING PARTS.
- INSTALL, CLOSE AND SECURE ALL GUARDS, SHIELDS AND HOODS BEFORE OPERATING.
- DO NOT PLACE HANDS IN THE DRUM UNLESS ENGINE IS OFF AND SPARK PLUG IS DISCONNECTED OR MOTOR IS OFF AND POWER CORD IS UNPLUGGED.
- STAY AWAY FROM HOT ENGINE COMPONENTS DURING OPERATION
- HAVE A LICENCED ELECTRICIAN WIRE UP ELECTRIC MOTORS.
- DO NOT SMOKE WHEN REFUELING.
- USE POWER CORD WITH REQUIRED CAPACITY TO CARRY POWER TO ELECTRIC MOTOR.
- FOLLOW GOOD SAFETY PROCEDURES WHEN HANDLING FUEL.
- ROUTE THE POWER CORD OUT OF THE WAY & PROTECT IT FROM DAMAGE.
- DO NOT OPERATE IN AN EXPLOSIVE ATMOSPHERE OR A POORLY VENTILATED AREA WITHOUT ADEQUATE VENTILATION.
- KEEP WORKING AREAS DRY AND CLEAN TO PREVENT SLIPPING AND TRIPPING.
- ALWAYS ATTACH SAFETY CHAIN WHEN TOWING.
- COMPLY WITH APPLICABLE TRANSPORTING REGULATIONS WHEN TOWING.
- DO NOT ALLOW RIDERS DURING TRANSPORTING.
- DO NOT EXCEED A SAFETY TRAVEL SPEED WHEN TRANSPORTING. SLOW DOWN FOR CORNERS AND WHEN GOING OVER ROUGH TERRAIN.

201001

H



**USE GASOLINE FUEL ONLY**  
201152

J



**DANGER**

**FIRE HAZARD  
NO SMOKING**

TO PREVENT SERIOUS INJURY OR DEATH FROM FIRE:

1. DO NOT SMOKE WHEN REFUELING
2. KEEP SPARKS, FLAMES, AND HOT MATERIAL AWAY FROM FLAMMABLE SUBSTANCES.

201005



L



**DANGER**

**ELECTROCUTION HAZARD**

1. TURN MACHINE OFF, SHUT DOWN AND LOCK OUT POWER SOURCE, UNPLUG POWER CORD AND WAIT FOR MOVING PARTS TO STOP BEFORE SERVICING OR REPAIRING MACHINE OR ELECTRICAL EQUIPMENT.

M



**WARNING**



EXCESSIVE TOWING SPEED CAN CAUSE SERIOUS INJURIES OR DEATH.

**DO NOT EXCEED 45 MI/HR. (73 KM/HR.)**

- BE CERTAIN THAT THE WHEEL LUG NUTS AND AXLE MOUNTING HARDWARE ARE TIGHTENED.
- CHECK PRESSURE AND OVERALL CONDITIONS OF TIRES.

201151





N

**NOTICE**

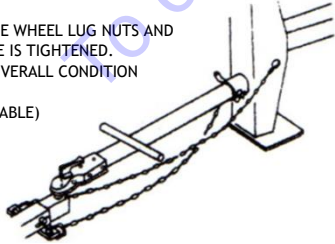

- ENSURE THE VEHICLE HAS TOWING CAPACITY FOR THE WEIGHT OF THIS MACHINE.
- DO NOT TOW MACHINE UNLESS THE DRAW BAR IS BOLTED IN PLACE AND THE SAFETY PIN IS SECURELY FASTENED.
- CLOSE ENGINE FUEL CUTOFF BEFORE TOWING MIXER TO PREVENT LEAKING OIL INTO ENGINE CRANKCASE.
- 2-PERSON LIFT PER UNIT TO POSITION MIXER ON VEHICLE.
- SECURELY ATTACH HITCH TO TOWING VEHICLE. ENSURE USE OF SAFETY PIN THROUGH LATCH OR HANDWHEEL FOR BALL TYPE HITCH. SAFETY CHAIN ATTACHMENT (SEE PICTURE) MUST CROSS UNDER THE DRAW BAR AND BE POSITIONED TO PREVENT THE DRAW BAR FROM DROPPING TO THE GROUND IN THE EVENT OF HITCH FAILURE.
- CONNECT LIGHTING PLUG/ELECTRIC BRAKE PLUG (WHEN APPLICABLE)
- MAKE CERTAIN THAT THE WHEEL LUG NUTS AND AXLE MOUNT HARDWARE IS TIGHTENED.
- CHECK PRESSURE AND OVERALL CONDITION OF TIRES.
- TEST BREAKS (IF APPLICABLE)

201150



P



**CAUTION**

**2-PERSON LIFT REQUIRED TO POSITION MIXER HITCH ON/OFF VEHICLE**

201155

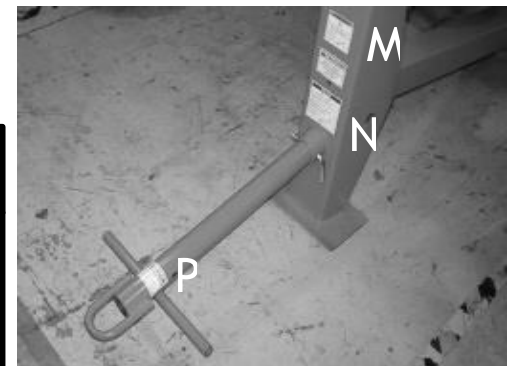

## 4 OPERATION

### 4.1 TO THE NEW OPERATOR OWNER

The Crown Construction Equipment Mortar Mixer is designed to efficiently combine water, lime, aggregate and cement into a mixture for forming mortar. It is the responsibility of the operator to be familiar with the machine before starting.

It is the responsibility of the owner or operator to read this manual before starting. Follow all safety instructions exactly. Safety is everyone's business. By following recommended procedures, a safe working environment is provided for the operator, bystanders and the environment.

Many features incorporated into this machine are the result of suggestions made by customers like you. Read this manual carefully to learn how to operate the machine safely and how to set it to provide maximum mixing efficiency. By following the operating instructions in conjunction with a good maintenance program, your Mixer will provide many years of trouble-free service.

### 4.2 HOW THE MACHINE WORKS

The Mortar Mixer consists of a large tilting drum with internal rotating paddles or spiral blades for combining cement, lime, aggregate and water into a mixture for forming mortar. The enclosure on the back end houses the electric motor or gas engine for turning the mixing elements. A set of pulleys and drive belt within the enclosure transmits rotational power to a gearbox that powers the mixing elements.

A lever on the front end of the drum assembly allows the operator to tilt the drum to the required position for mixing and emptying. A lever on the bottom of the frame extends to the power compartment and moves

the gearbox to engage the drive belt for turning the mixing elements. An extendable hitch allows the hitch to extend for towing and retracts during operation.

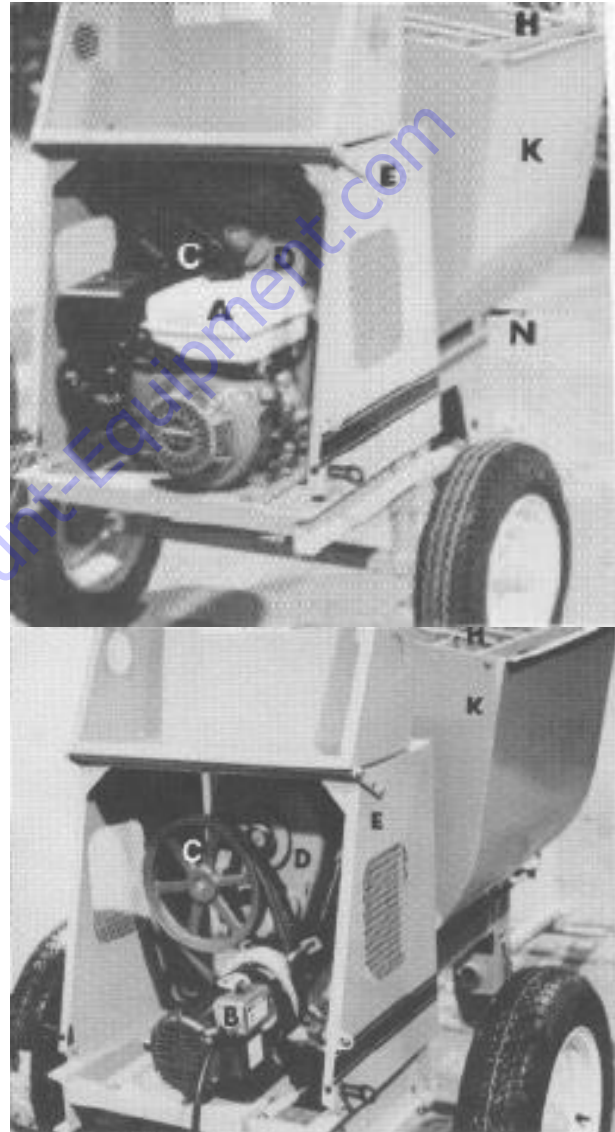

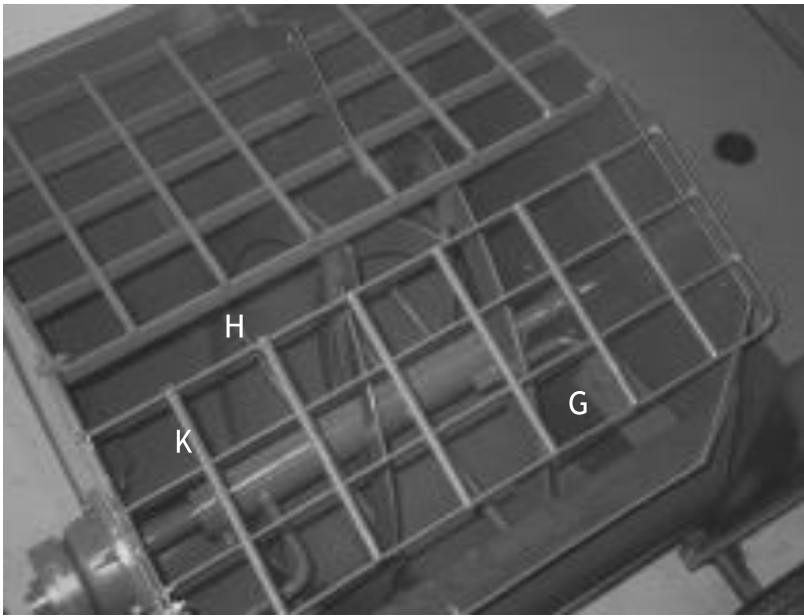

**Fig. 1 MACHINE COMPONENTS**

- |                     |                     |
|---------------------|---------------------|
| A Gas Engine        | J Bag Splitter      |
| B Electric Motor    | K Drum              |
| C Belt/Pulley Drive | L Tilt Lever        |
| D Gearbox           | M Drum Lock         |
| E Power Compartment | N Engagement Clutch |
| F Paddles           | O Hitch             |
| G Spiral Blades     | P Safety Chain      |
| H Grill             | Q Emergency Stop    |



To order go to Discount-Equipment.com

### 4.3 PRE-OPERATION CHECKLIST

Efficient and safe operation of the Mixer requires that each operator reads and understands the operating procedures and all related safety precautions outlined in this section. A pre-operation checklist is provided for the operator. It is important for both personal safety and maintaining the good mechanical condition of the machine that this checklist is followed.

Before operating the Mixer and each time there-after, the following areas should be checked off:

#### 1. Gas Engine Units:

- a. Check all fluid levels: fuel, engine oil and gearbox oil. Refuel or top up oil as required.
- b. Check the tires and be sure that they are inflated to the specified pressure.
- c. Check the tension and alignment of drive belt when engaged. Tension or align as required.
- d. Check the engine speed at maximum. Be sure it is set to give a paddle rotation speed of 30-35 RPM and a spiral rotation of 40-45 RPM.
- e. Use the emergency stop switch to stop the engine to be sure that it works. Repair or replace if it is not functioning.
- f. Lubricate machine per Maintenance Section.
- g. Close and secure all guards, shields and hoods.

#### 2. Electric motor units:

- a. Check the tension and alignment of drive belt when engaged. Tension and align as required.
- b. Check gearbox oil level. Top up as required.
- c. Check the tires and be sure that they are inflated to the specified pressure.
- d. Lubricate machine per Maintenance Section.
- e. Close and secure all guards, shields and hoods.

### 4.4 PRE-START PROCEDURES

All machines are sent from the factory in a special shipping configuration to prevent spilling oil or gas. As a result, the following items must be done prior to starting the machine:

#### 1. Gas engine powered units:

- a. Fill the engine crankcase with its specified oil (SAE 30W or 10W/30 oil).

**IMPORTANT**  
Engine warranty is void if the engine is run without oil.

Refer to engine manual for oil specifications if operating in unusual temperature conditions.

- b. Add **SAE 80W90 oil to the gearbox.**
- c. Fill the fuel tank with regular unleaded gas. Do not use an ethanol blend.
- d. Start the engine and set the high idle speed to give a mixing element rotation speed of 30 to 35 RPM for the paddles and 40 to 45 for the spiral.

#### **IMPORTANT**

The engine is supplied from the engine manufacturer with the high idle speed set at approximately 3500 RPM and no gas or oil. As a result, the engine is not run when it is mounted to the Mixer. It is the responsibility of the customer to add oil and gas, start the engine and reset the high idle RPM to the operating range (Refer the Maintenance Section for procedure).

- e. The machine is shipped with the drum tilt lever pointing down or fastened to the safety grill. Remove lever and turn it around so it is pointing up. Tighten mounting bolts to their specified torque.
- f. Be sure the emergency stop switch is functioning properly.



2. Electric motor-powered units:
  - a. Have a licensed electrician provide power to the motor. Use only a grounded cord with sufficient capacity to carry the required load.
  - b. Have a licensed electrician wire up the motor if it is not a 110-volt unit.
  - c. The machine is shipped with the drum tilt lever pointing down. Remove lever and turn it around so it is pointing up. Tighten mounting bolts to their specified torque.

## 4.4 MACHINE BREAK-IN

A special break-in procedure has been developed to ensure the integrity of the machine when first starting. When using the machine for the first time, follow this procedure.

### A. Before Starting:

1. Read the engine and Mixer Operator's Manuals.
2. Review and follow pre-start procedures before starting machine (Section 4.4).

### B. At 1/2, 2, 5 and 10 hours:

1. Check all machine fluid levels: Fuel, engine oil and gearbox oil. Refuel or top up as required.
2. Retorque wheel bolts.
3. Check for loose hardware. Tighten to specified torque.
4. Check drive belt tension and alignment when engaged. Tension and align as required.
5. Lubricate the points defined in the Maintenance section.
6. Then go to the service schedule as defined in the Maintenance section.

### C. At 10 hours:

1. Change the engine oil.
2. Change the gearbox oil.
3. Replace with their specified oil.
4. Then go to the oil replacement schedule as defined in the Maintenance section and engine manual.

## 4.5 CONTROLS

Before starting to work, all operators should familiarize themselves with the location and function of the controls.

### 1. Gas engine powered units:

Always read the engine Operator's Manual supplied with the machine for the detailed operating procedures for your engine.

#### a. Ignition switch:

This switch controls the electrical power to the engine electrical system. Turn the switch clockwise to turn the electrical system ON and the engine will run. Turn counterclockwise to stop the engine.

#### b. Fuel shutoff valves:

Each engine is equipped with a shut-off valve between the fuel tank and the carburetor.

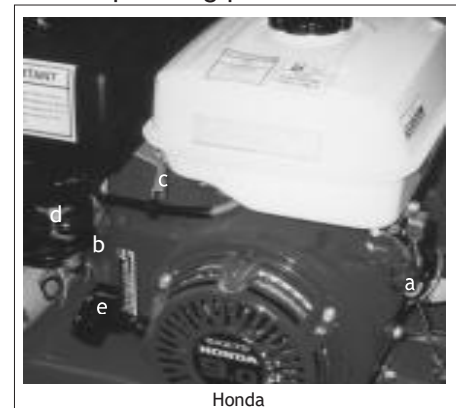

Honda

Slide the fuel valve toward the block to turn ON and away for OFF. Turn the fuel OFF when not in use or before transporting.

c. Throttle:

This lever controls the engine RPM. Move the lever laterally to increase or decrease the RPM. Always run at maximum throttle operating.

d. Choke:

The choke controls the fuel/air mixture to the engine. Close the choke when starting if the engine is cold. Open the choke as the engine warms. Always open the choke fully during operation.

e. Starting rope:

This retracting rope and T bar is used to turn the engine over for starting. Grasp the T bar firmly and pull the rope sharply to start the engine.

Close the choke if the engine is cold.

f. External Emergency Stop Switch:

This push-pull switch shorts out the power to the gas engine ignition system and is located on the outside of the hood. Push the switch in to stop the engine and pull out to allow it to run.

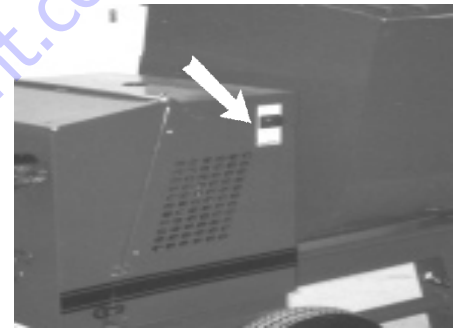

**2. Electric Motor (Typical):**

a. Master ON/OFF:

This switch controls the power to the electric motor that turns the mixing elements in the drum. Move the switch rearward to turn ON and forward for OFF.

2. Drum Position:

This lever sets the position of the mixing drum. Move the lever down to empty the drum and up to mix.

3. Drum Position Lock:

This lever locks the mixing drum in its mixing position. Pull up on lever to release the lock. It will automatically engage when the drum is moved into its mixing position

4. Drum Position Lock: This lever locks the mixing drum in its mixing position. Pull up on lever to release the lock. It will automatically engage when the drum is moved into its mixing position.

5. Drive Engagement Clutch: This lever engages and disengages the mixing elements in the drum. Move to the left to disengage the drive and ease to the right to engage. Always disengage before starting the engine or motor.

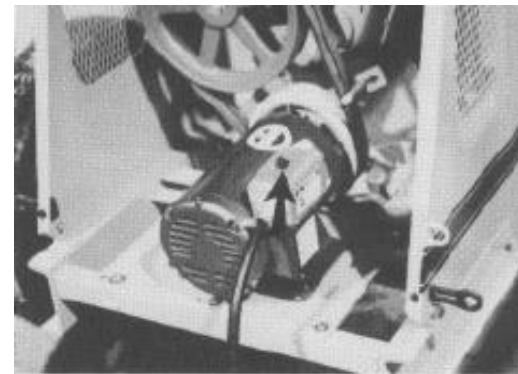

## 4.6 OPERATING SAFETY



### OPERATING SAFETY

1. Read and understand the Operator's Manual and all safety signs before operating, servicing, adjusting, or cleaning the Mixer.
2. Do not allow riders on the machine during transport.
3. Install, close and secure all guards, shields and hoods before starting or operating.
4. Stop engine or motor, disconnect spark plug wire or unplug power cord, and wait for all moving parts to stop before servicing, adjusting, repairing, or cleaning.
5. Clear the area of all bystanders before starting.
6. Keep hands, feet, hair and clothing away from moving parts.
7. Keep working area clean and dry to prevent slipping and tripping.
8. Do not run the mixer in an explosive atmosphere or in a poorly ventilated or enclosed area.
9. Wear appropriate hearing protection when operating for long periods of time.
10. Always attach safety chain when towing.
11. Do not exceed a safe travel speed when towing. Slow down for corners and when going over rough terrain.
12. Review safety instructions with all operators annually.

#### **Gas engine powered units:**

- Do not place hands in the drum unless the engine is OFF and the spark plug wire is disconnected.
- Stay away from hot engine components during operation.
- Do not smoke when refueling gas engine.

#### **Electric motor-powered units:**

- Do not place hands in the drum unless the motor is OFF and the power cord unplugged.
- Have a licensed electrician wire up and provide power to the motor. • Only use a power cord that is grounded. • Always use an electrical cord with the required power carrying capacity.

Each operator should review this section of the manual when starting a project and as often as required to be familiar with the machine. When operating, follow this procedure:

1. Review and follow the Pre-Start and Pre-Operation checklists.
2. Review the location and function of all controls.
3. Determine ratio of the cement, lime, water and aggregate required for your mixture. Always use the same mixture ratio for each batch.
4. Be sure the mixing elements turn at 30 to 35 RPM for the paddles and 40 to 45 RPM for the spiral to insure proper mixing.
5. Starting machine:
  - A. Electric motor-powered units:
    - a. Check that everyone is clear of the machine.
    - b. Move power engagement clutch to the left to disengage the mixing elements.
    - c. Unlatch and open the hood.
    - d. Turn the power switch ON.
    - e. Close and latch the hood.

- f. Move power engagement clutch to the right to engage the mixing elements.

(204) Gas engine powered units:

- a. Check that everyone is clear of the machine.
- b. Pull the emergency stop switch out.
- c. Move power engagement clutch to the left to disengage the drive.
- d. Unlatch and open the engine compartment hood.
- e. Move the throttle into its midrange position.
- f. Close the choke if starting when the engine is cold.
- g. Turn the ignition switch to its RUN position.
- h. Pull sharply on the T bar rope to start the engine.
- i. Allow the engine to run for a couple of minutes to warm up.
- j. Open the choke to its fully open position when the engine is warm.
- k. Move the throttle to its maximum RPM position.
- l. Close and secure the engine compartment hood.
- m. Ease the power engagement clutch to the right to engage the mixing elements

**IMPORTANT**

Be sure the engine has been set to give a mixing element speed of 30 to 35 RPM for the paddles and 40 to 45 RPM for the spiral.

6. Stopping machine:

C. Electric motor-powered units:

- a. Move the power engagement clutch to the left to disengage the mixing elements.
- b. Empty the drum of the mortar mixture.
- c. Unlatch and open the hood.
- d. Turn the power switch OFF.
- e. Close and latch the hood.

D. Gas engine powered units:

- a. Move the power engagement clutch to the left to disengage the mixing elements.
- b. Empty the drum of the mortar mixture.
- c. Unlatch and open the hood.
- d. Move the throttle to its low idle position.
- e. Stop the engine by turning the switch OFF or depressing the kill switch or strap.
- f. Close and secure the engine compartment hood.

7. Emergency Stopping:

If an emergency arises, stop the machine by moving the power engagement clutch to the left to disengage the mixing elements and then pushing the kill switch in.

8. Machine placement:

Always place the Mixer in a location so the operator has easy access to the mixture ingredients when adding to the mixing drum. Always position to provide adequate clearance for the machine or equipment removing the concrete mixture from the mixing drum. On the electric motor models, route the power cord out of the way to prevent damage. Do not run the mixture in an explosive atmosphere or in a poorly ventilated or enclosed area.

9. Filling

When mixing mortar, follow this procedure:

- a. Clear the working area of unauthorized personnel.
- b. Start the motor or engine.
- c. Engage the mixing elements.
- d. Add half the required amount of water into the mixing drum.

Add sand and water until the desired consistency is obtained.

**NOTE**

The Mixer is equipped with a solid grill and bag splitter over the drum opening. Place the bag of material on the grill/splitter and let the material fall into the drum. Repeat with the next bag until the required amount is added.

- e. Add half the required amount of sand into the drum.
- f. Add the required mortar mix (cement, lime, etc.).
- g. Add the cement required for the batch.
- h. Add the rest of the water.
- i. Add the rest of the sand until the desired work- ability is obtained.
- j. Mix until there is an even consistency throughout the mixture. Look into the drum and watch until the mixture is the same color throughout. This means the mortar mix is evenly distributed throughout the mixture.
- k. Disengage the mixing clutch.
- l. Release the drum lock and slowly tilt the drum down to discharge the mixture.
- m. Raise the hinged grill out of the way when discharging the mixture.
- n. Move the drum back into its mixing position and lock. Immediately engage the mixing clutch and add half the water for the next batch. This will help to keep the drum and mixing elements clean and prevent lumps from forming in the mortar

#### 10. Mixing Time

After all the ingredients have been added to the drum, allow time for the material to reach a uniform color and consistency. Watch the color and consistency of the mixture as the drum is turning. When the entire mixture becomes a pale green color, it means the mortar mix is uniformly distributed throughout the mixture and can be discharged. If the mixture is not uniform, the mortar will have weak spots.

#### 11. Emptying drum:

All Mixers are equipped with a lock for anchoring the drum at the mixing angle. Move the wheelbarrow or other mortar receiver up to the side of the Mixer.

To empty the drum:

- a. Disengage mixing clutch.
- b. Release drum lock.
- c. Move the wheelbarrow into position.
- d. Slowly tilt the drum down.
- e. Lift the hinged grill out of the way.
- f. Fill the wheelbarrow.
- g. Raise the drum back into its mixing position and lock.
- h. Engage mixing clutch.
- i. Add half the water and sand for the next batch to clean elements from drum.

#### 12. Mixing Elements:

A Mixer can be equipped with paddles or a spiral for mixing the materials into a uniform mixture. Each system has adjustable wipers to clean the sides and ends of the drum. Maintain the wipers at 1/16 to 1/8 inch (1.5 to 3.0 mm) from the drum surface. A large gap can result in a build-up on the surface. This build-up will break loose and produce lumps or chips in the mixture.

#### 13. Preventing Build-up:

To maintain high quality mixing, consistent performance and machine life, thoroughly clean the mixer inside and out at the end of each day.

Under normal operating conditions, adding water and sand and some aggregate to the drum immediately after emptying will wash and clean the mixing elements and the inside of the drum and keep them clean providing the wipers are set at 1/16 to 1/8 inch (1.5 to 3 mm) from the drum surface. If a slow build-up is occurring, add water and coarse sand to the drum at the end of the working day and let it run for 15 minutes.

#### 14. Removing Build-up:

Always disable the machine by unplugging the power cord or disconnecting the spark plug wire. Dried mix should be scraped out as necessary. DO NOT strike the outside of the drum with a shovel, hammer or other device to break up and loosen any build-up, as this will dent and damage the drum. At the end of the working day, thoroughly wash the inside of the drum and the outside of the machine to remove any residue build-up or clumps. Do not get water on the electric motor or gas engine.

#### 15. Drum speed:

The best mixing action occurs when the mixing elements are turning 30 to 35 RPM for the paddles and 40 to 45 for the spiral. Do not operate outside of this speed range. Increasing the mixing element speed does not significantly change mixing characteristics. Mixing time is much more important and the mixture must be thoroughly blended to obtain uniform and consistent mortar.

#### 16. Capacities:

Each model has its own specified capacity. When that capacity is exceeded, the excess spills out of the drum making a mess of the working area and increases the required time for mixing. It is recommended to use an additional mixer if more mixing capacity is required.

#### 17. Power engaging clutch

Power Engaging Clutch: The power engaging clutch lever is located next to the drum tilting controls so it is convenient for the operator to stop the mixing elements when emptying the drum. The linkage in the power compartment must be set so the drive belt does not slip during operation and the operator must feel the lever go over-center as it fully engages. Always disengage the clutch when starting, stopped or emptying.



#### 18. Selection of Mortar type:

The performance of masonry is influenced by various mortar properties such as workability, bond strength, durability, extensibility and compression strength. Since these properties vary with mortar type, it is highly important that the mortar type selected for a particular application is the one that best meets the end-user requirements. Table 1 is a general guide for the selection of for various masonry wall construction. Selection of mortar type should also be based on the type of masonry units to be used as well as the applicable building code and engineering practice standard requirements such as allowable design stresses and lateral support.

#### 19. Guide for the selection of masonry Mortars

TABLE 1 MORTAR TYPE:

Location	Building Segment	Recommended Alternative	
Exterior, above grade	Loadbearing wall	N	S or M
	Non-loading wall, Parapet wall, chimney & veneer wall	N	O <sup>B</sup> or S
		N	S
Exterior, at or below grade	Foundation wall, retaining wall, manholes, sewers pavements walks and patios	M	S <sup>C</sup> or N <sup>C</sup>
Interior	Loadbearing wall	N	S or M
	Non loadbearing partitions.	O	N

A This table does not provide for many specialized mortars used, such as reinforced masonry, acid resistant and fire box mortars.

B Type O mortar is recommended for use where the masonry is unlikely to be frozen when saturated or unlikely to be subject to high winds or other significant lateral loads. Type N or S mortar should be used in other cases.

C Masonry exposed to weather in a nominally horizontal surface is extremely vulnerable to weathering. Mortar for such masonry should be selected with due caution.

TABLE 3 PROPERTY SPECIFICATION REQUIREMENTS

Mortar type	Average compressive strength at 28 days, min psi (MPa)	Water retention min %	Air content max %	Aggregate ratio (measured in damp loose conditions)
M	2500 (17.2)	75	12	Not less than 2 1/4 and not more than 3 1/2 times the sum of the separate volumes of cementitious materials.
S	1800 (12.4)	75	12	
N	750 (5.2)	75	14	
O	350 (2.4)	75	14	

## 20. Volumes & weights of materials

1 Bag of Cement	88 lb.	1 Bag of Cement	40 Kg
1 Cu. ft. Sand/Gravel	85-100 lb.	1 cu. meter Sand/Gravel	1360-1600 Kg
1Cu. ft. Plain Concrete	140-150 lb.	1 cu. meter Plain Concrete	2240-260 Kg
1 Cu. ft. Water	62-65 lb.	1-liter Water	1 kg
1 Imperial Gallon of Water	10 lb.	1 cu. meter Water	1000 kg
1 Cu. Yard		27 cu. ft. = 7646 cu. mt	

## 21. Operating hints:

- Keep the working area as clean and dry as possible to prevent slipping and tripping.
- Provide sufficient space around the machine for adding material to the drum and removing the mixture.
- Always add the materials in the same ratio to give a uniform mixture for mortar.
- Provide sufficient time to thoroughly combine the mixture to a uniform consistency before discharging from the drum.
- The water requirements for the mixture can vary depending on moisture content of the sand. Vary the amount of water in the mixture to give the consistency of the mortar desired.

## 4.7 TRANSPORTING

Crown Construction Mixers are designed to be easily and conveniently moved from place to place.

When moving the machine, follow this procedure:

1. On the larger Models, extend the pole to its full length.
2. Secure with the lock pin and retainer.
3. Use 2 men to lift the hitch and pull the Mixer to the new location.
4. Retract and lock the pole.

When transporting the machine, follow this procedure:

5. On the electric motor-powered units, unplug the power cord.
6. On gas engine powered units, open the hood and close the fuel valve to prevent flooding the carburetor.
7. Move the drum to its mixing position and lock.
8. Attach the optional lighting bar and secure.
9. On the larger Models, extend the hitch pole and secure with the lock pin and retainer.
10. Securely attach the machine to the towing vehicle.
11. Use a mechanical retainer through the ball hitch or the clevis pin.

**FUEL SHUT OFF VALVE**



## TRANSPORT SAFETY

1. Read and understand ALL the information in the Operator's Manual regarding procedures and SAFETY when operating the Mixer in the workplace and/or on the road.
2. Always travel at a safe speed. Use caution when making corners or on a rough surface.
3. Make sure all the lights and reflectors that are required by the local highway and transport authorities are in place, are clean and can be seen clearly by all overtaking and oncoming traffic.
4. Do not allow riders on any part of the machine during either road or highway travel.
5. Always use a safety chain between the Mixer and the towing vehicle when transporting.
6. Use a mechanical retainer through the ball hitch or clevis pin before transporting.
7. Ensure wheel nuts and axle hardware are tight.

**DRUM COMPLETELY RAISED**





12. Attach the safety chain to prevent unexpected separation. Cross the chains under the hitch for support.
13. Plug the wiring harness into the truck. Be sure all the lights are working.
14. Check that the wheel bolts are tightened to their specified torque.
15. Check that the tires are inflated to their required pressure.
16. Use special care when transporting during times of limited visibility. Be sure that you can be seen by oncoming and overtaking traffic. Always use the lighting bar.
17. Never exceed the speed appropriate for the terrain and conditions. Slow down for turns and when traveling over rough terrain.



Be sure the ball on the truck is the correct size for the hitch. Do not use an undersized ball with the hitch.



## 4.8 STORAGE



### STORAGE SAFETY

1. Store unit in an area away from human activity.
2. Do not permit children to play on or around the stored Mixer.

At the end of the season or when the machine will not be used for a period, inspect all major components of the Mixer. Repair or replace any worn or damaged components to prevent any unnecessary down time at the start of next project. When preparing for storage, follow this procedure:

1. Drain the fuel from gas tank.
2. Turn the fuel supply valve OFF or unplug the power cord.
3. Close and secure the hood.
4. Thoroughly wash the machine using a water hose or pressure washer to remove all dirt, dust or residue.
5. Inspect the inside of the drum. Chip out or break lose any build-up.
6. Lubricate all the grease fittings.
7. Rotate the drum so it is pointing straight down or in its emptying position.
8. Cover the machine with a tarpaulin and tie down if the machine is not stored inside.

### IMPORTANT

Do not get water on the electric motor or gas engine. Use an air hose to clean the motor or engine.

## MAINTENANCE SAFETY

1. Review the Operator's Manual and all safety items before working with, maintaining or operating the Mixer.
2. Stop engine or motor, disconnect spark plug wire or unplug power cord, and wait for all moving parts to stop before servicing, adjusting, repairing, or cleaning.
3. Follow good shop practices:  
Keep service area clean and dry. Be sure electrical outlets and tools are properly grounded. Use adequate light for the job at hand.
4. Keep hands, feet, clothing and hair away from all moving and/or rotating parts.
5. Do not place hands in the drum unless the engine is off and the spark plug wire is disconnected or the power cord is unplugged.
6. Do not attempt any adjustment or maintenance to any system of the Mixer unless the power source is disabled.
7. Make sure that all guards, shields and hoods are properly installed and secured before operating the Mixer.
8. Securely support the machine using blocks or safety stands before working beneath it or changing tires.
9. Store and transfer gasoline, solvents, cleaners or any flammable liquids only in safety standard approved containers.

## 5. SERVICE

### 5.1 SERVICE & MAINTENANCE

#### 5.1.1 FLUIDS & LUBRICANTS

1. Grease

Use an SAE multi-purpose high temperature grease or a multi-purpose lithium base grease.

2. Gasoline

Use a standard unleaded gasoline for all operating conditions.  
Do not use gasoline with an ethanol blend.

Capacities:

5.5 Honda: 0.95 US Gal (3.6 lts, 0.79 Imp Gal)



(204)

8.0 Honda: 1.59 US Gal (6.0 lts, 1.32 Imp Gal)

### 3. Engine Oil

Use an SAE 10W30 multi-viscosity oil meeting the American Petroleum Institute (API) classification of SF OR SG for normal operating temperatures. Consult the engine manual for unusual operating conditions. Do not mix oil types or viscosities. Crankcase Capacity: 5.5 hp: 0.53 US qtrs. (0.5 lts, 0.44 Imp qtrs..) 9.0 hp: 1.16 US qtrs. (1.1 lts, 1.94 Imp qtrs.)

### 4. Storing Lubricants and Fluids

Your machine can operate at top efficiency only if clean lubricants are used. Use clean containers to handle all fluids. Store them in an area protected from dust, moisture and other contaminants.

### 5.1.2 GREASING

Refer to section 5.1.1 for recommended grease. Use the Maintenance Checklist provided to keep a record of all scheduled maintenance.

### 5.1.3 SERVICING INTERVALS

#### Daily or 8 Hours

Check engine fluid levels. Top as required.

- a. Check engine oil level. Top up as required.
- b. Check fuel level. Add as required.
- c. Grease the drum assembly bearings (2 locations).
- d. Check the drive belt tension with the clutch engaged.
- e. Grease the clutch linkage shaft in the power compartment (1 location)
- f. Use an air hose to blow out and clean the engine, motor and compartment.

**CLUCTH LINKAGE**



**ENGINE FLUID LEVELS**



**DRUM BEARINGS**



**DRIVE BELT TENSION**



### Weekly or 50 Hours

#### Change the engine oil.

**IMPORTANT** Change more frequently if operating in high ambient temperatures or in very dusty or dirty conditions

- a. Drain plug.
- b. Fill plug.

#### Clean the engine air intake filter



#### Check the gearbox oil level using the drain plugs

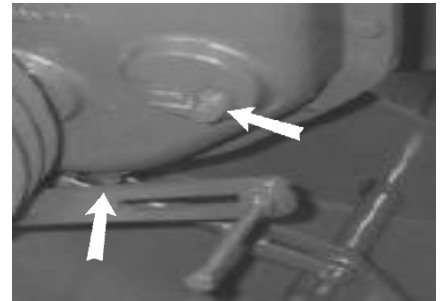

### Annually or 400 Hours

- a. Grease the electric motor bearings with 1/2 shot of grease (2 locations).
- b. Change gearbox oil
- c. Repack wheel bearings. (2 locations).
- d. Check wheel nut torque.
- e. Check axle mounting hardware.



### 5.1.4 SERVICE RECORD

See Lubrication and Maintenance sections for details of service. Copy this page to continue record.

ACTION CODE:      X CHECK                              C CHANGE                              CL CLEAN  
                             L LUBRICATE                              RE REMOVE                              R REPACK

HOURS SERVICED BY																				
MAINTENANCE																				
DAILY OR 8 HOURS																				
X Engine Fluid Levels																				
X Engine Oil Level & Fuel Level																				
X Drive Belt Tension																				
L Drum Assembly Bearings (2)																				
L Clutch Linkage Shaft (1)																				
CL Engine, Motor & Compartment																				
WEEKLY OR 50 HOURS																				
C Engine Oil, Drain Plug & Fill Plug																				
CL Engine Air Intake Filter																				
X Gearbox Oil Level																				
ANNUALLY OR 400 HOURS																				
L Electric Motor Bearings (2)																				
C Gearbox Oil																				
R Wheel Bearings (2)																				
X Wheel Nut Torque																				
X Check Axle Mounting Hardware																				

## 5.2 MAINTENANCE

By following a careful service and maintenance program for your machine, you will enjoy many years of trouble-free service.

### 5.2.1 ENGINE OIL CHANGING

1. Review the Operator's Manual for the engine.
2. Allow the engine to cool before changing oil. Hot oil can cause burns if it contacts exposed skin. Draining works best if the oil is warm.
3. Be sure the ignition switch is off and fuel valve is turned off.
4. Place a pan under the drain plug.
5. Remove the drain plug and allow oil to drain for 10 minutes.
6. Install the engine drain plug and tighten.
7. Dispose of the oil in an approved container.
8. Add the specified type and amount of motor oil. Refer to Section 5.1.1 or the engine manual.
9. Run the engine for 1 minute and check for leaks.
10. If leaks are found around the drain plug, tighten slightly and repeat Step 12.
11. Check engine oil level. Top up as required.

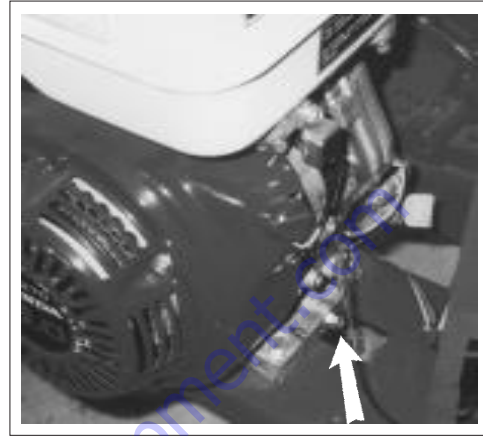

Fig. 30 ENGINE OIL CHANGING (DRAIN PLUG)

### 5.2.2 ENGINE SPEEDSETTING

Every engine is shipped from the engine factory without gas or oil because of fire hazards during shipping. They are all set with a high idle of 3500 RPM. Since no fluids are added at the Mixer factory, the RPM is not reset. When the Mixer is delivered, the fluids must be added and the RPM reset. To reset the RPM, follow this procedure:

1. Read the engine manual supplied with the machine.
2. Add fuel and the specified motor oil to the crankcase and oil to the gearbox.
3. Start the engine and run at wide open throttle.
4. Use a screwdriver to reset the high idle stop screw.
5. Count the mixing element revolutions to determine engine RPM. Set the engine speed to give 30-35 RPM for the paddles and 40-45 RPM for the spiral when mixing.
6. Load the drum and count the mixing element rotational speed again.
7. Reset if the speed changes as required

### 5.2.3 AIR CLEANER MAINTENANCE

Each engine is equipped with filter to remove dust and dirt from entering the air intake. To clean the filter, follow this procedure:

1. Read the engine manual supplied with the machine.
2. Unlatch and open the hood.
3. Remove the filter cover.
4. Remove filter and shake out.
5. Wash in a filter cleaning detergent if heavily caked with dirt. Allow time to dry before re-installing.
6. Replace filter after washing 5 times.
7. Install clean filter and secure cover.



### 5.2.4 BELT TENSION & ALIGNMENT

A drive belt and pulley system transmit power from the motor or engine to the gearbox for rotating the mixing elements. A clutch lever through an over center linkage swings the gearbox and pulley over to tighten and engage the drive. The belt tension must be properly set when the clutch is engaged to prevent slipping and the pulleys aligned to prevent belt wear. To set the tension and alignment, follow this procedure:

1. Unlatch and open hood.
2. Disable power source by unplugging power cord or disconnecting spark plug wire.
3. Remove the pins on each end of the linkage arm.
4. Lengthen or shorten linkage arm length by turning yokes on the threaded rod.
5. Repine linkage arm.
6. Engage clutch. There should be a definite feeling when the clutch linkage goes over center. If not readjust linkage.
7. The belt is properly tensioned when the mid-span deflects 1/4 inch (6 mm) when pushed on with a 10 lbs. force.
8. Align the pulleys by loosening the motor or engine mounting bolts.
9. Slide or tap the power unit into position to align the pulleys.
10. Tighten power unit mounting bolts to their specified torque.
11. Close and secure the hood.



Fig. 33 BELT TENSION AND ALIGNMENT



### 5.2.5 WIPER SPACING & REPLACEMENT

Each machine is equipped with wipers on the mixing elements to scrape the build-up from the inside of the drum. After extended use, they will wear. They need to be adjusted so they clean the sides of the drum. To adjust or repair, follow this procedure:

1. Thoroughly clean the inside of the drum to remove all the build-up.
2. Open hood and disable power source by unplugging power cord or removing spark plug wire.
3. To adjust wipers, loosen mounting bolts.
4. Tap or slide wipers to 1/16 inch (1.5 mm) from the drum.
5. Tighten mounting bolts to their specified torque.
6. If there is no more adjustment available, remove old wipers.
7. Replace wipers.
8. Set at 1/16 inch (1.5 mm) from the drum.
9. Tighten mounting bolts to their specified torque.

### 5.2.6 GEARBOX OILCHANGING

The gearbox transmits power from the belt/pulley drive to the mixing elements in the drum. As the gearbox breathes during its warming and cooling cycle, contaminants can enter through the breather. Change the oil annually to remove these contaminants

To change the oil, follow this procedure:

1. Open the hood.
2. Disable the power source by unplugging the power cord or removing the spark plug wire.
3. Place a pan under the drain plug.
4. Remove the drain, level and fill plugs and allow the oil to drain for 10 minutes.
5. Clean the drain plug.
6. Install the drain plug and tighten.
7. Add 1 quart of SAE 80W90 gear oil through the fill plug.
8. When the oil in the gearbox just fills the threads of the level plug, the gearbox is at the proper level.
9. Install the level and fill plugs and tighten.

#### NOTE

There is a filler in the top of the shroud (with a rubber plug) for gearbox oil filling and a drain in the bottom of it for oil replacement.

#### IMPORTANT

Allow the gearbox to cool before changing oil. Hot oil can cause burns if it contacts exposed skin. Draining works best if the oil is warm.

**PADDLE VIEW**



**SPIRAL VIEW**



**GEARBOX**

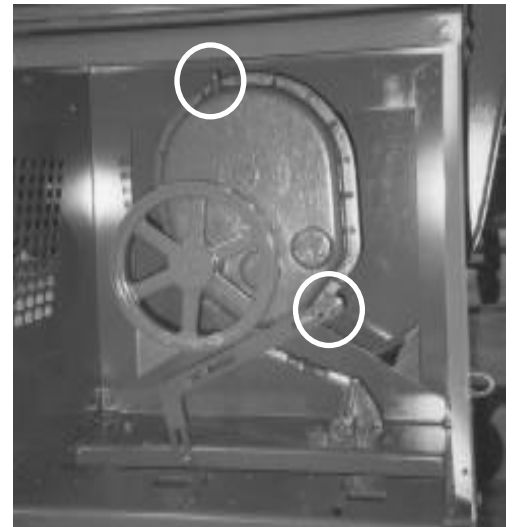



## 6. TROUBLE SHOOTING

The Crown Construction Mortar Mixer uses a large heavy-duty drum with mixing elements for combining water, cement, lime and sand into a mixture for forming mortar. It is a well-engineered machine that requires minimum maintenance. In the following trouble shooting section, we have listed many of the problems, causes and solutions to the problems which you may encounter.

If you encounter a problem that is difficult to solve, even after having read through this trouble shooting section, please contact your authorized dealer, distributor or the factory. Before you call, please have this Operator's Manual and the serial number from your machine ready.

PROBLEM	CAUSE	SOLUTION
Engine won't start.	No fuel.	Fill the fuel tank.
	Low engine oil.	Fill the crankcase with oil.
	Cold engine.	Open choke.
	Ignition switch off.	Turn ignition switch on.
	Kill switch off.	Pull kill switch out.
	Engine problem.	Refer to engine manual.
Motor won't run.	Power off.	Turn power ON at master panel.
		Trip breaker at master panel.
		Turn switch ON at motor.
	Overload switch tripped.	Reset overload switch on motor.
Mixing elements won't turn.	No power.	Turn power on.
		Start engine.
	Loose drive belt.	Adjust clutch linkage to tighten drive belt.
	Belt off pulleys.	Install belt and align pulleys.
Build-up on drum walls.	Wiper gap too large.	Adjust wiper gap to 1/16 to 1/8 inch (1.5 to 3 mm).
	Wipers worn out.	Replace wipers.
Lumps or chips in mortar.	Drum build-up breaking loose.	Clean build-up from drum walls and adjust wipers.

## 7. SPECIFICATIONS

Model	4S	S4S	6S	6SR/S6SR	6PR	8S/S8S	8P	10S	12S/S12S
Shaft R.P.M. Max:	38	46	38	38	38	32	32	32	32
Wrap Thickness:	10 USG	10 USG	10 USG	7 USG	1/4"	7USG	1/4"	7 USG	7 USG
End Plate Thickness:	7 USG	7 USG	7 USG	1/4"	1/4"	1/4"	1/4"	1/4"	1/4"
Drum Material:	Steel	Steel	Steel	Steel	Polymer	Steel	Polymer	Steel	Steel
Drum Width:	23-1/4"	23-1/4"	23-1/4"	23-1/4"	23-1/4"	29-5/8"	29-5/8"	29-5/8"	29-5/8"
Drum Height:	24"	24"	27-1/2"	27-1/2"	31"	31"	31"	31"	31"
Drum Length:	26 3/4"	26 3/4"	26 3/4"	26 3/4"	26 3/4"	25-3/16"	25-3/16"	29-13/16"	33-3/4"
Capacity Bags:	1 to 1-1/2	1 to 1-1/2	2 to 2-1/2	2 to 2-1/2	2 to 2-1/2	2-1/2 to 3	2-1/2 to 3	3 to 3-1/2	3-1/2 to 4
Capacity Cubic Feet:	4 cu ft	4 cu ft	6 cu ft	6 cu ft	6 cu ft	8 cu ft	8 cu ft	10 cu ft	12 cu ft
Overall Height:	42-1/2"	42-1/2"	46"	56"	56"	54-1/2"	54-1/2"	54-1/2"	56"
Overall Width:	29-1/2"	29-1/2"	29-1/2"	49"	49"	49"	49"	49"	59"
Charging Height:	36-1/2"	36-1/2"	41"	49"	49"	49"	49"	49"	59"
Length-TowPoleOut:	93"	93"	93"	93"	93"	93"	93"	97"	014"
Length-TowPoleIn:	65"	65"	65"	65"	65"	66"	66"	70"	83-1/2"
Tires (Pneumatic):	4.00 x 8	4.00 x 8	4.00 x 8	5.50 x 12	5.50 x 12	5.50 x 12	5.50 x 12	5.50 x 12	6.00 x 12
High Speed Bearings?	NO	No	No	Yes	Yes	Yes	Yes	Yes	Yes
Gear reduction System?	Yes	Yes	Yes	Yes	Yes	Yes	Yes	Yes	Yes

### ELECTRIC POWER

HP	1/2 Hp	1 Hp	1.5 Hp	1.5 Hp	2 Hp	2 Hp	3 Hp	3 Hp	5 Hp	5Hp
Volts	110/220	110/220	110/220	230/460	110/220	230/460	220	230/460	220	230/460
Phase	1	1	1	3	1	3	1	3	1	3
Amps	8.4/4.2	12.4/6.2	18.0/9.0	4.8/2.4	20.4/10.2	6.4/3.2	16	8.6/4.3	23	14.0/7.0

SPECIFICATIONS SUBJECT TO CHANGE WITHOUT NOTICE

## 7.2 HADWARE TORQUE

The tables shown below give correct torque values for various bolts and caps crews. Tighten all bolts to the torques specified in chart unless otherwise noted. Check tightness of bolts periodically, using bolt torque chart as a guide. Replace hardware with the same strength bolt.

### Imperial Torque Specifications

Bolt Dia. "A"	Bolt Torque*					
	SAE 2		SAE 5		SAE 8	
	Nm	ft.-lbs	Nm	ft.-lbs.	Nm	ft.-lbs
1/4	8	6	12	9	17	12
5/16	13	10	25	19	36	27
3/8	27	20	45	33	63	45
7/16	41	30	72	53	100	75
1/2	61	45	110	80	155	115
9/16	95	60	155	115	220	165
5/8	128	95	215	160	305	220
3/4	225	165	390	290	540	400
7/8	230	170	570	420	880	650
1	345	225	850	630	1320	970

### Metric Torque Specifications

Bolt Dia. "A"	Bolt Torque*			
	8.8		10.9	
	Nm	ft.-lbs	Nm	ft.-lbs
M4	3	2.2	4.5	3.3
M5	6	4	9	7
M6	10	7	15	11
M8	25	18	35	26
M10	50	37	70	52
M12	90	66	125	92
M14	140	103	200	148
M16	225	166	310	229
M20	435	321	610	450
M24	750	553	1050	774

SAE-2

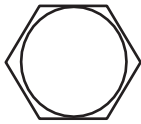

SAE-5



SAE-8

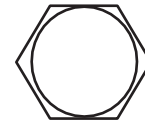

Torque figures indicated above are valid for non-greased or non-oiled threads and heads unless otherwise specified. Therefore, do not grease or oil bolts or caps crews unless otherwise specified in this manual. When using locking elements, increase torque values by 5%.

### WHEEL LUG NUT TORQUE:

Use the tightening pattern shown below, to ensure the even tightening of the lug nuts on each wheel.

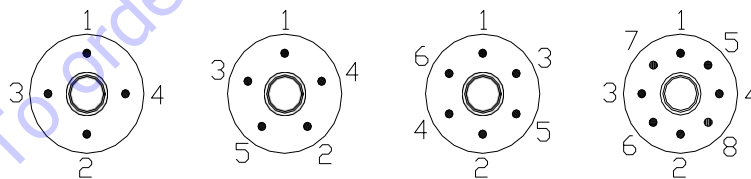

Bolt Diam	Bolt Torque	
	Nm	ft.-lbs.
1/2"	136	100
9/16"	203	150

\* Torque value for bolts and caps crews are identified by their head markings

**TO PURCHASE THIS PRODUCT PLEASE CONTACT US**



**Equipment Financing and  
Extended Warranties Available**



**Discount-Equipment.com is your online resource for  
commercial and industrial quality parts and equipment sales.**

**561-964-4949**

**visit us on line @ [www.discount-equipment.com](http://www.discount-equipment.com)**

Select an option below to find your Equipment

**Search by Manufacturer**

**Search by Product Type**

**Request a Quote**

We sell worldwide for the brands: Genie, Terex, JLG, MultiQuip, Mikasa, Essick, Whiteman, Mayco, Toro Stone, Diamond Products, Generac Magnum, Airman, Haulotte, Barreto, Power Blanket, Nifty Lift, Atlas Copco, Chicago Pneumatic, Allmand, Miller Curber, Skyjack, Lull, Skytrak, Tsurumi, Husquvarna Target, Stow, Wacker, Sakai, Mi-T-M, Sullair, Basic, Dynapac, MBW, Weber, Bartell, Bennar Newman, Haulotte, Ditch Runner, Menegotti, Morrison, Contec, Buddy, Crown, Edco, Wyco, Bomag, Laymor, EZ Trench, Bil-Jax, F.S. Curtis, Gehl Pavers, Heli, Honda, ICS/PowerGrit, IHI, Partner, Imer, Clipper, MMD, Koshin, Rice, CH&E, General Equipment, Amida, Coleman, NAC, Gradall, Square Shooter, Kent, Stanley, Tamco, Toku, Hatz, Kohler, Robin, Wisconsin, Northrock, Oztec, Toker TK, Rol-Air, APT, Wylie, Ingersoll Rand / Doosan, Innovatech, Con X, Ammann, Mecalac, Makinex, Smith Surface Prep, Small Line, Wanco, Yanmar