

**MORTAR MIXER
HYDRAULIC DRIVE/HYDRAULIC DUMP
MODELS 12SH AND 16SH**

OPERATOR'S MANUAL



www.Discount-Equipment.com

TO PURCHASE THIS PRODUCT PLEASE CONTACT US



**Equipment Financing and
Extended Warranties Available**



**Discount-Equipment.com is your online resource for
commercial and industrial quality parts and equipment sales.**

561-964-4949

visit us on line @ www.discount-equipment.com

Select an option below to find your Equipment

Search by Manufacturer

Search by Product Type

Request a Quote

We sell worldwide for the brands: Genie, Terex, JLG, MultiQuip, Mikasa, Essick, Whiteman, Mayco, Toro Stone, Diamond Products, Generac Magnum, Airman, Haulotte, Barreto, Power Blanket, Nifty Lift, Atlas Copco, Chicago Pneumatic, Allmand, Miller Curber, Skyjack, Lull, Skytrak, Tsurumi, Husquvarna Target, Stow, Wacker, Sakai, Mi-T-M, Sullair, Basic, Dynapac, MBW, Weber, Bartell, Bennar Newman, Haulotte, Ditch Runner, Menegotti, Morrison, Contec, Buddy, Crown, Edco, Wyco, Bomag, Laymor, EZ Trench, Bil-Jax, F.S. Curtis, Gehl Pavers, Heli, Honda, ICS/PowerGrit, IHI, Partner, Imer, Clipper, MMD, Koshin, Rice, CH&E, General Equipment, Amida, Coleman, NAC, Gradall, Square Shooter, Kent, Stanley, Tamco, Toku, Hatz, Kohler, Robin, Wisconsin, Northrock, Oztec, Toker TK, Rol-Air, APT, Wylie, Ingersoll Rand / Doosan, Innovatech, Con X, Ammann, Mecalac, Makinex, Smith Surface Prep, Small Line, Wanco, Yanmar

CROWN'S CONDITIONS OF SALES & LIMITED WARRANTY

All sales made by Crown Construction Equipment Division of ELJO Industries Inc. are subject to these conditions unless otherwise agreed in writing with a duly authorized officer of Crown. In all cases of conflict between these conditions and the requirements of the purchase order, these conditions shall prevail.

(1) SALES POLICY: Nothing herein shall be construed as abridging the right of Crown to sell directly or indirectly to: (a) Federal, State or Provincial Governments or Agencies thereof, or to Agencies employing Federal, State or Provincial Government aid; (b) Purchasers who buy Crown's products for sale as integral or assembled parts of their products; (c) Firms operating on a national scale; (d) Any other class of purchaser to whom Crown may from time to time, elect to sell.

(2) PRICES: All prices are F.O.B. our warehouses, freight allowance as specified on Distributor Net Price Lists. The suggested list prices and discounts schedules are established by Crown and are intended to act as a guide for our distributors. Unless otherwise stated in writing, prices are subject to change without notice and will be applied as in effect at time of shipment.

(3) (TERMS): Unless otherwise agreed upon in writing by an officer of Crown, all invoices become due and payable net 30 days following the date in invoice. Interest at the maximum legal rate will be charged on all overdue accounts. Minimum net charge per invoice is \$75.00

(4) CANCELLATION AND CHANGES: No orders or sales may be cancelled or changed without the consent of Crown. At Crown's option cancelled/changed orders are subject to payment of cancellation charges equal to all costs incurred by Crown up to the date of cancellation/change.

(5) DELAYED DELIVERIES: Crown shall not be liable for any delay of merchandise for any cause whatsoever.

(6) CLAIMS: All goods shall be deemed delivered to purchaser at the time they are placed in the hands of carrier and consigned to purchaser: loss, damage or destruction of any said merchandise is assumed by purchaser. No claims may be made for shortages unless made in writing within ten days from receipt of merchandise.

(7) RETURN OF GOODS: Written permission from Crown must be obtained before returning any merchandise. All transportation charges must be borne by the purchaser. Credit for returned goods will be based on the original price paid, less 20%. Special parts or custom-built items cannot be returned for credit.

(8) LIMITATION OF LIABILITY: Crown's liability on any claim of any kind, including negligence, for any loss or damage arising out of, connected with, or resulting from contract, or the performance or breach thereof, or the design, manufacture, sale, delivery, resale, installation, technical direction of installation, inspection, repair, operation or use of any equipment covered by or furnished under contract shall in no case exceed the price paid by the purchaser for the equipment. Crown also disclaims all purchaser for the equipment. Crown also disclaims all liability, whether in contract, tort, warranty, or otherwise, to any party other than purchaser.

(9) All Price Lists, Catalogues and other material shall remain the property of Crown and are subject to return on demand. The Suggested List Prices are established by Crown and are intended to act as a guide. All shipping weights shown are approximate.

LIMITED CROWN WARRANTY

For one year from date of purchase, Crown will replace or repair for the original purchaser, free of charge, any part or parts, found upon examination by any Crown Authorized Service Depot or by the Crown factory, to be defective in material or workmanship or both. Crown extends the warrantee for the drum bearings and seals on plaster/mortar mixers to "Lifetime" and agrees to furnish, free of charge, the seals and bearings only upon receipt of the defective parts and evaluation at the factory. Equipment and accessories not manufactured by Crown are warranted only to the extent of the original manufacturer's warranty. All transportation charges on parts submitted for replacement or repair under this warranty must be borne by the purchaser. For warranty service contact your nearest Crown Authorized Service Depot.

THERE IS NO OTHER EXPRESS WARRANTY, IMPLIED WARRANTIES, INCLUDING THOSE OF MERCHANTABILITY AND FITNESS FOR A PARTICULAR PURPOSE ARE LIMITED TO ONE YEAR FROM PURCHASE AND TO THE EXTENT PERMITTED BY LAW. LIABILITY FOR CONSEQUENTIAL DAMAGES UNDER ANY AND ALL WARRANTIES ARE EXCLUDED TO THE EXTENT EXCLUSION IS PERMITTED BY LAW. (THIS WARRANTY IS AN ADDITION TO ANY STATUTORY WARRANTY.)

CROWN CONSTRUCTION EQUIPMENT

MORTAR MIXER

WARRANTY REGISTRATION FORM & INSPECTION REPORT

WARRANTY REGISTRATION (please print)

This form must be filled out by the dealer and signed by both the dealer and the customer at the time of delivery.

Customer's Name _____	Distributor Name _____
Address _____	Address _____
City, State, Code _____	City, State, Code _____
Phone Number () _____	Check One: _____
Contact Name _____	Private _____
Mixer Model _____	Contractor <input type="checkbox"/>
Serial Number _____	Other <input type="checkbox"/>
Delivery Date _____	_____

I have thoroughly instructed the buyer on the above described equipment which review included the Operator's

DISTRIBUTOR INSPECTION REPORT

- ___ Tire Pressure Checked
- ___ Wheel Bolts Torqued
- ___ Mixing Shaft/Paddles Turn
- ___ Mixing Drum Pivots
- ___ Lubricate Machine
- ___ Check Hydraulic Oil Level
- ___ Check Engine Fluid Levels
- ___ Have Licensed Electrician Wire Motor And Provide Power

SAFETY

- ___ Safety Chain Attached
- ___ All Decals Installed
- ___ Review Operating And Safety Instructions

Manual content, equipment care, adjustments, safe operation and applicable warranty policy.

Date _____ Dealer's Rep. Signature _____

The above equipment and Operator's Manual have been received by me and I have been thoroughly instructed as to care, adjustments, safe operation and applicable warranty policy.

Date _____ Owner's Signature _____

WHITE	YELLOW	PINK
CROWN CONSTR. EQ.	DISTRIBUTOR	

TABLE OF CONTENTS

SECTION	DESCRIPTION	PAGE
A	Reporting Safety Defects	i
B	Proposition 65.....	ii
1	Introduction	1
2	Safety.....	2
2.1	General Safety.....	3
2.2	Operating Safety	4
2.3	Hydraulic Safety	4
2.4	Maintenance Safety	5
2.5	Transport Safety	5
2.6	Tire Safety	5
2.7	Storage Safety.....	5
2.8	Refueling Safety	6
2.9	Electrical Safety	6
2.10	Safety Signs.....	6
2.11	Sign-Off Form.....	7
3	Safety Sign Locations	8
4	Operation.....	11
4.1	To the New Operator or Owner	11
4.2	How The Machine Works.....	12
4.3	Pre-Operation Checklist	13
4.4	Pre-Start Procedures.....	13
4.5	Machine Break-In	14
4.6	Controls.....	15
4.7	Operating	17
4.8	Transporting	26
4.9	Storage	28
5	Service and Maintenance	29
5.1	Service	29
5.1.1	Fluids and Lubricants	29
5.1.2	Greasing	29
5.1.3	Servicing Intervals.....	30
5.1.4	Service Record	36
5.2	Maintenance.....	37
5.2.1	Engine Oil Changing.....	37
5.2.2	Engine Speed Setting.....	38
5.2.3	Air Cleaner Maintenance.....	39
5.2.4	Changing Hydraulic System Oil and Filter	40
5.2.5	Wiper Spacing and Replacement.....	41
5.2.6	Drum Packing Seal	42
6	Trouble Shooting	44
7	Specifications	45
7.1	Mechanical	45
7.2	Bolt Torque	46
7.3	Hydraulic Fitting Torque.....	47
8	Index.....	48

SECTION A

REPORTING SAFETY DEFECTS

CROWN CONSTRUCTION EQUIPMENT
330 Saulteaux Crescent
Winnipeg, Manitoba.
CANADA. R3H 0Z5

REPORTING SAFETY DEFECTS

If you believe that your vehicle has a defect which could cause a crash or could cause injury or death, you should immediately inform the National Highway Traffic Safety Administration (NHTSA) in addition to notifying Crown Construction Equipment.

If NHTSA receives similar complaints, it may open an investigation, and if it finds that a safety defect exists in a group of vehicles, it may order a recall and remedy campaign. However, NHTSA cannot become involved in any individual problems between you, your dealer or Crown Construction Equipment.

To contact NHTSA you may either call the Auto Safety Hotline, toll-free at 1-800-424-9393, (366-0123 in Washington, DC area) or write to:

NHTSA
U.S. DEPARTMENT of TRANSPORTATION
400 7th Street SW, (NSA-11)
Washington, DC 20590

You can also obtain other information about motor vehicle safety from the Hotline.

SECTION B



WARNING



CALIFORNIA - Proposition 65 Warning

Engine exhaust and some of its constituents and some dust created by power sanding, sawing, grinding, drilling and other construction activities contains chemicals known to the State of California to cause cancer, birth defects and other reproductive harm.

Some examples of these chemicals are:-

- Lead from lead-based paints
- Crystalline silica from bricks
- Cement and other masonry products
- Arsenic and chromium from chemically treated lumber

Your risk from these exposures varies, depending on how often you do this type of work. To reduce your exposure to these chemicals:

ALWAYS work in a well ventilated area, and work with approved safety equipment, such as dust masks that are specially designed to filter out microscopic particles.

1 INTRODUCTION

Congratulations on your choice of a Crown Construction Equipment Hydraulic Mortar Mixer to complement your construction operation. This equipment has been designed and manufactured to meet the needs of a discriminating buyer for the efficient mixing of mortar or plaster.

Safe, efficient and trouble free operation of your Crown Mortar Mixer requires that you and anyone else who will be operating or maintaining the Mixer, read and understand the Safety, Operation, Maintenance and Trouble Shooting information contained in the Operator's Manual.



This manual is applicable to all the Model 12SH and 16SH Hydraulic Mortar Mixers built by Crown Construction Equipment. Use the Table of Contents or Index as a guide when searching for specific information.

Keep this manual handy for frequent reference and to pass on to new operators or owners. Call your Crown Construction Equipment distributor or dealer if you need assistance or information.

OPERATOR ORIENTATION - The directions left, right, front and rear, as mentioned throughout this manual, are as seen from behind the machine and facing in the direction of towing.

2 SAFETY

SAFETY ALERT SYMBOL

This Safety Alert symbol means
ATTENTION! BECOME ALERT! YOUR
SAFETY IS INVOLVED!



The Safety Alert symbol identifies important safety messages on the Crown Mortar Mixer and in the manual. When you see this symbol, be alert to the possibility of personal injury or death. Follow the instructions in the safety message.

Why is SAFETY important to you?

3 Big Reasons

- Accidents Disable and Kill
- Accidents Cost
- Accidents Can Be Avoided

SIGNAL WORDS:

Note the use of the signal words DANGER, WARNING and CAUTION with the safety messages. The appropriate signal word for each message has been selected using the following guide-lines:

DANGER - Indicates an imminently hazardous situation that, if not avoided, will result in death or serious injury. This signal word is to be limited to the most extreme situations, typically for machine components that, for functional purposes, cannot be guarded.

WARNING - Indicates a potentially hazardous situation that, if not avoided, could result in death or serious injury, and includes hazards that are exposed when guards are removed. It may also be used to alert against unsafe practices.

CAUTION - Indicates a potentially hazardous situation that, if not avoided, may result in minor or moderate injury. It may also be used to alert against unsafe practices.

SAFETY

YOU are responsible for the SAFE operation and maintenance of your Concrete Mixer. YOU must ensure that you and anyone else who is going to operate, maintain or work around the Concrete Mixer be familiar with the operating and maintenance procedures and related SAFETY information contained in this manual. This manual will take you step-by-step through your working day and alerts you to all good safety practices that should be adhered to while operating the Mixer.

Remember, YOU are the key to safety. Good safety practices not only protect you but also the people around you. Make these practices a working part of your safety program. Be certain that EVERYONE operating this equipment is familiar with the recommended operating and maintenance procedures and follows all the safety precautions. Most accidents can be prevented. Do not risk injury or death by ignoring good safety practices.

- Mixer owners must give operating instructions to operators or employees before allowing them to operate the machine, and at least annually thereafter.
- The most important safety device on this equipment is a SAFE operator. It is the operator's responsibility to read and understand ALL Safety and Operating instructions in the manual and to follow these. All accidents can be avoided.
-

A person who has not read and understood all operating and safety instructions is not qualified to operate the machine. An untrained operator exposes himself and bystanders to possible serious injury or death.

- Do not modify the equipment in any way. Unauthorized modification may impair the function and/or safety and could affect the life of the equipment.

2.1 GENERAL SAFETY

1. Read and understand the Operator's manual and all safety signs before operating, maintaining, adjusting, servicing or cleaning the Mixer.



2. Only trained competent persons shall operate the Mixer. An untrained operator is not qualified to operate the machine.

3. Have a first-aid kit available for use, should the need arise and know how to use it.



4. Do not allow riders when towing.

5. Have a fire extinguisher available for use should the need arise and know how to use it.



Only trained competent persons shall operate the

- 6. Wear appropriate protective gear. This list includes, but is not limited to:
 - A hard hat
 - Protective boots with slip resistant soles
 - Protective goggles
 - Heavy gloves
 - Hearing protection



- 7. Stop engine, disconnect spark plug wire and wait for all moving parts to stop before servicing, adjusting, repairing or cleaning.

- 8. Wear appropriate hearing protection when operating for long periods of time.

- 9. Dust Hazard ~ Wear appropriate dust mask around this equipment.



- 10. Ventilation ~ Never operate any gas powered equipment in a poorly ventilated or enclosed area. Avoid prolonged breathing of exhaust gases.



- 11. Hot Surface ~ Avoid contact with hot exhaust system and engine. Allow to cool before performing repairs or service.



2.1 GENERAL SAFETY

- 12. Electrocutation Hazard ~ Always use proper size grounded extension cord. Inspect all extension cords for cuts, frayed wire and broken connectors. Do not use cords if not in good condition.



2.2 OPERATING SAFETY

1. Read and understand the Operator's Manual and all safety signs before operating, servicing, adjusting, or cleaning the Mixer.
2. Do not allow riders on the machine during transport.
3. Install, close and secure all guards, shields and hoods before starting or operating.
4. Stop engine and wait for all moving parts to stop before servicing, adjusting, repairing, or cleaning.
5. Clear the area of all bystanders before starting.
6. Keep hands, feet, hair and clothing away from moving parts.
7. Keep working area clean and dry to prevent slipping and tripping.
8. Keep all hydraulic lines, fittings, hoses and motors tight and free of leaks before using.
9. Do not run the mixer in an explosive atmosphere or in a poorly ventilated or enclosed area.
10. Wear appropriate hearing protection when operating for long periods of time.
11. Always attach safety chain when towing.
12. Do not exceed a safe travel speed when towing. Slow down for corners and when going over rough terrain.
13. Review safety instructions with all operators annually.

Gas engine powered units:

- Do not place hands in the drum unless the engine is OFF and the spark plug wire is disconnected.
- Stay away from hot engine components during operation.
- Do not smoke when refueling gas engine.

2.3 HYDRAULIC SAFETY

1. Make sure that all components in the hydraulic system are kept in good condition and are clean.
2. Replace any worn, cut, abraded, flattened or crimped hoses and steel lines.
3. Stop engine, disconnect spark plug wire and wait for all moving parts to stop before servicing, adjusting, repairing, or cleaning.
4. Do not attempt any makeshift repairs to the hydraulic lines, fittings or hoses by using tape, clamps or cements. The hydraulic system operates under extremely high-pressure. Such repairs will fail suddenly and create a hazardous and unsafe condition.

5. Wear proper hand and eye protection when searching for a high-pressure hydraulic leak. Use a piece of wood or cardboard as a backstop instead of hands to isolate and identify a leak.



6. If injured by a concentrated high-pressure stream of hydraulic fluid, seek medical attention immediately.

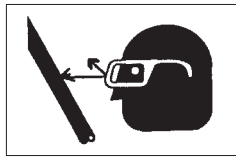

Serious infection or toxic reaction can develop from hydraulic fluid piercing the skin surface.

7. Before applying pressure to the system, make sure all components are tight and that lines, hoses and couplings are in good condition.

2.4 MAINTENANCE SAFETY

1. Review the Operator's Manual and all safety items before working with, maintaining or operating the Mixer.
2. Stop engine or motor, disconnect spark plug wire or unplug power cord, and wait for all moving parts to stop before servicing, adjusting, repairing, or cleaning.
3. Follow good shop practices:
4. Keep hands, feet, clothing and hair away from all moving and/or rotating parts.

- Keep service area clean and dry.
- Be sure electrical outlets and tools are properly grounded.
- Use adequate light for the job at hand.



5. Do not place hands in the drum unless the engine is off and the spark plug wire is disconnected or the power cord is unplugged.
6. Do not attempt any adjustment or maintenance to any system of the Mixer unless the power source is disabled.
7. Keep all hydraulic lines, fittings, hoses and motors tight and free of leaks before using.
8. Make sure that all guards, shields and hoods are properly installed and secured before operating the Mixer.
9. Securely support the machine using blocks or safety stands before working beneath it or changing tires.
10. Store and transfer gasoline, solvents, cleaners or any flammable liquids only in safety standard approved containers.
11. Establish and follow a lock out tag out procedure for the Mixer before working on machine.

2.5 TRANSPORT SAFETY

1. Read and understand ALL the information in the Operator's Manual regarding procedures and SAFETY when operating the Mixer in the workplace and/or on the road.
2. Always travel at a safe speed. Use caution when making corners or on a rough surface.
3. Make sure all the lights and reflectors that are required by the local highway and transport authorities are in place, are clean and can be seen clearly by all overtaking and oncoming traffic.
4. Do not allow riders on any part of the machine during either road or highway travel.
5. Always use a safety chain between the Mixer and the towing vehicle when transporting.
6. Use a mechanical retainer through the ball hitch or clevis pin before transporting.

2.6 TIRE SAFETY

1. Failure to follow proper procedures when mounting a tire on a wheel or rim can produce an explosion which may result in serious injury or death.
2. Do not attempt to mount a tire unless you have the proper equipment and experience to do the job.
3. Have a qualified tire dealer or repair service perform required tire maintenance.

2.7 STORAGE SAFETY

1. Store unit in an area away from human activity.
2. Do not permit children to play on or around the stored Mixer.

2.8 REFUELING SAFETY

1. Handle fuel with care. It is highly flammable.
2. Allow engine to cool for 5 minutes before refueling. Clean up spilled fuel before restarting engine.
3. Do not refuel the machine while smoking or when near open flame or sparks.
4. Always use an approved fuel container.
5. Fill fuel tank outdoors.
6. Prevent fires by keeping machine clean of accumulated trash, grease and debris.



2.9 ELECTRICAL SAFETY

1. Have a licensed electrician wire up and supply power to the electric motor.
2. Always use a grounded power cord with the required capacity to carry the power to the motor.
3. Route the power cord out of the way or protect from damage.
4. Establish and follow a lock out tag out procedure for the Mixer before working on machine.

5. Turn motor off, unplug power cord or turn off power at master panel and wait for all moving parts to stop before servicing, maintaining, adjusting or cleaning.
6. Keep all electrical components in good condition.

2.10 SAFETY SIGNS

1. Keep safety signs clean and legible at all times.
2. Replace safety signs that are missing or have become illegible.
3. Replaced parts that displayed a safety sign should also display the current sign.
4. Safety signs are available from your Distributor or the factory.

How to Install Safety Signs:

- Be sure that the installation area is clean and dry.
- Be sure temperature is above 50°F (10°C).
- Decide on the exact position before you remove the backing paper.
- Remove the smallest portion of the split backing paper.
- Align the sign over the specified area and carefully press the small portion with the exposed sticky backing in place.
- Slowly peel back the remaining paper and carefully smooth the remaining portion of the sign in place.
- Small air pockets can be pierced with a pin and smoothed out using the piece of sign backing paper.

2.11 SIGN-OFF FORM

Crown Construction Equipment follows the general Safety Standards specified by the Society of Automotive Engineers (SAE) and the Occupational Safety and Health Administration (OSHA). Anyone who will be operating and/or maintaining the Crown Hydraulic Mortar Mixer must read and clearly understand ALL Safety, Operating and Maintenance information presented in this manual.



C

WARNING

1. Read and understand Operator's Manual and safety signs before starting.
2. Stop engine, disconnect spark plug wire and wait for all moving parts to stop before servicing, maintaining, adjusting or cleaning.
3. Keep hands, feet, hair and clothing away from moving parts.
4. Install, close and secure all guards, shields and hoods before operating.
5. Do not place hands in the drum unless engine is OFF and spark plug wire is disconnected.
6. Stay away from hot engine components during operation.
7. Do not smoke when refueling.
8. Follow good safety procedures when handling fuel.
9. Do not operate in an explosive atmosphere or a poorly ventilated area without adequate ventilation.
10. Keep working area dry and clean to prevent slipping and tripping.
11. Always attach safety chain when towing.
12. Comply with applicable transporting regulations when towing.
13. Do not allow riders during transporting.
14. Do not exceed a safe travel speed when transporting. Slow down for corners and when going over rough terrain.

201001

REMEMBER - If Safety Signs have been damaged, removed, become illegible or parts replaced without safety signs, new signs must be applied. New safety signs are available from your authorized dealer.

3 SAFETY SIGN LOCATIONS

The types of safety signs and locations on the equipment are shown in the illustration below. Good safety requires that you familiarize yourself with the various Safety Signs, the type of warning and the area, or particular function related to that area, that requires your SAFETY AWARENESS.

- Think SAFETY! Work SAFELY!

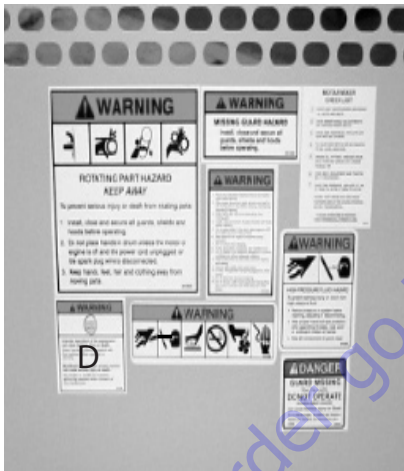

D

WARNING

Improper operation of this equipment can cause serious injury or death.
Read Operator's Manual supplied with this machine before operation or service.

Modification or alteration of this machine can cause serious injury or death.
Do not alter or modify this machine without the express written consent of the manufacturer.

201151

E

**USE
GASOLINE
FUEL ONLY**

201152

F

DANGER

**FIRE HAZARD
NO SMOKING**

To prevent serious injury or death from fire:

1. Do not smoke when refueling.
2. Keep sparks, flames and hot material away from flammable substances.

201005

REMEMBER - If Safety Signs have been damaged, removed, become illegible or parts replaced without safety signs, new signs must be applied. New safety signs are available from your authorized dealer.

3 SAFETY SIGN LOCATIONS

The types of safety signs and locations on the equipment are shown in the illustration below. Good safety requires that you familiarize yourself with the various Safety Signs, the type of warning and the area, or particular function related to that area, that requires your SAFETY AWARENESS.

- Think SAFETY! Work SAFELY!

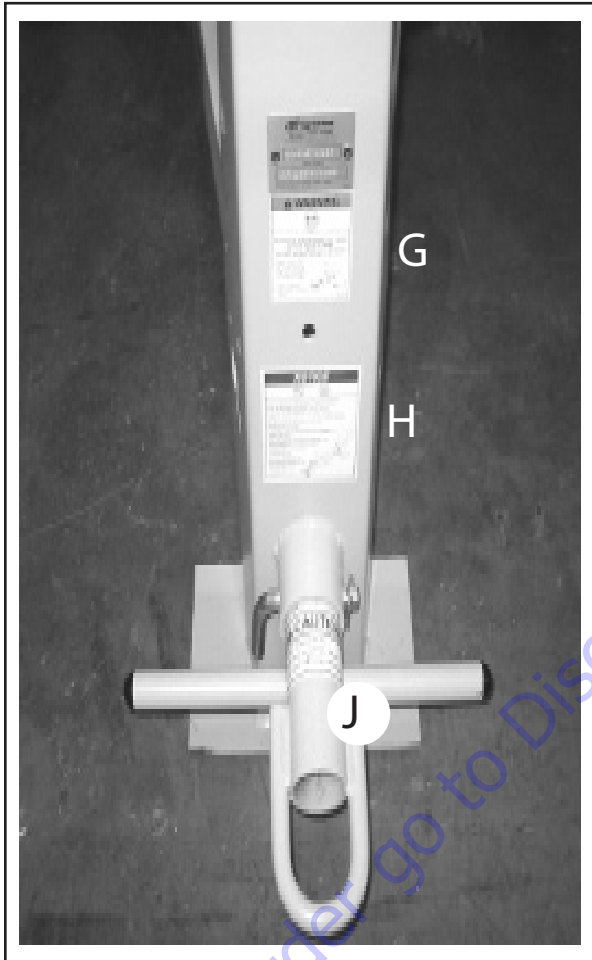

G

WARNING

105 km/h

Excessive towing speed can cause serious injury or death.
Do NOT exceed 65 mph (105 km/h)

1. Make certain that the wheel lug nuts and axle mounting hardware are tight.
2. Check pressure and overall condition of tires.

201151

H

NOTICE

- ◆ Ensure tow vehicle has towing capacity for the weight of this machine.
- ◆ Do not tow the machine unless the draw bar is bolted in place and the safety bolt on the end of the draw bar is securely fastened.
- ◆ Close engine fuel cutoff (where applicable) before towing mixer to prevent leakage into the engine crankcase.
- ◆ Use 2 people to lift and position hitch (pintle and ball) on and off tow vehicle.
- ◆ Securely attach hitch to towing vehicle - pintle or ball type coupler (ball type shown).
- ◆ Be certain ball clamp captures ball and lever or handwheel is fully clamped. Ensure use of safety pin through latch or handwheel (for ball type coupler).
- ◆ Safety chain attachment (see illustration) chains must cross under the draw bar and be positioned to prevent the draw bar from dropping to the ground in the event of a hitch failure.
- ◆ Connect lighting plug/electric brake plug (where applicable).
- ◆ Make certain that the wheel lug nuts and axle mounting hardware are tight.
- ◆ Check pressure and overall condition of tires.
- ◆ Test brakes (if applicable).

201150

J

CAUTION

Use 2 people to lift and position hitch on and off tow vehicle.

201155

REMEMBER - If Safety Signs have been damaged, removed, become illegible or parts replaced without safety signs, new signs must be applied. New safety signs are available from your authorized dealer.

3 SAFETY SIGN LOCATIONS

The types of safety signs and locations on the equipment are shown in the illustration below. Good safety requires that you familiarize yourself with the various Safety Signs, the type of warning and the area, or particular function related to that area, that requires your SAFETY AWARENESS.

- Think SAFETY! Work SAFELY!



K



L

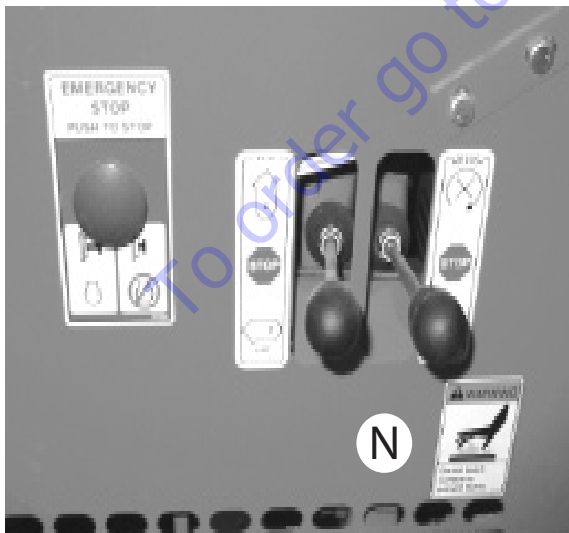

N

M



N



REMEMBER - If Safety Signs have been damaged, removed, become illegible or parts replaced without safety signs, new signs must be applied. New safety signs are available from your authorized dealer.

4 OPERATION



OPERATING SAFETY

1. Read and understand the Operator's Manual and all safety signs before operating, servicing, adjusting, or cleaning the Mixer.
 2. Do not allow riders on the machine during transport.
 3. Install, close and secure all guards, shields and hoods before starting or operating.
 4. Stop engine or motor, disconnect spark plug wire or unplug power cord, and wait for all moving parts to stop before servicing, adjusting, repairing, or cleaning.
 5. Clear the area of all bystanders before starting.
 6. Keep hands, feet, hair and clothing away from moving parts.
 7. Keep working area clean and dry to prevent slipping and tripping.
 8. Keep all hydraulic lines, fittings, hoses and motors tight and free of leaks before using.
 9. Do not run the mixer in an explosive atmosphere or in a poorly ventilated or enclosed area.
 10. Wear appropriate hearing protection when operating for long periods of time.
 11. Always attach safety chain when towing.
 12. Do not exceed a safe travel speed when towing. Slow down for corners and when going over rough terrain.
 13. Review safety instructions with all operators annually.
- Gas engine powered units:
- Do not place hands in the drum unless the engine is OFF and the spark plug wire is disconnected.
 - Stay away from hot engine components during operation.
 - Do not smoke when refueling gas engine.
- Electric motor powered units:
- Do not place hands in the drum unless the motor is OFF and the power cord unplugged.
 - Have a licensed electrician wire up and provide power to the motor.
 - Only use a power cord that is grounded.
 - Always use an electrical cord with the required power carrying capacity.
 - Establish and follow a lock out tag out procedure for the Mixer before working on machine.

4.1 TO THE NEW OPERATOR OR OWNER

The Crown Construction Equipment Hydraulic Mortar Mixer is designed to efficiently combine water, lime, aggregate and cement into a mixture for forming mortar. It is the responsibility of the operator to be familiar with the machine before starting.

It is the responsibility of the owner or operator to read this manual before starting. Follow all safety instructions exactly. Safety is everyone's business. By following recommended procedures, a safe working environment is provided for the operator, bystanders and the environment.

Many features incorporated into this machine are the result of suggestions made by customers like you. Read this manual carefully to learn how to operate the machine safely and how to set it to provide maximum mixing efficiency. By following the operating instructions in conjunction with a good maintenance program, your Mixer will provide many years of trouble-free service.

4.2 HOW THE MACHINE WORKS

The Mortar Mixer consists of a large tilting drum with internal rotating paddles or spiral blades for combining cement, lime, aggregate and water into a mixture for forming mortar. The enclosure on the back end houses the electric motor or gas engine and hydraulic system for turning the mixing elements.

control the drum dump and mixing element rotation. The on/off switch for the electric motor is also mounted on this side. The power source drives the hydraulic pump to turn the mixing elements. A reservoir and oil cooler are also located in the compartment.

Levers on the left side of the power compartment con-

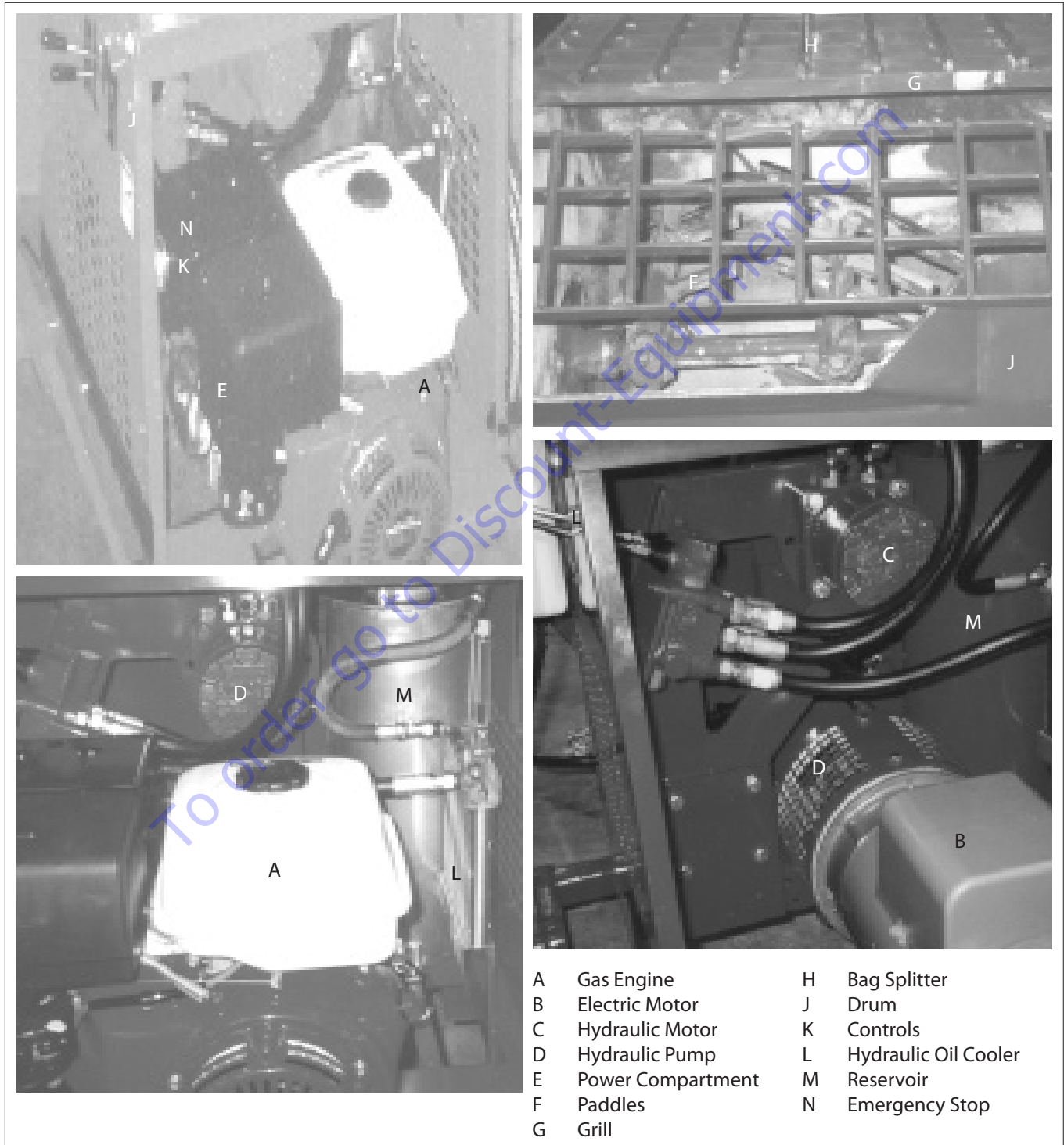

Fig. 1 MACHINE COMPONENTS

4.3 PRE-OPERATION CHECKLIST

Efficient and safe operation of the Mixer requires that

each operator reads and understands the operating procedures and all related safety precautions outlined in this section. A pre-operation checklist is provided for the operator. It is important for both personal safety and maintaining the good mechanical condition of the machine that this checklist is followed.

Before operating the Mixer and each time thereafter, the following areas should be checked off:

1. Gas Engine Units:
 - a. Check all fluid levels: fuel, engine oil and hydraulic oil. Refuel or top up oil as required.
 - b. Check the tires and be sure that they are inflated to the specified pressure.
 - c. Check the mixing element speed at maximum engine RPM. Be sure it is set to give a mixing element rotation speed of 30-35 RPM.
 - d. Use the emergency stop switch to stop the engine to be sure that it works. Repair or replace if it is not functioning.
 - e. Lubricate machine per Maintenance Section.
 - f. Close and secure all guards, shields and hoods.
2. Electric motor units:
 - a. Check hydraulic oil level. Top up as required.
 - b. Check the tires and be sure that they are inflated to the specified pressure.
 - c. Lubricate machine per Maintenance Section.
 - d. Close and secure all guards, shields and hoods.

4.4 PRE-START PROCEDURES

All machines are sent from the factory in a special shipping configuration to prevent spilling oil or gas. As a result, the following items must be done prior to starting the machine:

1. Gas engine powered units:
 - a. Fill the fuel tank with regular unleaded gas. Do not use an ethanol blend.
 - b. Check the engine crankcase. Refer to engine manual for oil specifications. Top up if required.

IMPORTANT

Engine warranty is void if the engine is run without oil.

- b. Check the oil in the hydraulic reservoir.
 - c. Fill the fuel tank with regular unleaded gas. Do not use an ethanol blend.
 - d. Start the engine and set the maximum speed to give a mixing element rotation speed of 30 to 35 RPM.

IMPORTANT

The engine is supplied from the engine manufacturer with the high idle speed set at approximately 3500 RPM and no gas or oil. Start engine, run at maximum RPM and check that the mixing elements turn at 30-35 RPM.

- e. Be sure the emergency stop switch is functioning properly.
2. Electric motor powered units:
 - a. Have a licensed electrician provide power to the motor. Use only a grounded cord with sufficient capacity to carry the required load.
 - b. Check the oil in the hydraulic reservoir.

4.5 MACHINE BREAK-IN

A special break-in procedure has been developed to insure the integrity of the machine when first starting. When using the machine for the first time, follow this procedure.

A. Before Starting:

1. Read the engine and Mixer Operator's Manuals.
2. Review and follow pre-start procedures before starting machine (Section 4.4).

B. At 1/2, 2, 5 and 10 hours:

1. Check all machine fluid levels: Fuel, engine oil and hydraulic oil. Refuel or top up as required.
2. Retorque wheel bolts.
3. Check for loose hardware. Tighten to specified torque.
4. Check hydraulic system for leaks. Tighten all leaking fittings and replace any leaking components.
5. Lubricate the points defined in the Maintenance section.
6. Then go to the service schedule as defined in the Maintenance section.

C. At 10 hours:

1. Change the engine oil. Replace with the specified oil.
2. Change the hydraulic system filter.
3. Then go to the oil replacement schedule as defined in the Maintenance section and engine manual.

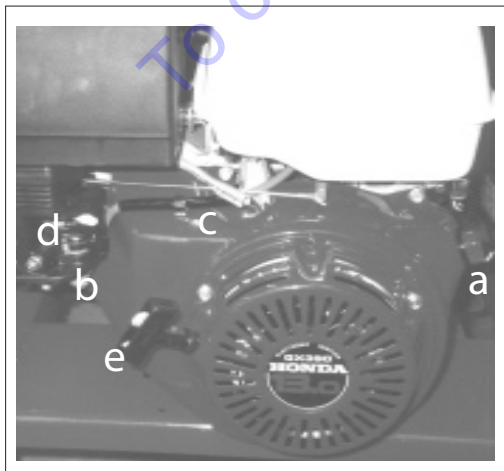

Fig. 2 ENGINE CONTROLS

4.6 CONTROLS

Before starting to work, all operators should familiarize themselves with the location and function of the controls.

1. Gas engine powered units:

A 13hp Honda engine option is available for use with the Mixer. Always read the engine Operator's Manual supplied with the machine for the detailed operating procedures for your engine.

a. Ignition switch:

This switch controls the electrical power to the engine electrical system. Turn the switch clockwise to turn the electrical system ON and the engine will run. Turn counterclockwise to stop the engine.

b. Fuel shutoff valves:

Each engine is equipped with a valve between the fuel tank and the carburetor. Slide the fuel valve toward the block to turn ON and away for OFF. Turn the fuel OFF when not in use or before transporting.

c. Throttle:

This lever controls the engine RPM. Move the lever laterally to increase or decrease the RPM. Always run at maximum throttle operating.

d. Choke:

The choke controls the fuel/air mixture to the engine. Close the choke when starting if the engine is cold. Open the choke as the engine warms. Always open the choke fully during operation.

e. Starting rope:

This retracting rope and T bar is used to turn the engine over for starting. Grasp the T bar firmly and pull the rope sharply to start the engine. Close the choke if the engine is cold.

f. Emergency stop Switch:

This push-pull switch shorts out the power to the engine ignition system and is located on the outside of the hood. Push the switch in to stop the engine and pull out to allow it to run.



Fig. 3 EMERGENCY STOP SWITCH

2. Electric Motor Powered Units:

a. Master ON/OFF:

This switch controls the power to the electric motor that turns the mixing elements in the drum. Depress the upper portion of the switch to turn the machine on and the bottom to turn off.

3. Drum Position:

This 3 position spring loaded to neutral center hydraulic valve controls the position of the mixing drum. Move the lever down and hold the lever to rotate the mixing drum down into the unloading position. Release the lever and the drum will stop moving. Move the lever up and hold to rotate the drum up into its filling and mixing position. Release the lever whenever the drum reaches its fully up or fully down position to prevent forcing the oil over relief.

4. Mixer Rotation:

This 3 position spring loaded to neutral center hydraulic valve controls the rotation of the mixing elements inside the mixing drum. Move the lever up into detent and it will remain in that position in detent while the mixing elements turn in the mixing drum. Move the lever to its centered neutral position to stop the mixing elements. Move the lever down and hold to run the mixing elements backwards. Normally this position is used to assist in unloading or emptying the mixing drum or to release a jam. Release the lever and its inner spring will return it to its centered neutral position and the mixing elements will stop moving.

5. Flow Control:

The hydraulic system is designed with a valve that controls the oil flow to the drum position circuit. Turn the valve clockwise to decrease the dump speed. Turn the valve counter-clock-wise to increase the dump speed. This valve should not be closed. If it is closed the dump circuit will work very slow or not at all.

NOTE

If you find that the rotating elements stop when you dump, then rotate flow control clockwise until unit dumps and rotates simultaneously as required. (Reducing flow to cylinder increases flow remaining for element rotation).



WARNING

Machine is shown with engine hood open for illustrative purposes only. Never operate with hood open.



Fig. 4 ELECTRIC MOTOR (TYPICAL)

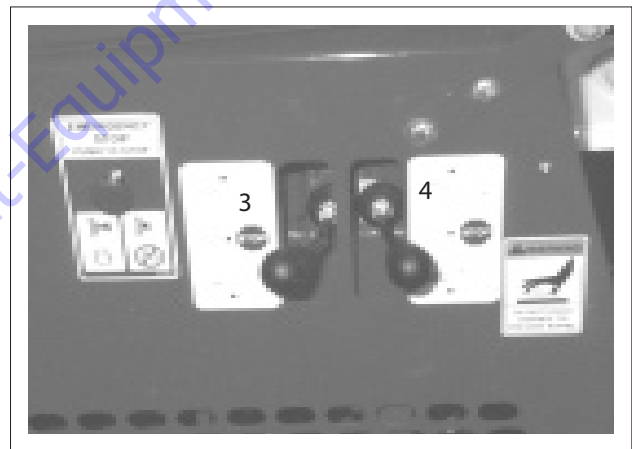

Fig. 5 HYDRAULIC LEVERS (TYPICAL)

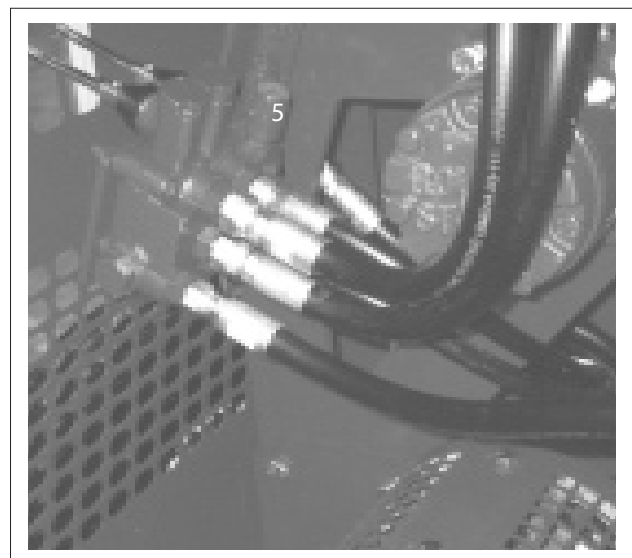

Fig. 6 FLOW CONTROL

4.7 OPERATING



OPERATING SAFETY

1. Read and understand the Operator's Manual and all safety signs before operating, servicing, adjusting, or cleaning the Mixer.
 2. Do not allow riders on the machine during transport.
 3. Install, close and secure all guards, shields and hoods before starting or operating.
 4. Stop engine or motor, disconnect spark plug wire or unplug power cord, and wait for all moving parts to stop before servicing, adjusting, repairing, or cleaning.
 5. Clear the area of all bystanders before starting.
 6. Keep hands, feet, hair and clothing away from moving parts.
 7. Keep working area clean and dry to prevent slipping and tripping.
 8. Keep all hydraulic lines, fittings, hoses and motors tight and free of leaks before using.
 9. Do not run the mixer in an explosive atmosphere or in a poorly ventilated or enclosed area.
 10. Wear appropriate hearing protection when operating for long periods of time.
 11. Always attach safety chain when towing.
 12. Do not exceed a safe travel speed when towing. Slow down for corners and when going over rough terrain.
 13. Review safety instructions with all operators annually.
- Gas engine powered units:
- Do not place hands in the drum unless the engine is OFF and the spark plug wire is disconnected.
 - Stay away from hot engine components during operation.
 - Do not smoke when refueling gas engine.
- Electric motor powered units:
- Do not place hands in the drum unless the motor is OFF and the power cord unplugged.
 - Have a licensed electrician wire up and provide power to the motor.
 - Only use a power cord that is grounded.
 - Always use an electrical cord with the required power carrying capacity.
 - Establish and follow a lock out tag out procedure for the Mixer before working on machine.

Each operator should review this section of the manual when starting a project and as often as required to be familiar with the machine. When operating, follow this procedure:

1. Review and follow the Pre-Start and Pre-Operation checklists.
2. Review the location and function of all controls.
3. Determine ratio of the cement, lime, water and aggregate required for your mixture. Always use the same mixture ratio for each batch.
4. Be sure the mixing elements turn at 30 to 35 RPM to insure proper mixing.
5. Starting machine:
 - A. Electric motor powered units:
 - a. Check that everyone is clear of the machine.
 - b. Place hydraulic levers in their centered neutral position.
 - c. Turn the power switch ON.
 - d. Move the mixing element lever up into its detent position.
 - B. Gas engine powered units:
 - a. Check that everyone is clear of the machine.
 - b. Pull the emergency stop switch out.

- c. Place hydraulic levers in their centered neutral position.
- d. Unlatch and open the engine compartment hood.
- e. Move the throttle into its midrange position.
- f. Close the choke if starting when the engine is cold.
- g. Turn the ignition switch to its RUN position.
- h. Pull sharply on the T bar rope to start the engine.
- i. Allow the engine to run for a couple of minutes to warm up.
- j. Open the choke to its fully open position when the engine is warm.
- k. Move the throttle to its maximum RPM position.
- l. Close and secure the engine compartment hood.
- m. Move the mixing element lever up into its detent position.

6. Stopping machine:

A. Electric motor powered units:

- a. Move the mixing lever to its centered off position.
- b. Empty the drum of the mortar mixture.



Fig. 7 ELECTRIC UNIT



Fig. 8 GAS ENGINE

- c. Turn the power switch OFF.
- B. Gas engine powered units:
- a. Move the mixing lever to its centered off position.
 - b. Empty the drum of the mortar mixture.

NOTE

Reverse the mixing elements to help empty the drum if required.

- c. Unlatch and open the hood.
 - d. Move the throttle to its low idle position.
 - e. Stop the engine by turning the switch OFF or depressing the emergency stop switch.
 - f. Close and secure the engine compartment hood.
7. Emergency Stopping:
If an emergency arises, stop the machine by depressing the emergency stop switch for the gas engine model or the stop switch for the electric power model.
8. Machine placement:
Always place the Mixer in a location so the operator has easy access to the mixture ingredients when adding to the mixing drum. Always position to provide adequate clearance for the machine or equipment removing the mortar mixture from the mixing drum. On the electric motor models, route the power cord out of the way to prevent damage. Do not run the mixture in an explosive atmosphere or in a poorly ventilated or enclosed area.
9. Filling:
When mixing mortar, follow this procedure:
- a. Clear the working area of unauthorized personnel.
 - b. Start the motor or engine.
 - c. Engage the mixing elements. Be sure the lever is in detent.
 - d. Add half the required amount of water into the mixing drum.
 - e. Add half the required amount of sand into the drum.
 - f. Add the required mortar mix (cement, lime, etc.).

NOTE

Reverse the mixing elements to help empty the drum if re-

- g. Add the cement required for the batch.
- h. Add the rest of the water.
- i. Add the rest of the sand until the desired workability is obtained.

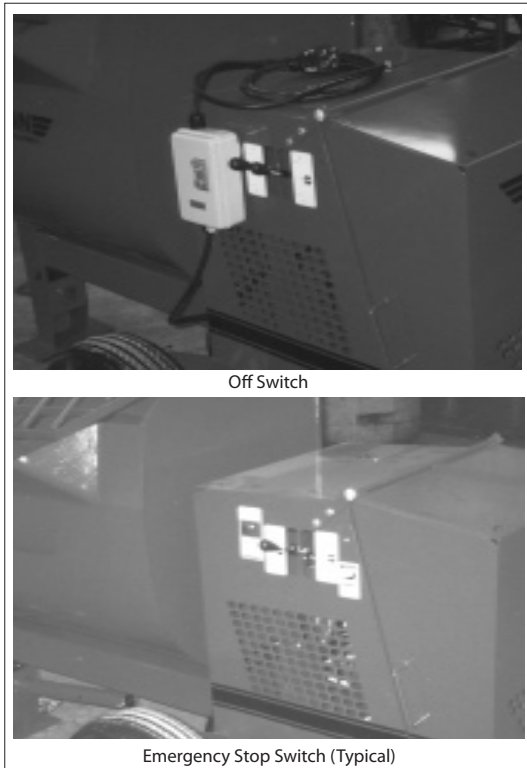

Fig. 9 STOPPING



Fig. 10 FILLING

NOTE

The Mixer is equipped with a solid grill and bag splitter over the drum opening. Place the bag of material on the grill/splitter and let the material fall into the drum. Repeat with the next bag until the required amount is added.

- j. Mix until there is an even consistency throughout the mixture. Look into the drum and watch until the mixture is the same color throughout. This means the mortar mix is evenly distributed throughout the mixture.
 - k. Move the mixing element control lever to its centered off position.
 - l. Move the drum tilt control lever down to discharge the mixture.
 - m. Move the drum back into its mixing position. Immediately start the mixing elements and add half the water for the next batch. This will help to keep the drum and mixing elements clean and prevent lumps from forming in the mortar.
10. Mixing time:
After all the ingredients have been added to the drum, allow time for the material to reach a uniform color and consistency. Watch the color and consistency of the mixture as the drum is turning. When the entire mixture becomes a pale green color, it means the mortar mix is uniformly distributed throughout the mixture and can be discharged. If the mixture is not uniform, the mortar will have weak spots.
11. Emptying drum:
- a. Move the wheelbarrow or other mortar receiver up to the discharge side of the drum.
 - b. Stop the mixing elements.

NOTE

Add sand a little at a time until the desired consistency is obtained.

- c. Move the tilt lever down and hold until the drum is at the desired position.
- d. Wait while the mortar flows into the wheelbarrow.
- e. Reverse the mixing elements momentarily to help empty the drum if required.
- f. When the drum is empty, raise the drum back into its filling and mixing configuration.
- g. Start the mixing elements.
- h. Add half the water and sand for the next batch. This will help to clean the mixing elements and the inside of the drum.

12. Mixing Elements:

A Mixer can be equipped with paddles or a spiral for mixing the materials into a uniform mixture. Each system has adjustable wipers to clean the sides and ends of the drum. Maintain the wipers at 1/16 to 1/8 inch (1.5 to 3.0 mm) from the drum surface. A large gap can result in a build-up on the surface. This build-up will break loose and produce lumps or chips in the mixture.

13. Cleaning:

Under normal operating conditions, adding water and sand and some aggregate to the drum immediately after emptying will wash and clean the mixing elements and the inside of the drum and keep them clean providing the wipers are set at 1/16 to 1/8 inch (1.5 to 3 mm) from the drum surface.

14. Drum speed:

The best mixing action occurs when the mixing elements are turning 30 to 35 RPM. Do not operate outside of this speed range. Increasing the mixing element speed does not significantly change mixing characteristics. Mixing time is much more important and the mixture must be thoroughly blended to obtain uniform and consistent mortar.

15. Capacities:

Each model has its own specified capacity. When that capacity is exceeded, the excess spills out of the drum making a mess of the working area and increases the required time for mixing. It is recommended to use an additional mixer if more mixing capacity is required.

NOTE

On the larger models, a full drum can fill more than one wheelbarrow. Change wheelbarrows until the drum is empty.



Fig. 11 EMPTYING DRUM



Paddles

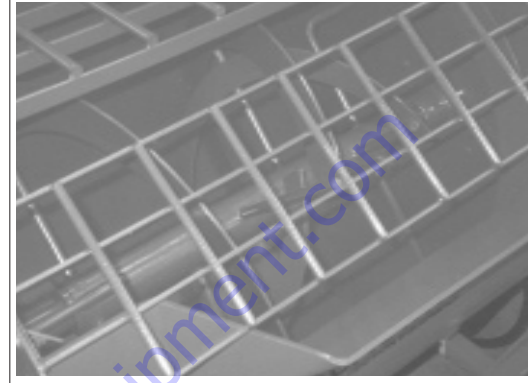

Spiral

Fig. 12 MIXING ELEMENTS

if a slow build-up is occurring, add water and coarse sand to the drum at the end of the working day and let it run for 15 minutes. If the coarse aggregate does not remove the build-up, disable the machine by unplugging the power cord or disconnecting the spark plug wire and using a hammer and chisel to break the build-up loose. Add water and sand and run until all the build-up has broken loose. Wash the drum out thoroughly to remove all the chips. Adjust the wipers as required.

At the end of the working day, thoroughly wash the inside of the drum and the outside of the machine to remove any residue build-up or clumps. Do not get water on the electric motor

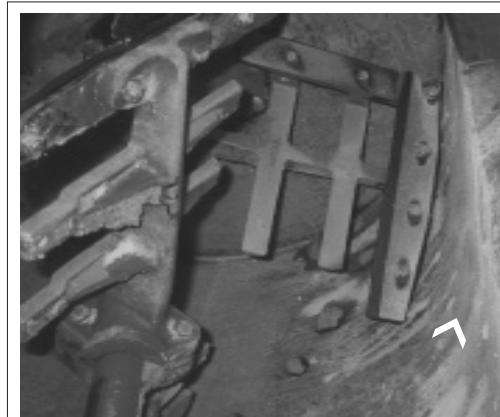

Paddles

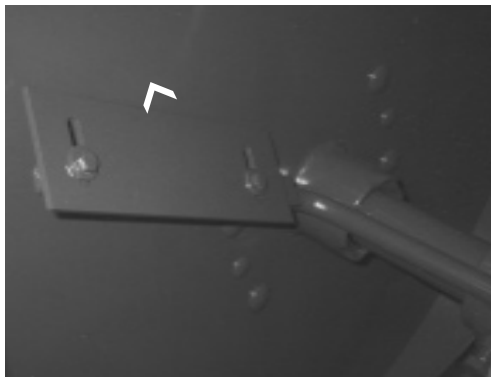

Spiral

Fig. 13 WIPER CLEARANCE

Table 1 Capacity Bags

S12SH	S16SH
S12 PH	S16PH
3-4	4 1/2-5 1/2

16. Hydraulic Drive System:

The Mixer is designed with a hydraulic system that provides power to the mixing elements and the tilt functions. All hydraulic components are contained within the power compartment. The system requires little maintenance except for checking the oil level. Generally a system that requires oil has a leak. Tighten any fitting that is leaking or replace any components that are leaking. Do not operate with any oil leaks to prevent contaminating the workplace.

! WARNING

Machine is shown with engine hood open for illustrative purposes only. Never operate with hood open.

! WARNING

HIGH-PRESSURE FLUID HAZARD
To prevent serious injury or death from high-pressure fluid:

1. Relieve pressure on system before repairing or adjusting or disconnecting.
2. Wear proper hand and eye protection when searching for leaks. Use wood or cardboard instead of hands.
3. Keep all components in good repair.

201022

17. Selection of Mortar type:

The performance of masonry is influenced by various mortar properties such as workability, bond strength, durability, extensibility and compression strength. Since these properties vary with mortar type, it is highly important that the mortar type selected for a particular application is the one that best meets the end-user requirements. Table 2 is a general guide for the selection of for various masonry wall construction. Selection of mortar type should also be based on the type of masonry units to be used as well as the applicable building code and engineering practice standard requirements such as allowable design stresses and lateral support.



Electric Motor



Gas Engine

Fig. 14 HYDRAULIC SYSTEM

18. Guide for the selection of masonry Mortars^A

TABLE 2 MORTAR TYPE:

Location	Building Segment	Recommended Alternative	
Exterior, above grade	Loadbearing wall	N	S or M
	Non-loading wall, Parapet wall, chimney & veneer wall	N	O ^B or S
		N	S
Exterior, at or below grade	Foundation wall, retaining wall, manholes, sewers pavements walks and patios	M	S ^C or N ^C
Interior	Loadbearing wall	N	S or M
	Non loadbearing partitions.	O	N

^A This table does not provide for many specialized mortar used, such as reinforced masonry, acid resistant and fire box mortars.

^B Type O mortar is recommended for use where the masonry is unlikely to be frozen when saturated or unlikely to be subject to high winds or other significant lateral loads. Type N or S mortar should be used in other cases.

^C Masonry exposed to weather in a nominally horizontal surface is extremely vulnerable to weathering. Mortar for such masonry should be selected with due caution.

TABLE 3 MORTAR PROPORTIONS BY VOLUME

Mortar type	Parts by volume of Portland cement	Parts by volume of hydrated lime	Aggregate ratio (measured in damp, loose conditions)
M	1	1/4	Not less than 2 1/4 and not more than 3 times the sum of the volumes of cement and lime used.
S	1	Over 1/4 to 1/2	
N	1	Over 1/2 to 1 1/4	
O	1	Over 1 1/4 to 2 1/2	

TABLE 4 PROPERTY SPECIFICATION REQUIREMENTS

Mortar type	Average compressive strength at 28 days, min psi (MPa)	Water retention min %	Air content max %	Aggregate ratio (measured in damp loose conditions)
M	2500 (17.2)	75	12	Not less than 2 1/4 and not more than 3 1/2 times the sum of the separate volumes of cementitious materials.
S	1800 (12.4)	75	12	
N	750 (5.2)	75	14	
O	350 (2.4)	75	14	

19. Volumes and weights of materials:

1 Bag of Cement	88 lb	1 Bag of Cement	40 Kg
1 Cu. ft. Sand/Gravel	85-100 lb	1 Cu. metre Sand/Gravel	1360-1600 Kg
1Cu. ft. Plain Concrete	140-150 lb	1Cu. metre Plain Concrete	2240-260 Kg
1 Cu. ft. Water	62-65 lb	1 litre Water	1 kg
1 Imperial Gallon of Water	10 lb	1 Cu. metre Water	1000 kg
1 Cu. Yard		27 cu. ft. = 7646 cu. metre	

20. Operating Environment:

It is the responsibility of the operator to use the gas engine machine in an open area with good air flow and ventilation to eliminate the chance of asphyxiation from exhaust fumes. All gas engines produce carbon monoxide gas in their exhaust that is deadly in small concentrations. Never operate the machine inside a building or enclosed area unless ample ventilation is provided.



21. Operating hints:

- Keep the working area as clean and dry as possible to prevent slipping and tripping.
- Provide sufficient space around the machine for adding material to the drum and removing the mixture.
- Always add the materials in the same ratio to give a uniform mixture for mortar.
- Provide sufficient time to thoroughly combine the mixture to a uniform consistency before discharging from the drum.
- The water requirements for the mixture can vary depending on moisture content of the sand. Vary the amount of water in the mixture to give the consistency of the mortar desired.
- Do not operate the machine when there are leaks in the hydraulic system. Leaks can contaminate the workplace.

4.8 TRANSPORTING



TRANSPORT SAFETY

- Read and understand ALL the information in the Operator's Manual regarding procedures and SAFETY when operating the Mixer in the workplace and/or on the road.
- Always travel at a safe speed. Use caution when making corners or on a rough surface.
- Make sure all the lights and reflectors that are required by the local highway and transport authorities are in place, are clean and can be seen clearly by all overtaking and oncoming traffic.
- Do not allow riders on any part of the machine during either road or highway travel.
- Always use a safety chain between the Mixer and the towing vehicle when transporting.
- Use a mechanical retainer through the ball hitch or clevis pin before transporting.



Fig. 15 EXTENDED POLE

Crown Construction Mixers are designed to be easily and conveniently moved from place to place.

When moving the machine, follow this procedure:

1. Place the drum in its mixing position.
2. On the larger Models, extend the pole to its full length.
3. Install the optional lighting package and wiring harness. Be sure to tie up harness to prevent dragging on the ground.
4. Secure with the lock pin and retainer bolt.
5. Use 2 men to lift the hitch and pull the Mixer to the new location.
4. Retract and lock the pole.
5. On the electric motor powered units, unplug the power cord.
6. On gas engine powered units, open the hood and close the fuel valve to prevent flooding the carburetor.
9. Securely attach the machine to the towing vehicle.
10. Use a mechanical retainer through the ball hitch or the pintle hitch.

 **WARNING**

Machine is shown with engine hood open for illustrative purposes only. Never operate with hood open.

IMPORTANT

Be sure the ball on the truck is the correct size for the hitch. Do not use an undersized ball with the hitch.



Fig. 16 OPTIONAL LIGHTING PACKAGE

11. Attach the safety chain to prevent unexpected separation. Cross the chains under the hitch for support.
12. Plug the wiring harness into the truck. Be sure all the lights are working.
13. Check that the wheel bolts are tightened to their specified torque.
14. Check that the tires are inflated to their required pressure.
15. Use special care when transporting during times of limited visibility. Be sure that you can be seen by oncoming and overtaking traffic. Always use the lighting bar.
16. Never exceed the speed appropriate for the terrain and conditions. Slow down for turns and when traveling over rough terrain.

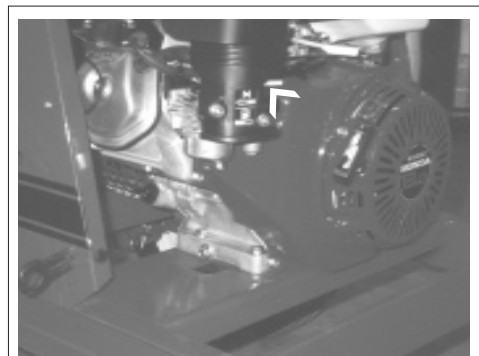

Fig. 17 FUEL SHUT OFF VALVE (TYPICAL)



Fig. 18 ATTACHMENT

4.9 STORAGE



STORAGE SAFETY

1. Store unit in an area away from human activity.
2. Do not permit children to play on or around the stored Mixer.

At the end of the season or when the machine will not be used for a period, inspect all major components of the Mixer. Repair or replace any worn or damaged components to prevent any unnecessary down time at the start of next project. When preparing for storage, follow this procedure:

1. Drain the fuel from gas tank.
2. Turn the fuel supply valve OFF or unplug the power cord.
3. Close and secure the hood.
4. Thoroughly wash the machine using a water hose or pressure washer to remove all dirt, dust or residue.

IMPORTANT

Do not get water on the electric motor or gas engine. Use an air hose to clean the motor or engine.

5. Inspect the inside of the drum. Chip out or break loose any build-up.
6. Lubricate all the grease fittings.
7. Rotate the drum so it is pointing straight down or in its emptying position and lock in place.
8. Cover the machine with a tarpaulin and tie down if the machine is not stored inside.



Fig. 19 STORED

5 SERVICE AND MAINTENANCE



MAINTENANCE SAFETY

1. Review the Operator's Manual and all safety items before working with, maintaining or operating the Mixer.
2. Stop engine or motor, disconnect spark plug wire or unplug power cord, and wait for all moving parts to stop before servicing, adjusting, repairing, or cleaning.
3. Follow good shop practices:
 - Keep service area clean and dry.
 - Be sure electrical outlets and tools are properly grounded.
 - Use adequate light for the job at hand.
4. Keep hands, feet, clothing and hair away from all moving and/or rotating parts.
5. Do not place hands in the drum unless the engine is off and the spark plug wire is disconnected or the power cord is unplugged.
6. Do not attempt any adjustment or maintenance to any system of the Mixer unless the power source is disabled.
7. Keep all hydraulic lines, fittings, hoses and motors tight and free of leaks before using.
8. Make sure that all guards, shields and hoods are properly installed and secured before operating the Mixer.
9. Securely support the machine using blocks or safety stands before working beneath it or changing tires.
10. Store and transfer gasoline, solvents, cleaners or any flammable liquids only in safety standard approved containers.
11. Establish and follow a lock out tag out procedure for the Mixer before working on machine.

5.1 SERVICE

5.1.1 FLUIDS AND LUBRICANTS

1. Grease:
Use an SAE multipurpose high temperature grease or a multipurpose lithium base grease.
2. Gasoline:
Use a standard unleaded gasoline for all operating conditions. Do not use gasoline with an ethanol blend.
Capacity: 1.7 gal
3. Engine oil:
Use an SAE 10W30 multi-viscosity oil meeting the American Petroleum Institute (API) classification of SF OR SG for normal operating temperatures. Consult the engine manual for unusual operating conditions. Do not mix oil types or viscosities.
Crankcase Capacity: 1.1 l (1.16 US qt, 1.94 Imp pt)
4. Hydraulic Oil:
Crown recommends SAE 20W50 motor oil for use in the hydraulic system. For sustained cold weather operation use Mobil Fluid 424, Shell Donax TD or TDL or PetroCan DuraTran.

5. Storing Lubricants and Fluids:
Your machine can operate at top efficiency only if clean lubricants are used. Use clean containers to handle all fluids. Store them in an area protected from dust, moisture and other contaminants.

5.1.2 GREASING

Refer to section 5.1.1 for recommended grease. Use the Maintenance Checklist provided to keep a record of all scheduled maintenance.

1. Use only a hand-held grease gun for all greasing. An air-powered greasing system can damage the seals on bearings and lead to early failures.
2. Wipe grease fitting with a clean cloth before greasing to avoid injecting dirt and grit.
3. Replace and repair broken fittings immediately.
4. If fittings will not take grease, remove and clean thoroughly. Also clean lubricant passage. Replace fitting if necessary.

5.1.3 SERVICING INTERVALS

Daily or 8 Hours

1. Check engine fluid levels. Top as required.

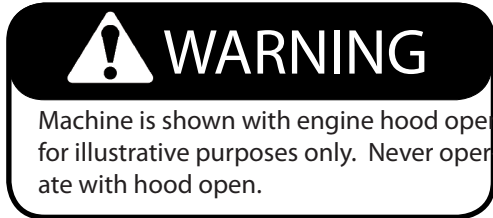

- a. Check engine oil level. Top up as required.
- b. Check fuel level. Add as required.



2. Check the oil level in the hydraulic reservoir.
4. Use an air hose to blow out and clean the engine, motor and compartment.

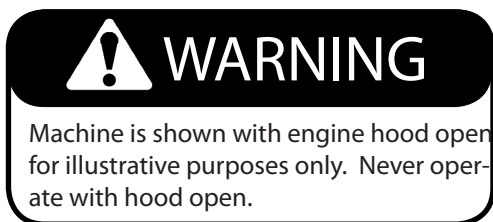

Schematic



Fig. 20 ENGINE FLUID LEVELS

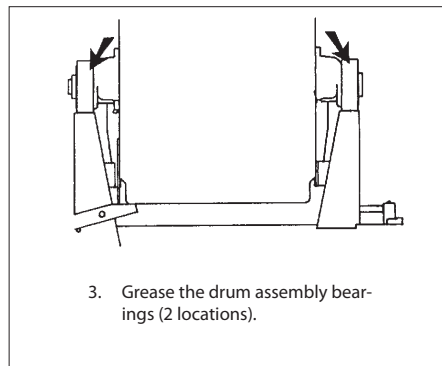

Fig. 21 OIL LEVEL



Front Bearing (Typical)

Fig. 22 DRUM ASSEMBLY BEARINGS





Gas Engine (Typical)



Electric Motor

Fig. 23 DRIVE COMPARTMENT

Weekly or 50 Hours

1. Change the engine oil.

IMPORTANT

Change more frequently if operating in high ambient temperatures or in very dusty or dirty conditions.

- a. Drain plug.
- b. Fill plug.

2. Clean the engine air intake filter.

! WARNING

Machine is shown with engine hood open for illustrative purposes only. Never operate with hood open.

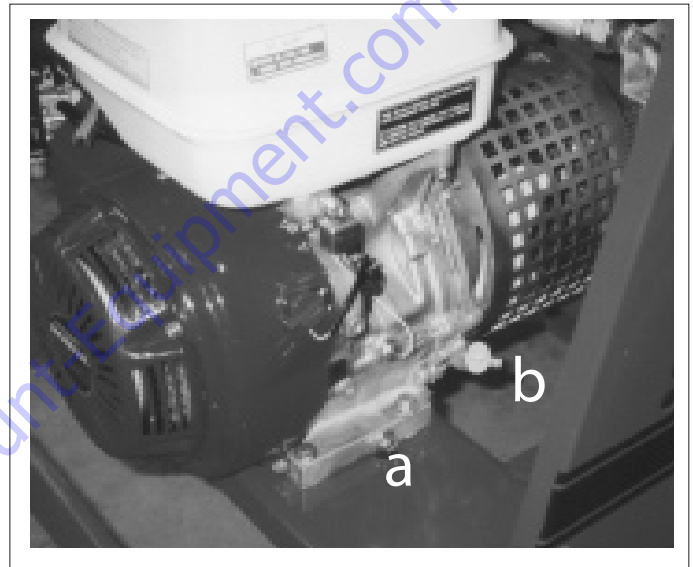

Fig. 24 ENGINE OIL

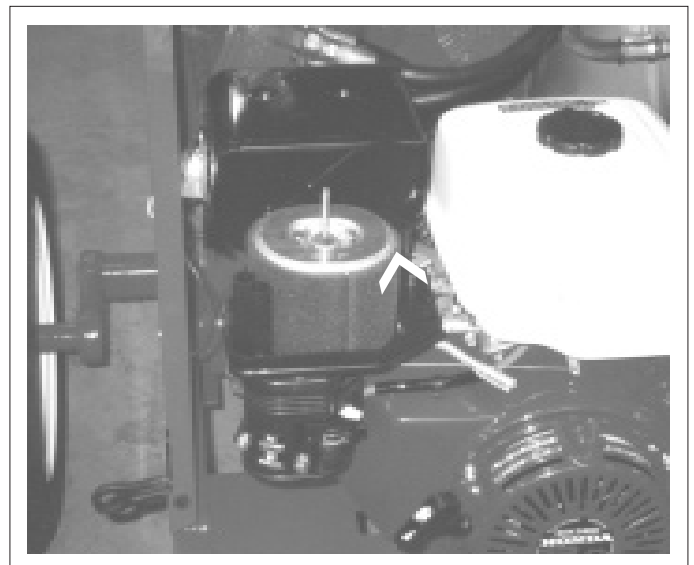

Fig. 25 ENGINE AIR INTAKE FILTER

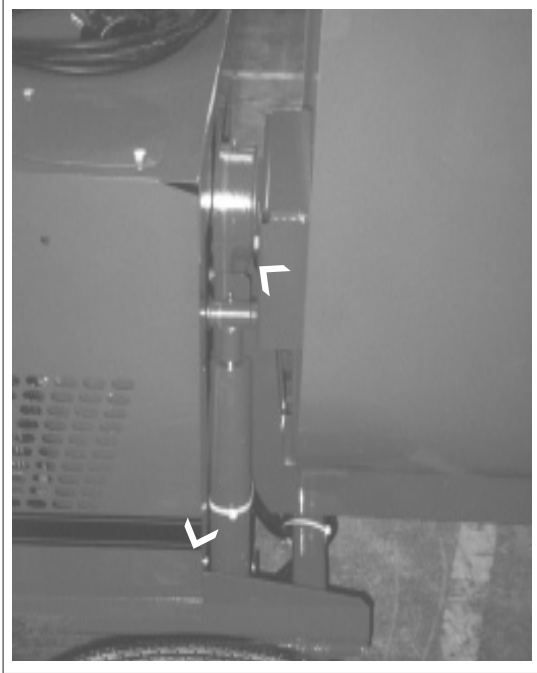

Fig. 26 DRUM TILT CYLINDER

- Grease the drum tilt cylinder ends with 1 shot of grease (2 locations).



Fig. 27 BEARING PACKING (TYPICAL)

- Check the condition of the drum bearing packing.

⚠ WARNING

Machine is shown with engine hood open for illustrative purposes only. Never operate with hood open.

Annually or 400 Hours

- Grease the electric motor bearings with 1/2 shot of grease (2 locations).

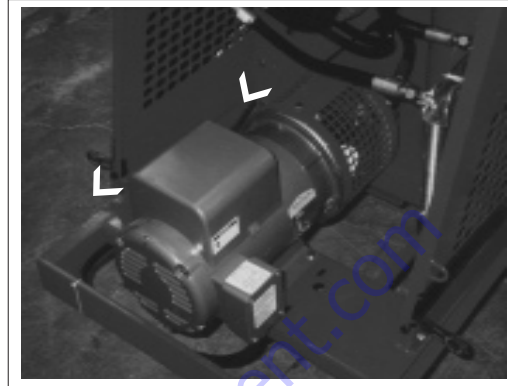

Fig. 28 ELECTRIC MOTOR



Fig. 29 OIL FILTER

- Change hydraulic filter.



Fig. 30 WHEELS

- Repack wheel bearings (2 locations).

5.2 MAINTENANCE

By following a careful service and maintenance program for your machine, you will enjoy many years of trouble-free service.

5.2.1 ENGINE OIL CHANGING

1. Review the Operator's Manual for the engine.
2. Allow the engine to cool before changing oil. Hot oil can cause burns if it contacts exposed skin. Draining works best if the oil is warm.
3. Be sure the ignition switch is off and fuel valve is turned off.
4. Place a pan under the drain plug.
5. Remove the drain plug and allow oil to drain for 10 minutes.
6. Install the engine drain plug and tighten.
7. Dispose of the oil in an approved container and manner.
8. Add the specified type and amount of motor oil. Refer to Section 5.1.1 or the engine manual.
9. Run the engine for 1 minute and check for leaks.
10. If leaks are found around the drain plug, tighten slightly and repeat Step 12.
11. Check engine oil level. Top up as required.



WARNING

Machine is shown with engine hood open for illustrative purposes only. Never operate with hood open.



Fig. 31 ENGINE OIL CHANGING (DRAIN PLUG)

5.2.2 ENGINE SPEED SETTING

Every engine is shipped from the engine factory without gas because of fire hazards during shipping. They are all set with a high idle of 3500 RPM. Gas and oil are added at the Mixer factory to check the engine RPM. When the Mixer is delivered, gas must be added and the mixing element RPM checked. To reset the RPM, follow this procedure:

1. Read the engine manual supplied with the machine.
2. Add gas to the fuel tank.
3. Start the engine and run at wide open throttle.
4. Count the mixing element revolutions to determine engine RPM. Be sure the engine speed to give 30-35 RPM for the mixing elements.
5. Use a screwdriver to reset the high idle stop screw if required to obtain the desired speed.



WARNING

Machine is shown with engine hood open for illustrative purposes only. Never operate with hood open.

5.2.3 AIR CLEANER MAINTENANCE

Each engine is equipped with filter to remove dust and dirt from entering the air intake. To clean the filter, follow this procedure:

1. Read the engine manual supplied with the machine.
2. Unlatch and open the hood.
3. Remove the filter cover.
4. Remove filter and shake out.
5. Wash in a filter cleaning detergent if heavily caked with dirt. Allow time to dry before re-installing.
6. Replace filter after washing 5 times.
7. Install clean filter and secure cover.

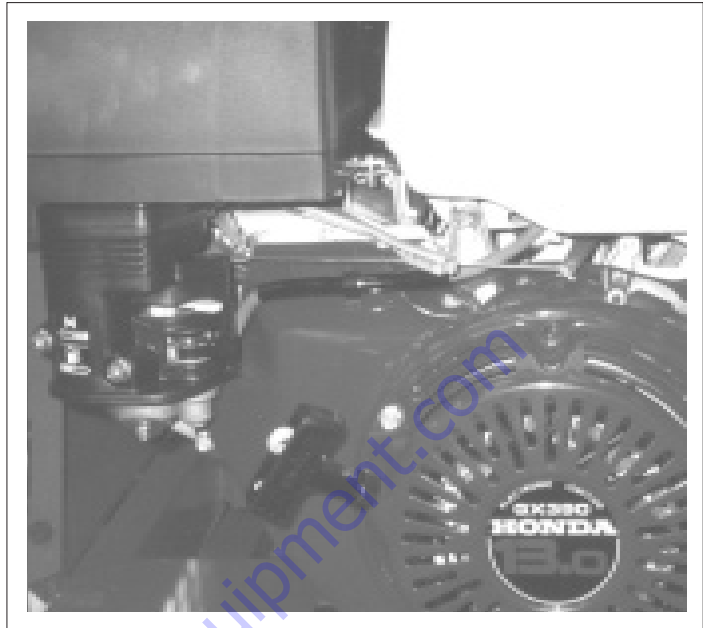

Fig. 32 ENGINE SPEED SETTING

5.2.4 CHANGING HYDRAULIC SYSTEM OIL AND FILTER

Annually or every 400 hours (or more often if conditions are extremely dusty) the filter in the hydraulic system should be changed. To change, follow this procedure:

1. Clear the area of bystanders, especially small children.
2. Allow the machine to cool before changing the filter. Hot oil can cause burns if it contacts exposed skin.
3. Remove an anchor bolt from access cover and rotate cover to the side.
4. Remove tank cover.
5. Remove filter and replace with a new one.
6. Install tank cover.
7. Slide access cover into position and secure.

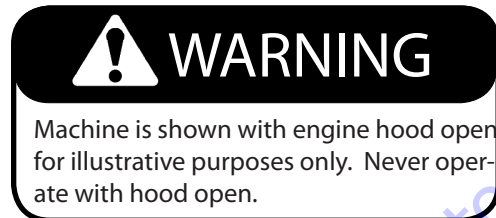
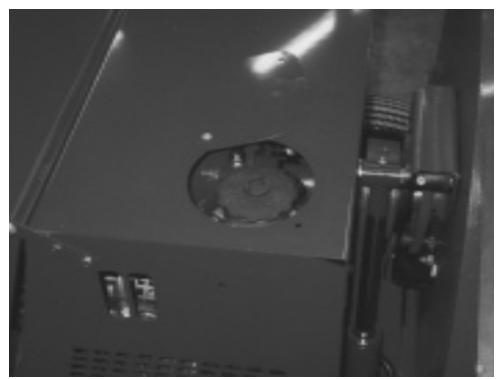

Fig. 33 AIR CLEANER



Access Cover



Filter

Fig. 34 HYDRAULIC FILTER



Paddles

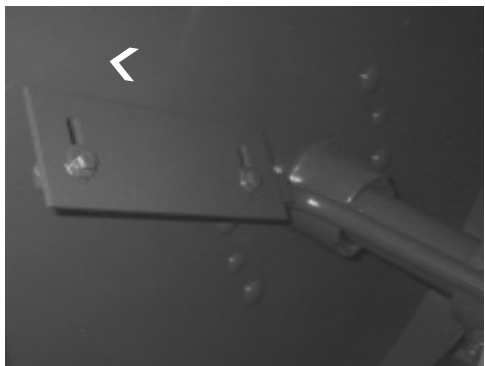

Spiral

Fig. 35 WIPERS

5.2.5 WIPER SPACING AND REPLACEMENT

Each machine is equipped with wipers on the mixing elements to scrape the build-up from the inside of the drum. After extended use, they will wear. They need to be adjusted so they clean the sides of the drum. To adjust or repair, follow this procedure:

1. Thoroughly clean the inside of the drum to remove all the build-up.
2. Open hood and disable power source by unplugging power cord or removing spark plug wire.
3. To adjust wipers, loosen mounting bolts.
4. Tap or slide wipers to 1/16 inch (1.5 mm) from the drum.
5. Tighten mounting bolts to their specified torque.
6. If there is no more adjustment available, remove old wipers.
7. Replace wipers.
8. Set at 1/16 inch (1.5 mm) from the drum.
9. Tighten mounting bolts to their specified torque.



Seals

5.2.6 DRUM PACKING SEAL

Each drum is designed with a packing seal to protect the mixing element drive shaft. This is a special seal that provides the required protection in an abrasive environment. As a result, the packing will protect the main shaft from excessive wear for a long period of time if it is maintained regularly.

Follow this procedure when maintaining the packing seal:

1. Clear the area of bystanders, especially small children.
2. Lock out tag out electric motor.
3. Disable gas engine by removing spark plug wire.
4. Regular Maintenance:
 - a. Wash the packing seal area on both ends of the drum after every use, to keep excessive buildup away from the seal adjustment area.
 - b. As the packing wears, the split Gland will compress the packings until its outer lip nears the drum side plate.
 - c. When dimension A measures 1/4 inch, an additional packing ring should be added.
 - d. Using water proof grease, install this on top of the existing packages.
 - e. Reassemble the spring plate, springs and adjusters.
 - f. Check that the spring plate is parallel with the drum side wall and set the spring installed height to 1.65 inches.



Shaft End

Fig. 36 PACKING SEAL

5. Packing Replacement:

- a. Once the above procedure has been completed once, the next time the split gland nears the 1/4 inch dimension A; full replacement is required.
- b. Disassemble and replace old packing rings with new parts, using a water proof grease generously on the main shaft and packings.
- c. When installing new packings, progressively install one seal at a time, staggering the parting lines at least 90° apart each time. Each time a ring is installed it should be compressed before the next one is added. This can be accomplished using Crown Tool No. 12SPD001 and a medium weight hammer.
- d. Run mixer for 1 to 4 hours then check packing for leakage. It is normal to experience slight leaking in the first hours of operation. Recheck spring heights and adjust as required.

IMPORTANT

Over tightening of adjusters may cause premature failure of packings.

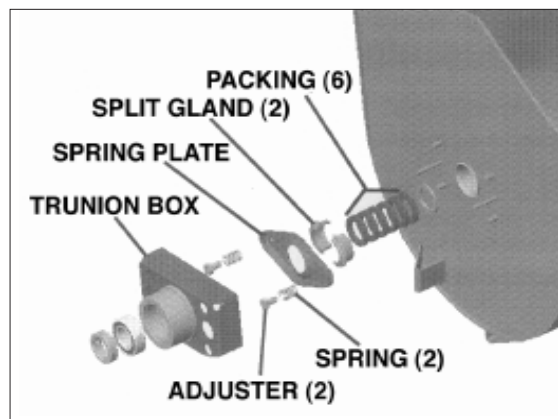

Fig. 37 SEAL GENERAL ARRANGEMENT

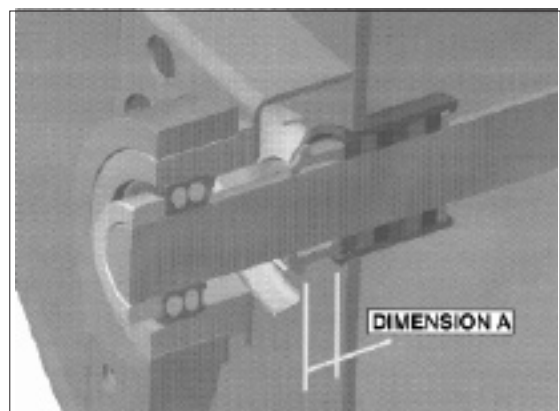

Fig. 38 SECTION VIEW GENERAL ARRANGEMENT

6 TROUBLE SHOOTING

The Crown Construction Mortar Mixer uses a large heavy-duty drum with hydraulically driven mixing elements for combining water, cement, lime and sand into a mixture for forming mortar. It is a well engineered machine that requires minimum maintenance.

In the following trouble shooting section, we have listed many of the problems, causes and solutions to the problems which you may encounter.

If you encounter a problem that is difficult to solve, even after having read through this trouble shooting section, please contact your authorized dealer, distributor or the factory. Before you call, please have this Operator's Manual and the serial number from your machine ready.

PROBLEM	CAUSE	SOLUTION
Engine won't start.	No fuel.	Fill the fuel tank.
	Low engine oil.	Fill the crankcase with oil.
	Cold engine.	Open choke.
	Ignition switch off.	Turn ignition switch on.
	Emergency Stop switch off.	Pull emergency stop switch out.
	Engine problem.	Refer to engine manual.
Motor won't run.	Power off.	Turn power on at master panel.
		Trip breaker at master panel.
		Turn switch on at motor.
	Overload switch tripped.	Reset overload switch on motor.
Mixing elements won't turn.	No power.	Turn power on.
		Start engine.
	Low hydraulic oil.	Add oil to bring to middle of sight tube.
Defective hydraulic component.	Repair or replace component.	
Build-up on drum walls.	Wiper gap too large.	Adjust wiper gap to 1/16 to 1/8 inch (1.5 to 3 mm).
	Wipers worn out.	Replace wipers.
Lumps or chips in mortar.	Drum build-up breaking loose.	Clean build-up from drum walls and adjust wipers.

7 SPECIFICATIONS

7.1 MECHANICAL

Model	12SH	16SH
Mixer Shaft RPM	30	30
Capacity - FT ³	12	16
Capacity Bags	3 to 4	4.5 to 5.5
Power	13HP Gas or 5HP Electric	13HP Gas or 5HP Electric
Weight	1250 LBS	1350 LBS
Length w/Tow Pole in/Out	92/112	98/118
Width	52"	52"
Height	57"	57"
Tires	195/75 - 14	195/75 - 14
High Speed Wheel Bearings	Yes	Yes
Dump Action	Hydraulic	Hydraulic
Fuel Capacity	1.7 Gallon	1.7 Gallon
Hydraulic Oil Capacity (Empty)	4 Gal. U.S.	4 Gal. U.S.
Hydraulic Oil Capacity (Oil Change)	3.5 Gal. U.S.	3.5 Gal. U.S.
Cooling Fan	Yes	Yes
Oil Cooler	Yes	Yes

Crown recommends SAE 20W50 motor oil for use in the hydraulic system.
 For sustained cold weather operation use: Mobil fluid 424
 Shell Donax TD, TDL
 PetroCan DuraTran

ELECTRIC POWER

	12 SH	16 SH
HP Volts Phase	5HP 220 1	N/A
HP Volts Phase	5HP 208/230/460 3	N/A
HP Volts Phase	N/A	7.5HP 208/230/460 3

NOTE: 5 HP & 7.5 HP Motors are available in 575/600 V, 3 PH (Special Order)

SPECIFICATIONS SUBJECT TO CHANGE WITHOUT NOTICE

7.2 BOLT TORQUE

CHECKING BOLT TORQUE

The tables shown below give correct torque values for various bolts and capscrews. Tighten all bolts to the torques specified in chart unless otherwise noted. Check tightness of bolts periodically, using bolt torque chart as a guide. Replace hardware with the same strength bolt.

Imperial Torque Specifications

Bolt Dia. "A"	Bolt Torque*					
	SAE 2		SAE 5		SAE 8	
	Nm	Ft-Lbs	Nm	Ft-Lbs	Nm	Ft-Lbs
1/4	8	6	12	9	17	12
5/16	13	10	25	19	36	27
3/8	27	20	45	33	63	45
7/16	41	30	72	53	100	75
1/2	61	45	110	80	155	115
9/16	95	60	155	115	220	165
5/8	128	95	215	160	305	220
3/4	225	165	390	290	540	400
7/8	230	170	570	420	880	650
1	345	225	850	630	1320	970

Metric Torque Specifications

Bolt Dia. "A"	Bolt Torque*			
	8.8		10.9	
	Nm	Ft-Lbs	Nm	Ft-Lbs
M4	3	2.2	4.5	3.3
M5	6	4	9	7
M6	10	7	15	11
M8	25	18	35	26
M10	50	37	70	52
M12	90	66	125	92
M14	140	103	200	148
M16	225	166	310	229
M20	435	321	610	450
M24	750	553	1050	774

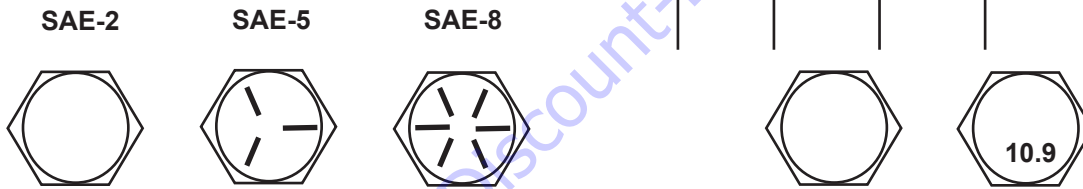

Torque figures indicated above are valid for non-greased or non-oiled threads and heads unless otherwise specified. Therefore, do not grease or oil bolts or capscrews unless otherwise specified in this manual. When using locking elements, increase torque values by 5%.

WHEEL LUG NUT TORQUE:

Use the tightening pattern shown below, to ensure the even tightening of the lug nuts on each wheel.

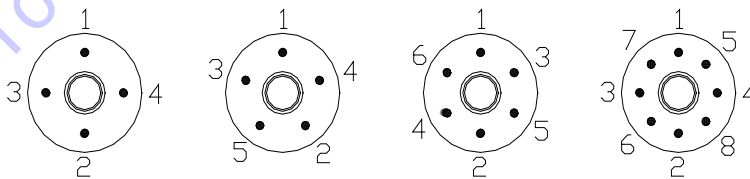

Bolt Dia	Bolt Torque	
	Nm	Ft-Lbs
1/2"	136	100
9/16"	203	150

* Torque value for bolts and capscrews are identified by their head markings.

7.3 HYDRAULIC FITTING TORQUE

TIGHTENING FLARE TYPE TUBE FITTINGS*

1. Check flare and flare seat for defects that might cause leakage.
 2. Align tube with fitting before tightening.
 3. Lubricate connection and hand tighten swivel nut until snug.
 4. To prevent twisting the tube(s), use two wrenches. Place one wrench on the connector body and with the second tighten the swivel nut to the torque shown.
- * The torque values shown are based on lubricated connections as in reassembly.

Tube Size OD (in.)	Nut Size Across Flats (in.)	Torque Value*		Recommended Turns To Tighten (After Finger Tightening)	
		(N.m)	(lb-ft)	(Flats)	(Turn)
3/16	7/16	8	6	1	1/6
1/4	9/16	12	9	1	1/6
5/16	5/8	16	12	1	1/6
3/8	11/16	24	18	1	1/6
1/2	7/8	46	34	1	1/6
5/8	1	62	46	1	1/6
3/4	1-1/4	102	75	3/4	1/8
7/8	1-3/8	122	90	3/4	1/8

TIGHTENING O-RING FITTINGS*

1. Inspect O-ring and seat for dirt or obvious defects.
 2. On angle fittings, back the lock nut off until washer bottoms out at top of groove.
 3. Hand tighten fitting until back-up washer or washer face (if straight fitting) bottoms on face and O-ring is seated.
 4. Position angle fittings by unscrewing no more than one turn.
 5. Tighten straight fittings to torque shown.
 6. Tighten while holding body of fitting with a wrench.
- * The torque values shown are based on lubricated connections as in reassembly.

Tube Size OD (in.)	Nut Size Across Flats (in.)	Torque Value*		Recommended Turns To Tighten (After Finger Tightening)	
		(N.m)	(lb-ft)	(Flats)	(Turn)
3/8	1/2	8	6	2	1/3
7/16	9/16	12	9	2	1/3
1/2	5/8	16	12	2	1/3
9/16	11/16	24	18	2	1/3
3/4	7/8	46	34	2	1/3
7/8	1	62	46	1-1/2	1/4
1-1/16	1-1/4	102	75	1	1/6
1-3/16	1-3/8	122	90	1	1/6
1-5/16	1-1/2	142	105	3/4	1/8
1-5/8	1-7/8	190	140	3/4	1/8
1-7/8	2-1/8	217	160	1/2	1/12

8 INDEX

	PAGE		PAGE
		I	
Introduction	1		
		O	
Operation	11		
Controls.....	15		
How The Machine Works	12		
Machine Break-In.....	14		
Operating.....	17		
Pre-Operation Checklist.....	13		
Pre-Start Procedures	13		
Storage.....	28		
To The New Operator or Owner	11		
Transporting.....	26		
		P	
Proposition 65	ii		
		R	
Reporting Safety Defects.....	i		
			S
		Safety	2
		Electrical Safety.....	6
		General Safety	3
		Hydraulic Safety.....	4
		Maintenance Safety.....	5
		Operating Safety.....	4
		Refueling Safety.....	6
		Safety Signs	6
		Sign-Off Form	7
		Storage Safety	5
		Tire Safety.....	5
		Transport Safety.....	5
		Safety Sign Locations.....	8
		Service and Maintenance.....	29
		Maintenance	37
		Air Cleaner Maintenance.....	39
		Changing Hydraulic System Oil and Filter	40
		Drum Packing Seal.....	42
		Engine Oil Changing	37
		Engine Speed Setting	38
		Wiper Spacing & Replacement.....	41
		Service	29
		Fluids and Lubricants.....	29
		Greasing	29
		Service Record.....	36
		Servicing Intervals	30
		Specifications.....	45
		Bolt Torque.....	46
		Hydraulic Fitting Torque	47
		Mechanical	45
		T	
		Trouble Shooting.....	44

SERIAL NUMBER LOCATION

Always give your dealer, distributor or factory the serial number of your Mortar Mixer when ordering parts or requesting service or other information.

The serial number is stamped into the frame where indicated. Please mark the number in the space provided for easy reference.

Model _____

Serial Number _____

TO PURCHASE THIS PRODUCT PLEASE CONTACT US



**Equipment Financing and
Extended Warranties Available**



**Discount-Equipment.com is your online resource for
commercial and industrial quality parts and equipment sales.**

561-964-4949

visit us on line @ www.discount-equipment.com

Select an option below to find your Equipment

Search by Manufacturer

Search by Product Type

Request a Quote

We sell worldwide for the brands: Genie, Terex, JLG, MultiQuip, Mikasa, Essick, Whiteman, Mayco, Toro Stone, Diamond Products, Generac Magnum, Airman, Haulotte, Barreto, Power Blanket, Nifty Lift, Atlas Copco, Chicago Pneumatic, Allmand, Miller Curber, Skyjack, Lull, Skytrak, Tsurumi, Husquvarna Target, Stow, Wacker, Sakai, Mi-T-M, Sullair, Basic, Dynapac, MBW, Weber, Bartell, Bennar Newman, Haulotte, Ditch Runner, Menegotti, Morrison, Contec, Buddy, Crown, Edco, Wyco, Bomag, Laymor, EZ Trench, Bil-Jax, F.S. Curtis, Gehl Pavers, Heli, Honda, ICS/PowerGrit, IHI, Partner, Imer, Clipper, MMD, Koshin, Rice, CH&E, General Equipment, Amida, Coleman, NAC, Gradall, Square Shooter, Kent, Stanley, Tamco, Toku, Hatz, Kohler, Robin, Wisconsin, Northrock, Oztec, Toker TK, Rol-Air, APT, Wylie, Ingersoll Rand / Doosan, Innovatech, Con X, Ammann, Mecalac, Makinex, Smith Surface Prep, Small Line, Wanco, Yanmar