

YANMAR

OPERATION & MAINTENANCE
MANUAL



www.discount-equipment.com

EXCAVATOR

Vi080

S/N 92053 & Above

Go to Discount-Equipment.com to order your parts

PARTS FINDER

**Search Website
by Part Number**



**Search Manual
Library For Parts
Manual & Lookup Part
Numbers – Purchase
or Request Quote**

Search Manuals

Enter your information to help us find the right parts manual for your machine.

* Brand:

* Model:

* Serial:

* Part Number:

SEARCH

**Can't Find Part or
Manual? Request Help
by Manufacturer,
Model & Description**

Parts Order Form

Please fill in the following information to help us find the right part for your machine.

Manufacturer:	<input type="text"/>
Model:	<input type="text"/>
Description:	<input type="text"/>
Part Number:	<input type="text"/>
Quantity:	<input type="text"/>
Notes:	<input type="text"/>

Submit

Discount-Equipment.com is your online resource for quality parts & equipment.

Florida: **561-964-4949** Outside Florida TOLL FREE: **877-690-3101**

Need parts?

Click on this link: <http://www.discount-equipment.com/category/5443-parts/> and choose one of the options to help get the right parts and equipment you are looking for. Please have the machine model and serial number available in order to help us get you the correct parts. If you don't find the part on the website or on one of the online manuals, please fill out the request form and one of our experienced staff members will get back to you with a quote for the right part that your machine needs.

We sell worldwide for the brands: Genie, Terex, JLG, MultiQuip, Mikasa, Essick, Whiteman, Mayco, Toro Stone, Diamond Products, Generac Magnum, Airman, Haulotte, Barreto, Power Blanket, Nifty Lift, Atlas Copco, Chicago Pneumatic, Allmand, Miller Curber, Skyjack, Lull, Skytrak, Tsurumi, Husquvarna Target, Stow, Wacker, Sakai, Mi-T-M, Sullair, Basic, Dynapac, MBW, Weber, Bartell, Bennar Newman, Haulotte, Ditch Runner, Menegotti, Morrison, Contec, Buddy, Crown, Edco, Wyco, Bomag, Laymor, EZ Trench, Bil-Jax, F.S. Curtis, Gehl Pavers, Heli, Honda, ICS/PowerGrit, IHI, Partner, Imer, Clipper, MMD, Koshin, Rice, CH&E, General Equipment, Amida, Coleman, NAC, Gradall, Square Shooter, Kent, Stanley, Tamco, Toku, Hatz, Kohler, Robin, Wisconsin, Northrock, Oztec, Toker TK, Rol-Air, APT, Wylie, Ingersoll Rand / Doosan, Innovatech, Con X, Ammann, Mecalac, Makinex, Smith Surface Prep, Small Line, Wanco, Yanmar

Read this manual carefully to learn how to operate and service your machine correctly. Failure to do so could result in personal injury or equipment damage

This manual should be considered a permanent part of your machine and should remain with the machine when you sell it.

This machine is of metric design, and consequently the measurements in this manual are also metric.

Use only metric hardware and tools as specified.

Right-hand and left-hand sides are determined by facing in the direction of forward travel.

Warranty is provided as a part of Yanmar's product support program for customers who operate and maintain their equipment as described in this manual. Should the equipment be abused, or modified to change its performance beyond the original factory specifications, the warranty will become void and field improvements under warranty may be denied. Setting fuel delivery above specifications or otherwise overpowering machines will result in such action.

All information, illustrations and specifications in this manual are based on the latest product information available at the time of publication. The right is reserved to make changes at any time without notice.

REFERENCE INFORMATION

Write the correct information for your YANMAR Excavator in the spaces below.

Always use these numbers when referring to your YANMAR Excavator.

Model name : _____
Serial Number : _____
Engine Serial Number : _____
Your YANMAR Excavator Dealer : _____
Address : _____
Phone : _____

California Proposition 65 Warning

Diesel engine exhaust and some of its constituents are known to the state of California to cause cancer, birth defects, and other reproductive harm.

California Proposition 65 Warning

Battery posts, terminals, and related accessories contain lead and lead compounds, chemicals known to the state of California to cause cancer and reproductive harm.
Wash hands after handling.

1. Introduction

This Operation and Maintenance Manual for the YANMAR ViO80 Excavator is designed to provide you with important information and suggestions necessary for using the machine with safety and efficiency. Please be sure to read through the manual before using the machine, to make yourself familiar with the procedures and instructions for operating, inspecting and servicing. Keep in mind that failure to observe the precautions given in the manual or using any procedures not prescribed in the manual may cause a serious accident.

WARNING

Improper use of the machine may lead to hazards which can result in death or serious injury. Personnel engaged in operating and maintaining the machine are required to familiarize themselves with the contents of the manual before setting about their job.

- **Do not attempt to operate the machine before making yourself familiar with the contents of the manual.**
- **Personnel responsible for using the machine must keep the manual at hand and review it periodically.**
- **If the manual should be lost or damaged, promptly order a new copy from the dealer.**
- **When you transfer the machine to another user, always transfer the manual as well.**
- **We at YANMAR provide customers with products in compliance with all applicable of your country regulations and industrial standards. If you are using a YANMAR machine purchased abroad, the machine may lack some safety devices. Please consult your dealer to confirm whether or not that machine is in compliance with all applicable of your country regulations and industrial standards of your country.**
- **Some machine specifications may differ from those which are described in this manual because of improvements in its design and performance. If you have any questions about the contents of the manual, don't hesitate to contact your dealer.**
- **Important safety instructions have been presented throughout this manual, and have been summarized in PART ONE : SAFETY. Be sure to review these pages and pay heed to those safety instructions before proceeding to operate the machine.**

2. Safety Information

- The following Signal Words have been used in this Manual and on the Safety Signs to indicate the seriousness of the hazards that could be encountered by failing to comply with the applicable Product Warnings, as follows:

! DANGER

The word "DANGER" indicates an imminently hazardous situation which, if not avoided, will result in death or serious injury. "DANGER" is limited to the most extreme situations.

! WARNING

The word "WARNING" indicates a potentially hazardous situation which, if not avoided, could result in death or serious injury.

! CAUTION

The word "CAUTION" indicates a potentially hazardous situation which, if not avoided, may result in minor or moderate injury.

IMPORTANT

The signal word "IMPORTANT" has been utilized in this Manual to denote those User Directions that must be followed to assure the safe operation and maintenance of the Excavator.

- WARNING** : Never attempt to operate or service this Excavator until you have first read and understood all of the applicable Product Warnings and User Directions that are set forth in this Manual and on the Safety Signs that are affixed to this Excavator.

The failure to comply with all relevant Safety Instructions could result in bodily injury.

- WARNING** : Never modify the design of this Excavator or its engine; never remove or disable any of the installed safety guards or devices; and never use any unauthorized attachments in the operation of this equipment.

The implementation of any unauthorized design modifications or the use of unauthorized attachments could result in bodily injury.

Furthermore, since those actions would expressly violate the terms of Yanmar's Product Warranty, the applicable Warranty would also be voided.

In this Manual, the major sections of the product are designated as follows:

Machine.....refers to the entire product.

Machine base.....refers to the section consisting of the upperstructure and the undercarriage.

Implement.....refers to the section consisting of the arm, boom and bucket or other attachment.

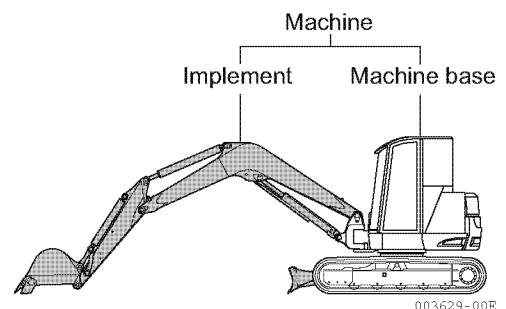

003629-00E

3. Product Overview

3-1. Intended uses

The ViO80 Excavator is intended to perform the following tasks:

- Digging
- Leveling of ground
- Shoveling
- Ditching and Guttering
- Loading

The machine should not be used for unintended tasks

For the details on how to work with the machine, refer to Section “13-13. Operations using the bucket”.

3-2. Break in period

The machine should not be subjected to severe stresses and loads during the initial break in period although it has been prepared well and stringently inspected before shipping. Otherwise the machine's performance may be affected and its service life shortened. Thus it is essential to break in the machine for the first approx. 100 service hours (reading of the hour meter).

In breaking in the machine:

- You should warm up the engine by idling for 5 minutes before starting operations.
- You should not operate the machine under heavy loads or at high speed.
- You should not start and accelerate the engine too abruptly, or stop it too abruptly.
- You should not change travel direction too abruptly.

The safety instructions for operation and maintenance that are presented in this Manual are applicable to each of the intended tasks. Never misuse this machine by violating the applicable safety instructions or by attempting to perform unintended tasks, because of the danger of serious bodily injury.

3-3. Conditions to be met to assure compliance with EPA emission standards *Conditions de conformité avec les standards d'émission EPA*

An EPA approved engine has been installed in this machine. The following are the conditions that must be met to assure that emissions during operation will meet EPA standards. Always comply with all of these requirements.

- The prevailing atmospheric conditions should be as follows.
 - (1) Ambient temperature : -4 to 104°F (-20 to 40°C)
 - (2) Relative humidity : 80% or lower
- The fuel and lube oil used should be as follows.
 - (1) Fuel : Diesel light oil ASTM D975 No.1D S15, S500 or No.2D S15, S500 (ISO 8217 DMX)
- The fuel cetane number should be equal to 45 or higher.
- For electronically controlled engine, it is mandatory to use fuel that does not contain 0.1% or more sulfur content. Less than 0.05% is preferred.

In general, using a high sulfur fuel may possible result in corrosion inside the cylinder. Especially in U.S.A. and Canada, Ultra Low Sulfur fuel should be used.
- The Water and sediment in the fuel should not exceed 0.05% by volume.
 - (2) Lube oil : Type API, class CF
- Never remove the seals limiting the amount of fuel injected and the speed.
- Always perform the required periodic maintenance.

Follow the basic guidelines outlined in Section "24. Maintenance Table" of this manual, and keep a record of the results. Pay particular attention to these important points: replacing the lube oil and lube oil filter; cleaning the air cleaner element and the radiator fins.

Un moteur thermique agréé EPA est installé sur cette machine. A la suite figurent les conditions d'utilisation permettant de satisfaire au standard EPA; il est impératif de les respecter.

• *Environnement extérieur:*

- (1) *Température ambiante : -4 à 104°F (-20 à 40°C)*
- (2) *Humidité relative : 80 % au moins*

• *Carburant et huiles à utiliser*

- (1) *Carburant : Diesel léger ASTM D975 N° 1D S15, S500 ou N° 2D S15, S500 (ISO 8217 DMX)*
- *L'indice de cétane du carburant doit être égal ou supérieur à 45.*
- *La teneur en soufre ne doit pas dépasser 0,1% par volume. Moins de 0,05% est préférable.*

En général, l'utilisation d'un carburant à teneur élevée en soufre peut entraîner une corrosion à l'intérieur du vérin.

Aux U.S.A. et au Canada notamment, l'utilisation d'un carburant à très basse teneur en soufre est recommandée.
- *L'eau et les sédiments présents dans le carburant ne doivent pas dépasser 0,05% par volume.*
 - (2) *Huiles : type API, classe CF*
- *Ne pas retirer les joints limitant la quantité de carburant injecté et la vitesse*
- *Respecter les inspections périodiques*

Suivre les indications figurant dans ce manuel (Table de maintenance 24) et garder une trace des résultats. Faire très attention aux points importants suivant: remplacer l'huile et le filtre à huile, nettoyer l'élément de filtre à air et le radiateur.

3-4. Emission system warranty***Garantie du système antipollution*****Yanmar Co., Ltd. limited emission control system warranty - U.S.A. only****■ Your warranty rights and obligations**

- California

The California Air Resources Board (CARB), the Environmental Protection Agency (EPA) and Yanmar Co., Ltd. hereafter referred to as Yanmar, are pleased to explain the **emission control system warranty** on your industrial compression-ignition engine. In California, model year 2000 or later off-road compression-ignition engines must be designed, built and equipped to meet the State's stringent anti-smog standards. In all states, 1998 and later non-road compression-ignition engines must be designed, built and equipped to meet the United States EPA emissions standards. Yanmar warrants the emission control system on your engine for the periods of time listed below provided there has been no abuse, neglect or improper maintenance of your engine.

Your emission control system may include parts such as the fuel injection system, the air induction system, the electronic control system and the EGR (Exhaust Gas Recirculation) system. Also included may be hoses, belts, connectors and other emission-related assemblies.

Where a warrantable condition exists, Yanmar will repair your non-road compression-ignition engine at no charge to you including diagnosis, parts and labor.

■ Manufacturer's Warranty Period

The model year 1998 or later certified and labeled non-road compression-ignition engines are warranted for the periods listed below. If any emission-related part on your engine is found to be defective during the applicable warranty period, the part will be replaced by Yanmar.

Engine Type	Warranty Period by Number of Years or Hours of Operation
Constant speed engines rated at or above 50 hp SAE (37 kW)	The warranty period is five (5) years or 3,000 hours of use, whichever occurs first. In the absence of a device to measure the hours of use, the engine has a warranty period of five (5) years.
Constant speed engines rated under 50 hp SAE (37 kW) with rated speeds greater than or equal to 3,000 rpm	The warranty period is two (2) years or 1,500 hours of use, whichever occurs first. In the absence of a device to measure the hours of use, the engine has a warranty period of two (2) years.
Constant speed engines rated under 50 hp SAE (37 kW) and engines rated at or above 26 hp SAE (19 kW) with rated speeds less than 3,000 rpm	The warranty period is five (5) years or 3,000 hours of use, whichever occurs first. In the absence of a device to measure the hours of use, the engine has a warranty period of five (5) years.
Engines rated at or above 26 hp SAE (19 kW)	The warranty period is five (5) years or 3,000 hours of use, whichever occurs first. In the absence of a device to measure the hours of use, the engine has a warranty period of five (5) years.
Engines rated under 26 hp SAE (19 kW)	The warranty period is two (2) years or 1,500 hours of use, whichever occurs first. In the absence of a device to measure the hours of use, the engine has a warranty period of two (2) years.

■ Warranty Coverage

This warranty is transferable to each subsequent purchaser for the duration of the warranty period. Repair or replacement of any warranted part will be performed at an authorized Yanmar industrial engine dealer or distributor.

Warranted parts not scheduled for replacement as required maintenance in the Operation Manual shall be warranted for the warranty period. Warranted parts scheduled for replacement as required maintenance in the operation manual are warranted for the period of time prior to the first scheduled replacement. Any part repaired or replaced under warranty shall be warranted for the remaining warranty period.

During the warranty period, Yanmar is liable for damages to other engine components caused by the failure of any warranted part during the warranty period.

Any replacement part which is functionally identical to the original equipment part in all respects may be used in the maintenance or repair of your engine, and shall not reduce Yanmar's warranty obligations. Add-on or modified parts that are not exempted may not be used. The use of any non-exempted add-on or modified parts shall be grounds for disallowing a warranty.

■ Warranted Parts

This warranty covers engine components that are a part of the emission control system of the engine as delivered by Yanmar to the original retail purchaser. Such components may include the following:

- Fuel injection system
- Electronic control system
- Cold start enrichment system
- Intake manifold
- Turbocharger systems
- Exhaust manifold
- EGR system
- Positive crankcase ventilation system
- Hoses, belts, connectors and assemblies associated with emission control systems

Since emissions-related parts may vary slightly between models, certain models may not contain all of these parts and other models may contain the functional equivalents.

■ Exclusions

Failures other than those arising from defects in material and / or workmanship are not covered by this warranty. The warranty does not extend to the following: malfunctions caused by abuse, misuse, improper adjustment, modification, alteration, tampering, disconnection, improper or inadequate maintenance or use of non-recommended fuels and lubricating oils; accident-caused damage, and replacement of expendable items made in connection with scheduled maintenance. Yanmar disclaims any responsibility for incidental or consequential damages such as loss of time, inconvenience, loss of use of equipment / engine or commercial loss.

■ Owner's Warranty Responsibilities

As the engine owner, you are responsible for the performance of the required maintenance listed in your owner's manual. Yanmar recommends that you retain all documentation, including receipts, covering maintenance on your non-road compression-ignition engine, but Yanmar cannot deny warranty solely for the lack of receipts, or for your failure to ensure the performance of all scheduled maintenance.

Yanmar may deny your warranty coverage of your non-road compression-ignition engine if a part has failed due to abuse, neglect, improper maintenance or unapproved modifications.

Your engine is designed to operate on diesel fuel only. Use of any other fuel may result in your engine no longer operating in compliance with applicable emissions requirements.

You are responsible for initiating the warranty process. You must present your engine to a Yanmar dealer as soon as a problem exists. The warranty repairs should be completed by the dealer as expeditiously as possible.

Garantie du système antipollution limité de Yanmar Co., Ltd. - états-unis uniquement

■ ***Vos droits et obligations en vertu de la garantie***

• Californie

*Le California Air Resources Board (CARB), l'agence de protection de l'environnement (EPA) et Yanmar Co., Ltd. ci-après appelé Yanmar, ont le plaisir de vous présenter la **garantie du système antipollution** de votre moteur industriel à allumage par compression. En Californie, les modèles 2000 ou ultérieurs de moteurs hors-route à allumage par compression doivent être conçus, construits et équipés pour répondre aux normes anti-smog strictes de l'État. Dans les États, les modèles 1998 et ultérieurs de moteurs hors route à allumage par compression doivent être conçus, construits et équipés pour répondre aux normes antipollution de l'EPA des États-Unis. Yanmar garantit le système antipollution de votre moteur pendant les périodes présentées ci-dessous à condition que votre moteur ne fasse pas l'objet d'un usage abusif, de négligences ou d'un entretien inapproprié.*

Votre système antipollution peut comprendre des pièces telles que le système d'injection de carburant, le système d'admission d'air, le système de contrôle électronique et le système EGR (Recirculation des gaz d'échappement). Il peut également inclure des tuyaux, courroies, connecteurs et autres ensembles de pièces du système antipollution.

En présence de condition couverte par la garantie, Yanmar réparera gratuitement votre moteur hors route à allumage par compression, le diagnostic étant inclus ainsi que les pièces et la main d'oeuvre.

3. Product Overview

■ Période de garantie du fabricant

Les modèles 1998 ou ultérieurs de moteurs hors route à allumage par compression certifiés et marqués sont garantis pour les périodes présentées ci-dessous. Si une pièce du système antipollution de votre moteur s'avère défectueuse durant la période de garantie applicable, la pièce sera remplacée par Yanmar.

Type de moteur	Période de garantie par nombre d'années et heures de fonctionnement
Moteurs à vitesse constante d'au moins 50 hp SAE (37 kW)	La période de garantie est de cinq (5) ans ou de 3000 heures d'utilisation, quelle que soit la première occurrence. En l'absence d'un dispositif de mesure des heures d'utilisation, le moteur bénéficie d'une période de garantie de cinq (5) ans.
Moteurs à vitesse constante de 50 hp SAE (37 kW) maximum présentant des vitesses nominales supérieures ou égales à 3000 tr/min	La période de garantie est de deux (2) ans ou de 1500 heures d'utilisation, quelle que soit la première occurrence. En l'absence d'un dispositif de mesure des heures d'utilisation, le moteur bénéficie d'une période de garantie de deux (2) ans.
Moteurs à vitesse constante de 50 hp SAE (37 kW) maximum et moteurs d'au moins 26 hp SAE (19 kW) présentant des vitesses nominales inférieures à 3000 tr/min	La période de garantie est de cinq (5) ans ou de 3000 heures d'utilisation, quelle que soit la première occurrence. En l'absence d'un dispositif de mesure des heures d'utilisation, le moteur bénéficie d'une période de garantie de cinq (5) ans.
Moteurs d'au moins 26 hp SAE (19 kW)	La période de garantie est de cinq (5) ans ou de 3000 heures d'utilisation, quelle que soit la première occurrence. En l'absence d'un dispositif de mesure des heures d'utilisation, le moteur bénéficie d'une période de garantie de cinq (5) ans.
Moteurs de 26 hp SAE (19 kW) maximum	La période de garantie est de deux (2) ans ou de 1500 heures d'utilisation, quelle que soit la première occurrence. En l'absence d'un dispositif de mesure des heures d'utilisation, le moteur bénéficie d'une période de garantie de deux (2) ans.

■ Couverture de la garantie

La présente garantie est transférable à tout acheteur ultérieur pendant la période de garantie. La réparation ou le remplacement de toute pièce sous garantie sera effectuée par un distributeur ou revendeur agréé de moteurs industriels Yanmar.

Les pièces sous garanties, dont le remplacement n'est pas prévu à titre d'entretien requis dans le guide d'utilisation, seront garanties pour la période de garantie. Les pièces sous garanties, dont le remplacement est prévu à titre d'entretien requis dans le guide d'utilisation, sont garanties pour la période précédant le premier remplacement prévu. Toute pièce réparée ou remplacée au titre de la présente garantie sera garantie pour le reste de la période de garantie.

Pendant la période de garantie, Yanmar est responsable des dommages aux autres éléments du moteur dus à la défaillance de toute pièce sous garantie pendant la période de garantie.

Toute pièce de rechange, qui est à tous points de vue fonctionnellement identique à la pièce d'équipement d'origine, peut être utilisée pour l'entretien ou la réparation de votre moteur, et ne réduira pas les obligations de Yanmar en vertu de la garantie. Les pièces ajoutées ou modifiées qui ne font pas l'objet d'une homologation ne peuvent être utilisées. L'utilisation de toute pièce ajoutée ou modifiée ne faisant pas l'objet d'une homologation donnera lieu à un refus de la réclamation au titre de la garantie.

■ Pièces sous garantie

La présente garantie couvre les éléments du moteur qui font partie du système antipollution du moteur fourni par Yanmar à l'acheteur au détail d'origine. Ces éléments peuvent comprendre les éléments suivants :

- Système d'injection
- Système de contrôle électronique
- Système d'enrichissement de démarrage à froid
- Tubulure d'admission
- Systèmes de turbocompresseur
- Tubulure d'échappement
- Système EGR
- Système de recyclage des gaz de carter
- Tuyaux, courroies, connecteurs et ensembles de pièces associés aux systèmes antipollution

Étant donné que les pièces du système antipollution peuvent varier légèrement d'un modèle à un autre, certains modèles ne peuvent pas contenir toutes ces pièces et d'autres modèles peuvent contenir les équivalents fonctionnels.

■ Exclusions

Les défaillances autres que celles résultant des défauts de pièce et / ou de main d'oeuvre ne sont pas couvertes par la présente garantie. La garantie ne s'étend pas à ce qui suit : les dysfonctionnements dus à un usage abusif, une mauvaise utilisation, un réglage inadéquat, une modification, une altération, une manipulation intempestive, une déconnexion, un entretien inapproprié ou inadéquat, les dommages accidentels dus à l'utilisation de carburants et d'huiles de graissage non-recommandés et le remplacement d'éléments superflus effectué en relation avec l'entretien prévu. Yanmar décline toute responsabilité pour les dommages accessoires ou consécutifs tels que la perte de temps, la gêne, l'impossibilité d'utiliser l'équipement / le moteur ou la perte commerciale.

3. Product Overview

■ Responsabilités du propriétaire en vertu de la garantie

En tant que propriétaire du moteur, vous êtes responsable de l'exécution de l'entretien nécessaire indiqué dans votre guide d'utilisation.

les reçus, couvrant les travaux d'entretien de votre moteur hors route à allumage par compression, mais Yanmar ne peut refuser la garantie uniquement en raison d'absence de reçus, ou pour défaut d'avoir suivi tout le programme d'entretien.

Yanmar peut refuser d'honorer la couverture de garantie de votre moteur hors route à allumage par compression si la défaillance d'une pièce est due à un usage abusif, une négligence, un entretien inapproprié ou à des modifications non approuvées.

Votre moteur est conçu pour fonctionner au carburant diesel uniquement. L'utilisation de tout autre carburant peut entraîner la panne définitive de votre moteur conformément aux exigences applicables en matière d'émissions.

Vous êtes responsable de l'initiation du processus de garantie. Vous devez présenter votre moteur à un revendeur Yanmar dès qu'un problème se présente. Les réparations couvertes par la garantie doivent être exécutées par le revendeur le plus rapidement possible.

4. Operation License

Before you operate this machine, confirm the licensing requirements that are applicable to the operation of this machine.

Comply with all applicable laws.

Ask your dealer about licensing requirements.

Go to Discount-Equipment.com to order your parts

5. Ordering Replacement Parts and Service Calls

5-1. Location of machine serial number plate

The machine serial number plate is located on the turning frame as illustrated at right. Never remove the plate for any reason.

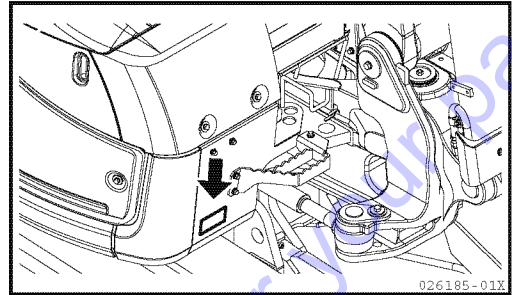

5-2. Location of engine serial number plate

The engine serial number plate is located on the top of the cylinder head cover. Never remove the plate for any reason.

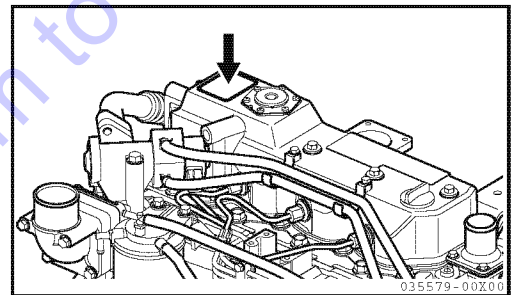

5-3. Location of EPA emission control plates

Localisation de la plaque signalétique EPA

The EPA emission control plates are located on the engine and engine hood as illustrated at right. Never remove the plates for any reason.

La plaque signalétique est fixée sur le moteur (voir illustration à droite).

En aucun cas ne retirer cette plaque.

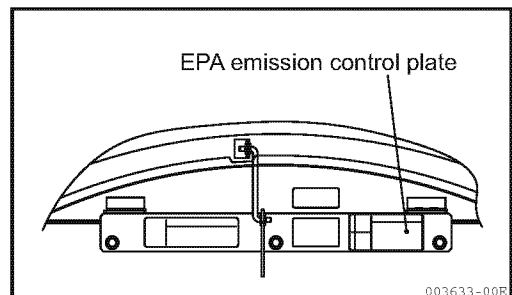
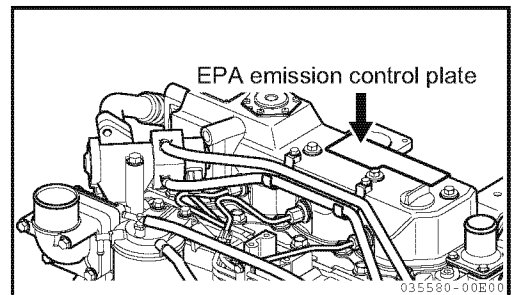

5-4. Ordering replacement parts and service calls

When ordering replacement parts or calling for service, let your dealer know the model designation, the machine serial number, and the engine serial number as well as the reading of the hour meter.

- Machine serial number plate

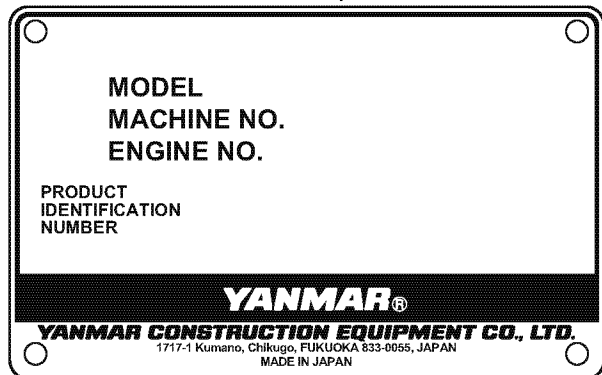

- Hour meter

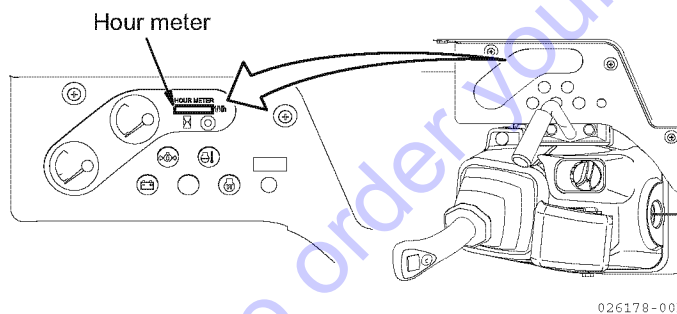

Go to Discount-Equipment.com to order your parts

6. Contents

1. Introduction	0-1
2. Safety Information	0-2
3. Product Overview	0-3
3-1. Intended uses	0-3
3-2. Break in period	0-3
3-3. Conditions to be met to assure compliance with EPA emission standards	0-4
3-4. Emission system warranty	0-5
4. Operation License	0-11
5. Ordering Replacement Parts and Service Calls	0-12
5-1. Location of machine serial number plate	0-12
5-2. Location of engine serial number plate	0-12
5-3. Location of EPA emission control plates	0-12
5-4. Ordering replacement parts and service calls	0-13
6. Contents	0-14

SAFETY

7. Basic Precautions	1-2
8. Operating Precautions	1-6
8-1. Precautions before starting the engine	1-6
8-2. Precautions for starting the engine, working and parking	1-8
8-3. Precautions for transportation	1-13
8-4. Precautions for the battery	1-14
8-5. Precautions for towing	1-15
8-6. Precautions for hooked bucket	1-16
9. Precautions for Servicing	1-19
9-1. Precautions before servicing	1-19
9-2. Precautions during servicing	1-21
10. Safety Messages (Warning Labels)	1-25
10-1. Location of warning labels	1-25

OPERATION

11. Identification of Important Parts	2-2
11-1. Overview of the machine	2-2
11-2. Controls and switches	2-3
12. Description of Control Devices	2-4
12-1. Monitors	2-4
12-2. Switches	2-8
12-3. Control levers and pedals	2-12
12-4. Engine hood	2-17
12-5. Storage compartment for the operation & maintenance manual	2-17
12-6. Tool storage space	2-18

12-7. Bonnet B	2-18
12-8. Bonnet R	2-19
12-9. Windshield	2-20
12-10. Hammer for emergency escape from operator's cab.....	2-23
12-11. Operator's seat	2-24
12-12. Headlight.....	2-25
12-13. Ash tray.....	2-25
12-14. Right window glass	2-26
12-15. Cabin side door.....	2-26
12-16. Air Conditioner	2-27
12-17. Replenishment of windshield washer fluid	2-31
12-18. Fuse	2-31
12-19. External power socket.....	2-33
13. Operating Instructions	2-34
13-1. Checking before starting the engine	2-34
13-2. Starting up the engine	2-45
13-3. Operating and checking instructions after starting the engine	2-48
13-4. Traveling	2-50
13-5. Steering.....	2-54
13-6. Stopping the machine	2-56
13-7. Swinging the upperstructure	2-57
13-8. Operating the implement.....	2-58
13-9. Precautions for operating the implement	2-59
13-10. Precautions for working	2-62
13-11. Precautions for going up and down a slope.....	2-63
13-12. Escaping from the mud	2-65
13-13. Operations using the bucket	2-66
13-14. Handling quick coupler.....	2-67
13-15. Parking the machine	2-77
13-16. Inspection requirements after completing operation	2-78
13-17. Stopping the engine	2-79
13-18. Inspection requirements after stopping the engine	2-80
13-19. Locking.....	2-80
13-20. Handling the rubber crawlers	2-81
13-21. Handling hydraulic P.T.O.	2-86
13-22. Releasing the internal pressure of the hydraulic circuit by accumulator	2-91
13-23. Replacing the bucket without the quick coupler.....	2-93
13-24. Reversing the bucket without the quick coupler.....	2-95
14. Transportation	2-97
14-1. Loading and unloading the machine	2-97
14-2. Precautions for loading the machine.....	2-99
14-3. Precautions for transporting the machine	2-100

14-4. Suspending the machine	2-101
15. Care and Service in Cold Weather	2-103
15-1. Preparing for cold weather	2-103
15-2. Precautions after a day's work	2-105
15-3. After cold weather ends	2-105
16. Long-term Storage	2-106
16-1. Before storing.....	2-106
16-2. Storing.....	2-107
16-3. Using the machine again	2-107
17. Troubleshooting	2-108
17-1. Phenomena that do not constitute faults.....	2-108
17-2. Towing	2-109
17-3. If the battery is overdischarged.....	2-110
17-4. Troubleshooting	2-115

MAINTENANCE

18. Precautions for Servicing	3-2
19. Basic Servicing Practices	3-5
19-1. Oils, fuel, and cooling water	3-6
19-2. Electrical equipment.....	3-9
19-3. Hydraulic system.....	3-10
20. Consumables	3-11
21. Fueling, Oiling and Greasing Based on Temperature Range	3-12
21-1. Fuel and oil	3-12
21-2. Cooling water	3-12
22. Standard Tightening Torque for Bolts and Nuts	3-13
22-1. Required tools.....	3-13
22-2. Torque table.....	3-14
23. Replacing Essential Parts Periodically	3-15
24. Maintenance Table.....	3-17
24-1. Table of service time intervals	3-17
24-2. Service intervals when using the hydraulic breaker.....	3-21
25. Procedures for Maintenance	3-22
25-1. First services	3-22
25-2. Nonperiodic services.....	3-23
25-3. Checking before start-up.....	3-44
25-4. Maintenance every 50 service hours	3-52
25-5. Maintenance every 100 service hours	3-53
25-6. Maintenance every 250 service hours	3-54
25-7. Maintenance every 500 service hours	3-60
25-8. Maintenance every 1000 service hours	3-64
25-9. Maintenance every 1500 service hours	3-68

25-10. Maintenance every 2000 service hours 3-68
25-11. Maintenance every 3000 service hours 3-71

SPECIFICATIONS AND DIMENSIONAL DIAGRAMS

26. Specifications and Dimensional Diagrams 4-2

OPTIONAL PARTS AND ATTACHMENTS

27. General Precautions 5-2
 27-1. Safety precautions 5-2
 27-2. Precautions for mounting an attachment (implement) 5-3
28. Handling the Hooked Bucket..... 5-4
 28-1. Checking the hooked bucket for damage 5-4
 28-2. Prohibitions 5-4
 28-3. Precautions 5-4
29. Optional Parts and Attachments 5-5
 29-1. Optional parts and attachments 5-5

NOTES

30. Maintenance Log..... 6-2
31. Notes 6-6

Go to Discount-Equipment.com to order your parts

SAFETY

WARNING

Never attempt to operate or service this Excavator until you have first read and understood all of the applicable Safety Instructions that are set forth in this Manual.

The failure to comply with all relevant Safety Instructions could result in bodily injury.

7. Basic Precautions

⚠ WARNING These instructions should be strictly followed for the safety of you, others and your machine.

Follow safety rules at your workplace

- The operation and servicing of this machine is restricted to qualified persons.
- When operating or servicing the machine, follow all the safety rules, precautions and procedures.
- Any work performed by a team or with a signal person should be conducted in accordance with signals agreed on beforehand.

Install safety devices

- Make sure that all guards and covers are installed in their correct position. If any of them are damaged, repair them immediately.
- The proper use of all safety devices, such as lock lever, should be well understood by the machine operator.
- Never remove the safety devices. Always make sure that they operate properly.
For lock lever, refer to Section "12-3. Control levers and pedals".
- Incorrect operation of the safety devices could cause serious bodily injury.

Wear proper clothing and safety items

- Do not wear loose clothing or jewelry that can be caught on the control levers and other machine parts. Also avoid wearing working clothes stained with oil as they can ignite.
- Be sure to wear a helmet, safety goggles, safety shoes, a mask, gloves and other protective items, as appropriate. Take particular precautions when generating metal debris, when striking metal objects with a hammer or when cleaning components with compressed air.

Also make sure there are no persons near the machine.

For driving the pins, refer to Section "13-23. Replacing the bucket without the quick coupler".

For cleaning the fuel, oil and air filter elements, refer to Section "25-2. Nonperiodic services".

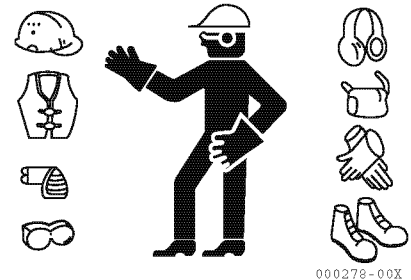

Alcohol

- Never operate the machine after consuming alcoholic beverages, or while you are under the influence of alcohol or if you feel ill or unwell, as that could result in accidental bodily injury to yourself or others.

Avoid unauthorized modifications

- Modifications not recommended by YANMAR may cause safety hazards.
- When you wish to modify your machine, contact your dealer. The implementation of unauthorized modifications or the use of unauthorized attachments could result in bodily injury. Since those actions would also violate the terms of YANMAR's Warranty, it would be voided.

Always lock up your machine when leaving the operator's seat

- When leaving the operator's seat, be sure to place the lock lever in the lock position, to prevent accidental machine movement which could result in bodily injury.
- When you leave the machine:
 - (1) Lower the bucket to the ground.
 - (2) Place the lock lever in the lock position.
 - (3) Stop the engine.
 - (4) Set all the locks in to the lock position.
 - (5) Be sure to take the starter switch key out of the starter switch.

For information on parking the machine, refer to Section "13-15. Parking the machine".

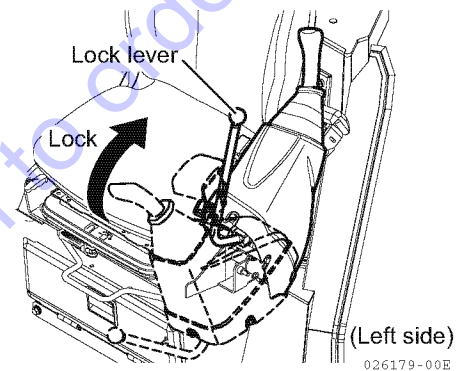

Use handrails and steps when getting on and off

- Do not jump on or off the machine. Never get on or off a machine in motion as it may result in bodily injury.
- When getting on and off the machine, face the machine and use the handrails and steps.
- Do not use control levers as handrails.
- Make sure that you maintain three point contact with the handrails or the steps.
- If the handrails and the steps are soiled with oil or dirt, clean them off immediately. Repair any damaged parts and retighten any loose bolts.

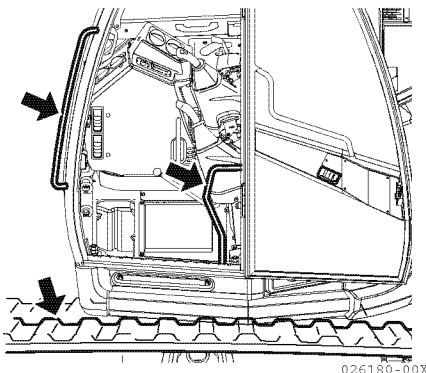

Keep fuel and oil away from sources of ignition

- Open flames can ignite fuel, oil, hydraulic oil or antifreeze solutions, which are flammable and dangerous. Special attention must be paid to the following matters:
 - Keep flammable materials away from lighted cigarettes or matches, or any other sources of ignition.
 - Never refuel while the engine is running. Smoking during refueling must be strictly prohibited.
 - Firmly tighten the caps on the fuel and oil tanks.
 - Store fuel and oil in a cool and well-ventilated place where they are not subjected to direct sunlight.
 - Fuel and oil must be stored in a place which meets all applicable safety regulations. Unauthorized persons should not be allowed entry.

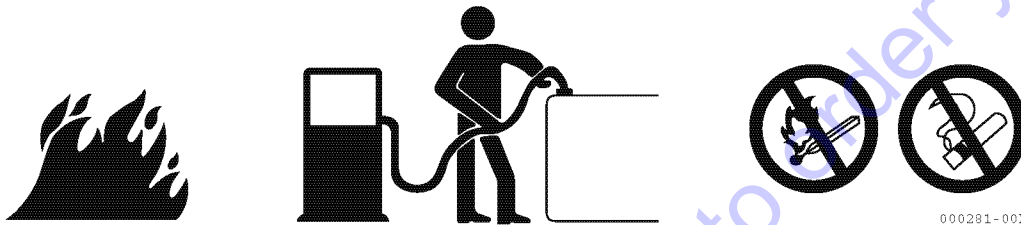

Avoid removing filler caps while temperatures are high

- The engine coolant, engine oil and hydraulic oil are hot and under pressure immediately after the machine stops operation. Removing caps, draining coolant or oil, or replacing a filter at such a time may cause burns. Allow temperatures to cool down and follow the procedures in this manual.
- When removing the radiator cap, stop the engine and allow the coolant to cool down, then turn the cap slowly to relieve all pressure.
- Before removing the cap from the hydraulic oil tank, stop the engine and turn the cap slowly to relieve all pressure to prevent oil from spouting out.

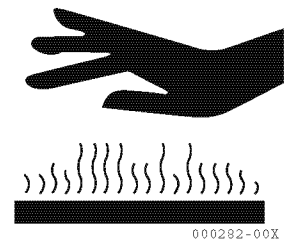

Avoid harmful asbestos dust

- Air containing asbestos dust is carcinogenic and is hazardous to humans. Inhalation of the air may cause lung cancer. When handling materials that may contain asbestos, keep in mind that:
 - Compressed air must not be used for cleaning.
 - Water must be used to clean the machine to prevent asbestos from scattering in the air.
 - You must work on the windward side when operating the machine in a place where there may be asbestos dust.
 - You should wear an appropriate respirator as necessary.



Prevent crush injuries by the implements

- Keep hands, arms and all other parts of your body away from all the moving parts, particularly between the implements and the machine and between the hydraulic cylinder and the implements, as pinch points are created in those areas.



000284-00X

Keep a fire extinguisher and first aid kit handy

- The workplace must be provided with a fire extinguisher. Read instructions on the label to familiarize yourself with how to use it.
- Keep a first aid kit in a prescribed place.
- Know what to do in the event of a fire or an accident.
- Know who to contact in an emergency and keep emergency telephone numbers in a prominent place.

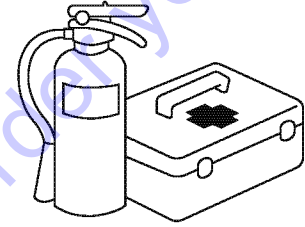

000285-00X

Precautions for installing optional parts and attachments

- When installing or using optional attachments, read the operating instructions for the attachments and the Manual Sections relating to the installation of attachments.
- Use only attachments authorized by YANMAR. The use of unauthorized attachments may affect not only the safety of the machine but also the proper operation and life of the machine.
- The use of unauthorized attachments would also violate the terms of YANMAR's Warranty, so that it would be voided.

Caution for broken cabin glass

- If the glass in a cabin window should be broken by accident, the jagged edges pose a danger to the operator. Immediately stop working and remove the broken glass, and replace it as soon as possible.

Emergency escape from operator's cab

- If the door of the cabin should not open, break the window glass with a hammer which is provided inside the cabin to escape from the operator's cab in an emergency.
- Remove the broken pieces of the window glass from the window frame to prevent any injury by those broken pieces. Besides, watch your step not to slip on the broken pieces of the window glass which dropped around your feet.

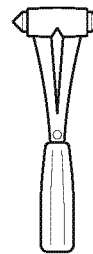

Hammer

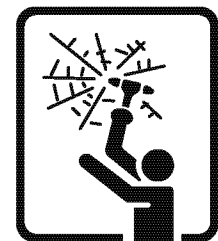

003637-00E

For instructions on how to escape, refer to Section "12-10. Hammer for emergency escape from operator's cab".

8. Operating Precautions

⚠ WARNING These instructions should be strictly followed for the safety of you, others and your machine.

8-1. Precautions before starting the engine

Ensure the safety of your workplace

- Before starting the machine, check to see if there are any hazards in your working area.
- Examine the terrain and soil, and decide the best way to do the work.
- When working on the street, provide a signal person or fence for the safety of vehicles and pedestrians.
- If there are underground utilities at the work site, such as water pipes, gas pipes, high-voltage conduits or others, contact the responsible companies to locate them exactly, so as not to damage them.
- Before operating the machine in water, or crossing a creek, confirm the condition of the submerged ground, the water depth and the water flow speed, and make sure that the depth is within the allowable level.

For allowable water depth, refer to Section "13-10. Precautions for working".

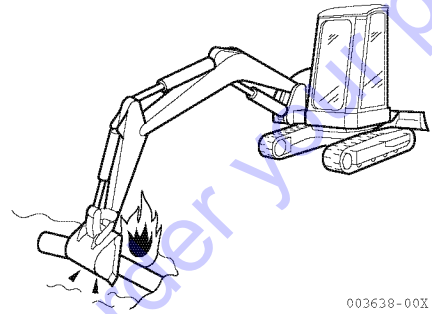

Prevent fire

- Wood chips, dead leaves, trash and other flammable materials in proximity to the engine are hazardous as they may cause fire. Always check and keep your machine clear of these flammable materials.
- Check for any leaks from fuel, lube oil or hydraulic oil lines. Repair faults and clean spilled oil as necessary.

For additional information, refer to Section "13-1. Checking before starting the engine".

- Check to see where fire extinguishers are located and know how to use them.

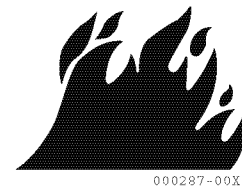

Inspect around the operator's seat

- Dirt, oil and snow on the floor, levers, handrails or steps are slippery and hazardous. Remove them all completely.
- Keep parts and tools away from the operator's seat as they may damage the control levers or switches or create other hazards.

Provide adequate ventilation when working in an enclosed area

Engine exhaust fumes are harmful to the human body and their inhalation is extremely hazardous. When starting the engine in an enclosed area, open the windows and doors for ventilation. Also do not idle the engine unnecessarily or leave the engine running while the machine is not in use.

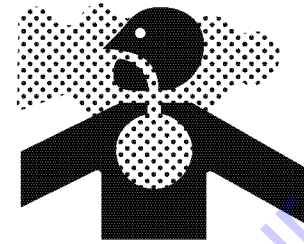

Keep the cabin window clean

- Keep the surface of the cabin windows and the headlights clean for clear view.
- Make sure that your machine is equipped with headlights and all required working lamps, and that they all work properly.

Fasten the seatbelt

- For your safety, ROPS (Roll-Over Protective Structure)/OPG (Operator Protective Guards) and a seatbelt have been provided.
- Always fasten the seatbelt across the pelvic region and adjust it snugly before you operate the machine.
- The seatbelt must be replaced if the machine is involved in an accident.
- In addition, the seat and the seat mounting must also be checked by your dealer after an accident has occurred.
- If the seat and the seat mounting are damaged, they must be replaced immediately.

ROPS/OPG

- Never modify a structural member of the ROPS/OPG.
- If the ROPS/OPG is damaged, replace it immediately to prevent bodily injury. Never repair or modify it.

Caution for the protection of plants from hot wind and exhaust gases

The wind and exhaust gases from the radiator and the muffler respectively are very hot. Plants directly exposed to hot wind or exhaust gases may die. Erect a barrier to protect plants from hot wind and exhaust gases when working near them.

8-2. Precautions for starting the engine, working and parking

Signal before starting the engine

- Check the machine carefully before initial start up for the day.
- Make sure there are no persons near the machine before getting on it.
- Never start the engine when the "SERVICING IN PROGRESS" tag is attached to the control system.
- Sound the horn to alert people nearby before starting the engine.
- Be sure to start the engine and operate the machine from the operator's seat only.
- Do not allow any other persons to get on the machine.

Check the position of the blade before operating the machine

- Check the position of the blade before operating the travel levers. When the blade is located in the back, the operation of the travel levers is reversed.

For instructions on How the machine travels, refer to Section "13-4. Traveling".

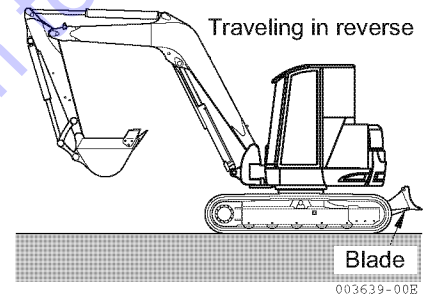

Make sure there are no persons nearby when turning or reversing the machine

- A signal person should be provided for safety when the work site is hazardous or when visibility is poor.
- Keep all other persons away from the work site or the traveling path of the machine.
- Alert persons nearby with a horn or other signal before starting the machine.
- The machine permits a limited range of vision toward the rear. Make sure there are no persons behind the machine before reversing.

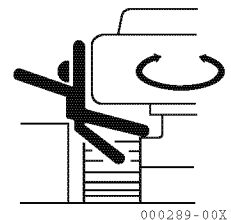
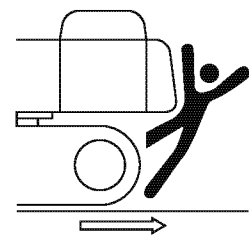

Precautions for traveling

- When traveling with the machine, keep the bucket 16 to 20 in. (40 to 50 cm) above the ground with boom and arm folded as illustrated below.
- If you need to operate the control levers while traveling, never move them abruptly.
- Travel the machine at a low speed and slow down when turning on rough terrain.
- Avoid running over obstacles if possible. If unavoidable, run the machine at a low speed while keeping the implement close to the ground. Never run over obstacles that may cause the machine to tilt more than 10 degrees.

Orientation in travel

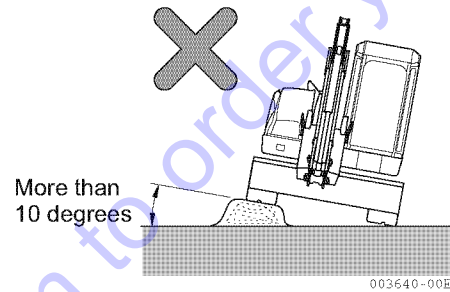
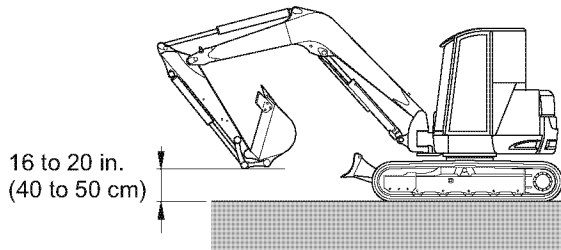

Running the machine on a slope

- Run the machine carefully on a slope to avoid overturning or skidding sideways.
- When running the machine on a slope, keep the bucket 8 to 12 in. (20 to 30 cm) above the ground so that you can immediately lower it to the ground and stop the machine in an emergency.
- Never turn the machine on a slope or run it across the slope. Move down to flat ground and then make a turn.

For instructions on how to run the machine on a slope, refer to Section "13-11. Precautions for going up and down a slope".

- On grasses, dead leaves or a wet metal plate, even with a slight gradient, the machine will easily slip. Under those circumstances, run the machine carefully at low speed to prevent it from skidding.

Going down a slope

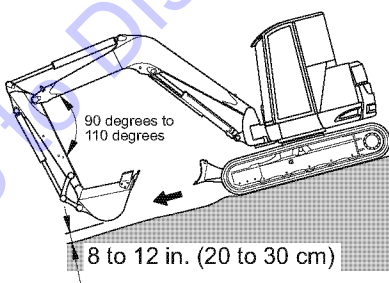

Going up a slope

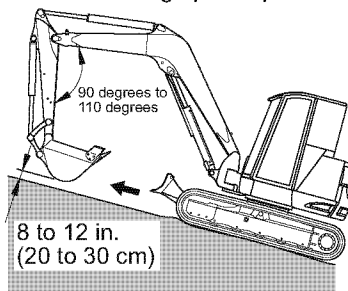

Running across a slope

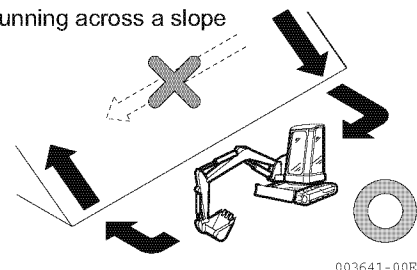

Avoid hazardous work

- Undermining a cliff is dangerous as it may cause a rockslide or landslide.
- Undercutting the machine is dangerous as it may cause a cave-in, resulting in the machine overturning and falling into the excavation.

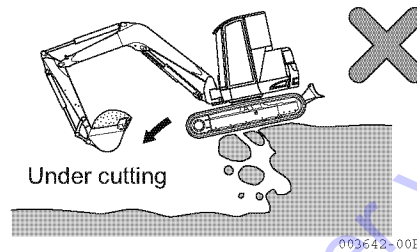
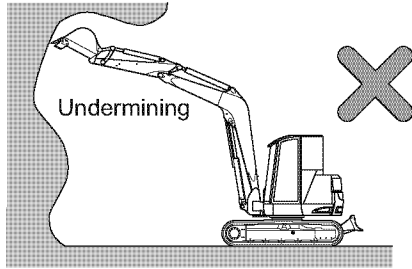

Never suspend loads without a hooked bucket

- Suspending loads without a hooked bucket is extremely hazardous.
- To suspend loads, the machine must be equipped with a hooked bucket specifically designed for the purpose.

For information on suspending loads, refer to Section "13-9. Precautions for operating the implement".

⚠ DANGER

Keep away from electric power lines

- Working in the vicinity of overhead electric power lines presents a very serious hazard and special precautions must be taken. For purposes of this manual you are considered to be working in the vicinity of overhead power lines when the attachment or load of your excavator, in any position, can reach to within the minimum safe distances shown below.
- The following procedures are effective in preventing accidents or injuries.
 - 1) Wear shoes with rubber or leather soles.
 - 2) Use a signal person to warn the operator when the machine is getting too close to a power line.
- If the machine should contact a wire, the operator must not leave the operator's seat.
- When working near power lines, caution all ground personnel to stand clear of the machine.
- To determine the transmission voltage at the working site, contact the electric utility concerned.

	Transmission voltage (V)	Minimum safe distance [ft. (m)]
Power distribution	100/200 or less	7 (2) or more
	6600 or less	7 (2) or more
Transmission line	22000 or less	10 (3) or more
	66000 or less	13.5 (4) or more
	154000 or less	16.5 (5) or more
	275000 or less	23 (7) or more

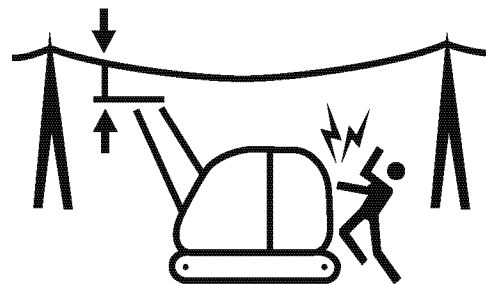

000293-00X

Prevent bumping the implements

- When traveling through tunnels or under bridges, or working at a site near other overhead obstacles, operate the machine carefully so as not to bump the boom, arm or the implement against those overhead obstacles.

Work only where visibility is good

- When working in a dark place, light up the area with the work lights and head lights, and prepare extra lighting equipment as necessary.
- Stop working when fog, snow or rain impedes your view.

Work carefully in a snow-covered areas

- Snow-covered ground and icy roads are dangerous as they may cause the machine to skid even on a slight slope. Run the machine at low speed, and never start, stop or turn abruptly on such ground or under such road conditions.
- Be careful removing snow as road shoulders or other hazards may be buried under snow.

Unstable ground creates a high possibility of overturn

- Keep away from cliffs, road shoulders or trenches if possible as the ground near them is unstable. The ground may crumble due to the weight or vibrations of the machine, resulting in an overturn or fall of the machine. Be particularly careful when working immediately after a rainstorm or after blasting as the ground may be unstable.
- Ground-fills or ground near a ditch may be unstable and may crumble due to the weight or vibrations of the machine, causing the machine to tilt. Much caution must be taken in working in these areas.
- When working in an area where there is a high possibility of falling rocks, wear a hard-hat and stay under the canopy.

Using the quick coupler

- Observe the procedures of mounting and dismounting the bucket.
- Always securely and correctly install the lock pin when the bucket is mounted on the quick coupler.
- Replace the lock pin whenever it is damaged or lost.

For information of handling the quick coupler, refer to Section "13-14. Handling quick coupler".

Working on a slope

- Be aware that the machine may tip over when swinging the upperstructure or swinging the implement on a slope.
- Never swing the upperstructure toward the downward side of the slope with earth loaded in the bucket.
(See the illustration at upper right.)
- If swinging is unavoidable, level off a work area to maintain the machine as horizontal as possible, then swing.
(See the illustration at lower right.)

For levelling off a work area, refer to Section "13-11. Precautions for going up and down a slope".

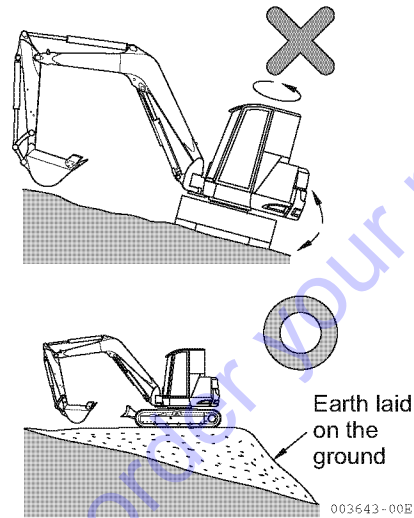

Parking the machine

- Park on level ground. If parking on a slope is unavoidable, block the tracks with solid pieces of wood and dig the bucket into the ground. (See the illustration at right.)
- If necessary to park the machine on the side of a road, set up a warning flag, fence, or lamp that can be easily recognized by passing cars and pedestrians but does not impede them.

For parking procedures, refer to Section "13-15. Parking the machine".

- When leaving the operator's seat, do the following:
 - (1) Be sure to place the bucket on the ground.
 - (2) Set the lock lever to the lock position.
 - (3) Stop the engine.
 - (4) Set all the locks to the lock position.
 - (5) Be sure to take the starter switch key out of the starter switch.

For information about parking procedures, refer to Section "13-15. Parking the machine".

For information about the parts to be locked, refer to Section "13-19. Locking".

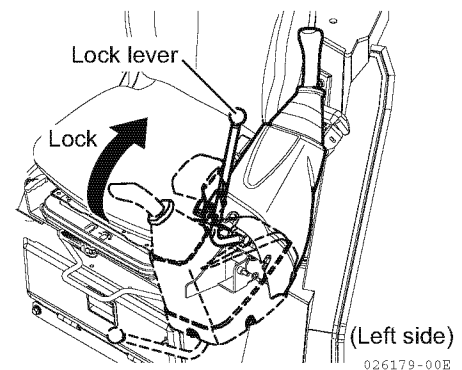
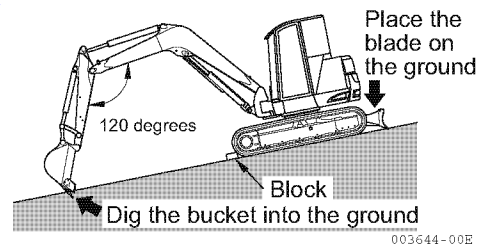

8-3. Precautions for transportation

Precautions for loading and unloading the machine

- Be careful in loading and unloading the machine, because it is a job of high hazard potential.
- Load or unload the machine at a low engine speed, and low travel speed.
- Load or unload the machine on the level, solid ground away from the shoulder of the road.
- Use ramp plates of adequate strength with hooks on their ends.

Check to see that the ramp plates are wide, long, and thick enough to sustain the load so that you can load or unload the machine safely. Support the ramp plates with blocks, to provide additional strength.

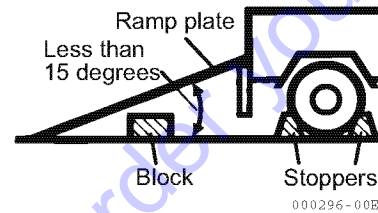

- Securely hook the ramp plates to the deck of the truck so that they will not come off.
- Remove grease, oil, and other slippery deposits from the ramp plates, and remove mud from the tracks to prevent the machine from skidding on the ramp plates.
- Do not load or unload the machine if the ramp plates are slippery because of rain, snow or ice.
- Never change travel direction while on the ramp plates. If you need to change travel direction, go down the ramp plates, and change direction on the ground.
- After loading the machine, block it with lumber and secure the machine with a chain or a wire rope so that the machine will not move during transit.

For instructions on loading and unloading the machine, refer to Section "14. Transportation".

For instructions on securing the machine, refer to Section "14. Transportation".

Precautions for transporting

- Transport the machine safely in accordance with local regulations and applicable law.
- Select a travel route consistent with the width, height and weight of the machine loaded on the truck.

8-4. Precautions for the battery **DANGER****Be careful in handling the battery**

- The battery electrolyte contains dilute sulfuric acid, which can severely burn the eyes or skin. Always wear safety goggles and protective clothing when servicing the battery. If contact with the eyes or skin should occur, flush with a large amount of water and obtain prompt medical treatment.
- Because flammable hydrogen gas is produced by the battery, ignition and explosion may occur. Keep flames and sparks away from the battery.
- Do not use or charge the battery if the battery electrolyte level is below the lower limit. Doing so may cause the battery to explode. Always check the battery electrolyte level before starting the engine. If the electrolyte level is low, add distilled water to the upper limit.
- If you swallow battery electrolyte by mistake, drink a large amount of water, milk, or fresh eggs, and obtain medical treatment immediately.
- Before checking or handling the battery, be sure to stop the engine and turn the starter switch to the "OFF" position.
- Be careful not to cause a short circuit by placing a tool across the terminals of the battery.
- If a terminal connection is loose, sparks may be generated due to contact failure, causing possible ignition and explosion. Be sure to connect the terminals securely.
- Do not use the machine with the battery which is short of battery electrolyte. The shortage of battery electrolyte not only will reduce the life of the battery but also could cause an explosion.

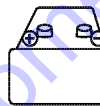
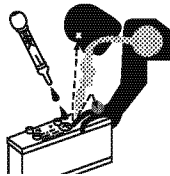
 **WARNING****Observe the procedures for starting the engine using booster cables**

- When you start the engine using booster cables, wear safety goggles.
- If you start the engine by taking electric power from another machine, do not allow your machine to contact the other machine.
- To connect the booster cables, begin with the positive terminal, and to disconnect them, begin with the negative terminal (ground side).
- If a tool simultaneously touches the positive terminal and the machine, potentially hazardous sparks may be generated.
- Do not connect the booster cables to the terminals in reverse polarity. In other words, never connect the negative terminal on one machine to the positive terminal on the other machine.
- As the last step, connect the negative booster cable terminal to the upper structure frame. At that time, sparks will be generated. Consequently, connect the terminal to a point as far away from the battery as possible.

For information about starting the engine using booster cables, refer to Section "17-3. If the battery is overdischarged".

8-5. Precautions for towing

Hook the wire rope on the frame when towing

- Improper towing procedures can cause death or serious injury.
- When towing a machine with another machine, use a wire rope strong enough to sustain the machine weight.
- Never tow a machine on a slope.
- Do not use a towing rope that is kinked, distorted or damaged.
- Do not ride on the towing cable or on the wire rope.
- When connecting an object to be towed, make sure that no person enters the space between the machine and the object.
- To connect an object to be towed, hook the sling belt as illustrated at right.
- The hook provided on the machine is intended for stabilizing the machine during transporting. Never use it for towing.

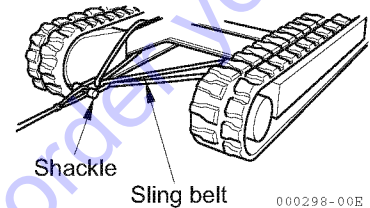

For information about towing the machine, refer to Section "17-2. Towing".

8-6. Precautions for hooked bucket**8-6-1. General precautions****Special hook**

- A dedicated hook is required for suspending a load.
- The following procedures are extremely dangerous and must never be attempted:
 - Suspending a load with a wire rope hooked on the bucket teeth
 - Suspending a load with the wire rope directly hooked on the boom or the arm

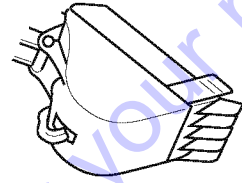

000299-00X

Checking the hook

- Check for abnormalities before suspending a load, as follows:
 - No cracks or deformations in the suspension sling belt and fittings
 - No abnormalities in the locking devices
- Every time you make a voluntary monthly check or a specified annual check, check all suspension gear for abnormalities and enter the results in the inspection records.

Securely attach a wire rope to the hook

- To suspend a load, securely attach a wire rope to the dedicated suspension hook.

Precautions for selecting a place to park the machine

- Survey the terrain and soil and select a solid, level spot for parking the machine, for maximum stability.

Do not use the machine for other than the specified purpose

- Never suspend a person together with the load, under any circumstances, because of the extreme danger.

Keep out of the radius of the work area

- Never permit anyone to enter the work area because of the danger of spilling or swinging the load.

Designate a leader to supervise suspension work

- When suspending a load, designate a leader to supervise the work and follow the leader's instructions.
- Follow the leader's instructions for the handling methods and procedures.
- Define hand signals in advance for communicating, and respond to the leader's signals.

Handling the wire rope

- When handling the wire rope, use leather gloves.

For additional information about the hooked bucket, refer to Section "28. Handling the Hooked Bucket".

Go to Discount-Equipment.com to order your parts

8-6-2. Precautions for suspending a load**Move a suspended load slowly**

- Raise and swing a suspended load slowly.
- Do not operate the control levers or the accelerator lever abruptly.
- The swing speed is three to four times higher than that of a truck crane. Swing the upper structure slowly.

Do not leave the operator's seat

- Never leave the operator's seat with a load suspended.

Do not operate the machine unsafely

- Working beyond the machine's capacity can cause accidents or failures. Suspend loads within the machine's capacity.
- Do not suspend a load greater than the specified maximum, or subject it to a sharp impact. Those actions may damage the machine.
- Do not move the suspended load sideways or toward the machine, or haul it. Those actions are extremely dangerous.

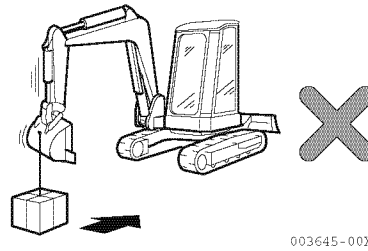
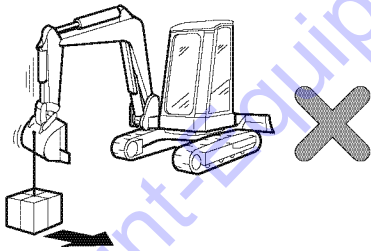

003645-00X

Do not travel while suspending a load

- Do not travel while suspending a load.

Make sure of the posture of the machine

- If the bucket hook is not maintained in a vertical position, the wire rope or the shackle may slip off the hook. Be careful to maintain a vertical hook angle, so that the wire rope or the shackle will not come off.

9. Precautions for Servicing

⚠ WARNING Neglecting these instructions may cause extreme hazards.

9-1. Precautions before servicing

Attach the "SERVICING IN PROGRESS" tag to an implement control lever

- If another person should start the engine or operate the control levers while service is in progress, the service personnel can sustain serious bodily injury.

Always attach the "SERVICING IN PROGRESS" tag to one of the implement control levers, while service is in progress.

The "SERVICING IN PROGRESS" tag is enclosed with the Operation & Maintenance Manual.

(Article number : 172437-03250)

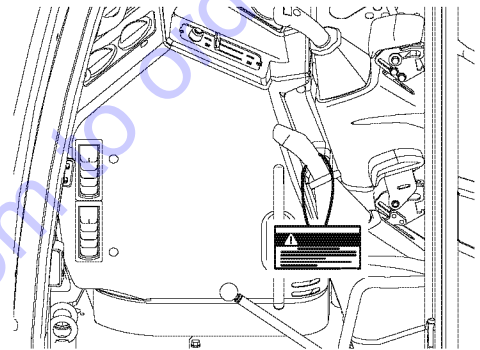

Use appropriate tools

- Using damaged or worn tools or using tools inappropriate for the required application is very dangerous, and may also cause damage to the machine. Make sure to use the tools that are appropriate for the specific job.

For information about tools, refer to Section "22-1. Required tools".

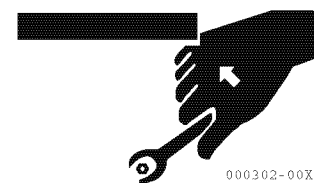

Periodically replace the parts essential to safety

- Aging or damage to the parts listed below can cause a fire. Make sure that they are replaced periodically.
 - Fuel system : Fuel hose and fuel tube cap
 - Hydraulic system : Outlet hose of main pump
- The parts listed above must be replaced periodically even if no abnormality is found in them. (They age with time.)
- If any abnormality is found in them, replace or repair the parts even though the suggested replacement time has not been reached.

For information about replacing essential safety parts, refer to Section "23. Replacing Essential Parts Periodically".

Stop the engine before beginning inspection and servicing

- Be sure to stop the engine before performing inspection and servicing.
- If necessary to perform service while running the engine, as when cleaning the inside of the radiator, be sure to set the lock lever to the lock position and do the job together with a partner. (One should take the operator's seat so that he or she can stop the engine at any time.) That person must be careful not to touch any levers in the cabin.
- Be extremely careful not to contact the moving fan or fan belt, or any hot surfaces.

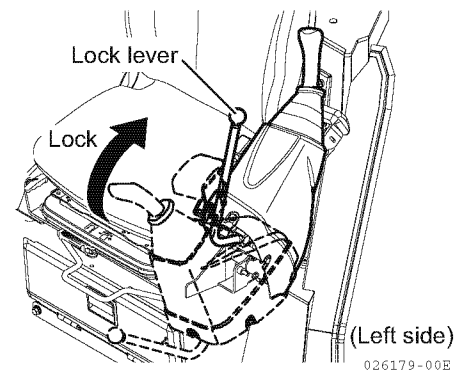
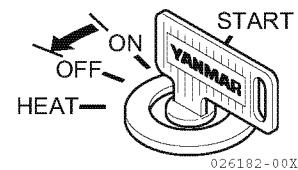

9-2. Precautions during servicing

Keep unauthorized persons away

- Never admit any persons into the work area who are not taking part in the work. Be conscious of the safety of other persons.
Be especially careful when grinding, welding, or using a large hammer.

Removed attachments

- When an attachment is placed on the ground or against a wall after removing it or prior to reinstalling it, be sure that it is stable to prevent it from falling down.

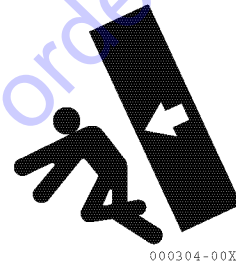

000304-00X

Working under the machine

- Before performing service or repairs underneath the machine, place the implement on the ground in its lowest position.
- Be sure to apply blocks to the tracks to lock the tracks securely.
- Never perform service underneath the machine if it is not completely stable.



000305-00X

Keep the machine clean

- Spilled oil or grease, or scattered parts are dangerous and can cause falls. Keep the machine clean.
- Getting water into the electrical system may cause it to malfunction, resulting in faulty operation of the machine. Also it may permit electrical leaks that could cause a fire or electric shocks.
- Never clean the sensors, connectors or the operator's seat with water or steam.

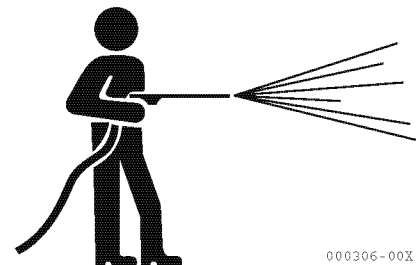

000306-00X

Precautions for fueling and oiling

- Spilled fuel and oil could cause a fire and they are dangerously slippery. Wipe up spills immediately.
- Close the fuel cap and oil cap securely.
- Never use fuel for cleaning.
- Provide good ventilation when replenishing fuel or oil.

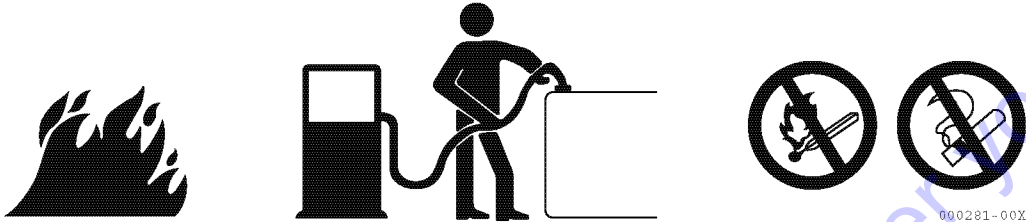
**Radiator cooling water level**

- Before checking the radiator cooling water level, stop the engine and wait until the engine and the radiator have cooled down.
- Slowly loosen the cap to release the inner pressure before removing the cap.

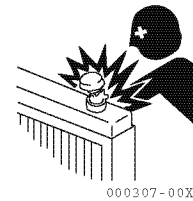
**Use an explosion-proof lighting source**

- Use an explosion-proof lighting source when checking the fuel, the oil, the cooling water, or the battery electrolyte. Failure to use an explosion-proof lighting source may cause ignition to occur, inducing an explosion.

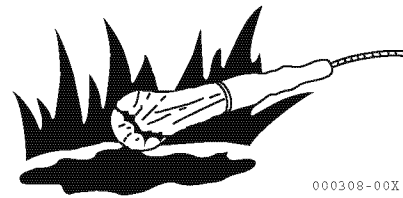
**Precautions for handling battery**

- When welding or repairing the electrical system, disconnect the negative terminal of the battery to interrupt the electric circuit.



Handling hoses

- Leaks of fuel and oil could cause a fire.
Be sure to retighten or repair any loosened or damaged fuel hoses and hydraulic hoses. If oil or fuel leaks, a fire could be caused.
- Do not bend a high-pressure hose forcibly, or strike it with a hard object. Because abnormally bent or damaged piping, tubes, and hoses easily burst under high pressure, never use them.

Be careful of hot oil under high-pressure

- The hydraulic system for the implement operates under high pressure.
When replenishing or draining hydraulic oil, or performing inspection or servicing, be sure to first relieve the high pressure.
- The emission of hot oil under high-pressure from a small leak could result in serious bodily injury.
Wear safety goggles and thick gloves when checking for leaks. Use a piece of cardboard or a plywood block to detect emissions of hot oil.
If the hot oil should contact your body, obtain prompt medical treatment.



000310-00X

Be careful when servicing systems under high temperature and high pressure

- The engine cooling water and various lube oil systems are still under high temperature and pressure immediately after the engine has stopped. Removing caps, draining oil and water, or replacing filter elements at that time may cause a burn. Wait until the temperature drops, then begin servicing in accordance with the procedures described in this manual.

For cleaning the inside of the cooling system, refer to Section "25-2. Nonperiodic services".

For checking the level of the cooling water and the hydraulic oil, refer to Section "25-3. Checking before start-up".

For checking the oil levels in various systems and replenishing the oil, refer to Sections "25-3 to 5. Periodic services".

For replacing the oils in various systems and replacing the filter elements, refer to Sections "25-6 to 8. Periodic services".

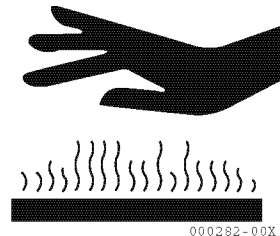

000282-00X

Hazards from high-pressure grease when adjusting the track crawler tension

High-pressure grease is enclosed in the track crawler adjuster.

Failure to use the specified procedures for adjusting the track crawler tension could cause grease plugs or nipples to eject, which could result in bodily injury.

- Do not loosen the grease draining plug more than one turn.
- Never position your face, hands, legs, or body in line with the grease draining plug and valve.

For information about adjusting track crawler tension, refer to Section "25-2. Nonperiodic services".

**Rotating radiator fan and fan belt**

- Never contact the rotating radiator fan or fan belt with any object.
- Contacting the rotating radiator fan or fan belt with any object can result in serious bodily injury.

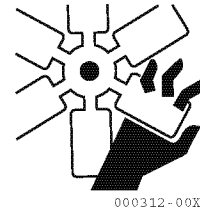
**Processing wastes**

- Do not dispose of waste oil in the sanitary sewer system.
- Always drain the oil from the machine into a secure container, and never directly to the ground.
- When disposing of toxic wastes such as fuel, oil, cooling water, solvent, filters, and spent batteries, comply with all applicable disposal regulations.

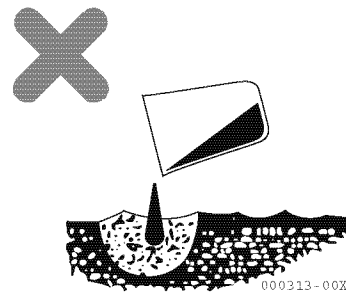

10. Safety Messages (Warning Labels)

There are a number of Warning Labels on the machine. Full descriptions of all Warning Labels and their locations are reviewed in this section. Periodically confirm whether all Warning Labels are still mounted in their correct locations and can be easily read.

If a warning label is missing, damaged or cannot be read, it must be promptly replaced. Also, if a warning label was mounted on a part which is replaced, a new warning label must be installed on the replaced part.

Contact your dealer to obtain new labels. The part code number is shown on each warning label as well as on the reproductions in this manual.

10-1. Location of warning labels

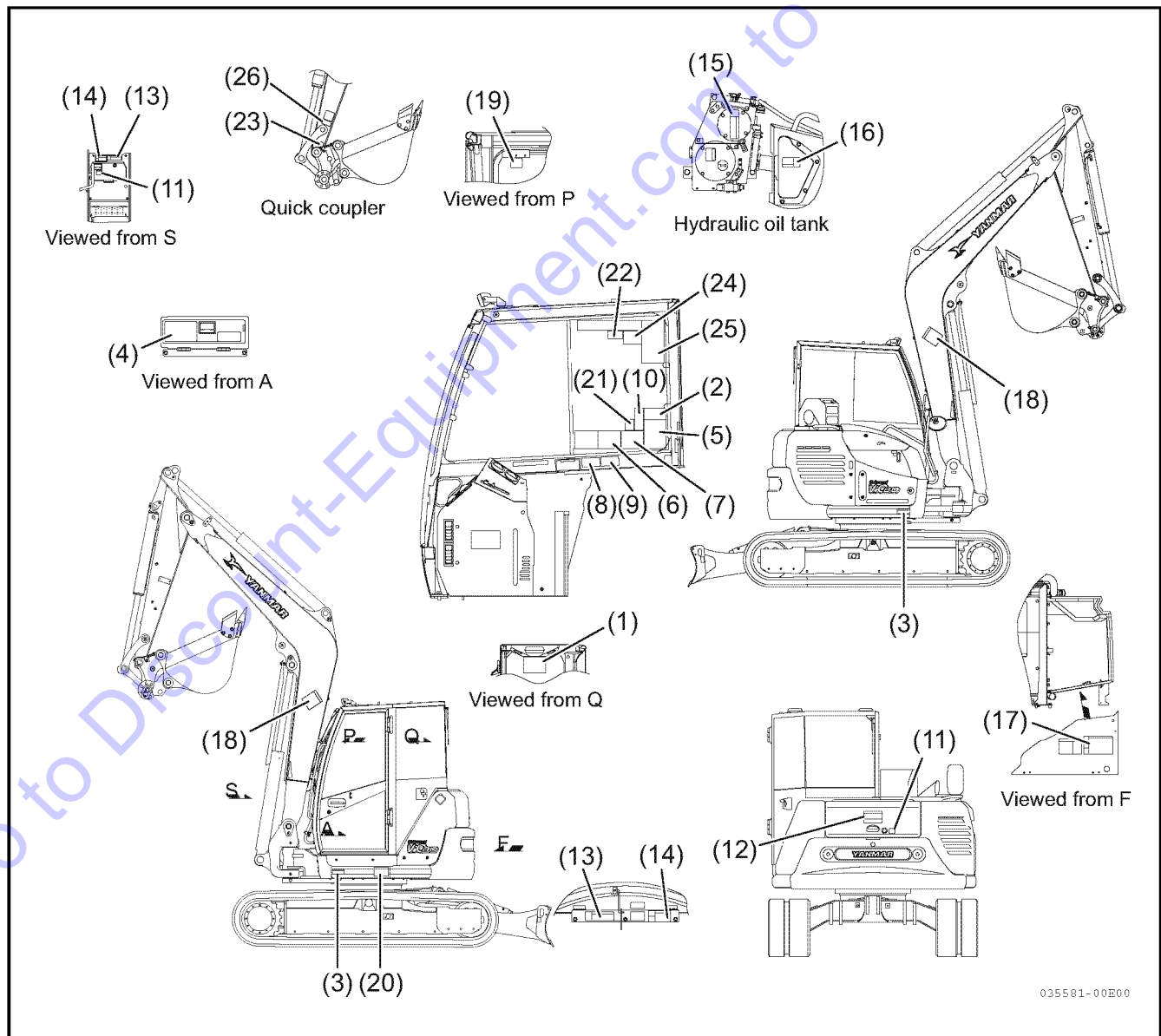

(1) 172A89-03360

WARNING

TIP-OVER HAZARD!
Never allow total bucket weight to exceed excavator lift capacity.

MODEL
ViO80 EXCAVATOR
Quick Coupler Spec.

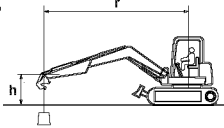

Note where applicable specifications conform to ISO standards.
Loads shown in table include weight of standard bucket (430 lbs. [195 kg])
Weight of all lifting devices and attachment must be deducted to determine load that can be lifted.
Lift point is bucket hinge point with bucket fully curled.
Specifications subject to change without notice.
※Rated Hydraulic lift capacity

LIFT POINT HEIGHT h in. (mm)	(r) LIFT RADIUS · in. (mm)				(r) LIFT RADIUS · in. (mm)				(r) LIFT RADIUS · in. (mm)			
	MAX	RATED LIFT CAPACITY OVER END BLADE DOWN · lbs. (kg)		118.1 (3000)	MAX	RATED LIFT CAPACITY OVER END BLADE UP · lbs. (kg)		118.1 (3000)	MAX	RATED LIFT CAPACITY OVER SIDE BLADE UP · lbs. (kg)		118.1 (3000)
		196.9 (5000)	157.1 (4000)		196.9 (5000)	157.1 (4000)			196.9 (5000)	157.1 (4000)		
196.9 (5000)	*3638 (1650)		*3572 (1620)		*3550 (1610)		*3461 (1570)		2734 (1240)		*3550 (1610)	
157.5 (4000)	*3417 (1550)	*3417 (1550)	*3572 (1620)		2403 (1090)	2734 (1240)	*3417 (1550)		2271 (1030)	2491 (1130)	*3528 (1600)	
118.1 (3000)	*3483 (1580)	*3616 (1640)	*4233 (1920)	*5468 (2480)	2028 (920)	2668 (1210)	*4123 (1870)	*5336 (2420)	1896 (860)	2447 (1110)	*4145 (1880)	*5534 (2510)
78.7 (2000)	*3351 (1520)	*3946 (1790)	*5027 (2280)	*6879 (3120)	1830 (830)	2513 (1140)	3594 (1630)	*6174 (2800)	1697 (770)	2315 (1050)	3395 (1540)	4806 (2180)
39.4 (1000)	*3395 (1540)	*4255 (1930)	*5710 (2590)	*7651 (3470)	1764 (800)	2381 (1080)	3439 (1560)	4564 (2070)	1675 (760)	2249 (1020)	3175 (1440)	4262 (1930)
Ground (0)	*3373 (1530)	*4321 (1960)	*5865 (2660)	*8070 (3660)	1830 (830)	2337 (1060)	3307 (1500)	4873 (2210)	1719 (780)	2160 (980)	3153 (1430)	4542 (2060)
-39.4 (-1000)	*3329 (1510)	*4057 (1840)	*5468 (2480)	*7585 (3440)	2028 (920)	2315 (1050)	3285 (1490)	5137 (2330)	1918 (870)	2160 (980)	3087 (1400)	4692 (2120)
-78.7 (-2000)	*2976 (1350)		*4498 (2040)	*6218 (2820)	2491 (1130)	2491 (1130)	3373 (1530)	5292 (2400)	2425 (1100)	2425 (1100)	3197 (1450)	4972 (2250)

US 172A89-03360

(2) 172437-03312

WARNING

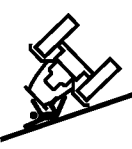

ROLLOVER HAZARD!
NEVER drive on slopes greater than 20 degrees.
NEVER turn on or drive across slopes.
ALWAYS drive with bucket 8 to 12 inches (20 to 30 cm) above ground.
ALWAYS descend at low speed using travel levers or pedals, accelerator and brakes for control as necessary.
Failure to comply could result in death or serious injury.

172437-03312

(3) 172437-03352

WARNING



BURN HAZARD!
CONTENTS UNDER PRESSURE!
ALWAYS relieve pressure in grease cylinder before servicing.
NEVER open valve more than one turn.
Failure to comply could result in death or serious injury.

172437-03352

(4) 172437-03601

WARNING

OPERATING PATTERN

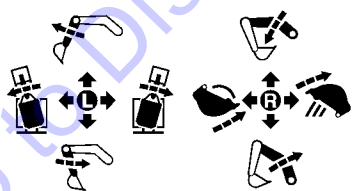

A STANDARD (ISO)

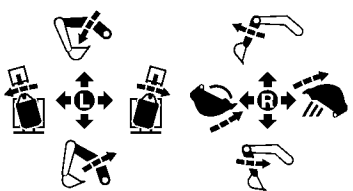

B OPTION

Confirm location of Pattern Change Lever before operating.
Failure to comply could result in death or serious injury.

172437-03601

(5) 172437-03372

WARNING

PROPER OPERATING PROCEDURE:
ALWAYS wear seat belt.
NEVER start excavator unless all safety guards are in place and implement controls are in neutral.
NEVER operate with people on or near excavator.
Start from operator's seat only.
NEVER start engine standing on ground.
Inspect for overhead power lines, obstructions, holes and drop-offs and note location of underground utility lines before operation.
NEVER leave operator's seat until all implements are grounded, hydraulic pressure is relieved for all controls, lock levers are locked and ignition key has been removed.
NEVER attempt to raise chassis off ground with blade and attachment.

172437-03372

(6) 172437-03432

WARNING

Travel levers

Blade

Travel levers

Blade

CRUSH HAZARD!
 Machine travels in direction of blade when travel levers are pushed away from operator.
NEVER move excavator before confirming location of blade and direction of travel.
 Failure to comply could result in death or serious injury.

172437-03432

(7) 172437-03343

WARNING

TRANSPORTATION HAZARD!

- Set parking brake and block wheels of transporting vehicle.
- Use ramps of proper height, length, width and strength with non-skid surfaces.
- Ensure that ramps are secured to vehicle bed and properly aligned.
- Support ramps with blocks or struts for additional strength.
- Support ramps with blocks or struts for additional strength.
- NEVER exceed 15° ramp angle.
- ALWAYS load/unload on solid and level ground.
- ALWAYS securely fasten machine to transporting vehicle using chains and chain binders.

See Operation Manual.
 Failure to comply could result in death or serious injury.

172437-03343

(8) 172437-03302

WARNING

OPERATION HAZARD!
 •Read and understand Operation Manual before operating, maintaining or servicing machine.
 •Failure to comply could result in death or serious injury.

172437-03302

(9) 172437-03471

WARNING

LOCK LEVERS BEFORE LEAVING SEAT!
 Never leave operator's seat unless all lock levers are in locked position, and starter switch key has been removed.
 Failure to comply could result in death or serious injury.

172437-03471

(10) 172437-03451

WARNING

ROLL-OVER HAZARD!
NEVER operate without a seat belt.
NEVER jump if excavator rolls.

172437-03451

(11) 172437-03402



(12) 172437-03381



(13) 172437-03422

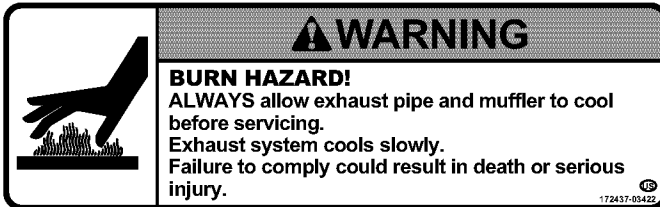

(14) 172A36-03411

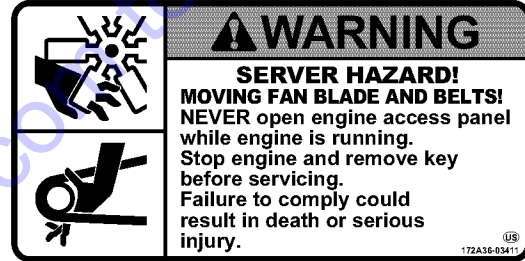

(15) 172437-03322



(16) 172437-03391

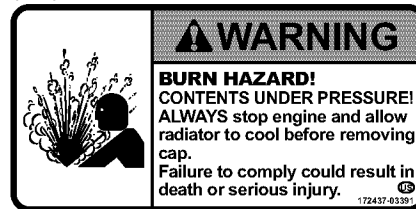

(17) 172437-03361

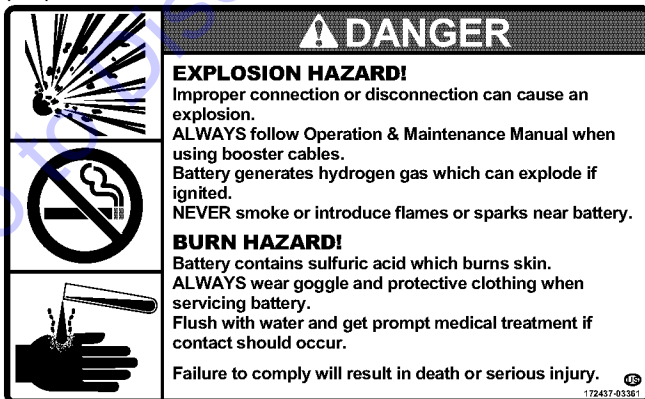

(18) 172187-03941



(19) 172437-03551



(20) 172472-03141

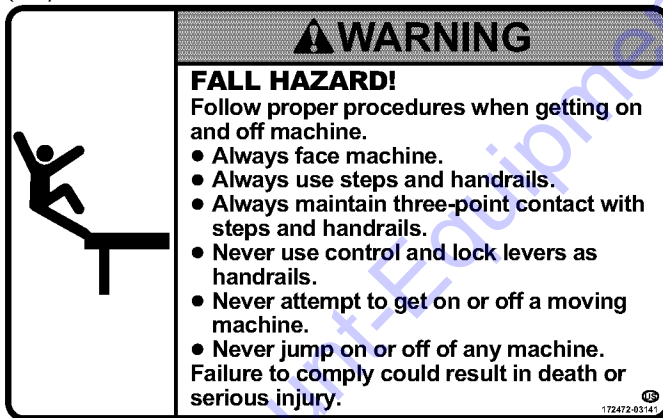

(21) 172437-03441

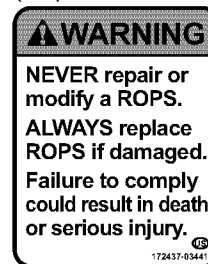

(22) 172472-03241

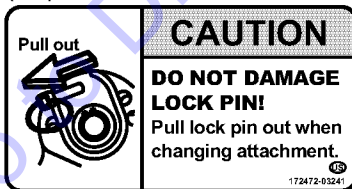

(23) 172472-03261



(24) 172472-03271

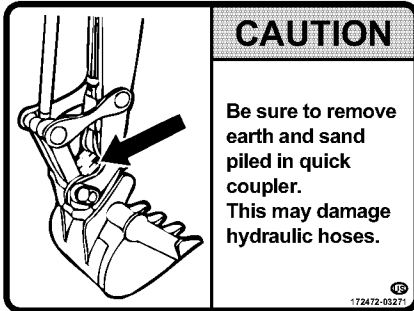

(25) 172472-03281



(26) 172472-03330



OPERATION

Go to Discount-Equipment.com to order your parts

11. Identification of Important Parts

11-1. Overview of the machine

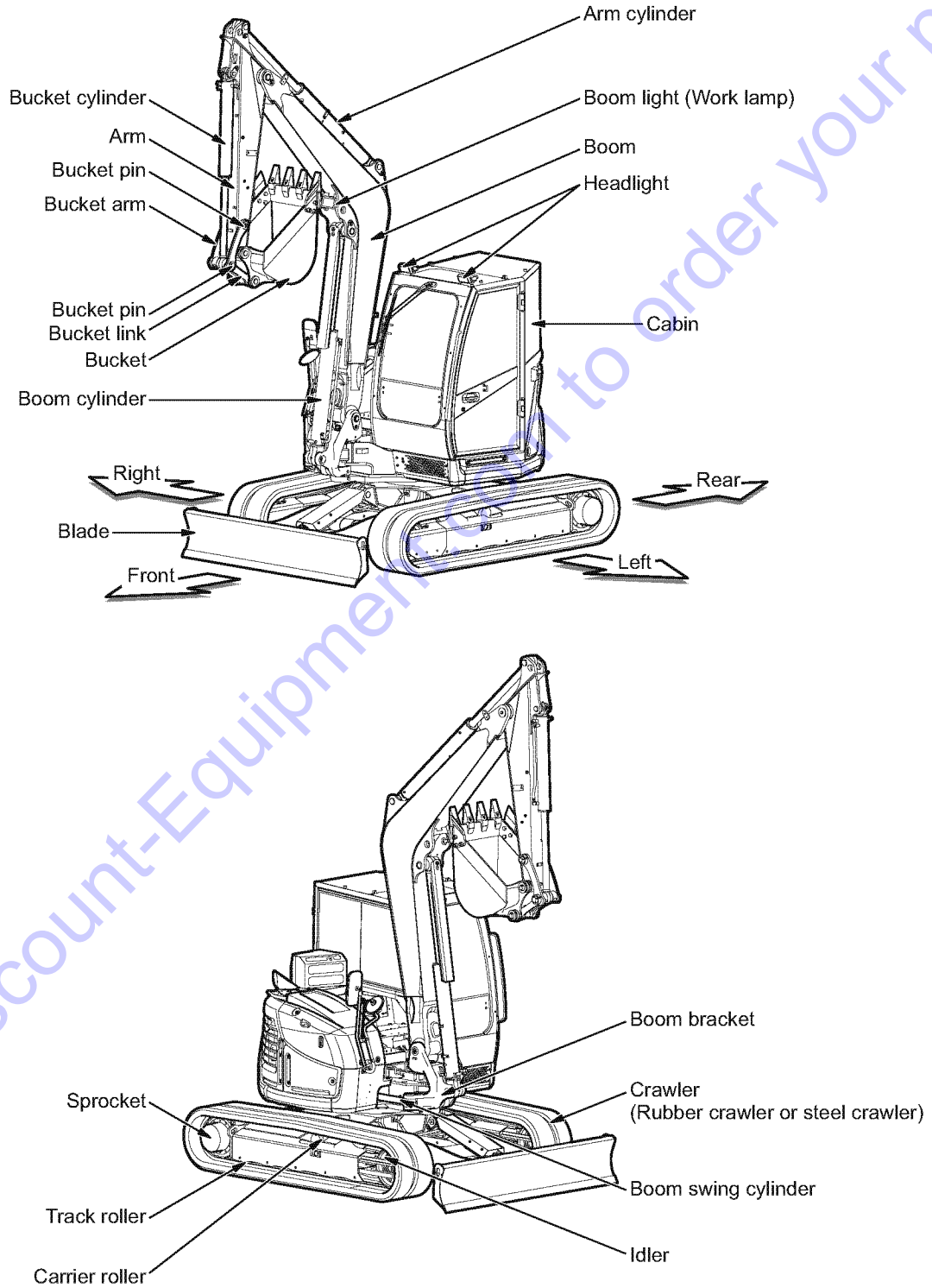

035697-00B00

11-2. Controls and switches

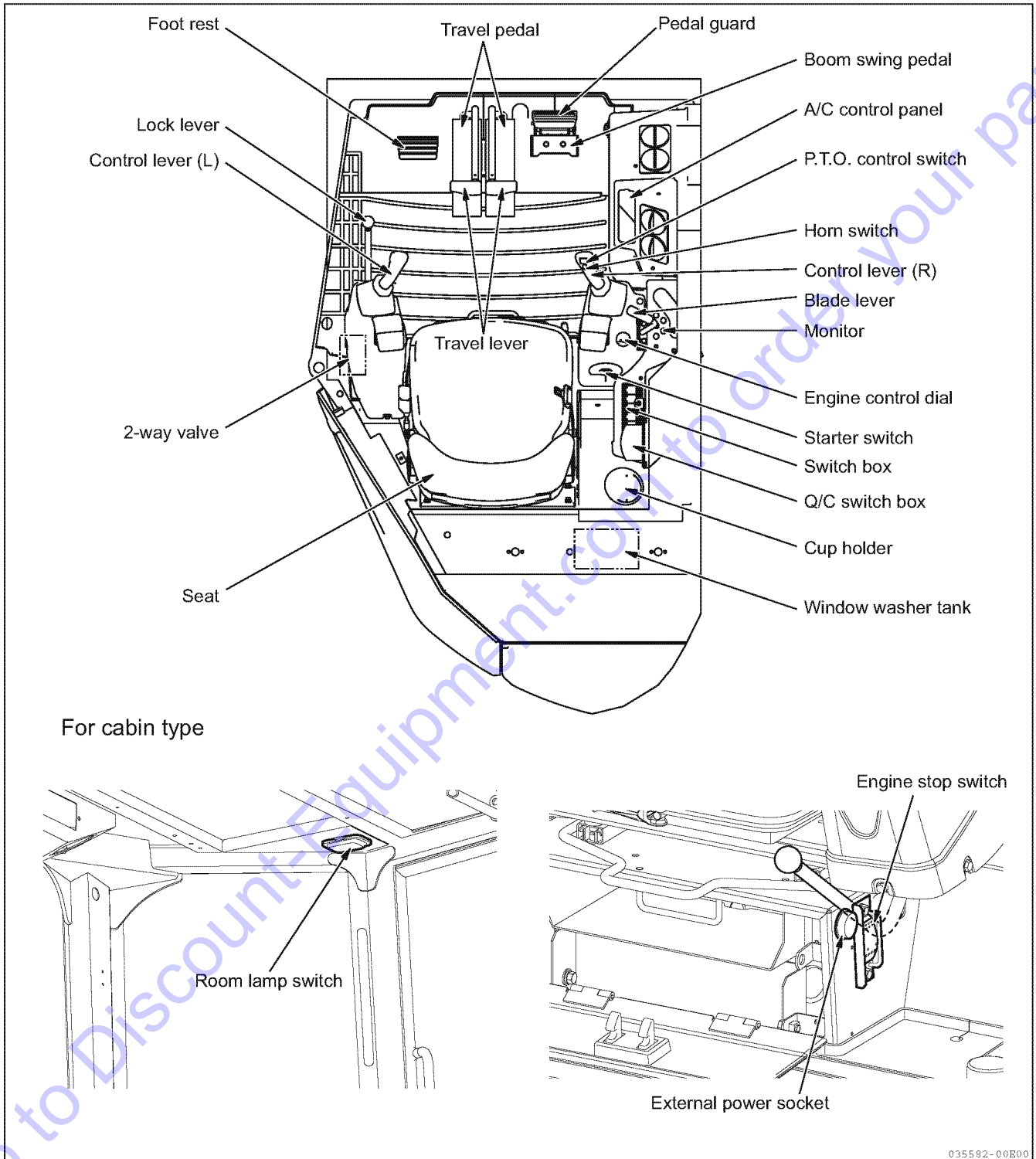

12. Description of Control Devices

This section describes several of the control devices necessary to operate the machine. In order to ensure safety and comfort in working with the machine, it is imperative for you to fully understand how to operate and interact with these devices.

12-1. Monitors

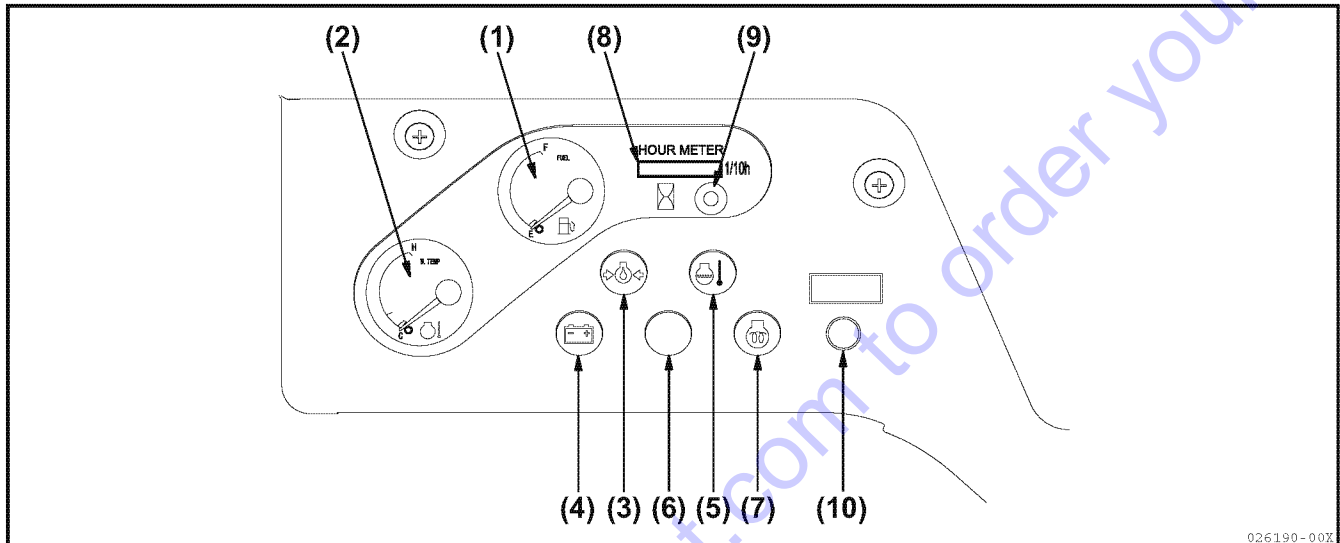

IMPORTANT

For start-up inspection, be sure to refer to **PART THREE: MAINTENANCE**, or Section "13. Operating Instructions" as well as the monitor messages as shown above.

! WARNING

When an indicator lamp lights and a buzzer sounds during operation, immediately stop operation and check and service the abnormality.

When the starter switch key is in the "ON" position, the monitor lamps (3), (4) and (5) light and a buzzer sounds. (Only the water temperature alarm lamp (1) and engine trouble monitor lamp (10) go off in a few seconds.)

Normally, all monitor lamps go off after the engine starts. When there is any failure during operation, a lamp lights and a buzzer sounds. (If the starter switch key is in the "ON" position and a monitor lamp does not light, its bulb must be burnt out.)

(1) Fuel gauge

The fuel gauge works when the starter switch key is in the "ON" position and indicates the fuel amount in the fuel tank. When the gauge pointer indicates close to E (empty), refill fuel tank soon.

- It is not abnormal that the fuel oil gauge may not indicate properly immediately after the starter switch key is turned to the "ON" position.
- The reading on the fuel meter scale is affected by how much the machine is slanted.

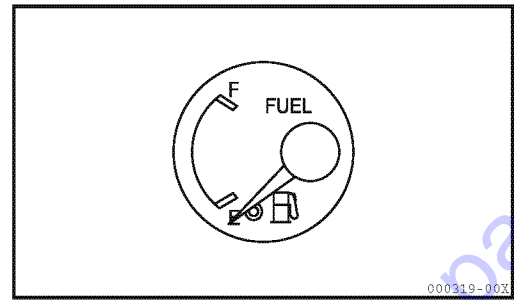

(2) Engine water temp. meter

It indicates the cooling water temperature for the engine. When the water temp. meter indicates "H" and buzzer sounds during operation, idle the engine at low speed until the water temperature cools down.

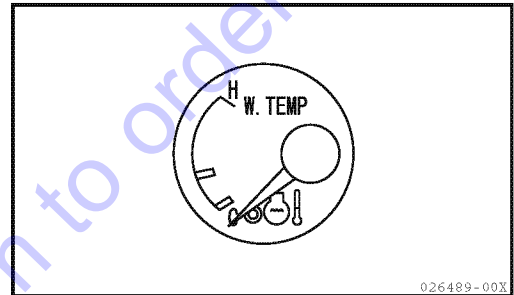

(3) Engine oil pressure alarm lamp

If engine oil pressure falls below the normal level, the alarm lamp will turn on and the buzzer will sound. In this event, stop the engine and inspect it according to Section "17-4. Troubleshooting".

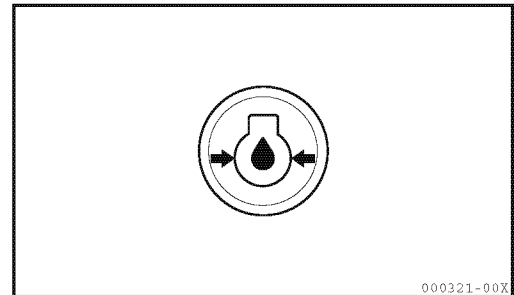

(4) Battery charge alarm lamp

If the battery is not charged properly, the alarm lamp will flash and the buzzer will sound. In this event, inspect the battery charging circuit. If you find something abnormal with it, take corrective action by referring to Section "17-4. Troubleshooting".

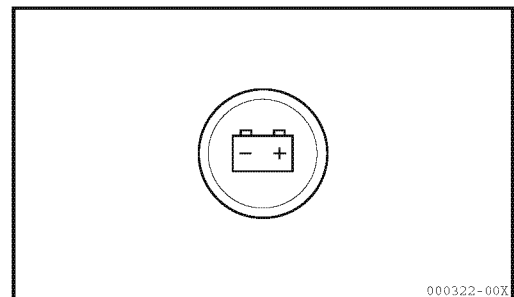

(5) Water temperature alarm lamp

When the starter switch key is turned to the "ON" position, the water temperature alarm lamp initially goes on and goes off in a few seconds. When the cooling water temperature rises abnormally during operation, the alarm lamp goes on and buzzer sounds, indicating engine overheating. Idle the engine for a while, and stop the engine.

After the engine has cooled, take corrective actions.

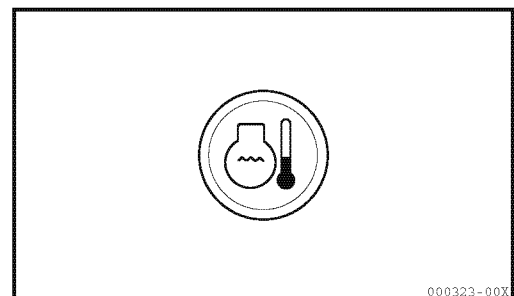

12. Description of Control Devices

(6) Auto-deceleration indicator lamp

It indicates the "ON/OFF" condition of the deceleration switch.

When the "ON" position of the deceleration switch is pressed, the lamp will go on.

When the "OFF" position is pressed, it will go off.

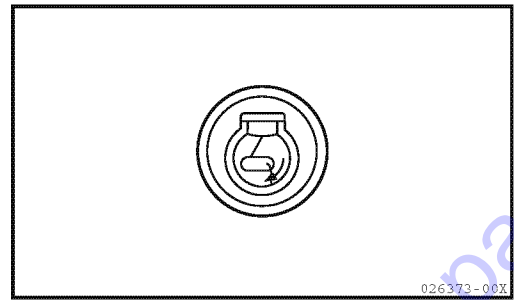

(7) Preheat pilot lamp

When the starter switch is turned to the "HEAT" position, the preheat pilot lamp goes on and then goes off in 15 seconds, which indicate it is okay to finish the preheat operation.

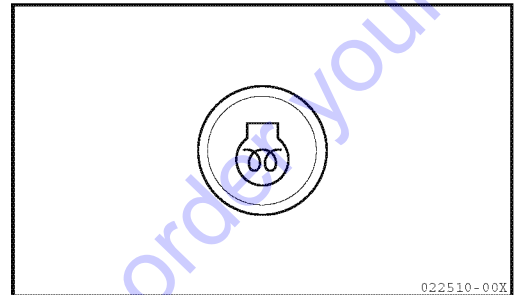

(8) Hour meter

The hour meter indicates the accumulated service hours for the machine.

The reading of the hour meter helps you set time intervals for periodic servicing of the machine. While the starter switch is turned to the "ON" position, the hour meter will continue registering even if the engine is not running.

- The hour meter reading increases by "1" per hour regardless of engine rotational speed.
- The tenths digit at the far right registers "1" per 0.1 hour (6 minutes).

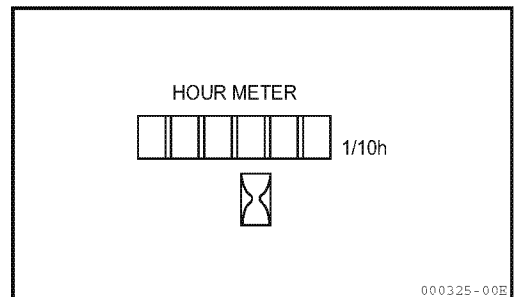
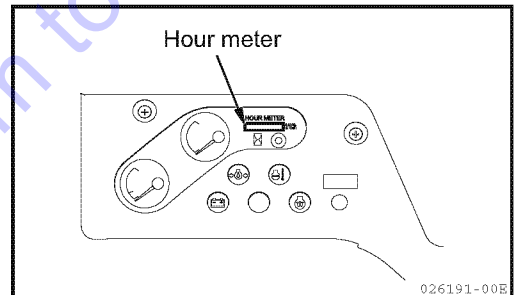

(9) Hour meter display button

- Even if the starter switch is in the "OFF" position, the operation time can be checked by pushing the hour meter display button.

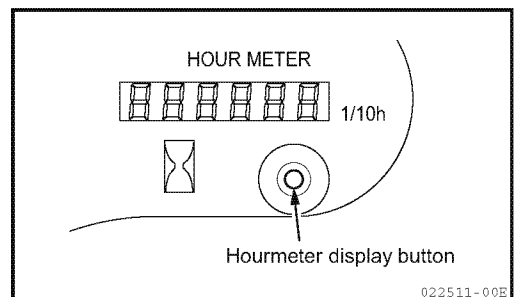

(10) Engine trouble monitor lamp

When the starter switch key is in the "ON" position, the engine trouble monitor lamp blinks and goes off in a few seconds.

If any abnormalities or troubles are encountered in the engine control system or governor system, the engine trouble monitor lamp blinks.

If it blinks during the operation, please consult your dealer.

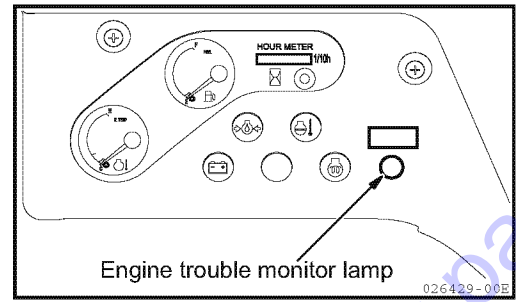

Go to Discount-Equipment.com to order your parts

12-2. Switches

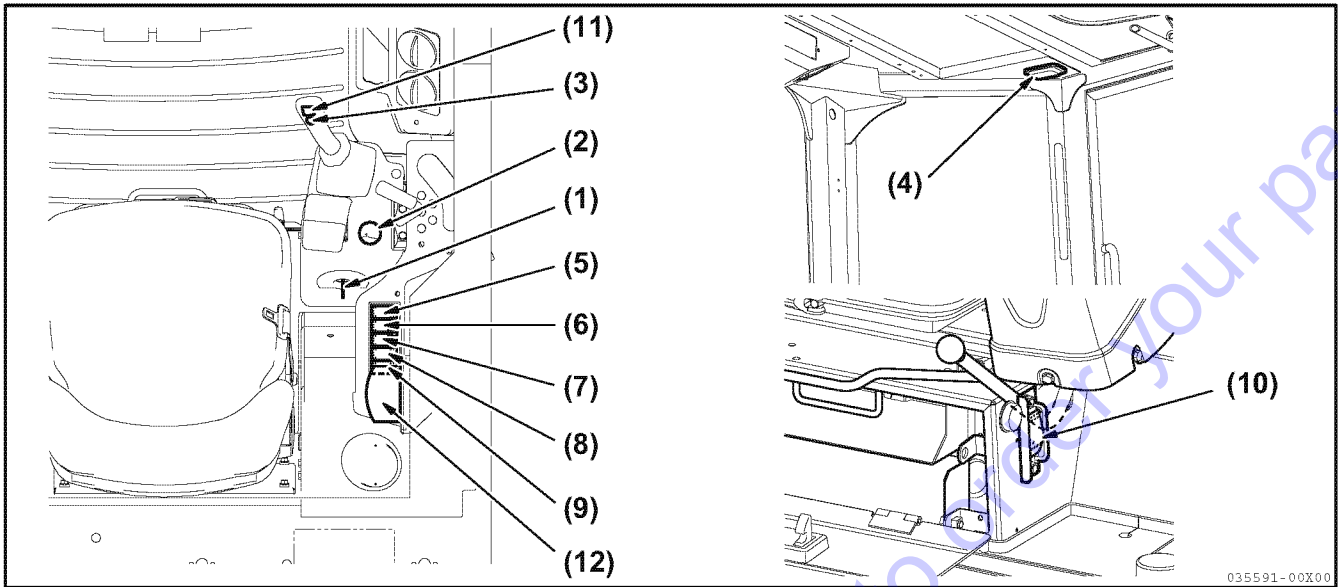

(1) Starter switch

Use this switch to start and stop the engine.

- OFF position

Turn the starter switch key to "OFF" to stop the engine and disconnect electrical circuit or remove the starter switch key.

- ON position

Turn the starter switch key to "ON" to connect the electrical fuel solenoid circuit and the electrical charging circuit. (Keep the starter switch key in this position while running the engine.)

When the engine is not running and the starter switch key is in the "ON" position, a buzzer will sound.

Turn the switch to the "OFF" position to stop the buzzer.

- START position

Turn the starter switch key to "START" to start the engine. Release the starter switch key after the engine is started and it will return to the "ON" position.

- HEAT position

Turn the starter switch key to activate the preheating circuit and warm up intake air to make engine starting easier in cold weather. (Set the starter switch key to this position when the outside temperature is low.)

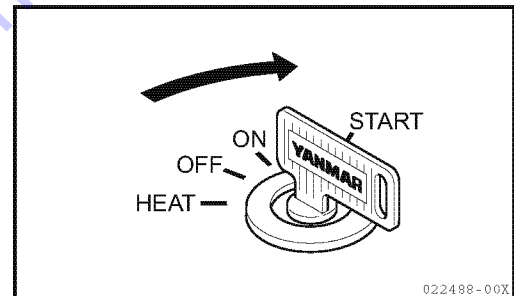

(2) Engine control dial

The dial controls the engine speed (output).

- 1) IDLING : Turn the dial to left (counterclockwise)
The fully turned position
- 2) RUN : Turn the dial to right (clockwise)
The fully turned position

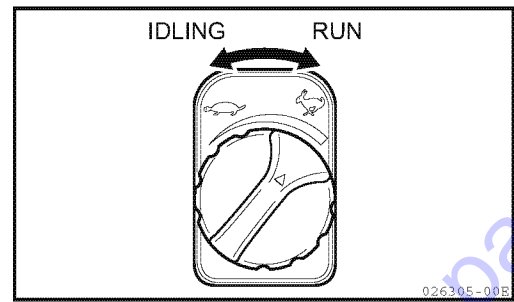

(3) Horn switch

Press the switch on the top of the right control lever to sound the horn.

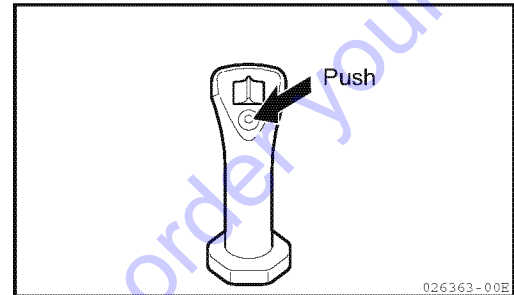

(4) Room lamp switch

The room lamp can be turned on when the starter switch key is in the "ON" position.

- ON : Turned on
- OFF : Turned off

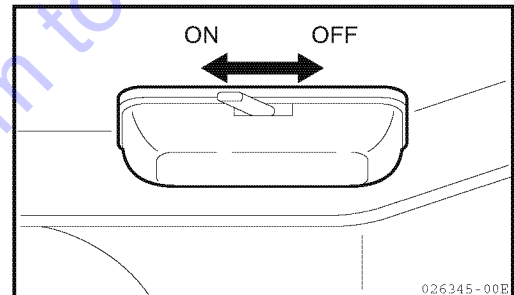

(5) Travel automatic dual speed switch

It is the switch for shifting the travel speed to "High Speed Travel".

When the travel force is required on soft ground and slopes even during the high speed travel, you do not need to shift the switch, as it will automatically shift to the low speed travel.

- ON : High speed travel (the lamp goes on)
- OFF : Low speed travel (the lamp goes off)

Note :

When traveling is shifted from "High Speed Travel" to "Low Speed Travel" due to the load during traveling, the travel speed will change without the engine speed being changed.

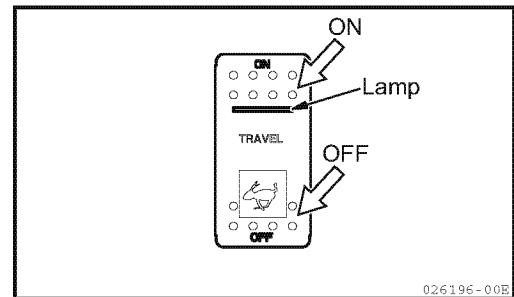

(6) Wiper switch

The wiper on the windshield is activated.

- Position (1) : The wiper is activated (the lamp goes on)
- Position (2) : Press the (1) further to spray the washer liquid.
- Position (OFF) : The wiper is off (the lamp goes off)

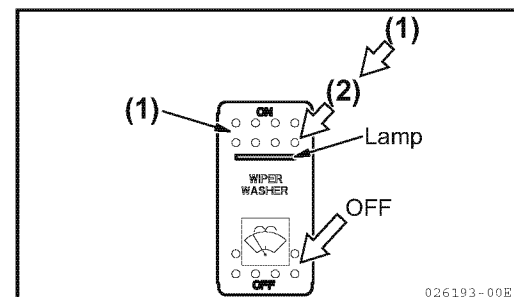

(7) Light switch

The working lamps and inner instrument lamps go on when the starter switch key is in the "ON" position.

- ON : The working lamps and inner instrument lamps are turned on (the lamps go on)
- OFF : Turned off (the lamps go off)

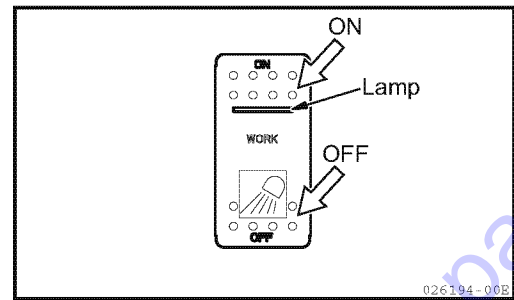

(8) Auto deceleration switch

It is the switch to activate the equipment that reduces the engine speed and fuel consumption when the engine power is not required such as when the travel lever and control lever are in neutral.

- ON : The auto deceleration is activated (the lamp goes on)
- OFF : The auto deceleration is released (the lamp goes off)

When the auto deceleration switch is switched to the "ON" position and all the control levers and pedals are placed in their neutral position, about 4 seconds later the engine speed is reduced to low idle. If any of the control levers or pedals is operated, the engine speed returns to the speed originally set by the engine control dial. While the auto deceleration switch is in the "ON" position, the auto deceleration indicator lamp in the indicator box remains lit.

When the auto deceleration switch is switched to the "OFF" position, whether or not the control levers or pedals are operated, the engine speed returns to the speed originally set by the engine control dial.

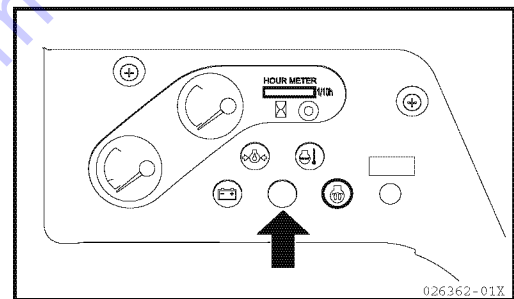
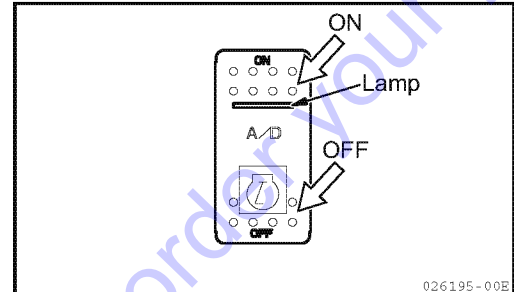

(9) Eco mode switch

It is the switch for drastically reducing the fuel consumption, as the engine speed is reduced to the dial "9" or equivalent even when the engine control dial is in the maximum "10".

- ON : The eco mode is activated (the lamp goes on)
- OFF : The eco mode is released (the lamp goes off)

Note :

The eco mode is not activated when the engine speed is below the dial "8" of the engine control dial and both the travel lever and control lever are in the neutral position.

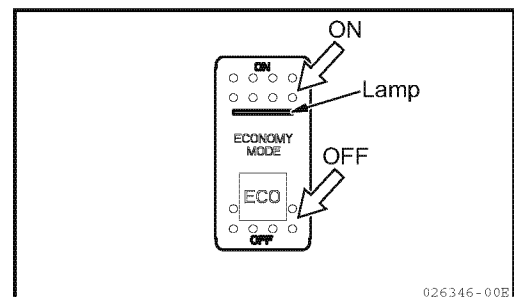

(10) Engine stop switch

If the engine is not stopped by turning the key switch to the "OFF" position, push the Engine stop switch to the "STOP" position.

The engine stop switch is in the storage compartment for operation & maintenance manual as indicated by the right figure.

After stopping the engine, always be sure to return:

- the engine stop switch to the "NORMAL" position, because when engine stop switch is in the "STOP" position, engine cannot be started.
- the key switch to the "OFF" position to avoid running down of battery.

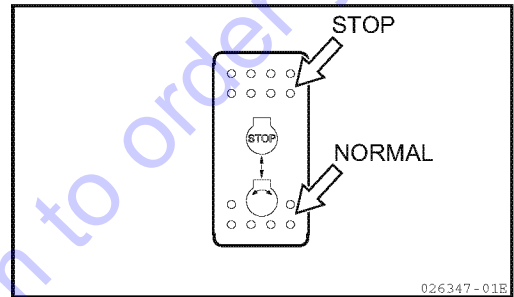
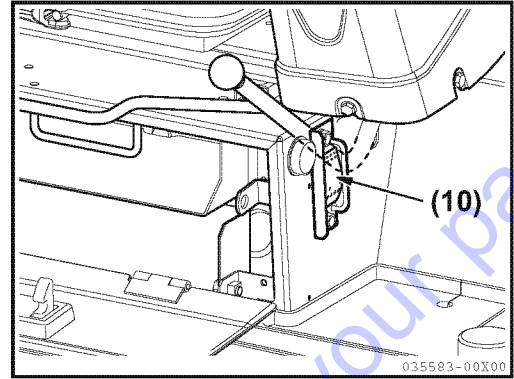

(11) P.T.O. switch

Move the switch on the top of the right control lever to right and left to control the P.T.O.

For handling P.T.O., refer to Section "13-21. Handling hydraulic P.T.O.".

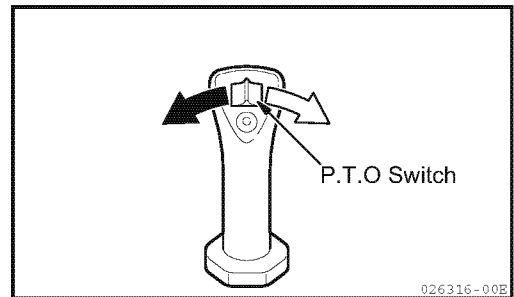

(12) Quick hitch box

Refer to Section "13-14. Handling quick coupler".

12-3. Control levers and pedals

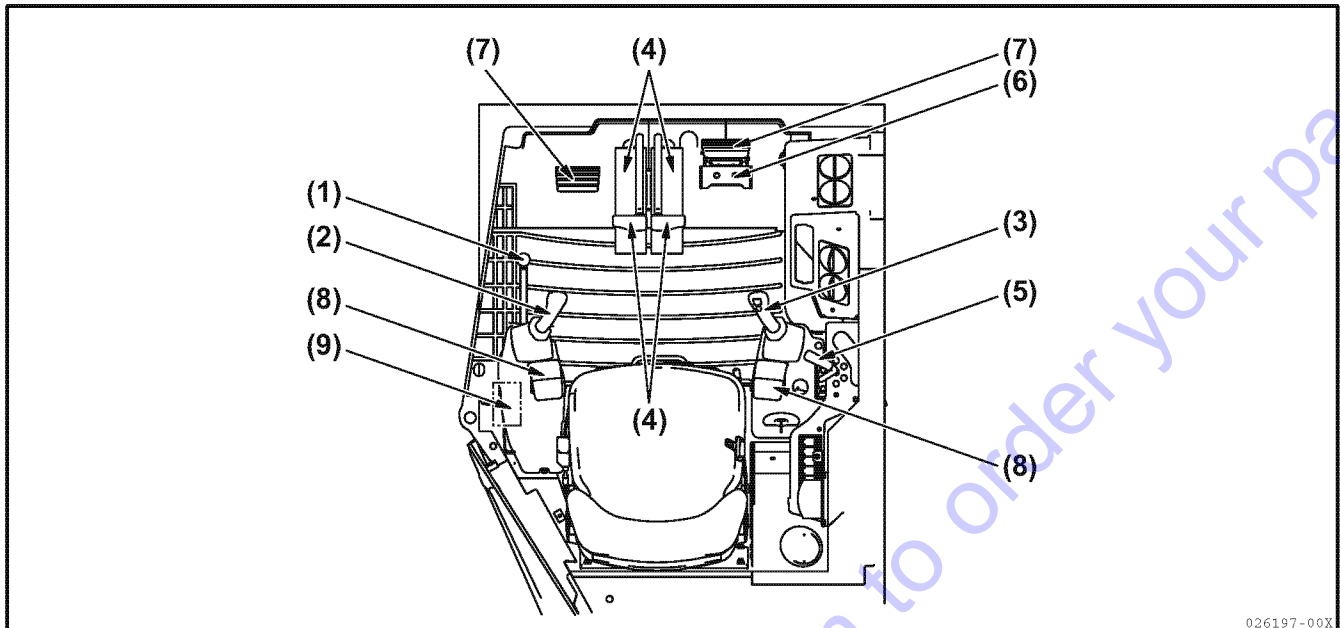

(1) Lock lever (for the implement control levers on both sides and the travel levers)

The lock lever locks the implement control levers and the travel levers.

! WARNING

- When leaving the operator's seat, be sure to place the bucket on the ground and move lock lever to the lock position. Keep in mind that if you should touch an unlocked lever inadvertently, a serious accident could occur.
- Be sure to place the lock lever securely in the lock position. If not, they could slip out of the lock position. Thus always make sure that the lock lever is in the lock position as illustrated in the figure at the right.
- Note that even if the lock lever is in the lock position, the blade is not locked and is free to operate.
- When pulling the lock lever back, be careful not to touch the control lever.
- Remember that if the lock lever is not pulled back fully, the implement will not be locked.

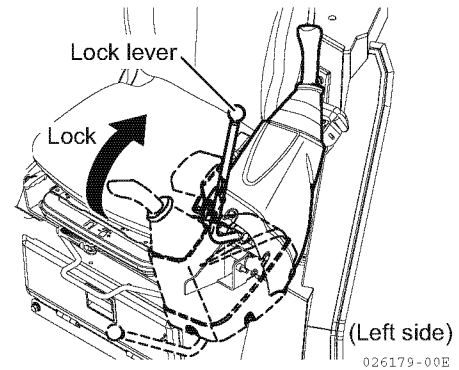

IMPORTANT

The machine uses the hydraulic lock system. If the lock lever is in the lock position, all the hydraulic cylinders for the boom, the arm, and the bucket as well as the swing motor and travel will not operate although the right and left implement control levers are free to move.

⚠ WARNING

When pushing the lock lever forward, be careful not to accidentally touch the implement control levers.

⚠ WARNING

The relationship between the control lever shift configuration and the implement movement is detailed in this manual. To prevent an accident due to operational error, therefore, the hydraulic system must never be modified by reconnecting the hydraulic hoses and valves.

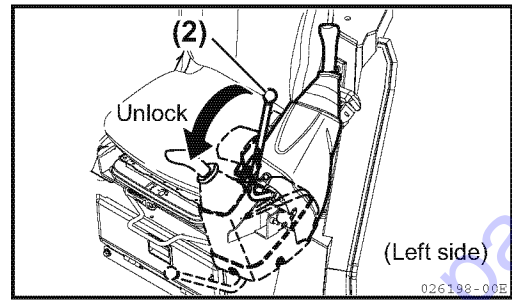

(2) Control lever (L)

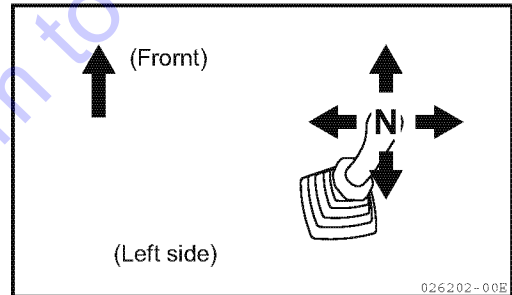

(3) Control lever (R)

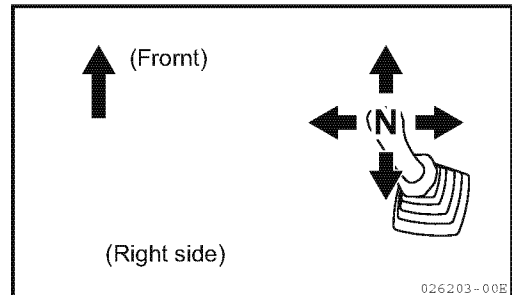

Use these levers to control the implements and swinging of upperstructure.

Refer to Section "13-8. Operating the implement".

(4) Travel levers and pedals

The travel levers and pedals control the traveling of the machine.

⚠ WARNING

- If the blade is in the reverse direction, the travel levers and pedals should also be operated in reverse for forward and backward travel.
- When operating the travel levers and pedals, you must check to see if the blade is in the normal position or in the reverse position. Note that the blade is in the normal position when the sprocket is in the rear. Refer to Section "11-1. Overview of the machine".

When the blade is in the normal position:

The pedal operation is in the parenthesis.

(A) Forward : Push the travel levers forward.

(Step on the front position of the pedals)

(B) Reverse : Pull the travel levers backward.

(Step on the rear position of the pedals)

N (Neutral) : The machine stops.

Note :

When the travel lever is shifted to the forward or reverse position from neutral, an alarm sounds to inform the surrounding area that the machine is about to start moving.

(5) Blade lever

Use this lever to control the blade.

IMPORTANT

The blade lever is not locked by setting the lock lever to the lock position. Never touch the blade lever when not operating the blade.

(A) : Down : Push the lever forward.

(B) : Up : Pull the lever backward.

N (Neutral) : When released, the lever will return to the neutral position and the blade is held as it is.

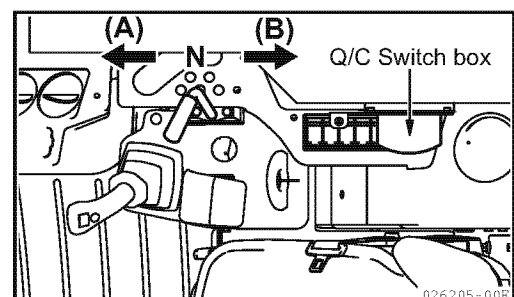
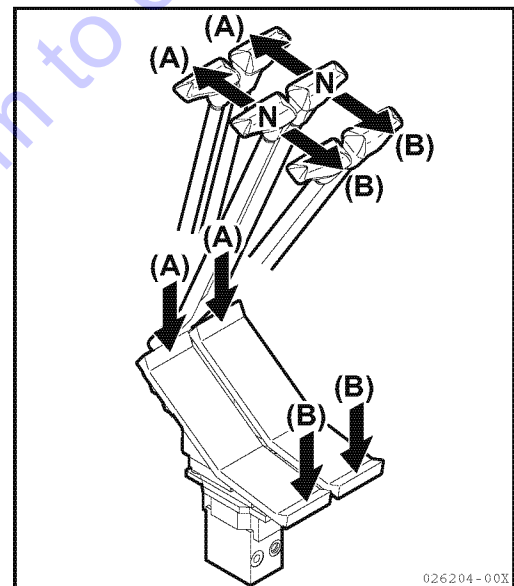
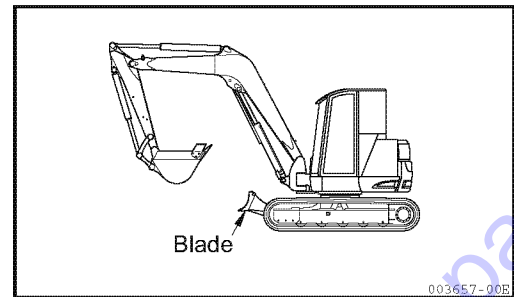

(6) Boom swing pedal

Use this pedal to swing the boom to right and left.

(A) : Swing right : move to the right.

(B) : Swing left : move to the left.

N (Neutral) : When released, the pedal will return to the neutral position and the boom is held as it is.

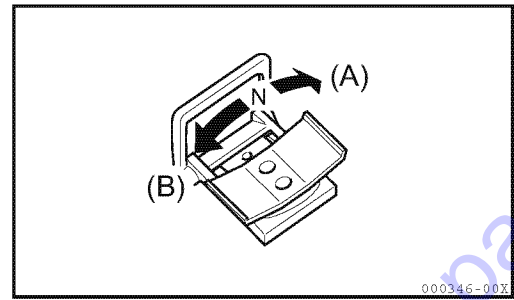

(7) Pedal guard (foot rest)

The boom swing pedal has a pedal guard.

! WARNING

To avoid bodily injury, securely place the pedal guard in the lock position whenever the boom swing pedal is not being operated.

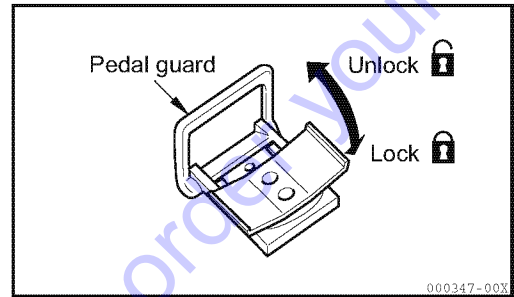

Placing the pedal guard in the lock position completely covers the boom swing pedal.

To prevent misuse, always set the pedal guard in the lock position whenever the boom swing pedal is not being operated. The pedal guard can be used as a foot rest.

Go to Discount-Equipment.com to order your parts

(8) Armrest

Rest the elbow in the armrest and operate the implement control lever.

Armrest adjustment:

The armrest can be fixed in the 3 positions by inserting the armrest pin in the hole in the stay.

Lift the armrest up and slide it to make adjustment.

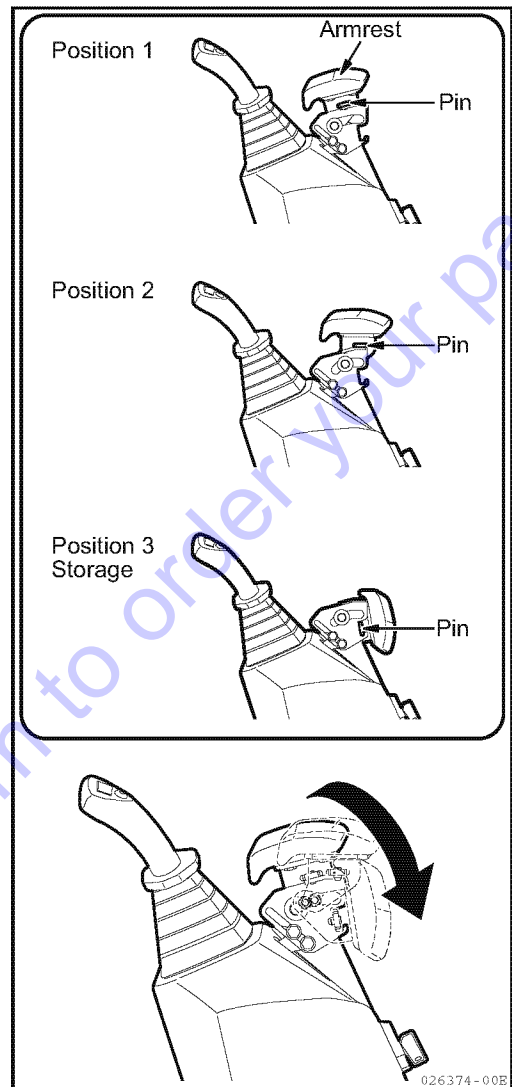

(9) 2 way valve

STD : ISO pattern

OPT : OPT pattern

Refer to Section "13-8. Operating the implement".

- 1) Unlock the lock plate.
- 2) Turn the pattern change lever to "STD" or "OPT" position.
- 3) Lock the lock plate.

IMPORTANT

Be sure to place the lock plate in the lock position.

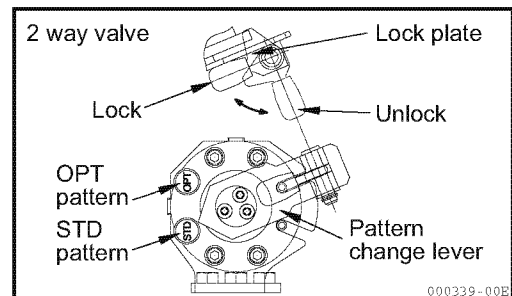

12-4. Engine hood

⚠ WARNING

Do not open the engine hood while the engine is running. Check and service the engine after it has been stopped and temperatures have cooled.

(1) Opening the engine hood

- 1) Insert the starter switch key and turn it counterclockwise to unlock the engine hood.
- 2) Pull the engine hood lever to release the engine hood, and it will open.
- 3) When the engine hood is fully open, lock it in that position with the stopper rod.

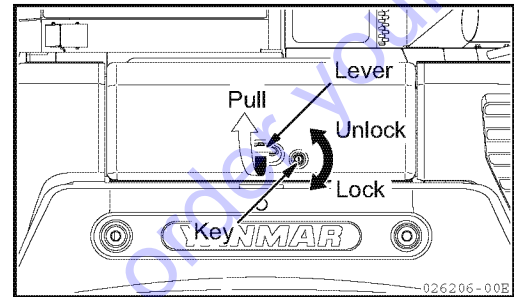

(2) Closing the engine hood

- 1) Lift the engine hood slightly and pull the stopper rod to disengage it.
- 2) Close the engine hood and press it until it clicks shut.
- 3) Turn the starter switch key clockwise to lock the engine hood.

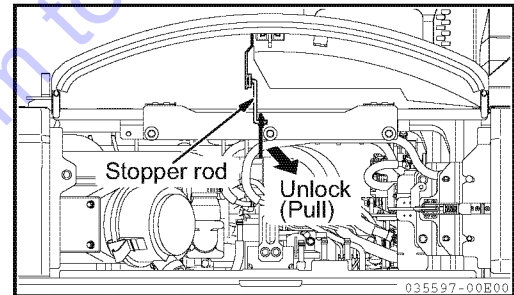

12-5. Storage compartment for the operation & maintenance manual

Storage compartment for the operation & maintenance manual has been provided under the operator's seat.

Pull the lever to open the cover.

Store the operation & maintenance manual in the box (A).

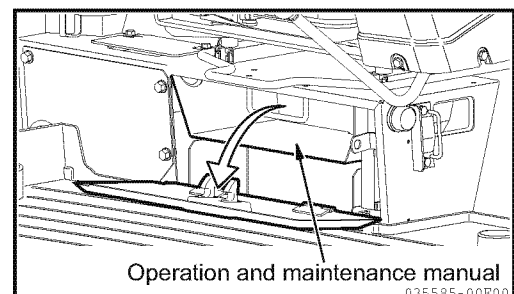
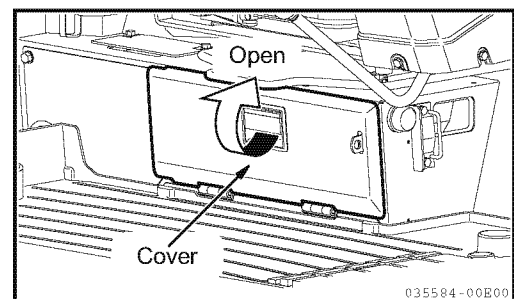

12-6. Tool storage space

Loosen the wing bolt and open the cover to find the tool storage space.

Note :

The tools are optional.

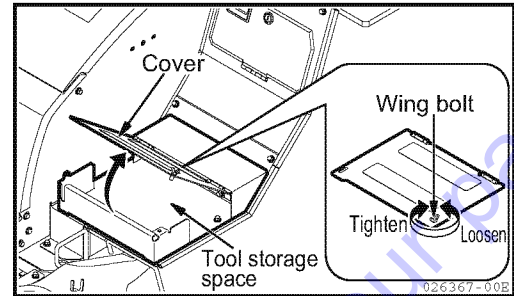

12-7. Bonnet B

(1) Opening the bonnet B

- 1) Insert the starter switch key into the key hole in the bonnet B and turn it counterclockwise to unlock the bonnet B.
- 2) Pull the lever up to unlock it, and open the bonnet B.

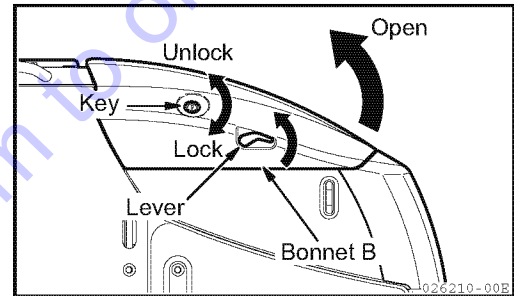

(2) Closing the bonnet B

- 1) Close the bonnet B and press it down with your hands.
- 2) Turn the starter switch key clockwise to lock the bonnet B.

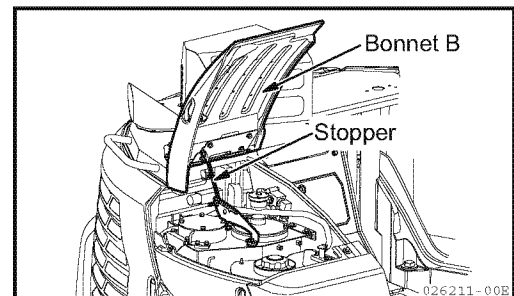

12-8. Bonnet R

(1) Opening the bonnet R

- 1) Open the engine hood.
- 2) Pull the lock lever to this side and open the bonnet R.
- 3) Fix the bonnet R with the stopper.

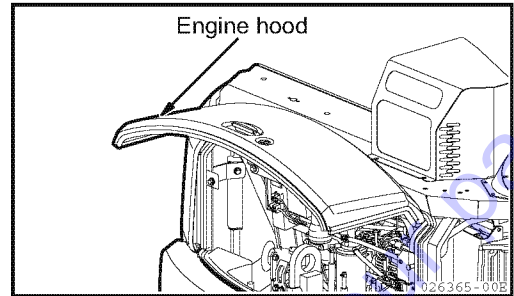

(2) Closing the bonnet R

- 1) Remove the stopper from the bonnet R to reinstall it in its original position.
- 2) Close the bonnet R and fix it with the lock lever.
- 3) Close the engine hood.

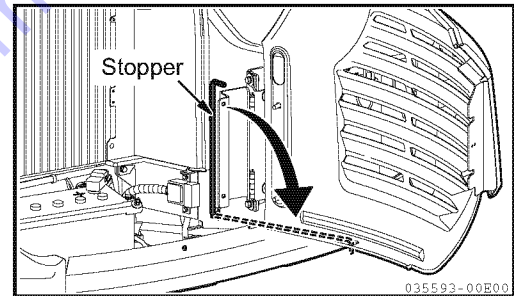
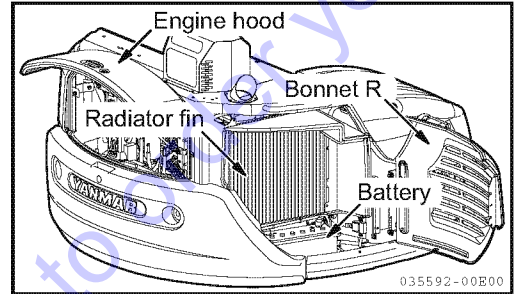

Go to Discount-Equipment.com to buy parts

12-9. Windshield

⚠ WARNING

- To avoid bodily injury while operating the machine, make sure the side door and upper windshield are securely locked in either the open or shut position.

If they are not securely locked, they may open or close unexpectedly.

Never stick your hands or your head out of an open side door or windshield.

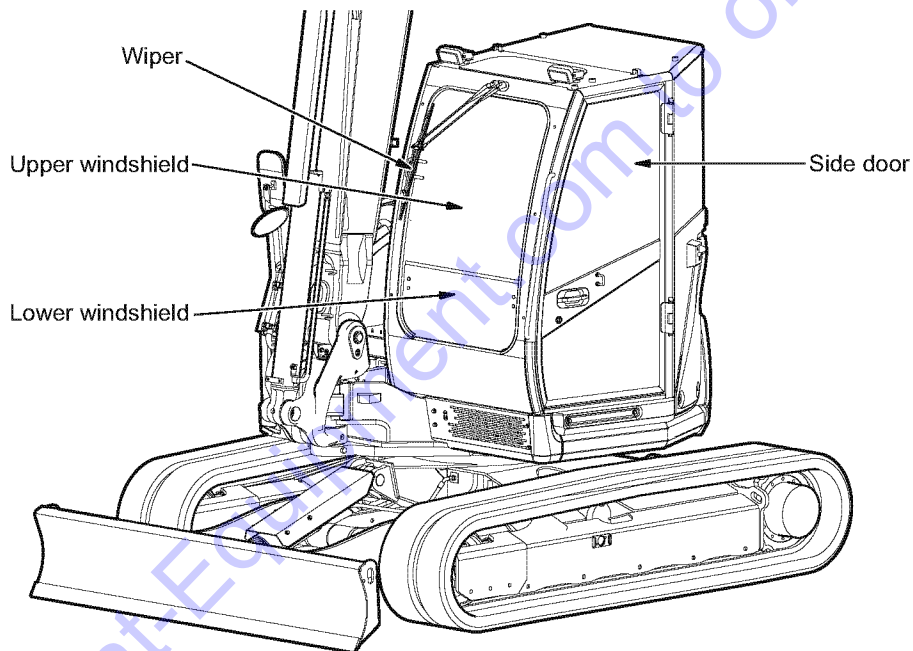

035698-00E00

⚠ WARNING

Both the upper and lower windshields can be opened and closed.

Securely lock the upper and lower windshield with the locks when storing or closing them.

⚠ WARNING

- To avoid bodily injury, securely grasp the knobs with both hands when opening and closing the windshield.

(1) Opening the upper windshield

- 1) Grasp the knobs with your hands and turn the right and left window lock levers (A) to the forward direction to release the lock.
- 2) Holding the knobs slide the windshield to the upper rear side while pulling it to this side, and engage and fix the auto lock (B) on both sides of the upper windshield with the lock section (C) in the ceiling.

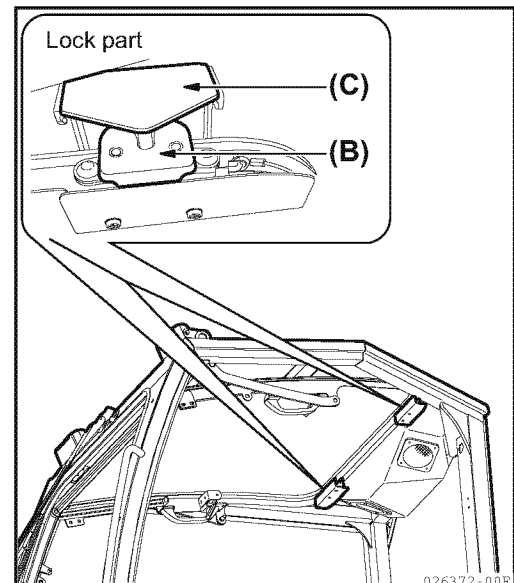
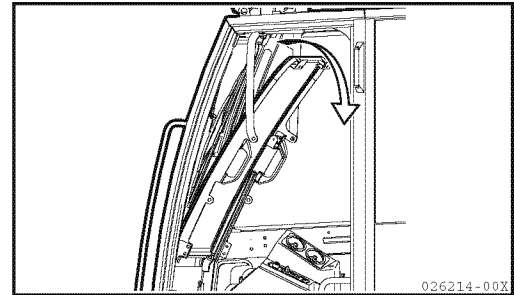
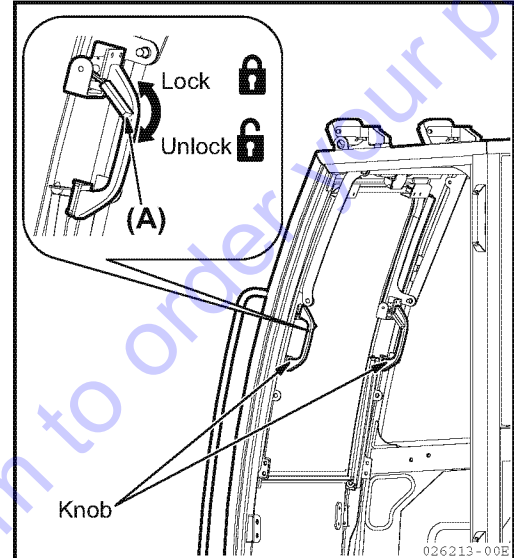

(2) Closing the upper windshield

- 1) Grasp the knobs with your hands and release the right and left window lock levers (A).
- 2) Grasp the knobs with your hands and lower the upper windshield slowly.
- 3) Keep grasping the knobs with your hands and fix the upper windshield by pushing it forward.

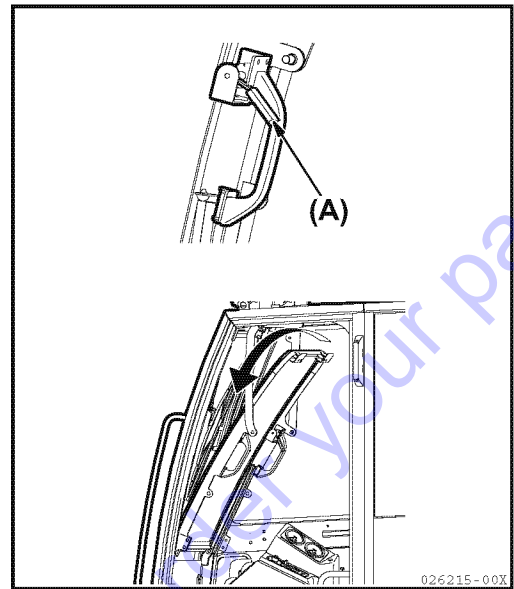

(3) Opening and closing the lower windshield

⚠ CAUTION

Open and close the lower windshield with the upper windshield closed.

- 1) To open the lower windshield, pull the right and left window lock levers (A) inward and unlock.
- 2) Keep grasping the window lock levers (A) and pull the lower windshield slightly inward to lift it up.
- 3) Store the window lock levers (A) in the lock section (D) of the upper windshield.
- 4) Close the lower windshield according to the reverse order of 1) - 3).

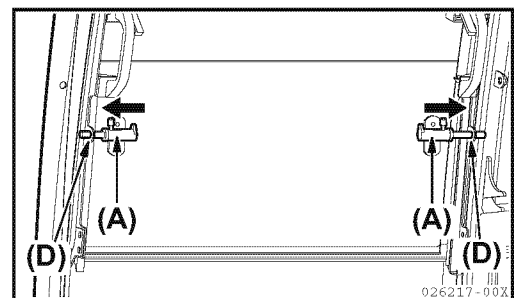
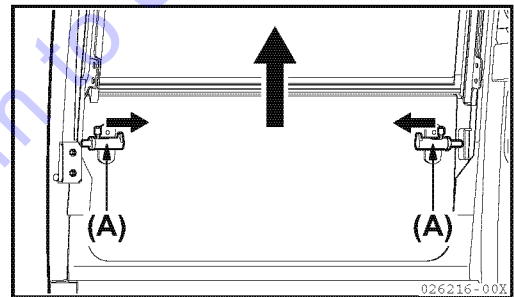

12-10. Hammer for emergency escape from operator's cab

If the door of the cabin should not open, hammer (1) is provided inside the cabin to escape from the operator's cab in an emergency.

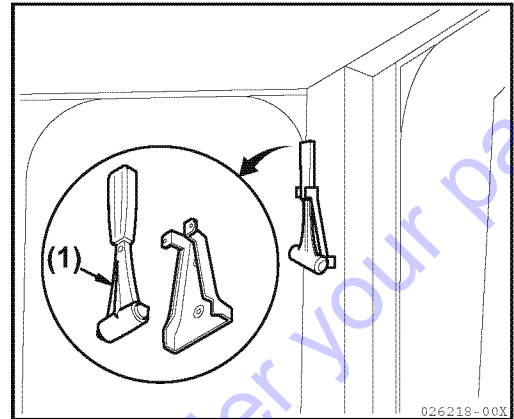

Break the window glass with the hammer (1) to escape from the operator's cab.

IMPORTANT

- Remove the broken pieces of the window glass from the window frame to prevent any injury by those broken pieces.
- Watch your step not to slip on the broken pieces of the window glass which dropped around your feet.

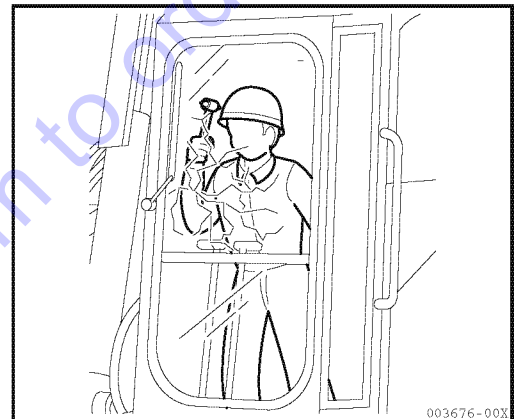

12-11. Operator's seat

⚠ WARNING

- Be sure to adjust the seat slide to obtain the best operating position whenever you (or a new operator) starts operation.
- Do not place any foreign objects within the moving area of the operator's seat.
- Do not adjust the operator's seat while operating the machine.

Adjust the seat so that the operator can easily operate the control levers in good posture.

■ **Seat position control adjustment**

(1) Seat position control adjustment (forward and backward)
Pull the slide lever (A) upward, to move the seat forward or backward. Adjust the seat to the best position for operating the control levers.

The adjustable amount of seat movement is 2.95 in. (75 mm) maximum, in five separate positions.

(2) Seat backrest control adjustment
Pull the lever (B) upward to adjust the backrest to the desired position.
Adjust the backrest, keeping your back in contact with the backrest or pushing the backrest with your hand, to prevent the backrest from returning suddenly.

(3) Entire seat back position control adjustment (forward and backward)
Pull the slide lever (C) upward, to move the seat forward or backward. In this case, the control levers and safety lock levers move together with the seat, so adjust to the best position for operating the travel levers and pedals. The adjustable amount of seat movement is 2.76 in. (70 mm) maximum, in seven separate positions.

(4) Weight adjustment

- The seat can be adjusted for the operator's weight by turning the weight adjuster lever (D) with the seat empty. The setting weight can be read at the indicator (E).
- Turn the weight adjuster lever (D) clockwise the setting weight is increased.
- Turn the weight adjuster lever (D) counterclockwise, the setting weight is decreased.

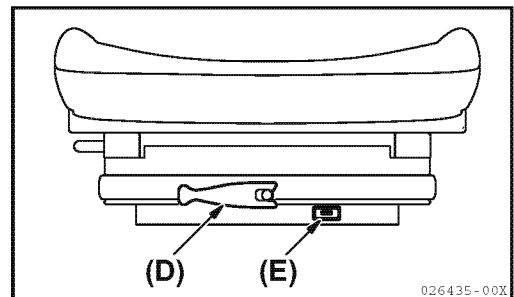
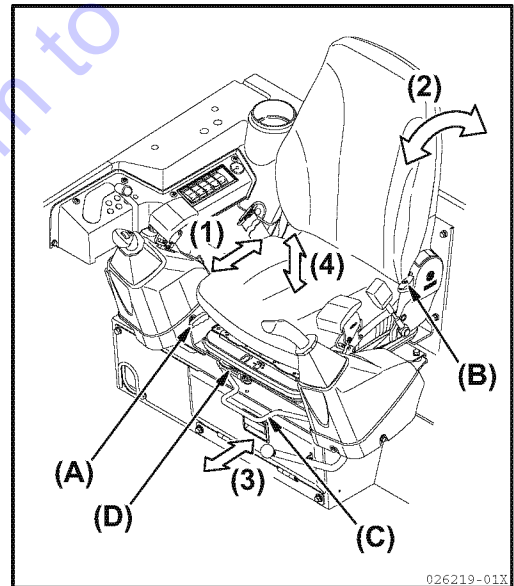

12-12. Headlight

⚠ WARNING

The headlight gets hot when it is turned on. Do not touch it with your bare hand before it cools, to prevent burns.

The irradiation (direction) of the headlight can be adjusted. Move the light up and down to adjust the irradiation in the direction where the lighting is needed for the nighttime work.

IMPORTANT

Do not turn the cabin light excessively to prevent damage to the harness.

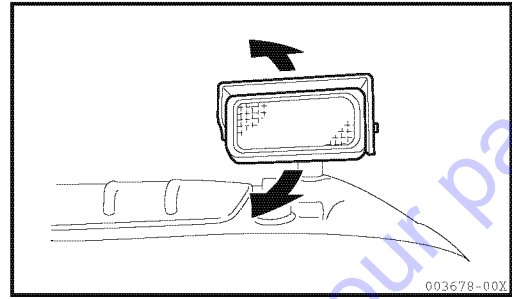

12-13. Ash tray

⚠ WARNING

Do not place any combustible matter in the ash tray.

Open the ash tray by pulling it toward you, and close the ash tray when it is not in use.

To empty and clean the ash tray, lift it up by holding both ends.

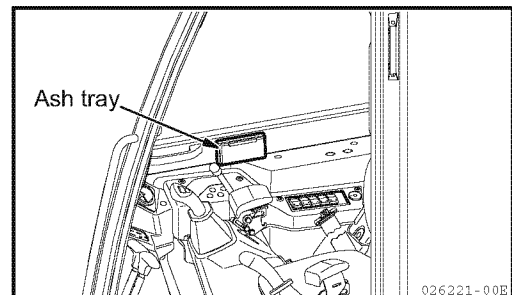

12-14. Right window glass

Open the window on the right by sliding the glass in direction indicated.

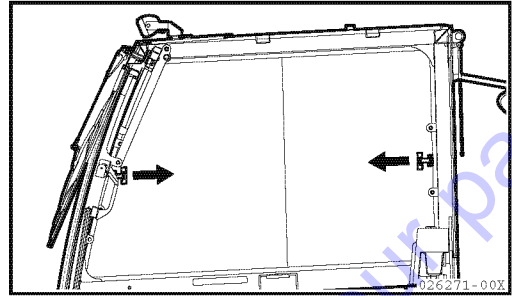

12-15. Cabin side door

12-15-1. Opening and closing the cabin side door

■ From outside

- 1) Turn the starter switch key counterclockwise to unlock the side door.
- 2) Pull the outer handle to the side to open the side door.
- 3) Close the side door and turn the starter switch key clockwise to lock the side door.

■ From inside

- 1) Push the inner handle down to open the side door.

12-15-2. Door lock

The door lock is used to hold the side door open.

- 1) Press the side door into the lock section to latch it open.
- 2) Pull the lever (1) downward to unlatch the side door.

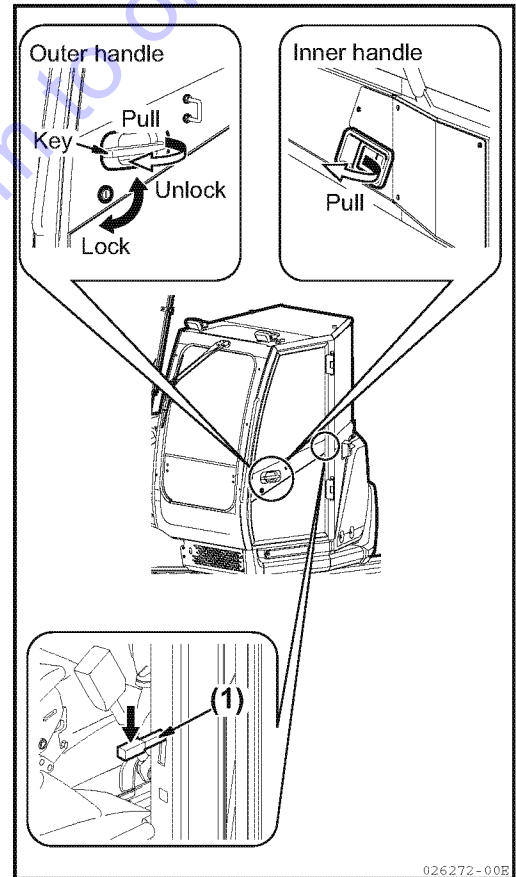

12-16. Air Conditioner

12-16-1. Description of lever and switches for air conditioner

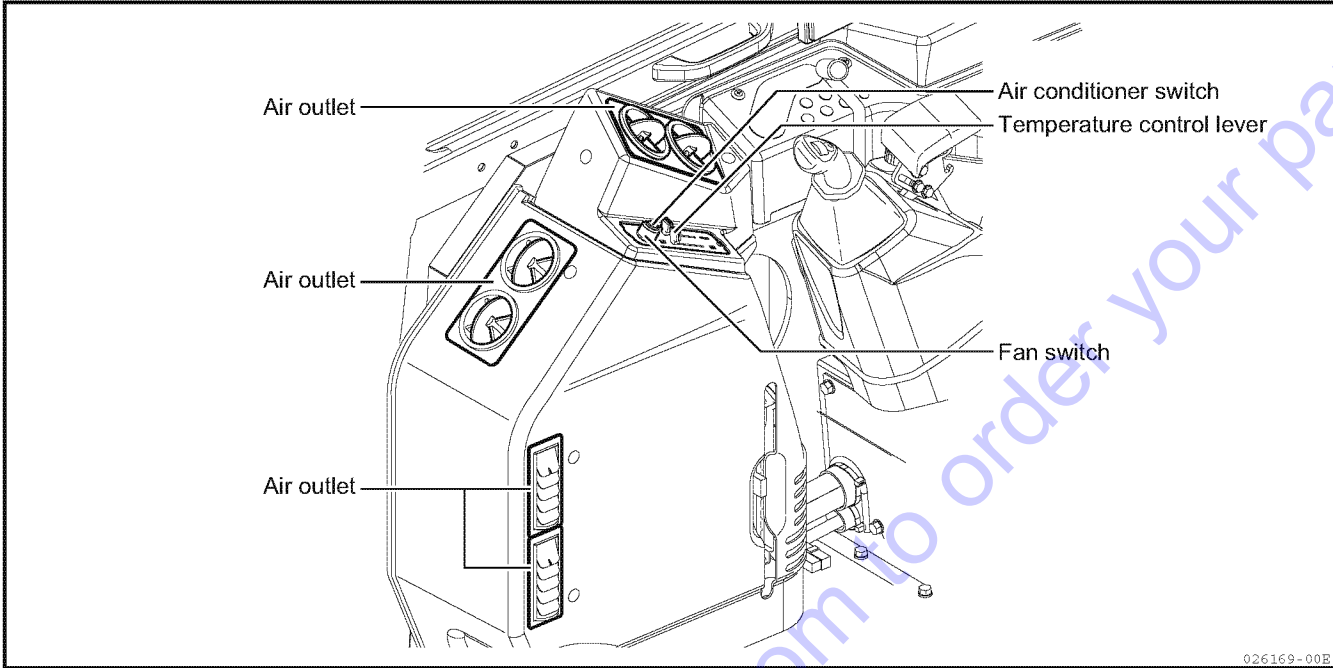

026169-00B

Temperature control lever:

It is used to control the temperature of the air blown by the air conditioner.

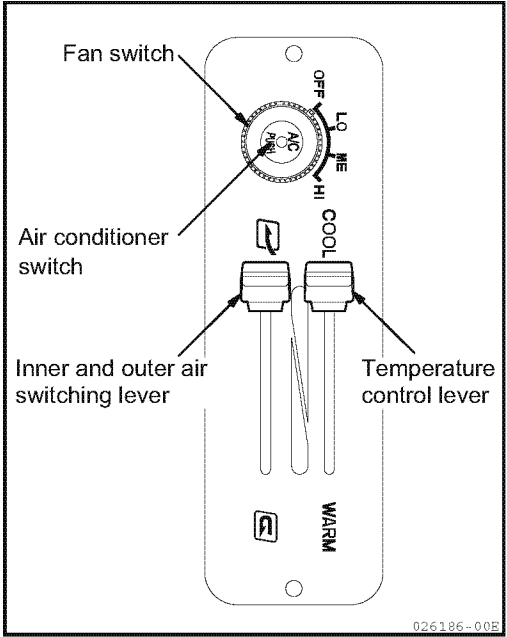

026186-00B

Inner and outer air switching lever :

- Outer air induction

Move the lever to the outer air induction mark position to induce the outer air to the cab for cooling and heating. It is used when inducing the clean air from outside the cab or defogging the cab window.

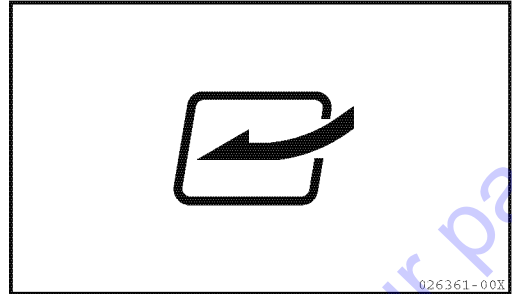

- Inner air circulation

Move the lever to the inner air circulation mark position to circulate the air only in the cab. It is used when rapidly cooling or heating the cab or the outer air is polluted.

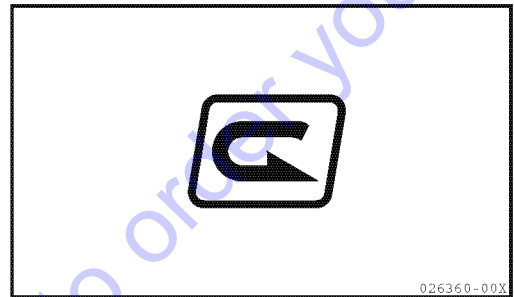

Fan switch :

It is used to set the air volume at one of the three levels.

LO : Low

ME : Medium

HI : High

OFF : Stop

Air conditioner switch :

It is used to turn the compressor ON or OFF.

 The compressor is turned OFF. (The lamp goes off.)

 The compressor is turned ON. (The lamp goes on.)

Press the switch in the OFF state to turn the compressor ON, and press it again to turn the compressor OFF. When the fan switch is in the OFF position, the lamp does not go on and the compressor does not work even if the air conditioner switch is turned ON.

12-16-2. How to use air conditioner

⚠ CAUTION

- The eyes might get sore from smoking when the air conditioner is being used in the cabin. Ventilate the cabin by opening the window slightly when smoking.
- Some mist might blow off with cooled air when the air conditioner is being used in the cabin. This occurs because the water particles in the wet air are frozen and blown out. It is not abnormal.
- When using the air conditioner after parking the machine in the hot weather, ventilate the cabin by opening the door and windows to let the hot air inside go out of the cabin so that the air-conditioning can work efficiently.
- Take care not to cool the inside of the cabin too long because it is not good for the operator's health. Control the air temperature properly.
- If the air conditioner blows no air, the air volume is too low or the cabin is not air conditioned well when the air conditioner is turned on, ask your dealer to check the air conditioner. If you keep using the air conditioner in such an abnormal state, it will cause damage to the fan motor or the compressor.
- Even in the seasons when the air conditioner is not used, operate the air conditioner for a few minutes once or twice every two or three weeks. That prevents the rotating parts such as the compressor from running out of oil, which prevents malfunction of the parts in turn.

■ Air conditioning

- 1) Set the fan switch at any of the three levels (Low, Medium or High).
- 2) Set the temperature control lever to the COOL position (the top position).
- 3) Turn the air conditioner switch ON. (The lamp goes on.)
- 4) Control the temperature inside the cabin properly with the temperature control lever and the fan switch after the inside of the cabin has been cooled off.

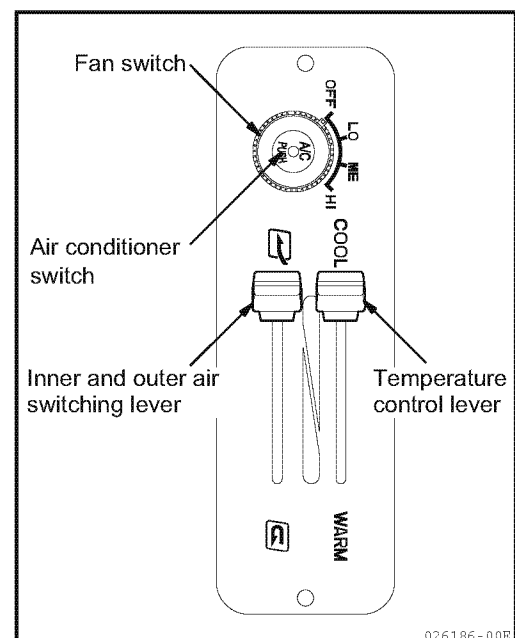

026106-00E

12. Description of Control Devices

5) Adjust the air direction with the air outlet grille.

- Set the fan switch for ventilation to apply preload to the inside of the cabin when the air conditioner is not used, so that no dust can come into the cabin easily during operation.

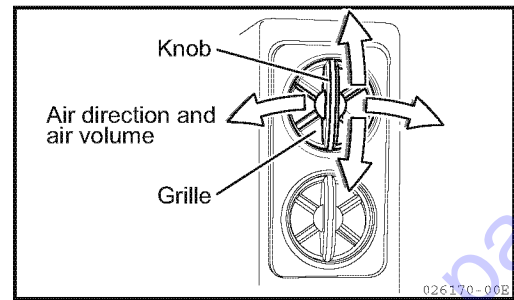

IMPORTANT

Be sure to turn on the air conditioner after starting the engine to prevent excessive force to the compressor etc.

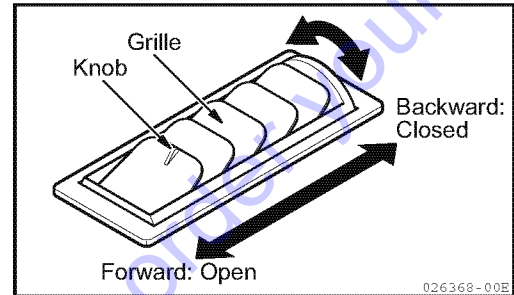

■ Heating

- 1) Set the fan switch at any of the three levels (Low, Medium or High).
- 2) Set the temperature control lever to the WARM position (the bottom position).
- 3) Turn the air conditioner switch OFF. (The lamp goes off.)

■ Heating for dehumidification

(In the case that the window glass tends to get fogged in rainy weather in spring or autumn.)

With the heating turned on, turn the air conditioner switch ON. (The lamp goes on.)

- If the temperature inside the cabin is low, dehumidification might not work because the compressor does not operate even if the air conditioner switch is turned ON.

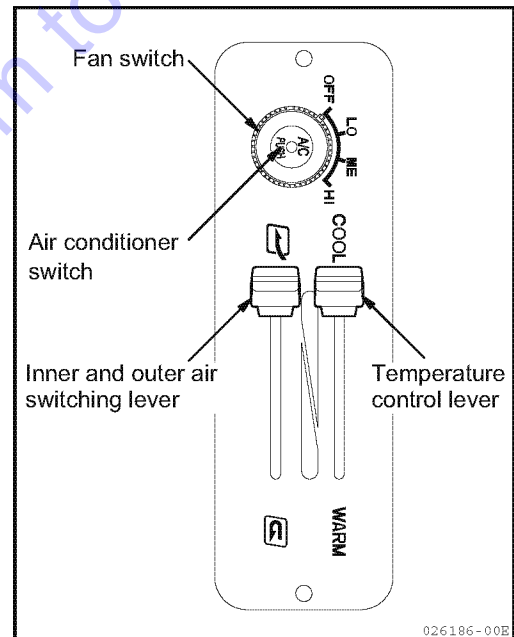

■ Stop

- 1) Turn the air conditioner switch OFF. (The lamp goes off.)
- 2) Turn the fan switch OFF.

- The air conditioner also stops only by turning the fan switch OFF.

12-17. Replenishment of windshield washer fluid

- 1) Replenish windshield washer fluid, whenever necessary, to the reservoir.

⚠ CAUTION

- When you fill the reservoir with windshield washer fluid, take care not to allow foreign matter to enter the reservoir.
- Determine the ratio of windshield washer fluid to water on the basis of the lowest past air temperature.

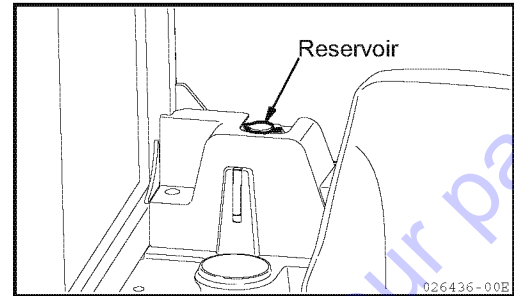
**12-18. Fuse****⚠ CAUTION**

- When replacing a fuse, be sure to turn off the power by turning the starter switch key to the OFF position.
- Using the wrong fuse or shorting out a fuse holder could damage the gauges, the electrical equipment and the wiring due to overheating.
- If a new fuse blows out immediately after replacement, there may be a problem with the electrical system. Ask your dealer for assistance.

■ The following two types of fuses are used in the electrical wiring circuit :

Blade fuse

- Protect the electrical equipment from overcurrent which exceeds the allowable limit of the electrical equipment.
- Protect the wiring from overcurrent which exceeds the allowable limit of the wiring due to a problem with the electrical equipment.

Slow-blow fuse

- Protect the electrical equipment and the wiring from a burnout caused by overcurrent which flows in the circuit for large-capacity current when a problem occurs (such as short-circuit due to breaking of wire).

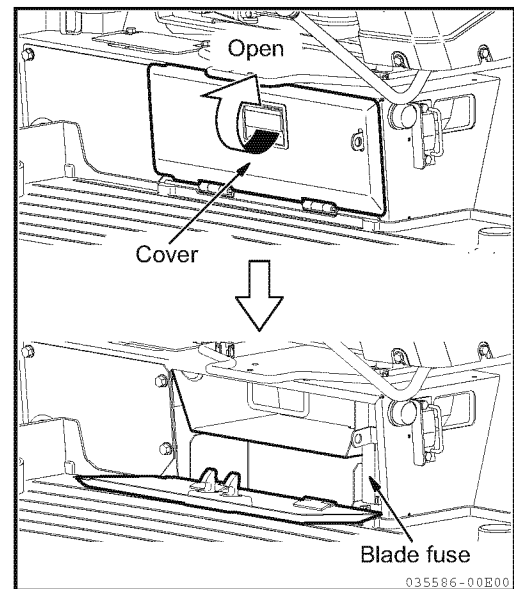

■ Position of the fuse

Blade fuse

- It is installed on the front right of the seat mount.

Slow-blow fuses

- It is installed on the right of battery inside the bonnet R.

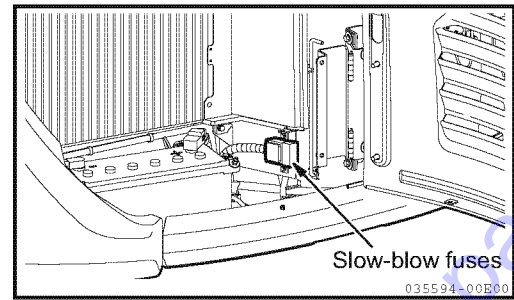

■ Replacing the fuses

If any electrical equipment does not operate when the starter switch is set to "ON" or "START", the fuse may have been blown out. Follow the procedure below:

- 1) Turn the starter switch key to the "OFF" position.
- 2) Remove the fuse box cover.
- 3) If a fuse is blown out, replace it with a spare fuse of rated capacity.

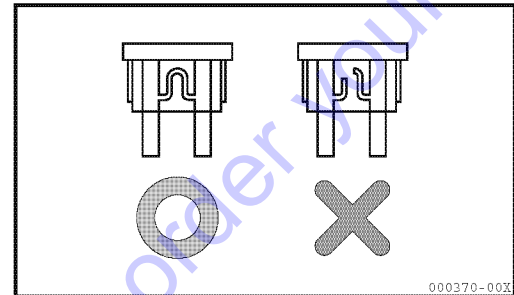

Blade fuse

Symbol	Fuse capacity	Circuit name
A	30A	(Radio), Boom light, Head light, Monitor lamp, Air conditioner, 12V Outlet
B	30 A	Air conditioner, (Refueling pump)
C	10 A	Travel shift valve, Buzzer, PTO solenoid valve, Horn, Indicator box
D	10 A	Power relay, Wiper, Window washer
E	5 A	Fuel feed pump, Generator
F	5 A	Safety relay, Cut-off valve, Travel alarm, Quick coupler
G	10 A	Room lamp
H	10 A	Engine control
I	30 A	Spare fuse
J	10 A	

Applicable to models with the relevant equipment.

(Oblique character) parts.

Slow-blow fuse

When the slow-blow fuse is damaged, contact your dealer.

Note :

To replace the fuses on both ends of the slow-blow fuse box, it is necessary to remove the screws, which are fixing the harness in the bottom of the box.

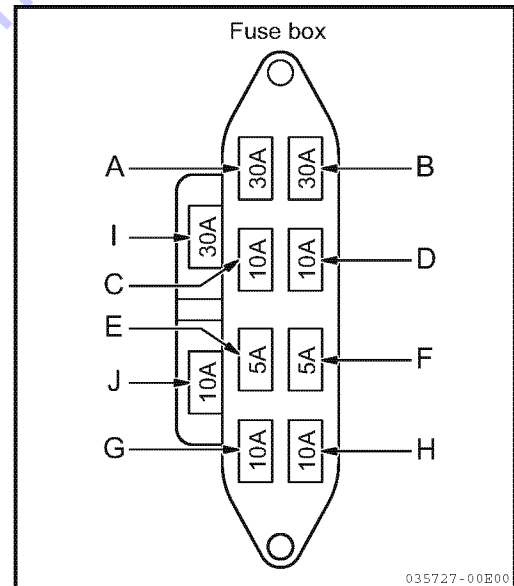

12-19. External power socket

It is the socket that can be used as a power for electronic products.

Comply the following conditions for use:

- It can be used when the starter switch key is in the "ON" position.
Use the electronic products with 12 V specification and the maximum 120 W (10 A) or below.

IMPORTANT

- **Be sure to close the cover when the external power is not in use. Not closing the cover may cause the intrusion of foreign matter.**
- **The prolonged use of battery in the engine stop condition will cause the dead battery.**

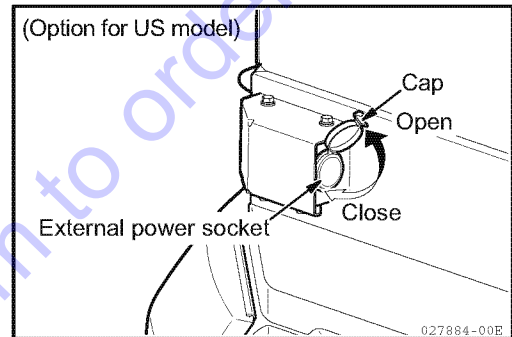
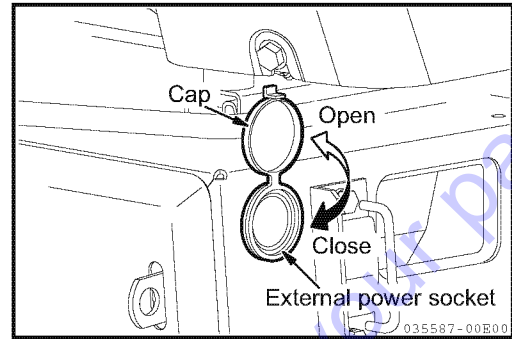

13. Operating Instructions

13-1. Checking before starting the engine

13-1-1. Walking check (visual inspection) around the machine

⚠ WARNING

- If there are any combustibles in any heat build-up areas, or if there are any fuel and/or oil leaks, a fire can result.
- Check for possible fire causes carefully. If there is anything abnormal, be sure to take corrective action or contact your dealer.

Before starting the engine, visually check the outside and underside of the machine as follows: Check bolts and nuts for loose connections; check the fuel, oil, and water for leaks; and also check the implement and the hydraulic system to see that they are operating properly. In addition, check the electrical wiring for loose connections and for dust deposits in the heat build-up areas.

Check the following points before initial start-up for the day.

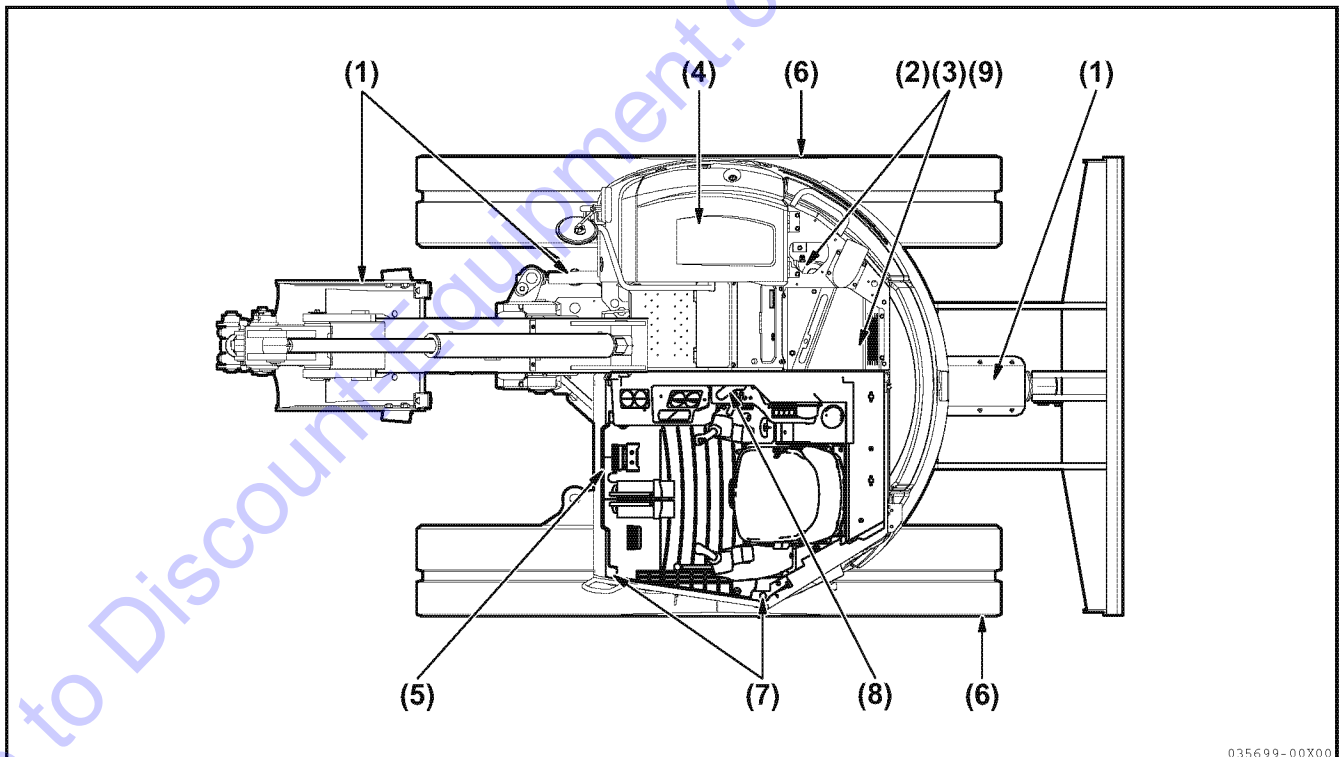

(1) Checking the implement, hydraulic cylinders, linkages, and hoses for damage, wear and loose connections

Check the implement, hydraulic cylinders, linkages, and hoses for damage, wear and loose connections. If any abnormality is found, take corrective action.

(2) Removing dust deposits from around the engine, battery, and radiator

Check to confirm that there are no dust deposits or other combustibles around the engine, on the radiator, or in other heat build-up areas, such as the muffler. If there are any, remove them.

(3) Checking the engine and its accessories for oil or water leakage

Check the engine for oil leakage and the cooling water system for water leakage.

If oil or water leakage is found, take corrective action.

(4) Checking the hydraulic system, hydraulic oil tank, hoses, and joints for oil leakage

Check for oil leakage. If oil leakage is found, take corrective action.

(5) Checking the grease piping for grease leakage

Check for grease leakage or ooze. If grease leakage or ooze is found, take corrective action.

(6) Checking the undercarriage (crawler, sprockets, and idlers) for breakage, wear, loose bolts, and oil leakage around the rollers

If any breakage or wear is found, correct it. Retighten the bolts if necessary.

If oil leakage is found, take corrective action.

(7) Checking the handrails and steps for breakage and loose bolts

If any breakage is found, take corrective action. Retighten the bolts if necessary.

(8) Checking the gauges and the monitor for breakage and loose bolts

Check the gauges and the monitor for breakage and loose bolts. If any abnormality is found, replace the gauge or the monitor with a new one, or retighten the bolts if necessary. Clean the surfaces of the gauges and monitor.

(9) Checking the water separator to see whether the red ring has sunk down to the cup bottom

If the red ring has sunk down to the cup bottom, no water has mixed into the oil; if the red ring is floating in the cup, water is mixed into the oil under the red ring. In this case, take out the cup to remove the water. Refer to Section "25-4-3. Cleaning the water separator element" for the removal and reinstallation procedure for the cup.

13-1-2. Checking before start-up

Check the following points before initial start-up for the day.

■ Checking and replenishing the cooling water

⚠ WARNING

- Do not remove the fill cap from the radiator unless supplying the cooling water.
- Check the cooling water level in the sub-tank when the engine is cool.

- 1) Open the engine hood. Then check that the cooling water level in the sub-tank (1) (illustrated at the right figure) is between the FULL and LOW marks. If the water level is below the LOW mark, refill the sub-tank up to the FULL mark through the water supply port of the sub-tank (1).

For the cooling water to be used, refer to Section "21. Fueling, Oiling and Greasing Based on Temperature Range".

- 2) After replenishing, securely tighten the cap.
- 3) If the sub-tank is empty, check it for water leakage, and then, check the water level in the radiator.
If the water level is low, refill the radiator first, then refill the sub-tank.
- 4) If the cooling water level is appropriate, close the engine hood.

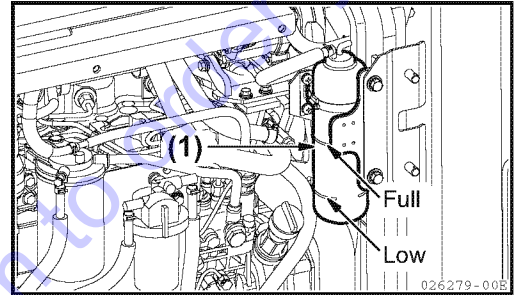

■ Checking and replenishing the engine oil

⚠ WARNING

- At operating temperature, oil and dipstick areas are hot.
Do not allow hot oil or hot components to contact the skin, to prevent bodily injury.
- Check oil level and replenish oil after engine has cooled down.

- 1) Open the engine hood and securely lock it in that position with the stopper rod.
- 2) Pick up the dipstick (G) and wipe it with a rag to remove oil deposits.
- 3) Fully insert the dipstick (G) into the dipstick tube, then draw it out.
- 4) If the dipstick (G) is wet above the midpoint between the H and L marks, the engine oil level is appropriate. If the oil level is below the midpoint between the H and L marks, add engine oil through the oil supply port (F). For the quality of the engine oil to be used, refer to Section "21. Fueling, Oiling and Greasing Based on Temperature Range".
- 5) If the engine oil level is above the H mark, remove the excessive amount of oil through the drain plug (P), then recheck the engine oil level.
- 6) After verifying that the amount of engine oil is appropriate, securely retighten the oil supply port cap and close the engine hood.

Note :

When checking the engine oil level after starting up the engine, stop the engine and allow more than 15 minutes for the engine to cool down.

If the machine is slanted, reposition the machine to ensure it is level before checking the engine oil level.

Keep in mind that the excess engine oil must not be disposed of on the ground or the road.

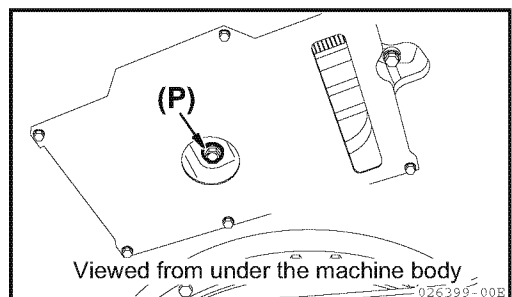
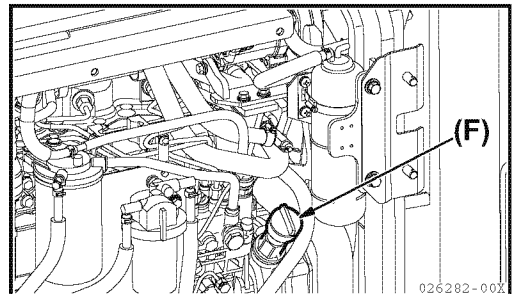
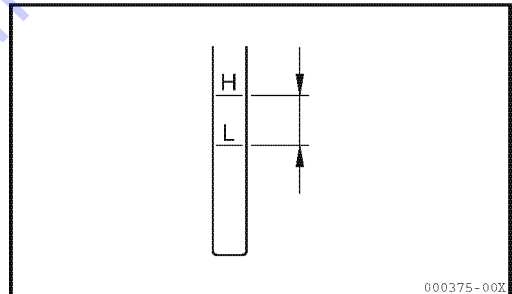
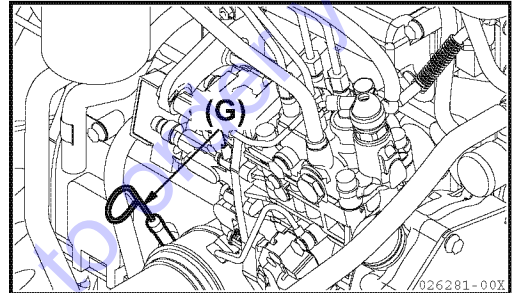

■ Checking and replenishing the fuel in the fuel tank

⚠ WARNING

Be careful not to overfill the fuel tank because it could cause a fire. If the tank is overfilled, completely wipe off the spilled fuel.

⚠ CAUTION

- Do not remove the strainer from the fuel supply port of the fuel tank when supplying fuel.
- Be careful not to allow any water that may be in the fuel container or dirt on the refueling equipment to enter the fuel tank.

- 1) Turn the starter switch key to the "ON" position, and check the fuel level. Open the cover, and supply fuel to the fuel supply port.

When the fuel meter pointer indicates "E", approximately 6.9 Gals. (26 L) of fuel is left in the tank.

Fuel tank capacity : 30.4 Gals. (115 L)

For the quality of the fuel to be used, refer to Section "21. Fueling, Oiling and Greasing Based on Temperature Range".

- 2) After refueling, securely retighten the fuel supply port cap and close the cover.

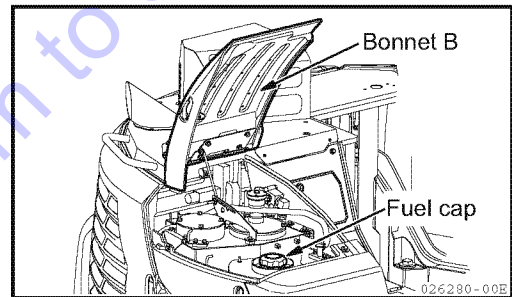
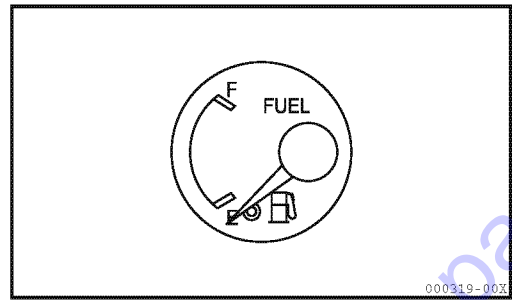

■ Checking and replenishing the hydraulic oil tank

⚠ WARNING

When removing the plug of the oil supply port, slowly loosen it to gradually relieve the internal pressure in the tank, or oil may spurt from the tank.

- 1) Park the machine as illustrated in the figure at the right. When the machine is not in that posture, start the engine, retract the bucket and arm cylinders to their stroke ends at low speed, lower the boom until the bucket teeth contact the ground, lower the blade to the ground, and stop the engine.
- 2) Check the oil level by reading the oil level gauge on the side of the tank. Confirm that the oil level is between the upper and lower limit marks.

IMPORTANT

Do not replenish hydraulic oil above the upper limit mark on the oil level gauge. An excessive amount of hydraulic oil may damage the hydraulic system by placing stress on its components, causing a dangerous high-pressure leak.

- 3) Open the bonnet B. Remove the plug of the oil supply port (F) and add oil if the oil level is below the lower limit.

For the quality of the oil to be used, refer to Section "21. Fueling, Oiling and Greasing Based on Temperature Range".

Note :

Note that the oil level varies with the oil temperature.

When reading the oil level, follow these guidelines:

- Before start-up, the oil level gauge should read at or near the midpoint of the gauge scale
[oil temperature : 50 to 86°F (10 to 30°C)].
- During normal operation, the oil level gauge should read at or near the upper limit mark of the gauge scale
[oil temperature : 122 to 176°F (50 to 80°C)].

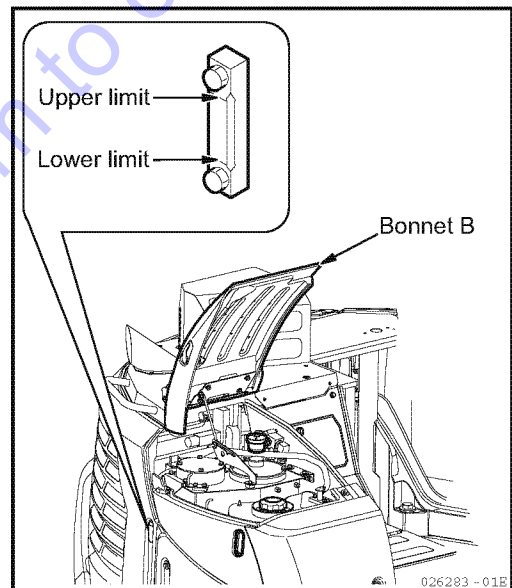
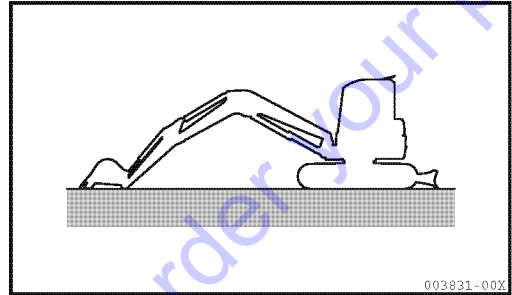

■ Checking and adjusting the fan belt tension

- 1) Open the cover (1).
- 2) Press down on the fan belt between the fan pulley and the generator with a finger, to check the fan belt tension.

Pressing force : Approximately 22.1 lbs. (10 kgf)

Correct slack : 0.4 to 0.6 in. (10 to 15 mm)

- 3) Adjust the tension if necessary.
Refer to Section "25-3-5. Checking and adjusting the fan belt tension" for the adjustment procedure.
- 4) When the tension is proper, close the cover.

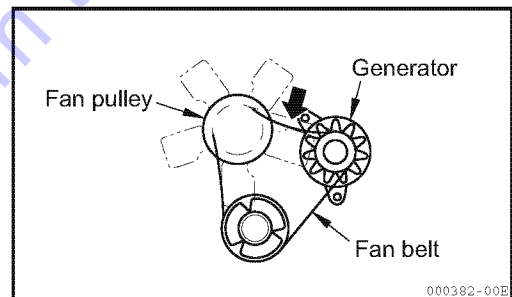
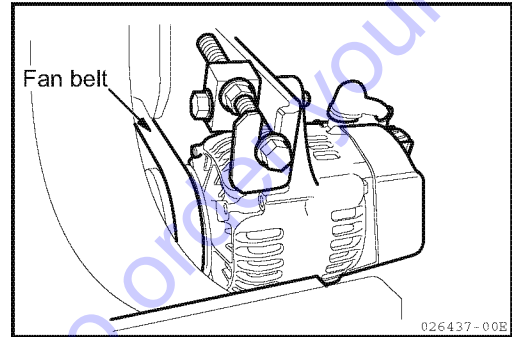
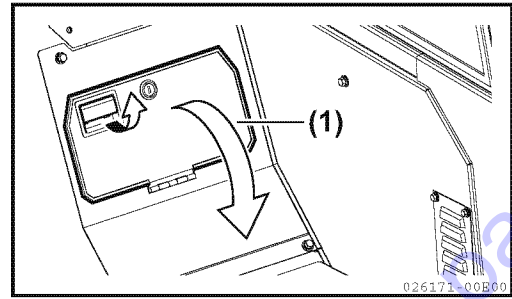

■ Checking and replenishing the battery electrolyte

⚠ DANGER

- The battery generates flammable gas and can cause a fire and an explosion. Keep sparks, flames and lit cigarettes away from the battery.
- Battery electrolyte is strong acid. To avoid serious injury, do not allow the electrolyte to contact your skin or splash into your eyes.
- Always wear safety goggles and protective clothing, when adding electrolyte.
- Do not use the machine with the battery which is short of battery electrolyte. The shortage of battery electrolyte not only will reduce the life of the battery but also could cause an explosion.

- 1) Open the bonnet R to check the electrolyte level. The level must be between the upper and lower level marks.
- 2) If the electrolyte level is lower than the lower level mark, replenish it.

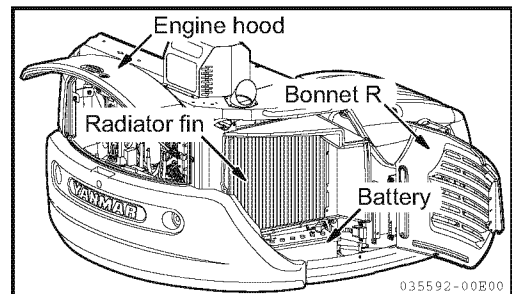

■ Greasing

IMPORTANT

Grease the fittings thoroughly after washing the machine or after operation in rain, on soft ground, or in muddy water.

- 1) Put the bucket and the blade on the ground and stop the engine.
- 2) Clean the grease nipples indicated by arrows in the figures at the right and grease them with a grease gun.
- 3) After greasing, wipe off any excess that remains.
- 4) For greasing for quick coupler type, refer to Section "13-14-10. Maintenance".

■ Implement

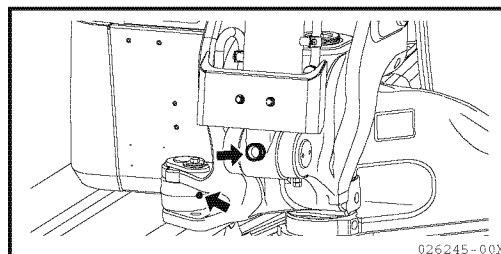
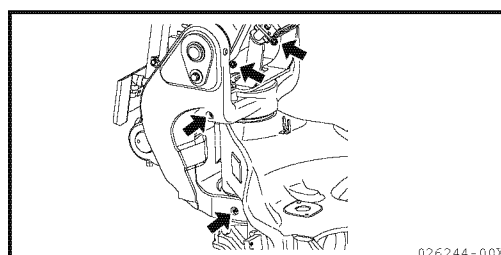
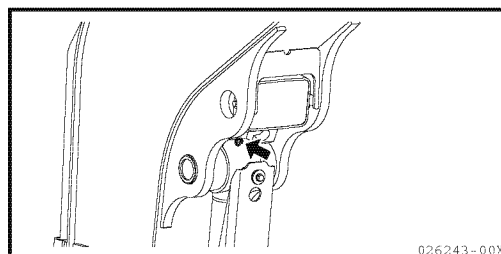
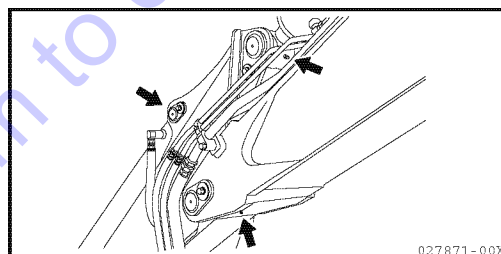
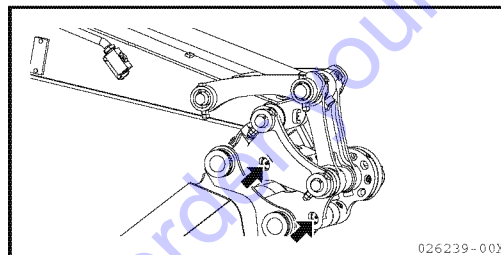
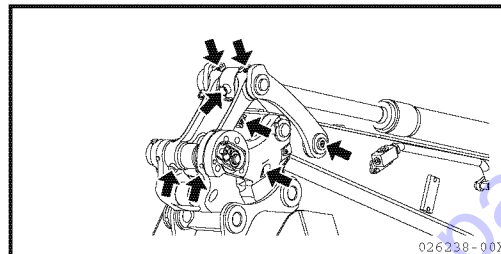

■ Blade

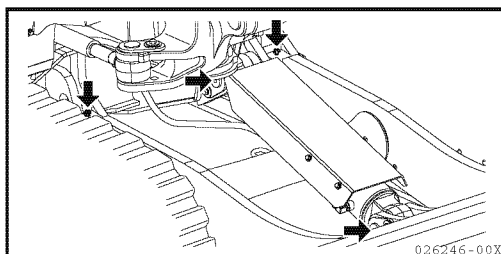

Go to Discount-Equipment.com to order your parts

■ Checking the electrical equipment

CAUTION

If a fuse blows out frequently, contact your dealer for assistance.

Check fuses for damage, wiring for poor connections or short circuits, and battery terminals for corrosion or loose fits. Take corrective action.

Check the following items after the starter switch is turned to the "ON" position.

1) Check the monitor functions.

- Check the fuel gauge, water temperature gauge, and hour meter.
- Check the engine oil pressure alarm lamp, charge alarm lamp, water temperature alarm lamp, Engine trouble monitor lamp, Auto-deceleration indicator lamp.

2) Check that all switches function correctly and all lamps light correctly.

- Check the horn.
- Check the cabin lights, and boom lights.
- Check the wiper function.
- Check the room lamp for lighting.
- Check the air conditioner.
- Check the activation of auto-deceleration.

3) Check the travel alarm function.

- To check the travel alarm function, push or pull the travel levers after the lock lever have been unlocked.

13-1-3. Operating and checking instructions before starting up the engine

! WARNING

- Accidentally operating a control lever can cause the machine to move suddenly, possibly causing a serious accident.
- When leaving the operator's seat, be sure to place the lock lever securely in the lock position.

- 1) Check that the lock lever (1) is in the lock position.
- 2) Check that all other levers are in their appropriate positions.
- 3) Fasten the seatbelt snugly.
- 4) Insert the starter switch key into the starter switch (2) and set it to the "ON" position. Then check the following points:

[1] The buzzer will sound, and the following alarm lamps will go on or flash.

- Engine oil pressure alarm lamp (3)
- Battery charge alarm lamp (4)
- Water temperature alarm lamp (5) (goes off in 2 to 3 seconds)
- Engine trouble monitor lamp (6) (turns off in 2 to 3 seconds)

If any of the alarm lamps do not go on or the buzzer does not sound, it may mean that an alarm lamp has blown out or is broken. Take corrective action, or consult your dealer for assistance.

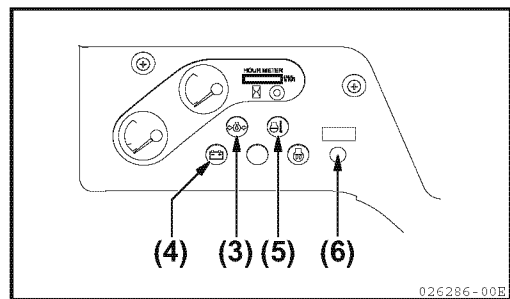
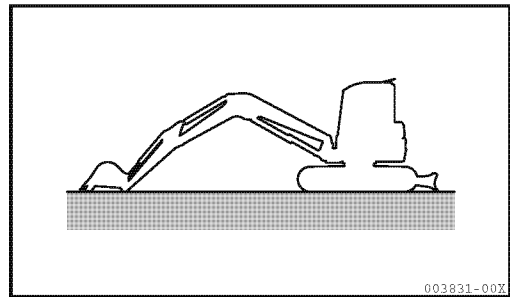
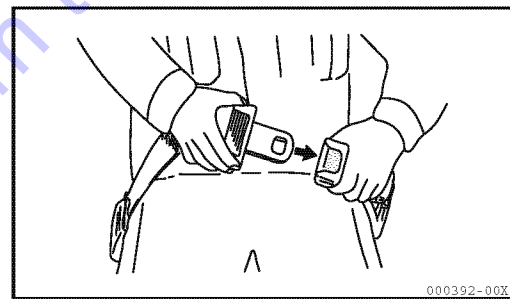
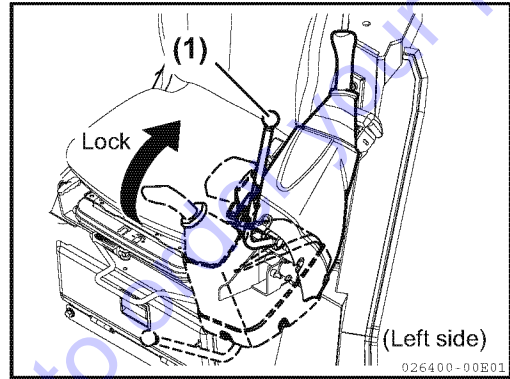
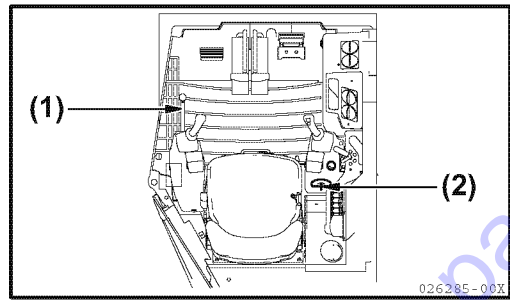

13. Operating Instructions

[2] Turn the light switch "ON" to see whether the headlights will go on. If either or both of them do not go on, the lamp(s) might have blown out or might be broken. Take corrective action, or consult your dealer for assistance.

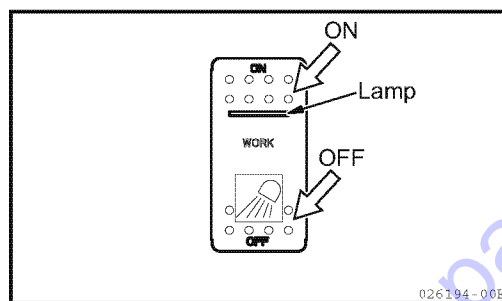

Go to Discount-Equipment.com to order your parts

13-2. Starting up the engine

13-2-1. Normal start-up

! WARNING

- First check that there are no people or obstacles around the machine.
Then sound the horn and start the engine.
- Be sure that you are seated on the operator's seat when starting the engine.
- When starting the engine in an enclosed place, be sure that there is adequate ventilation so that the exhaust gases can escape.

- 1) Turn the engine control dial (1) to the RUN direction.
- 2) Set the starter switch key in the starter switch (2) to the "START" position. The engine will start.
- 3) After the engine has started, let go of the starter switch key.
The starter switch key will return to the "ON" position by itself.

Note :

When the engine is warm, the engine can start up even if the accelerator lever is left in the "IDLING" position.

IMPORTANT

To protect the starter motor and the battery:

- Do not keep the starter switch key in the "START" position for more than 10 seconds.
- If the engine fails to start, do not attempt to start the engine immediately again, but set the switch to the "OFF" position and wait for approximately 30 seconds, then start the engine again.

The swing motor brake is engaged when the engine is "OFF", but is released when the engine starts.

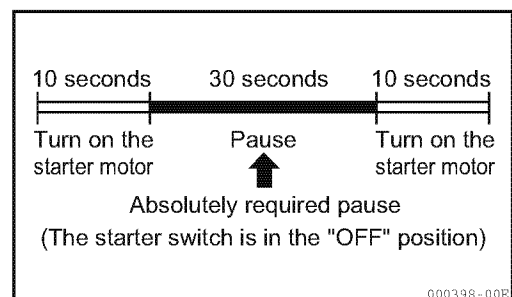
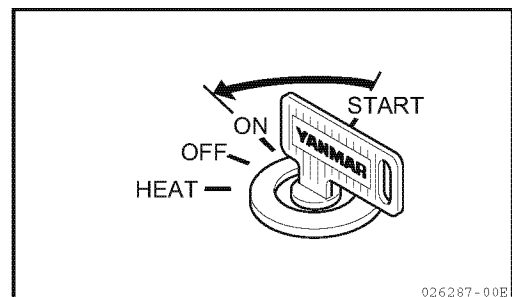
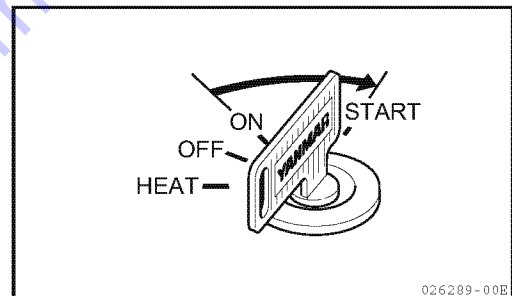
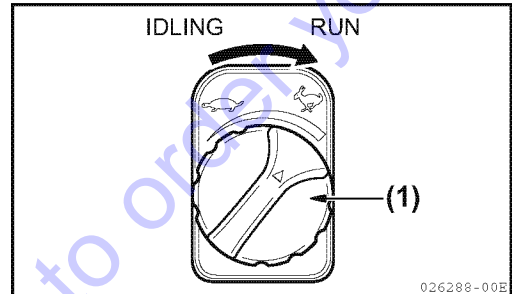
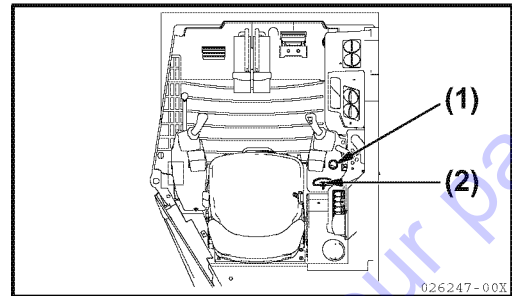

13-2-2. Starting the engine in cold weather

⚠ WARNING

- First check that there are no people or obstacles around the machine.
Then sound the horn and start the engine.
- Be sure that you are seated on the operator's seat when starting the engine.
- When starting the engine in an enclosed place, be sure that there is adequate ventilation so that the exhaust gases can escape.

To start the engine when the outside air temperature is low, follow the steps below:

1) Turn the engine control dial (1) to the RUN direction.

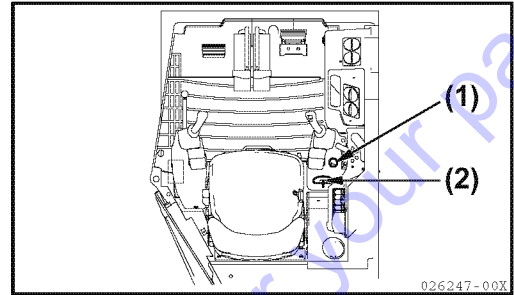

2) Turn the starter switch key in the starter switch (2) to the "HEAT" position and keep it there for approximately 10 to 15 seconds to preheat the intake air of the engine.

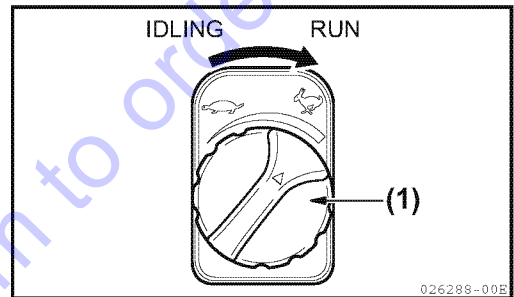

3) Turn the starter switch key in the starter switch (2) to the "START" position to start the engine.

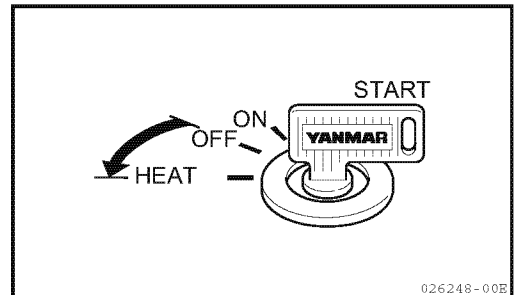

4) After the engine has started, let go of the starter switch key.

The starter switch key will return to the "ON" position by itself.

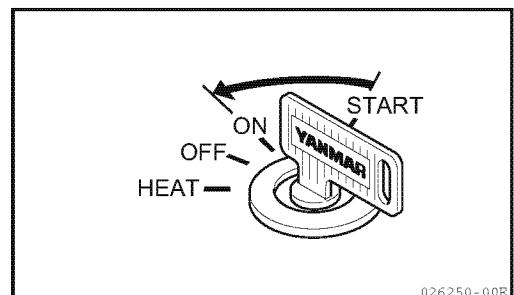
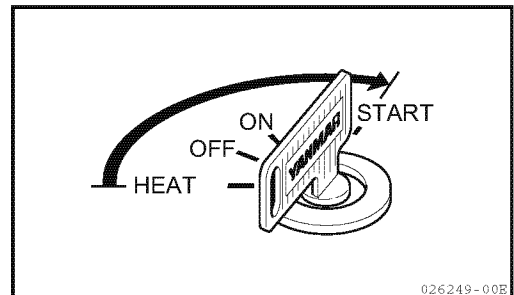

- 5) When the engine speed has increased, turn the engine control dial to the IDLING position.

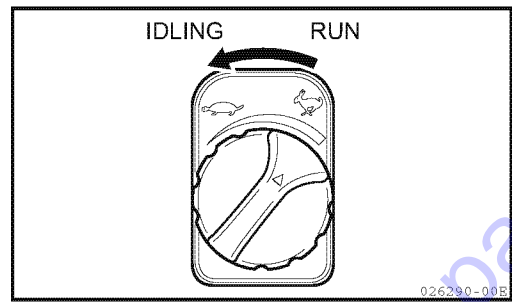

IMPORTANT

To protect the starter motor and the battery:

- Do not keep the starter switch key in the "START" position for more than 10 seconds.
- If the engine fails to start, do not start the engine immediately again, but set the switch to the "OFF" position and wait for approximately 30 seconds, then start the engine again.
- Traveling or operating the machine without adequate warming in cold weather may adversely affect the machine performance.

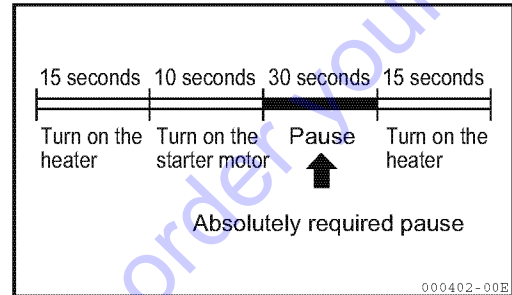

Go to Discount-Equipment.com to order your parts

13-3. Operating and checking instructions after starting the engine

⚠ WARNING

- **Emergency stop.**
If abnormal operation occurs, turn the starter switch key to the "OFF" position, to shut off the electrical system and the engine. Then ask your dealer to check the machine.
- **Be sure to warm up the engine.** If you operate the implement without full warm-up, the machine may not respond or operate properly, especially in cold weather.

IMPORTANT

- The proper hydraulic oil temperature is between 122°F and 176°F (50°C and 80°C).
If you have to operate the machine at a low hydraulic oil temperature, increase the hydraulic oil temperature to about 68°F (20°C) before operating the implement.
- In the event that you have to operate any control lever at a temperature lower than 68°F (20°C), operate it gently.
- Do not accelerate the engine rapidly until the engine warms up.

After starting the engine, do not start operating the machine immediately but follow this procedure:

- 1) Idle the engine, to check that the engine oil pressure alarm lamp is off.
- 2) Turn the engine control dial (1) to the IDLING and RUN position, and run the engine with no load at medium speed for approximately five minutes.

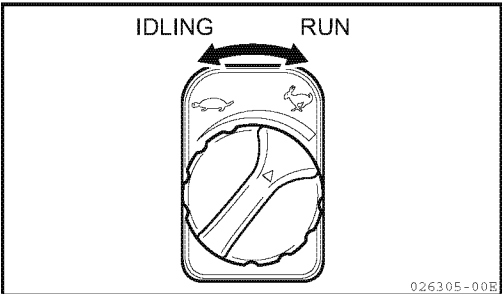
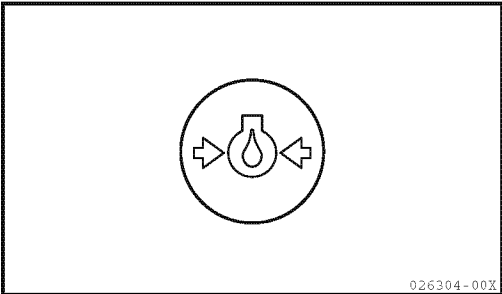
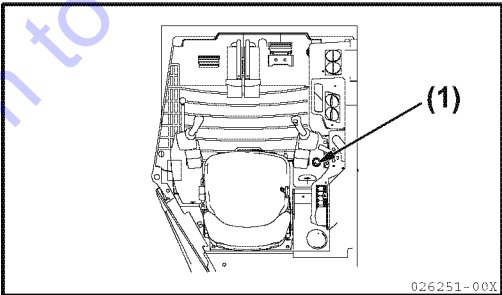

- 3) Unlock the lock lever (2), and lift the bucket from the ground.
- 4) Operate the bucket and arm control levers slowly to move the bucket and arm cylinders to their stroke ends. Operate the bucket for thirty seconds and the arm for thirty seconds alternately for approximately five minutes to increase the hydraulic oil temperature to 68°F (20°C).

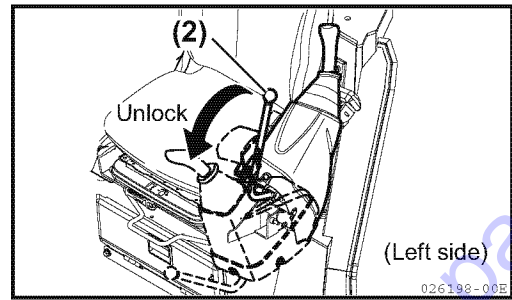

IMPORTANT

When moving the implement, be careful not to bump it against the machine or the ground.

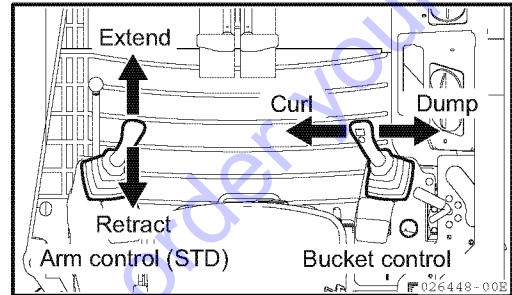

- 5) After warming up the engine, check that the gauges and the monitor are in the following status. If there is anything abnormal, take corrective action.

- Fuel meter (1), water temperature meter (2) and hour meter (3) Normal
- Engine oil pressure alarm lamp (4) Off
- Battery charge alarm lamp (5)..... Off
- Water temperature alarm lamp (6) Off
- Engine trouble monitor lamp (7)..... Off

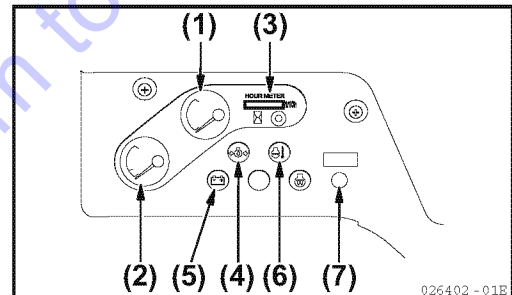

- 6) Check the exhaust gas color, the machine noise, and the vibration level for abnormality. If something is abnormal, take corrective action.

- 7) Set the lock lever (2) to the "LOCK" position to confirm that the implement cannot be operated and the upperstructure cannot be swung with the left and right control levers.

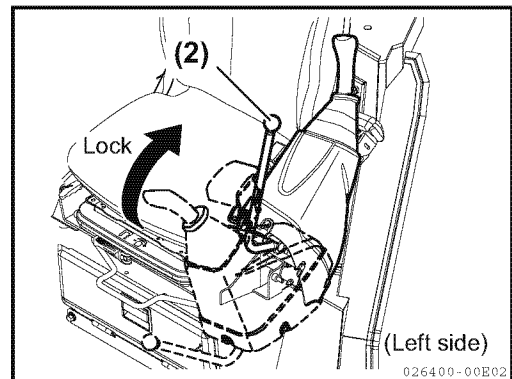

- 8) Unlock the lock lever and operate the control levers to check that the implement can be operated and the upperstructure can be swung normally. If something is abnormal, take corrective action.

- 9) Check that the swing brake valve operates normally. If something is abnormal, take corrective action.

- 10) Check that no abnormal noise is heard from the hydraulic pump. If any abnormal noise is heard, take corrective action.

Ask your dealer to resolve any problems identified in steps 1) to 10) above.

13-4. Traveling

13-4-1. Traveling forward

! WARNING

- Always check the position of the blade before operating the travel levers and pedals.
- When the blade is in the rear, the travel levers and pedals operate in reverse of normal operation.
- A signal person should be in attendance to give signals at sites which are dangerous or not clearly in view of the operator.
- Clear all people from the working area.
- Sound the horn before beginning travel, to alert the people near the machine.
- Clear obstacles from the path of the machine.
- Do not operate the travel levers and pedals rapidly while the engine is running at high speed. Otherwise, the machine may move unexpectedly, causing a serious accident.

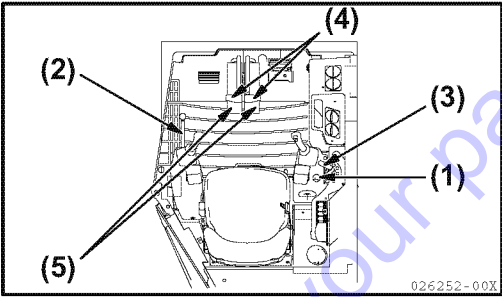

1) Turn the engine control dial (1) to the RUN direction and increase the engine speed.

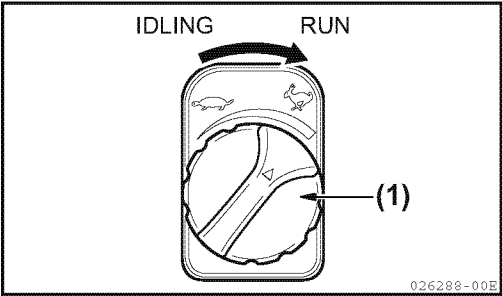

2) Unlock the lock lever (2), and retract the implement to raise it 16 to 20 in. (40 to 50 cm) above the ground.

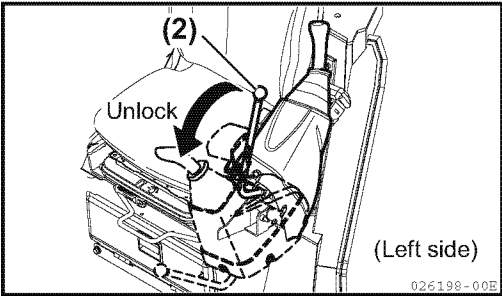

3) Pull back the blade lever (3) to raise the blade.

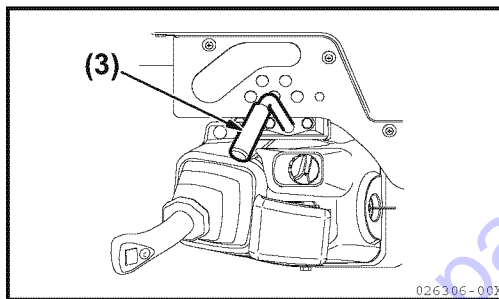

4) Operate the left and right travel levers (4) or pedals (5) as follows:

- When the blade is in the front of the machine:
Slowly push the travel levers (4) forward or step on the front of the pedals (5) to move the machine forward.

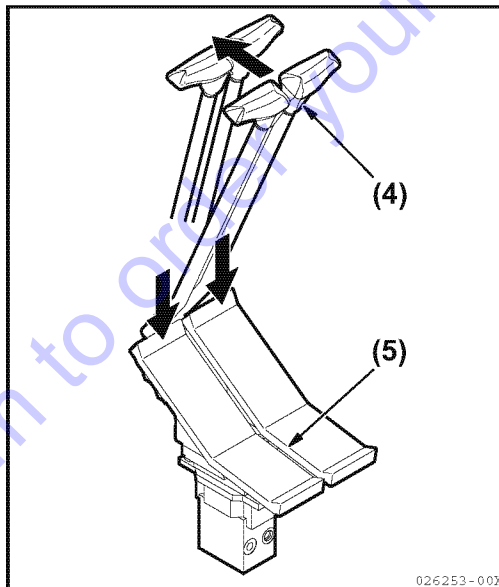

- When the blade is in the rear of the machine:
Slowly pull the travel levers (4) back or step on the rear of the pedals (5) to move the machine forward.

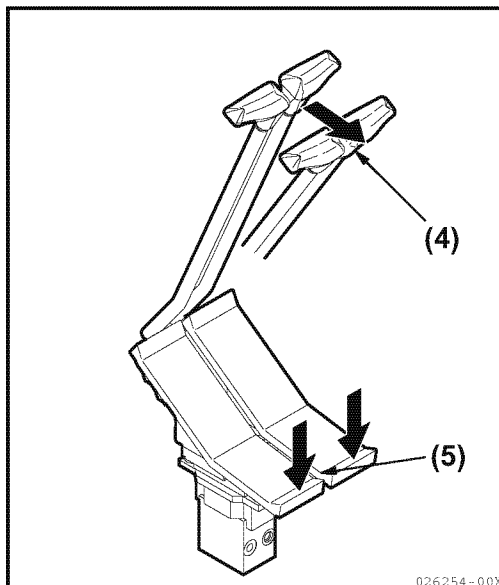

Go to Discount-Equipment.com to order your parts

13-4-2. Traveling in reverse

⚠ WARNING

- Always check the position of the blade before operating the travel levers and pedals. When the blade is in the rear of the machine, the travel levers and pedals operate in reverse of normal operation.
- A signal person should be in attendance to give signals at sites which are dangerous or not clearly in view of the operator.
- Clear all people from the working area.
- Sound the horn before beginning travel to alert the people near the machine.
- Clear obstacles from the path of the machine.
- There is a blind spot behind the machine. Make sure that no people are in the blind spot before traveling backwards.
- Do not operate the travel levers and pedals rapidly while the engine is running at high speed. Otherwise, the machine may move unexpectedly, causing a serious accident.

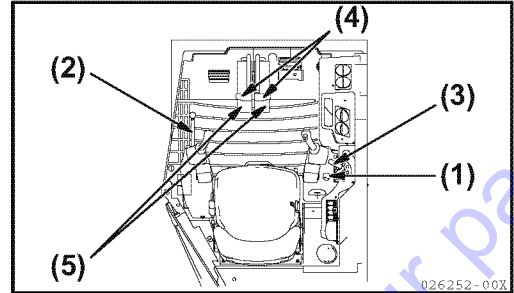

1) Turn the engine control dial (1) to the RUN direction and increase the engine speed.

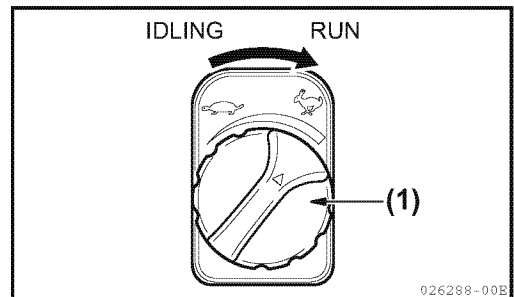

2) Unlock the lock lever (2), and retract the implement to raise it 16 to 20 in. (40 to 50 cm) above the ground.

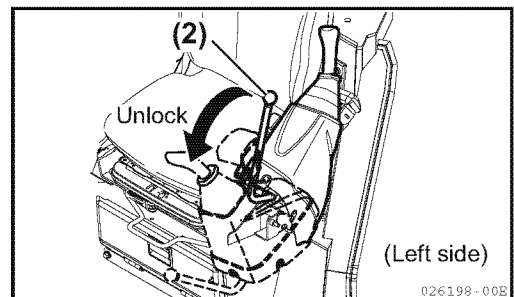

3) Pull back the blade lever (3) to raise the blade.

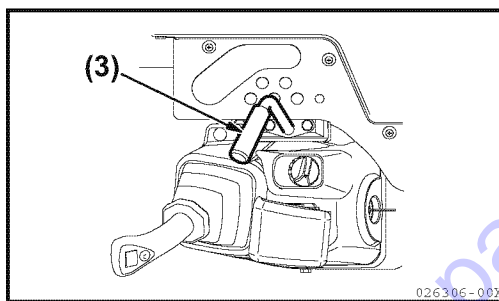

4) Operate the left and right travel levers (4) or pedals (5) as follows:

- When the blade is in the front of the machine:
Slowly pull the travel levers (4) back or step on the rear of the pedals (5) to move the machine backward.

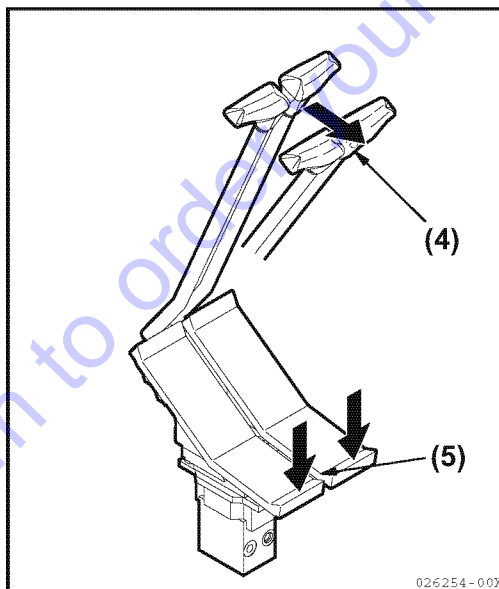

- When the blade is in the rear of the machine:
Slowly push the travel levers (4) forward or step on the front of the pedals (5) to move the machine backward.

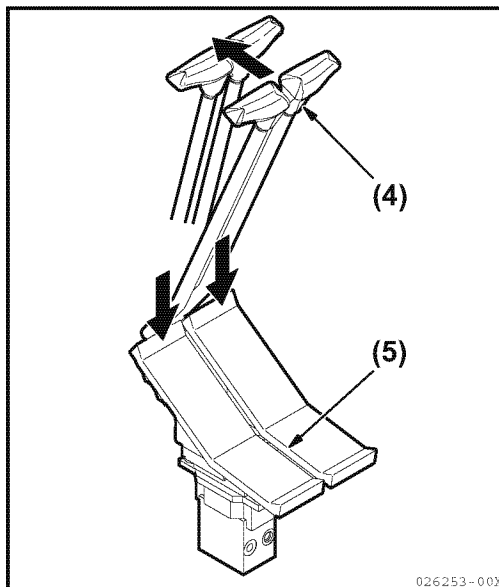

13-5. Steering

13-5-1. Steering (turning the machine)

⚠ WARNING

Always check the position of the blade before operating the travel levers.

When the blade is in the rear, the travel levers operate in reverse of normal operation.

Do not use the travel pedals to steer the machine, or the machine may not be controlled expectedly, causing a serious accident.

To steer the machine, operate the travel levers only. Do not turn the machine too sharply. Before spin-turning, always stop the machine first. Operate the two travel levers (1) as follows:

Steering the machine when it is not traveling

To turn left, push the right travel lever forward and start traveling forward to the left. Pull the right travel lever back and start traveling in reverse to the left.

Note :

To turn right, operate the left travel lever in the same manner as above.

Steering the machine while traveling (the left and right travel levers are both tilted in the same direction)

To turn left, return the left travel lever to the neutral position.

Note :

To turn right, return the right travel lever to the neutral position.

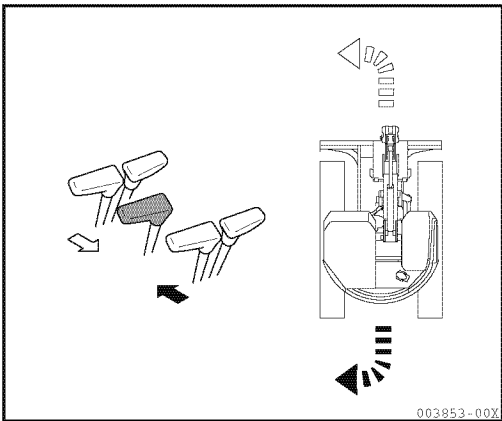
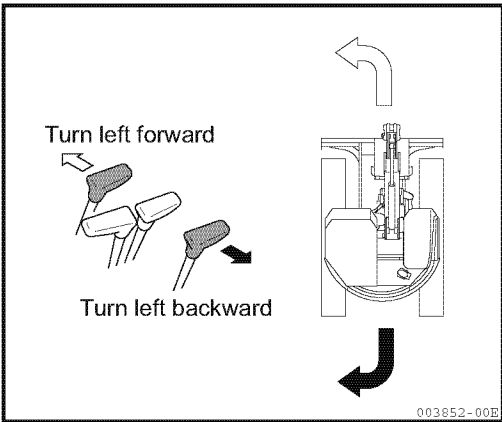
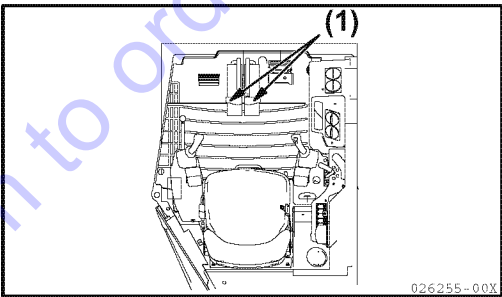

■ **Spin-turning the machine when it is not traveling**

To spin-turn left, push the right travel lever forward while pulling the left travel lever back.

Note :

To spin-turn right, push the left travel lever forward while pulling the right travel lever back.

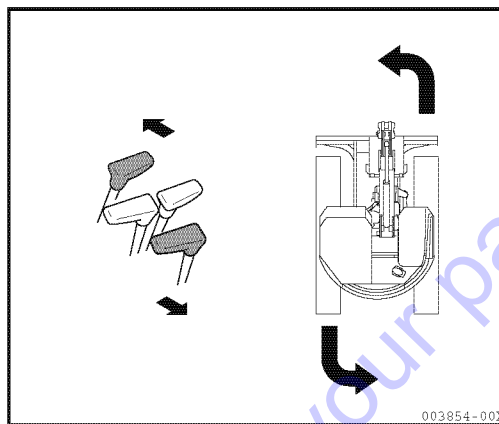

Go to Discount-Equipment.com to order your parts

13-6. Stopping the machine

⚠ CAUTION
Do not stop the machine suddenly but provide a safety margin.

⚠ WARNING

- Park on solid, level ground.
- Do not park on a slope. If it is unavoidable to park on a slope, place solid blocks of wood behind the crawlers, place the blade on the ground, and dig the bucket into the ground.

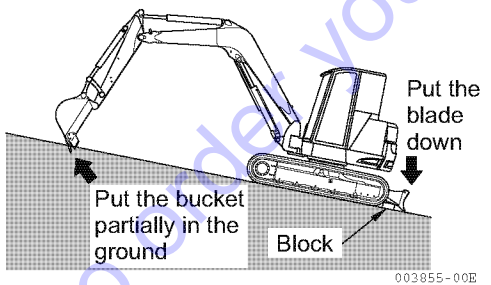

⚠ WARNING

- Do not touch the control levers and pedals accidentally. Otherwise, the implement or the machine may move unexpectedly, causing serious bodily injury.
- Whenever leaving the operator's seat, be sure to place the lock lever securely in the lock position and remove the starter switch key.

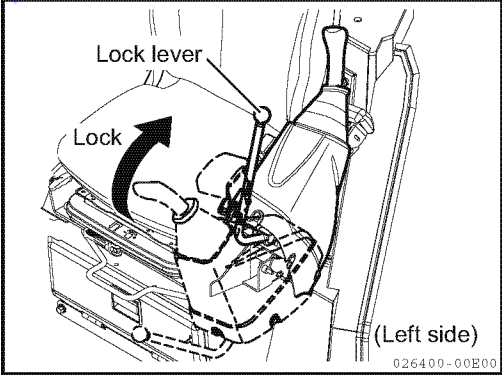

1) Set the right and left travel levers (1) or pedals (2) to the neutral position to stop the machine.

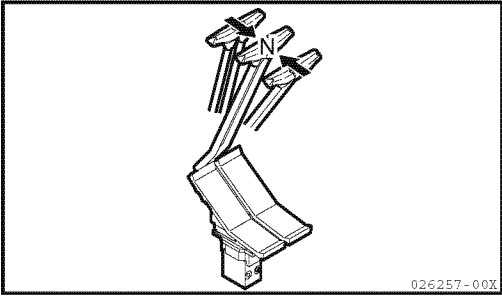
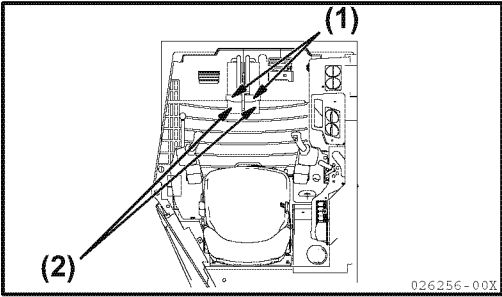

13-7. Swinging the upperstructure

⚠ WARNING

Before swinging, make sure that there are no people or obstacles within the swing range of the implement or the machine tail.

1) To swing the upperstructure, operate the left control lever as illustrated in the figure at the right.

(A) : Swing right

(B) : Swing left

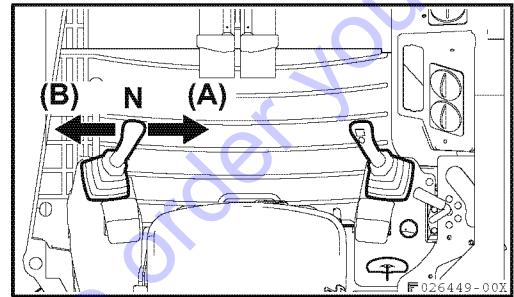

Go to Discount-Equipment.com to order your parts

13-8. Operating the implement

⚠ WARNING

- Check the area around the machine for safety and sound the horn before beginning to operate the machine.
- The setting of the pattern change lever alters control lever operation. Always chose the pattern (STD VS. OPT) that you prefer to use.
- To prevent accidental injury, never operate the Excavator before confirming the setting of the pattern change lever.

Operate the machine using the right and left control levers, the boom swing pedal and the blade lever.

<STD Pattern>

- Control lever (L) : Operates arm and upperstructure swing.
- Control lever (R) : Operates boom and bucket.

<OPT Pattern>

- Control lever (L) : Operates boom and upperstructure swing.
- Control lever (R) : Operates arm and bucket.
- Boom swing pedal : Operates boom swing.
- Blade lever : Operates blade.

The relationships between the operation of the control levers, the boom swing pedal and the movement of the implement are shown in the illustrations on the right.

On releasing the control levers and the boom swing pedal, they will return to their neutral positions and the implement will stop moving.

003857-00E

13-9. Precautions for operating the implement

⚠ WARNING

- Do not operate the implement control levers while traveling. Stop traveling first and then operate the implement.
- Do not operate the implement on any rocky surface.

■ Do not use the implement's swing force

Do not level the ground or break down a wall by the use of swing force, and do not dig the bucket teeth into the ground while swinging. Doing these may cause the implement to be damaged.

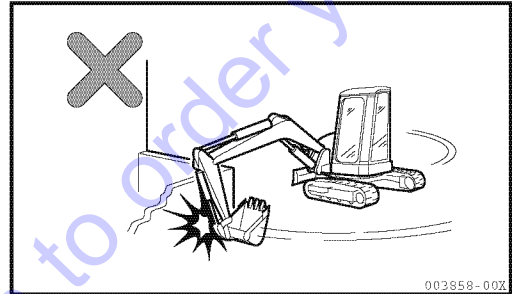
**■ Do not use the implement's travel force**

Do not excavate the ground by the use of travel force with the bucket teeth in contact with the ground. Doing this may cause excessive force to be imposed on the rear of the machine, shortening the machine life.

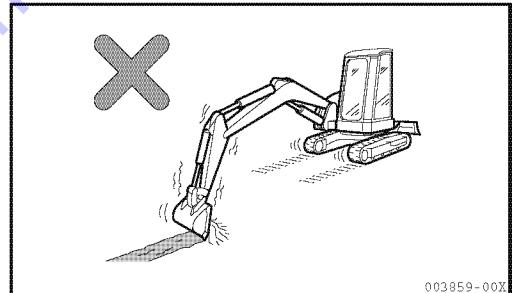
**■ Take care not to operate the hydraulic cylinder to the stroke end**

Operating the hydraulic cylinder to the stroke end may impose an undue force on the stopper in the hydraulic cylinder, shortening the implement life. Operate with a small safety margin.

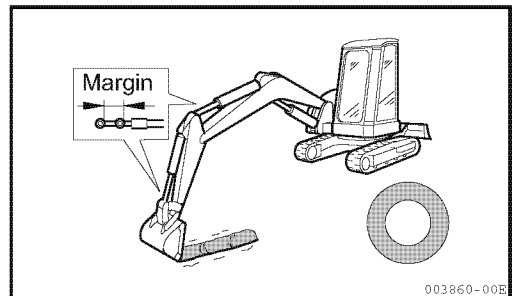
**■ Do not operate the implement by the using the dropping force of the bucket**

Do not excavate the ground by using the dropping force of the bucket as a pickaxe or pile driver. Doing this may cause excessive force to be imposed on the rear of the machine, shortening the machine life and possibly causing a serious accident.

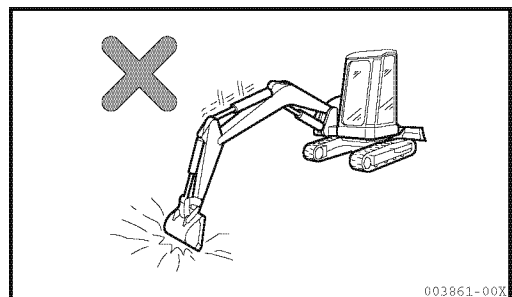

13. Operating Instructions

■ **Do not operate the implement by using the dropping force of the machine**

Do not excavate the ground by using the dropping force of the machine.

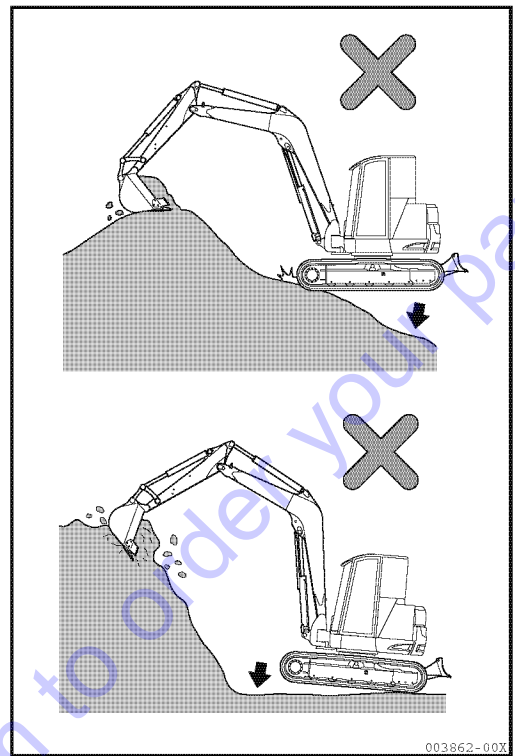

■ **Excavating a hard rock**

It is recommended that a hard rock first be broken into small pieces by other means. Doing so will prevent damage to the machine and will increase economic efficiency.

■ **Do not suspend a load unless you use a hooked bucket**

Suspending a load safely requires the use of a hooked bucket. Refer to Section "28. Handling the Hooked Bucket".

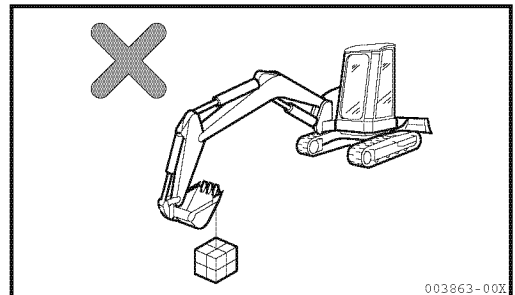

■ **Do not bump the blade against a large rock or boulder**

Never bump the blade against a large rock or boulder. Doing so may cause the blade or the hydraulic cylinder to be damaged.

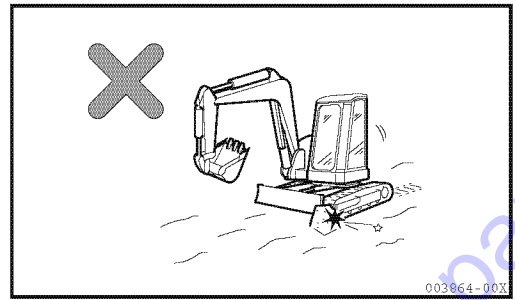

■ **Be careful when retracting the implement**

When retracting the implement for travel or transport, be careful that the bucket and the blade never bump against each other.

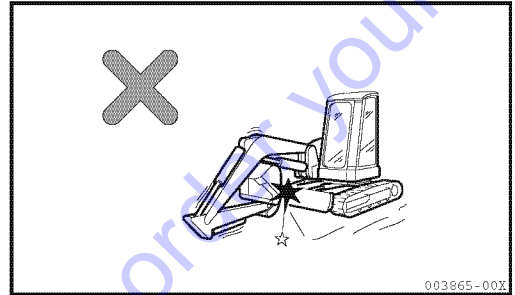

■ **Support the blade on both sides**

When you use the blade as an outrigger, support the blade on both sides.

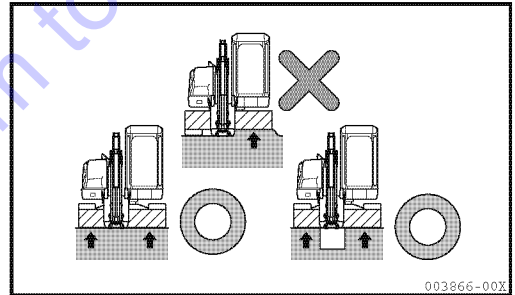

■ **Be careful not to bump the blade when excavating**

When excavating the ground with the blade in front, never let the blade bump against the boom cylinder. Place the blade in the rear, when it is not being used.

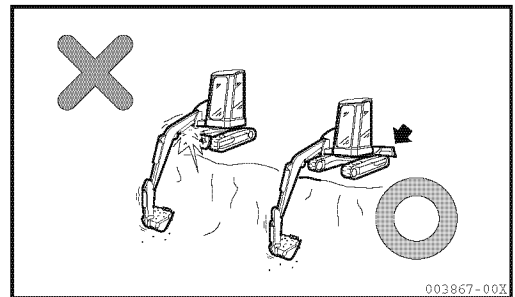

Go to Discount-Equipment.com to order your parts

13-10. Precautions for working

■ Precautions for traveling

Driving over a stone or a stump subjects the machine (especially undercarriage) to a shock, which may cause damage to the machine.

Avoid such obstacles by driving around them, or removing them.

If driving over them is unavoidable, reduce speed, hold the implement close to the ground, and drive over the obstacles with the center of the track shoes.

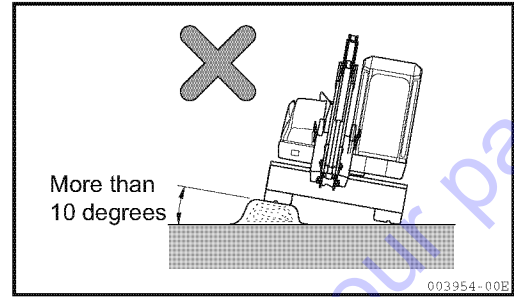

■ Allowable water depth

IMPORTANT

When driving out of water, if the machine climbs a slope at an angle of more than 15 degrees, the rear of the upperstructure may submerge too deeply in the water, which may damage the radiator fan. Avoid this if possible when driving out of water.

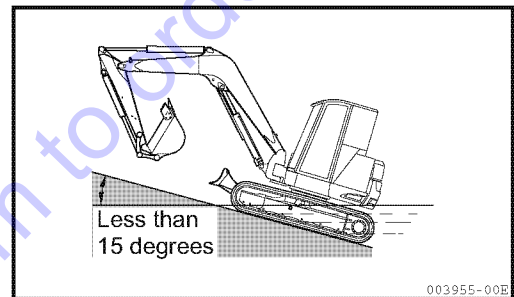

The maximum water depth in which the machine can be used is up to the center of the carrier roller.

Apply a generous amount of grease to the moving parts that have been submerged in the water for a long time until the used grease is extruded out of the bearings.

Wipe away the extruded used grease.

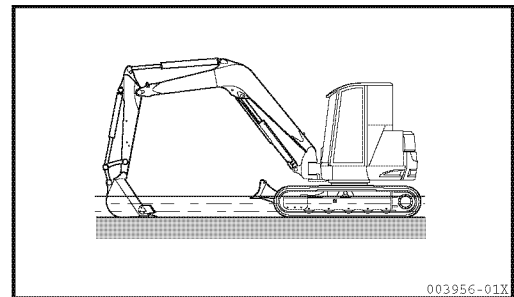

13-11. Precautions for going up and down a slope

⚠ WARNING

- When traveling on a slope, place the implement in the direction of travel and raise the bucket 8 to 12 in. (20 to 30 cm) above the ground.
- When driving over obstacles such as foot paths, hold the implement close to the ground and drive the machine slowly.
- Never turn on or traverse a slope. Descend to flat ground to make a course change.
- If the machine is starting to slip or you feel that the machine is unstable, place the bucket on the ground and stop the machine at once.
- Recognize that the machine may roll over when swinging the upperstructure or operating the implement on a slope.

Do not swing the upperstructure toward the downward side of the slope with a load in the bucket.

If swinging is unavoidable, first lay earth on the slope to maintain the machine as horizontal as possible, then swing the upperstructure.

- Do not travel on a slope of 20 degrees or more, as the machine may upset.

- 1) Go down slopes at low speed, using the travel levers and accelerator lever to control your speed.

When going down a slope, drive the machine at low engine speed and position the implement as shown in the figure on the right.

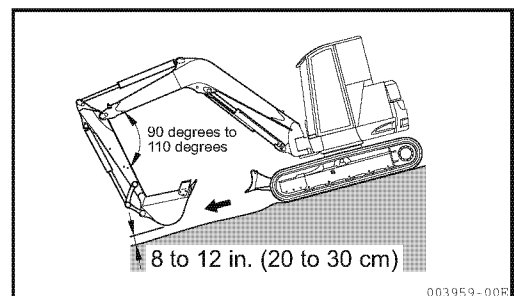
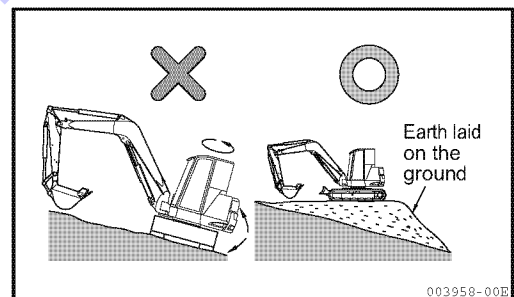
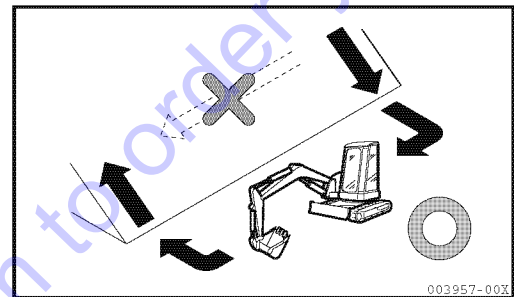

- 2) When climbing a slope, drive the machine with the implement positioned as shown in the figure on the right.

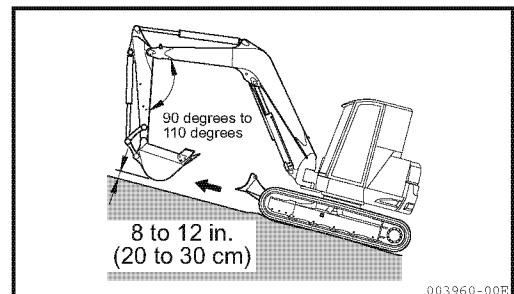

■ Braking when going down a slope

When going down a slope, you can automatically brake the machine by setting the travel levers to the neutral position.

■ When the crawler is slipping

If you cannot climb a slope by operating the travel levers because the crawler is slipping, retract the arm and use the pull-back power of the implement to help you climb the slope.

■ When the engine stops

If the engine stops while climbing a slope, set the travel levers to the neutral position, stop the machine, and restart the engine.

■ Precautions for traveling on a slope

Do not open or close the cabin side door on a slope.

Doing this may cause the door to swing open or closed very rapidly.

Be sure to lock the cabin side door in either the open or closed position.

Go to Discount-Equipment.com to order your parts

13-12. Escaping from the mud

Carefully operate the machine not to allow it to get mired in mud. If the machine is mired in mud, the machine can escape as follows:

13-12-1. If only one track is mired in the mud

If only one track is mired in the mud, place the bucket on the muddy side, lift the track above the ground, lay a log or a wood block under the track shoe, and raise the bucket to escape.

IMPORTANT

When lifting the machine above the ground with the boom or the arm, press on the ground with the bottom of the bucket. (Do not press on the ground with the bucket teeth.)

In doing this, the angle between the boom and the arm should be 90 degrees to 110 degrees.

The same procedure described above should be utilized when the bucket is in the reverse position.

13-12-2. If both tracks are mired in the mud

If both tracks are mired in the mud, lay a log or a wood block under the track shoes in the same manner as mentioned above, dig the bucket into the solid ground, retract the arm just as when excavating, and push the travel levers forward to escape from the mud.

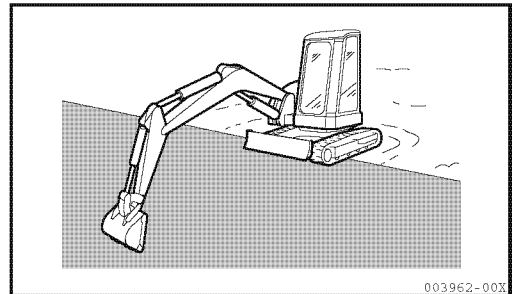
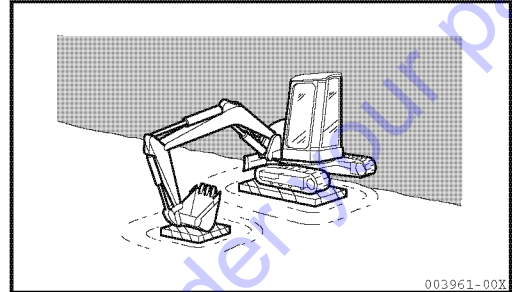

13-13. Operations using the bucket

You can greatly widen the range of work described here by using optional attachments.

13-13-1. Backhoe operation

Backhoe operation is suitable for digging the ground below the machine.

Suppose that the machine is operating as illustrated in the figure at the right : a maximum digging force of each cylinder can be obtained when the angle between the bucket cylinder and the bucket arm as well as between the arm cylinder and the arm is maintained at 90 degrees.

When digging, make good use of this angle to increase the operating efficiency.

To excavate the ground efficiently by manipulating the arm, the arm needs to be operated within a range of angles between 45 degrees forward and 30 degrees backwards, as illustrated in the figure at the right. Though the range differs according to the depth of the work, do not move the implement to the cylinder stroke end.

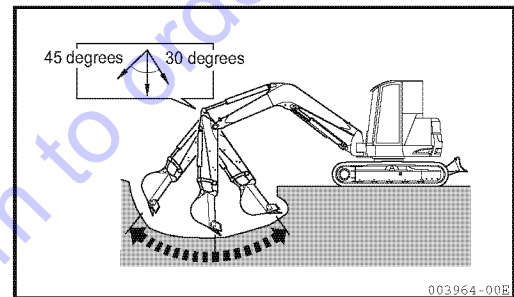
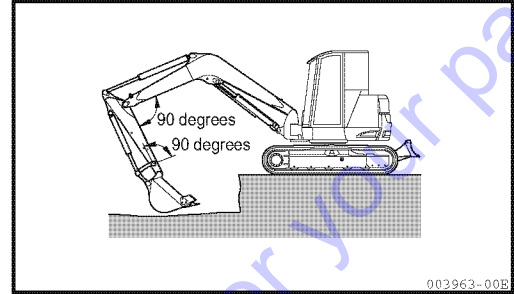

13-13-2. Shoveling

Shoveling is suitable for excavating ground that is higher than the machine bottom.

Install the bucket in the reverse position before operating. For the procedure for installing the bucket in the reverse position, Refer to Section "13-24. Reversing the bucket without the quick coupler".

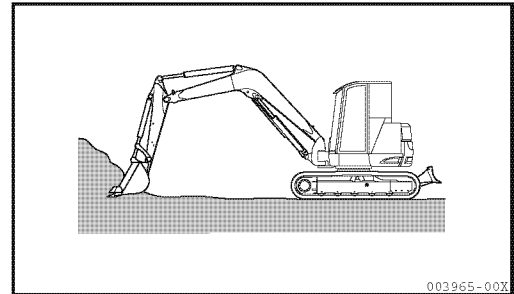

13-13-3. Ditching

To increase work efficiency, install a suitable bucket for ditching and position the tracks in parallel with the ditch to be made.

To make a wide ditch, first dig the two sides, and then dig the center.

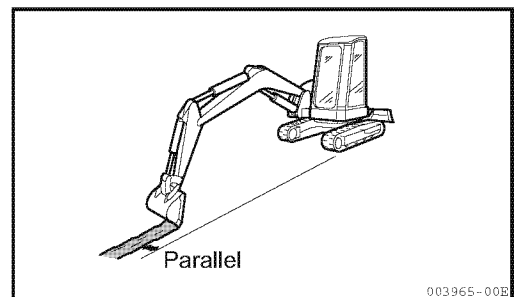

13-13-4. Loading

To increase work efficiency, locate the dump truck at a position where the swing angle of the machine will be minimized and the operator can clearly view the dump truck.

Load earth from the rear of the dump truck, because it can be loaded more easily and in larger amounts than from the side.

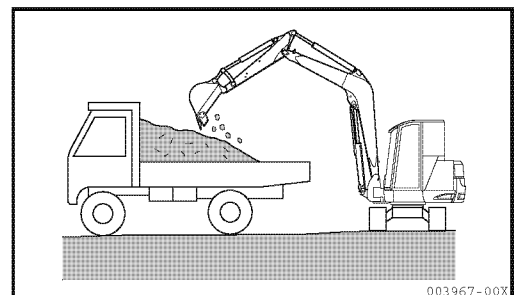

13-14. Handling quick coupler

13-14-1. Features of quick coupler

The quick coupler is the device to simplify the replacement of a variety of attachments for hydraulic implement. The distance between pins is adjustable so that the attachments with different distances between pins are available.

13-14-2. Description of switches

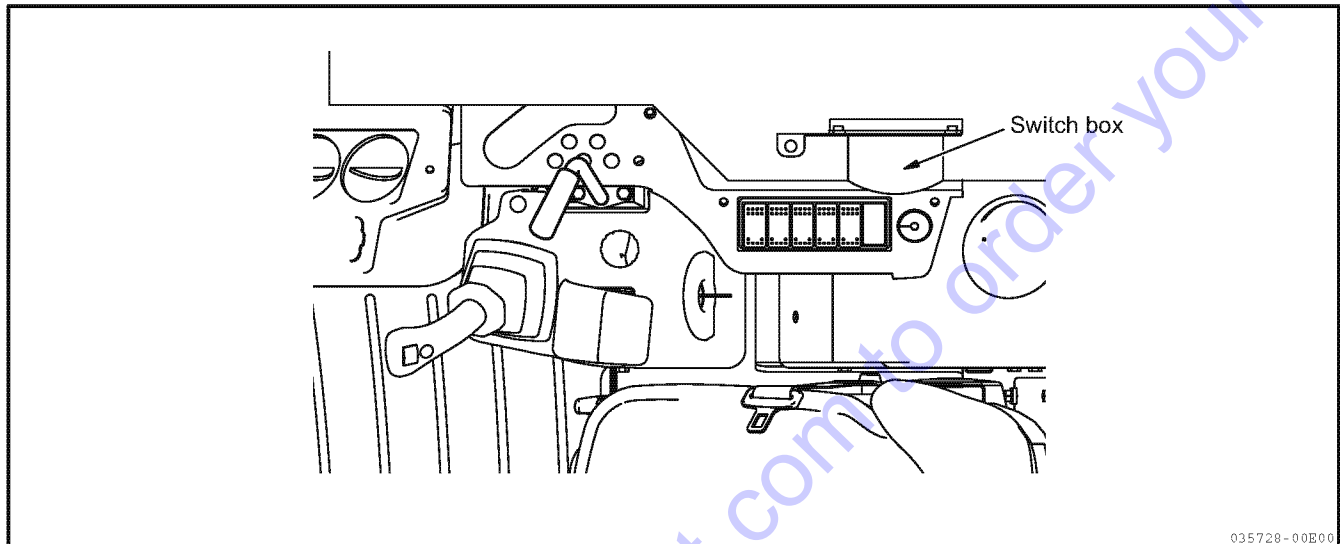

035728-00E00

⚠ WARNING

Never open the Switch Box cover except when mounting or dismantling the Attachment to prevent accidental activation of the Quick Coupler. This may cause breakdown or sudden operation of the Attachment, causing serious accident.

1) Control switch of quick coupler

Use this switch to dismount or mount the attachment.

Operating control switch to dismount or mount the attachment	
Dismounting of attachment	Mounting of attachment
<p>(1) Press</p> <p>Power supply switch goes on, and beeps sound.</p> <p>(2) Turn to the left</p> <p>Lamp goes on.</p> <p>000483-00E</p>	<p>(1) Turn to the right</p> <p>(2) Press</p> <p>000484-00E</p>

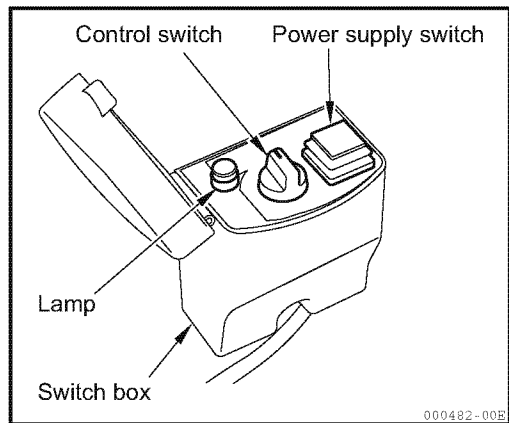

000482-00E

13-14-3. Structure of quick coupler

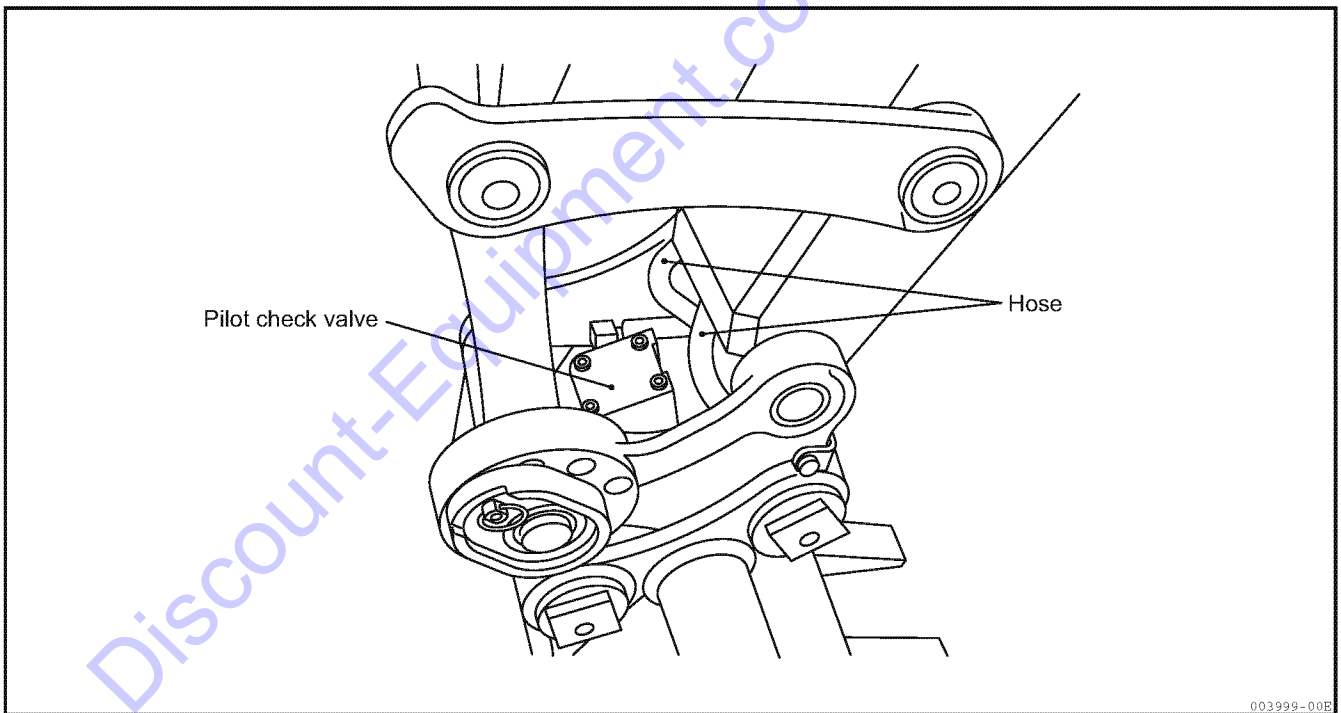
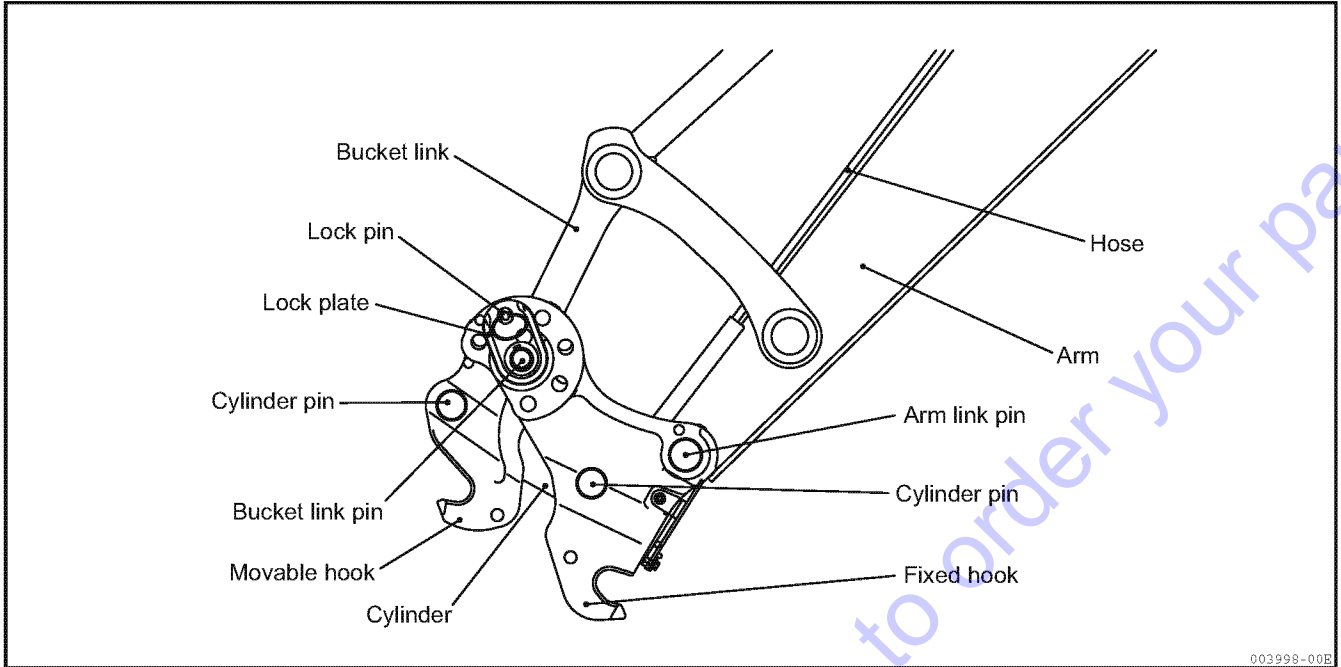

13-14-4. Attachment types

- 1) The attachments, which can be mounted on the machine with quick coupler, are only the same 2-pin type as the bucket. The 1-pin type such as clamshell cannot be mounted in the quick coupler.
- 2) The following 2-pin type of attachments exceptionally cannot be mounted in the quick coupler.
 - (1) Attachments much different from the standard bucket in shape of mounting part
 - (2) Attachments with excessively long or short pin pitch
- 3) Do not use any attachments improper for the machine with the quick coupler.

13-14-5. Allowable size of bucket

Allowable size of bucket to be mounted in the quick coupler

Unit : in. (mm)

Mark	Part	ViO80	
A	Attachment width	7.09 (180) or more	
B	Distance between pins	Pin diameter Ø1.77 (45)	10.8 to 15.7 (275 to 400)
		Pin diameter Ø1.97 (50)	10.9 to 16.5 (278 to 419)
C	Operating radius of bucket	43.7 (1110) or less	
D	Pin diameter	Ø1.77 to 1.97 (45 to 50)	

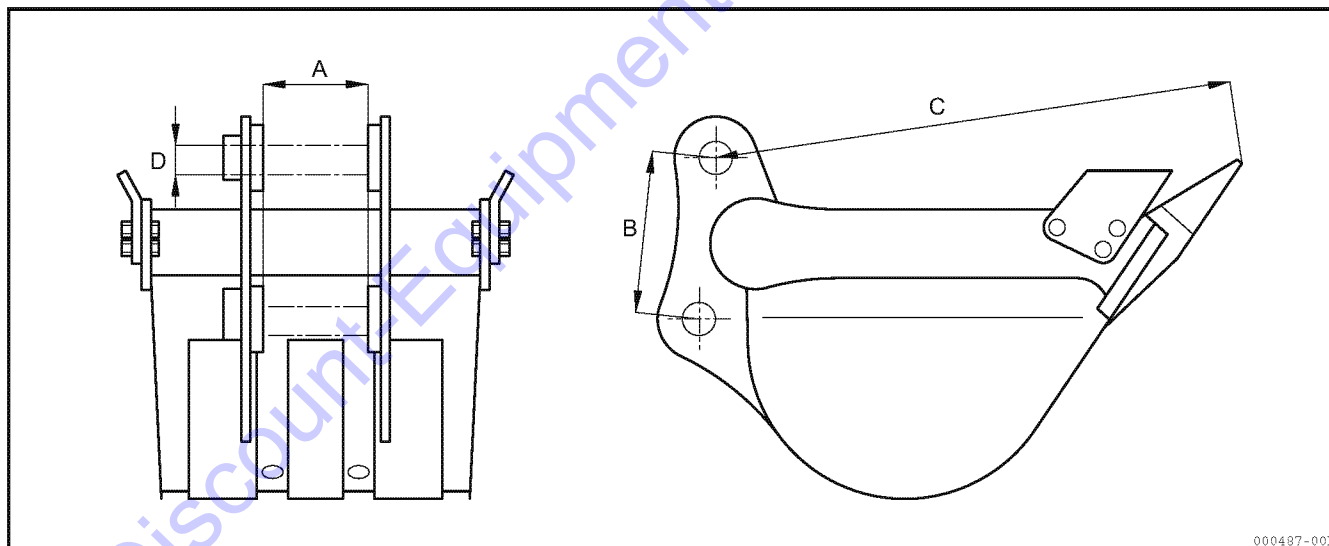

000487-00X

13-14-6. Phenomena that are not breakdowns

While setting the control switch of the quick coupler in the dismounting mode, stop the engine and then restart it to open the hook of the quick coupler.

13-14-7. Posture for storing the machine without attachment

Place the quick coupler on the ground as illustrated in the right figure for a long-term storage.

If the quick coupler is placed on the ground when the control switch is in the dismounting mode, the hook will open when the engine is restarted, causing the floor surface scratches or the machine breakdown.

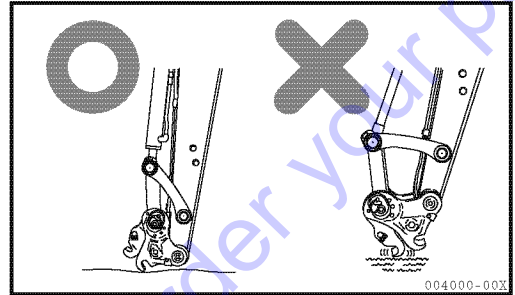

Go to Discount-Equipment.com to order your parts

13-14-8. Dismounting attachment

⚠ WARNING

- Never dismount the Attachment while it is still elevated, as it will drop to the ground and could cause bodily injury.
- Never dismount the Attachment unless it is resting on stable level ground, as it could otherwise fall over.

1) Park the machine on stable level ground.

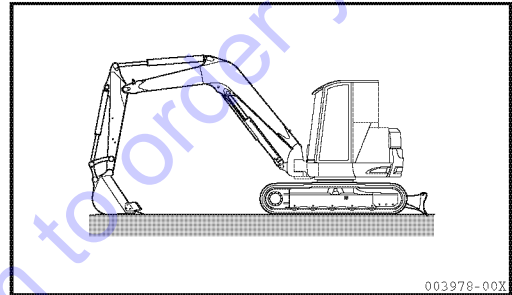

2) Lower the attachment onto the ground.

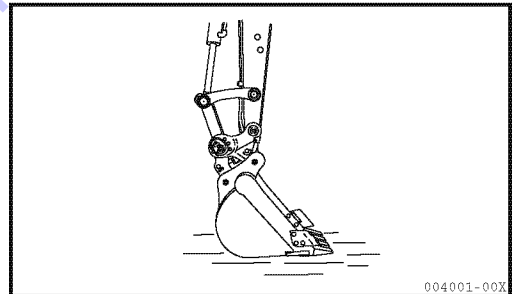

3) Set up the handle of the lock pin.

4) Turn the arrow on the head of the lock pin from the lock position to the unlock position, and then pull it up.

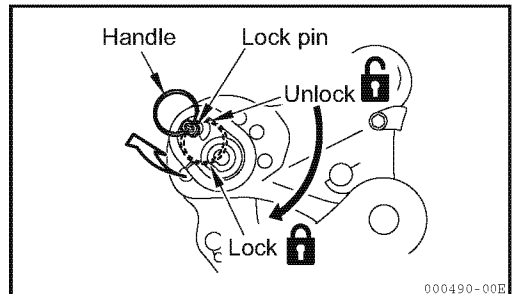

IMPORTANT

The lock pin cannot be removed from the body.

13. Operating Instructions

5) Open the switch box cover.

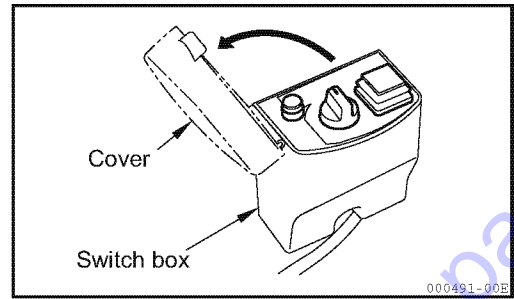

6) Press the power supply switch.
Then, beeps sound and the power supply switch blinks.

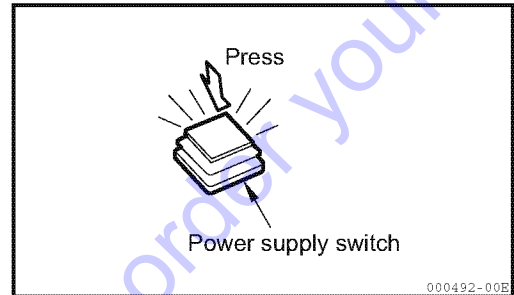

7) Turn the control switch to the dismantling position on the left side, and the attachment is dismantled.

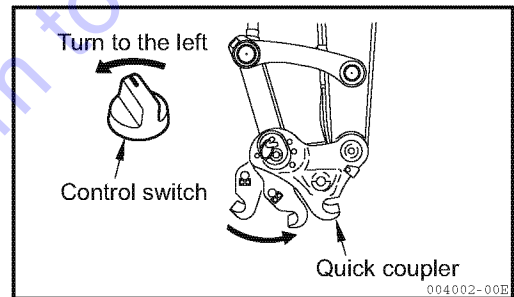

8) Remove the quick coupler from the attachment.

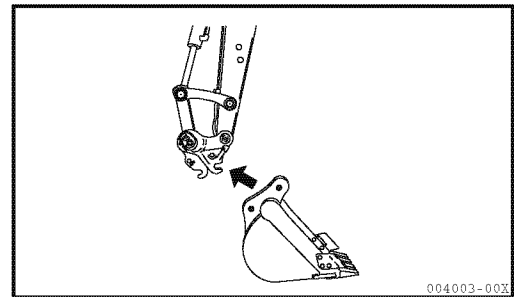

13-14-9. Mounting attachment

⚠ WARNING

- Never place your hands or any other part of your body between the Quick Coupler and the Attachment to prevent bodily injury.
- Never stand near the Attachment unless it is resting on stable level ground to avoid bodily injury.
- Never use a newly mounted Attachment before confirming that it has been properly secured to the Quick Coupler, and that the Lock Pin has been correctly installed, as accidental detachment could otherwise result.
- Always replace the Lock Pin if damaged or lost. Failure to do so could result in death or serious injury.

- 1) Place the attachment on stable level ground.
Be sure to install the pins into the attachment.

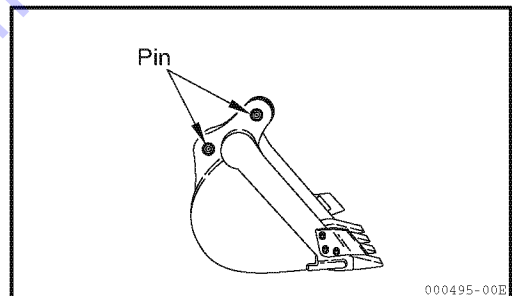

- 2) Close the movable hook.
- 3) Put the fixed hook onto the pin of the attachment on the arm side and set the quick hitch level with the ground as illustrated in the right figure.

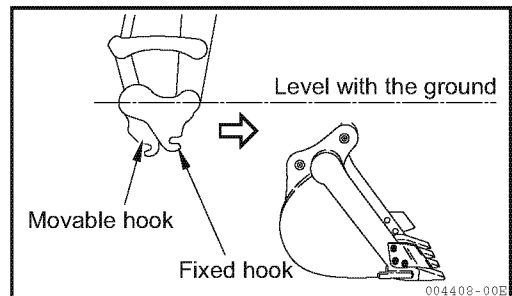

- 4) Lift the attachment up in that state.

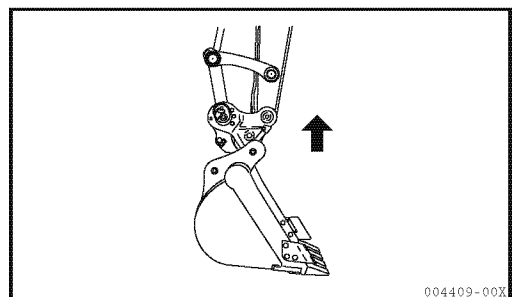

13. Operating Instructions

5) Curl the attachment so that it is level.

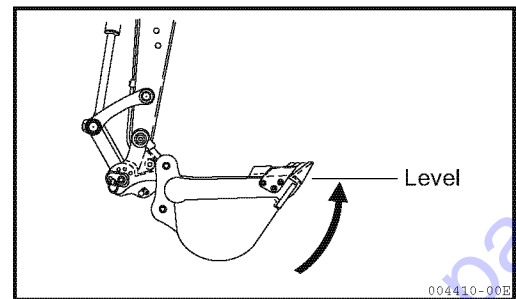

6) Turn the control switch to the mounting position on the right side, and the attachment is mounted.

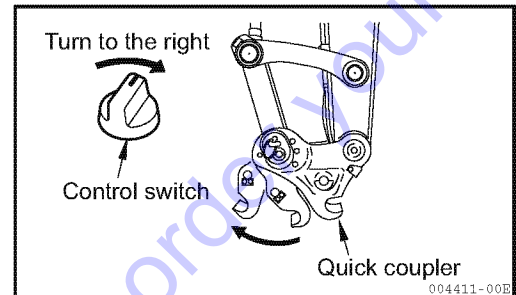

7) Only one of the bores allows the whole lock pin. Install the lock pin to that bore.

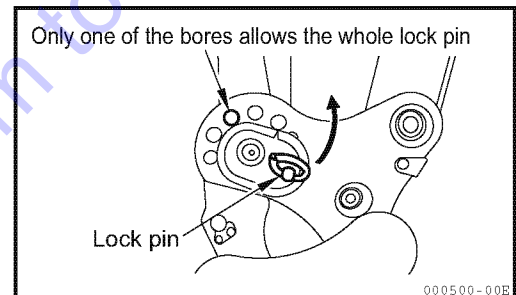

8) Turn the arrow on the lock pin to the lock side.

9) Put the handle of the lock pin down to the arrowed side.

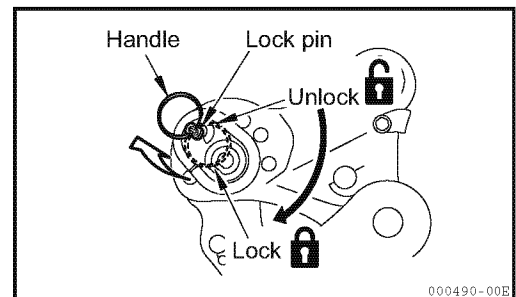

10) Make sure the attachment is securely mounted in the quick coupler before pressing the power supply switch on. The beeps stop sounding and the red lamp goes off.

11) Close the switch box cover.

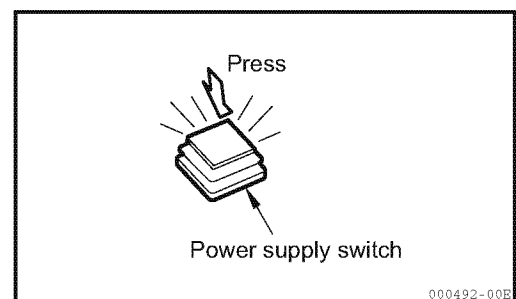

13-14-10. Maintenance

1) Checking specifications

- Check there are no cracks and plays.
- Check the bolts and nuts for looseness.
- Check the hydraulic piping for oil leak.

2) Installation instruction of the Lock Pin

- (1) Remove the damaged lock pin if any, and clean the bore of the lock plate.

Note :

Replace the lock plate with a new one if it is damaged.

- (2) Put a new lock pin into the bore of the lock plate.

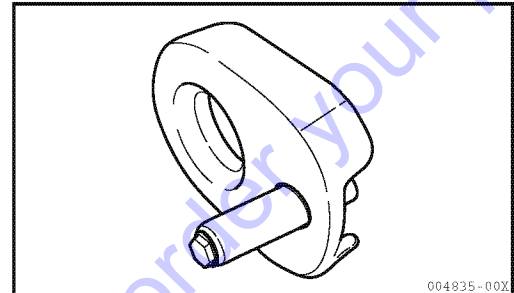

- (3) Install the washer and nut onto the lock pin from the back side of the lock plate.

Note :

Apply a lock agent Three Bond 1324 on the thread.

- (4) Tighten the nut (M10, Hex 14 mm) to 33 to 43 ft•lb.

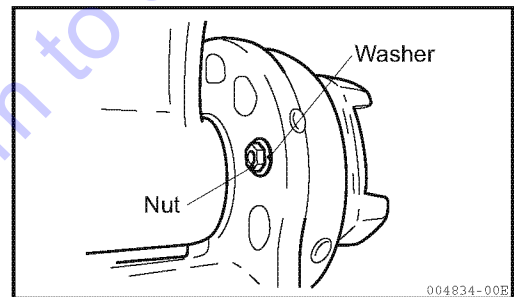

- (5) Confirm if the new lock pin can smoothly move to the lock and unlock positions.

3) Greasing

IMPORTANT

Grease the fittings thoroughly after washing the machine or after operation in rain, on soft ground, or in muddy water.

- (1) Put the bucket and the blade on the ground and stop the engine.
- (2) Clean the grease nipples indicated with the arrows in the right figures and grease them using a grease gun.
- (3) After greasing, wipe off the excessive grease with waste cloth or the like.

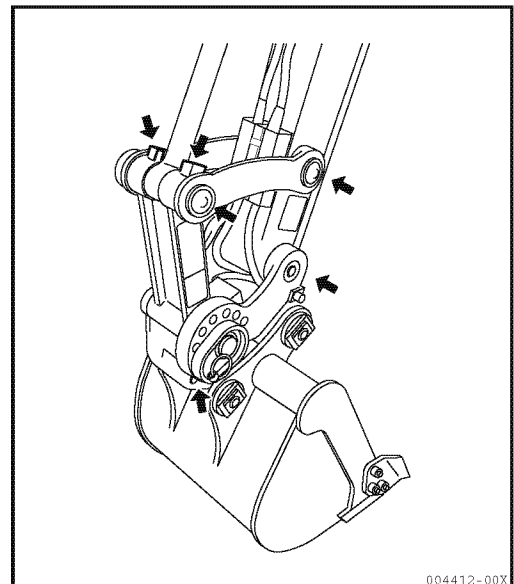

13. Operating Instructions

4) Nonperiodic inspection

- The pins in the attachment are free from rotation and cannot be worn.
Apply antirust solvent or grease to them to prevent rust.

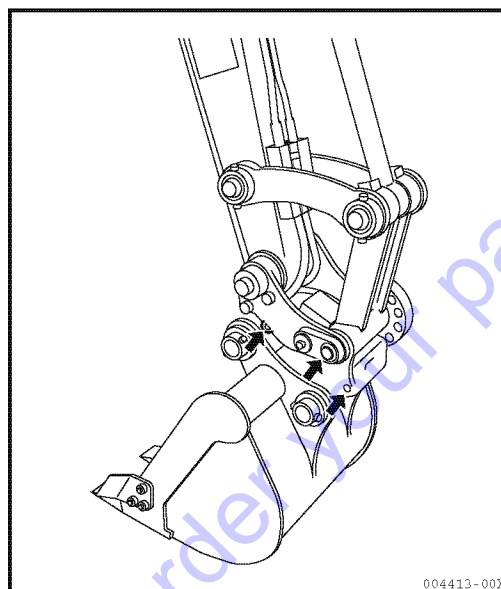

Go to Discount-Equipment.com to order your parts

13-15. Parking the machine

⚠ CAUTION

Do not stop the machine suddenly, but try to stop with a safety margin.

⚠ WARNING

- Park on solid, level ground.
- Do not park on a slope. If it is unavoidable to park on a slope, place solid blocks of wood behind the crawlers, place the blade on the ground, and dig the bucket into the ground.

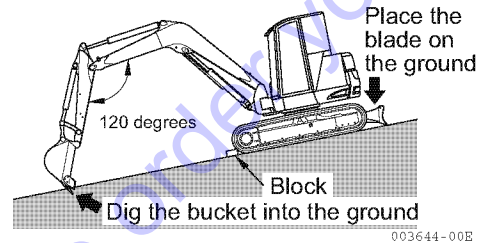

⚠ WARNING

- Do not touch the control levers and pedals accidentally. Otherwise, the implement or the machine may move unexpectedly, causing a serious accident.
- When leaving the operator's seat, be sure to place the lock lever securely in the lock position and remove the starter switch key.

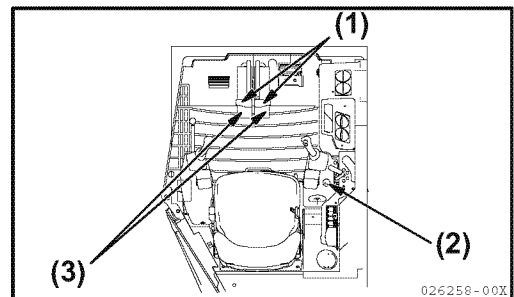

1) Set the left and right travel levers (1) or pedals (3) to the neutral position to stop the machine.

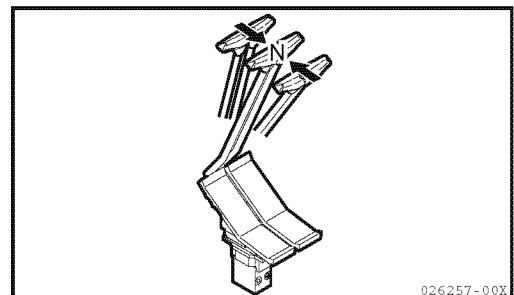

2) Turn the engine control dial (2) to the IDLING direction.

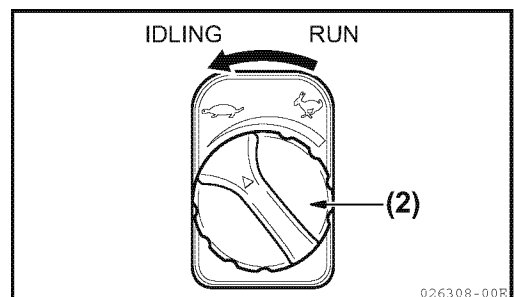

13. Operating Instructions

3) Place the bucket on the ground with its bottom surface in contact with the ground.

4) Place the blade on the ground.

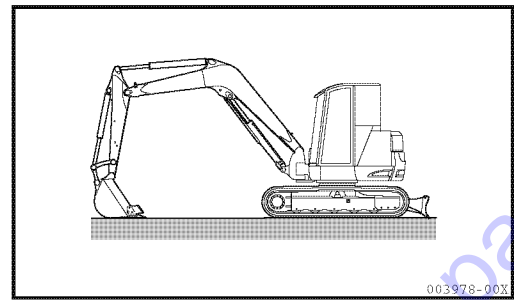

5) Set the lock lever to the "LOCK" position.

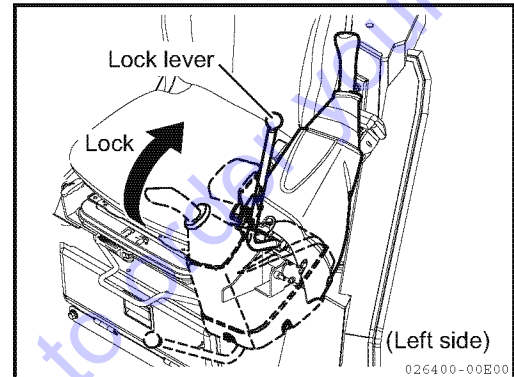

13-16. Inspection requirements after completing operation

Check the monitor for the engine cooling water temperature (1), the engine oil pressure (2), and the residual quantity of fuel (3). Take any actions necessary.

Trouble monitor lamp (4)

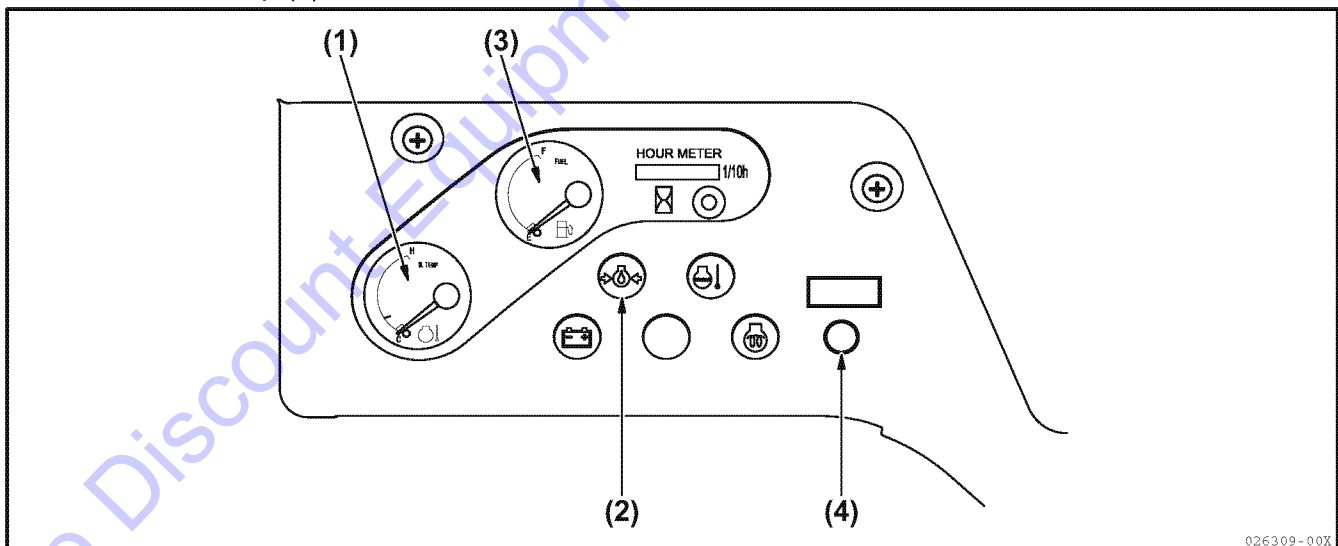

13-17. Stopping the engine

IMPORTANT

- Stopping the engine after rotation at high speed may shorten the engine life. Do not stop the engine suddenly except in case of emergency.
- If the engine is overheated, do not stop the engine immediately. Gradually lower the engine temperature by rotating the engine at medium rotational speed before stopping the engine.

- 1) Idle the engine for approximately five minutes with no load.
(The engine temperature gradually lowers.)

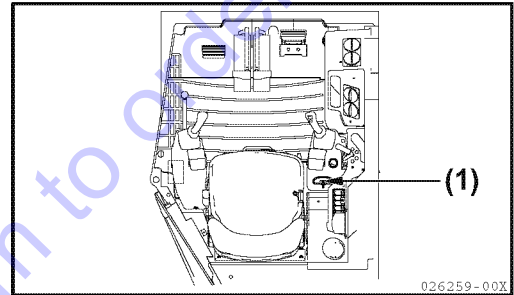

- 2) To stop the engine, turn the starter switch key (1) to the "OFF" position.
- 3) Take the starter switch key out of the starter switch (1).

Note :

The swing motor brake will engage automatically when the engine stops.

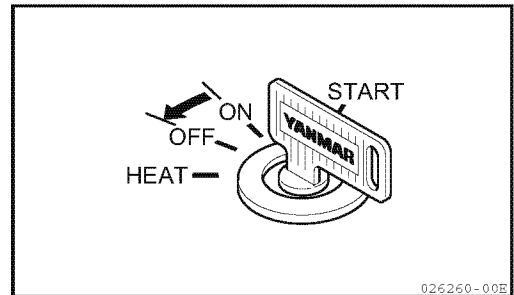

13-18. Inspection requirements after stopping the engine

- 1) Check oil and water for leaks, and visually inspect the implement, the machine, and the undercarriage by walking around them.
If there are any leaks of oil or water, or any observed abnormality, take corrective action.
- 2) Completely fill the fuel oil tank.
- 3) Confirm that the engine compartment is free of any foreign matter.
Combustibles or dust in the engine compartment may cause a fire. Remove them, if any.
- 4) Remove mud adhering to the undercarriage of the machine.

13-19. Locking

Make sure that you lock the following parts :

- (1) Engine hood

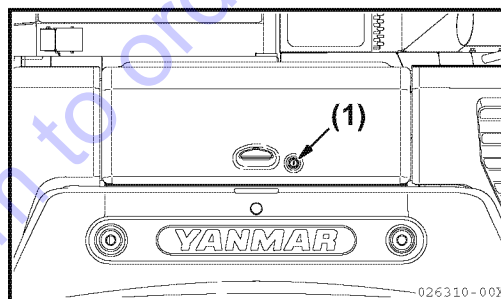

- (2) Bonnet B

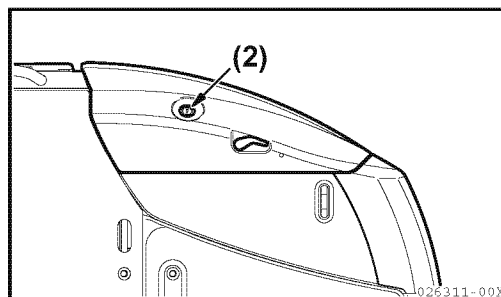

- (3) Side door (for cabin)

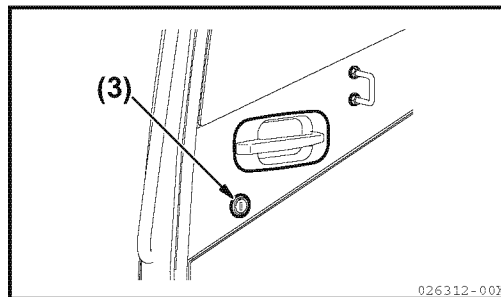

- (4) Inspection cover

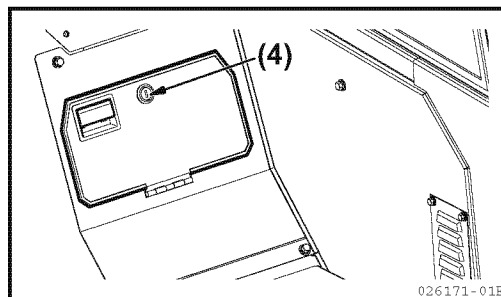

Note :

The starter switch key is used to lock all of the items mentioned above.

13-20. Handling the rubber crawlers

13-20-1. Using the rubber crawlers properly

Rubber crawlers have some advantages over steel crawlers.

However, you cannot take full advantage of them if you use them in the same manner as steel ones. Use care in operating with rubber crawlers in accord with the conditions of the work site and the type of work.

Comparison Table of Rubber and Steel Crawlers

	Rubber	Steel
Low vibration	◇	□
Smooth travel	◇	○
Silent travel	◇	□
Less damage to paved roads	◇	□
Simple handling	◇	□
Susceptibility to damage (strength)	□	◇
Tractive force	◇	◇

◇ : Excellent

○ : Good

□ : Ordinary

Rubber crawlers have many advantages inherent in the unique properties of the material. On the other hand, however, they are low in strength. It is essential that you fully understand the properties of rubber crawlers, and observe the precautions for operating and handling them to prolong their life and get the most out of them. Be sure to read Section "13-20-3. Precautions for using the rubber crawlers" before using them.

13-20-2. Warranty for rubber crawlers

The rubber crawlers are not warranted for free repair or replacement if they are damaged because of misuse by the customer, including the failure to comply with the prohibitions and the instructions for safe operation; (for example, the failure to check the tension of the rubber crawlers or service the rubber crawlers properly, or "using the rubber crawlers on surfaces and terrains which could physically damage them".)

13-20-3. Precautions for using the rubber crawlers

■ Prohibitions

Observe the following prohibitions:

- Do not operate or turn on surfaces or terrains that have sharp stones, a hard, uneven rock base, or that expose the crawlers to steel rods, scrap iron, or edges of iron plates. Failure to observe these prohibitions may damage the rubber crawlers.
- Do not operate the machine on a stony surface like a riverbed. Doing this may damage the rubber crawlers by catching gravel in the crawlers or may cause the crawlers to come off. Forcibly pushing obstacles will also shorten the life of the rubber crawlers.
- Prevent the rubber from getting exposed to oil, fuel, or chemical solvents. If they are exposed, immediately wipe them. Also, do not travel on roads which have oily surfaces.
- When storing the rubber crawlers for a long time period (more than three months), avoid placing them in a place subject to direct exposure to sunlight or rain.
- Do not operate the machine when the crawlers will be exposed to heat. (i.e., near an open-air fire, on a steel plate that has been exposed to the blazing sun, or on a hot asphalt road.)
- Never run on one rubber crawler track while the other is held above the ground with the implement. Doing this may damage the rubber crawler or cause it to come off.

13-20-4. Other precautions for using the rubber crawlers

Observe the following precautions when operating the machine:

- Never spin-turn on concrete or asphalt roads.
- Do not change course suddenly. Doing this will cause the rubber track to wear early or be damaged.
- Do not turn the machine across a large level gap while traveling. Remember that running over a level gap at a right angle will prevent the crawler from coming off.
- Slowly lower the machine after it has been lifted above the ground with the implement.
- It is not recommended that the machine be used to handle any materials that become oily after being crushed (e.g., soybeans, corn, rapeseed oil seeds, etc.). After unavoidably using the machine to handle such materials, clean the crawlers with water.
- It is not recommended that the machine be used to handle materials such as salt, ammonium sulfate, potassium chloride, potassium sulfate, or superbiphosphate of lime. Handling these materials may affect the core metal adversely. After using the machine to handle such materials, clean the crawlers with water.
- Do not operate the machine at the seashore. Doing this may affect the core metal adversely due to the salt content.
- If a rubber crawler is cracked, it could be easily damaged when exposed to salt, sugar, wheat, or soybeans. Be sure to repair any cracks in the rubber crawler to prevent rubber chips from getting into the materials being handled.
- Do not allow the rubber crawler to rub against a concrete wall.
- The rubber crawlers are prone to slipping on snow or on a frozen road. Be careful of skidding when traveling or operating on a slope in cold weather.
- Operating the machine in extremely cold weather will deteriorate the rubber crawlers, shortening their life.
- Use the rubber crawlers between -13°F to +131°F (-25°C to +55°C) because of the physical characteristics of rubber.
- Be careful not to damage the rubber crawlers with the bucket while operating the machine.

13. Operating Instructions

- Keep the crawlers in appropriate tension to prevent them from coming off.
If the tension is too low, the rubber crawlers may come off under the following conditions.
(Even if the tension is adequate, take care when operating the crawlers under these conditions.)

- Do not steer the machine at an angle other than 90 degrees across a large level gap created by a curbstone or a rock [approximately more than 8 in. (20 cm)]. Run over a level gap at a right angle only to prevent the crawlers from coming off.

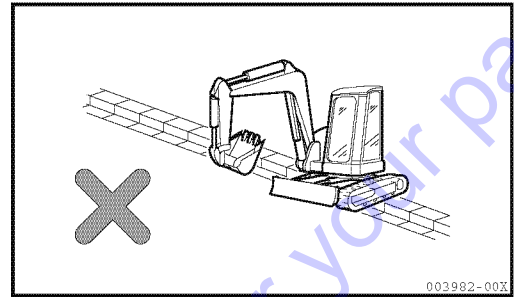

- Do not steer the machine across a boundary between the flat ground and a slope, while moving backwards. If such travel is not avoidable, slow down the speed.

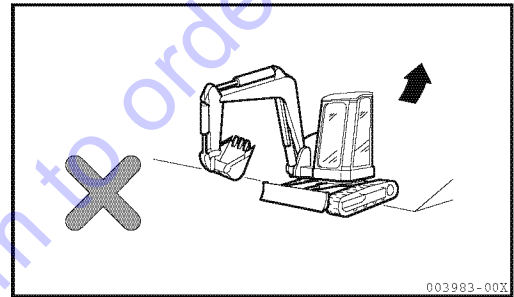

- Do not travel with the crawler on one side on a slope or on convex ground (causing a machine angle of more than 10 degrees), and with the crawler on the other side on flat ground, to prevent the rubber crawler from being damaged. Be sure to travel with the crawlers on both sides on the same level surface.

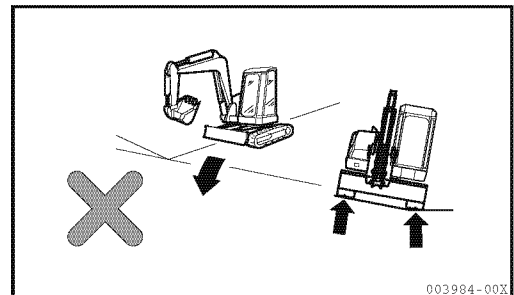

- The three cases illustrated above are those which could cause the rubber crawlers to loosen. In addition, do not subject the machine to such ground conditions as are illustrated in the figure on the right.

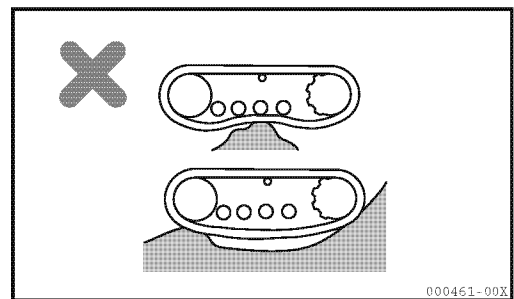

[How the rubber crawlers come off]

- 1) When running over a level gap, a clearance is created between the crawlers and the track rollers. At this point, the crawlers tend to come off.

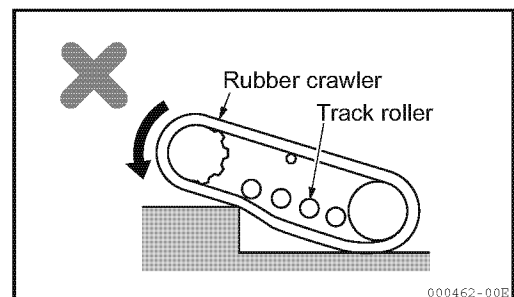

2) If the machine is traveling in reverse, clearance may also be created between the track rollers and the rubber crawlers, and between the idlers and the rubber crawlers, causing the rubber crawlers to come off.

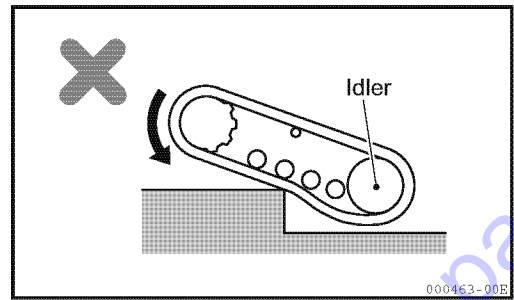

3) Other situations to be avoided.

- When the machine changes the travel direction while the rubber crawlers are blocked sideways by an obstacle or the like.

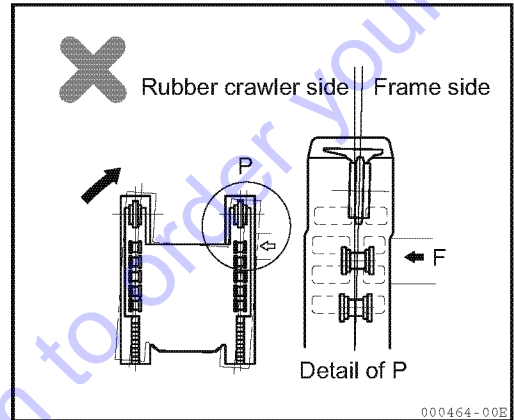

- When the idler and the track rollers are misaligned from the core metal, due to rubber crawler misalignment.

- Traveling in reverse under the condition illustrated will cause the rubber crawlers to come off.

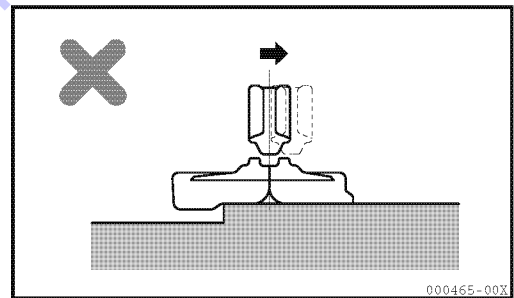

- Changing the travel direction of the machine under the condition illustrated will cause the rubber crawlers to come off.

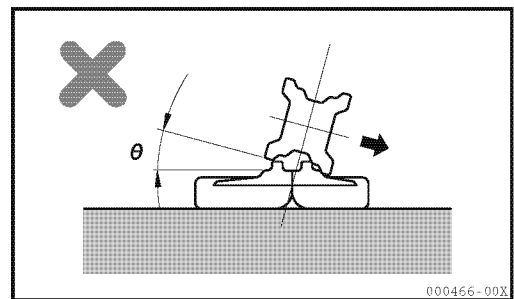

13-20-5. Checking and servicing the machine with rubber crawlers

To check and service the machine with rubber crawlers, refer to and follow Section "24-1. Table of service time intervals".

13-21. Handling hydraulic P.T.O.

13-21-1. Description of stop valve, P.T.O. selector valve, P.T.O. switch

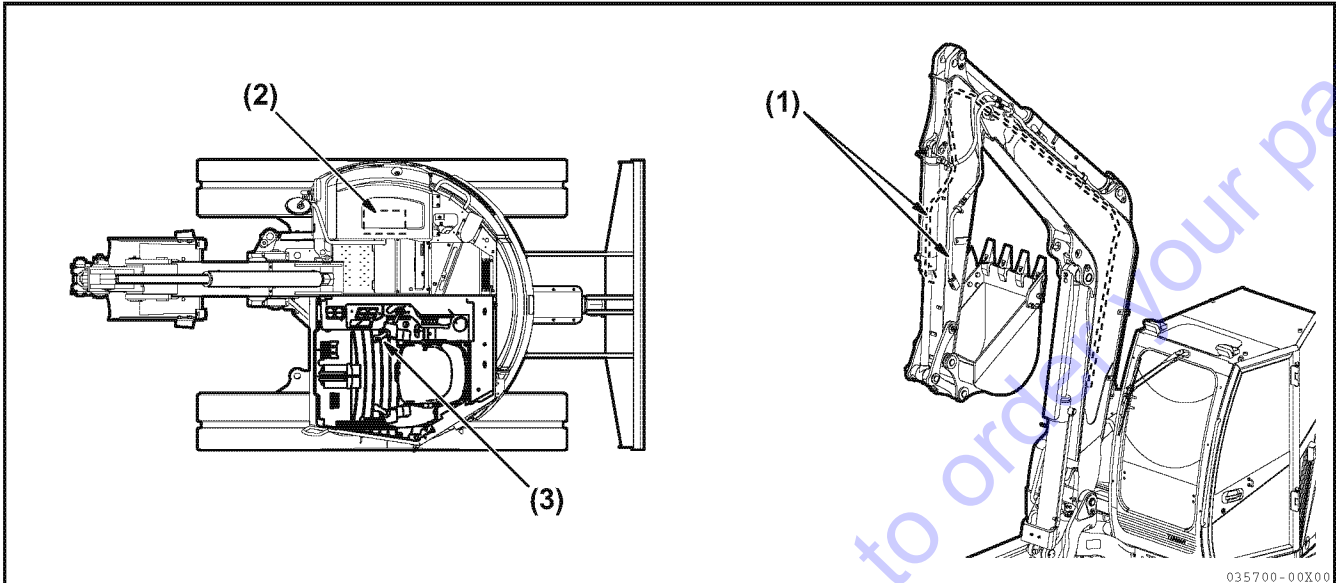

(1) Stop valve

This valve stops the flow of hydraulic oil.

(A) Open : The hydraulic oil flows

(B) Close: The hydraulic oil stops.

Set this valve at the closed position when removing and installing an attachment.

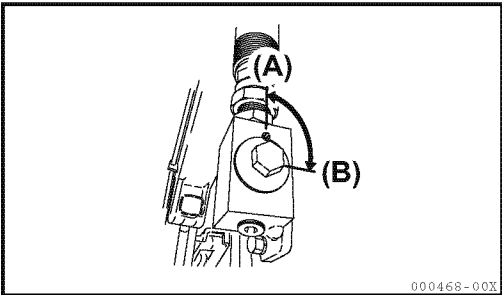

(2) P.T.O. selector valve

Use this valve to select either single acting or double acting power take off.

1) Open the bonnet B.

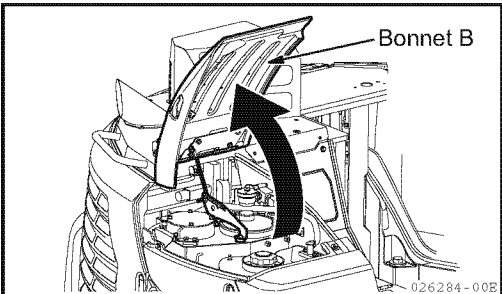

2) Turn the lever of the selector valve and select either single acting type or double acting type.

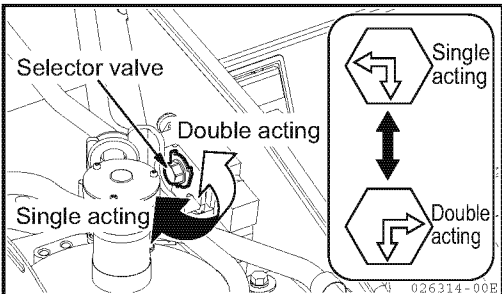

(3) P.T.O. switch

Use this switch to operate the attachment.

- Move the P.T.O. switch to L side for operating the single acting actuator type of attachments, when the P.T.O. selector valve is in the single acting position.

[Example : Breaker]

- Move the P.T.O. switch to L or R side for operating the double acting actuator type of attachments, when the P.T.O. selector valve is in the double acting position.

[Examples : Tilt bucket, Clamshell, etc.]

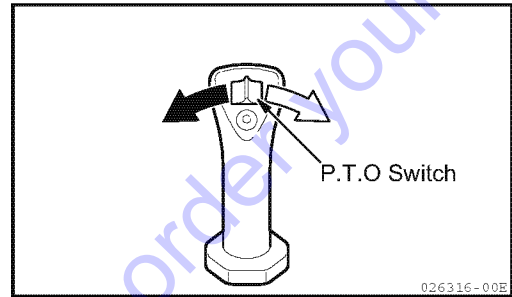
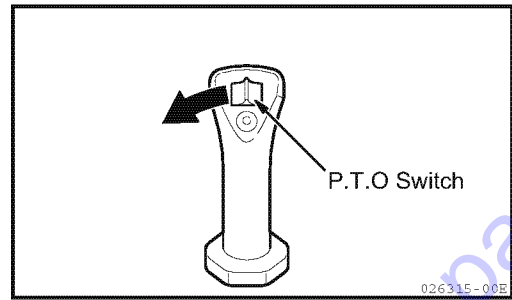

Go to Discount-Equipment.com to order your parts

13. Operating Instructions

13-21-2. Hydraulic circuit

When mounting any attachment, follow the procedure below to connect the circuit.

1) Depressurization of P.T.O. piping

- (1) Turn the starter switch to the "ON" position (the engine cannot be started) after stopping the engine.
- (2) Release (depress) the lock lever.
- (3) Move the P.T.O. switch right and left alternately for a few times.

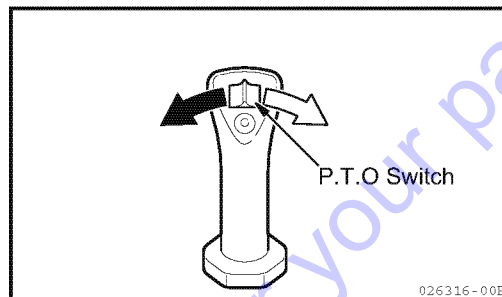

2) Connecting the hydraulic circuit

- (1) Make sure the stop valves are in the closed position and remove the screw plugs. Take care not to lose or damage the removed parts.
- (2) Install the connectors supplied by the manufacturer of the attachment and connect the hoses.

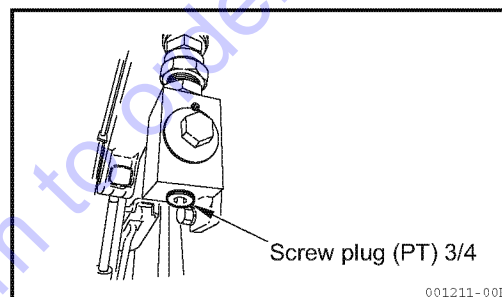

■ Oil flow system

The directions of switch operation and of the oil flow system are indicated in the figure below.

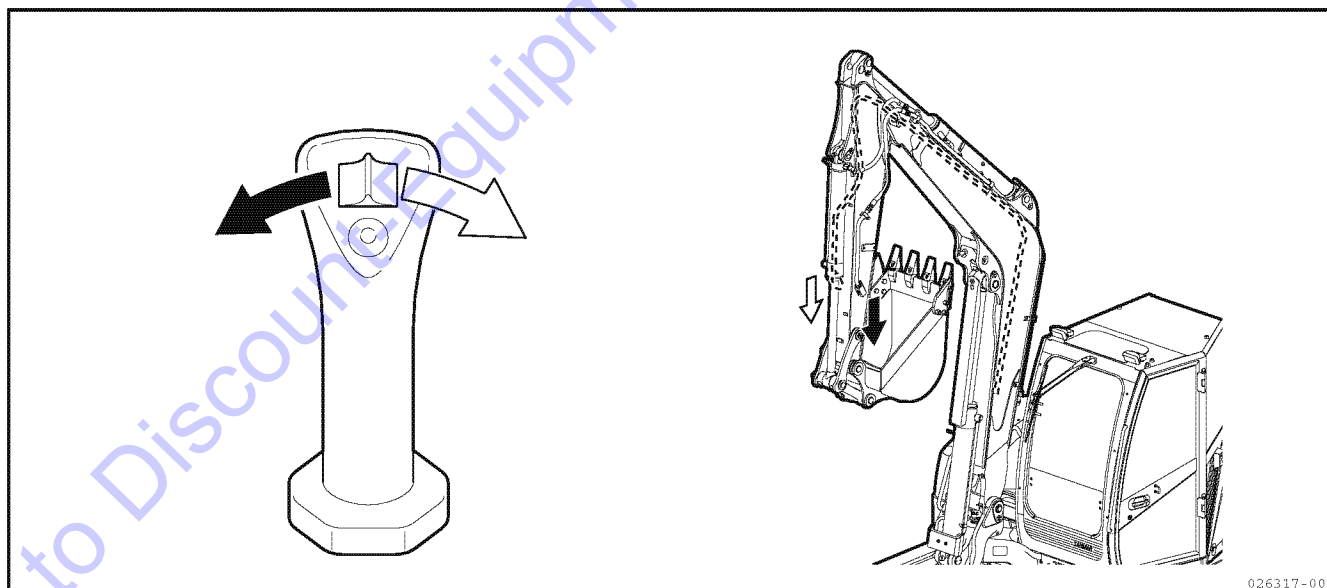

13-21-3. Operating attachment

Operate the attachment as follows:

■ Precautions

- Make sure the stop valves are in the open position.
Refer to Section "13-21-2. Hydraulic circuit" for oil flow system.

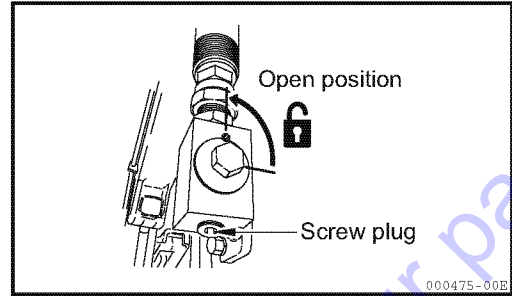

1) When using the breaker:

The breaker operates when the P.T.O. switch is moved to the left.

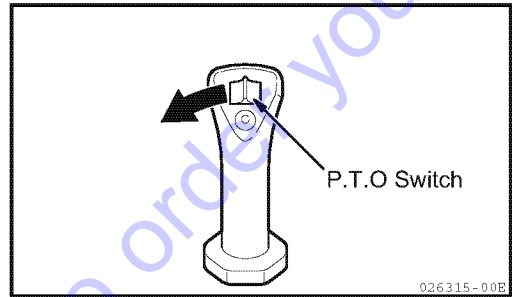

- Make sure the P.T.O. selector valve is in the single acting position.
Refer to Section 13-21-1. Description of stop valve, P.T.O. selector valve, P.T.O. switch.

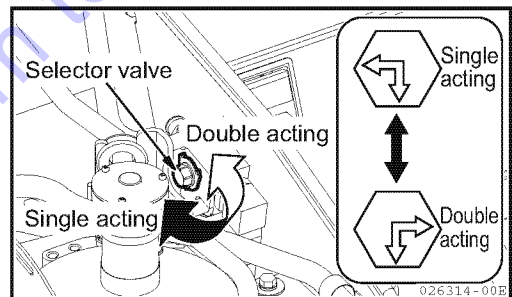

- Always use the breaker in accordance with the handling instructions in the operation manual provided by the manufacturer of the breaker.

2) When using general attachments such as a tilt bucket :
Move the P.T.O. switch to the right or the left, and the attachment will operate.

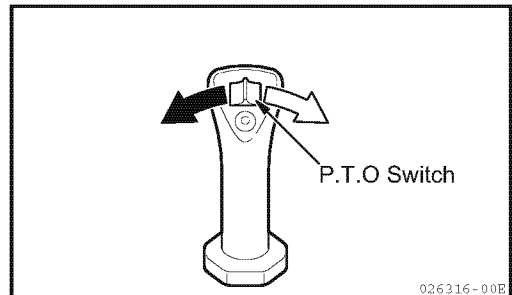

■ Precautions

- Make sure the P.T.O. selector valve is in the double acting position.
Refer to Section "13-21-1. Description of stop valve, P.T.O. selector valve, P.T.O. switch".

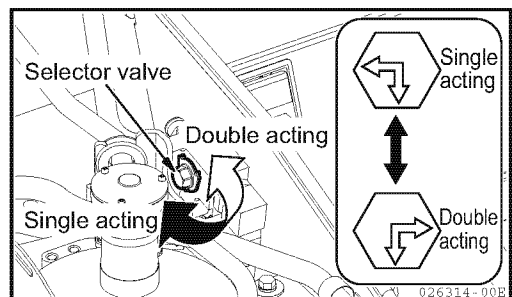

- Always use the general attachments in accordance with the handling instructions in the operation manuals provided by the manufacturers of the general attachments.

13. Operating Instructions

13-21-4. Long-term storage

If a hydraulic tool will not be connected, do the following:

- Close the stop valves.
- Disconnect the hoses for the hydraulic tool. Wrap the screw plugs with seal tape and affix them to the stop valves.

Operating the P.T.O. switch when no attachment is mounted may cause system overheating.

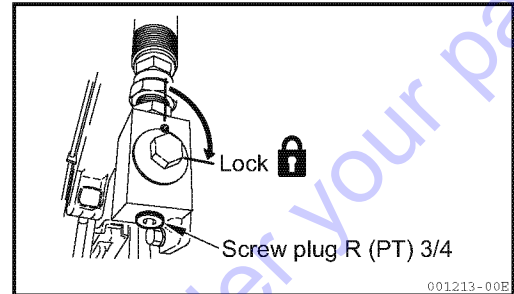

13-21-5. Specification

- Oil flow rate (Combined flow of P2 and P3 pump)
: 31.7 GPM (120 L / min.)

Go to Discount-Equipment.com to order your parts

13-22. Releasing the internal pressure of the hydraulic circuit by accumulator**■ Function of accumulator**

The accumulator (1) accumulates the pressure of the operating circuit. As the operating circuit is activated for awhile even after stopping the engine, the following can be done:

- By moving the control levers to the direction of lowering the implement, it can go down on the ground with its self-weight.
- The pressure of the hydraulic circuit can be released.

Note:

The function can be used when the starter switch is "ON" and the lock lever is in the "Unlock" position.

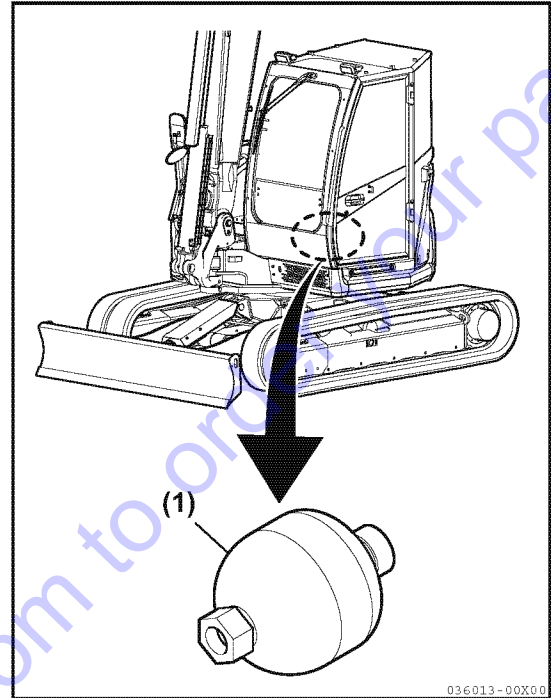

■ Releasing the internal pressure of the hydraulic circuit

IMPORTANT

The procedures from stopping the engine to moving the control levers and pedals back and forth and around at full stroke must be performed within 15 seconds in the following procedures.

As the accumulator pressure is gradually reduced after stopping the engine, the pressure can only be released right after stopping the engine.

- 1) Place the implement down on the ground and stop the engine.
- 2) Set the starter switch to the "ON" position.

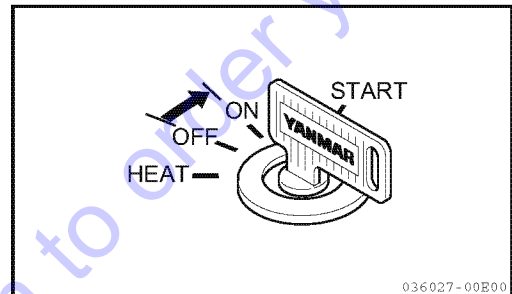

- 3) Set the lock lever (2) to the "Unlock" position and move the control levers and pedals back and forth and around at full stroke to relieve the pressure of the hydraulic circuit.

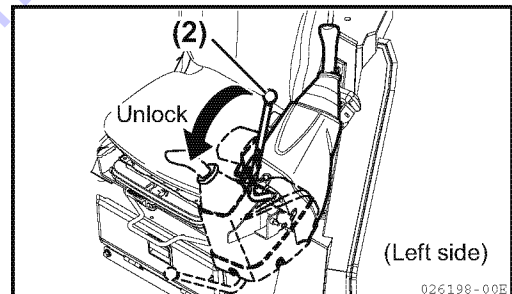

- 4) Set the lock lever (2) to the "LOCK" position to lock the control levers and pedals.

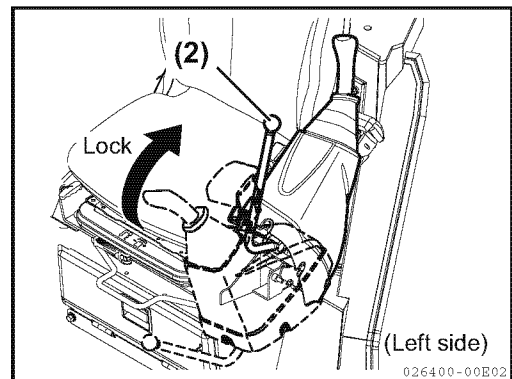

13-23. Replacing the bucket without the quick coupler

⚠ WARNING

- When driving pins into the bucket with a hammer, metal chips may fly. If metal chips should get into your eyes, they can cause serious injury. Use goggles, a hard hat, and gloves for safety when replacing the bucket.
- After removing the bucket, place it on solid ground in a stable position.
- When aligning the holes for pin A and pin B, be careful not to insert your fingers into those holes to prevent serious injury to your fingers. Visually check the alignment of the holes.

Work on level ground with good footing. If two or more persons work together, communicate with signals selected beforehand for safety.

■ Replacement procedure

Replace the bucket according to the following procedure:

- 1) Park the machine on level, flat ground, and lower the bucket onto the ground.
- 2) Stop the engine.
- 3) Clean around the bucket pin to prevent foreign material from entering the pin holes.
- 4) Remove pins A and B.

IMPORTANT

- Keep the pins away from dirt or mud.
- The machines have dust seals on either end of the bush. Be careful not to damage them.

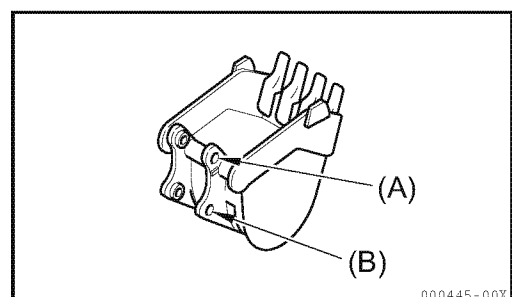
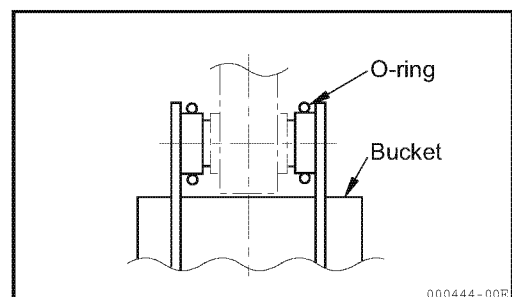
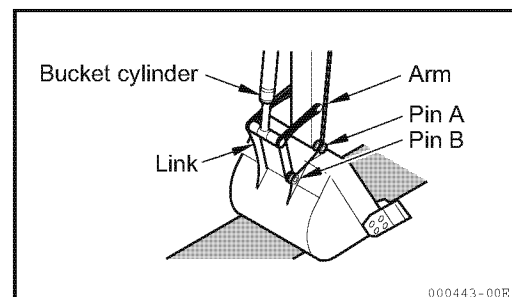

13. Operating Instructions

5) Clean the bucket boss section and mount the O-ring.

IMPORTANT

- Check that the O-ring is not damaged. If it is damaged, replace it with a new one.
- It is recommend that the O-ring should be replaced when replacing the bucket. (It extends the implement life.)

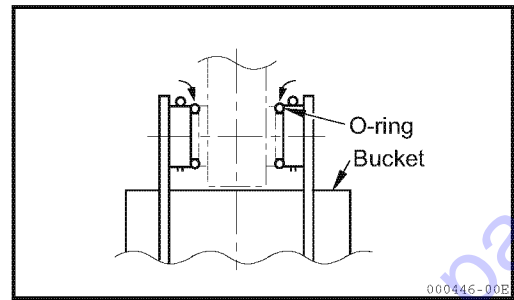

6) Connect the arm to (A), and then connect the link to (B).

7) Install the O-ring in position.

IMPORTANT

Before mounting the bucket, clean the arm pin hole and grease it.

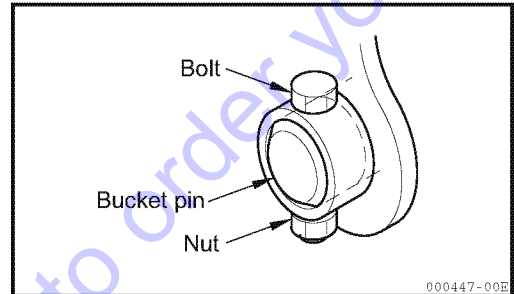

8) Install the collars and bolts into the bucket pins A and B.

9) Grease the connecting parts.

13-24. Reversing the bucket without the quick coupler

⚠ WARNING

- When driving pins into the bucket with a hammer, metal chips may fly. If metal chips should get into your eyes, they can cause serious injury. Use goggles, a hard hat and gloves for safety when reversing the bucket.
- After removing the bucket, place it stably on solid ground in a stable position.
- When aligning the holes for pin A and pin B, be careful not to insert your fingers into the holes to prevent serious injury to your fingers. Visually check the alignment of the holes.

Work on level ground with good footing. If two or more persons work together, communicate with signals selected beforehand for safety.

■ Reversing procedure

Reverse the bucket according to the following procedure:

- 1) Park the machine on level, flat ground, and lower the bucket onto the ground.

Note :

To remove the pins, place the bucket on the ground in such a way that it touches the ground lightly. Lowering the bucket down on the ground by its full weight will increase stresses on the pins and make the pins difficult to remove.

IMPORTANT

Keep the pins away from dirt or mud.

- 2) Stop the engine.
- 3) Clean the area around the bucket pins to prevent foreign material from entering the pin holes.
- 4) Remove pins A and B.
- 5) Reverse the bucket.
- 6) Refer to Section "13-23. Replacing the bucket without the quick coupler" for installation of the O-ring.
- 7) Connect the arm to hole (B), and then the link to hole (A). [You can easily align the hole of the link and hole (A) by lifting the bucket slightly.]
- 8) Install the split pin into the bucket pins A and B.
- 9) Grease the connecting parts.

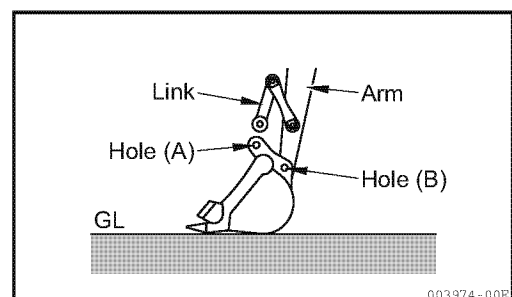
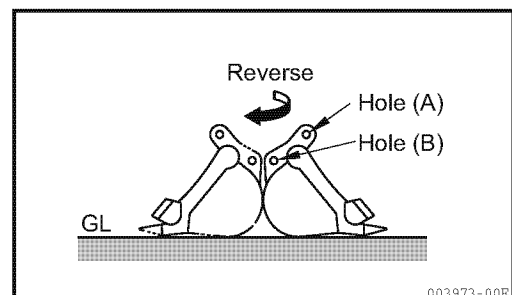
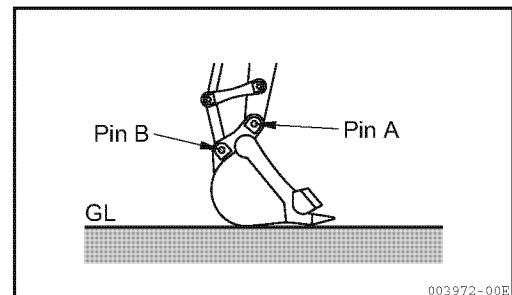

IMPORTANT

When using a reversed bucket, the bucket and the boom cylinder can contact each other when the arm is curled or the boom is lowered beyond the positions indicated in the figure on the right.

Never curl the bucket too much, and never allow it to contact the boom cylinder.

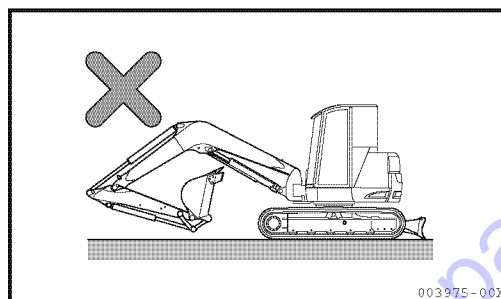

Go to Discount-Equipment.com to order your parts

14. Transportation

14-1. Loading and unloading the machine

For safety in transporting the machine, comply with all applicable regulations and laws.

WARNING

- **Be careful when loading and unloading the machine, because it is a job of high hazard potential.**
- **Load or unload the machine on level, solid ground far away from the shoulder of the road.**
- **Load or unload the machine at a low engine speed.**
- **Use ramp plates of adequate strength having hooks. Check to see that the ramp plates are wide, long, and thick enough to safely sustain the machine so that you can load or unload safely. To prevent the ramp plates from bending too much, support them with blocks.**
- **Securely hook the ramp plates to the deck of the truck so that they will not come off.**
- **Remove mud, grease, and other slippery deposits from the track shoes, and grease, oil, and ice deposits from the ramp plates to prevent the machine from skidding.**
- **Never change the travel direction on the ramp plates. If you need to change the travel direction, go back down the ramp plates.**
- **Swing slowly when on the truck bed, if it becomes necessary to do so, since the machine's position will be unstable.**
- **Make sure that the side door of the cabin is locked, either in the open or closed position. Never open or close the side door on the ramp plates, to prevent it from swinging violently.**

14. Transportation

To load or unload the machine, be sure to use the ramp plates and follow the procedures outlined below:

- 1) Firmly brake the truck and apply wheel stoppers to the tires. Securely install the ramp plates on the bed of the truck in a position where the center of the truck aligns with the center of the machine. Make sure that the left and right ramp plates are at the same level.

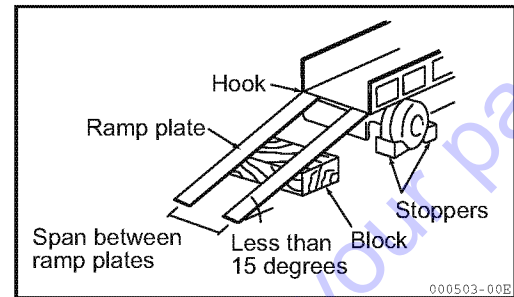

The ramp plates should be set at an angle of less than 15 degrees.

Determine the span between the ramp plates on the basis of the centers of the track shoes.

Make sure that the travel automatic dual speed switch is OFF.

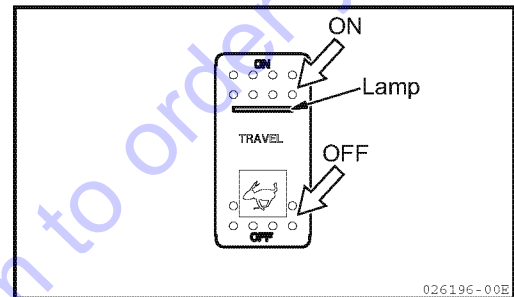

- 2) Return the engine control dial to reduce engine speed.
- 3) Travel toward the ramp plates at a low speed, and load or unload the machine with the implement lowered as close as possible to the deck of the truck. Do not operate any levers other than the travel levers while driving on the ramp plates.

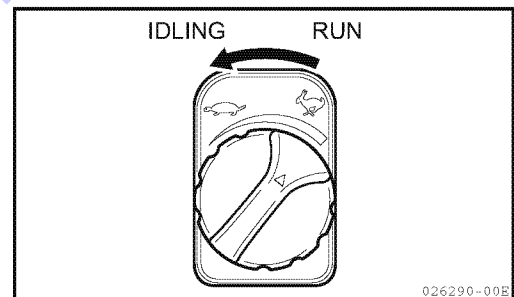

- 4) Load the machine in a safe position on the truck.

14-2. Precautions for loading the machine

⚠ WARNING

Load or unload the machine on level, solid ground far away from the shoulder of the road.

After loading the machine in a safe position on the truck, secure the machine as follows:

- 1) Place the blade down on the bed of the truck.
- 2) Extend the bucket and arm cylinders to the maximum limit, and slowly lower the boom down on a block of wood.
- 3) Stop the engine to take the starter switch key out of the starter switch.
(The automatic brake locks the swing motor.)
- 4) Be sure to lock the control levers with the lock lever.
- 5) Provide wood blocks in the front and back of the track and hook the shackles to the machine's hook bores, and secure the machine with a chain or a wire rope so that the machine will not move during shipping. In particular, be sure to secure it to prevent skidding.

IMPORTANT

- To protect the bucket cylinder from being damaged during shipping, place a wooden block under one end of the bucket to prevent it from directly touching the deck of the truck.
- Do not use the hook hole for the purpose other than stabilizing the machine during shipping. In particular, do not use the hook in the track frame section for lifting the machine.

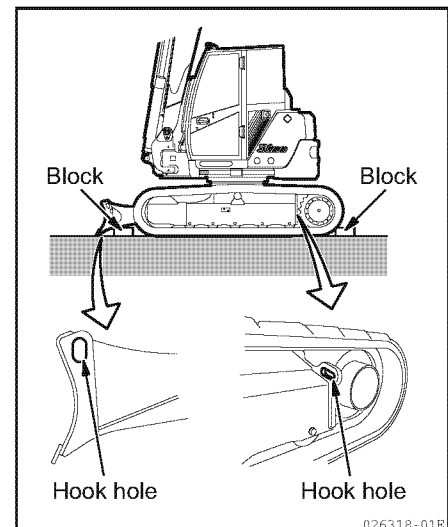
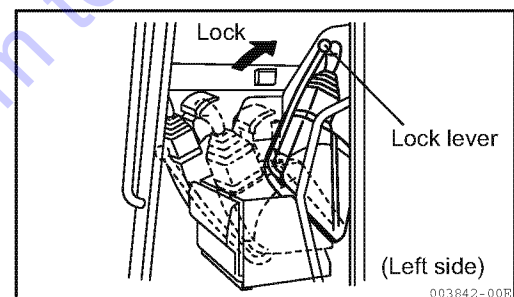
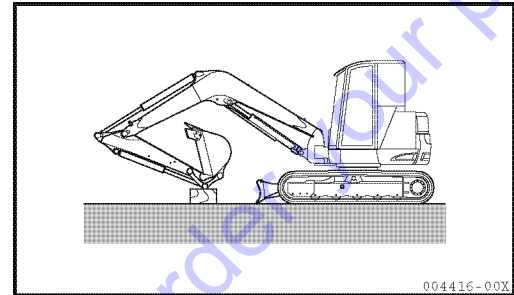

14-3. Precautions for transporting the machine

⚠ WARNING

- Select a route for transporting the machine based on the road width and clearance, and the height and weight of the machine.
- Make sure that the side door of the cabin is closed and locked before shipping.

For safe transportation, comply with all local regulations and laws.

Go to Discount-Equipment.com to order your parts

14-4. Suspending the machine

⚠ WARNING

- Never suspend the machine if any person is on the machine or the implement.
- Use wire ropes strong enough for the weight of the machine.
- Do not suspend the machine in any way other than that explained on the following page.
Failure to suspend the machine as prescribed will throw the machine off balance.
- Do not swing the machine being suspended.
- When suspending the machine, keep the machine in balance taking note of the center of gravity of the machine.
- Never stand near or under the suspended machine.

For safety in suspending the machine, comply with all applicable regulations.

Go to Discount-Equipment.com to order your parts

14. Transportation

Suspend the machine on the level ground as follows:

- 1) Swing the upperstructure so that the blade is behind the operator's seat.
- 2) Raise the blade to the highest limit.
- 3) Extend the hydraulic cylinders of the front implement (except for the boom swing cylinder) to the maximum.
- 4) Stop the engine, and make sure that nothing is left around the operator's seat before leaving the machine.
- 5) Put a slingbelt (or a wire rope) through (A) illustrated in the figure on the right and install shackles in the right and left holes in the side plate of the blade on the rear side, then securely fasten the slingbelt to the shackles.
- 6) Put splints on the machine where the slingbelt touches when the slingbelt is pulled.
- 7) Suspend the machine above the ground, wait until the machine is stable and then suspend it slowly.

IMPORTANT

- For a machine with a cabin, be sure to close the side door and the windshield.
- Set each lock lever at the lock position.

Shipping weight:

lbs. (kg)

Quick coupler		W/O quick coupler	
Steel crawler	Rubber crawler	Steel crawler	Rubber crawler
With cabin	With cabin	With cabin	With cabin
18103 (8210)	17970 (8150)	17750 (8050)	17168 (7990)

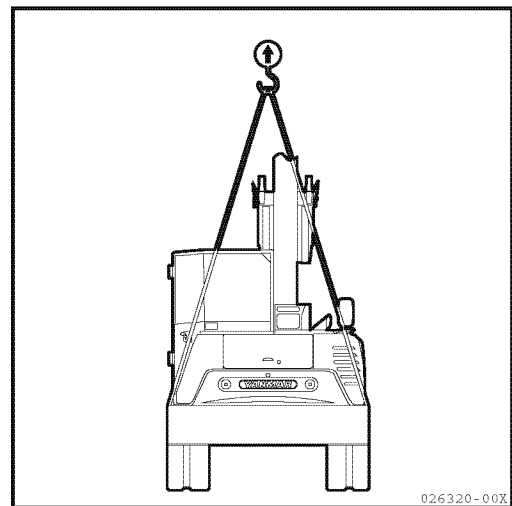
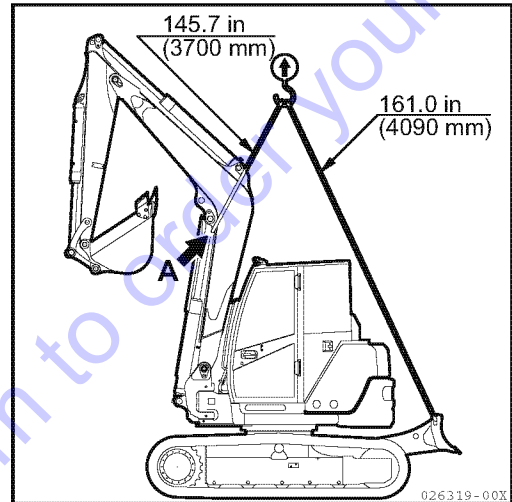
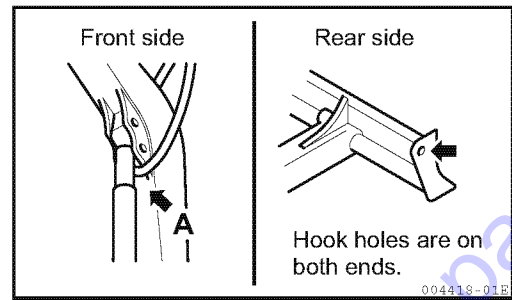

15. Care and Service in Cold Weather

15-1. Preparing for cold weather

In cold weather, you may have difficulty in starting the engine or the cooling water may freeze. So take measures as follows:

15-1-1. Fuel and lube oil

Use low viscosity fuel and lube oil. For the specified viscosities, refer to Section "21. Fueling, Oiling and Greasing Based on Temperature Range".

15-1-2. Cooling water

WARNING

Anti-freeze is flammable. When handling anti-freeze, keep away from any sources of ignition and do not smoke.

IMPORTANT

Never use an anti-freeze containing methanol, ethanol, or propanol.

For the timing of cooling water change and the mixing ratio of the anti-freeze, refer to Section "25-2. Nonperiodic services".

Note :

Because a YANMAR genuine long-life coolant (LLC) is added to the cooling water, you need not change it until the temperature falls below -31°F (-35°C).

If the temperature falls below -31°F (-35°C), refer to Section "25-2. Nonperiodic services" to control the density of the cooling water.

15-1-3. Battery

⚠ WARNING

- The battery generates flammable gas and it can cause a fire and an explosion. Keep sparks or flames away from the battery.
- Battery electrolyte contains dilute sulfuric acid which is a strong acid. To avoid serious injury, do not allow the electrolyte to contact skin or splash into eyes. If the electrolyte contacts your skin or gets in your eyes, flush immediately with large amounts of water, and obtain medical treatment at once.

Battery performance deteriorates as the temperature goes down. When the battery voltage is low, battery electrolyte will easily freeze. Keep the charging rate close to 100% (full charging) and keep the battery warm for easy start the next day.

Note :

Measure the specific gravity of the electrolyte to determine the charge ratio using the conversion table given below.

Charging rate \ Electrolyte temperature	68°F	32°F	14°F	-4°F
	(20°C)	(0°C)	(-10°C)	(-20°C)
100%	1.28	1.29	1.30	1.31
90%	1.26	1.27	1.28	1.29
80%	1.24	1.25	1.26	1.27
75%	1.23	1.24	1.25	1.26

The specific gravity of the electrolyte varies with its temperature and recharged condition.

15-2. Precautions after a day's work

To prevent the machine from getting stuck in the morning due to frozen mud or water deposits on the undercarriage, be sure to observe the following precautions:

- Remove any mud or water adhering to the machine. If mud or water droplets adhering to the hydraulic cylinder rods should get into the seals, the seals could be damaged.
- Park the machine on solid, dry ground.
If no solid, dry ground is available, lay plates on the ground and park the machine on the plates to prevent the frozen tracks from sticking to the ground.
- Drain the water accumulated in the fuel system by opening the drain cock, to prevent freezing.
- As battery performance deteriorates in low temperatures, cover the battery or move it to a warm place, and reinstall it in the machine on the next morning.
If the level of the battery electrolyte is low, add distilled water before starting operation on the next morning. To prevent the battery from freezing at night, do not add distilled water after completing operation.

15-3. After cold weather ends

When the temperature rises, do the following:

- Replace the lube oil and fuel with the specified viscosities according to Section "21. Fueling, Oiling and Greasing Based on Temperature Range".
- If you have added an AF-PT anti-freeze (for one winter season only), fully drain the cooling system, flush the inside of the cooling system well, and fill the cooling system with tap water.

16. Long-term Storage

16-1. Before storing

IMPORTANT

When storing the machine, set up the machine as illustrated in the figure at the right, to protect the hydraulic cylinder rods from becoming corroded.

When storing the machine for a long period, do the following:

- Clean all parts and store the machine indoors. If you have to store the machine outdoors, park the machine on level ground and cover it with a protective sheet.
- Apply lube oil and grease to the machine and replace the engine oil.
- Apply a small amount of antirust to exposed parts of the hydraulic cylinder rods.
- Fill the battery with distilled water up to the upper level mark. After the battery has fully recharged, disconnect the negative terminal, and cover the battery or remove the battery from the machine to store it.
- Add an anti-freeze to the cooling water if the air temperature can fall below 32°F (0°C).

Because a YANMAR genuine long-life coolant (LLC) is added to the cooling water, you need not change it until the temperature falls below -31°F (-35°C).

If the temperature falls below -31°F (-35°C), refer to Section "25-2. Nonperiodic services" to control the density of the cooling water.

- Lock the control levers and pedals with the lock lever and pedal guards respectively.
- Antirust

When stored near the sea or in a place exposed to sea breezes, the machine easily becomes rusty. Carefully apply an antirust to all exposed parts of the piston rods and cover the machine with a polyethylene sheet or oil paper.

Recommended antirust	Manufacturer
P-1300 (Solvent cutback rust preventive oil)	Shin Nihon Sekiyu
P-3 (Solvent cutback rust preventive oil)	Japan Energy
P-300 (Solvent cutback rust preventive oil)	Cosmo Sekiyu

Some antirust solvent damages rubber materials. Be sure to use the recommended antirust or its equivalent.

- To prevent condensation inside the fuel tank, either drain the fuel tank or fill the tank completely.

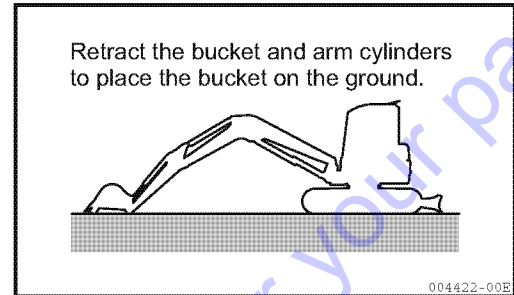

16-2. Storing

WARNING

When you have to operate the machine indoors for the antirust procedure, be sure to ventilate the area well by opening windows and doors to prevent asphyxiation.

Move the machine at least once a month to form new oil films on all the moving parts during long-term storage, and recharge the battery at the same time.

16-3. Using the machine again

IMPORTANT

When reusing a machine that has been stored for a long time without receiving antirust treatment once a month, consult your dealer.

To use the machine again after a long period of storage, follow the procedure below:

- Wipe antirust off the hydraulic cylinder rods.
- Apply generous amounts of grease or oil to the moving parts.
- Drain water from the fuel tank, the engine oil pan and the hydraulic oil tank by removing the drain plugs.
- After starting the engine, warm-up the machine before use.

17. Troubleshooting

17-1. Phenomena that do not constitute faults

The following phenomena do not constitute faults:

- Shaking of the bucket

When the boom is raised immediately after extending the arm while curling the bucket, the bucket may shake. This phenomenon is not a fault.

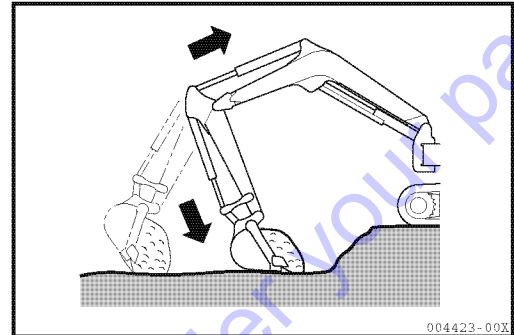

- Discontinuous arm movement

When digging the ground with the arm, the arm may slow down momentarily at the almost vertical position especially when the engine speed is low.

This phenomenon is not a fault.

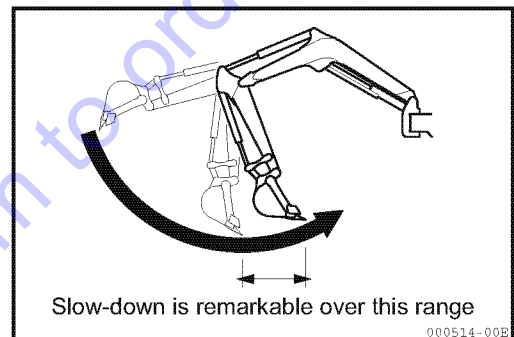

- Shift in upperstructure position

When turning the machine sharply as when spin-turning or pivot-turning, the upperstructure may slightly shift out of position.

This phenomenon is not a fault.

- Thermal shock of the travel motor

If, in cold weather, the temperature of the hydraulic oil elevates after start-up and becomes 140°F (60°C) higher than the outside temperature by relief operation without traveling, sometimes the machine cannot pivot-turn because of thermal shock. This phenomenon is not a fault.

- The boom swing cylinder is extended when digging

The swing cylinder may become extended in some digging situations or postures. This phenomenon is not a fault.

- Time lag in travel speed change response

At low engine speed, a time lag in response may occur when the travel speed is changed from high speed to low speed. This phenomenon is not a fault.

17-2. Towing

⚠ WARNING

Always safely tow a disabled machine by using the proper equipment and procedures.

The use of incorrect methods or improper procedures could result in bodily injury.

Follow the recommendations below to properly perform the towing procedure.

If the machine becomes mired in muddy ground and must be towed out, or when it is necessary for the machine to tow a heavy object, attach the sling belt as illustrated at the right.

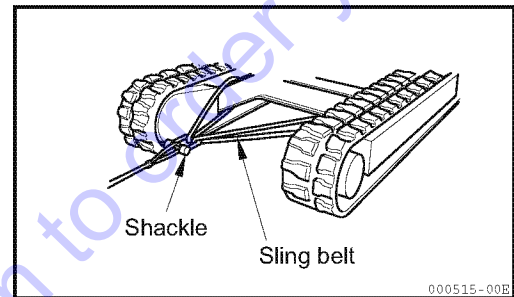
**IMPORTANT**

- Check to see that the wire ropes, sling belts, and shackles to be used are of sufficient strength and are free from cracks and damage.
- Never tow the machine with the wire rope attached only to the hook.
- The hook is only intended for stabilizing the machine during shipping.

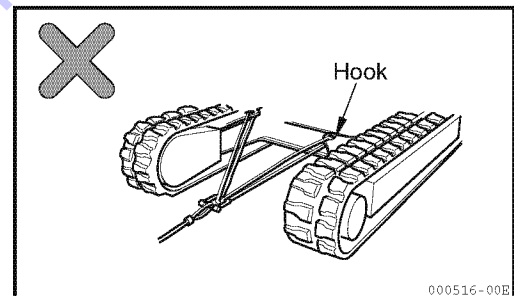

17-3. If the battery is overdischarged

⚠ WARNING

- Stop the engine and turn the starter switch key to the "OFF" position before checking or servicing the battery.
- Flammable hydrogen gas is produced by the battery, which may cause ignition. Keep flames, sparks and lit cigarettes away from the battery.
- The battery electrolyte contains dilute sulfuric acid, which is a strong acid.

If the battery electrolyte contacts your clothes, they may be damaged.

If the battery electrolyte gets into your eyes or contacts your skin, flush immediately with large amounts of water, and obtain medical treatment at once.

- Be sure to wear safety goggles when handling a battery.
 - To disconnect the terminals, begin with the negative terminal (ground side); to connect the terminals, begin with the positive terminal.
 - If a tool touches both the positive terminal and the machine, hazardous sparks may be generated.
 - If a terminal is loose, hazardous sparks may be generated due to poor contact, which could cause ignition and explosion.
- Be sure to securely connect the terminals.

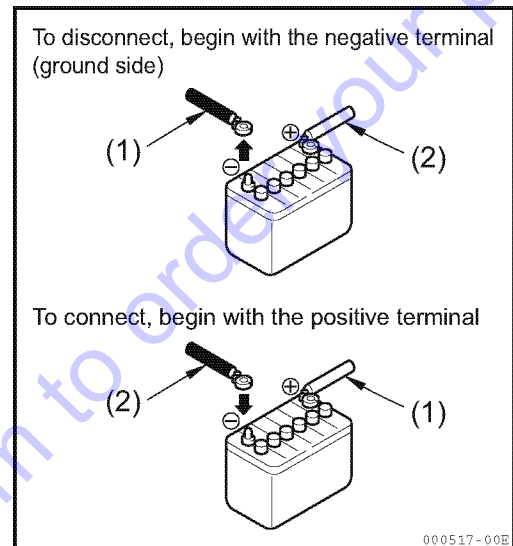

17-3-1. Starting the engine using booster cables

To start the engine using booster cables, do the following.

■ **Precautions for connecting and disconnecting the booster cables**

⚠ WARNING

- When you start the engine using booster cables, wear safety goggles.
- If you start the engine by taking electric power from another machine, do not allow contact between your machine and the other machine.
- To connect the booster cables, begin with the positive terminal, and to disconnect them, begin with the negative terminal (ground side).
- If a tool touches the positive terminal and the machine at the same time, hazardous sparks may be generated.
- Do not connect the booster cables to terminals of reverse polarity. That is, never connect a negative terminal on one machine to the positive terminal on the other machine.
- As the last step, connect the negative booster cable to the upperstructure. At this time, sparks will be generated. Connect the terminal to a point as far away from the battery as possible.

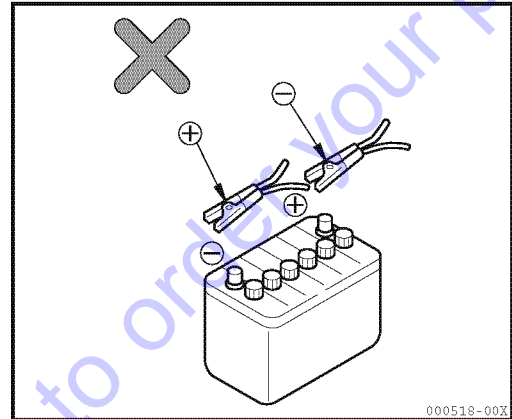

IMPORTANT

- The booster cable capacity and the clip size should be suitable for the battery current.
- The battery of the normal machine should be the same capacity as that of the machine in trouble.
- Check the booster cables and clips for an absence of damage, cracks, and corrosion.
- Securely connect the clips.

■ Charging with the battery mounted on the machine

- Remove the battery cables from the positive and negative terminals of the battery before charging it. If this is not done, abnormal voltage may be applied to the generator which could damage it.
- While charging the battery, remove all plugs to release the gases generated by charging.
- If the battery overheats [the temperature of the electrolyte exceeds 113°F (45°C)], interrupt charging.
- Stop charging as soon as the process has been completed.
Overcharging could cause the following troubles:
 - Overheating of the battery
 - Decrease in battery electrolyte
 - Battery failure
- Do not reverse polarity of the cable connections to the battery (i.e., the negative cable to the positive terminal, or the positive cable to the negative terminal).
Reversing the polarity of the connections will cause the generator to be damaged.
- Handling the battery (except for checking the electrolyte level and measuring the specific gravity of the electrolyte) should be performed after disconnecting the battery cables.

■ Connecting the booster cables

Turn the starter switch to the "OFF" position, and connect the booster cables as follows:

- 1) Turn the starter switches on both the normal machine and the machine in trouble to the "OFF" position.
- 2) Connect the clip of the booster cable (A) (normally red) to the positive terminal on the machine in trouble.
- 3) Connect the other clip of the booster cable (A) to the positive terminal on the normal machine.
- 4) Connect the clip of the booster cable (B) (normally black) to the negative terminal on the normal machine.
- 5) Connect the other clip of the booster cable (B) to the engine block of the machine in trouble.

■ Starting the engine

- 1) Make sure that the clips are securely connected to the battery terminals.
- 2) Start the engine on the normal machine, and increase the engine speed to the maximum.
- 3) Turn the starter switch on the machine in trouble to the "START" position to start the engine.
If the engine does not start, wait for more than two minutes and retry starting. (At this point, do not stop the engine on the normal machine and keep engine speed at full.)

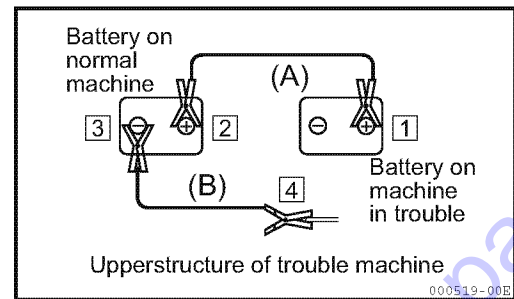

■ Disconnecting the booster cables

After the engine on the machine in trouble has started, disconnect the booster cables in the reverse order of the connecting procedure.

- 1) Remove the clip of the booster cable (B) from the engine block on the machine in trouble.
- 2) Remove the clip of the booster cable (B) from the negative terminal on the normal machine.
- 3) Remove the clip of the booster cable (A) from the positive terminal on the normal machine.
- 4) Remove the clip of the booster cable (A) from the positive terminal on the machine in trouble.

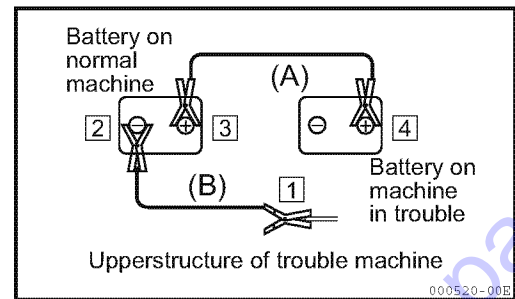

17-4. Troubleshooting

17-4-1. Engine and electrical equipment

- Contact your dealer for assistance, regarding the measures indicated in the parentheses in the list below.
- If any abnormalities or troubles are encountered that are not included among those shown below, ask your dealer for assistance.

Trouble		Cause	Measure	
Engine	Steam comes out of top of radiator.	<ul style="list-style-type: none"> • Shortage of cooling water 	<ul style="list-style-type: none"> • Check cooling water level. Refill, if necessary. (Check cooling water for leak from water port.) • Adjust belt tension. • Replace cooling water. Clean inside of cooling system. • Replace thermostat. • Clean or repair fin. • Check or replace electrical system. 	
	Water temperature alarm lamp lights.			<ul style="list-style-type: none"> • Loose fan belt • Buildup of dust and water scale on cooling system • Defective thermostat • Clogged radiator fin or inclined fin • Defective electrical system
	Engine trouble monitor lamp blinks.			
	Turning on starter motor does not start engine.	<ul style="list-style-type: none"> • Shortage of fuel • Air mixed in fuel system 	<ul style="list-style-type: none"> • Refill fuel tank. • Repair air leak. Release air from fuel system. (• Contact dealer for repair.) 	
	Dark fumes come out of machine.	<ul style="list-style-type: none"> • Defective fuel injection pump or deteriorated nozzle performance • Improper compression • Blown out fuse • Damaged starter switch key stop solenoid. Link disengagement 	<ul style="list-style-type: none"> (• Check and repair.) • Replace fuse. (• Check and repair.) 	
Fume color is white or bluish white.	<ul style="list-style-type: none"> • Clogged air cleaner element • Deteriorated nozzle performance • Improper compression 	<ul style="list-style-type: none"> • Clean or repair element. (• Check and repair.) (• Check and repair.) 		
Electrical equipment	Turning starter switch to "START" dose not start starter motor.	<ul style="list-style-type: none"> • Too much oil in oil pan • Improper fuel • Worn cylinder or piston ring 	<ul style="list-style-type: none"> • Drain oil from oil pan up to specified level. • Replace fuel with recommended one. (• Repair.) 	
	Maximum engine speed does not provide enough brightness of lamps.	<ul style="list-style-type: none"> • Defective wiring system • Defective starter switch • Insufficiently charged battery • Defective starter motor 	<ul style="list-style-type: none"> • Check and repair wiring system. • Replace starter switch. • Recharge battery. (• Check and repair.) 	
	During engine operation, lamp is extremely bright, and frequently burns out.	<ul style="list-style-type: none"> • Defective wiring system • Defective generator or regulator 	<ul style="list-style-type: none"> • Check terminals for looseness and disconnection. Repair terminal, if necessary. (• Check and repair.) 	
	Electrolyte leaks from battery.	<ul style="list-style-type: none"> • Defective regulator 	<ul style="list-style-type: none"> (• Replace regulator.) 	
	Speed of starter motor is too low.	<ul style="list-style-type: none"> • Defective battery 	<ul style="list-style-type: none"> (• Replace battery.) 	
	<ul style="list-style-type: none"> • Defective wiring system • Insufficiently charged battery • Defective starter motor 	<ul style="list-style-type: none"> • Check and repair wiring system. • Recharge battery. (• Check and repair.) 		

17. Troubleshooting

17-4-2. Machine body

- Contact your dealer for assistance, regarding the measures indicated in the parentheses in the list below.
- If any abnormalities or troubles are encountered that are not included among those shown below, ask your dealer for assistance.

Trouble		Cause	Measure
Machine body	Power or speed of moving part is low.	<ul style="list-style-type: none"> • Deteriorated function caused by worn hydraulic pump • Pressures at system relief valve or circuit relief valve of control valve have dropped below set values • Damaged hydraulic cylinder • Insufficient amount of hydraulic oil • Clogged filter 	<ul style="list-style-type: none"> (• Replace hydraulic pump.) (• Check and repair valves.) (• Check and repair.) • Replenish hydraulic oil up to specified level. • Clean or replace filter.
	Upperstructure does not swing or does not swing smoothly.	<ul style="list-style-type: none"> • Insufficient amount of grease • Defective swing brake valve • Defective swing motor • Swing brake has not released 	<ul style="list-style-type: none"> • Check and grease. (• Check and repair.) (• Check and repair.) (• Check and repair.)
	Temperature of hydraulic oil is too high.	<ul style="list-style-type: none"> • Insufficient amount of hydraulic oil • Overload 	<ul style="list-style-type: none"> • Replenish hydraulic oil up to specified level. • Lower load.
	Machine does not move straight.	<ul style="list-style-type: none"> • Improperly adjusted crawler or trapped foreign material • Damaged hydraulic motor • Defective hydraulic pump • Defective control valve • Damaged sprocket, idler or track roller 	<ul style="list-style-type: none"> • Adjust or clean. (• Check and repair.) (• Check and repair.) (• Check and repair.) (• Check and repair.)

MAINTENANCE

Go to Discount-Equipment.com to order your parts

18. Precautions for Servicing

Do not use any inspection or servicing procedures that are not described and recommended in this manual.

Park the machine on solid, level ground to inspect and service it.

Check the hour meter

Read the hour meter every day to check if any service item has reached the time prescribed for implementation.

Use YANMAR genuine replacement parts

Use YANMAR genuine parts specified in the Parts Catalog.

Use YANMAR genuine lube oil and grease

Use YANMAR genuine lube oil and grease of specified viscosity for the operating temperature range.

Use clean lube oil and grease

Use clean lube oil, grease and containers and prevent dust from mixing into them.

Clean the machine

Clean the machine for easy isolation of faulty parts.

Particularly clean the grease nipple, breather, and the oil level gauge glass to prevent dust from entering into them.

Be careful of high water and oil temperatures

It is dangerous to replace the oil, the cooling water and the filter immediately after stopping the engine. Wait until their temperatures drop. When the engine oil is too cool, heat the oil to adequate temperature [approximately 68°F to 104°F (20°C to 40°C)] before draining oil to improve draining efficiency.

Check the drained oil and the old filter element

When replacing the engine oil, the hydraulic oil, or the filter element, check the drained oil and the old filter element for metallic dust and foreign solid deposits.

Observe precautions for replenishing oil

If a strainer is mounted on the oil port, do not remove the strainer to replenish oil.

Be careful of dust

When checking or replacing the oil, do this in a clean environment to prevent dust contamination.

Attach the warning tag

When the oil or the cooling water is being drained, attach the "SERVICING IN PROGRESS" tag to one of the control levers so that other persons will not start the engine.

Observe the warning labels

Observe the warning labels affixed to the machine.

Observe the precautions for welding

- Make sure to disconnect the battery cables (positive and negative terminals).
- Do not apply more than 200 V continuously.
- Ground the machine within 3.3 ft. (1000 mm) from the welded part.
- Make sure that there is no seal or bearing between the welded part and the grounded part.
- Do not ground around the pins on the implement or the hydraulic cylinder.

Be careful of fire

Clean parts with noncombustible detergent.

Clean mating surfaces before assembly

When you have removed a part with an O-ring or a gasket seal, clean the mating surfaces before installing the new part.

At this point, do not fail to refit the O-ring or the gasket.

Do not drop anything from your breast pocket

When you open the cover and attempt to look down into the inside of the machine, remove loose items from your breast pocket to eliminate the risk that they may drop into the machine.

Check the undercarriage

After the machine is used at a rocky place, check the undercarriage for damage. Check for loose bolts and nuts, cracks, wear, and other damage. Loosen the tension of the crawlers more than usual.

Observe the precautions for cleaning the machine

- Do not spray steam directly at the connectors.
- Do not splash water on the monitors in the cabin.
- Do not spray high-pressure water directly at the radiator and the oil cooler.

18. Precautions for Servicing

Check before and after working

If the machine is to be used in mud, rain, snow, or on a beach, check for loose plugs and cocks before working. After working, clean the machine and check each part for cracks and damage and check for loose or missing bolts and nuts. Apply grease earlier than usual. Particularly apply grease every day to the pins on the implement which are submerged in mud.

Observe the precautions for working in a dusty place

If you use the machine in a dusty place, be careful of the following:

- Check the air cleaner for clogging.
- Clean the air cleaner element earlier than scheduled.
- Clean the radiator fin earlier to prevent it from clogging.
- Clean or replace the fuel filter element earlier than scheduled.
- Clean the electric equipment, especially the starter motor and the generator, to avoid dust deposits.

Do not mix oils

Never mix oils of different makes or types. If you have to replenish an oil with a different make or type than the one already in the tank, remove the remaining oil completely.

Go to Discount-Equipment.com to order your parts

19. Basic Servicing Practices

- Use YANMAR genuine replacement parts.
- Do not mix oils of different makes and types when replacing or replenishing oil.
- The following types of oil, fuel and cooling water are used at the factory for shipping unless otherwise specified:

Item	Type
Engine oil	Engine oil SAE10W30, CF class
Travel reduction gear oil	Gear oil SAE90 (GL-4)
Hydraulic oil	ISO VG46
Fuel	Diesel light oil (Ultra low sulfur)
Engine cooling water	YANMAR genuine long-life coolant (LLC) 51% added water

Go to Discount-Equipment.com to order your parts

19-1. Oils, fuel, and cooling water

19-1-1. Oils

- Because the oil is used in the engine and implement under extreme conditions (high temperature and pressure), it deteriorates as time elapses.
Be sure to use oils of the grades which are specified in the Operation & Maintenance Manual and suitable for the operating temperature range.
Even if the oil is not contaminated, be sure to replace the oil within the specified service hours.
- Oil is equivalent to blood in a human body. Be careful in handling it so that impurities (water, metallic dust, and foreign solids) will not be mixed into it.
Most machine failures are caused by impurities in the oils.
Be careful not to mix impurities into the oils especially after storing the machine and replenishing oils.
- Do not mix oils of different makes and types.
- Use the specified amount of oil.
Use of larger or smaller amounts of oil than specified may cause machine problems.
- If the oil becomes cloudy, it may suggest that water or air could have been mixed into the hydraulic system. If this event happens, ask your dealer for assistance.
- Be sure to replace the oil filter element with a new one when changing the oil.
- To know what condition the machine is in, it is recommended that you analyze the properties of the oil periodically.
Ask your dealer for more information on this issue.

19-1-2. Fuel

- Because the fuel injection pump is a precision device, using a fuel containing water or dust will cause problems.
- Be careful that impurities will not be mixed into the fuel especially after storing the machine and refueling.
- Be sure to use a fuel recommended in the Operation & Maintenance Manual.
In addition, keep in mind that you should use a fuel appropriate for the operating temperature range because it will freeze at temperatures lower than 5°F (-15°C).
- Fully refuel every day after finishing the work so that the moisture in the fuel tank will not condense and water will not mix with the fuel.
- Before starting the engine, or ten minutes after refueling, drain any deposits and water through the drain plug on the fuel tank.
- If the fuel level becomes low or the filter element is replaced, the air should be bled from the fuel system.

19-1-3. Cooling water

- Because unpotable water may contain much calcium and impurities, using it will cause water scale to build up in the engine or the radiator, causing poor heat exchange and overheating.
Never use unpotable water for cooling purposes.
- When using an anti-freeze, observe the precautions described in the Operation & Maintenance Manual.
- A YANMAR machine is shipped with YANMAR genuine anti-freeze. The anti-freeze is anticorrosive to protect the cooling system. Because the anti-freeze can be used continuously over two years, you need not remove it in hot weather.

! DANGER

Keep sources of ignition away from the antifreeze because it is flammable.

- The mixing ratio of anti-freeze to water differs based on air temperature.
For the mixing ratio, refer to Section "25-2-6. Cleaning the inside of the cooling system".
- If the engine is overheated, replenish the cooling water after the engine has cooled down.
- Shortage of cooling water will cause the cooling system not only to overheat but also to corrode, due to air which comes in the system.

19-1-4. Grease

- Grease ensures smooth operation of moving parts such as connectors and prevents operating noises.
- The nipples not listed on the pages for periodic service are those used for overhaul purposes. Normally it is not necessary to refill them.
Grease them if any abnormal condition arises after long term use.
- Wipe away all excess grease after greasing.
Carefully wipe the excess grease from all moving parts which might be easily worn by adhered sand or grit.

19-1-5. Storing the oil and fuel

- Store the oil and fuel indoors so that they will not be contaminated by impurities such as water or dust.
- When you store oil or fuel in drums for a long period, position them so that their outlets align in a straight line (to prevent moisture absorption).
When storing the oil or the fuel outdoors, cover the drums with a waterproof sheet.
- To avoid deterioration caused by long-term storage, use the oil on a first-in first-out basis.

19-1-6. Filter

- The filters are very important parts which prevent impurities from getting into critical devices through the lube oil, fuel and air systems.
Replace the filter elements periodically according to the instructions of the Operation & Maintenance Manual.
Under difficult conditions, you need to replace the filter elements earlier than suggested in the Operation & Maintenance Manual depending on the type of oil and fuel (sulfur content).
- Never reuse the filter elements (cartridge type) by cleaning them.
- When replacing a filter element, confirm that no metallic dust or foreign solids are present on the old filter.
If they are found to be present, contact the nearest dealer.
- Do not unpack the filter element before use.
- Use YANMAR genuine filter elements.

19-2. Electrical equipment

- If electrical equipment gets wet or wiring insulation is broken, electric leaks may occur and the machine may malfunction.
- Check the fan belt for tension and damage, and also check the battery for electrolyte level.
- Never disconnect or disassemble the electrical equipment mounted on the machine.
- Do not mount any electrical equipment other than those items provided by YANMAR.
- Be careful not to spray water on the electrical equipment when washing the machine or operating in the rain.
- After working near the sea, take necessary precautions to protect the electrical equipment from corrosion.

Go to Discount-Equipment.com to order your parts

19-3. Hydraulic system

- The hydraulic system is hot during and immediately after operation. It is also under high pressure during operation. Therefore, check and service the hydraulic system carefully as follows:

- Put the bucket on level ground so that no pressure is applied to the hydraulic cylinder circuits.
- Be sure to stop the engine.
- Wait until the temperature drops sufficiently before starting maintenance.

Do not suddenly remove any plugs, screws or connecting parts of the hoses. Otherwise oil may spout out due to residual internal pressure even when the oil temperature has lowered. Be careful not to stand in front of any plugs, screws or connecting parts when loosening them, to prevent injury. Loosen them gradually, to relieve the internal pressure.

- Always relieve the internal pressure before checking and servicing the hydraulic system.
- Check the hydraulic oil level, replace the filter element, and replace the hydraulic oil when necessary.
- After removing hydraulic hoses and piping, check the O-rings and the packing for damage before reinstalling them.

Replace them if they are damaged.

- Bleed air after replacing or cleaning the hydraulic oil filter element or strainer, repairing or replacing the hydraulic equipment, or reinstalling the hydraulic cylinder or piping.

Bleed air according to the following procedure:

- 1) Set the engine rotation to medium. That is, set the lever in the middle of the stroke.
- 2) Slowly operate each cylinder 4 to 5 times to approximately 4 in. (100 mm) before both stroke ends.
- 3) Operate the cylinder 4 to 5 times at full stroke.

- Failure to bleed air from the hydraulic cylinder and operating it suddenly to the stroke ends could cause piston seal damage.

- If air is left in the hydraulic circuit, it will compress and expand and the hydraulic equipment will not operate smoothly.

Air in the hydraulic circuit may shorten the service life of the hydraulic pump.

- 4) Check the hydraulic oil level and replenish hydraulic oil to the specified level if necessary.

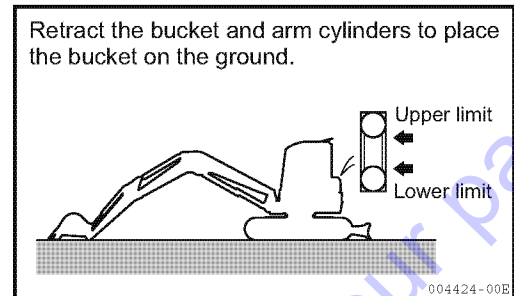

20. Consumables

Replace consumable parts such as filter element and bucket teeth periodically or earlier than wear limit.

Replace consumable parts securely to use our product more economically.

When you replace a part, be sure to use a Yanmar genuine part.

When ordering consumables, let us know the part numbers given in the parts catalog.

List of consumables

The numbers of parts in the parentheses represent those which must be replaced at the same time.

Item	Name	Q'ty	Replacing time interval
Engine oil filter	Filter 80×100 L	1	Every 250 service hours (At first 50 service hours)
Hydraulic oil tank filter	Filter element	1	Every 500 service hours (At first 250 service hours)
Line filter	Filter element	1	Every 1000 service hours
Fuel filter	FO filter 90×160 L	1	Every 500 service hours
Air cleaner	Cleaner element	1	Every 500 service hours
Bucket	Point teeth	4	-
	(Pin)	(4)	
	(Pin)	(4)	
	Side cutter (left)	1	
	Side cutter (right)	1	
	(Bolt 22×62)	(6)	
	(Nut 22)	(6)	

21. Fueling, Oiling and Greasing Based on Temperature Range

21-1. Fuel and oil

Select fuel and oil based on to the air temperature range.

The prescribed amount of oil means the total amount of oil included in the piping and equipment. The amount of oil to be changed means the amount of oil replaced in checking and servicing.

If you start the engine at air temperatures lower than 32°F (0°C), use SAE10W, SAE10W-30, or SAE15W-40 even if the temperature in the daytime rises to 50°F (10°C) or so.

21-2. Cooling water

Because a YANMAR genuine long-life coolant (LLC) is added to the cooling water, you need not change it unless the temperature falls bellow -31°F (-35°C).

If the temperature falls below -31°F (-35°C), refer to Section "25-2. Nonperiodic services" to control the density of the cooling water.

Part to be refilled	Oil type	Recommendations with regard to temperature ranges							Prescribed amount of oil Qts. (L)	Amount of oil to be changed Qts. (L)
		(°F) (°C)	-4 (-20)	14 (-10)	32 (0)	50 (10)	68 (20)	86 (30)		
Engine oil pan	Engine oil	SAE 10WCF							11.10 Qts. (10.5 L)	11.10 Qts. (10.5 L)
		SAE 10W-30CF								
		SAE 15W-40CF								
Travel reduction gear	Gear oil	SAE 90 (GL-4)							1.16 Qts. (1.1 L) (For right and left each)	1.16 Qts. (1.1 L) (For right and left each)
Hydraulic oil system	Hydraulic oil	ISO VG46							In the tank 15.8 Gals. (60 L) Other parts 13.8 Gals. (52 L)	15.8 Gals. (60 L)
Fuel tank	Light oil	No.2-D							30.4 Gals. (115 L)	-
		No.3-D								
		No.3-D (S)								
Cooling system	Water	YANMAR genuine long-life coolant (LLC) added							Radiator 9.1 Qts. (8.6 L) Subtank 0.4 Qts. (0.4 L)	-

035729-00E00

22. Standard Tightening Torque for Bolts and Nuts

22-1. Required tools

The following tools are required for servicing:

No.	Name	Part number	Q'ty
1	Screwdriver (replaceable head)	104200-92350	1
2	Filter wrench 68	119332-92751	1
3	Filter wrench 80	119640-92750	1
4	Filter wrench LO	171301-92750	1
5	Pressure nozzle	172122-05101	1
6	Wrench 8×10	28110-080100	1
7	Wrench 12×14	28110-120140	2
8	Wrench 17×19	28110-170190	1
9	Wrench 22×24	28110-220240	2
10	Wrench 27×30	28110-270300	1
11	Wrench 32×36	28110-320360	1
12	Hexagon socket screw key 4	28150-050000	1
13	Hexagon socket screw key 5	28150-050000	1
14	Hexagon socket screw key 8	28150-080000	1
15	Box wrench 27×140	28227-271400	1
16	Turning handle 12×250	28230-120250	1
17	Grease hose	933110-09701	1
18	Grease injector 800	933110-09802	1
19	Pliers 200	933171-00470	1

22. Standard Tightening Torque for Bolts and Nuts

22-2. Torque table

Bolts or nuts in the metric system should be tightened at the torque described below unless otherwise specified.

Item		Thread size × pitch	Tightening torque ft•lbf (N•m)	Remarks
Hexagon bolt (7T) Nut	Coarse threads	M6 × 1	7.2 to 8.7 (9.8 to 11.8)	1) Apply 80% tightening torque when tightened to aluminum. 2) Apply 60% tightening torque for 4T bolt and lock nut. 3) Use fine threads for engine only.
		M8 × 1.25	16.7 to 20.9 (22.6 to 28.4)	
		M10 × 1.5	32.5 to 43.4 (44.1 to 58.8)	
		M12 × 1.75	58 to 72.4 (78.5 to 98.1)	
		M14 × 2	86.8 to 108.5 (117.7 to 147.1)	
		M16 × 2	123 to 151.9 (166.7 to 206.0)	
		M18 × 2.5	173.6 to 209.8 (235.4 to 284.4)	
	M20 × 2.5	238.7 to 296.6 (323.6 to 402.1)		
	Fine threads	M14 × 1.5	94 to 108.5 (127.5 to 147.1)	
M16 × 1.5		155.5 to 177.2 (210.8 to 240.3)		
PT plug		1/8	7.2 (9.8)	
		1/4	14.5 (19.6)	
		3/8	21.7 (29.4)	
		1/2	43.4 (58.8)	
Pipe joint bolt		M8	9.4 to 12.3 (12.7 to 16.7)	
		M12	18.1 to 25.3 (24.5 to 34.3)	
		M14	28.9 to 36.1 (39.2 to 49)	
		M16	36.1 to 43.4 (49.0 to 58.8)	

IMPORTANT

If a part to be tightened is made of resin like a panel board, excessive tightening torque may damage the tightened part. Be careful when tightening.

23. Replacing Essential Parts Periodically

For safe operation, the machine must be serviced periodically. To increase safety, be sure to periodically replace the parts listed in the table of safety parts on the next page. A fire could result if they deteriorate or are damaged.

These parts are vulnerable to age and wear or deterioration and it is difficult to determine the degree to which they have deteriorated on the occasion of periodic service. To maintain their proper function at all times, therefore, replace them with new ones after using them for a specific period of time even if no abnormality is found with the parts.

If you find abnormalities in these parts before their scheduled replacement time is reached, repair or replace them immediately.

If a hose clamp is deformed or cracked, replace it immediately.

Check the hydraulic hoses (which are not periodic replacement parts). If any abnormality is found in them, retighten them or replace them immediately.

When replacing the hydraulic hoses, replace the O-rings and seals at the same time.

For further information about replacing the safety parts, ask your dealer.

Check the fuel and hydraulic hoses according to the periodic schedule described below.

Check categories	Check points
Start-up check	Oil leak from the connections or bodies of the fuel and hydraulic hoses
Voluntary monthly check	Oil leak from the connections or bodies of the fuel and hydraulic hoses Damage (crack, wear, or peeling) of the fuel and hydraulic hoses
Prescribed annual check	Oil leak from the connections or bodies of the fuel and hydraulic hoses Interference, crushing, aging, torsion, or damage (crack, wear, or peeling) of the fuel and hydraulic hoses

23. Replacing Essential Parts Periodically

■ List of essential parts

No.	Essential parts to be replaced periodically	Q'ty	Replacement time intervals
1	Fuel hose (fuel tank to water separator)	1	Earlier of either every 2 years or every 4000 service hours
2	Fuel hose (water separator to feed pump)	1	
3	Fuel hose (feed pump to fuel filter)	1	
4	Fuel hose (fuel filter to fuel injection pump)	1	
5	Fuel hose (fuel filter to fuel tank)	1	
6	Fuel hose (fuel injection pump to fuel filter)	1	
7	Fuel hose (fuel injection valve to fuel injection pump)	1	
8	Fuel hose (fuel injection valve to fuel injection valve)	3	
9	Fuel tube cap	1	
10	Main pump outlet hose (P1, P2, P3 to C/V)	3	

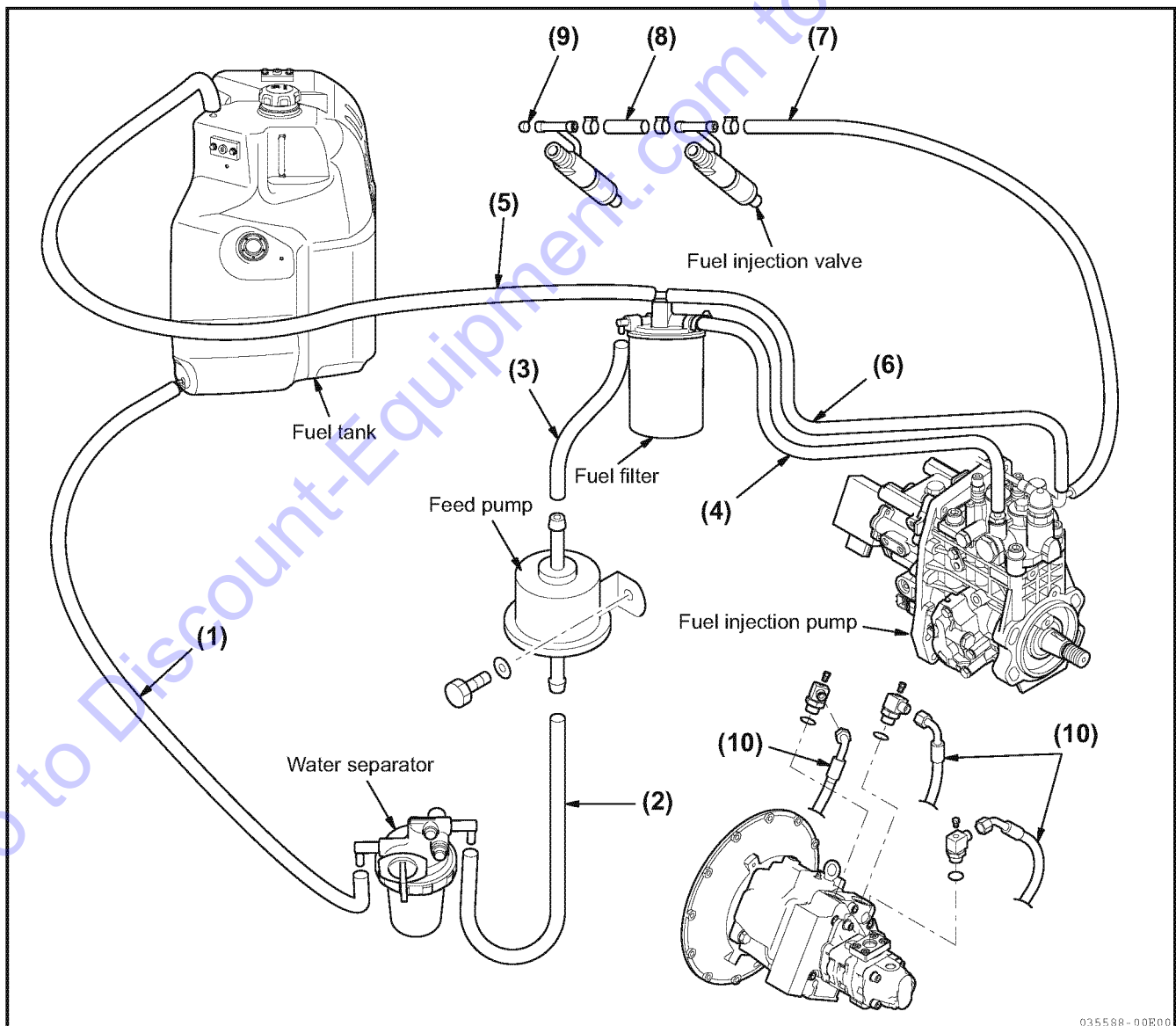

24. Maintenance Table

Daily and periodic inspection are important to keep the machine in its best condition. The following is a summary of inspection and servicing requirements by inspection interval. Periodic inspection intervals vary depending on the use, loads, fuels and lube oils used and handling conditions, and are hard to establish definitively. The following should be treated only as a general standard.

When the time for an inspection approaches, study the relevant pages in the Operation & Maintenance Manual. Keep a record of daily operation and the results of maintenance work.

24-1. Table of service time intervals

Check and service points	Page
■ At first 50 hours (only once after the new machine has started to be used)	
Replacing the engine oil and the engine oil filter element	3-22
■ At first 100 hours (only once after the new machine has started to be used)	
Replacing the lube oil for the travel reduction gearbox	3-22
■ At first 250 hours (only once after the new machine has started to be used)	
Replacing hydraulic return filter element	3-22
Cleaning the suction filter element in the hydraulic oil tank	3-22
■ Nonperiodic servicing	
Checking the rubber crawler (for rubber crawler types)	3-23
Checking and adjusting the rubber crawler tension (for rubber crawler types)	3-25
Replacing the rubber crawler (for rubber crawler type)	3-28
Checking and adjusting the steel crawler tension (for steel crawler types)	3-31
Replacing the bucket teeth	3-34
Cleaning the inside of the cooling system	3-36
Maintenance, inspection and servicing of air conditioner	3-40
■ Checking before start-up	
Checking and replenishing the cooling water	3-44
Checking and replenishing the engine oil	3-45
Checking and replenishing the fuel in the fuel tank	3-46
Checking and replenishing the hydraulic oil in the hydraulic oil tank	3-47
Checking and adjusting the fan belt tension	3-48
Checking and replenishing the battery electrolyte	3-49
Greasing	3-50
Checking the electrical equipment	3-51

24. Maintenance Table

Check and service points	Page
■ Every 50 hours	
Greasing the swing gear and the swing bearing	3-52
Draining the water and deposits in the fuel tank	3-52
Cleaning the water separator element	3-53
■ Every 100 hours	
(Perform the same maintenance as indicated for every 50 service hours)	3-53
■ Every 250 hours	
Replacing the engine oil and the engine oil filter element	3-54
Checking and cleaning the air cleaner	3-56
Checking and replenishing the lube oil for the travel reduction gearbox	3-58
Checking and cleaning the radiator fin	3-59
■ Every 500 hours	
Replacing the fuel filter element	3-60
Replacing the air cleaner element	3-62
Replacing the hydraulic oil return filter element	3-63
■ Every 1000 hours	
Replacing the lube oil for the travel reduction gearbox	3-64
Replacing the hydraulic oil and cleaning the suction filter element	3-65
Replacing the line filter	3-67
Checking and adjusting the intake/exhaust valve clearances	Ask your dealer
Checking, cleaning and testing the fuel injection valve	Ask your dealer
Retightening the cylinder head bolts	Ask your dealer
■ Every 1500 hours	
Checking crankcase breather system	Ask your dealer
■ Every 2000 hours	
Checking and replacing fuel piping, cooling water piping	Ask your dealer
Lapping the intake/exhaust valves	Ask your dealer
Checking the accumulator	3-69
■ Every 3000 hours	
Checking, cleaning and testing EGR valve	Ask your dealer
Cleaning EGR lead valve	Ask your dealer

■ List of periodic inspection and servicing

*Applicable to models with the relevant equipment ◇ : Check ○ : Supply ● : Replace □ : Adjust (clean) ■ : Oil & grease

Check & service items		Daily	Every 50 hrs	Every 100 hrs	Every 250 hrs	Every 500 hrs	Every 1000 hrs	Every 2000 hrs
General	Check falling off, breakage of parts	◇						
	Check loosened bolts & nuts, retighten	◇						
	Check engine condition	◇						
	Clean	□						
Lube oil	Travel reduction gear oil					○		
	Check, resupply							
	Replace			●1st time			●	
Hydraulic system	Hydraulic oil							
	Check, resupply	◇						
	Replace						●	
	Clean suction filter					□1st time	□	
	Replace return filter				●1st time	●		
	Replace line filter						●	
	Check for abnormality of hydraulic pump	◇						
	Check function of accumulator							◇
Grease	Check grease-up positions, grease	■						
	Greasing the swing gears and the swing bearings		■					
Undercarriage	Check, adjust track tension	◇						
Steering equipment	Check performance, play of travel lever (pedal)	◇						
	Check performance of accel. dial	◇						
Electric equipment	Check front & work lights, horn	◇						
	Check hour meter function	◇						
	Check function of change, oil and pilot lamps	◇						
	Check wire breakage, short-circuits, loosened terminals retighten	◇						
	Check, resupply battery fluid	◇						
	Check specific gravity of electrolyte						□As required	
	Check function of monitor	◇						

24. Maintenance Table

◇ : Check ○ : Supply ● : Replace □ : Adjust (clean) ■ : Oil & grease

Check & service items		Daily	Every 50 hrs	Every 250 hrs	Every 500 hrs	Every 1000 hrs	Every 1500 hrs	Every 2000 hrs	Every 3000 hrs
Fuel oil	Check & supply of oil to the tank	◇							
	Drain the fuel tank		□						
	Clean the oil/water separator		□						
	Replace the fuel filter element				●				
Lube oil	Check the quantity of engine oil	◇							
	Replace the engine oil		● 1st time	●					
	Replace the engine oil filter element		● 1st time	●					
Cooling water	Check & supply of cooling water	◇							
	Clean radiator fins			□					
	Check the fan-belt tension	◇ (□)							
	Replace the cooling water					● within one year			
	Clean & check the cooling water system							● within two years	
Rubber hose	Check & replace fuel oil pipe, cooling water pipe	◇						●	
Intake system	Clean air cleaner & replace element			□	●				
Cylinder head	Adjust the intake and exhaust valve clearance					□			
	Lapping the intake and exhaust valve							□	
	Retightening the cylinder head bolts					□			
Fuel injection valve	Check, clean and test fuel injection valve					□			
EGR system	Check, clean and test EGR valve								□
	Clean EGR lead valve								□
Crankcase	Check crankcase breather system						◇		

Note :

- 1) When machine is used at dusty worksites, clean and replace filter element twice as often as specified in the table.
- 2) Execution of periodic inspection and servicing is indispensable to assuring conformance to EPA emission control regulations.
Keep a record of the results.

24-2. Service intervals when using the hydraulic breaker

When a hydraulic breaker is used, the hydraulic oil deteriorates earlier than in usual bucket excavating work. Set up the service time intervals as follows:

- **Replacing the hydraulic oil return filter element**

Replace the hydraulic oil return filter element on the new machine once after the first 100 to 150 hours. After that, replace it in accordance with the chart at the right.

- **Replacing the hydraulic oil in the hydraulic oil tank**

Replace the hydraulic oil in accordance with the chart at the right.

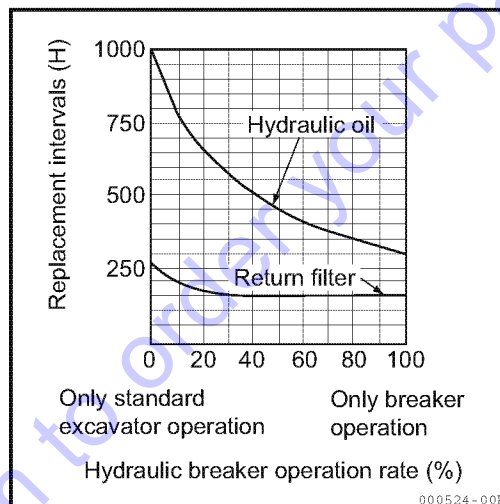

25. Procedures for Maintenance

25-1. First services

Service a new machine at 50, 100 and 250 hours, as follows:

25-1-1. At first 50 hours

- Replace the engine oil and the engine oil filter element.
For these procedures, refer to Section "25-6. Maintenance every 250 service hours".

25-1-2. At first 100 hours

- Replacing the lube oil for the travel reduction gearbox.
For this procedures, refer to Section "25-8. Maintenance every 1000 service hours".

25-1-3. At first 250 hours

- Replacing hydraulic return filter element.
For this procedure, refer to Section "25-7. Maintenance every 500 service hours".
- Cleaning the suction filter element in the hydraulic oil tank.
For this procedure, refer to Section "25-8. Maintenance every 1000 service hours".

25-2. Nonperiodic services

25-2-1. Checking the rubber crawlers (for rubber crawler types)

Rubber crawlers in the following condition require repair or replacement. Ask your dealer to repair or replace them.

■ Height of lugs

- As the lug height "a" is reduced by wear, the tractive force decreases.

If "a" becomes 0.2 in. (5 mm) or less, replace the crawler with a new one.

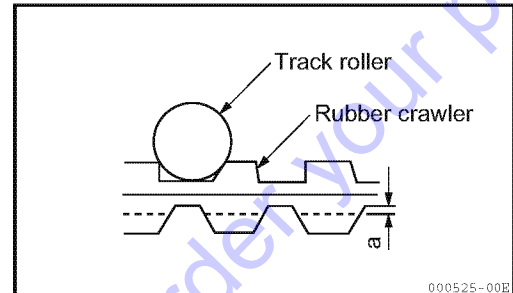

- If two or more links of the steel cord inside the crawler are exposed due to wear of the lugs, replace the crawler with a new one.

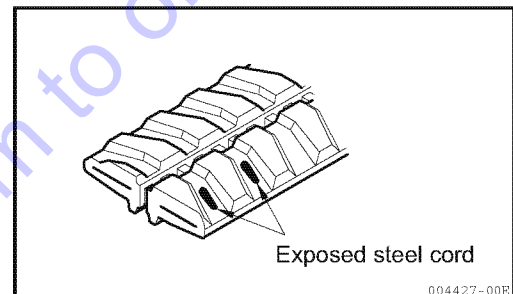

■ Rubber crawler steel cord breakage

If half or more of either of the steel cords is broken, replace the rubber crawler with a new one.

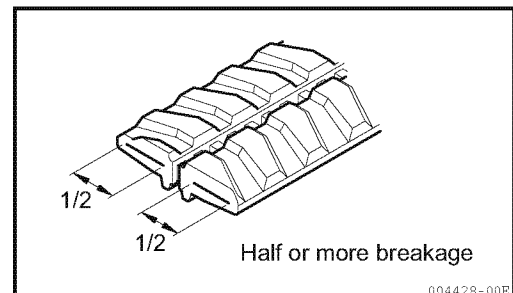

■ Separation of the core metal of the rubber crawler

If the core metal of the rubber crawler separates even at one place, replace the rubber crawler with a new one.

■ Rubber crawler tension

If the rubber crawler tension is habitually loose even after grease is injected, the grease adjuster may be defective internally. Ask your dealer to repair the grease adjuster.

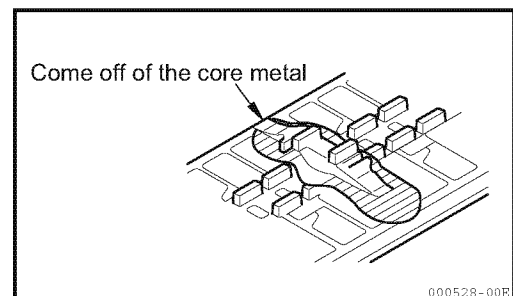

■ **Crack in the rubber crawler**

If a crack occurs between any lugs of the rubber crawler, repair it if the crack length reaches approximately 2.4 in. (60 mm). If the inside steel cord is exposed even though the crack is small, repair the rubber crawler immediately. If the crack length is less than 1.2 in. (30 mm) or the crack depth is less than 0.4 in. (10 mm), you do not need to repair the rubber crawler.

For a decision on whether the rubber crawler should be replaced, repaired or should continue to be used, ask your dealer.

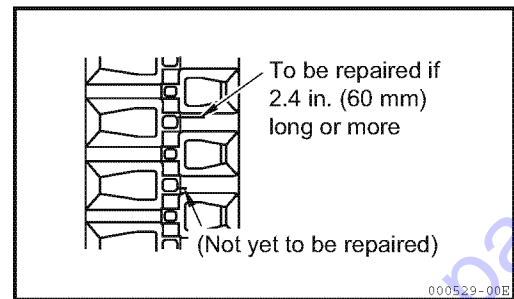

Go to Discount-Equipment.com to order your parts

25-2-2. Checking and adjusting the rubber crawler tension

⚠ WARNING

- When adjusting the rubber crawler tension while raising the machine, do not support the machine with the implement only.
The control levers could move or the hydraulic oil could flow out accidentally so that the machine would fall.
- When raising the machine, support it with safety blocks of sufficient strength.
When the machine is being checked or adjusted by two persons, one must operate the machine in response to signs from the other.

How a rubber crawler wears out depends on the working conditions and the nature of the ground. Be sure to check the rubber crawlers for wear and tension from time to time. When a new rubber crawler is mounted, perform the first check after 30 hours operation.

■ Checking the rubber crawler tension

- 1) Move the machine so that the joint (△ mark) on the inside surface of the rubber crawler is positioned at the upper center of the track frame.
- 2) Lift the machine with the implement and the safety blocks.
To do this, operate the control lever slowly.
- 3) The tension is proper if the clearance (H in the figure at the right) between the middle track roller rim and the rubber crawler is 0.8 to 1.0 in. (20 to 25 mm).

Working with the rubber crawler too loose will cause the rubber crawler to come off or the core metal to wear out earlier.

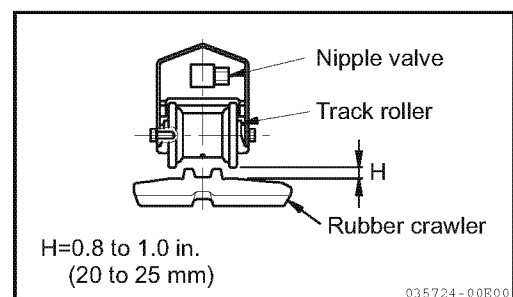
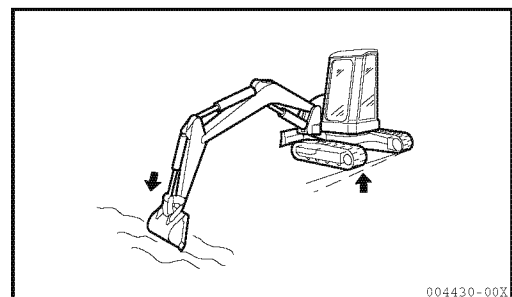
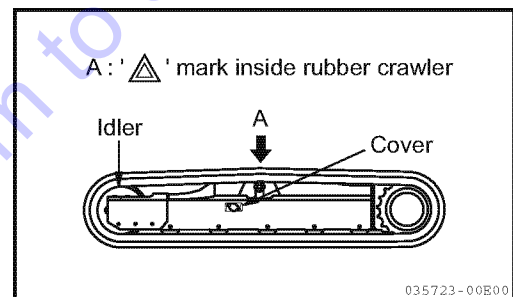

If the tension is improper, adjust it as follows:

■ **Adjusting the rubber crawler tension**

• **To increase the tension**

Prepare a grease gun.

1) Remove the cover.

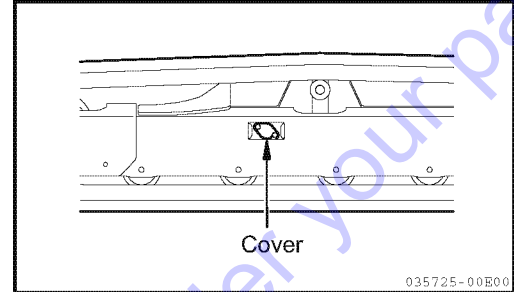

2) Raise the machine using the implement and the safety blocks. Inject grease through the nipple valve (1) using a grease gun until the rubber crawler tension has achieved a clearance (H) that is within the following range : 0.8 to 1.0 in. (20 to 25 mm).

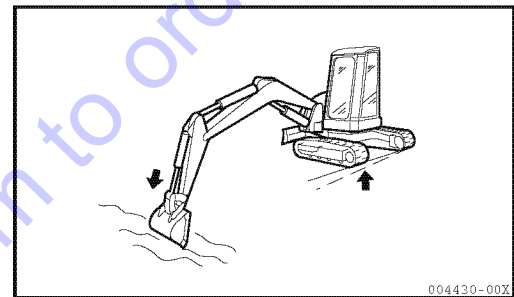

3) To check that the tension is proper, lower the machine and move the machine back and forth slightly.

4) Check the rubber crawler tension again. If the tension is improper, adjust it again.

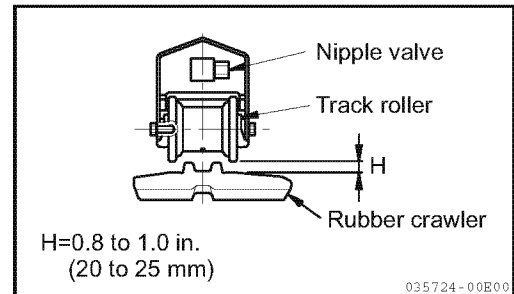

5) Install the cover.

6) The tension is adjustable until the clearance "a" is reduced to 0 in. (0 mm). If the tension is still loose, the rubber crawler may need repairing due to excessive wear. Contact your dealer and ask for repair.

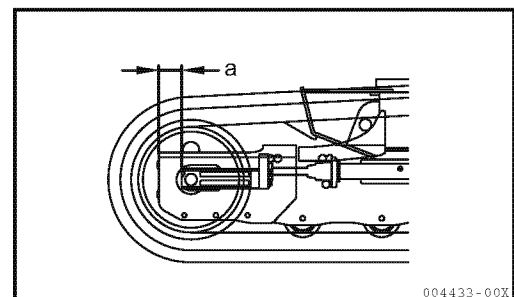

7) If the tension is loose even after grease injection, it is necessary to replace either the rubber crawler or the grease adjuster. Contact your dealer for assistance.

- Loosening the tension

⚠ WARNING

- Grease is under high pressure. If the nipple valve (1) is opened suddenly, grease could be ejected or the valve could blow, which could cause bodily injury.
- Do not rely on valve appearance alone to determine whether or not grease has been discharged, but check that by measuring the tension of the rubber crawler.
- Do not open the nipple valve (1) more than one turn.
- It is very dangerous to discharge the grease by any procedure other than that described below. If the tension of the rubber crawler cannot be loosened, contact your dealer and ask for repair.

- Remove the cover.
- Raise the machine with the implement and the safety blocks. Slowly loosen the nipple valve (1) and discharge the grease to adjust the rubber crawler tension and to achieve clearance (H) that is within the following range : 0.8 to 1.0 in. (20 to 25 mm).
- Never loosen the nipple valve more than one turn. (If the grease is not discharging properly, lower the machine and move the machine back and forth slightly.)
- Tighten the nipple valve (1).
Tightening torque : 36.1 ft•lbf (49 N•m)
- To check that the tension is proper, lower the machine and move the machine back and forth slightly.
- Recheck the rubber crawler tension and readjust it if necessary.
- Completely wipe away all of the discharged grease.

IMPORTANT

The rubber crawler is not grease-resistant. Completely wipe away all of the grease because grease will shorten its service life.

- Install the cover.

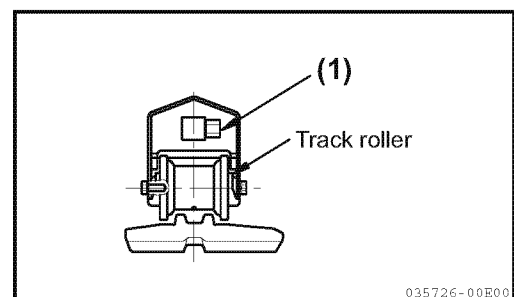
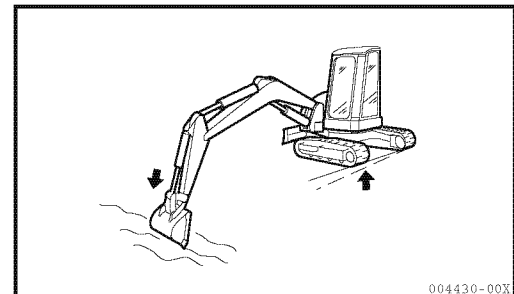
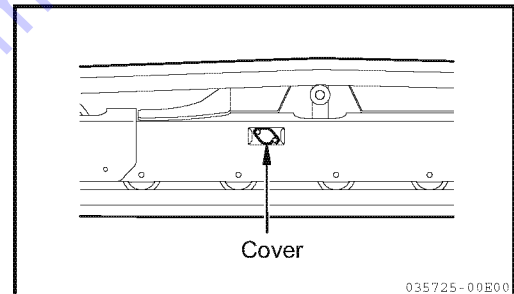

25-2-3. Replacing the rubber crawler

⚠ WARNING

- To replace the rubber crawler with a new one, work with a partner. You must operate the machine in response to signs from your partner.
- Because the rubber crawler is replaced with the machine in a raised position, there is a danger that the machine may accidentally fall. Do not move any parts other than the rubber crawler to be replaced in doing the job.
- The high internal pressure of the grease can cause the nipple valve to eject.
When you loosen the nipple valve (1), do not loosen it more than one turn.
At this point, do not loosen any parts other than the nipple valve (1). Also, do not turn your face toward the nipple valve (1).
- If the tension of the rubber crawler cannot be loosened by the procedure described here, ask your dealer to repair the rubber crawler.

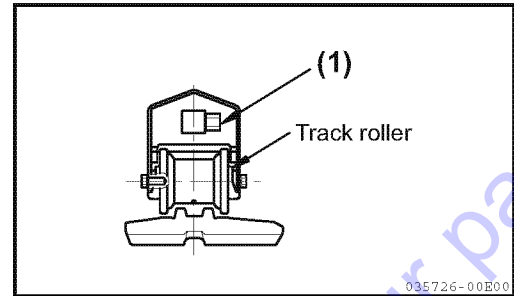

■ Replacing the rubber crawler

- Prepare a grease gun and steel pipes.

■ Removing the rubber crawler

⚠ WARNING

- It is very dangerous to discharge the grease by any procedure other than that described below.
- If the tension of the rubber crawler cannot be properly adjusted, ask your dealer to repair or replace the rubber crawler.
- When removing the rubber crawler, make sure that all of the grease has been completely discharged before turning the sprocket.

1) Raise the machine with the implement and the safety blocks.

To do this, slowly operate the control lever.

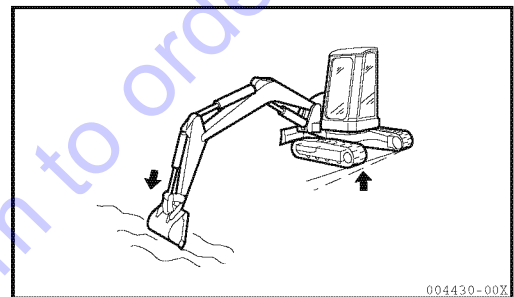

2) Loosen the nipple valve (1) little by little to gradually discharge the grease.

3) Never loosen the nipple valve (1) more than one turn.

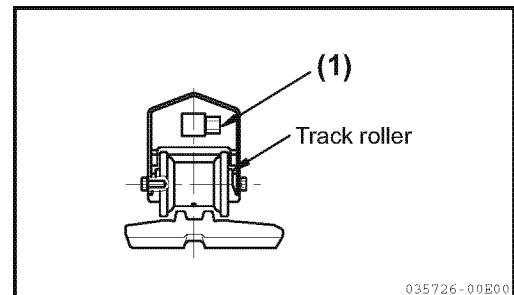

4) Insert the steel pipes into the rubber crawler and turn the sprocket in the reverse direction. When the rubber crawler is separated from the idler by the steel pipes, slide the rubber crawler off.

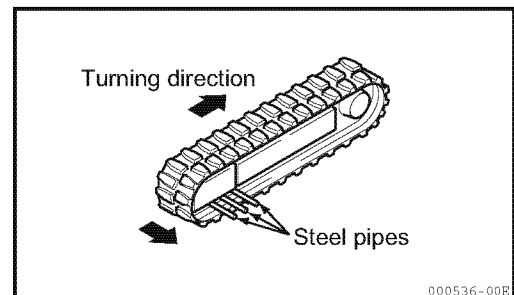

■ Installing the rubber crawler

- 1) Raise the machine with the implement and the safety blocks.

To do this, slowly operate the control lever.

- 2) Engage the rubber crawler with the sprocket, and place the rubber crawler on the idler.

- 3) Rotate the sprocket in the reverse direction to push the rubber crawler in, and then stop rotating it.

- 4) Insert a steel pipe into the rubber crawler, and rotate the sprocket again to place the rubber crawler on the idler.

- 5) Stop rotating the sprocket, and confirm that the rubber crawler is securely positioned on both the sprocket and the idler.

- 6) Adjust the rubber crawler tension, referring to Section "25-2-2. Checking and adjusting the rubber crawler tension".

- 7) Confirm that the rubber crawler is fully engaged with both the sprocket and the idler, and that the rubber crawler tension is sufficient. Then lower the machine to the ground.

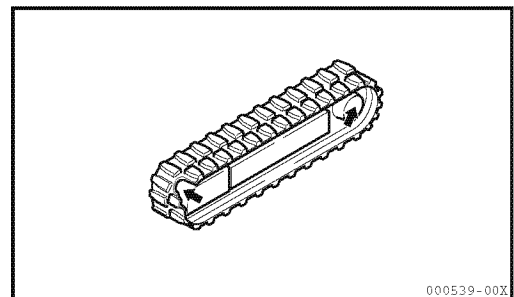
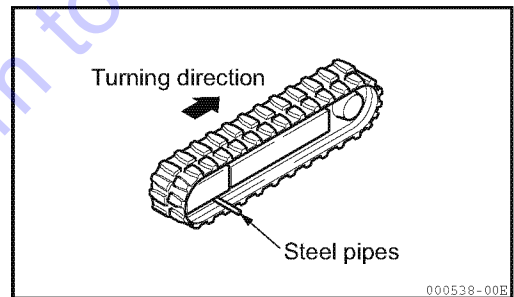
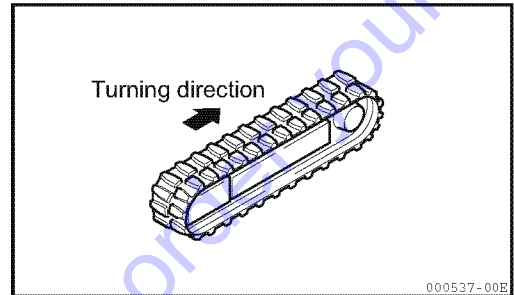
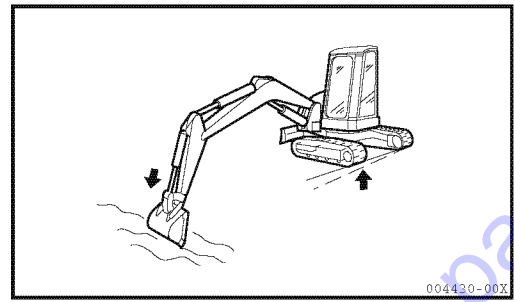

25-2-4. Checking and adjusting the steel crawler tension

⚠ WARNING

- When adjusting the steel crawler tension while raising the machine, do not support the machine with the implement only. The control levers could move or the hydraulic oil could flow out accidentally so that the machine would fall.
- When raising the machine, support it with safety blocks of sufficient strength.
- When the machine is being checked or adjusted by two persons, one must operate the machine in response to the signs from the other.

How the pins and bushings on the steel crawler will wear down depends on the working conditions and the ground conditions. Check the steel crawler tension from time to time to keep proper tension.

Check and adjust the steel crawler tension under the same conditions as in operation (for example, mud clogged condition if working in muddy ground.)

■ Checking the steel crawler

1) Raise the machine with the implement and the safety blocks. To do this, operate the control lever slowly.

2) From a position that will be safe even if the machine should fall, measure the clearance between the bottom of the track frame and the upper surface of the shoe plate.

The tension is proper if the clearance is 5.91 to 6.30 in. (150 to 160 mm).

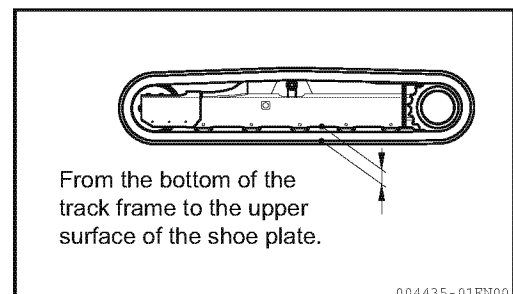
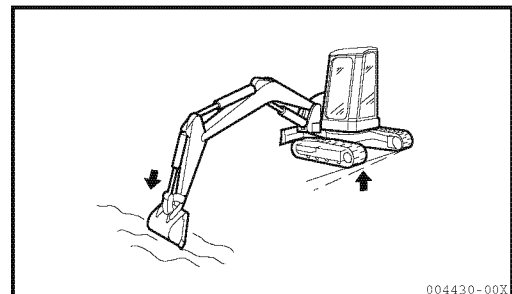

If the tension is improper, adjust it as follows:

■ **Adjusting the steel crawler tension**

• **To increase the tension**

Prepare a grease gun.

1) Remove the cover.

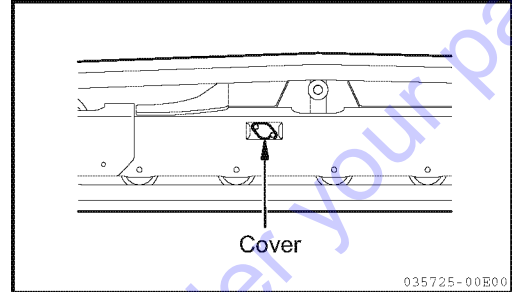

2) Raise the machine with the implement and the safety blocks. Inject grease from the nipple valve (1) with a grease gun until the steel crawler tension has achieved a clearance that is within the following range : 5.91 to 6.30 in. (150 to 160 mm).

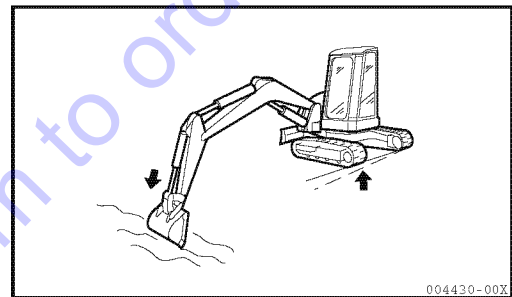

3) To check that the tension is proper, lower the machine and move the machine back and forth slightly.

4) Check the steel crawler tension again. If the tension is improper, adjust it again.

5) Install the cover.

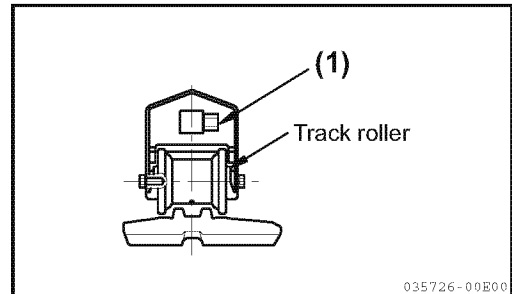

6) The tension can be adjusted until the clearance "a" is reduced to 0 in. (0 mm). If the tension is still loose after adjustment, the pin and the bushing should be replaced because they are probably worn excessively. Ask your dealer to repair the crawler.

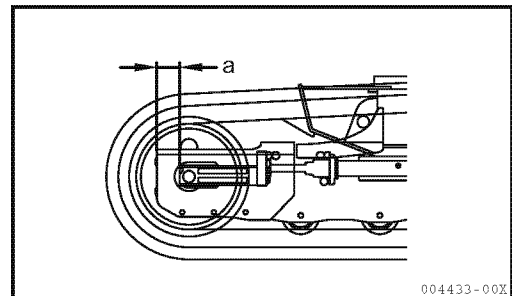

- Loosening the tension

⚠ WARNING

- Grease is under high pressure. If the nipple valve (1) is opened suddenly, grease could be ejected or the valve could blow, which could cause bodily injury.
- Do not rely on valve appearance alone to determine whether or not grease has been discharged, but check that by measuring the tension of the steel crawler.
Do not open the nipple valve (1) more than one turn.
- It is very dangerous to discharge the grease by any procedure other than that described below. If the tension of the steel crawler cannot be loosened, ask your dealer to repair the steel crawler.

- Remove the cover.
- Raise the machine with the implement and the safety blocks. Slowly loosen the nipple valve (1) and to discharge the grease to adjust the steel crawler tension and to achieve a clearance that is within the following range : 5.91 to 6.30 in. (150 to 160 mm).
- Never loosen the nipple valve (1) more than one turn. (If the grease is not discharging properly, lower the machine and move the machine back and forth slightly.)
- Tighten the nipple valve (1).
Tightening torque : 36.1 ft•lbf (49 N•m)
- To check that the tension is proper, put down the machine and move the machine back and forth slightly.
- Recheck the steel crawler tension and readjust it if necessary.
- Completely wipe away all of the discharged grease.
- Install the cover.

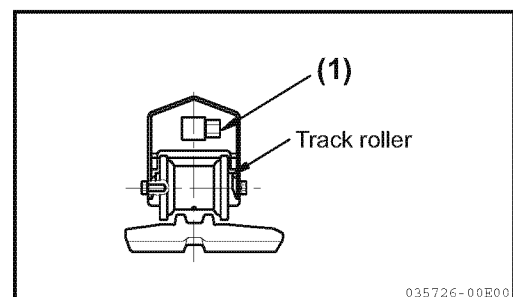
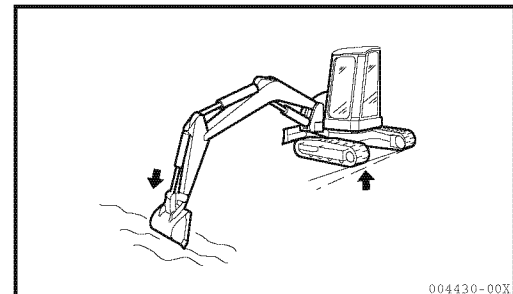
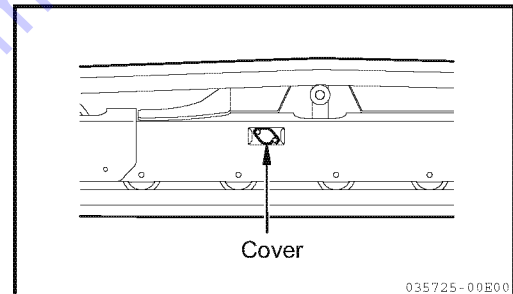

25-2-5. Replacing the bucket teeth

When the bucket teeth are worn, replace them in accordance with the following procedure:

⚠ WARNING

When replacing the bucket teeth, be careful not to move the implement by mistake, for safety reasons. Place the implement in a stable position, stop the engine, and securely lock the lock lever.

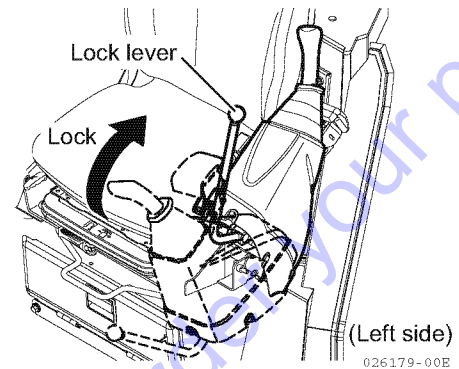

■ Replacing the point type teeth

Replace the point type teeth before they are worn down to the adapter.

- Position the bucket so that the bottom is level.
- To remove a point :

1) Strike out the locking pin (3) which connects the point type tooth (1) to the adapter (4), using a hammer and a pointed tool for easy removal.

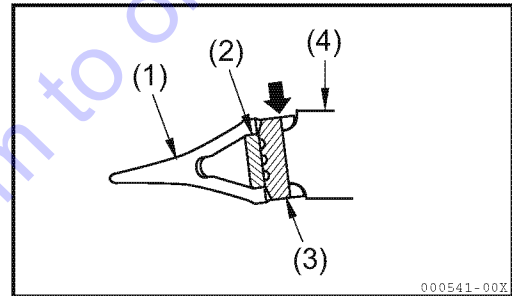

IMPORTANT

Do not strike the pin toward the rubber pin lock (2). Otherwise the rubber pin lock may be damaged. Strike the pin in the opposite direction.

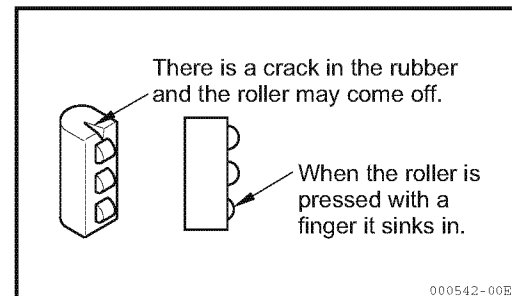

2) Remove the rubber pin lock (2).

3) Check the condition of the rubber pin lock (2) and locking pin (3).

Replace a damaged rubber pin lock or locking pin. Using a faulty rubber pin lock or locking pin may cause a point to come off during operation. Replace a rubber pin lock or a locking pin if the following faults are present :

- There is a crack in the rubber of the pin lock, as the roller may come off.
- When the roller is pressed with a finger, it sinks into the rubber.
- The locking pin is too short.

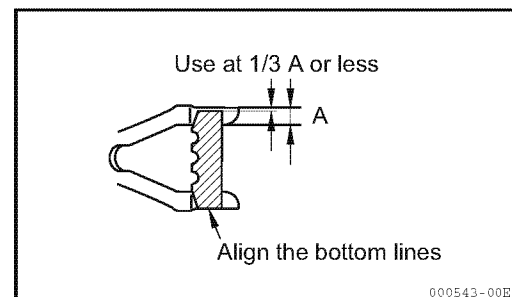

- 4) Clean the surface of adapter (4) with a putty knife to remove any hard mud on it.
- 5) Press-fit the rubber pin lock (2) into the hole of adapter (4) by hand or with a hammer.

IMPORTANT

Do not let the rubber pin lock extend beyond the adapter surface.

- 6) Fit the point (1) onto adapter (4) and check that the rear surface of the pin bore of the point is aligned with the rear surface of the pin bore in the adapter when the point is pressed firmly.

IMPORTANT

If the rear surface of the pin bore of the point (1) is in front of the rear surface of the pin bore in adapter (4), do not strike locking pin (3).

- 7) Press-fit locking pin (3) in the pin hole of point (1) so that the upper end of the locking pin is flush with the surface of the point.

- Replace the rubber pin lock and the locking pin with new ones when replacing a point, to prevent the point from coming off.

■ Replacing the side cutter

Delay in replacing the side cutter could damage the bucket. Replace the side cutter before the bucket is damaged.

Tightening torque :

651.01 to 795.65 ft•lbf (882.6 to 1078.7 N•m)

Screw lock agent : Loctite 262

- Replace the bolts, nuts and spring washers when replacing the side cutter.

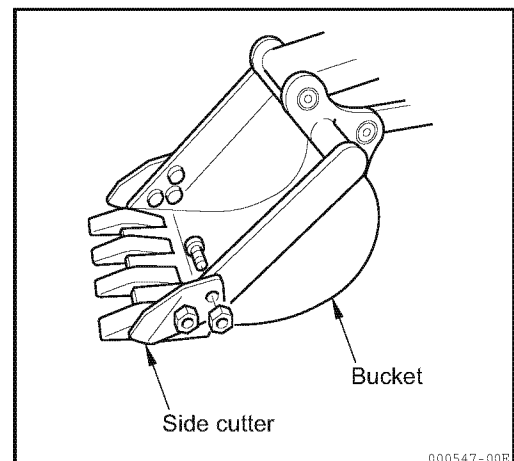
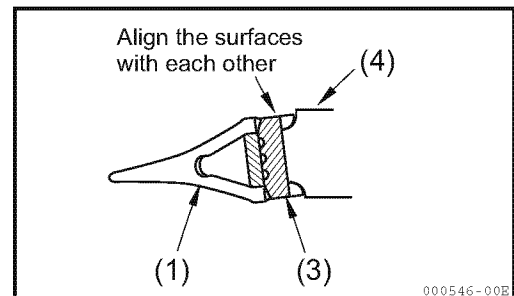
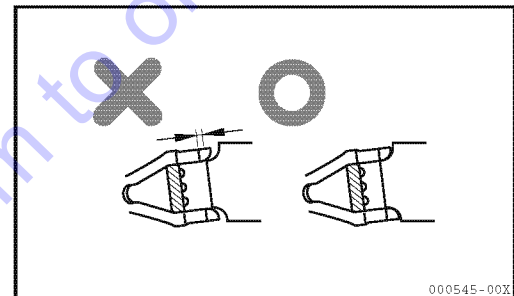
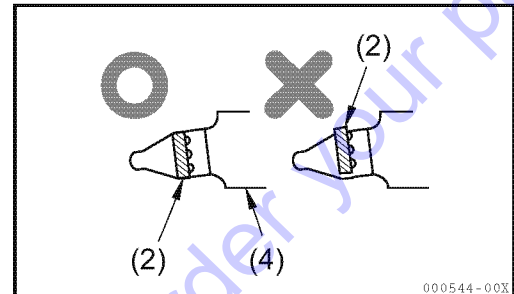

25-2-6. Cleaning the inside of the cooling system

⚠ WARNING

- The cooling water is very hot immediately after the engine has stopped. Discharging the cooling water immediately after the engine has stopped may cause burns. Start cleaning the inside of the cooling system after the engine has cooled down sufficiently.
- Stepping into the area behind the machine to clean the inside of the cooling system while the engine is running is very dangerous, because you may not be visible from the operator's seat and the machine could start moving.

Also, with the engine hood being open, contacting the radiator fan or fan belt could result in serious bodily injury.

Never step into the area behind the machine while the engine is running.

- Do not remove the radiator cap while the water temperature in the radiator is high. Hot water may spout from the radiator.

When you do remove the radiator cap after the water has cooled down, slowly turn the radiator cap to relieve the internal pressure before removing it.

Clean the inside of the cooling system and replace the anti-freeze according to the following table.

Anti-freeze type	Cleaning inside of cooling system and replacing anti-freeze
YANMAR Super Long-Life Coolant (LLC anti-freeze) (All season type for anticorrosion)	Every 2 years (autumn)
LLC anti-freeze (all season type)	Every 1 year (autumn)
AF-PT anti-freeze (winter, one season type)	Every 6 months (spring, autumn) Add anti-freeze only in autumn
No anti-freeze	Every 6 months

Park the machine on level ground to clean or replace the cooling water.

The YANMAR Long-Life Coolant has anticorrosive effect as well as anti-freeze effect.

Though the mixing ratio of an anti-freeze to water differs with air temperature, at least 30% of anti-freeze by volume is required to obtain anticorrosive effect.

Determine the mixing ratio of the anti-freeze to water on the basis of the lowest past temperature, referring to the ratio table on the next page.

Actually set the temperature 18°F (10°C) lower than the lowest temperature.

Table of mixing ratio of anti-freeze to water

Lowest temperature		°F (°C)	23 (-5)	14 (-10)	5 (-15)	-4 (-20)	-13 (-25)	-22 (-30)	-31 (-35)	-40 (-40)
ViO80	Amount of anti-freeze	Qts. (L)	1.43 (1.4)	2.38 (2.3)	2.85 (2.7)	3.33 (3.2)	3.80 (3.6)	4.28 (4.1)	4.75 (4.5)	5.23 (5.0)
	Amount of water	Qts. (L)	8.07 (7.6)	7.12 (6.7)	6.65 (6.3)	6.17 (5.8)	5.70 (5.4)	5.22 (4.9)	4.75 (5.2)	4.27 (4.0)

Note :

At the delivery from the factory, water and anti-freeze are mixed in the ratio shown above for the -31°F (-35°C) temperature.

DANGER

Keep sources of ignition away from the antifreeze because it is flammable.

Use tap water. If you obtain water from a river, a well or a small water-supply system, consult your dealer.

Use a densitometer to control the mixing ratio.

WARNING

When removing the drain plug, be careful that the anti-freeze does not contact your eyes or skin.

■ How to clean the inside of the cooling system

■ Things to prepare

- Container for cooling water
Capacity (with sub-tank capacity) : 9.5 Qts. (9 L) or more

- Hose for supplying the water

- 1) Swing the upper structure so that the drain plug is positioned in the middle of the right and left crawlers.
- 2) Put the container for cooling water under the drain plug.
- 3) Remove the cover, slowly remove the radiator cap, pour in the washing agent and mount the cap.

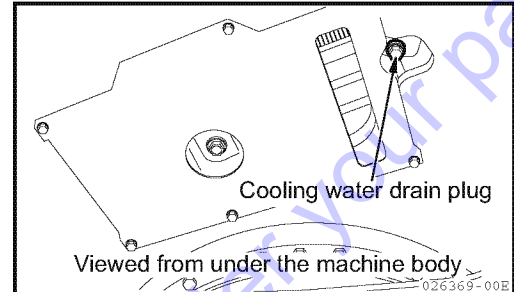

IMPORTANT

Washing methods vary depending on the manufacturer of the washing agent.

Follow the instructions of the manufacturer.

- 4) Start the engine until the water temperature rises to 176 °F (80°C) or more and idle the engine for 10 to 15 minutes. Then stop the engine.
- 5) After the engine has cooled down, slowly loosen the drain plug to drain the water, and remove the radiator cap.
When the drain plug is removed, the water in the radiator is completely discharged.
- 6) After the water is completely discharged, reinstall the drain plug and pour tap water into the water supply port of the radiator.
- 7) When the cooling system is filled with water, remove the drain plug, idle the engine and flush the cooling system with running water until clean water comes out.
While flushing with running water, always keep the cooling system completely filled with water by regulating the amounts of water to be drained out and poured in.
Hold the water supply hose securely while flushing with running water.

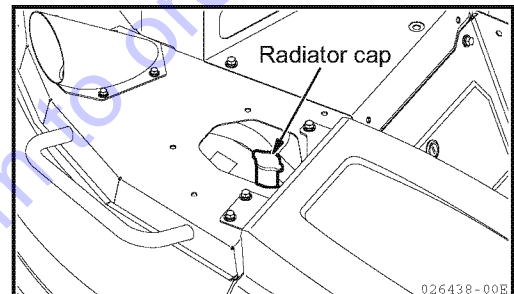

- 8) After flushing with running water, stop the engine, drain the cooling system completely and then install the drain plug.
- 9) Pour water mixed with anti-freeze into the water supply port of the radiator, to fill it up.
- 10) To bleed air, idle the engine for 5 to 6 minutes and then run the engine without load at high speed for 5 to 6 minutes. (While running the engine, keep the radiator cap removed.)
- 11) Approximately 5 minutes after stopping the engine, pour water mixed with anti-freeze up to the water supply port of the radiator, and install and tighten the cap.
- 12) Drain the cooling water from the sub-tank (1), wash the inside of the sub-tank (1) and pour water mixed with anti-freeze up to the "FULL" level.

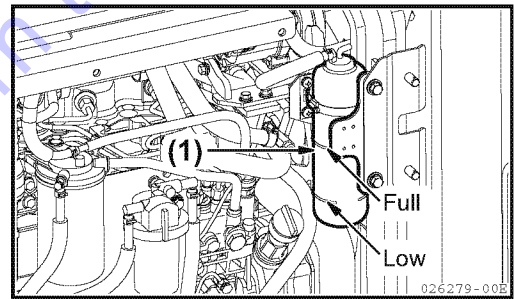

25-2-7. Maintenance, inspection and servicing of air conditioner

Daily maintenance and periodic inspection and servicing are required for the air conditioner to use it comfortably in the best condition.

Proper maintenance allows reduction in trouble and longer life of the air conditioner.

Exact inspection and servicing prevent trouble and reduce the cost for repair.

The air conditioner should also be checked and serviced at the time of a voluntary monthly inspection and a prescribed annual inspection of the machine.

It is recommended that the rubber hoses and electrical wires should be replaced every two years to use the air conditioner in the best condition.

List of inspection items for air conditioner

	Part	Check item	Servicing
Daily inspection (during season)	Filter	Check the filter for clogging.	Clean
	Condenser	Check the cover and the fin for contamination and clogging.	Clean
	Compressor driving belt	Check the belt for tension and damage.	Repair or replace
	Sight glass	Check the refrigerant quantity.	

■ **Replacing the filter**

- 1) Grab the knobs of the filter and pull it out to this side.
- 2) Blow off the clogged dirt or the like with compressed air or wash it off with water.
- 3) Reinstall the cleaned filter.

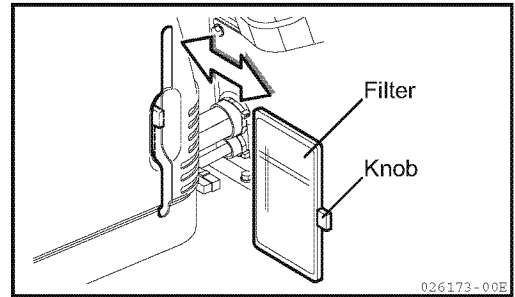

■ Checking and cleaning condenser

⚠ WARNING

- Be sure to stop the engine and remove the starter switch key before checking and servicing the condenser.
- Be sure to reinstall the cover and other parts, which have been removed for checking and servicing, to their original positions after completion of the work.

Check the condenser cover. If there is any mud or dirt on the cover, then remove the cover to wash it off with water.

- If there is some mud or dirt on the condenser fin, it will cause degradation of the air conditioner performance. Wash it off from the fin with water, using a soft brush.
- If the condenser fin is crushed or deformed, it will also cause degradation of the air conditioner performance. Repair it with a screwdriver or the like, taking care not to damage the condenser fin.

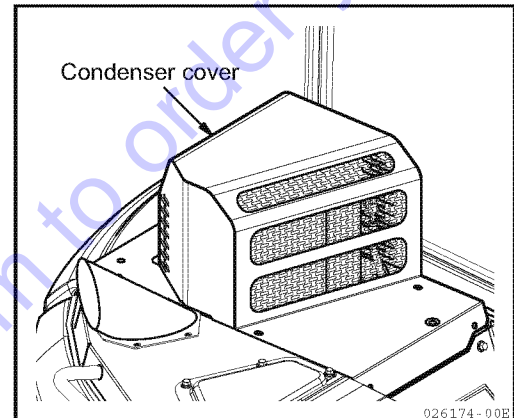

■ Checking and servicing compressor driving belt

⚠ WARNING

Stop the engine and remove the starter switch key before checking and servicing the compressor driving belt.

Press the compressor driving belt in the middle to check the slack of the compressor driving belt.

Driving belt

Pressing force : Approximately 22.05 lbs. (98.1 N)

Correct slack : 0.91 to 0.94 in. (23 to 24 mm)

If the slack of the belt is not correct, adjust it according to the following procedure :

- 1) Open the cover and press the belt in the middle with a force of approximately 22.05 lbs. (98.1 N). Adjust the belt tension by loosening the tension pulley bolt and applying a wrench or the like to the protruding portion of bracket so that the slack of the belt will be correct.

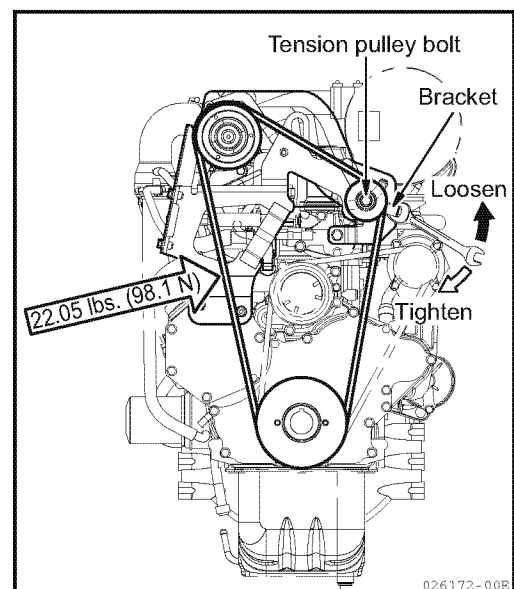
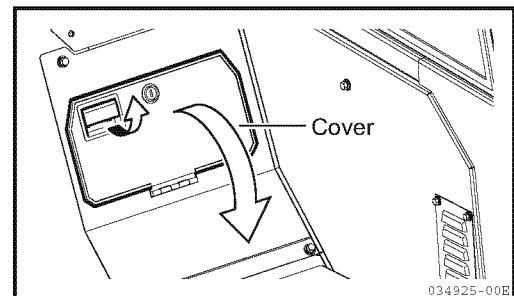

25. Procedures for Maintenance

- If the belt tension cannot be adjusted to the specified slack because the belt has lost its elasticity, replace the belt with a new one.
- 2) Tighten the tension pulley bolt.
 - 3) Check whether each pulley or the belt is damaged, especially whether the belt is in contact with the bottom of the pulley groove.
- If there are any cuts on the belt or cracks in it, replace it with a new one.

Compressor driving belt :

Mitsubishi Rawedge moulded cogged V-belt

RECMF-1600 or its equivalent

Yanmar part number : 172A69-18190

■ Checking the refrigerant quantity

Through the top of the condenser cover, observe the flow of the refrigerant air bubble from the sight glass (inspection window) of the liquid tank according to the following procedure to check the refrigerant quantity.



- 1) Start the engine and run it at the maximum speed.
- 2) Set the fan switch at the High level.
- 3) Set the temperature control lever to the COOL position.
(The top position.)
- 4) Turn the air conditioner switch ON. (The lamp goes on.)
- 5) Check the refrigerant condition from the sight glass and compare it with the check list shown below.

IMPORTANT

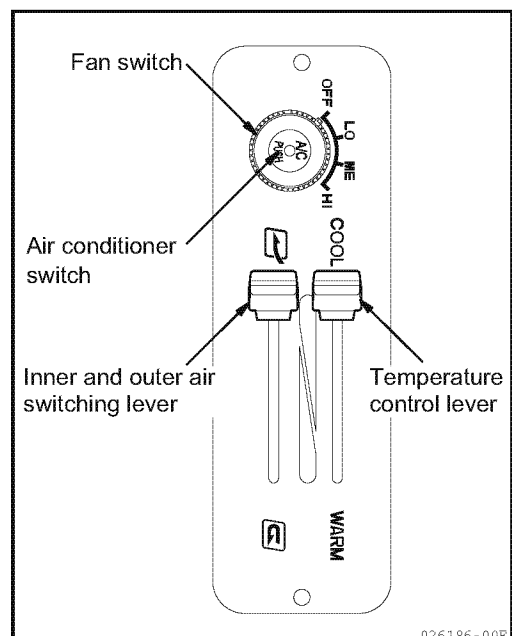
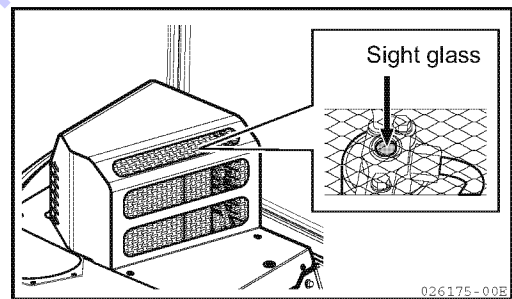
If the refrigerant quantity is not normal, ask your dealer for check and repair.

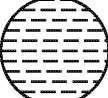
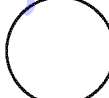

Check list for the refrigerant quantity

Air conditioner condition	Normal	Abnormal		
Temperatures of high and low pressure pipes	Temperature difference is big. High pressure pipe : hot Low pressure pipe : cold Compressor discharge side temperature : 158°F (70°C) Compressor intake side temperature : 41°F (5°C)	High pressure pipe is warm and low pressure pipe is rather cool. Temperature difference is not so big.	There is almost no difference in temperature between high and low pressure pipes.	High pressure pipe is hot and low pressure pipe is rather warm. There is some difference in temperature between them.
Sight glass	Almost transparent. Even if air bubble flow is seen, it becomes transparent as the engine speed changes.  001312-00X *1	Air bubble flow is always seen. It is sometimes transparent or white.  001313-00X	Flow of mist or the like is seen slightly.  001314-00X	No air bubble flow is seen even cabin windows, idling engine, and rotating fan to the maximum.  001315-00X *2
Pipe connection	Normal	Some parts are contaminated by oil.	Some parts are badly contaminated by oil.	Normal
Refrigerant quantity	Refrigerant quantity is adequate and normal.	Refrigerant might leak in a small amount from some part.	Almost all refrigerant leaks and does not remain.	Refrigerant quantity is too large.

*1 : When the outside air temperature is low, air bubble might be seen even if the refrigerant quantity is adequate.

*2 : When there is no refrigerant, no air bubble is seen, either. Therefore, be sure to check the difference in temperature between the high and low pressure pipes.

Go to Discount-Equipment.com to order car parts

25-3. Checking before start-up

Check the items described here every day, before starting the engine for the first time.

25-3-1. Checking and replenishing the cooling water

⚠ WARNING

**Normally do not open the radiator cap.
Check the cooling water in the sub-tank when the
engine is cool.**

1) Open the engine hood to check to see that the cooling water level is between the FULL and LOW marks on the sub-tank (1) (illustrated at the right). If the cooling water level is low, add cooling water to the FULL mark through the port of the sub-tank (1). For the cooling water to be used, refer to Section "21. Fueling, Oiling and Greasing Based on Temperature Range".

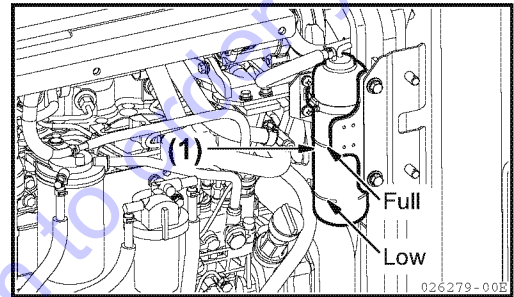

- 2) Securely close the cap after replenishing.
- 3) If the sub-tank is empty, check the sub-tank for leaks and then check the cooling water level in the radiator. If the cooling water is insufficient, refill the radiator and then the sub-tank with cooling water.
- 4) If the cooling water level is proper, close the engine hood.

25-3-2. Checking and replenishing the engine oil

⚠ WARNING

- At operating temperature, the oil and dipstick areas are hot.
 - Do not allow hot oil or hot components to contact the skin, to prevent bodily injury.
- Check oil level and replenish oil after engine has cooled down sufficiently.

- 1) Open the engine hood.
- 2) Pull out the oil dipstick (G) and wipe oil off with a cloth.
- 3) Insert the oil dipstick (G) fully again and pull it out.
- 4) Check that the oil level is above the midpoint between the upper and lower limit marks (H and L).
Open the cap of the oil supply port (F) and replenish oil if the oil level is below the midpoint.
See Section "21. Fueling, Oiling and Greasing Based on Temperature Range" for the engine oil to be used.
- 5) If the engine oil level is above the H mark, drain the excess engine oil through the drain plug (P), and check the engine oil level again.
- 6) If the engine oil level is proper, securely close the port cap and close the engine hood.

Note :

When checking the engine oil level after the engine has been running, stop the engine and wait at least 15 minutes before checking.

If the machine is on an incline, make it level before checking the engine oil level.

Do not discard the excess engine oil onto the ground or the road.

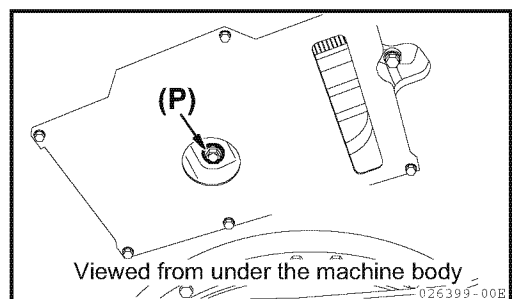
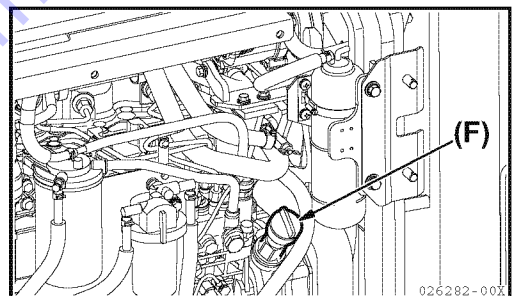
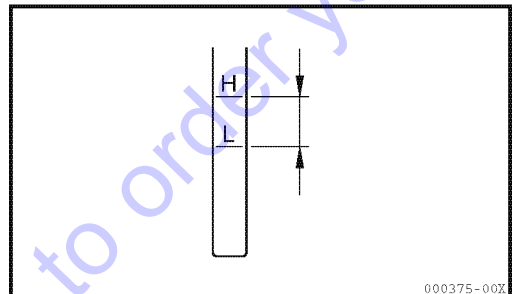
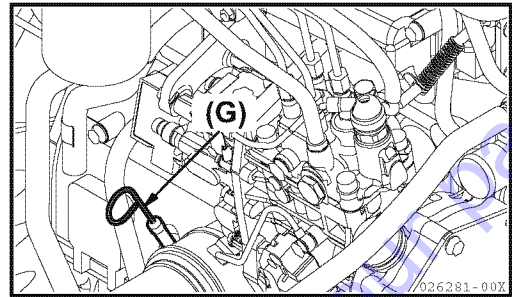

25-3-3. Checking and replenishing the fuel in the fuel tank

⚠ WARNING

Be careful not to overfill the fuel tank because it could cause a fire. If the fuel tank is overfilled, completely wipe off the spilled fuel.

⚠ CAUTION

- Do not remove the strainer from the fuel supply port of the fuel tank when supplying fuel.
- Be careful not to allow any water that may be in the fuel container or dirt on the refueling equipment to enter the fuel tank.

1) Turn the starter switch key to the "ON" position and check the fuel level with the fuel gauge. Add necessary fuel through the fuel supply port.

When the fuel meter pointer is at "E", approximately 6.9 Gals. (26 L) of fuel is left in the tank.

Fuel tank capacity : 30.4 Gals. (115 L)

See Section "21. Fueling, Oiling and Greasing Based on Temperature Range" for the fuel to be used.

2) After refueling, securely retighten the fuel port cap.

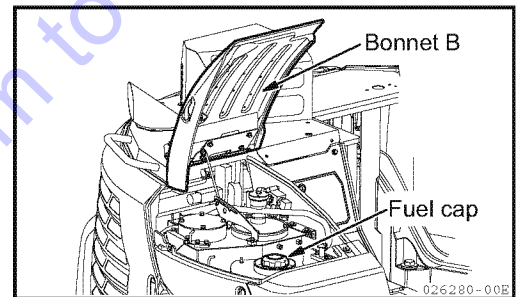
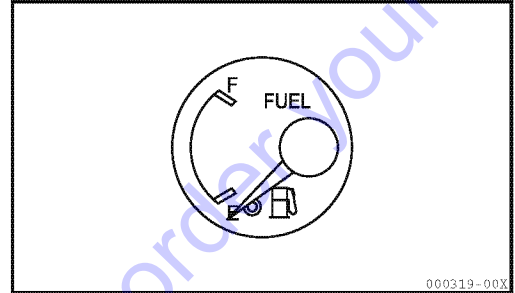

25-3-4. Checking and replenishing the hydraulic oil in the hydraulic oil tank

⚠ WARNING

When removing the plug of the oil supply port, slowly loosen it to gradually relieve the internal pressure in the tank, or oil may spurt from the tank.

- 1) Park the machine as illustrated in the figure at the right. If the machine is not in that posture, start the engine, retract the bucket and arm cylinders to their stroke ends at low speed, lower the boom until the bucket teeth are put on the ground, lower the blade to the ground, and stop the engine.
- 2) Open the bonnet B.
- 3) Check the oil level with the oil level gauge. Check that the oil level is between the upper and lower limit marks, which is a proper level.

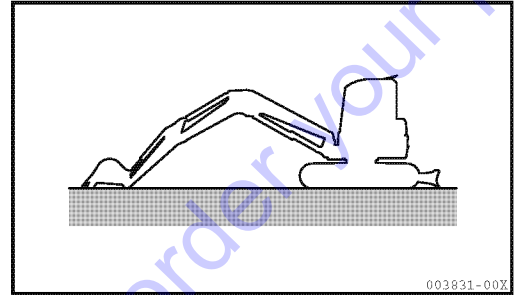
**IMPORTANT**

Do not replenish hydraulic oil above the upper limit mark on the oil level gauge. An excessive amount of hydraulic oil may damage the hydraulic system by placing stress on its components, causing a dangerous high-pressure leak.

- 4) Add oil to the oil supply port if the oil level is below the lower limit. See Section "21. Fueling, Oiling and Greasing Based on Temperature Range" for the hydraulic oil to be used.

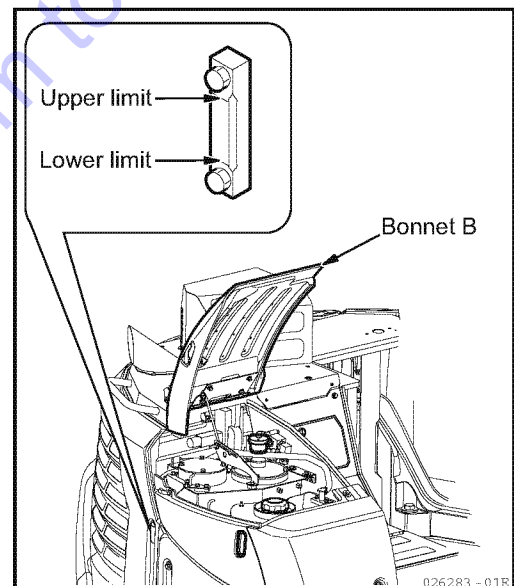
**Note :**

As the oil level differs with the oil temperature, check the oil level by referring to the following guidelines:

- Before start-up : Near the middle of the oil level gauge [oil temperature 50 to 86°F (10 to 30°C)]
- During normal operation : Near the upper limit of the oil level gauge [oil temperature 122 to 176°F (50 to 80°C)]

25-3-5. Checking and adjusting the fan belt tension

⚠ WARNING

- Stop the engine, take out the starter switch key, and attach the "SERVICING IN PROGRESS" tag to a control lever.
- The fan belt is hot immediately after the engine is stopped.
Do not adjust the fan belt tension immediately after stopping the engine.
- Adjust the fan belt tension after all of the parts of the engine have cooled sufficiently.

Adjustment

- Prepare the wooden bar (the handle of a hammer or the like)
 - 1) Open the cover (1).
 - 2) Loosen the generator (2) mounting bolt (3).
 - 3) Loosen the lock nut (4) of the adjuster.
 - 4) Turn the adjuster bolt (5) and move the generator (2) so that the generator fan belt will be slacked approximately 0.4 to 0.6 in. (10 to 15 mm) with a pressing load of 72.3 ft•lbf (98.1 N•m).
 - 5) Retighten the mounting bolt (3) to secure the generator (2).
 - 6) Retighten the lock nut (4) of the adjuster.
 - 7) Check the pulleys, the V-groove, and the fan belt (6) for damage, and check to see that the fan belt (6) does not touch the bottom of the V-groove.
 - 8) If the fan belt (6) cannot be adjusted since it has lost its elasticity or if it is damaged or cracked, replace the fan belt (6) with a new one.

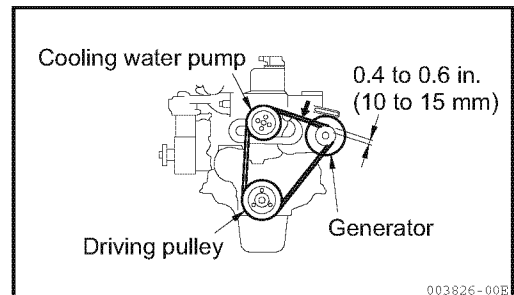
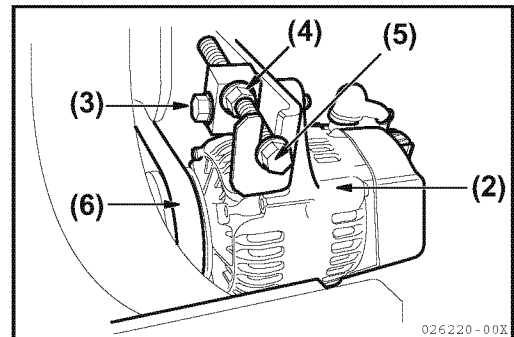
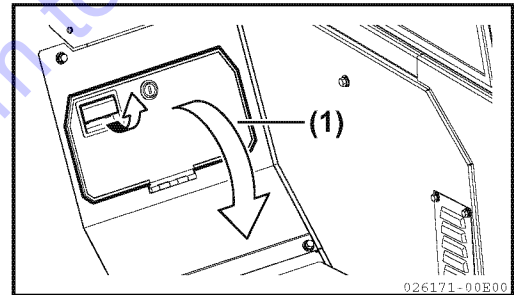
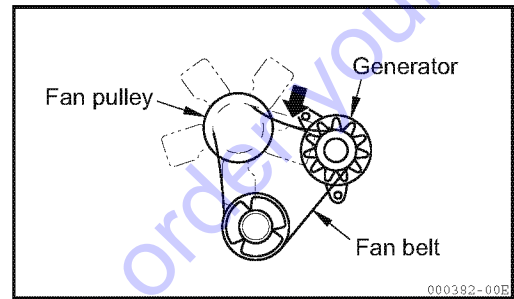

[Fan belt size] (Inch)

	Size
Fan belt	A42.5

25-3-6. Checking and replenishing the battery electrolyte

⚠ DANGER

- The battery generates flammable gas and can cause a fire and an explosion.
Keep sparks, flames and lit cigarettes away from the battery.
- Battery electrolyte is strong acid. To avoid serious injury, do not allow the electrolyte to contact your skin or splash into your eyes.
- Always wear safety goggles and protective clothing, when adding electrolyte.
- Do not use the machine with the battery which is short of battery electrolyte. The shortage of battery electrolyte not only will reduce the life of the battery but also could cause an explosion.

- 1) Open the bonnet R to check the electrolyte level. The level must be between the upper and lower level marks.
- 2) If the electrolyte level is lower than the lower level mark, replenish it.

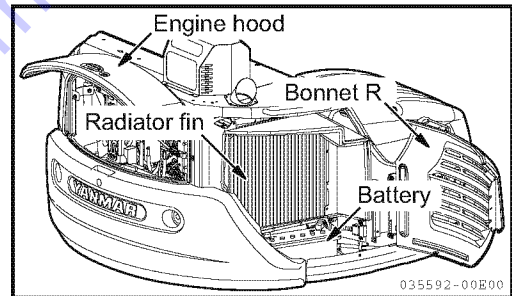

25-3-7. Greasing

IMPORTANT

Grease the fittings thoroughly after washing the machine or after operation in rain, on soft ground, or in muddy water.

- 1) Put the bucket and the blade on the ground and stop the engine.
- 2) Clean the grease nipples indicated by arrows in the figures on the right, and grease them with a grease gun.
- 3) After greasing, wipe off any excess that remains.

■ Implement

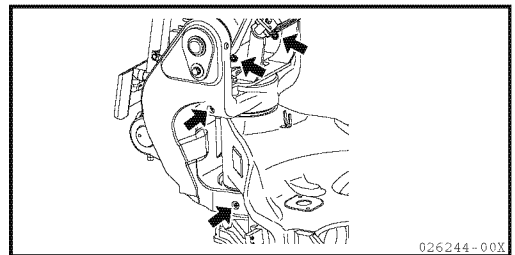
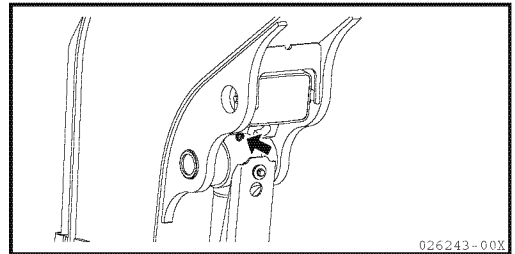
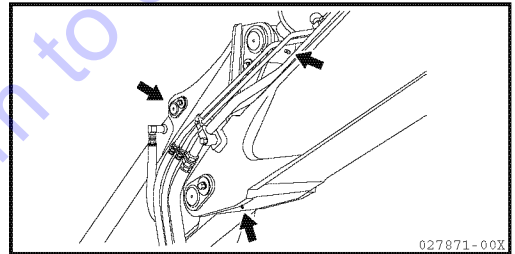
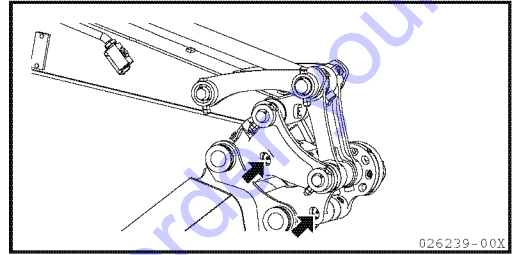
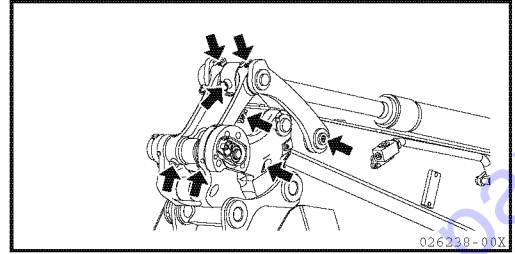

■ Blade

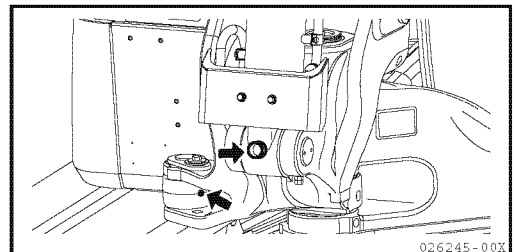
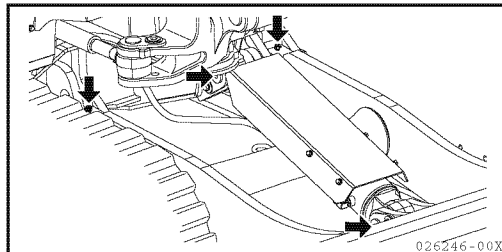

25-3-8. Checking the electrical equipment

⚠ CAUTION

If a fuse blows out frequently, contact your dealer for assistance.

Check the fuses for damage, the wiring for poor connections or short circuits, and the battery terminals for corrosion and loose connections. Take corrective action.

Check the following items after the starter switch is turned to the "ON" position.

- 1) Check the monitor function
 - Check the fuel meter, water temperature meter, and hour meter.
 - Check the engine oil pressure alarm lamp, charge alarm lamp, water temperature alarm lamp, engine trouble monitor lamp and auto-deceleration indicator lamp.

- 2) Check that all switches function correctly and all lamps light correctly.
 - Horn
 - Travel alarm
 - Lighting of the cabin light and the boom light
 - Operation of the wiper (for cabin)
 - Light of the room lamp (for cabin)
 - Air conditioner (for cabin)
 - Activation of auto-deceleration
 - Activation of eco mode

25-4. Maintenance every 50 service hours

25-4-1. Greasing the swing gear and the swing bearing

! WARNING

Do not swing the upperstructure while greasing.
Swing the upperstructure after each stage of greasing is completed to avoid serious bodily injury.

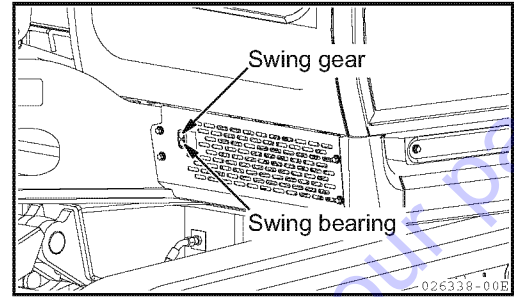

- 1) Grease the swing gear and bearing through the grease nipples indicated with arrows in the figure at the right, using a grease gun.
- 2) Swing the upperstructure in small increments and grease after each stop, until the upperstructure has made a full revolution.

25-4-2. Draining the water and deposits in the fuel tank

! WARNING

Keep sparks, flames and lit cigarettes away.

■ Things to prepare

- Container for fuel waste
- 1) Swing the upperstructure so that the drain plug under the fuel tank is positioned in the middle of the right and left crawlers.
 - 2) Loosen the bolts to move the under cover in the direction of an arrow.
 - 3) Put the container for fuel waste under the hose for the drain cock.
 - 4) Open the drain cock to discharge the water and dirt deposits in the fuel tank.
Take care that the fuel does not contact your body.
 - 5) When clean fuel starts coming out, close the drain cock and close the under cover.

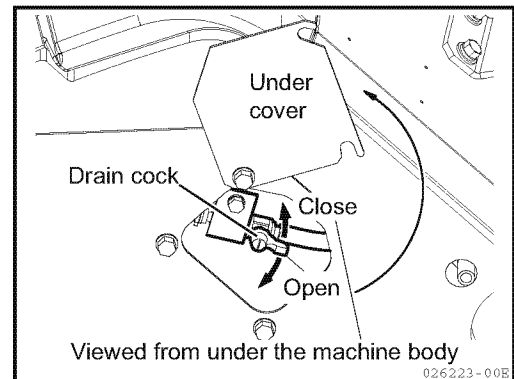

25-4-3. Cleaning the water separator element

⚠ WARNING

- Keep sparks, flames and lit cigarettes away.
- At operating temperature, the engine components are hot and can cause a burn.
- Disconnect the battery and replace the element after the engine has cooled sufficiently.
- Fuel leaked or spilled onto hot surfaces or electrical components could cause a fire.
- Drain the fuel from the water separator into a container before removing the water separator retainer ring.

■ Things to prepare

- Container for fuel waste

- 1) Open the engine hood.
- 2) Place the container for fuel waste under the water separator.
- 3) After setting the water separator cock to the closed position, loosen the retainer ring to remove the cup and drain the water from the cup.
Do not lose the red ring in the cup.
- 4) Remove the element and clean it and the inside of the cup, using light oil or a washing agent.
- 5) Check the O-ring and if it is damaged or deformed, replace it with a new one.
- 6) Install the element and the cup and turn the cock to the open position.
- 7) Close the engine hood.

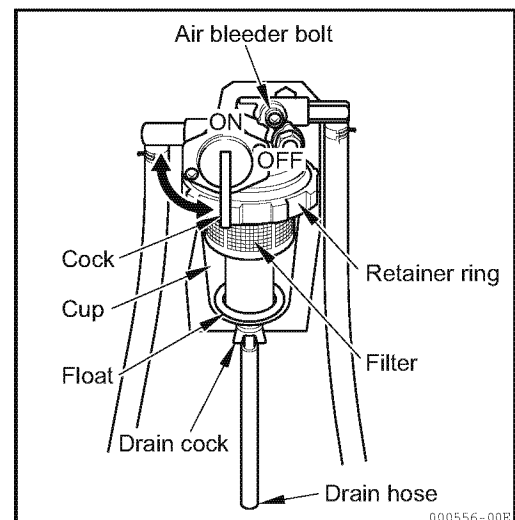
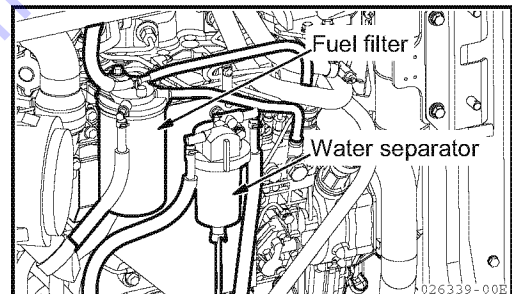
**25-5. Maintenance every 100 service hours**

Perform the same maintenance as indicated for every 50 service hours.

25-6. Maintenance every 250 service hours

Also perform the maintenance every 50 service hours.

25-6-1. Replacing the engine oil and the engine oil filter element

⚠ WARNING

- Do not replace the oil immediately after the engine stops to prevent bodily injury, because all the components are hot.
- Do not allow hot oil or components to contact skin.
- Replace the oil and the filter element after the oil and the components have cooled sufficiently.

■ Things to prepare

- Replacement new oil and container for waste oil

Model	Amount of oil	Container
ViO80	11.10 Qts. (10.5 L)	11.10 Qts. (10.5 L)

- Filter wrench for engine oil filter cartridge
- 1) Swing the upperstructure so that the drain plug (P) on the bottom of the engine is positioned in the middle of the right and left crawlers.
 - 2) Put the container for waste oil under the drain plug (P) on the bottom of the machine body.
 - 3) Slowly remove the drain plug (P) so that the oil should not splash on you and drain the waste oil.
 - 4) Check the waste oil, and contact your dealer if any metallic particles or foreign objects are mixed in it.
 - 5) Reinstall the drain plug (P).
 - 6) Turn the oil filter cartridge counterclockwise with the filter wrench to remove it.
After removing the oil filter, wait 10 to 15 minutes before replacing it.
 - 7) Wipe the dirt and oil from the filter mount and apply engine oil (or apply grease lightly) to the seal surface of a new oil filter (cartridge).

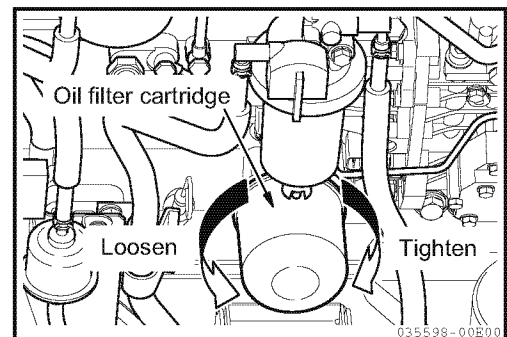
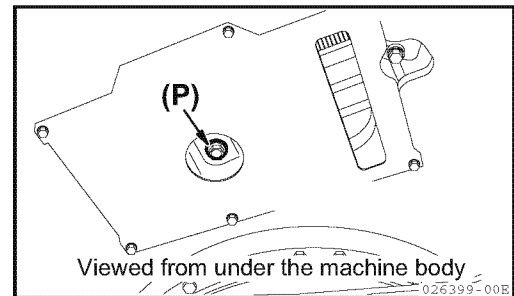

8) When mounting the new filter (cartridge), turn it 2/3 of a turn after the seal surface has contacted the filter mount.

9) After replacing the oil filter (cartridge), add engine oil up to the upper limit (H) mark on the oil dipstick through the oil supply port (F).

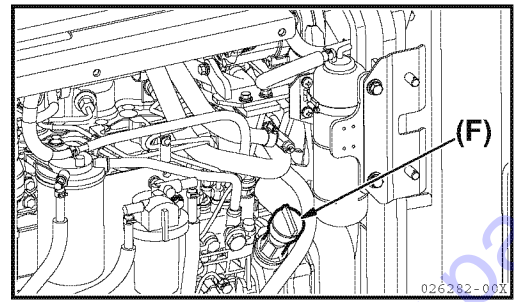

10) Idle the engine for several minutes and then stop the engine. Then check that the oil level exceeds the mid-point between the upper and lower limit marks on the oil dipstick.

Refer to Section "25-3. Checking before start-up".

11) Install and tighten the oil supply port cap securely.

Replace the engine oil and the oil filter element 6 months after the previous replacement, even if the service hours have not reached 250 hours.

Also replace them at 250 service hours, even if 6 months have not elapsed since the previous replacement.

Go to Discount-Equipment.com to order your parts

25-6-2. Checking and cleaning the air cleaner

⚠ WARNING

- Never attempt to clean and replace the air cleaner while the engine is running.
Always stop the engine and allow it to cool first.
- Compressed air is used to clean the element. Always wear safety goggles to prevent injury to your eyes.
- The maximum compressed air pressure should be less than 100 PSI (0.7 MPa) for cleaning purposes.

■ Cleaning procedure for element

- 1) Open the engine hood.
- 2) Remove the clips and remove the cover.
- 3) Remove the element.
Cover the connector side at the back of the air cleaner body using a clean cloth and tape to prevent dirt from entering.
- 4) Clean the cover and the inside of the body.
- 5) Blow the dry, compressed air [100 PSI (0.7 MPa) or less] from inside the element along the pleats to initially remove the dirt. Then blow compressed air from outside the element along the pleats to remove dirt. Blow compressed air again from inside the element, to complete the dirt removal.

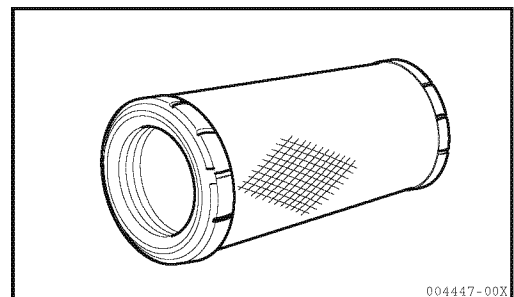
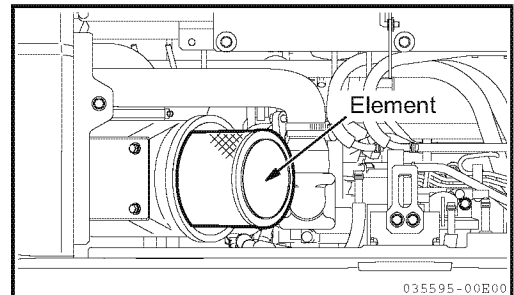
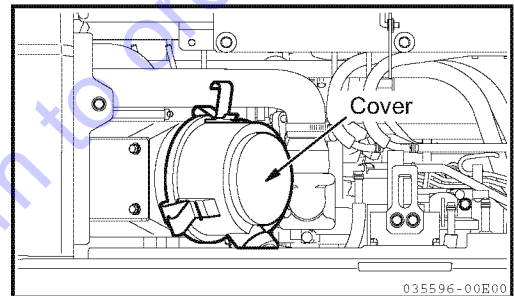

- 6) After cleaning, illuminate the element from inside with a light bulb and check it. If there are any small holes or thin areas, replace the element with a new one.

IMPORTANT

- **When cleaning the element, do not tap it or strike it against other objects. Otherwise the element may be damaged.**
- **Do not reuse the element if the pleat, gasket or seal is damaged.**
- **Replacement elements should be wrapped in clean paper and stored in a dry place.**

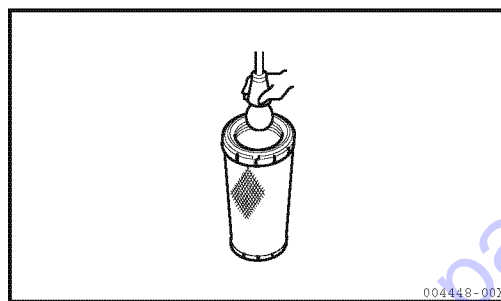

- 7) Remove the protective cloth and tape used to cover the air cleaner body.
- 8) Insert the newly-cleaned element.
- 9) Install the cover, using the arrow mark on it, to confirm proper alignment.
- 10) Close the engine hood.

Go to Discount-Equipment.com to order your parts

25-6-3. Checking and replenishing the lube oil for the travel reduction gearbox

⚠ WARNING

- The gear oil and casing of the reduction gearbox are hot immediately after ceasing machine operation and can cause bodily injury. Do not allow hot oil or the gearbox to contact your skin. Replace oil after the oil and the gearbox have cooled sufficiently, if necessary.
- At operating temperature, the reduction gearbox is hot and its contents are under pressure. In such condition, the oil or a plug may be ejected violently, causing bodily injury. Remove a plug slowly to gradually relieve the residual pressure.

■ Things to prepare

- Container for oil
 - Oil jug
- 1) Position the machine so that the drain port will be in the lowest position, as illustrated in the figure at the right.
 - 2) Place the container for oil under the level port.
 - 3) Remove the level port plug using a hexagon wrench check that the oil level reaches the lower end of the level port.
 - 4) When the oil quantity is insufficient, remove the oil supply port plug and replenish gear oil through the oil supply port until gear oil overflows from the level port. Refer to Section "21. Fueling, Oiling and Greasing Based on Temperature Range" for the oil to be used.
 - 5) Install the plug.
Tightening torque : 16.67 to 20.28 ft•lbf
(22.6 to 27.5 N•m)

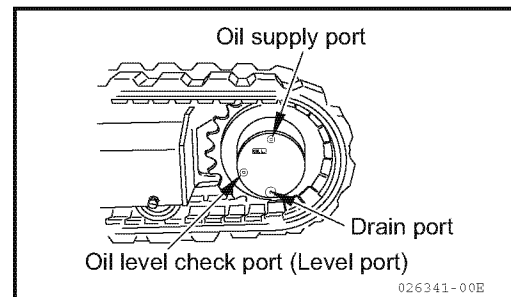

25-6-4. Checking and cleaning the radiator fin

⚠ WARNING

- Never attempt to check and clean the radiator fin while the engine is running.
Always stop the engine and allow it to cool first, before checking and cleaning it.
- Compressed air can cause bodily injury since the objects around the radiator fin may scatter.
- Whenever using compressed air for cleaning, check that there are no other persons nearby, and always wear safety goggles and protective clothing and shoes.
- The maximum compressed air pressure should be less than 100 PSI (0.7 MPa) for cleaning purposes.

- 1) Open the engine hood before opening the bonnet R.
- 2) Clean off any mud, dirt or leaves clogged in the radiator fin by blowing compressed air or by flushing with steam.

IMPORTANT

- Always blow the compressed air away from the fin to prevent damage to the fin.
 - A damaged fin will cause water leakage and overheating.
- 3) Check that the radiator fins are straight and that all the dirt has been removed completely.
 - 4) Close the bonnet R before closing the engine hood.

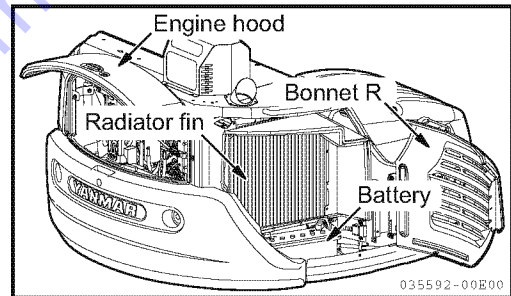

25-7. Maintenance every 500 service hours

Also perform the maintenance every 50, 100, and 250 service hours.

25-7-1. Replacing the fuel filter element

⚠ WARNING

- Keep sparks, flames and lit cigarettes away.
- At operating temperature, the engine components are hot and can cause a burn.
- Replace the element after the engine has cooled sufficiently.
- Fuel leaked or spilled onto hot surfaces or electrical components could cause a fire.
- Drain the fuel from the fuel filter into a container before removing the fuel filter.

■ Things to prepare

- Container for fuel waste
- Filter wrench for fuel filter cartridge

- 1) Open the engine hood.
- 2) Place the container for fuel waste under the fuel filter.
- 3) Turn the fuel filter cartridge counterclockwise with the filter wrench to remove it.
- 4) Clean the filter mount and apply engine oil to the seal surface of a new fuel filter, then mount the filter. At that time, fill the with fuel.
- 5) After replacing the fuel filter element, release air.
(Refer to page 3-58.)
- 6) After air release, start the engine and check for fuel leak.
If the there is nothing wrong, stop the engine and close the engine hood.

IMPORTANT

So that the filter cartridge should not be too tightened, turn it lightly until the seal surface contacts with the filter mount, then tighten the filter by 2/3 of a turn.

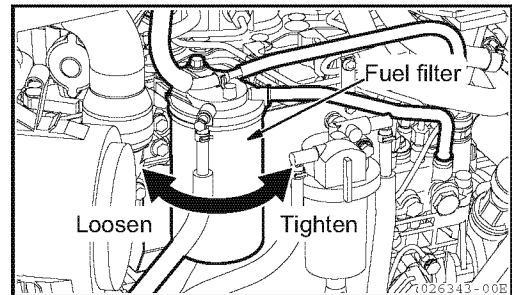

How to release air:

This machine is equipped with an automatic air release device (solenoid pump). Release air according to the procedure.

- 1) Fill up the fuel tank.
- 2) Set the lock lever to the "LOCK" position and the accelerator lever to the "RUN" position.
- 3) Turn the starter switch to the "ON" position to turn on electricity for approximately 10 to 15 seconds. (Air is normally released in 10 to 15 seconds automatically.)
- 4) Turn the starter switch to the "START" position to start the engine.

IMPORTANT

If the engine does not start within 10 seconds, wait at least a minute before again attempting to restart the engine.

Whenever you refuel, release air in the same way. After the engine starts, sometimes it will revolve irregularly. In that case, turn the starter switch to the "OFF" position, wait for one minute or more and turn the starter switch to the "START" position again.

25-7-2. Replacing the air cleaner element

⚠ WARNING

Never attempt to replace the air cleaner element while the engine is running.

Replace the air cleaner element after the engine has been stopped and has cooled sufficiently.

- 1) Open the engine hood.
- 2) Remove the clips and remove the cover.
- 3) Remove the element.
Cover the connector side at the back of the air cleaner body using a clean cloth and tape to prevent dirt from entering.
- 4) Clean the cover and the inside of the body.
Remove the protective cloth and tape used to cover the air cleaner body.
- 5) Install a new element.
- 6) Install the cover, using the arrow mark on it, to confirm proper alignment.
- 7) Close the engine hood.

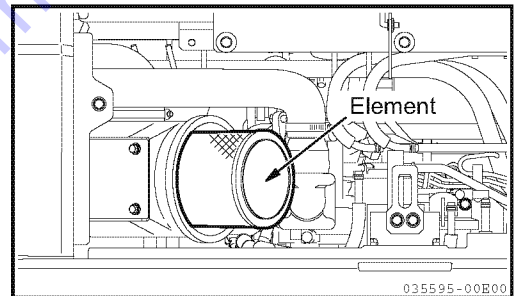
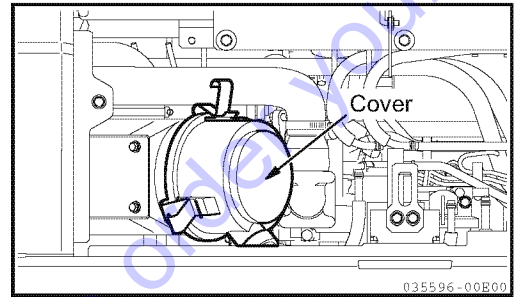

Go to Discount-Equipment.com to order your parts

25-7-3. Replacing the hydraulic oil return filter element

⚠ WARNING

- The hydraulic oil and the tank are hot and under pressure immediately after the engine stops, and can cause bodily injury.
Be sure to replace the filter only after the hydraulic oil tank has cooled enough to permit touching the tank surface with your bare hand.
- If the cover of the tank is removed too quickly, the cover may pop out due to the spring force applied to the filter. Also, the hydraulic oil may spout out if the pressure inside the tank has not been gradually relieved.
- Slowly loosen the four bolts diagonally to remove the cover.

- 1) Open the bonnet B and clean the area around the tank cover on top of the hydraulic oil tank, using a cloth.
- 2) Slowly loosen the bolts to relieve the internal pressure, and remove the tank cover.
- 3) Remove the old filter, install the valve on the new filter, and then install the new filter into the tank.

IMPORTANT

Do not allow any dirt to enter the tank when installing the new return filter element.

- 4) Clean the contact face of the cover with a cloth and check the O-ring. If the O-ring is damaged, replace the O-ring with a new one and then reinstall the tank cover.
- 5) Install the bonnet B.

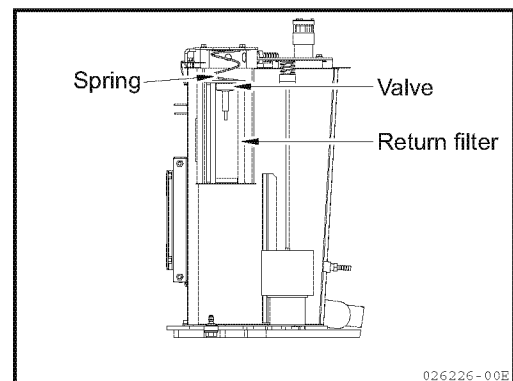
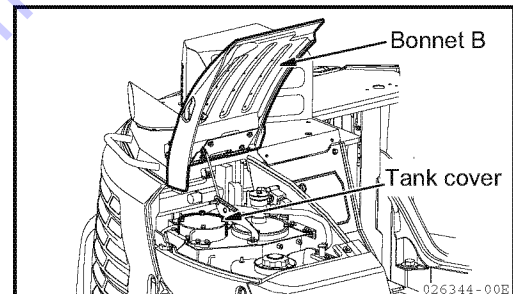

25-8. Maintenance every 1000 service hours

Also perform the maintenance every 50, 100, 250 and 500 service hours.

25-8-1. Replacing the lube oil for the travel reduction gearbox

⚠ WARNING

- The gear oil and casing of the reduction gearbox are hot immediately after ceasing machine operation and can cause bodily injury such as a burn. Do not allow hot oil or the gearbox to contact your skin.
Replace the oil after the oil and the gearbox have cooled enough to permit touching the surface of the gearbox casing with your bare hand.
- At operating temperature, the reduction gearbox is hot and its contents are under pressure. In such condition, the oil or a plug may be ejected violently, causing bodily injury. Loosen a plug slowly to gradually relieve the residual pressure.

■ Things to prepare

- Container for waste oil : Capacity of 1.16 Qts. (1.1 L) or more
- New oil : 1.16 Qts. (1.1 L) for right and left each
- Oil jug : Capacity of 1.16 Qts. (1.1 L) or more

- 1) Position the machine so that the drain port will be in the lowest position, as illustrated in the figure at the right.
- 2) Place the container for waste oil under the drain port.
- 3) Remove the plug from the drain port and level port with a hexagon wrench and drain the waste oil.
- 4) After finish draining the waste oil, reinstall the plug in the drain port.
[Tightening torque : 16.67 to 20.28 ft•lbf
(22.6 to 27.5 N•m)]
- 5) Replenish gear oil to the specified level through the oil supply port. Refer to Section "21. Fueling, Oiling and Greasing Based on Temperature Range" for the oil to be used.
- 6) When the oil begins to overflow from the level port, reinstall the plugs in the oil supply port and level port.
[Tightening torque : 16.67 to 20.28 ft•lbf
(22.6 to 27.5 N•m)]

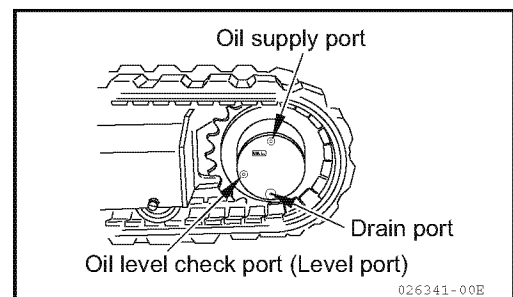

25-8-2. Replacing the hydraulic oil and cleaning the suction filter element

⚠ WARNING

- The hydraulic oil and the tank are hot and under pressure at operating temperature. Never replace the oil immediately after operation is stopped. Wait until the tank has cooled enough to permit you to touch its surface with your bare hand.
- When removing the oil supply port cap, slowly loosen it to relieve the internal pressure, then remove the cap carefully.
- If the cover of the tank is removed too quickly, the cover may pop out due to the spring force applied to the filter. Also, the hydraulic oil may spout out if the pressure inside the tank has not been gradually relieved. Slowly loosen the four bolts diagonally to remove the cover.

■ Things to prepare

- Container for waste oil : Capacity of 15.8 Gals. (60 L) or more
 - New hydraulic oil : 15.8 Gals. (60 L) [When all oil is drained from all of the hydraulic equipment, pipes and hoses, the required new oil amount is 29.6 Gals. (112 L)].
 - O-ring
- 1) Swing the upperstructure so that the drain plug on the bottom of the hydraulic oil tank is positioned in the middle of the right and left crawlers.
 - 2) Retract the bucket and arm cylinders to their stroke ends, lower the boom and put the bucket teeth on the ground.
 - 3) Put the blade on the ground and stop the engine.
 - 4) Place the container for waste oil under the drain plug.
 - 5) Remove the drain plug and drain the waste oil.
When removing the drain plug, take care that the oil does not splash on you.
 - 6) Open the bonnet B and clean the area around the tank cover on the top of the hydraulic oil tank with a cloth. Slowly loosen the bolts diagonally and remove the tank cover.
 - 7) Check the drain plug for metallic particles and remove them, if any.

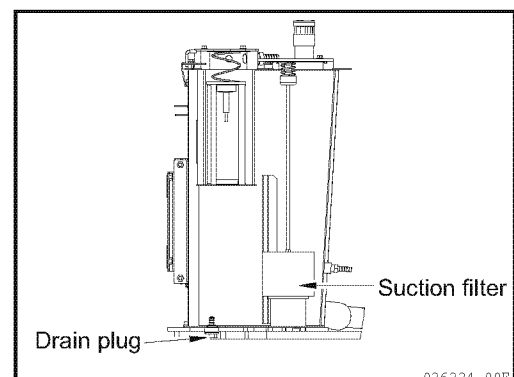
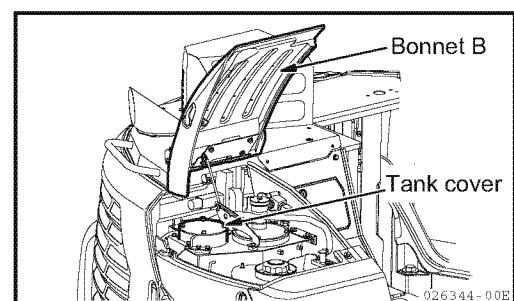
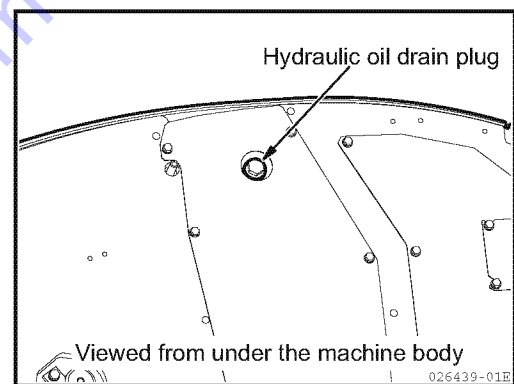
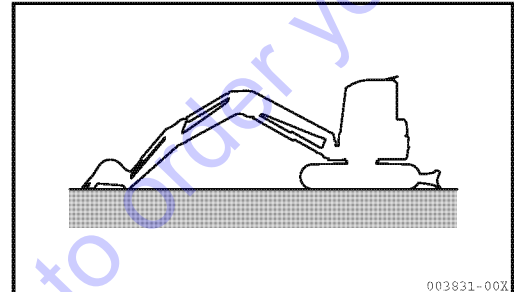

25. Procedures for Maintenance

- 8) Degrease and wash the threads of the plug, and replace the O-ring in the plug with a new one.
- 9) After draining the waste oil, install and tighten the drain plug.
Tightening torque :
115.7 to 137.4 ft•lbf (156.9 to 186.3 N•m)
- 10) Remove the suction filter from the tank. Remove the dirt from the filter and wash it with a washing agent or light oil.
- 11) Check the filter and the O-ring mounted on it. If either the filter or the O-ring is damaged or cracked, replace the filter with a new one and install it in the tank.

IMPORTANT

Do not allow any dirt to enter the tank when installing the filter.

- 12) Add oil to the specified level in the hydraulic oil tank. Check the oil level with the oil level gauge on the side of the tank and do not add oil beyond the midpoint between the upper and lower limit marks on the oil level gauge.
Refer to Section "21. Fueling, Oiling and Greasing Based on Temperature Range" for the oil to be used.
- 13) Wipe off the area around the tank cover with a cloth and check the O-ring. If the O-ring is damaged, replace it with a new one and then mount the tank cover.
- 14) After replacing the oil, set all control levers to the neutral position and idle the engine for approximately 2 to 3 minutes and then test each implement for proper operation.
- 15) Close the bonnet B.

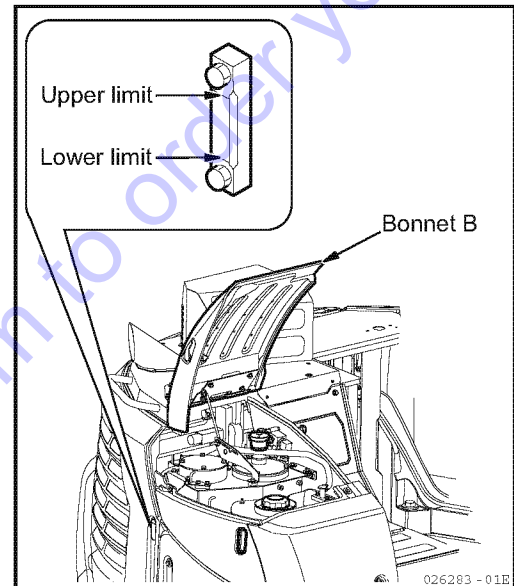
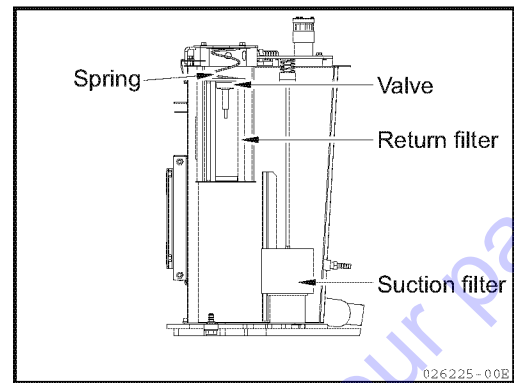

25-8-3. Replacing the line filter

⚠ WARNING

The oil is hot immediately after ceasing machine operation. Do not replace the filter immediately. Replace the filter after the oil has cooled down sufficiently.

■ Things to prepare

- Container for waste oil

- 1) Remove the cover (1).
- 2) Place the container under the line filter.
- 3) Turn the line filter (2) (cartridge type) with the use of tool (wrench or the like) to the left to remove it.
- 4) Wipe the filter installation part with a rag containing light oil to remove the accumulated dirt, oil residue and so on.
- 5) Apply a little amount of clean hydraulic oil to the gasket face and install the new filter element (2).
- 6) Screw it in until its gasket contacts the bracket and tighten it 2/3 turns more.
Tightening torque : 18.4 to 25.8 ft•lbf (25 to 35 N•m)
- 7) Run the engine and check for the oil leak from the installation face.
- 8) Install the cover (1).

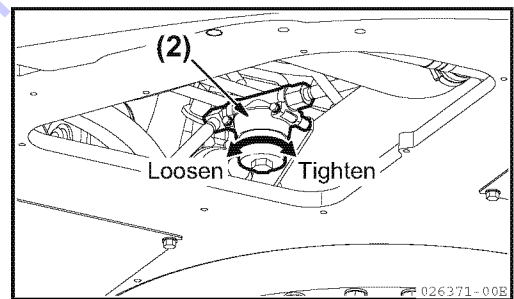
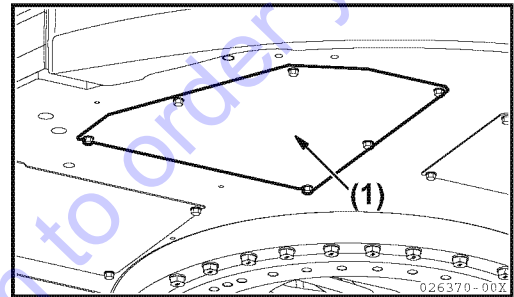

25-8-4. Checking and adjusting the intake/exhaust valve clearances

Ask your dealer for checking and adjusting.

25-8-5. Checking, cleaning and testing the fuel injection valve

Ask your dealer for checking, cleaning and testing.

25-8-6. Retightening the cylinder head bolts

Ask your dealer for checking and adjusting.

25-9. Maintenance every 1500 service hours

Also perform the maintenance every 50, 100, 250 and 500 service hours.

25-9-1. Checking crankcase breather system

Ask your dealer for checking.

25-10. Maintenance every 2000 service hours

Also perform the maintenance every 50, 100, 250, 500 and 1000 service hours.

25-10-1. Checking and replacing fuel piping, cooling water piping

Ask your dealer for checking and replacing.

25-10-2. Lapping the intake/exhaust valves

Ask your dealer for lapping.

25-10-3. Checking the accumulator

⚠ WARNING

High pressure nitrogen gas is enclosed in the accumulator. Incorrect handling of the accumulator could cause bodily injury due to an explosion. When handling the accumulator, the following precautions shall be observed:

- Do not disassemble.
- Keep sparks or flames away.
- Do not drill, weld or melt.
- Do not give an impact such as hitting and rolling over.
- The pressure of the hydraulic circuit cannot be relieved completely. When removing the hydraulic equipment, do not work in the direction of oil injection. Loosen the screws slowly.
- As it is necessary to relieve the enclosed gas at the time of disposal, ask your dealer.

IMPORTANT

Continuing to operate the accumulator with the reduced enclosed nitrogen gas pressure will result in failure to relieve the pressure of the hydraulic circuit at the time of machine failures.

■ Function of accumulator

The accumulator (1) accumulates the pressure of the operating circuit. As the operating circuit is activated for awhile even after stopping the engine, the following can be done:

- By moving the control levers to the direction of lowering the implement, it can go down on the ground with its self-weight.
- The pressure of the hydraulic circuit can be released.

Note:

The function can be used when the starter switch is "ON" and the lock lever is in the "Unlock" position.

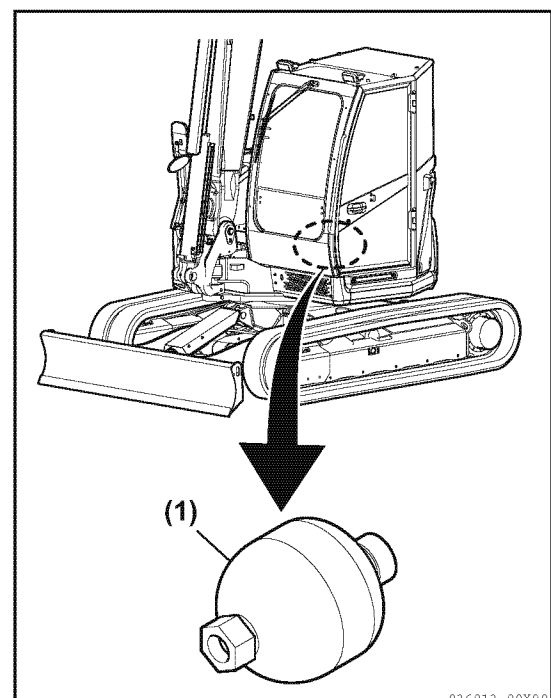

036013-00X00

■ Checking the accumulator function

⚠ CAUTION

Check to see that there are no people or obstacles around the machine before operating the engine.

Check the nitrogen gas enclosed pressure according to the following procedures:

Perform the steps 1-2 while the engine is starting.

- 1) Stop the machine on level ground with good footing.
- 2) Keep the implement at maximum reach posture and keep the bucket pivot pin and the boom pivot pin at the same height.

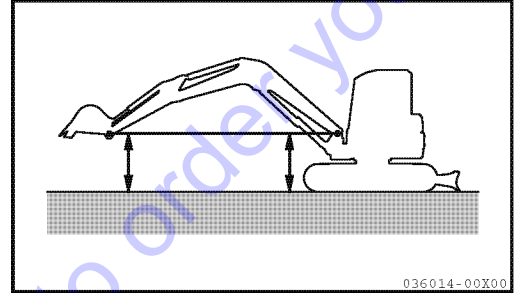

Perform the steps 3-5 within 15 seconds.

As the accumulator pressure is gradually reduced after stopping the engine, checking can only be done right after stopping the engine.

- 3) While keeping the implement at maximum reach posture, set the starter switch to the "OFF" position to stop the engine.

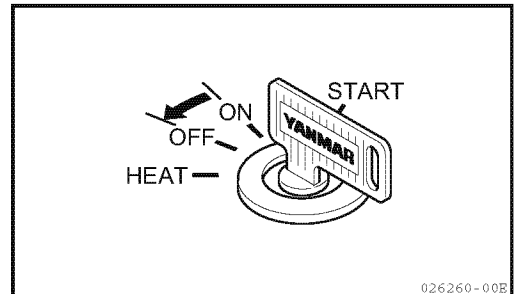

- 4) Set the starter switch to the "ON" position.

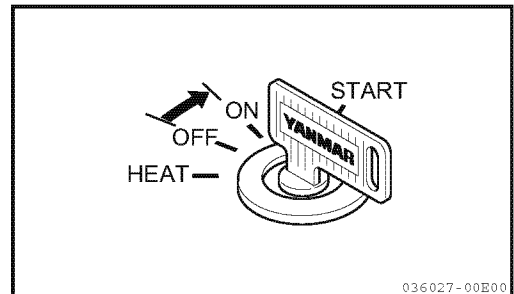

- 5) Set the lock lever (2) to the "Unlock" position and move the control levers to the boom lower direction at full stroke to check if the implement can go down on the ground.

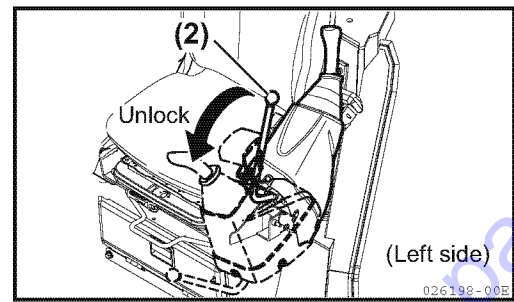

- 6) If the implement can go down on the ground with its self-weight, the accumulator is normal. If the implement cannot be lowered or stops along the way, the gas enclosed pressure of the accumulator for operation circuit could be reduced. Ask your dealer to check the machine.

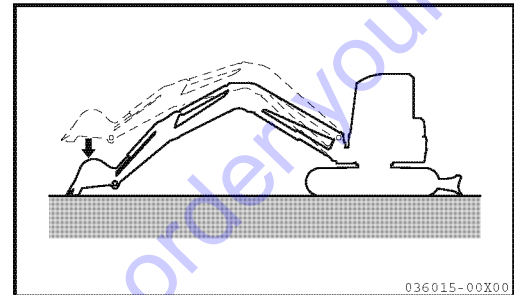

- 7) Set the lock lever to the "LOCK" position and turn the starter switch "OFF" after the completion of checking.

25-11. Maintenance every 3000 service hours

Also perform the maintenance every 50, 100, 250, 500, 1000 and 1500 service hours.

25-11-1. Checking, cleaning and testing EGR valve

Ask your dealer for checking, cleaning and testing.

25-11-2. Cleaning EGR lead valve

Ask your dealer for cleaning.

SPECIFICATIONS AND DIMENSIONAL DIAGRAMS

Go to Discount-Equipment.com to order your parts

26. Specifications and Dimensional Diagrams

■ Specifications (Quick coupler)

Items	Type	ViO80	
		Rubber crawler	Steel crawler
		Cabin	Cabin

- Weight (in compliance with SAE standards)

Operating mass	lbs. (kg)	18136 (8225)	18268 (8285)
Machine mass (without implement)	lbs. (kg)	13098 (5940)	13230 (6000)

- Working range and performance

Bucket capacity, standard	cu.ft (cu.m)	9.89 (0.28)	
Bucket width, standard	in. (mm)	29.53 (750)	
Maximum digging depth <at down the blade>	in. (mm)	172 (4380) <184 (4670)>	
Maximum vertical wall digging depth	in. (mm)	154 (3920)	
Maximum cutting height	in. (mm)	285 (7250)	
Maximum dumping height	in. (mm)	183 (4640)	
Maximum digging radius of the ground	in. (mm)	281 (7140)	
Front minimum swing radius <at swinging the boom>	in. (mm)	107 (2720) <93 (2370)>	
Boom swing angle : left / right	degrees	57/60	
Maximum digging force (bucket)	lbs. (kN)	11334 (50.4)	
Travel speed : high / low	MPH (km / h)	2.8 (4.5) / 1.6 (2.5)	2.6 (4.1) / 1.4 (2.3)
Swing speed	rpm	9	
Average ground pressure, standard crawler	PSI (kPa)	5.2 (35.8)	5.2 (36.2)
Hydraulic pump displacement	GPM (L / min)	18.6 (70.3)×2 <Variable displacement pump> 14.0 (53.0)×1, 5.5 (20.9)×1 <Gear pump>	
System relief set pressure	PSI (MPa)	3699×2, 3481×1, 421×1 (25.5×2, 24.0×1, 2.9×1)	

- Engine

Type	-	Vertical four cylinder water-cooled direct injection diesel engine
Model	-	4TNV98-ZWBV1
Rated output	HP (kW) / rpm	54.6 (40.7) / 2000
Maximum output at high idle speed (High idle speed is limited by the engine control unit.)	HP (kW) / rpm	52.7 (39.3) / 1900
Displacement	cu.in. (cu.cm)	202.40 (3318)
Compression pressure	PSI (MPa)	483 to 512 (3.33 to 3.53) to 250 rpm
Nozzle injection pressure	PSI (MPa)	3132 to 3277 (21.6 to 22.6)
Fan belt (V-belt) size	-	A42.5
Generator capacity	V / A	12 / 55

- **Battery type and capacity.....130E41R-MF / 12V, 92Ah (5 hours rate capacity)**

■ Model view and working range Unit : in. (mm)
(Quick coupler)

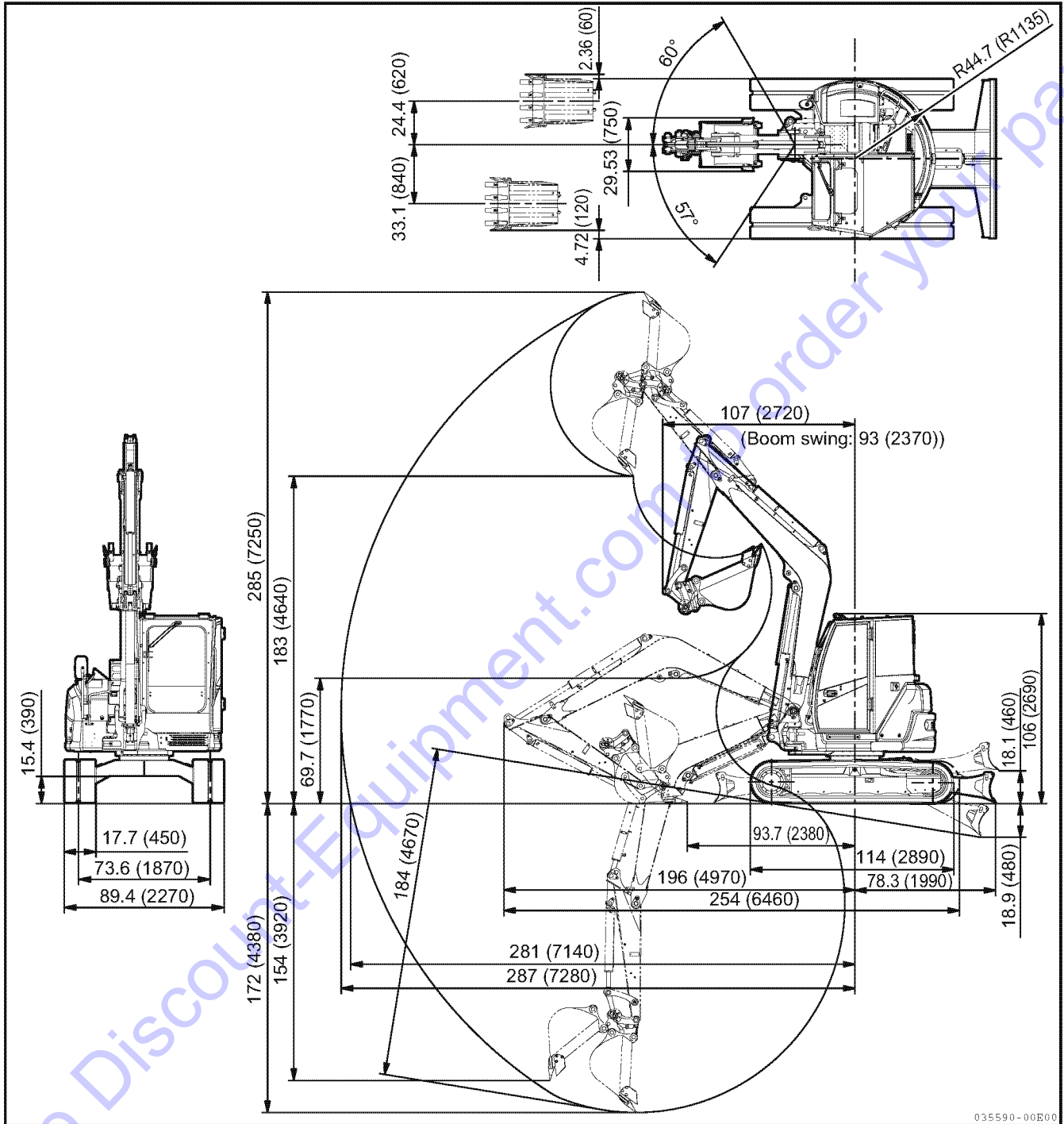

26. Specifications and Dimensional Diagrams

■ Specifications (W/O Quick coupler)

Items	Type	ViO80	
		Rubber crawler	Steel crawler
		Cabin	Cabin

- Weight (in compliance with SAE standards)

Operating mass	lbs. (kg)	17783 (8065)	17916 (8125)
Machine mass (without implement)	lbs. (kg)	13098 (5940)	13230 (6000)

- Working range and performance

Bucket capacity, standard	cu.ft (cu.m)	9.89 (0.28)	
Bucket width, standard	in. (mm)	29.53 (750)	
Maximum digging depth <at down the blade>	in. (mm)	163 (4130) <174 (4430)>	
Maximum vertical wall digging depth	in. (mm)	149 (3780)	
Maximum cutting height	in. (mm)	268 (6810)	
Maximum dumping height	in. (mm)	185 (4700)	
Maximum digging radius of the ground	in. (mm)	269 (6820)	
Front minimum swing radius <at swinging the boom>	in. (mm)	97 (2470) <84 (2130)>	
Boom swing angle : left / right	degrees	57 / 60	
Maximum digging force (bucket)	lbs. (kN)	14288 (63.5)	
Travel speed : high / low	MPH (km / h)	2.8 (4.5) / 1.6 (2.5)	2.6 (4.1) / 1.4 (2.3)
Swing speed	rpm	9	
Average ground pressure, standard crawler	PSI (kPa)	5.1 (35.1)	5.1 (35.5)
Hydraulic pump displacement	GPM (L / min)	18.6 (70.3)×2 <Variable displacement pump> 14.0 (53.0)×1, 5.5 (20.9)×1 <Gear pump>	
System relief set pressure	PSI (MPa)	3699×2, 3481×1, 421×1 (25.5×2, 24.0×1, 2.9×1)	

- Engine

Type	-	Vertical four cylinder water-cooled direct injection diesel engine
Model	-	4TNV98-ZWBV1
Rated output	HP (kW) / rpm	54.6 (40.7) / 2000
Maximum output at high idle speed (High idle speed is limited by the engine control unit.)	HP (kW) / rpm	52.7 (39.3) / 1900
Displacement	cu.in. (cu.cm)	202.40 (3318)
Compression pressure	PSI (MPa)	483 to 512 (3.33 to 3.53) to 250 rpm
Nozzle injection pressure	PSI (MPa)	3132 to 3277 (21.6 to 22.6)
Fan belt (V-belt) size	-	A42.5
Generator capacity	V / A	12 / 55

- **Battery type and capacity.....130E41R-MF / 12V, 92Ah (5 hours rate capacity)**

- Model view and working range Unit : in. (mm)
(W/O Quick coupler)

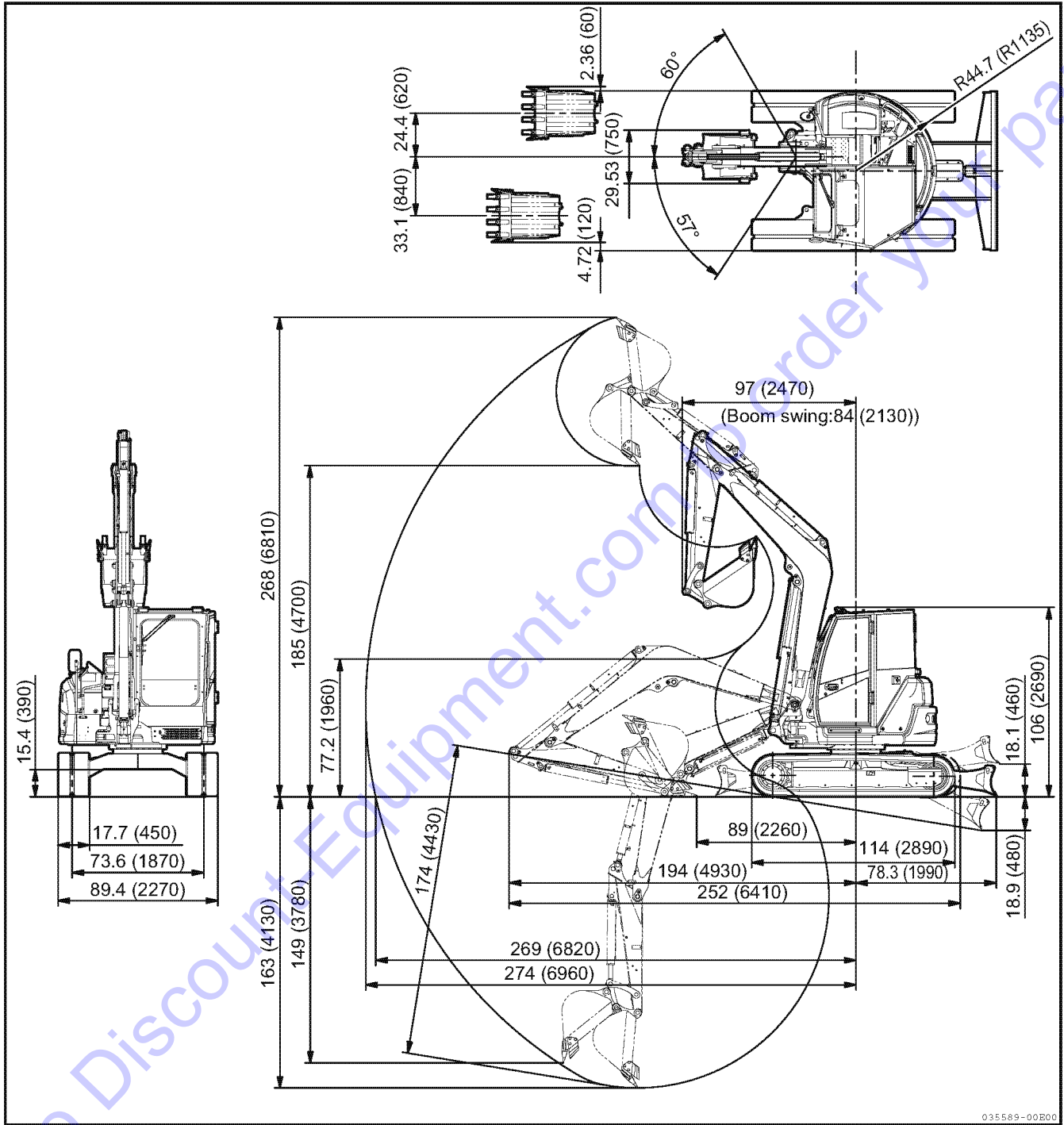

OPTIONAL PARTS AND ATTACHMENTS

Go to Discount-Equipment.com to order your parts

27. General Precautions

27-1. Safety precautions

The mounting of attachments and optional parts that are not authorized by YANMAR may cause accidents as well as shorten the machine life.

If you need to mount any attachments other than those described in this manual, contact your dealer. If you fail to do so, the installation and use of unauthorized attachments and parts may void your Warranty.

WARNING

Precautions for mounting and dismounting an attachment

When mounting or dismounting an attachment, observe the following precautions for safety.

- **When mounting or dismounting a heavy implement or attachment, place the machine on level, solid ground.**
- **To prevent clashing against cabin or canopy, never mount attachment over Max. wrist radius.**
- **When you work together with a partner, define hand signals and communicate in accordance with those signals.**
- **When moving a heavy load [more than 55 lbs. (25 kg)], use a crane.**
- **When removing a heavy part, be sure to support it adequately.**

When lifting such a part with a crane, take note of its center of gravity.

- **Do not mount or dismount a heavy part while suspending it with a crane. Be sure to support it securely on a stable base.**
- **Securely support any attachment that has been removed or is to be installed, and take adequate precautions not to let it fall down.**
- **Never stand directly under a load suspended by a crane.**
Stand far enough away to be safe if the load should fall.

IMPORTANT

Comply with all licensing requirements before operating a crane.

Do not permit an unauthorized person to operate a crane.

For more information about the procedures for mounting and dismounting attachments, ask your dealer.

27-2. Precautions for mounting an attachment (implement)

⚠ WARNING

A long implement may throw a machine off balance, and may cause the machine to roll over when the machine descends or swings on a slope.

The following operations are especially dangerous, and must never be done.

- Descending a slope with the implement raised
- Traversing across a slope
- Swinging on a slope

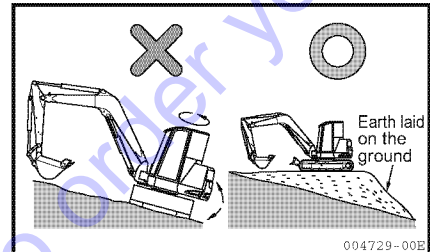
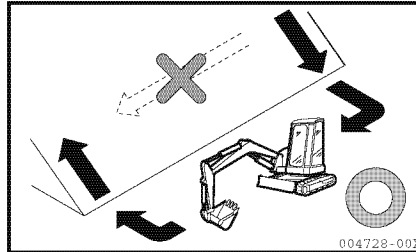
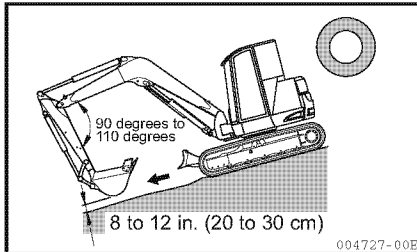

- If you mount an unusually heavy implement (attachment) on the machine, the inertia of the upperstructure will increase so that the upperstructure will continue to turn over a longer distance after it has been deactivated. This can mislead the operator about the safe distance between the swinging implement and an object nearby and could cause the implement to bump against the object. To avoid this type of accident, deactivate the upperstructure a little earlier than usual. Because of increased inertia, the implement will also drop a greater distance after it has been stopped in mid-air. (The unintentional drifting of the implement will be greater.)
- Be sure that the boom and the arm have been mounted correctly. Otherwise, serious accidents or damage may occur. If you do not know how to mount the boom or the arm correctly, ask your dealer.
- If you mount a long implement, you may misjudge the distance between the implement and a nearby object, and cause the implement to bump against the object.
Be sure to provide adequate clearance between long implements and nearby objects.

28. Handling the Hooked Bucket

28-1. Checking the hooked bucket for damage

Check the hook, the lock, and the hook mounting base for damage.

If any damage is found, ask your dealer to repair the bucket.

28-2. Prohibitions

■ Do not suspend a load without the dedicated hook

A dedicated hook is required to suspend a load with the machine.

For details, ask your dealer.

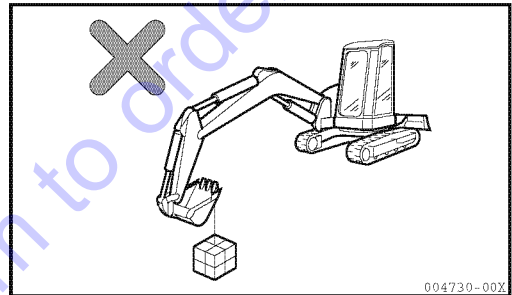

28-3. Precautions

■ Precautions for suspending a load

- Reduce the engine speed when suspending a load.
- The wire rope or the suspending ring may slip off the bucket hook if the hook cannot be maintained in a vertical position due to the working posture of the machine. Be careful to maintain a vertical hook position, so that the wire rope or the suspending ring will not slip off.
- When the hooked bucket is used in a reverse position, take care that the bucket hook should not interfere with the arm while dumping the bucket.
- The weight of a load to be suspended must not exceed 474 lbs. (215 kg) (with the standard arm mounted).
- Ask your dealer to mount a hook on the bucket.

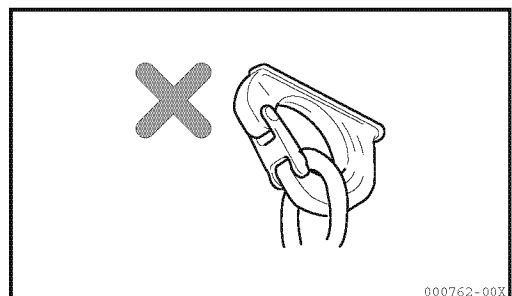
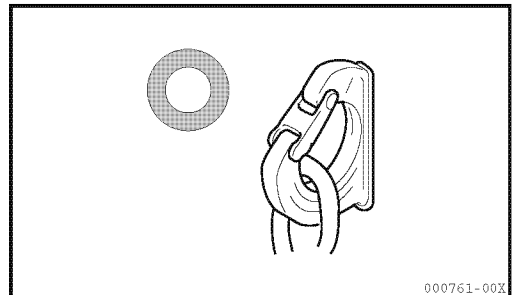

29. Optional Parts and Attachments

29-1. Optional parts and attachments

The following options are available. Select options useful for your work.

If you need an option, contact your dealer.

- **Bucket (Teeth...Point type)**

Width in. (mm)	Capacity cu.ft (cu.m)	Remarks
17.7 (450)	6.00 (0.17)	
23.6 (600)	8.12 (0.23)	
27.6 (700)	9.18 (0.26)	
29.5 (750)	9.89 (0.28)	VI080
31.5 (800)	10.59 (0.30)	

Go to Discount-Equipment.com to order your parts

EXCAVATOR



www.discount-equipment.com

YANMAR

YANMAR CONSTRUCTION EQUIPMENT CO., LTD.

Copyright© 2012 YANMAR CONSTRUCTION EQUIPMENT CO., LTD. All Rights Reserved.
This manual may not be reproduced or copied in whole or in part, without the written consent of
YANMAR CONSTRUCTION EQUIPMENT CO., LTD.

0AKB3-G0001
Rev.2011-075@YTSK

PARTS FINDER

**Search Website
by Part Number**



**Search Manual
Library For Parts
Manual & Lookup Part
Numbers – Purchase
or Request Quote**

Search Manuals

Enter your information to help us find the right parts manual for your machine.

* Brand:

* Model:

* Serial:

* Part Number:

SEARCH

**Can't Find Part or
Manual? Request Help
by Manufacturer,
Model & Description**

Parts Order Form

Please fill in the following information to help us find the right part for your machine.

Manufacturer:	<input type="text"/>
Model:	<input type="text"/>
Description:	<input type="text"/>
Part Number:	<input type="text"/>
Quantity:	<input type="text"/>
Notes:	<input type="text"/>

Submit

Discount-Equipment.com is your online resource for quality parts & equipment.

Florida: **561-964-4949** Outside Florida TOLL FREE: **877-690-3101**

Need parts?

Click on this link: <http://www.discount-equipment.com/category/5443-parts/> and choose one of the options to help get the right parts and equipment you are looking for. Please have the machine model and serial number available in order to help us get you the correct parts. If you don't find the part on the website or on one of the online manuals, please fill out the request form and one of our experienced staff members will get back to you with a quote for the right part that your machine needs.

We sell worldwide for the brands: Genie, Terex, JLG, MultiQuip, Mikasa, Essick, Whiteman, Mayco, Toro Stone, Diamond Products, Generac Magnum, Airman, Haulotte, Barreto, Power Blanket, Nifty Lift, Atlas Copco, Chicago Pneumatic, Allmand, Miller Curber, Skyjack, Lull, Skytrak, Tsurumi, Husquvarna Target, Stow, Wacker, Sakai, Mi-T-M, Sullair, Basic, Dynapac, MBW, Weber, Bartell, Bennar Newman, Haulotte, Ditch Runner, Menegotti, Morrison, Contec, Buddy, Crown, Edco, Wyco, Bomag, Laymor, EZ Trench, Bil-Jax, F.S. Curtis, Gehl Pavers, Heli, Honda, ICS/PowerGrit, IHI, Partner, Imer, Clipper, MMD, Koshin, Rice, CH&E, General Equipment, Amida, Coleman, NAC, Gradall, Square Shooter, Kent, Stanley, Tamco, Toku, Hatz, Kohler, Robin, Wisconsin, Northrock, Oztec, Toker TK, Rol-Air, APT, Wylie, Ingersoll Rand / Doosan, Innovatech, Con X, Ammann, Mecalac, Makinex, Smith Surface Prep, Small Line, Wanco, Yanmar