

OPERATION & MAINTENANCE  
MANUAL

# EXCAVATOR

ViO45-5B

ViO55-5B

(US)

ViO45-5B : S/N 53001 & Above  
ViO55-5B : S/N 53001 & Above



[www.discount-equipment.com](http://www.discount-equipment.com)

Go to Discount-Equipment.com to order your parts

# PARTS FINDER

**Search Website  
by Part Number**



**Search Manual  
Library For Parts  
Manual & Lookup Part  
Numbers – Purchase  
or Request Quote**

**Search Manuals**

Enter your information to help us find the right parts manual for your machine.

\* Brand:

\* Model:

\* Serial:

\* Part Number:

SEARCH

**Can't Find Part or  
Manual? Request Help  
by Manufacturer,  
Model & Description**

**Parts Order Form**

Please fill in the following information to help us find the right part for your machine.

|               |                      |
|---------------|----------------------|
| Manufacturer: | <input type="text"/> |
| Model:        | <input type="text"/> |
| Description:  | <input type="text"/> |
| Part Number:  | <input type="text"/> |
| Quantity:     | <input type="text"/> |
| Notes:        | <input type="text"/> |

Submit

Discount-Equipment.com is your online resource for quality parts & equipment.

Florida: **561-964-4949** Outside Florida TOLL FREE: **877-690-3101**

**Need parts?**

Click on this link: <http://www.discount-equipment.com/category/5443-parts/> and choose one of the options to help get the right parts and equipment you are looking for. Please have the machine model and serial number available in order to help us get you the correct parts. If you don't find the part on the website or on one of the online manuals, please fill out the request form and one of our experienced staff members will get back to you with a quote for the right part that your machine needs.

We sell worldwide for the brands: Genie, Terex, JLG, MultiQuip, Mikasa, Essick, Whiteman, Mayco, Toro Stone, Diamond Products, Generac Magnum, Airman, Haulotte, Barreto, Power Blanket, Nifty Lift, Atlas Copco, Chicago Pneumatic, Allmand, Miller Curber, Skyjack, Lull, Skytrak, Tsurumi, Husquvarna Target, Stow, Wacker, Sakai, Mi-T-M, Sullair, Basic, Dynapac, MBW, Weber, Bartell, Bennar Newman, Haulotte, Ditch Runner, Menegotti, Morrison, Contec, Buddy, Crown, Edco, Wyco, Bomag, Laymor, EZ Trench, Bil-Jax, F.S. Curtis, Gehl Pavers, Heli, Honda, ICS/PowerGrit, IHI, Partner, Imer, Clipper, MMD, Koshin, Rice, CH&E, General Equipment, Amida, Coleman, NAC, Gradall, Square Shooter, Kent, Stanley, Tamco, Toku, Hatz, Kohler, Robin, Wisconsin, Northrock, Oztec, Toker TK, Rol-Air, APT, Wylie, Ingersoll Rand / Doosan, Innovatech, Con X, Ammann, Mecalac, Makinex, Smith Surface Prep, Small Line, Wanco, Yanmar

**Read this manual** carefully to learn how to operate and service your machine correctly. Failure to do so could result in personal injury or equipment damage

**This manual should be considered** a permanent part of your machine and should remain with the machine when you sell it.

**This machine is of metric** design, and consequently the measurements in this manual are also metric. Use only metric hardware and tools as specified.

**Right-hand and left-hand** sides are determined by facing in the direction of forward travel.

**Warranty** is provided as a part of Yanmar's product support program for customers who operate and maintain their equipment as described in this manual. Should the equipment be abused, or modified to change its performance beyond the original factory specifications, the warranty will become void and field improvements under warranty may be denied. Setting fuel delivery above specifications or otherwise overpowering machines will result in such action.

*All information, illustrations and specifications in this manual are based on the latest product information available at the time of publication. The right is reserved to make changes at any time without notice.*

## REFERENCE INFORMATION

Write the correct information for your YANMAR Excavator in the spaces below. Always use these numbers when referring to your YANMAR Excavator.

Model name : \_\_\_\_\_  
Serial Number : \_\_\_\_\_  
Engine Serial Number : \_\_\_\_\_  
Your YANMAR Excavator Dealer : \_\_\_\_\_  
Address : \_\_\_\_\_  
Phone : \_\_\_\_\_

### California Proposition 65 Warning

Diesel engine exhaust and some of its constituents are known to the state of California to cause cancer, birth defects, and other reproductive harm.

### California Proposition 65 Warning

Battery posts, terminals, and related accessories contain lead and lead compounds, chemicals known to the state of California to cause cancer and reproductive harm.  
Wash hands after handling.

# 1. Introduction

This Operation and Maintenance Manual for the YANMAR ViO45-5B / ViO55-5B Excavator is designed to provide you with important information and suggestions necessary for using the machine with safety and efficiency. Please be sure to read through the manual before using the machine, to make yourself familiar with the procedures and instructions for operating, inspecting and servicing. Keep in mind that failure to observe the precautions given in the manual or using any procedures not prescribed in the manual may cause a serious accident.

## **WARNING**

**Improper use of the machine may lead to hazards which can result in death or serious injury. Personnel engaged in operating and maintaining the machine are required to familiarize themselves with the contents of the manual before setting about their job.**

- **Do not attempt to operate the machine before making yourself familiar with the contents of the manual.**
- **Personnel responsible for using the machine must keep the manual at hand and review it periodically.**
- **If the manual should be lost or damaged, promptly order a new copy from the dealer.**
- **When you transfer the machine to another user, always transfer the manual as well.**
- **We at YANMAR provide customers with products in compliance with all applicable your country's regulations and industrial standards. If you are using a YANMAR machine purchased abroad, the machine may lack some safety devices. Please consult your dealer to confirm whether or not that machine is in compliance with all applicable your country's regulations and industrial standards.**
- **Some machine specifications may differ from those which are described in this manual because of improvements in its design and performance. If you have any questions about the contents of the manual, don't hesitate to contact your dealer.**
- **Important safety instructions have been presented throughout this manual, and have been summarized in PART ONE : SAFETY. Be sure to review these pages and pay heed to those safety instructions before proceeding to operate the machine.**

## 2. Safety Information

- The following Signal Words have been used in this Manual and on the Safety Signs to indicate the seriousness of the hazards that could be encountered by failing to comply with the applicable Product Warnings, as follows:

**! DANGER**

Could result in death or catastrophic bodily injury.

**! WARNING**

Could result in bodily injury.

**! CAUTION**

Could result in property damage.

**IMPORTANT**

The signal Word "IMPORTANT" has been utilized in this Manual to denote those User Directions that must be followed to assure the safe operation and maintenance of the Excavator.

- **WARNING** : Never attempt to operate or service this Excavator until you have first read and understood all of the applicable Product Warnings and User Directions that are set forth in this Manual and on the Safety Signs that are affixed to this Excavator.

The failure to comply with all relevant Safety Instructions could result in bodily injury.

- **WARNING** : Never modify the design of this Excavator or its engine; never remove or disable any of the installed safety guards or devices; and never use any unauthorized attachments in the operation of this equipment.

The implementation of any unauthorized design modifications or the use of unauthorized attachments could result in bodily injury.

Furthermore, since those actions would expressly violate the terms of Yanmar's Product Warranty, the applicable Warranty would also be voided.

In this Manual, the major sections of the product are designated as follows:

**Machine**.....refers to the entire product.

**Machine base**.....refers to the section consisting of the upper-structure and the undercarriage.

**Implement**.....refers to the section consisting of the arm, boom and bucket or other attachment.

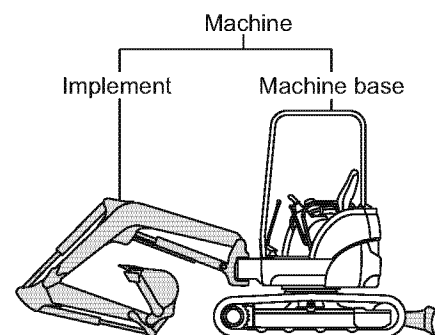

000273-00B

## 3. Product Overview

### 3-1. Intended uses

The ViO45-5B / ViO55-5B Excavator is intended to perform the following tasks:

- Digging
- Leveling of ground
- Shoveling
- Ditching and Guttering
- Loading

**The machine should not be used for unintended tasks**

For the details of how to work with the machine, refer to OPERATION Section "12-1. Overview of the machine".

### 3-2. Break in period

The machine should not be subjected to severe stresses and loads during the initial break in period although it has been prepared well and stringently inspected before shipping. Otherwise the machine's performance may be affected and its service life shortened. Thus it is essential to break in the machine for the first approx. 100 service hours (reading of the hourmeter).

In breaking in the machine:

- You should warm up the engine by idling for 5 minutes before starting operations.
- You should not operate the machine under heavy loads or at high speed.
- You should not start and accelerate the engine too abruptly, or stop it too abruptly.
- You should not change travel direction too abruptly.

The safety instructions for operation and maintenance that are presented in this Manual are applicable to each of the intended tasks. Never misuse this machine by violating the applicable safety instructions or by attempting to perform unintended tasks, because of the danger of serious bodily injury.

#### 3-3. Conditions to insure compliance with EPA emission standards *Conditions de conformité avec les standards d'émission EPA*

An EPA approved engine has been mounted on this machine. The following are the conditions that must be met in order to insure that the emission during operation meets the EPA standards. Be sure to follow these.

- The surrounding conditions should be as follows.
  - (1) Ambient temperature : -4 to 104°F (-20 to 40°C)
  - (2) Relative humidity : 80% or lower
- The fuel and lube oil used should be as follows.
  - (1) Fuel : Diesel light oil ASTM D975 No.1D S15, S500 or No.2D S15, S500 (ISO 8217 DMX)
- The fuel cetane number should be equal to 45 or higher.
- The sulfur content must not exceed 0.5% by volume. Less than 0.05% is preferred.

In general, using a high sulfur fuel may possible result in corrosion inside the cylinder.  
Especially in U.S.A. and Canada, Low Sulfur (300-500mg/kg sulfur content) or Ultra Low Sulfur fuel should be used.
- The water and sediment in the fuel should not exceed 0.05% by volume.
  - (2) Lube oil : Type API, class CD
- Do not remove the seals limiting the amount of fuel injected and the speed.
- Be sure to carry out inspections.

Follow the basic guidelines outlined in Section "26. Maintenance Table" of this manual, and keep a record of the results. Pay particular attention to these important points: replacing the lube oil and lube oil filter, cleaning the air cleaning the air cleaner element and the radiator fins.

*Un moteur thermique agréé EPA est installé sur cette machine. A la suite figurent les conditions d'utilisation permettant de satisfaire au standard EPA; il est impératif de les respecter.*

• *Environnement extérieur:*

- (1) *Température ambiante : -4 à 104°F (-20 à 40°C)*
- (2) *Humidité relative : 80 % au moins*

• *Carburant et huiles à utiliser*

- (1) *Carburant : Diesel léger ASTM D975 N° 1D S15, S500 ou N° 2D S15, S500 (ISO 8217 DMX)*
- *L'indice de cétane du carburant doit être égal ou supérieur à 45.*
  - *La teneur en soufre ne doit pas dépasser 0,5% par volume. Moins de 0,05% est préférable.*

*En général, l'utilisation d'un carburant à teneur élevée en soufre peut entraîner une corrosion à l'intérieur du vérin.*

*Aux U.S.A. et au Canada notamment, l'utilisation d'un carburant à basse teneur (teneur en soufre 300-500mg/kg) ou très basse teneur en soufre est recommandée.*

- *L'eau et les sédiments présents dans le carburant ne doivent pas dépasser 0,05% par volume.*
- (2) *Huiles : type API, classe CD*

• *Ne pas retirer les joints limitant la quantité de carburant injecté et la vitesse*

• *Respecter les inspections périodiques*

*Suivre les indications figurant dans ce manuel (Table de maintenance 26) et garder une trace des résultats. Faire très attention aux points importants suivant: remplacer l'huile et le filtre à huile, nettoyer l'élément de filtre à air et le radiateur.*

**3-4. Emission system warranty*****Garantie du système antipollution*****Yanmar Co., Ltd. limited emission control system warranty - U.S.A. only****■ Your warranty rights and obligations**

- California

The California Air Resources Board (CARB), the Environmental Protection Agency (EPA) and Yanmar Co., Ltd. hereafter referred to as Yanmar, are pleased to explain the **emission control system warranty** on your industrial compression-ignition engine. In California, model year 2000 or later off-road compression-ignition engines must be designed, built and equipped to meet the State's stringent anti-smog standards. In all states, 1998 and later non-road compression-ignition engines must be designed, built and equipped to meet the United States EPA emissions standards. Yanmar warrants the emission control system on your engine for the periods of time listed below provided there has been no abuse, neglect or improper maintenance of your engine.

Your emission control system may include parts such as the fuel injection system, the air induction system, the electronic control system and the EGR (Exhaust Gas Recirculation) system. Also included may be hoses, belts, connectors and other emission-related assemblies.

Where a warrantable condition exists, Yanmar will repair your non-road compression-ignition engine at no charge to you including diagnosis, parts and labor.

**■ Manufacturer's Warranty Period**

The model year 1998 or later certified and labeled non-road compression-ignition engines are warranted for the periods listed below. If any emission-related part on your engine is found to be defective during the applicable warranty period, the part will be replaced by Yanmar.

| Engine Type  | Warranty Period by Number of Years or Hours of Operation  |
|--|---|
| Constant speed engines rated at or above 50 hp SAE (37 kW)   | The warranty period is five (5) years or 3,000 hours of use, whichever occurs first.<br>In the absence of a device to measure the hours of use, the engine has a warranty period of five (5) years. |
| Constant speed engines rated under 50 hp SAE (37 kW) with rated speeds greater than or equal to 3,000 rpm                                  | The warranty period is two (2) years or 1,500 hours of use, whichever occurs first.<br>In the absence of a device to measure the hours of use, the engine has a warranty period of two (2) years.   |
| Constant speed engines rated under 50 hp SAE (37 kW) and engines rated at or above 26 hp SAE (19 kW) with rated speeds less than 3,000 rpm | The warranty period is five (5) years or 3,000 hours of use, whichever occurs first.<br>In the absence of a device to measure the hours of use, the engine has a warranty period of five (5) years. |
| Engines rated at or above 26 hp SAE (19 kW)  | The warranty period is five (5) years or 3,000 hours of use, whichever occurs first.<br>In the absence of a device to measure the hours of use, the engine has a warranty period of five (5) years. |
| Engines rated under 26 hp SAE (19 kW)  | The warranty period is two (2) years or 1,500 hours of use, whichever occurs first.<br>In the absence of a device to measure the hours of use, the engine has a warranty period of two (2) years.   |



#### ■ Warranty Coverage

This warranty is transferable to each subsequent purchaser for the duration of the warranty period. Repair or replacement of any warranted part will be performed at an authorized Yanmar industrial engine dealer or distributor.

Warranted parts not scheduled for replacement as required maintenance in the Operation Manual shall be warranted for the warranty period. Warranted parts scheduled for replacement as required maintenance in the operation manual are warranted for the period of time prior to the first scheduled replacement. Any part repaired or replaced under warranty shall be warranted for the remaining warranty period.

During the warranty period, Yanmar is liable for damages to other engine components caused by the failure of any warranted part during the warranty period.

Any replacement part which is functionally identical to the original equipment part in all respects may be used in the maintenance or repair of your engine, and shall not reduce Yanmar's warranty obligations. Add-on or modified parts that are not exempted may not be used. The use of any non-exempted add-on or modified parts shall be grounds for disallowing a warranty.

#### ■ Warranted Parts

This warranty covers engine components that are a part of the emission control system of the engine as delivered by Yanmar to the original retail purchaser. Such components may include the following:

- Fuel injection system
- Electronic control system
- Cold start enrichment system
- Intake manifold
- Turbocharger systems
- Exhaust manifold
- EGR system
- Positive crankcase ventilation system
- Hoses, belts, connectors and assemblies associated with emission control systems

Since emissions-related parts may vary slightly between models, certain models may not contain all of these parts and other models may contain the functional equivalents.

#### ■ Exclusions

Failures other than those arising from defects in material and / or workmanship are not covered by this warranty. The warranty does not extend to the following: malfunctions caused by abuse, misuse, improper adjustment, modification, alteration, tampering, disconnection, improper or inadequate maintenance or use of non-recommended fuels and lubricating oils; accident-caused damage, and replacement of expendable items made in connection with scheduled maintenance. Yanmar disclaims any responsibility for incidental or consequential damages such as loss of time, inconvenience, loss of use of equipment / engine or commercial loss.

### ■ Owner's Warranty Responsibilities

**As the engine owner, you are responsible for the performance of the required maintenance listed in your owner's manual.** Yanmar recommends that you retain all documentation, including receipts, covering maintenance on your non-road compression-ignition engine, but Yanmar cannot deny warranty solely for the lack of receipts, or for your failure to ensure the performance of all scheduled maintenance.

Yanmar may deny your warranty coverage of your non-road compression-ignition engine if a part has failed due to abuse, neglect, improper maintenance or unapproved modifications.

Your engine is designed to operate on diesel fuel only. Use of any other fuel may result in your engine no longer operating in compliance with applicable emissions requirements.

You are responsible for initiating the warranty process. You must present your engine to a Yanmar dealer as soon as a problem exists. The warranty repairs should be completed by the dealer as expeditiously as possible.

### ***Garantie du système antipollution limité de Yanmar Co., Ltd. - états-unis uniquement***

#### ■ ***Vos droits et obligations en vertu de la garantie***

##### *• Californie*

*Le California Air Resources Board (CARB), l'agence de protection de l'environnement (EPA) et Yanmar Co., Ltd. ci-après appelé Yanmar, ont le plaisir de vous présenter la **garantie du système antipollution** de votre moteur industriel à allumage par compression. En Californie, les modèles 2000 ou ultérieurs de moteurs hors-route à allumage par compression doivent être conçus, construits et équipés pour répondre aux normes anti-smog strictes de l'État. Dans les États, les modèles 1998 et ultérieurs de moteurs hors route à allumage par compression doivent être conçus, construits et équipés pour répondre aux normes antipollution de l'EPA des États-Unis. Yanmar garantit le système antipollution de votre moteur pendant les périodes présentées ci-dessous à condition que votre moteur ne fasse pas l'objet d'un usage abusif, de négligences ou d'un entretien inapproprié.*

*Votre système antipollution peut comprendre des pièces telles que le système d'injection de carburant, le système d'admission d'air, le système de contrôle électronique et le système EGR (Recirculation des gaz d'échappement). Il peut également inclure des tuyaux, courroies, connecteurs et autres ensembles de pièces du système antipollution.*

*En présence de condition couverte par la garantie, Yanmar réparera gratuitement votre moteur hors route à allumage par compression, le diagnostic étant inclus ainsi que les pièces et la main d'oeuvre.*

### 3. Product Overview

#### ■ Période de garantie du fabricant

Les modèles 1998 ou ultérieurs de moteurs hors route à allumage par compression certifiés et marqués sont garantis pour les périodes présentées ci-dessous. Si une pièce du système antipollution de votre moteur s'avère défectueuse durant la période de garantie applicable, la pièce sera remplacée par Yanmar.

| Type de moteur   | Période de garantie par nombre d'années et heures de fonctionnement   |
|--|---|
| Moteurs à vitesse constante d'au moins 50 hp SAE (37 kW)   | La période de garantie est de cinq (5) ans ou de 3000 heures d'utilisation, quelle que soit la première occurrence. En l'absence d'un dispositif de mesure des heures d'utilisation, le moteur bénéficie d'une période de garantie de cinq (5) ans. |
| Moteurs à vitesse constante de 50 hp SAE (37 kW) maximum présentant des vitesses nominales supérieures ou égales à 3000 tr/min                               | La période de garantie est de deux (2) ans ou de 1500 heures d'utilisation, quelle que soit la première occurrence. En l'absence d'un dispositif de mesure des heures d'utilisation, le moteur bénéficie d'une période de garantie de deux (2) ans. |
| Moteurs à vitesse constante de 50 hp SAE (37 kW) maximum et moteurs d'au moins 26 hp SAE (19 kW) présentant des vitesses nominales inférieures à 3000 tr/min | La période de garantie est de cinq (5) ans ou de 3000 heures d'utilisation, quelle que soit la première occurrence. En l'absence d'un dispositif de mesure des heures d'utilisation, le moteur bénéficie d'une période de garantie de cinq (5) ans. |
| Moteurs d'au moins 26 hp SAE (19 kW)   | La période de garantie est de cinq (5) ans ou de 3000 heures d'utilisation, quelle que soit la première occurrence. En l'absence d'un dispositif de mesure des heures d'utilisation, le moteur bénéficie d'une période de garantie de cinq (5) ans. |
| Moteurs de 26 hp SAE (19 kW) maximum   | La période de garantie est de deux (2) ans ou de 1500 heures d'utilisation, quelle que soit la première occurrence. En l'absence d'un dispositif de mesure des heures d'utilisation, le moteur bénéficie d'une période de garantie de deux (2) ans. |

#### ■ Couverture de la garantie

La présente garantie est transférable à tout acheteur ultérieur pendant la période de garantie. La réparation ou le remplacement de toute pièce sous garantie sera effectuée par un distributeur ou revendeur agréé de moteurs industriels Yanmar.

Les pièces sous garanties, dont le remplacement n'est pas prévu à titre d'entretien requis dans le guide d'utilisation, seront garanties pour la période de garantie. Les pièces sous garanties, dont le remplacement est prévu à titre d'entretien requis dans le guide d'utilisation, sont garanties pour la période précédant le premier remplacement prévu. Toute pièce réparée ou remplacée au titre de la présente garantie sera garantie pour le reste de la période de garantie.

Pendant la période de garantie, Yanmar est responsable des dommages aux autres éléments du moteur dus à la défaillance de toute pièce sous garantie pendant la période de garantie.

Toute pièce de rechange, qui est à tous points de vue fonctionnellement identique à la pièce d'équipement d'origine, peut être utilisée pour l'entretien ou la réparation de votre moteur, et ne réduira pas les obligations de Yanmar en vertu de la garantie. Les pièces ajoutées ou modifiées qui ne font pas l'objet d'une homologation ne peuvent être utilisées. L'utilisation de toute pièce ajoutée ou modifiée ne faisant pas l'objet d'une homologation donnera lieu à un refus de la réclamation au titre de la garantie.

#### ■ **Pièces sous garantie**

La présente garantie couvre les éléments du moteur qui font partie du système antipollution du moteur fourni par Yanmar à l'acheteur au détail d'origine. Ces éléments peuvent comprendre les éléments suivants :

- Système d'injection
- Système de contrôle électronique
- Système d'enrichissement de démarrage à froid
- Tubulure d'admission
- Systèmes de turbocompresseur
- Tubulure d'échappement
- Système EGR
- Système de recyclage des gaz de carter
- Tuyaux, courroies, connecteurs et ensembles de pièces associés aux systèmes antipollution

Étant donné que les pièces du système antipollution peuvent varier légèrement d'un modèle à un autre, certains modèles ne peuvent pas contenir toutes ces pièces et d'autres modèles peuvent contenir les équivalents fonctionnels.

#### ■ **Exclusions**

Les défaillances autres que celles résultant des défauts de pièce et / ou de main d'oeuvre ne sont pas couvertes par la présente garantie. La garantie ne s'étend pas à ce qui suit : les dysfonctionnements dus à un usage abusif, une mauvaise utilisation, un réglage inadéquat, une modification, une altération, une manipulation intempestive, une déconnexion, un entretien inapproprié ou inadéquat, les dommages accidentels dus à l'utilisation de carburants et d'huiles de graissage non-recommandés et le remplacement d'éléments superflus effectué en relation avec l'entretien prévu. Yanmar décline toute responsabilité pour les dommages accessoires ou consécutifs tels que la perte de temps, la gêne, l'impossibilité d'utiliser l'équipement / le moteur ou la perte commerciale.

#### ■ Responsabilités du propriétaire en vertu de la garantie

***En tant que propriétaire du moteur, vous êtes responsable de l'exécution de l'entretien nécessaire indiqué dans votre guide d'utilisation.***

*les reçus, couvrant les travaux d'entretien de votre moteur hors route à allumage par compression, mais Yanmar ne peut refuser la garantie uniquement en raison d'absence de reçus, ou pour défaut d'avoir suivi tout le programme d'entretien.*

*Yanmar peut refuser d'honorer la couverture de garantie de votre moteur hors route à allumage par compression si la défaillance d'une pièce est due à un usage abusif, une négligence, un entretien inapproprié ou à des modifications non approuvées.*

*Votre moteur est conçu pour fonctionner au carburant diesel uniquement. L'utilisation de tout autre carburant peut entraîner la panne définitive de votre moteur conformément aux exigences applicables en matière d'émissions.*

*Vous êtes responsable de l'initiation du processus de garantie. Vous devez présenter votre moteur à un revendeur Yanmar dès qu'un problème se présente. Les réparations couvertes par la garantie doivent être exécutées par le revendeur le plus rapidement possible.*

## 4. Operation License

Before you operate this machine, confirm the licensing requirements that are applicable to the operation of this machine.

Comply with all applicable laws.

Ask your dealer about licensing requirements.

Go to [Discount-Equipment.com](http://Discount-Equipment.com) to order your parts

## 5. Ordering Replacement Parts and Service Call

### 5-1. Location of machine serial number plate

The machine serial number plate is located on the turning frame as illustrated at right. Never remove the plate for any reason.

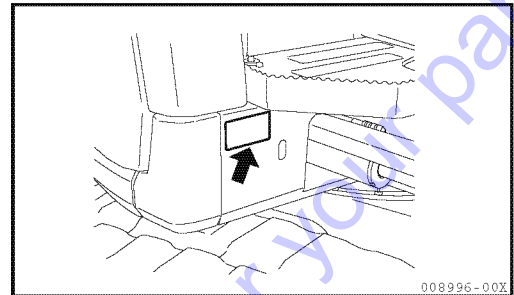

### 5-2. Location of engine serial number plate

The engine serial number plate is located on the top of the cylinder head cover. Never remove the plate for any reason.

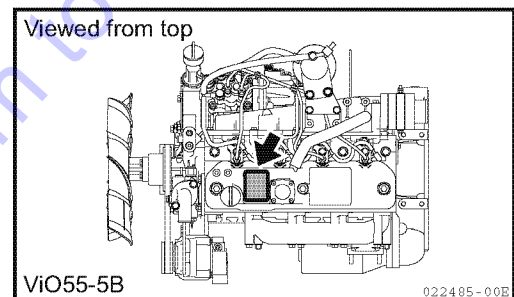
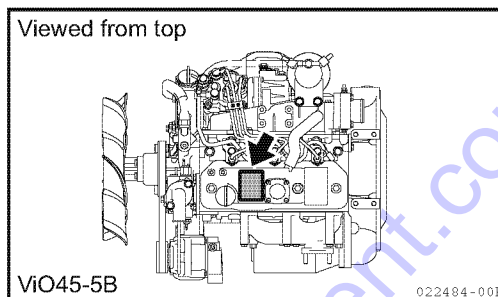

### 5-3. Location of EPA emission control plate

#### *Localisation de la plaque signalétique EPA*

The EPA emission control plate are located on the engine and engine hood as illustrated at right. Never remove the plate for any reason.

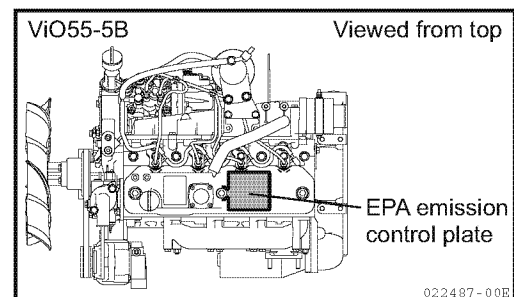
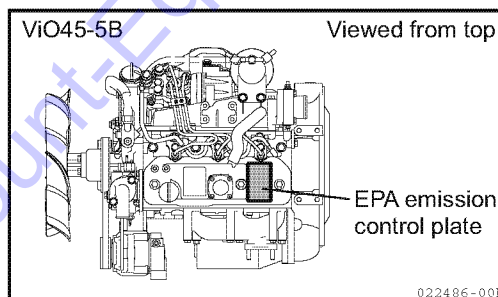

*La plaque signalétique est fixée sur le moteur (voir illustration à droite).*

*En aucun cas ne retirer cette plaque.*

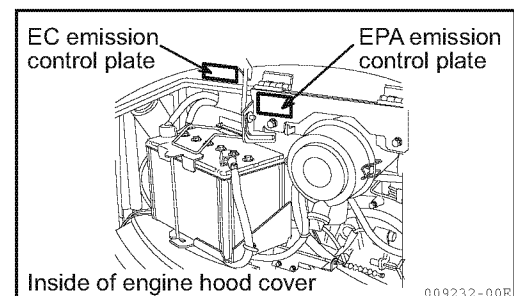

**5-4. Ordering replacement parts and service calls**

When ordering replacement parts or calling for service, let your dealer know the model designation, the machine serial number, and the engine serial number on the machine serial number plate as well as the reading of the hourmeter.

- Machine serial number plate

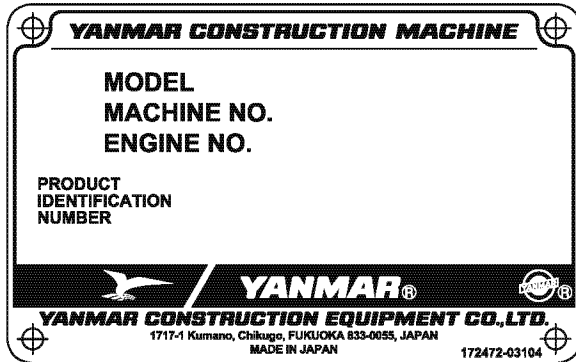

- Hourmeter

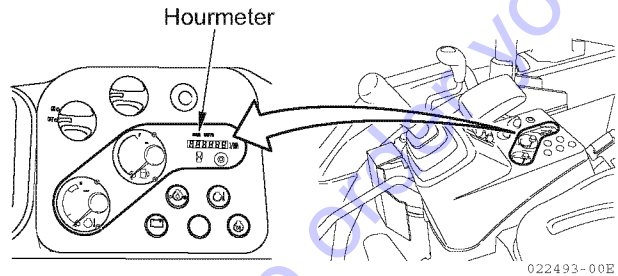

Go to Discount-Equipment.com to buy your parts



## 6. Contents

|  |      |
|--|------|
| 1. Introduction .....  | 0-1  |
| 2. Safety Information .....  | 0-2  |
| 3. Product Overview .....  | 0-3  |
| 3-1. Intended uses .....   | 0-3  |
| 3-2. Break in period .....   | 0-3  |
| 3-3. Conditions to insure compliance with EPA emission standards ..... | 0-4  |
| 3-4. Emission system warranty .....                                    | 0-5  |
| 4. Operation License .....   | 0-11 |
| 5. Ordering Replacement Parts and Service Call.....                    | 0-12 |
| 5-1. Location of machine serial number plate .....                     | 0-12 |
| 5-2. Location of engine serial number plate .....                      | 0-12 |
| 5-3. Location of EPA emission control plate .....                      | 0-12 |
| 5-4. Ordering replacement parts and service calls.....                 | 0-13 |
| 6. Contents .....  | 0-14 |

### SAFETY

|   |      |
|---|------|
| 7. Basic Precautions .....  | 1-2  |
| 8. Operating Precautions .....                                      | 1-6  |
| 8-1. Precautions before starting the engine .....                   | 1-6  |
| 8-2. Precautions for starting the engine, working and parking ..... | 1-8  |
| 8-3. Precautions for transportation .....                           | 1-13 |
| 8-4. Precautions for the battery .....                              | 1-14 |
| 8-5. Precautions for towing .....                                   | 1-15 |
| 8-6. Precautions for hooked bucket .....                            | 1-16 |
| 9. Precautions for Servicing .....                                  | 1-19 |
| 9-1. Precautions before servicing .....                             | 1-19 |
| 9-2. Precautions during servicing .....                             | 1-21 |
| 10. Safety Messages (Warning Labels) .....                          | 1-25 |
| 10-1. Location of warning labels .....                              | 1-25 |
| 11. SAFETY (ViO55-5B Angle blade spec.).....                        | 1-33 |
| 11-1. Safety Messages (Warning Labels) .....                        | 1-33 |
| 11-2. Operating Precautions .....                                   | 1-34 |

### OPERATION

|   |      |
|---|------|
| 12. Identification of Important Parts ..... | 2-2  |
| 12-1. Overview of the machine .....         | 2-2  |
| 12-2. Controls and switches .....           | 2-3  |
| 13. Description of Control Devices .....    | 2-4  |
| 13-1. Monitor .....                         | 2-4  |
| 13-2. Switch .....                          | 2-7  |
| 13-3. Control levers and pedals .....       | 2-10 |

|   |      |
|---|------|
| 13-4. Engine hood B .....   | 2-14 |
| 13-5. Engine hood rear cover.....   | 2-14 |
| 13-6. Storage space for the operation & maintenance manual.....           | 2-15 |
| 13-7. Windshield (for cabin) .....  | 2-16 |
| 13-8. Operator's seat .....   | 2-18 |
| 13-9. Ash tray (for cabin).....   | 2-19 |
| 13-10. Headlight.....   | 2-19 |
| 13-11. Air outlet (for cabin).....  | 2-20 |
| 13-12. Right window glass (for cabin) .....                               | 2-20 |
| 13-13. Cabin side door.....   | 2-21 |
| 13-14. Replenishment of windshield washer fluid .....                     | 2-21 |
| 13-15. Fuse .....   | 2-22 |
| 14. Operating Instructions .....  | 2-23 |
| 14-1. Checking before starting the engine .....                           | 2-23 |
| 14-2. Starting up the engine .....  | 2-33 |
| 14-3. Operating and checking instructions after starting the engine ..... | 2-36 |
| 14-4. Traveling .....   | 2-38 |
| 14-5. Steering.....   | 2-42 |
| 14-6. Stopping the machine .....  | 2-44 |
| 14-7. Swinging the upperstructure .....                                   | 2-45 |
| 14-8. Operating the implements.....                                       | 2-46 |
| 14-9. Precautions for operating the implement.....                        | 2-47 |
| 14-10. Precautions for working .....                                      | 2-50 |
| 14-11. Precautions for going up and down a slope.....                     | 2-51 |
| 14-12. Escaping from the mud .....  | 2-53 |
| 14-13. Operations using the bucket.....                                   | 2-54 |
| 14-14. Handling quick coupler.....  | 2-55 |
| 14-15. Parking the machine .....  | 2-65 |
| 14-16. Inspection requirements after completing operation .....           | 2-66 |
| 14-17. Stopping the engine .....  | 2-67 |
| 14-18. Inspection requirements after stopping the engine .....            | 2-68 |
| 14-19. Locking.....   | 2-68 |
| 14-20. Handling the rubber track (for rubber track type).....             | 2-69 |
| 14-21. Handling hydraulic P.T.O. ....                                     | 2-74 |
| 14-22. Replacing the bucket without the quick coupler.....                | 2-78 |
| 15. Transportation .....  | 2-80 |
| 15-1. Loading and unloading the machine .....                             | 2-80 |
| 15-2. Precautions for loading the machine.....                            | 2-82 |
| 15-3. Precautions for transporting the machine .....                      | 2-83 |
| 15-4. Suspending the machine .....  | 2-84 |
| 16. Care and Service in Cold Weather.....                                 | 2-86 |
| 16-1. Preparing for cold weather .....                                    | 2-86 |

## 6. Contents

---

|   |       |
|---|-------|
| 16-2. Precautions after a day's work .....      | 2-88  |
| 16-3. After cold weather ends .....             | 2-88  |
| 17. Long-term Storage .....                     | 2-89  |
| 17-1. Before storing.....                       | 2-89  |
| 17-2. Storing.....                              | 2-90  |
| 17-3. Using the machine again .....             | 2-90  |
| 18. Troubleshooting .....                       | 2-91  |
| 18-1. Phenomena that are not breakdowns .....   | 2-91  |
| 18-2. Towing .....                              | 2-92  |
| 18-3. If the battery is overdischarged .....    | 2-93  |
| 18-4. Troubleshooting .....                     | 2-98  |
| 19. OPERATION (ViO55-5B Angle blade spec.)..... | 2-100 |
| 19-1. Identification of Important Parts .....   | 2-100 |
| 19-2. Description of Control Devices.....       | 2-102 |
| 19-3. Operating Instruction.....                | 2-103 |
| 19-4. Troubleshooting .....                     | 2-104 |

### MAINTENANCE

|   |      |
|---|------|
| 20. Precautions for Servicing .....                               | 3-2  |
| 21. Basic Servicing Practices .....                               | 3-5  |
| 21-1. Oils, fuel, and cooling water.....                          | 3-6  |
| 21-2. Electrical equipment.....                                   | 3-9  |
| 21-3. Hydraulic system.....                                       | 3-10 |
| 22. Consumables .....   | 3-11 |
| 23. Fueling, Oiling and Greasing Based on Temperature Range ..... | 3-12 |
| 23-1. Fuel and oil .....  | 3-12 |
| 23-2. Cooling water .....   | 3-12 |
| 24. Standard Tightening Torque for Bolts and Nuts .....           | 3-13 |
| 24-1. Required tools.....   | 3-13 |
| 24-2. Torque table.....   | 3-14 |
| 25. Replacing Essential Parts Periodically .....                  | 3-15 |
| 26. Maintenance Table.....  | 3-17 |
| 26-1. Table of service time intervals .....                       | 3-17 |
| 26-2. Service intervals when using the hydraulic breaker.....     | 3-21 |
| 27. Procedures for Maintenance .....                              | 3-22 |
| 27-1. First services.....   | 3-22 |
| 27-2. Nonperiodic services.....                                   | 3-23 |
| 27-3. Checking before start-up.....                               | 3-40 |
| 27-4. Maintenance every 50 service hours .....                    | 3-48 |
| 27-5. Maintenance every 100 service hours .....                   | 3-49 |
| 27-6. Maintenance every 250 service hours .....                   | 3-50 |
| 27-7. Maintenance every 500 service hours .....                   | 3-57 |

|   |      |
|---|------|
| 27-8. Maintenance every 1000 service hours .....  | 3-61 |
| 27-9. Maintenance every 2000 service hours .....  | 3-64 |
| 28. MAINTENANCE (ViO55-5B Angle blade spec.)..... | 3-65 |
| 28-1. Procedures for maintenance .....            | 3-65 |

### **SPECIFICATIONS AND DIMENSIONAL DIAGRAMS**

|  |     |
|--|-----|
| 29. Specifications and Dimensional Diagrams .....                              | 4-2 |
| 30. SPECIFICATIONS AND DIMENSIONAL DIAGRAMS (ViO55-5B Angle Blade Spec.) ..... | 4-6 |

### **OPTIONAL PARTS AND ATTACHMENTS**

|  |     |
|--|-----|
| 31. General Precautions .....  | 5-2 |
| 31-1. Safety precautions .....                                       | 5-2 |
| 31-2. Precautions for mounting an attachment (implement) .....       | 5-3 |
| 32. Handling the Hooked Bucket.....                                  | 5-4 |
| 32-1. Checking the hooked bucket for damage .....                    | 5-4 |
| 32-2. Prohibitions .....   | 5-4 |
| 32-3. Precautions .....  | 5-4 |
| 33. Optional Parts and Attachments .....                             | 5-5 |
| 33-1. Optional parts and attachments .....                           | 5-5 |
| 34. Handling Air Conditioner (for Cabin) .....                       | 5-6 |
| 34-1. Description of lever and switches for air conditioner.....     | 5-6 |
| 34-2. How to use air conditioner .....                               | 5-7 |
| 34-3. Maintenance, inspection and servicing of air conditioner ..... | 5-9 |

### **NOTES**

|                          |     |
|--------------------------|-----|
| 35. Maintenance Log..... | 6-2 |
| 36. Notes .....          | 6-6 |

# SAFETY

## **WARNING**

Never attempt to operate or service this Excavator until you have first read and understood all of the applicable Safety Instructions that are set forth in this Manual.

The failure to comply with all relevant Safety Instructions could result in bodily injury.

## 7. Basic Precautions

**⚠ WARNING** These instructions should be strictly followed for the safety of you, others and your machine.

### Follow safety rules at your workplace

- The operation and servicing of this machine is restricted to qualified persons.
- When operating or servicing the machine, follow all the safety rules, precautions and procedures.
- Any work performed by a team or with a signal person should be conducted in accordance with signals agreed on beforehand.

### Install safety devices

- Make sure that all guards and covers are installed in their correct position. If any of them are damaged, repair them immediately.
- The proper use of all safety devices, such as lock lever, should be well understood by the machine operator.
- Never remove the safety devices. Always make sure that they operate properly.  
**For lock lever, refer to Section "13-3. Control levers and pedals".**
- Incorrect operation of the safety devices could cause serious bodily injury.

### Wear proper clothing and safety items

- Do not wear loose clothing or jewelry that can be caught on the control levers and other machine parts. Also avoid wearing working clothes stained with oil as they can ignite.
- Be sure to wear a helmet, safety goggles, safety shoes, a mask, gloves and other protective items, as appropriate. Take particular precautions when generating metal debris, when striking metal objects with a hammer or when cleaning components with compressed air.

Also make sure there are no persons near the machine.

**For driving the pins, refer to Section "14-22. Replacing the bucket without the quick coupler".**

**For cleaning the elements, refer to Section "27-2. Nonperiodic services".**

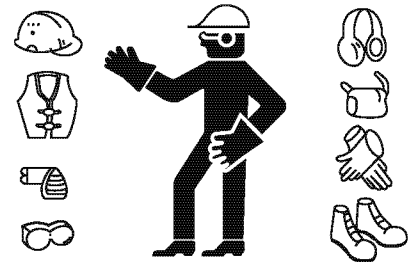

### Alcohol

- Never operate the machine while you are under the influence of alcohol or when you are ill or feel unwell as this results in accidents.

**Avoid unauthorized modifications**

- Modifications not recommended by YANMAR may cause safety hazards.
- When you wish to modify your machine, contact your dealer. The implementation of unauthorized modifications or the use of unauthorized attachments could result in bodily injury, since those actions would also violate, the terms of YANMAR's Warranty, it would be voided

**Always lock up your machine when leaving the operator's seat**

- When leaving the operator's seat, be sure to place the lock lever in the lock position, to prevent accidental machine movement which could result in bodily injury.
- When you leave the machine:
  - (1) Lower the bucket to the ground.
  - (2) Place the lock lever in the lock position.
  - (3) Stop the engine.
  - (4) Set all the locks in to the lock position.
  - (5) Be sure to take the key out of the starter switch.

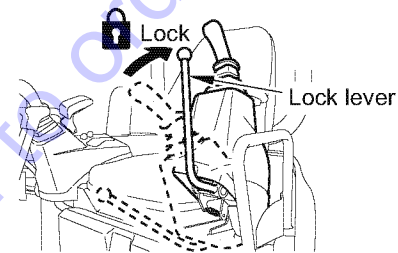

(Left side) 008999-00E

**For information on parking the machine, refer to Section "14-15. Parking the machine".**

**Use handrails and steps when getting on and off**

- Do not jump on or off the machine. Never get on or off a machine in motion as it may result in bodily injury.
- When getting on and off the machine, face the machine and use the handrails and steps.
- Do not use control levers as handrails.
- Make sure that you maintain three point contact with the handrails or the steps.
- If the handrails and the steps are soiled with oil or dirt, clean them off immediately. Repair any damaged parts and retighten any loose bolts.

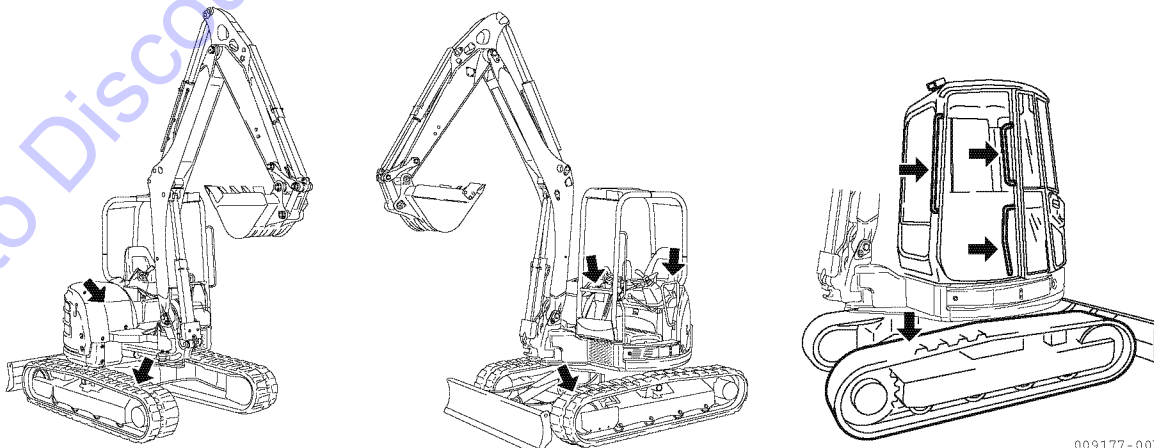

009177-00X

### Keep fuel and oil away from sources of ignition

- Open flames can ignite fuel, oil, hydraulic oil or antifreeze solutions, which are flammable and dangerous. Special attention must be paid to the following matters.
  - Keep flammable materials away from lighted cigarettes or matches, or any other sources of ignition.
  - Never refuel while the engine is running. Smoking during refueling must be strictly prohibited.
  - Firmly tighten the caps on the fuel and oil tanks.
  - Store fuel and oil in a cool and well-ventilated place where they are not subjected to direct sunlight.
  - Fuel and oil must be stored in a place which meets all applicable safety regulations. Unauthorized persons should not be allowed entry.

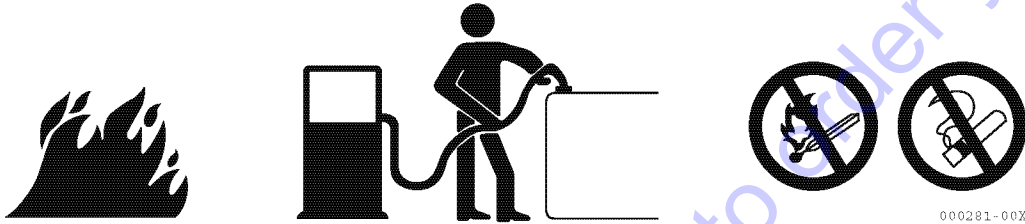

### Avoid removing filler caps while temperatures are high

- The engine coolant, engine oil and hydraulic oil are hot and under pressure immediately after the machine stops operation. Removing caps, draining coolant or oil, or replacing a filter at such a time may cause burns. Allow temperatures to cool down and follow the procedures in this manual.
- When removing the radiator cap, stop the engine and allow the coolant to cool down, then turn the cap slowly to relieve all pressures.
- Before removing the cap from the hydraulic oil tank, stop the engine and turn the cap slowly to relieve all pressure to prevent oil from spouting out.

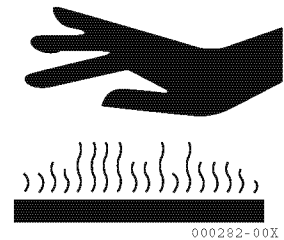

### Avoid harmful asbestos dust

- Air containing asbestos dust is carcinogenic and is hazardous to humans. Inhalation of the air may cause lung cancer. When handling materials that may contain asbestos, keep in mind that:
  - Compressed air must not be used for cleaning.
  - Water must be used to clean the machine to prevent asbestos from scattering in the air.
  - You must work on the windward side when operating the machine in a place where there may be asbestos dust.
  - You should wear breathing apparatus as necessary.





**Prevent crush injuries by the implements**

- Keep hands, arms and all other parts of your body away from all the moving parts, particularly between the implements and the machine and between the hydraulic cylinder and the implements, as pinch points are created in those areas.



000284-00X

**Keep a fire extinguisher and first aid kit handy**

- The workplace must be provided with a fire extinguisher. Read instructions on the label to familiarize yourself with how to use it.
- Keep a first aid kit in a prescribed place.
- Advise what to do in the event of fire or accidents.
- Indicate who to contact in an emergency and keep their telephone number in a prominent place.

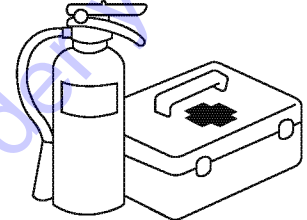

000285-00X

**Precautions for installing optional parts and attachments**

- When installing or using optional attachments, read the operating instructions for the attachments and the Manual Sections relating to the installation of attachments.
- Use only attachments authorized by YANMAR. The use of unauthorized attachments may affect not only the safety of the machine but also the proper operation and life of the machine.
- The use of unauthorized attachments would also violate the terms of YANMAR's Warranty, so that it would be voided.

**Caution for cabin glass**

- If the glass of the cabin should be broken by accident, it is very dangerous since the operator's body might contact the implement directly. Immediately stop working to replace the broken glass with a new one.

## 8. Operating Precautions

**⚠ WARNING** These instructions should be strictly followed for the safety of you, others and your machine.

### 8-1. Precautions before starting the engine

#### Ensure the safety of your workplace

- Before starting the machine, check to see if there are any hazards in your working area.
- Examine the terrain and soil, and decide the best way to do the work.
- When working on the street, provide a signal person or fence for the safety of vehicles and pedestrians.
- If there are underground utilities at the work site, such as water pipes, gas pipes, high-voltage conduits or others, contact the responsible companies to locate them exactly, so as not to damage them.
- Before operating the machine in water, or crossing a creek, confirm the condition of the submerged ground, the water depth and the water flow speed, and make sure that the depth is within the allowable level.

**For allowable water depth, refer to Section "14-10. Precautions for working".**

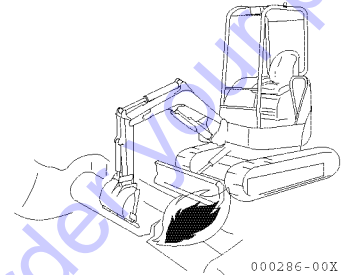

#### Prevent fire

- Wood chips, dead leaves, trash and other flammable materials in proximity to the engine are hazardous as they may cause fire. Always check and keep your machine clear of these flammable materials.
  - Check for any leaks from fuel, lube oil or hydraulic oil lines. Repair faults and clean spilled oil as necessary.
- For additional information, refer to Section "14-1. Checking before starting the engine".**
- Check to see where fire extinguishers are located and know how to use them.

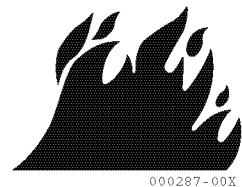

#### Inspect around the operator's seat

- Dirt, oil and snow on the floor, levers, handrails or steps are slippery and hazardous. Remove them all completely.
- Keep parts and tools away from the operator's seat as they may damage the control levers or switches or create any other hazards.

**Provide adequate ventilation when working in an enclosed area**

Engine exhaust fumes are harmful to the human body and their inhalation is extremely hazardous. When starting the engine in an enclosed area, open the windows and doors for ventilation. Also do not idle the engine unnecessarily or leave the engine running while the machine is not in use.



**Keep the cabin window clean**

- Keep the surface of the cabin windows and the headlights clean for clear view.
- Make sure that your machine is equipped with headlights and all required working lamps, and that they work properly.

**Fasten the seatbelt**

- For your safety, ROPS (Roll-Over Protective Structure)/FOPS (Falling Objects Protective Structures) with a seatbelt is installed.
- Always fasten the seatbelt across the pelvic region and adjust snugly before you operate the machine.  
Never fasten a seatbelt across the abdomen.
- The seatbelt must be replaced after an accident.
- In addition the seat and seat mounting must be checked by your dealer after an accident has occurred.
- If the seat and seat mounting are damaged, they must be replaced.

**ROPS/FOPS**

- Never modify the structural member of ROPS/FOPS.
- If ROPS/FOPS is damaged, replace it immediately to prevent bodily injury.  
Never repair or modify it.

**Caution for the protection of plants from hot wind**

The hot wind of the high temperature is exhausted from the muffler and the radiator.

If this hot wind hits plants directly, they will die.

Give a cover board to protect plants from the hot wind when working near the arranging fence or plant.

## 8-2. Precautions for starting the engine, working and parking

### Signal before starting the engine

- Check the machine carefully before initial start up for the day.
- Make sure there are no persons near the machine before getting on it.
- Never start the engine when the "SERVICING IN PROGRESS" tag is attached to the control system.
- Sound the horn to alert people nearby before starting the engine.
- Be sure to start the engine and operate the machine from the operator's seat only.
- Do not allow any other persons to get on the machine.

### Check the position of the blade before operating the machine

- Check the position of the blade before operating the travel levers. When the blade is located in the back, the operation of the travel levers is reversed.

**For instructions on How the machine travels, refer to Section "14-4. Traveling".**

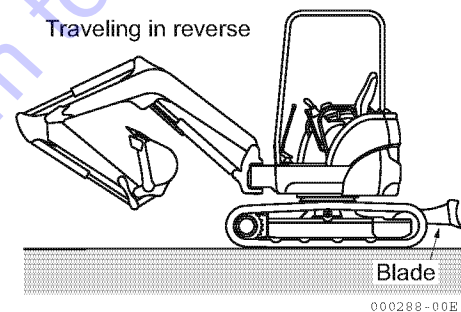

### Make sure there are no persons nearby when turning or reversing the machine

- A signal person should be provided for safety when the work site is hazardous or when visibility is poor.
- Keep all other persons away from the work site or the traveling path of the machine.
- Alert persons nearby with a horn or other signal before starting the machine.
- The machine permits a limited range of vision toward the rear. Make sure there are no persons behind the machine before reversing.

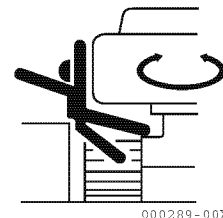
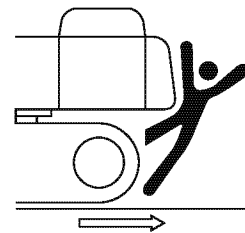

### Precautions for traveling

- When traveling with the machine, keep the bucket 16 to 20 in. (40 to 50 cm) above the ground with boom and arm folded as illustrated below.
- If you need to operate the control levers while traveling, never move them abruptly.
- Travel the machine at a low speed and slow down when turning on rough terrain.
- Avoid running over obstacles if possible. If unavoidable, run the machine at a low speed while keeping the implement close to the ground. Never run over obstacles that may cause the machine to tilt more than 10 degrees.

Orientation in travel

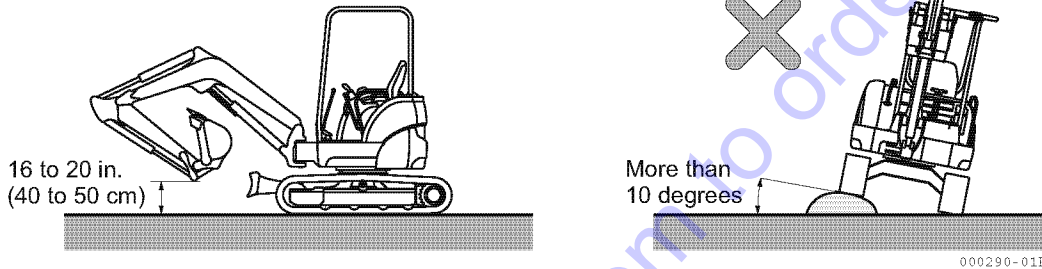

### Running the machine on a slope

- Run the machine carefully on a slope to avoid overturning or skidding sideways.
  - When running the machine on a slope, keep the bucket 8 to 12 in. (20 to 30) cm above the ground so that you can immediately lower it to the ground and stop the machine in an emergency.
  - Never turn the machine on a slope or run it across the slope.  
Move down to flat ground and then make a turn.
- For instructions on how to run the machine on a slope, refer to Section "14-11. Precautions for going up and down a slope".**
- On grasses, dead leaves or a wet metal plate, even with a slight gradient, the machine will easily slip. Under those circumstances, run the machine carefully at low speed to prevent it from skidding.

Going down a slope

Going up a slope

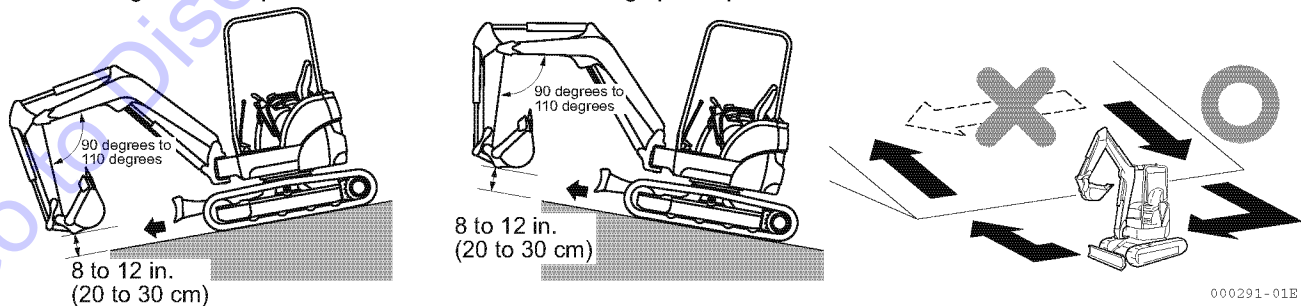

**Avoid hazardous work**

- Undermining a cliff is dangerous as it may cause a rockslide or landslide.
- Undercutting the machine is dangerous as it may cause a cave-in, resulting in the machine overturning and falling into the excavation.

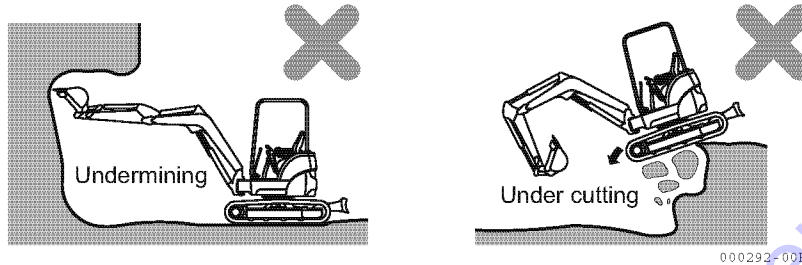

**Never suspend loads without a hooked bucket**

- Suspending loads without a hooked bucket is extremely hazardous.
- To suspend loads, the machine must be equipped with a hooked bucket specifically designed for the purpose.

**For information on suspending loads, refer to Section "14-9. Precautions for operating the implement".**

**⚠ DANGER**

**Keep away from electric power lines**

- Working in the vicinity of overhead electric power lines presents a very serious hazard and special precautions must be taken. For purposes of this manual you are considered to be working in the vicinity of overhead power lines when the attachment or load of your excavator, in any position, can reach to within the minimum distances shown below.
- The following procedures are effective in preventing accidents or injuries.
  - 1) Wear shoes with rubber or leather soles.
  - 2) Use a signal person to warn the operator when the machine is getting too close to a power line.
- If the machine should contact a wire, the operator must not leave the seat.
- When working near power lines, caution all ground personnel to stand clear of the machine.
- To determine the transmission voltage at the working site, contact the electric utility concerned.

|                    | Transmission voltage (V) | Minimum safe distance [ft. (mm)] |
|--------------------|--------------------------|----------------------------------|
| Power distribution | 100/200 or less          | 6.6 (2000) or more               |
|                    | 6600 or less             | 6.6 (2000) or more               |
| Transmission line  | 22000 or less            | 9.8 (3000) or more               |
|                    | 66000 or less            | 13.1 (4000) or more              |
|                    | 154000 or less           | 16.4 (5000) or more              |
|                    | 275000 or less           | 23.0 (7000) or more              |

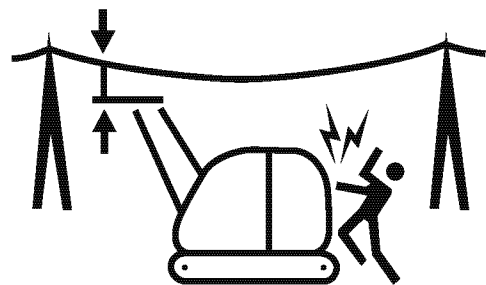

**Prevent bumping the implements**

- When traveling through tunnels or under bridges, or working at a site near other overhead obstacles, operate the machine carefully so as not to bump the boom, arm, or the implement against those overhead obstacles.

**Work only where visibility as good**

- When working in a dark place, light up the area with the work lights and head lights, and prepare extra lighting equipment as necessary.
- Stop working when fog, snow or rain impedes your view.

**Work carefully in a snow-covered areas**

- A snow-covered ground and icy roads are dangerous as they may cause the machine to skid even on a slight slope. Run the machine at low speed, and never start, stop or turn abruptly on such ground or under such road conditions.
- Be careful removing snow as road shoulders or other hazards may be buried under snow.

**Unstable ground creates a high possibility of overturn**

- Keep away from cliffs, road shoulders or trenches if possible as the ground near them is unstable. The ground may crumble due to the weight or vibrations of the machine, resulting in an overturn or fall of the machine. Be particularly careful when working immediately after rainstorm or after blasting as the ground may be unstable.
- Ground-fills or ground near a ditch may be unstable and may crumble due to the weight or vibrations of the machine, causing the machine to tilt. Much caution must be taken in working in these areas.
- When working in an area where is a high possibility of falling rocks, wear a hard-hat and stay under the canopy.

**Using the quick coupler**

- Observe the procedures of mounting and dismounting the bucket.
- Always securely and correctly install the lock pin when the bucket is mounted on the quick coupler.
- Replace the lock pin whenever it is damaged or lost.

**For information of handling the quick coupler, refer to Section "14-14. Handling quick coupler".**

### Working on a slope

- Be aware that the machine may tip over when swinging the upperstructure or swinging the implement on a slope.
- Never swing the upperstructure toward the downward side of the slope with earth loaded in the bucket.  
(See the illustration at upper right.)
- If swinging is unavoidable, level off a work area to maintain the machine as horizontal as possible, then swing.  
(See the illustration at lower right.)

**For levelling off a work area, refer to Section "14-11. Precautions for going up and down a slope".**

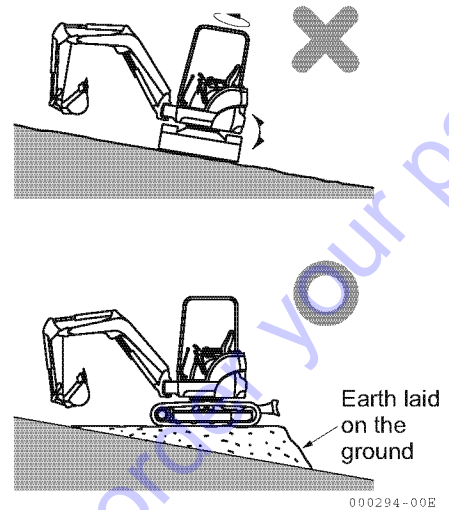

### Parking the machine

- Park on level ground. If park on a slope is unavoidable, block the tracks with solid pieces of wood and dig the bucket into the ground. (See the illustration at right.)
- If necessary to park the machine on the side of a road, set up a warning flag, fence, or lamp that can be easily recognized by passing cars and pedestrians but does not impede them.

**For parking procedures, refer to Section "14-15. Parking the machine".**

- When leaving the operator's seat, do the following:
  - (1) Be sure to place the bucket on the ground.
  - (2) Set the lock lever to the lock position.
  - (3) Stop the engine.
  - (4) Set all the locks to the lock position.
  - (5) Be sure to take the key out of the starter switch.

**For information about parking procedures, refer to Section "14-15. Parking the machine".**

**For information about the parts to be locked, refer to Section "14-19. Locking".**

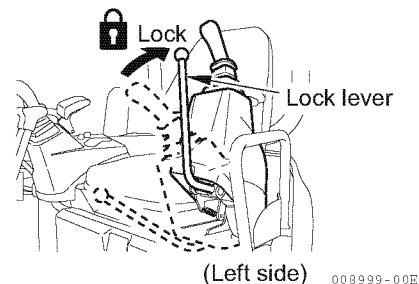
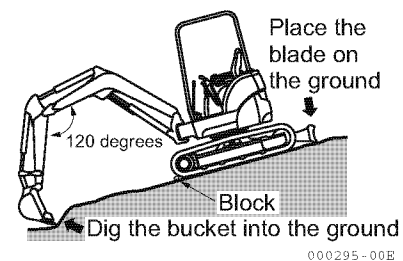



### 8-3. Precautions for transportation

#### Precautions for loading and unloading the machine

- Be careful in loading and unloading the machine, because it is a job of high hazard potential.
- Load or unload the machine at a low engine speed, and low travel speed.
- Load or unload the machine on the level, solid ground away from the shoulder of the road.
- Use ramp plates of adequate strength with hooks on their ends.

Check to see that the ramp plates are wide, long, and thick enough to sustain the load so that you can load or unload the machine safely. Support the ramp plates with blocks, to provide additional strength.

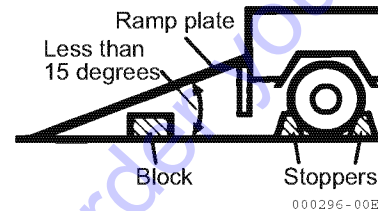

- Securely hook the ramp plates to the deck of the truck so that they will not come off.
- Remove grease, oil, and other slippery deposits from the ramp plates, and remove mud from the tracks to prevent the machine from skidding on the ramp plates.
- Do not load or unload the machine if the ramp plates are slippery because of rain, snow or ice.
- Never change travel direction while on the ramp plates. If you need to change travel direction, go down the ramp plates, and change direction on the ground.
- After loading the machine, block it with lumber and secure the machine with a chain or a wire rope so that the machine will not move during transit.

**For instructions on loading and unloading the machine, refer to Section "15. Transportation".**

**For instructions on securing the machine, refer to Section "15. Transportation".**

#### Precautions for transporting

- Transport the machine safely in accordance with the laws associated with applicable law.
- Select a travel route consistent with the width, height and weight of the machine loaded on the truck.

**8-4. Precautions for the battery** **DANGER****Be careful in handling the battery**

- The battery electrolyte contains dilute sulfuric acid, which can severely burn the eyes or skin. Always wear safety goggles and protective clothing when servicing the battery. If contact with the eyes or skin should occur, flush with a large amount of water and obtain prompt medical treatment.
- Because flammable hydrogen gas is produced by the battery, ignition and explosion may occur. Keep flames and sparks away from the battery.
- Do not use or charge the battery if the battery electrolyte level is below the lower limit. Doing so may cause the battery to explode. Always check the battery electrolyte level before starting the engine. If the electrolyte level is low, add distilled water to the upper limit.
- If you swallow battery electrolyte by mistake, drink a large amount of water, milk, or fresh eggs, and obtain medical treatment immediately.
- Before checking or handling the battery, be sure to stop the engine and turn the starter switch to the "OFF" position.
- Be careful not to cause a short circuit by placing a tool across the terminals of the battery.
- If a terminal connection is loose, sparks may be generated due to contact failure, causing possible ignition and explosion. Be sure to connect the terminals securely.

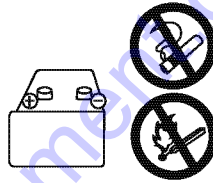
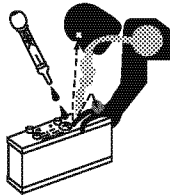

000297-00X

 **WARNING****Observe the procedures for starting the engine using booster cables**

- When you start the engine using booster cables, wear safety goggles.
- If you start the engine by taking electric power from another machine, do not allow your machine to contact the other machine.
- To connect the booster cables, begin with the positive terminal, and to disconnect them, begin with the negative terminal (ground side).
- If a tool simultaneously touches the positive terminal and the machine, potentially hazardous sparks may be generated.
- Do not connect the booster cables to the terminals in reverse polarity. In other words, never connect the negative terminal on one machine to the positive terminal on the other machine.
- As the last step, connect the negative booster cable terminal to the upper structure frame. At that time, sparks will be generated. Consequently, connect the terminal to a point as far away from the battery as possible.

**For information about starting the engine using booster cables, refer to Section "18-3. If the battery is overdischarged".**

### 8-5. Precautions for towing

#### Hook the wire rope on the frame when towing

- Improper towing procedures can cause death or serious injury.
- When towing a machine with another machine, use a wire rope strong enough to sustain the machine weight.
- Never tow a machine on a slope.
- Do not use a towing rope that is kinked, distorted or damaged.
- Do not ride on the towing cable or on the wire rope.
- When connecting an object to be towed, make sure that no person enters the space between the machine and the object.
- To connect an object to be towed, hook the sling belt as illustrated at right.
- The hook provided on the machine is intended for stabilizing the machine during transporting. Never use it for towing.

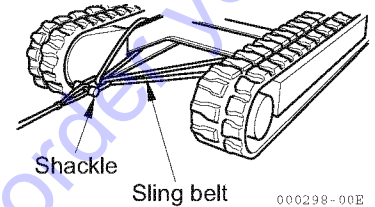

**For information about towing the machine, refer to Section "18-2. Towing".**

**8-6. Precautions for hooked bucket****8-6-1. General precautions****Special hook**

- A dedicated hook is required for suspending a load.
- The following procedures are extremely dangerous and must never be attempted:
  - Suspending a load with a wire rope hooked on the bucket teeth
  - Suspending a load with the wire rope directly hooked on the boom or the arm

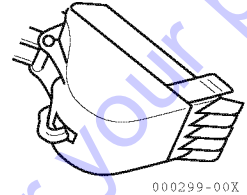
**Checking the hook**

- Check for abnormalities before suspending a load, as follows:
  - No cracks or deformations in the suspension sling belt and fittings
  - No abnormalities in the locking devices
- Every time you make a voluntary monthly check or a specified annual check, check all suspension gear for abnormalities and enter the results in the inspection records.

**Securely attach a wire rope to the hook**

- To suspend a load, securely attach a wire rope to the dedicated suspension hook.

**Precautions for selecting a place to park the machine**

- Survey the terrain and soil and select a solid, level spot for parking the machine, for maximum stability.

**Do not use the machine for other than the specified purpose**

- Never suspend a person together with the load, under any circumstances, because of the extreme danger.

**Keep out of the radius of the work area**

- Never permit anyone to enter the work area because of the danger of spilling or swinging the load.

**Designate a leader to supervise suspension work**

- When suspending a load, designate a leader to supervise the work and follow the leader's instructions.
- Follow the leader's instructions for the handling methods and procedures.
- Define hand signals in advance for communicating, and respond to the leader's signals.

**Handling the wire rope**

- When handling the wire rope, use leather gloves.

**For additional information about the hooked bucket, refer to Section "32. Handling the Hooked Bucket".**

### 8-6-2. Precautions for suspending a load

#### Move a suspended load slowly

- Raise and swing a suspended load slowly.
- Do not operate the control levers or the accelerator lever abruptly.
- The swing speed is three to four times higher than that of a truck crane. Swing the upper structure slowly.

#### Do not leave the operator's seat

- Never leave the operator's seat with a load suspended.

#### Do not operate the machine unsafely

- Working beyond the machine's capacity can cause accidents or failures. Suspend loads within the machine's capacity.
- Do not suspend a load greater than the specified maximum, or subject to a sharp impact. Those actions may damage the machine.
- Do not move the suspended load sideways or toward the machine, or haul it. Those actions are extremely dangerous.

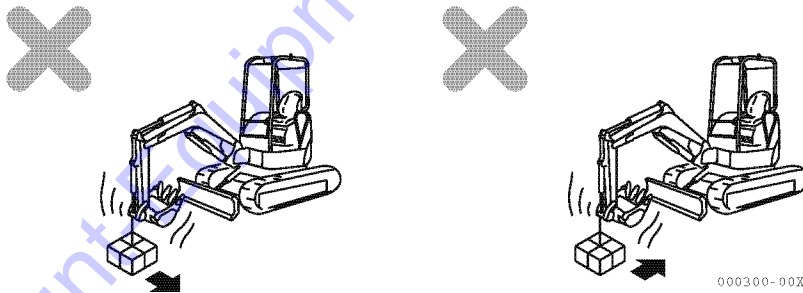

#### Do not travel while suspending a load

- Do not travel while suspending a load.

#### Make sure of the posture of the machine

- If the bucket hook is not maintained in a vertical position, the wire rope or the shackle may slip off the hook. Be careful to maintain a vertical hook angle, so that the wire rope or the shackle will not come off.

## 9. Precautions for Servicing

**⚠ WARNING** Neglecting these instructions may cause extreme hazards.

### 9-1. Precautions before servicing

#### Attach the "SERVICING IN PROGRESS" tag to an implement control lever

- If another person should start the engine or operate the control levers while service is in progress, the service personnel can sustain serious bodily injury.

Attach the "SERVICING IN PROGRESS" tag indicating "Servicing in Progress" to one of the implement control levers.

The "SERVICING IN PROGRESS" tag is enclosed with the Operation Manual.

Article number : 172437-03250

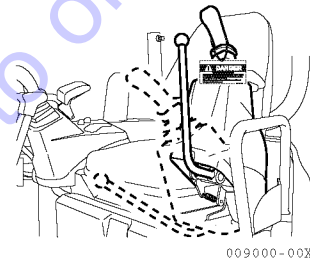

#### Use appropriate tools

- Using damaged or worn tools or using tools inappropriate for the required application is very dangerous, and may also cause damage to the machine. Make sure to use the tools that are appropriate for the specific job.

**For information about tools, refer to Section "24-1. Required tools".**

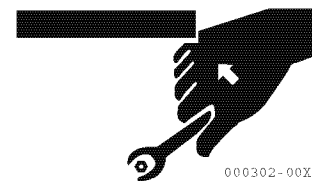

### Periodically replace the parts essential to safety

- Aging or damage to the parts listed below can cause a fire. Make sure that they are replaced periodically.
  - Fuel system : Fuel hose and fuel tube cap
  - Hydraulic system : Outlet hose of main pump
- The parts listed above must be replaced periodically even if no abnormality is found in them. (They age with time.)
- If any abnormality is found in them, replace or repair the parts even though the suggested replacement time has not been reached.

**For information about replacing essential safety parts, refer to Section "25. Replacing Essential Parts Periodically".**

### Stop the engine before beginning the inspection and servicing

- Be sure to stop the engine before performing inspection and servicing.
- If necessary to perform service while running the engine, as when cleaning the inside of the radiator, be sure to set the lock lever to the lock position and do the job together with a partner. (One should take the operator's seat so that he or she can stop the engine at any time.) That person must be careful not to touch any levers in the cabin.
- Be extremely careful not to contact the moving fan or fan or fan belt, or any hot surfaces.

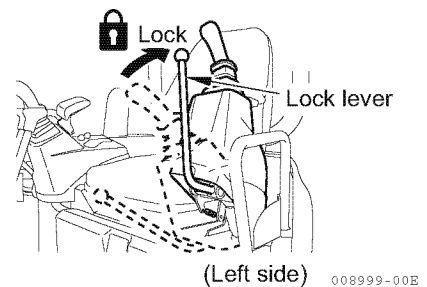
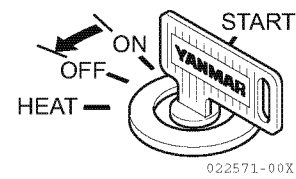



## 9-2. Precautions during servicing

### Keep unauthorized persons away

- Never admit any persons into the work area who are not taking part in the work. Be conscious of the safety of other persons.  
Be especially careful when grinding, welding, or using a large hammer.

### Removed attachments

- When an attachment is placed on the ground or against a wall after removing it or prior to reinstalling it, be sure that it is stable to prevent it from falling down.



000304-00X

### Working under the machine

- Before performing service or repairs underneath the machine, place the implement on the ground in its lowest position.
- Be sure to apply blocks to the tracks to lock the tracks securely.
- Never perform service underneath the machine if it is not completely stable.



000305-00X

### Keep the machine clean

- Spilled oil or grease, or scattered parts are dangerous and can cause falls. Keep the machine clean.
- Getting water into the electrical system may cause it to malfunction, resulting in faulty operation of the machine. Also it may permit electrical leaks that could cause a fire or electric shocks.
- Never clean the sensors, connectors or the operator's seat with water or steam.

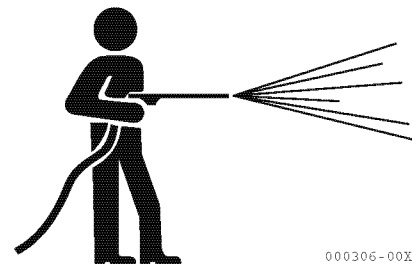

000306-00X

**Precautions for fueling and oiling**

- Spilled fuel and oil could cause a fire and they are dangerously slippery. Wipe up spills immediately.
- Close the fuel cap and oil cap securely.
- Never use fuel for cleaning.
- Provide good ventilation when replenishing fuel or oil.

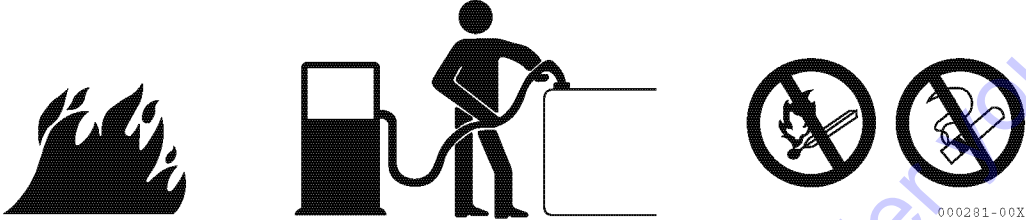
**Radiator cooling water level**

- Before checking the radiator cooling water level, stop the engine and wait until the engine and the radiator have cooled down.
- Slowly loosen the cap to release the inner pressure before removing the cap.

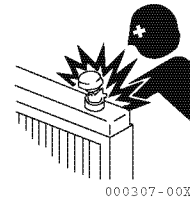
**Use an explosion-proof lighting source**

- Use an explosion-proof lighting source when checking the fuel, the oil, the cooling water, or the battery electrolyte. Failure to use an explosion-proof lighting source may cause ignition to occur, inducing an explosion.

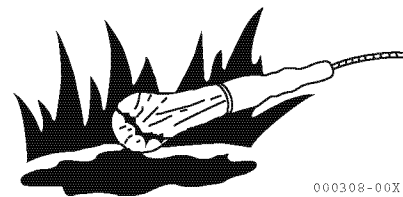
**Precautions for handling battery**

- When welding or repairing the electrical system, disconnect the negative terminal of the battery to interrupt the electric circuit.



**Handling high-pressure hoses**

- Leaks of fuel and oil could cause a fire.
- Do not bend a high-pressure hose forcibly, or strike it with a hard object. Because abnormally bent or damaged piping, tubes, and hoses easily burst under high pressure, never use them.

**Be careful of hot oil under high-pressure**

- The hydraulic system for the implement operates under high pressure. When replenishing or draining hydraulic oil, be sure to first relieve the high pressure.
- The emission of hot oil under high-pressure from a small leak could result in serious bodily injury. Wear safety goggles and thick gloves when checking for leaks. Use a piece of cardboard or a plywood block to detect emissions of hot oil. If the hot oil should contact your body, obtain prompt medical treatment.

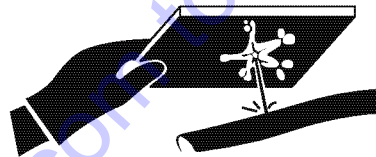
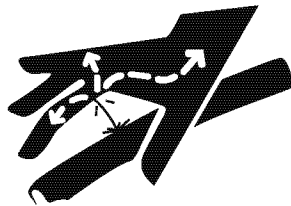

000310-00X

**Be careful when servicing systems under high temperature and high pressure**

- The engine cooling water and each lube oil system are still under high temperature and pressure immediately after the engine has stopped. Removing caps, draining oil and water, or replacing filter elements at that time may cause a burn. Wait until the temperature drops, then begin servicing in accordance with the procedures described in this manual.

**For cleaning the inside of the cooling system, refer to Section "27-2. Nonperiodic services".**

**For checking the level of the cooling water and the hydraulic oil, refer to Section "27-3. Checking before start-up".**

**For checking the oil levels in various systems and replenishing the oil, refer to Section "27-3 to 5. Periodic services".**

**For replacing the oils in various systems and replacing the filter elements, refer to Section "27-6 to 8. Periodic services".**



000282-00X

### Hazards from the high-pressure grease when adjusting the track tension

High-pressure grease is enclosed in the track adjuster. Failure to use the specified procedures for adjusting the track tension, could cause grease plugs or nipples to eject, which could result in bodily injury.

- Do not loosen the grease draining plug more than one turn.
- Never position your face, hands, legs, or body in line with the grease draining plug and valve.

**For information about adjusting track tension, refer to Section "27-2. Nonperiodic services".**



000311-00X

### Rotating radiator fan and fan belt

- Never contact the rotating radiator fan or fan belt with any object.
- Contacting the rotating radiator fan or fan belt with any object can result in serious bodily injury.

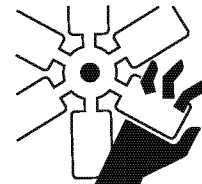

000312-00X

### Processing wastes

- Do not dispose of waste oil in the sanitary sewer system.
- Always drain the oil from the machine into a secure container, and never directly to the ground.
- When disposing of toxic wastes such as fuel, oil, cooling water, solvent, filters, and spent batteries, comply with all applicable disposal regulation.

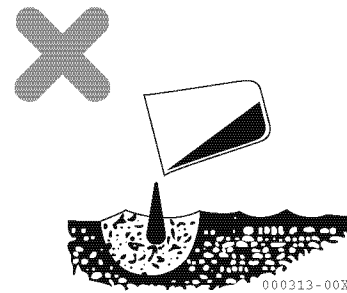

000313-00X

## 10. Safety Messages (Warning Labels)

There are a number of Warning Labels on the machine. Full descriptions of all Warning Labels and their locations are reviewed in this section. Periodically confirm whether all Warning Labels are still mounted in their correct locations and can be easily read.

If a warning label is missing, damaged or cannot be read, it must be promptly replaced. Also, if a warning label was mounted on a part which is replaced, a new warning label must be installed on the replaced part.

Contact your dealer to obtain new labels. The part code number is shown on each warning label as well as on the reproductions in this manual.

### 10-1. Location of warning labels

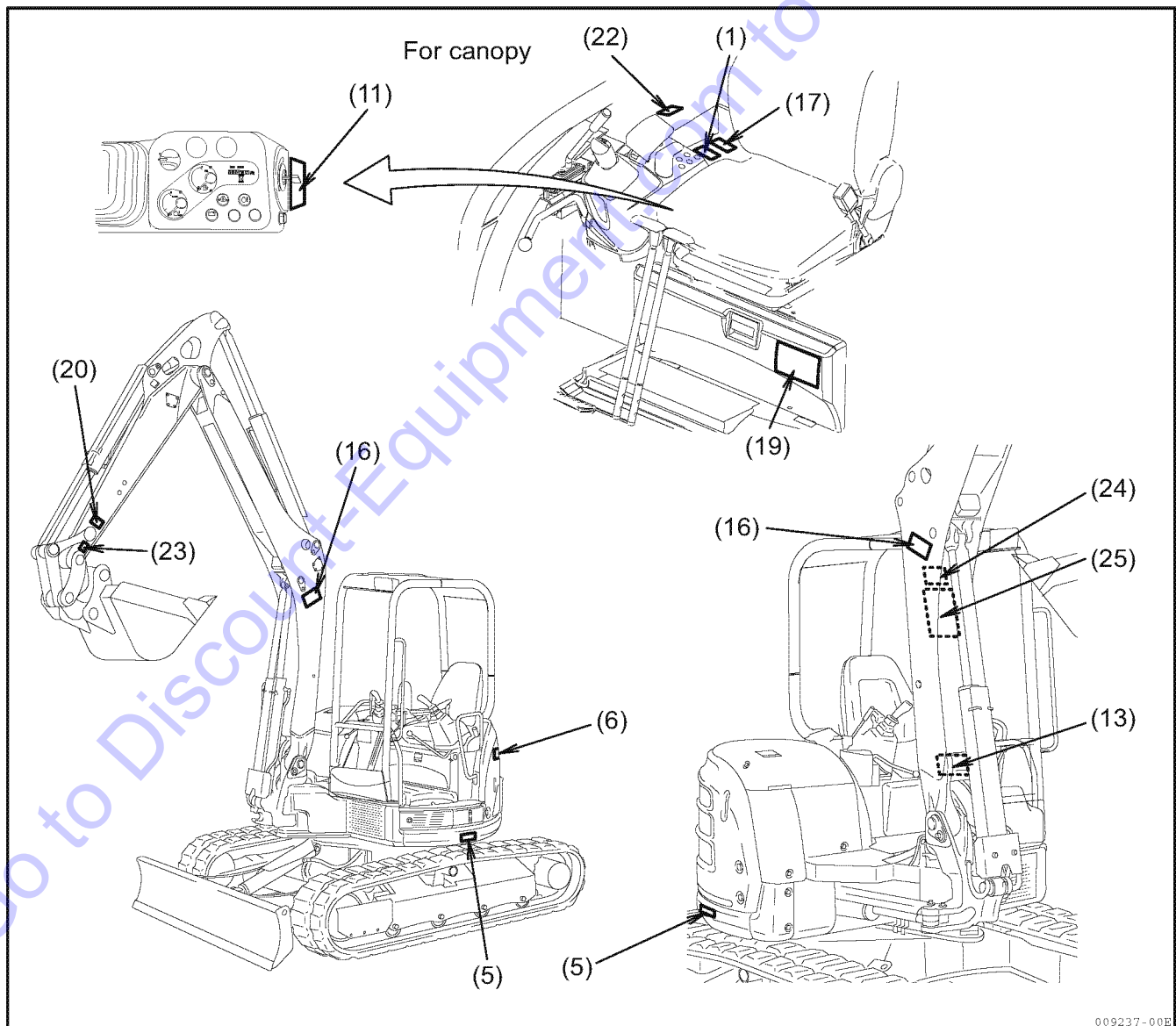

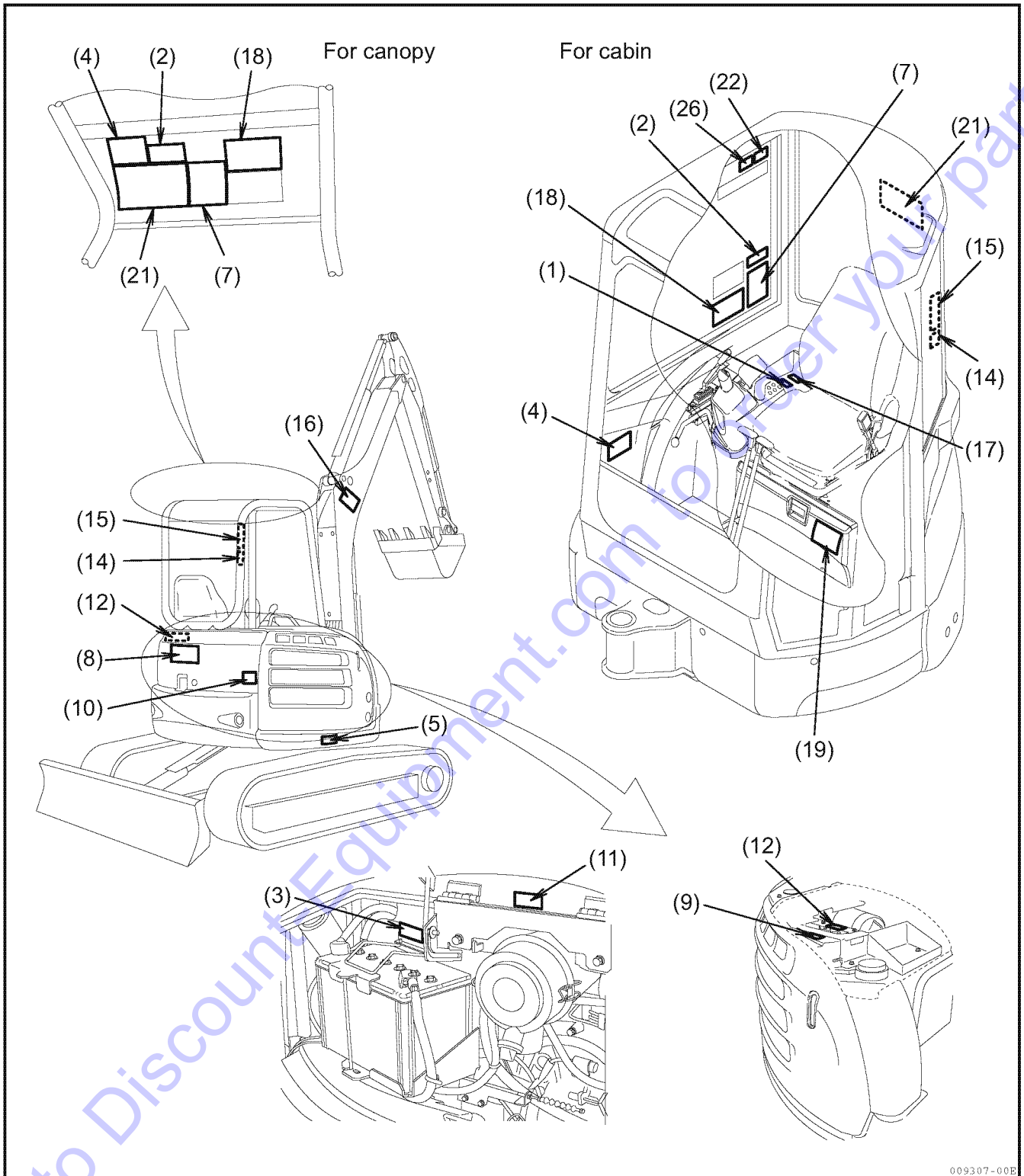

009307-00B

(1) 172437-03301

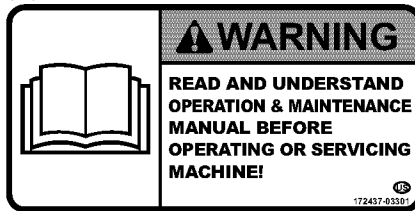

(2) 172437-03312

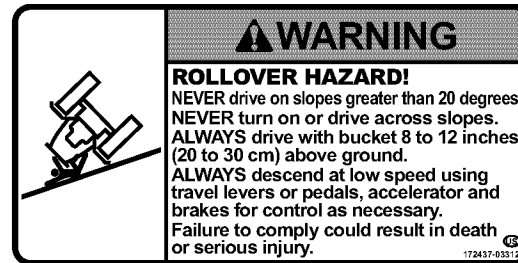

(3) 172437-03322



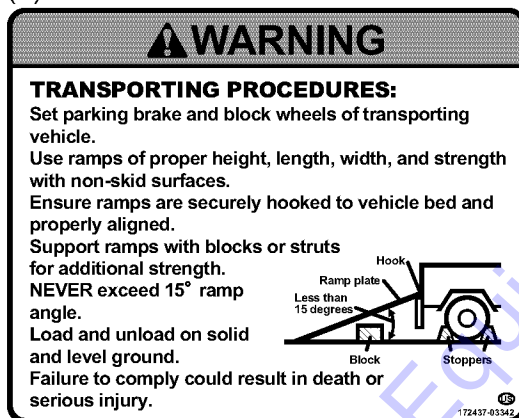

(4) 172437-03342

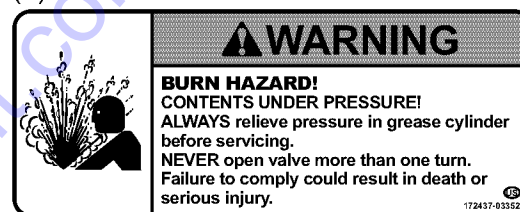

(5) 172437-03352



(6) 172437-03361

|   |   |
|---|---|
| <b>⚠ DANGER</b>   |   |
|  | <p><b>EXPLOSION HAZARD!</b><br/>Improper connection or disconnection can cause an explosion.<br/>ALWAYS follow Operation &amp; Maintenance Manual when using booster cables.<br/>Battery generates hydrogen gas which can explode if ignited.<br/>NEVER smoke or introduce flames or sparks near battery.</p> |
|  | <p><b>BURN HAZARD!</b><br/>Battery contains sulfuric acid which burns skin.<br/>ALWAYS wear goggles and protective clothing when servicing battery.<br/>Flush with water and get prompt medical treatment if contact should occur.</p>  |
|  | <p>Failure to comply will result in death or serious injury.</p>  |
| <small>172437-03361</small>   |   |

(7) 172437-03372

|   |
|---|
| <b>⚠ WARNING</b>  |
| <p><b>PROPER OPERATING PROCEDURE:</b><br/>ALWAYS wear seat belt.<br/>NEVER start excavator unless all safety guards are in place and implement controls are in neutral.<br/>NEVER operate with people on or near excavator.<br/>Start from operator's seat only.<br/>NEVER start engine standing on ground.<br/>Inspect for overhead power lines, obstructions, holes and drop-offs and note location of underground utility lines before operation.<br/>NEVER leave operator's seat until all implements are grounded, hydraulic pressure is relieved for all controls, lock levers are locked and ignition key has been removed.<br/>NEVER attempt to raise chassis off ground with blade and attachment.</p> |
| <small>172437-03372</small>   |

(8) 172437-03381

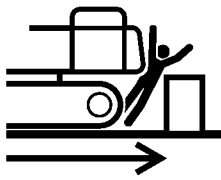
|   |   |
|---|---|
| <b>⚠ DANGER</b>   |   |
|    |  |
| <p><b>CRUSH HAZARD!</b><br/>Stay clear of swing range of Excavator implements and machine tail.<br/>Failure to comply will result in death or serious injury.</p> |   |
| <small>172437-03381</small>   |   |

(9) 172437-03391

|   |   |
|---|---|
|  | <p><b>⚠ WARNING</b></p> <p><b>BURN HAZARD!</b><br/>CONTENTS UNDER PRESSURE!<br/>ALWAYS stop engine and allow radiator to cool before removing cap.<br/>Failure to comply could result in death or serious injury.</p> |
| <small>172437-03391</small>   |   |

(10) 172437-03402

|  |
|--|
| <p><b>⚠ WARNING</b></p> <p><b>BURN HAZARD!</b><br/>Engine is hot!<br/>Allow to cool before servicing.<br/>Failure to comply to any of above could result in death or serious injury.</p> |
| <small>172437-03402</small>  |



(11) 172A36-03411

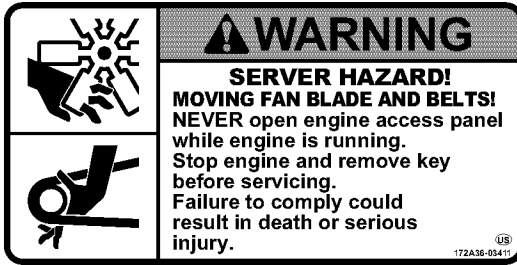

(12) 172437-03422

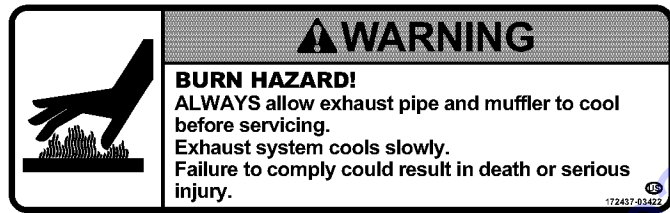

(13) 172437-03432

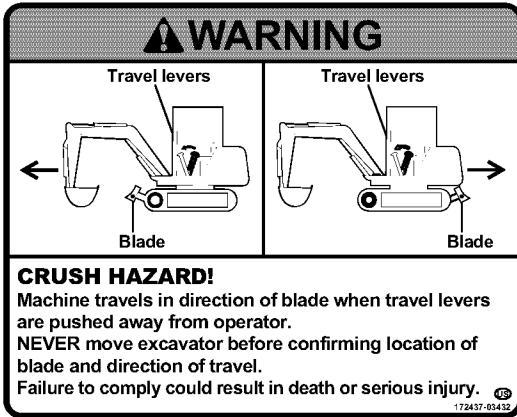

(14) 172437-03441

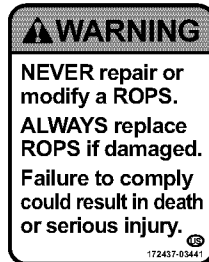

(15) 172437-03451

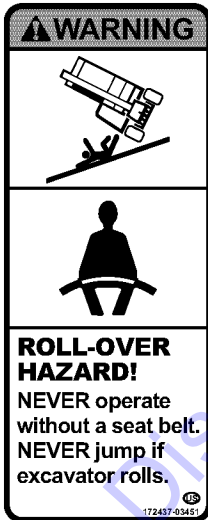

(16) 172437-03461



(17) 172437-03471

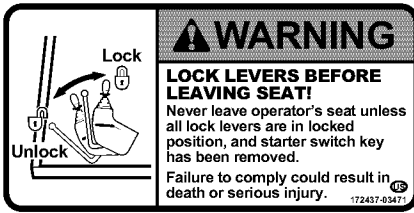

(18) 172437-03601

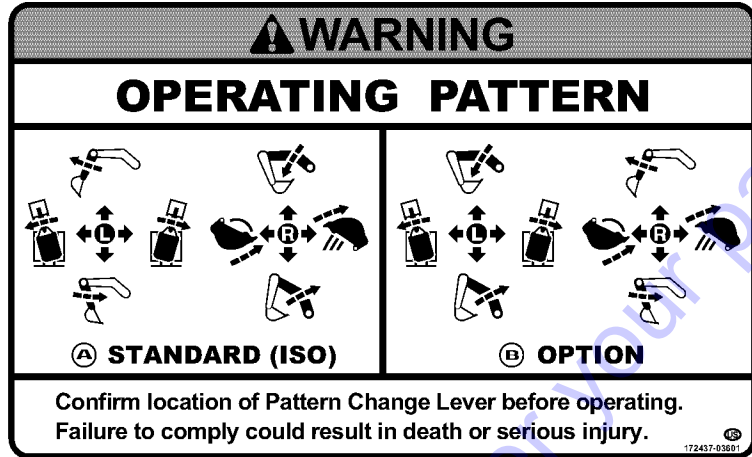

(19) 172472-03141

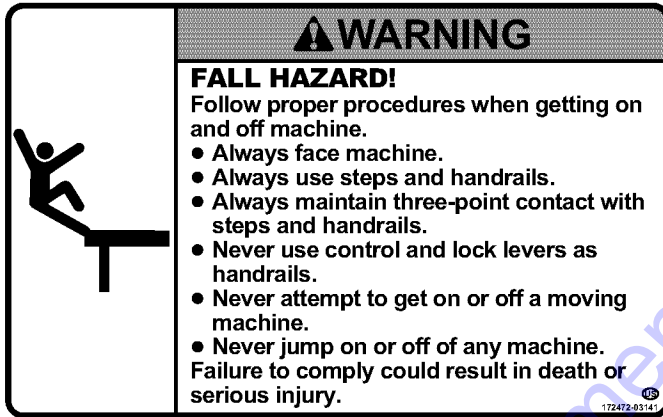

(20) 172472-03330



(21)

172A47-03363

**WARNING**

**TIP-OVER HAZARD!**  
Never allow total bucket weight to exceed excavator lift capacity.

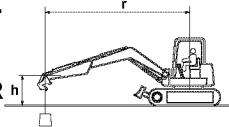

**MODEL**  
**ViO45-5, 5B EXCAVATOR**  
Quick coupler Spec.

Note where applicable specifications conform to ISO standards.  
Loads shown in table include weight of standard bucket (280 lbs. [127 kg])  
Weight of all lifting devices and attachment must be deducted to determine load that can be lifted.  
Lift point is bucket hinge point with bucket fully curled.  
Specifications subject to change without notice.  
※Rated Hydraulic lift capacity

| LIFT POINT HEIGHT<br>h in. (mm) | (r) LIFT RADIUS · in. (mm) |              |              |              | (r) LIFT RADIUS · in. (mm) |              |              |              | (r) LIFT RADIUS · in. (mm) |              |              |              |
|---------------------------------|----------------------------|--------------|--------------|--------------|----------------------------|--------------|--------------|--------------|----------------------------|--------------|--------------|--------------|
|                                 | MAX                        | 157.5 (4000) | 118.1 (3000) | 98.5 (2500)  | MAX                        | 157.5 (4000) | 118.1 (3000) | 98.5 (2500)  | MAX                        | 157.5 (4000) | 118.1 (3000) | 98.5 (2500)  |
| 157.5 (4000)                    | *1851 (840)                |              |              |              | *1741 (790)                |              |              |              | *1763 (800)                |              |              |              |
| 118.1 (3000)                    | *1918 (870)                | *1851 (840)  |              |              | 1234 (560)                 | *1741 (790)  |              |              | 1102 (500)                 | 1410 (640)   |              |              |
| 78.7 (2000)                     | *2006 (910)                | *2160 (980)  | *2733 (1240) | *3284 (1490) | 992 (450)                  | 1455 (660)   | *2513 (1140) | *3196 (1450) | 903 (410)                  | 1322 (600)   | *2623 (1190) | *3218 (1460) |
| 39.4 (1000)                     | *2116 (960)                | *2557 (1160) | *3659 (1660) | *4651 (2110) | 947 (430)                  | 1366 (620)   | 2204 (1000)  | 2932 (1330)  | 859 (390)                  | 1234 (560)   | 2006 (910)   | 2623 (1190)  |
| Ground (0)                      | *2226 (1010)               | *2755 (1250) | *3990 (1810) | *5026 (2280) | 992 (450)                  | 1300 (590)   | 2050 (930)   | 2711 (1230)  | 903 (410)                  | 1168 (530)   | 1851 (840)   | 2447 (1110)  |
| -39.4 (-1000)                   | *2336 (1060)               | *2645 (1200) | *3769 (1710) | *4872 (2210) | 1168 (530)                 | 1300 (590)   | 2028 (920)   | 2821 (1280)  | 1058 (480)                 | 1168 (530)   | 2028 (920)   | 3284 (1490)  |
| -78.7 (-2000)                   | *2336 (1060)               |              | *2777 (1260) | *3373 (1530) | 1895 (860)                 |              | 2160 (980)   | 2821 (1280)  | 1785 (810)                 |              | 1984 (900)   | 2557 (1160)  |

US172A47-03363

172A48-03393

**WARNING**

**TIP-OVER HAZARD!**  
Never allow total bucket weight to exceed excavator lift capacity.

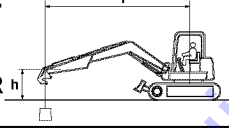

**MODEL**  
**ViO55-5, 5B EXCAVATOR**  
Quick coupler Spec.

Note where applicable specifications conform to ISO standards.  
Loads shown in table include weight of standard bucket (291 lbs. [132 kg])  
Weight of all lifting devices and attachment must be deducted to determine load that can be lifted.  
Lift point is bucket hinge point with bucket fully curled.  
Specifications subject to change without notice.  
※Rated Hydraulic lift capacity

| LIFT POINT HEIGHT<br>h in. (mm) | (r) LIFT RADIUS · in. (mm) |              |              |              | (r) LIFT RADIUS · in. (mm) |              |              |              | (r) LIFT RADIUS · in. (mm) |              |              |              |
|---------------------------------|----------------------------|--------------|--------------|--------------|----------------------------|--------------|--------------|--------------|----------------------------|--------------|--------------|--------------|
|                                 | MAX                        | 157.5 (4000) | 118.1 (3000) | 98.5 (2500)  | MAX                        | 157.5 (4000) | 118.1 (3000) | 98.5 (2500)  | MAX                        | 157.5 (4000) | 118.1 (3000) | 98.5 (2500)  |
| 157.5 (4000)                    | *2006 (910)                | *1873 (850)  |              |              | *1873 (850)                | *1807 (820)  |              |              | *1940 (880)                | *1873 (850)  |              |              |
| 118.1 (3000)                    | *1962 (890)                | *1984 (900)  |              |              | 1300 (590)                 | *2028 (920)  |              |              | 1234 (560)                 | *1962 (890)  |              |              |
| 78.7 (2000)                     | *2050 (930)                | *2447 (1110) | *3218 (1460) | *4078 (1850) | 1190 (540)                 | 1962 (890)   | *3086 (1400) | *3880 (1760) | 1102 (500)                 | 1829 (830)   | *3196 (1450) | *4056 (1840) |
| 39.4 (1000)                     | *2138 (970)                | *2888 (1310) | *4188 (1900) | *5511 (2500) | 1124 (510)                 | 1829 (830)   | 2910 (1320)  | 3769 (1710)  | 1036 (470)                 | 1697 (770)   | 2645 (1200)  | 3527 (1600)  |
| Ground (0)                      | *2182 (990)                | *3130 (1420) | *4519 (2050) | *5621 (2550) | 1168 (530)                 | 1719 (780)   | 2689 (1220)  | 3549 (1610)  | 1102 (500)                 | 1631 (740)   | 2513 (1140)  | 3240 (1470)  |
| -39.4 (-1000)                   | *2248 (1020)               | *2998 (1360) | *4232 (1920) | *5246 (2380) | 1344 (610)                 | 1697 (770)   | 2733 (1240)  | 3659 (1660)  | 1256 (570)                 | 1609 (730)   | 2491 (1130)  | 3351 (1520)  |
| -78.7 (-2000)                   | *2160 (980)                |              | *3439 (1560) | *4034 (1830) | *2138 (970)                |              | 2821 (1280)  | 4254 (1930)  | *2006 (910)                |              | 2579 (1170)  | 3395 (1540)  |

US172A48-03393

(22) 172472-03241

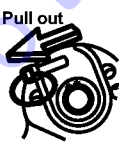

CAUTION

**DO NOT DAMAGE LOCK PIN!**  
Pull lock pin out when changing attachment.

172472-03241

(23) 172472-03261

WARNING

**SEVER HAZARD!**  
NEVER insert fingers into pin hole.  
Failure to comply could result in death or serious injury.



172472-03261

(24) 172472-03271

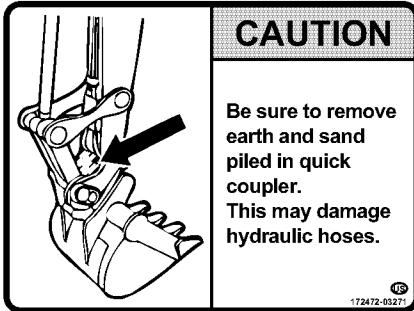

(25) 172472-03281

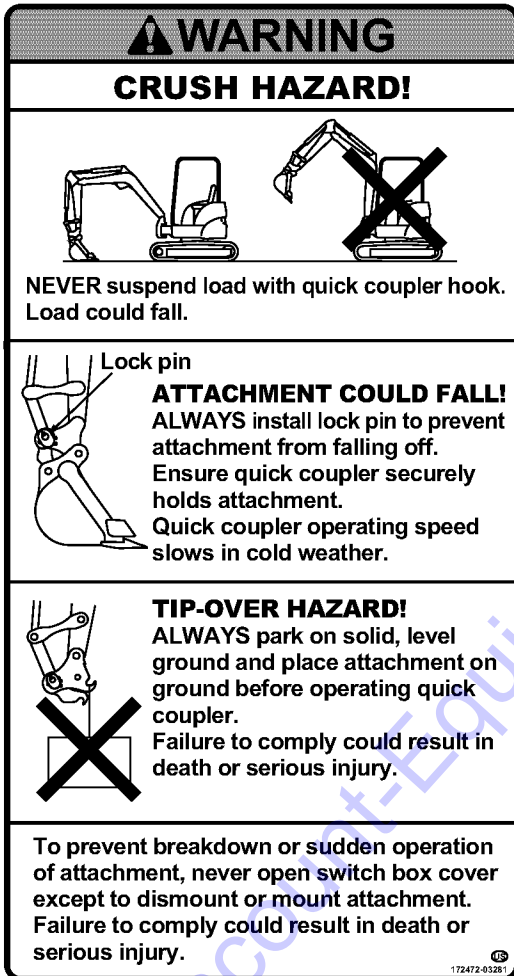

(26) 172437-03551



# 11. SAFETY (ViO55-5B Angle blade spec.)

## 11-1. Safety Messages (Warning Labels)

There are a number of Warning Labels on the machine. Full descriptions of all Warning Labels and their locations are reviewed in this section. Periodically confirm whether all Warning Labels are still mounted in their correct locations and can be easily read.

If a warning label is missing, damaged or cannot be read, it must be promptly replaced. Also, if a warning label was mounted on a part which is replaced, a new warning label must be installed on the replaced part. Contact your dealer to obtain new labels. The part code number is shown on each warning label as well as on the reproductions in this manual.

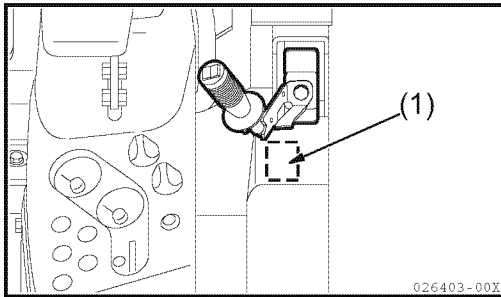

(1) 172A79-03220

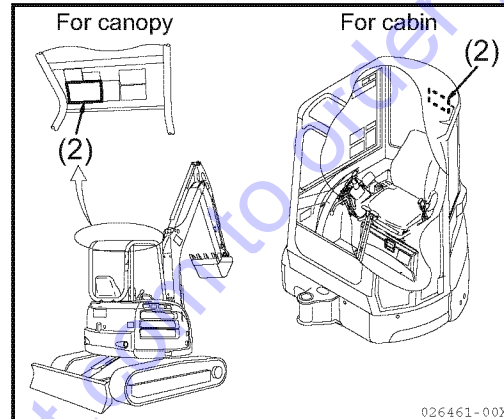
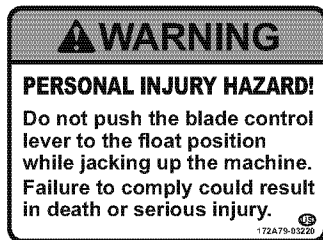

(2) 172A79-03390

**WARNING**

**TIP-OVER HAZARD!**  
Never allow total bucket weight to exceed excavator lift capacity.

**MODEL**  
ViO55-5B EXCAVATOR  
Quick coupler Spec.  
Angle Blade Spec.

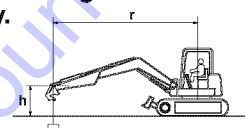

Note where applicable specifications conform to ISO standards.  
Loads shown in table include weight of standard bucket (291 lbs. [132 kg])  
Weight of all lifting devices and attachment must be deducted to determine load that can be lifted.  
Lift point is bucket hinge point with bucket fully curled.  
Specifications subject to change without notice.  
※Rated Hydraulic lift capacity

| LIFT POINT HEIGHT<br>h in.<br>(mm) | (r) LIFT RADIUS · in. (mm) |                 |                 |                 | (r) LIFT RADIUS · in. (mm) |                 |                 |                 | (r) LIFT RADIUS · in. (mm) |                 |                 |                 |
|------------------------------------|----------------------------|-----------------|-----------------|-----------------|----------------------------|-----------------|-----------------|-----------------|----------------------------|-----------------|-----------------|-----------------|
|                                    | MAX                        | 157.5<br>(4000) | 118.1<br>(3000) | 98.5<br>(2500)  | MAX                        | 157.5<br>(4000) | 118.1<br>(3000) | 98.5<br>(2500)  | MAX                        | 157.5<br>(4000) | 118.1<br>(3000) | 98.5<br>(2500)  |
| 157.5<br>(4000)                    | *1984<br>(900)             | *1984<br>(900)  |                 |                 | *1631<br>(740)             | *1829<br>(830)  |                 |                 | 1631<br>(740)              | *1873<br>(850)  |                 |                 |
| 118.1<br>(3000)                    | *1984<br>(900)             | *2006<br>(910)  |                 |                 | 1278<br>(580)              | *1918<br>(870)  |                 |                 | 1366<br>(620)              | *1984<br>(900)  |                 |                 |
| 78.7<br>(2000)                     | *1984<br>(900)             | *2447<br>(1110) | *3152<br>(1430) | *3902<br>(1770) | 1124<br>(510)              | 1851<br>(840)   | *2954<br>(1340) | *3747<br>(1700) | 1146<br>(520)              | 1962<br>(890)   | *3042<br>(1380) | *3858<br>(1750) |
| 39.4<br>(1000)                     | *2006<br>(910)             | *2777<br>(1260) | *4078<br>(1850) |                 | 1080<br>(490)              | 1741<br>(790)   | 2799<br>(1270)  |                 | 1146<br>(520)              | 1763<br>(800)   | 2866<br>(1300)  |                 |
| Ground<br>(0)                      | *2094<br>(950)             | *3042<br>(1380) | *4497<br>(2040) | *5709<br>(2590) | 1102<br>(500)              | 1631<br>(740)   | 2601<br>(1180)  | 3461<br>(1570)  | 1146<br>(520)              | 1741<br>(790)   | 2667<br>(1210)  | 3659<br>(1660)  |
| -39.4<br>(-1000)                   | *2094<br>(950)             | *2866<br>(1300) | *4188<br>(1900) | *5246<br>(2380) | 1256<br>(570)              | 1675<br>(760)   | 2601<br>(1180)  | 3549<br>(1610)  | 1322<br>(600)              | 1719<br>(780)   | 2645<br>(1200)  | 3571<br>(1620)  |
| -78.7<br>(-2000)                   | *1940<br>(880)             |                 | *3218<br>(1460) |                 | *1609<br>(730)             |                 | 2601<br>(1180)  |                 | *1873<br>(850)             |                 | 2733<br>(1240)  |                 |

US/172A79-03390

For other warning labels, refer to section "10. Safety Messages (Warning Labels)".

## 11-2. Operating Precautions

Precautions for digging, lifting and suspending the machine

- When digging the ground by lowering the blade, lifting up the machine with the blade and suspending the machine, place the angle of blade in the neutral position (refer to the below-mentioned "Neutral position of the angle blade" for the neutral position). The machine may lose balance, which poses a danger, as well as cause excessive force to be imposed on the angle blade, resulting in failures.
- NEVER put the blade lever in the float position, when digging the ground by lowering the blade or lifting up the machine with the blade. NEVER go under the machine, as it may get down suddenly and cause a serious accident.

Neutral position of the angle blade

- The neutral position of the angle blade is marked as shown in the figure. Align the mark (1) (2) in the figure to place the angle blade in the neutral position.

Precautions for blade operation

- NEVER bump the blade. The excessive force may be imposed on the angle blade, resulting in failures.

For the angle lever operation, refer to "19-2. Description of Control Devices" and "19-3. Operating Instruction".

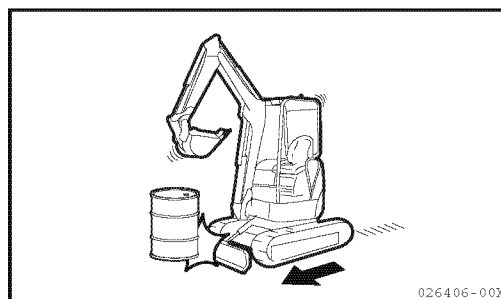
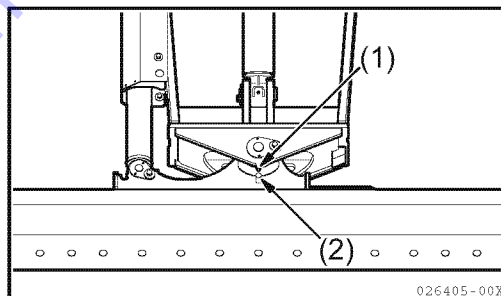
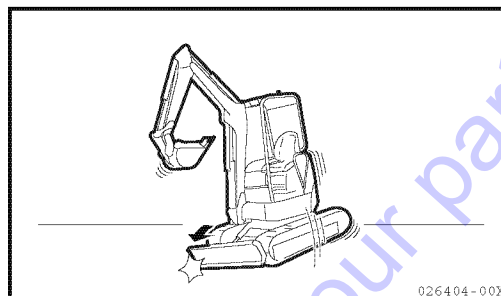

# OPERATION

*Go to [Discount-Equipment.com](http://Discount-Equipment.com) to order your parts*

## 12. Identification of Important Parts

### 12-1. Overview of the machine

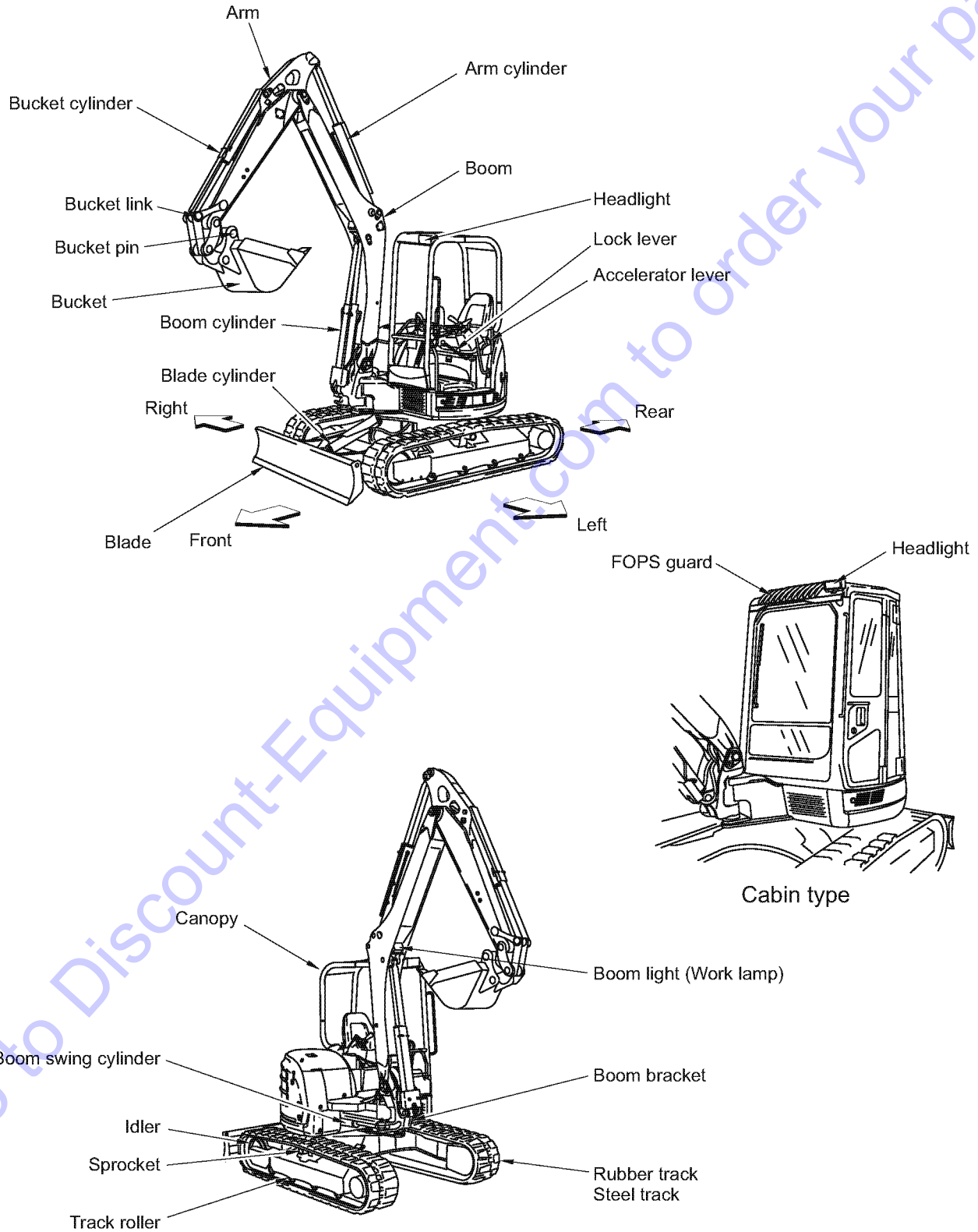

009179-00B



12-2. Controls and switches

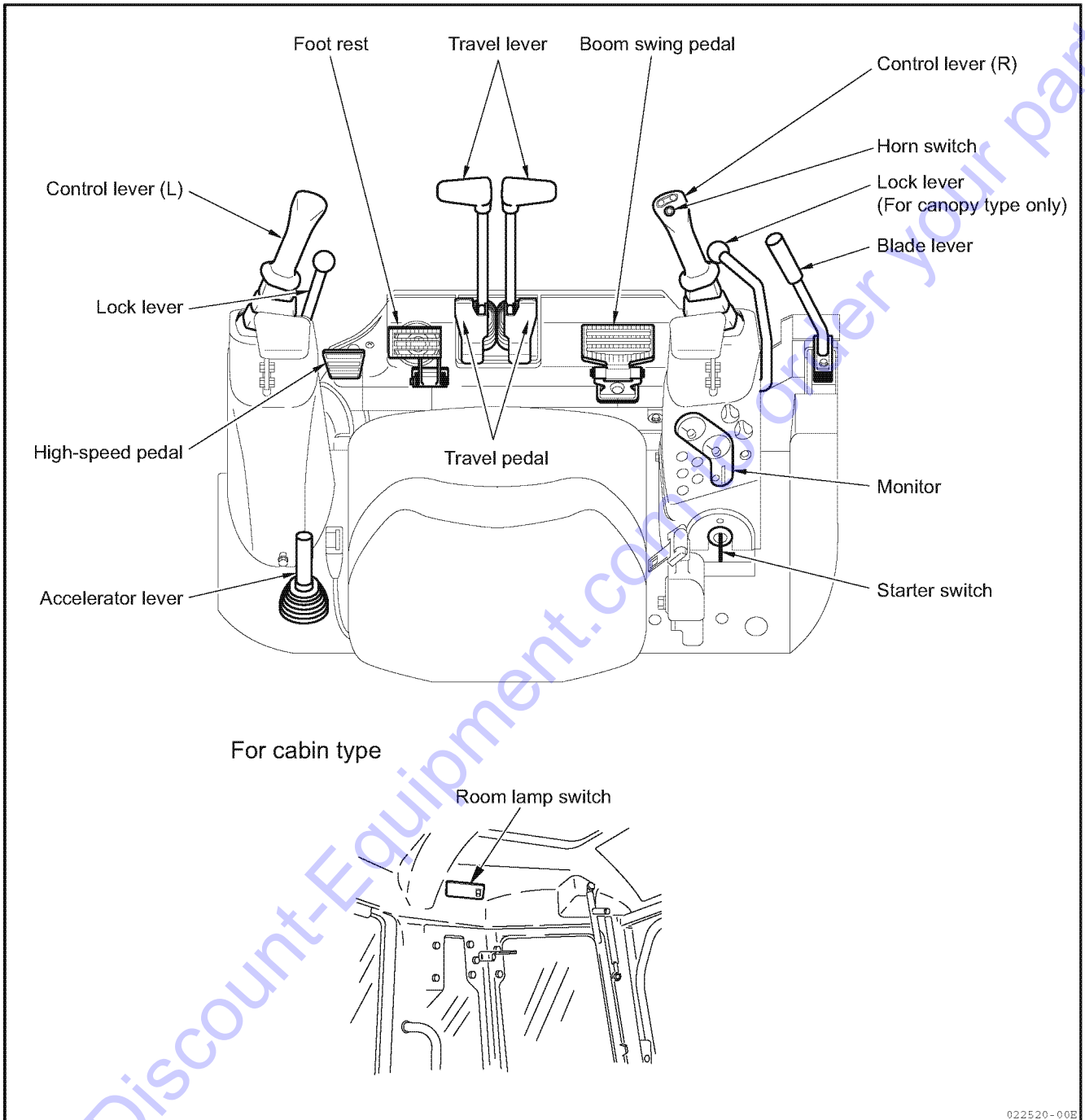

## 13. Description of Control Devices

This section describes several of the control devices necessary to operate the machine. In order to ensure safety and comfort in working with the machine, it is imperative for you to fully understand how to operate and interact with these devices.

### 13-1. Monitor

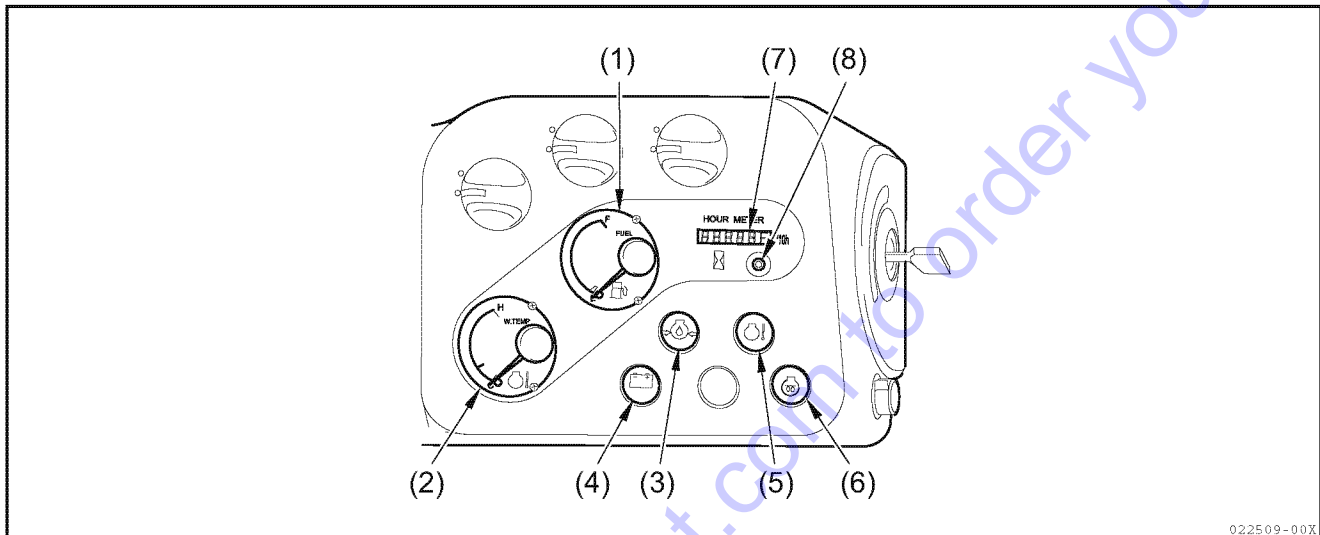

#### IMPORTANT

For start-up inspection, be sure to refer to **PART THREE: MAINTENANCE**, or Section "14. Operating Instructions" as well as the monitor messages as shown above.

#### **!** WARNING

**When an indicator lamp lights and a buzzer sounds during operation, immediately stop operation and check and service the abnormality.**

When the starter switch key is in the "ON" position, the monitor lamps (3), (4) and (5) light and buzzer sounds.

(Only the water temp alarm lamp (5) goes off in a few seconds.)

Normally, all monitor lamps go off after the engine starts.

When there is any failure during operation, a lamp lights and buzzer sounds. (If the starter switch key is in the "ON" position and a monitor lamp does not light, its bulb must be burnt out.)

**(1) Fuel gauge**

The fuel gauge works while the starter switch key is in the "ON" position and indicates the fuel amount in the fuel tank. When the gauge pointer indicates close to E (empty), refill fuel oil soon.

- It is not abnormal that the fuel gauge may not indicate properly immediately after the starter switch key is turned to the "ON" position.
- The reading on the fuel meter scale is affected by how much the machine is slanted.

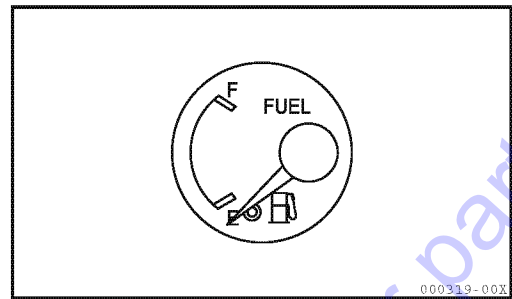

**(2) Water temp meter**

This indicates water temperature for engine. When the water temp. meter indicates "H" and buzzer sounds during operation, idle the engine at low speed until the water temperature cools down.

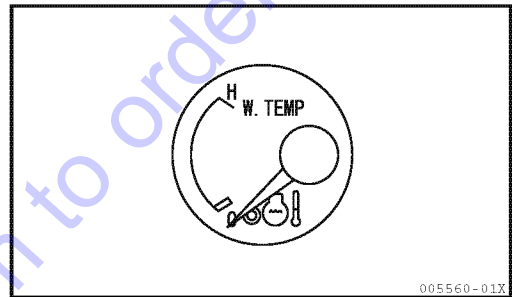

**(3) Engine oil pressure alarm lamp**

If engine oil pressure falls below the normal level, the alarm lamp will turn on and the buzzer will sound. In this event, stop the engine and inspect it according to Section "18-4. Troubleshooting".

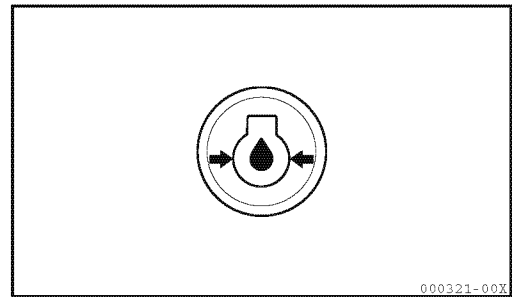

**(4) Battery charge alarm lamp**

If the battery is not charged properly, the alarm lamp will flash. In this event, inspect the battery charging circuit. If you find something abnormal with it, take corrective action by referring to Section "18-4. Troubleshooting".

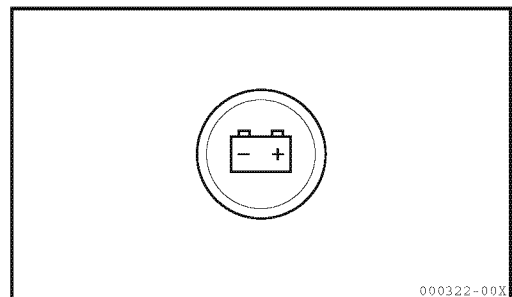

**(5) Water temp alarm lamp**

When the starter switch is turned to the "ON" position, the alarm lamp goes on and then goes off in a few seconds. When the cooling water temperature rises abnormally during operation, the alarm lamp goes on and the buzzer sounds, indicating engine overheating. Idle the engine for a while, and stop the engine. After the engine has cooled, take corrective actions.

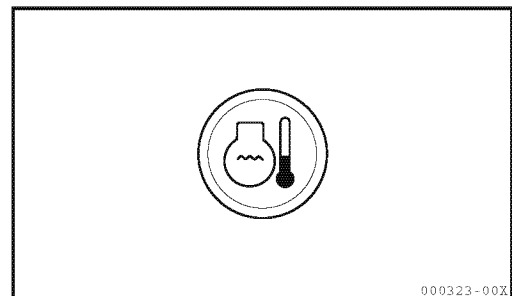

**(6) Preheat pilot lamp**

When the starter switch is turned to the "HEAT" position, the preheat pilot lamp goes on and then goes off in 15 seconds, which indicate it is okay to finish the preheat operation.

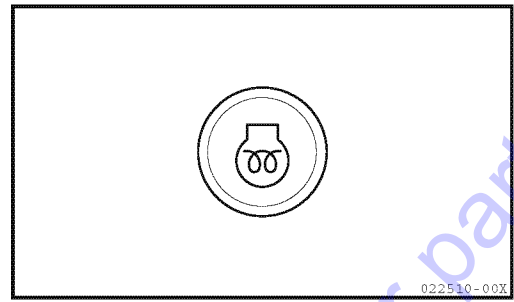

**(7) Hourmeter**

The hourmeter indicates the accumulated service hours for the machine.

The reading of the hourmeter helps you set time intervals for periodic servicing of the machine. While the engine is running, the hourmeter will continue registering even if the machine is not being operated.

- The hourmeter reading increases by "1" per hour regardless of engine rotational speed.  
The digit at the far right registers "1" per 0.1 hour (6 min.).

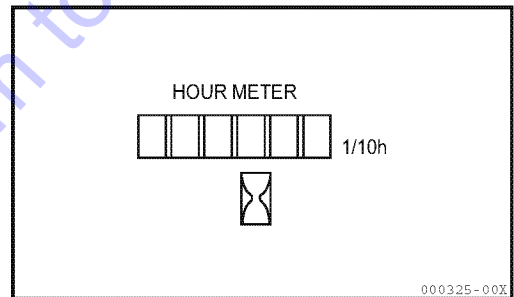
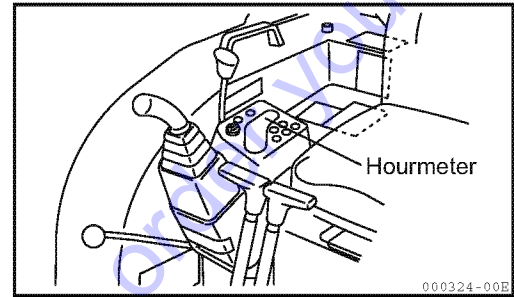

**(8) Hourmeter display button**

Even if the starter switch is in the "OFF" position, the operation time can be checked by pushing the hourmeter display button.

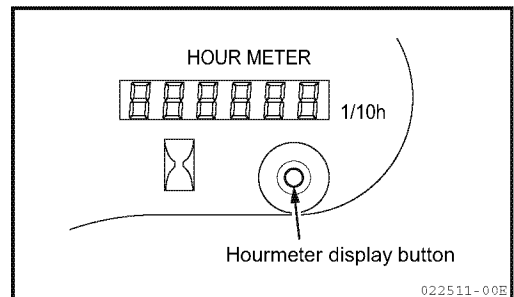

## 13-2. Switch

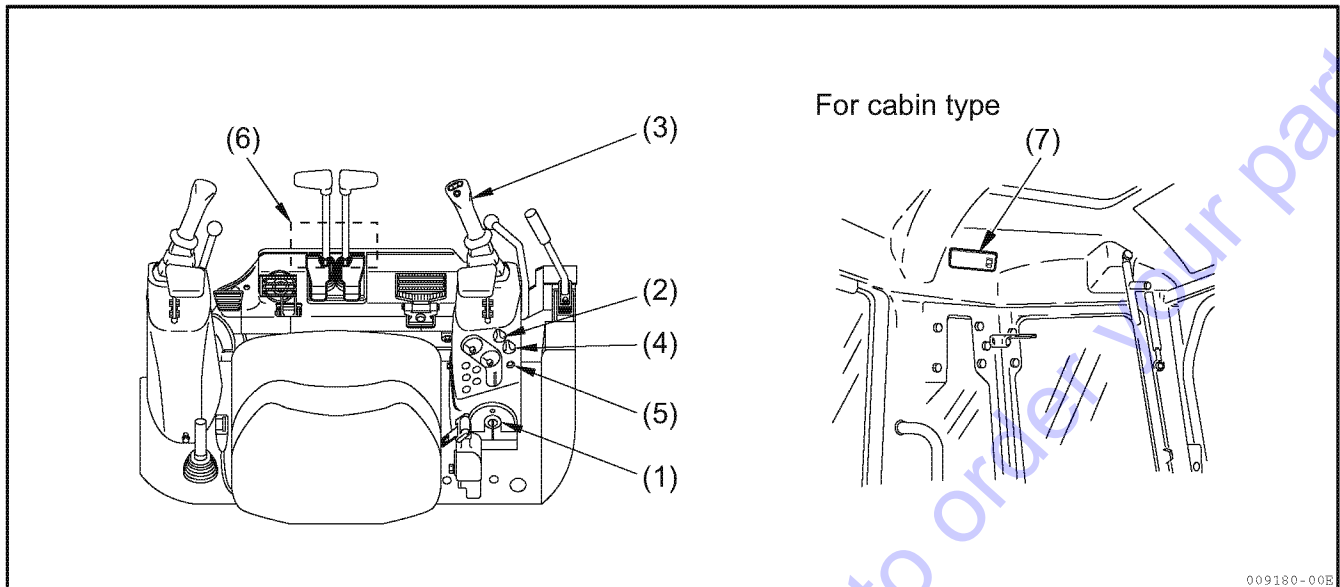

009180-00B

**(1) Starter switch**

Use this switch to start and stop the engine.

- OFF position  
Turn the key to "OFF" to stop the engine and disconnect electrical circuit or remove the key.
- ON position  
Turn the key to "ON" to connect the electrical fuel solenoid circuit and the electrical charging circuit. (Keep the key in this position while running the engine.)
- START position  
Turn the key to "START" to start the engine. Release the key after the engine is started and it will return to the "ON" position.
- HEAT position  
Turn the key to activate the preheating circuit and warm up intake air to start the engine easier in cold weather. (Set the key to this position when the outside temperature is low.)
- When the engine is not running and the switch is in the "ON" position, the buzzer keeps sounding.  
Turn the switch to the "OFF" position to stop sounding.

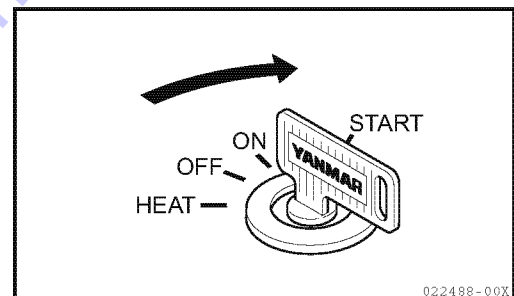

022498-00X

### (2) Light switch

The boom light and the headlight go on when the switch is turned on with the starter switch set to the "ON" position.

- ON : The lamps go on.
- OFF : The lamps go off.

#### IMPORTANT

**Do not keep on the lamps on for a long time while the engine is not running. The battery runs down and the engine cannot be started.**

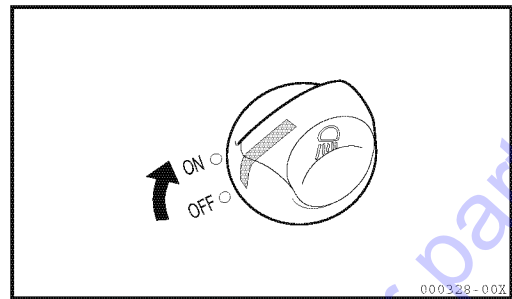

### (3) Horn switch

Press the switch on the top of the right control lever to sound the horn.

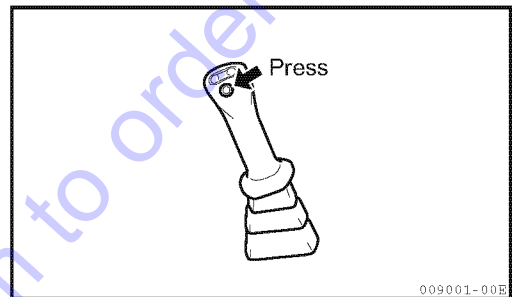

### (4) Wiper and windshield washer switch (for cabin)

This switch serves both wiper switch and windshield washer switch.

#### 1) Wiper switch

Move the switch to the "ON" position to actuate the wiper of the windshield.

- ON : Wiper works.
- OFF : Wiper stops.

#### 2) Windshield washer

Push the wiper switch.

The windshield will be sprayed with windshield washer fluid.

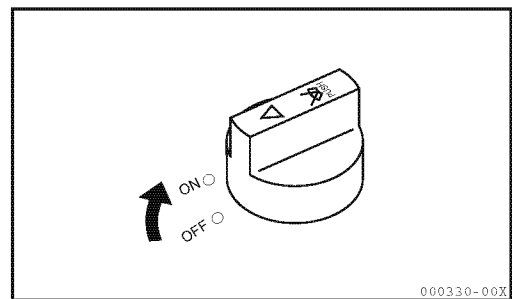

#### IMPORTANT

- **Do not push the switch when the tank is empty. It could cause pump failure.**
- **Wiping the dry windshield could damage the glass. Use the wiper only when the windshield is wet.**
- **The wiper blade may freeze in cold weather. Do not attempt to move it; otherwise the wiper motor will be damaged.**

**(5) Heater switch (for cabin)**

Use this switch to warm up the air in cabin. Move the switch to select fan speed. The heater switch allows you to select a high or low draft volume by setting it as follows:

- LO : Low fan speed.
- HI : High fan speed.
- OFF : Off.

Operate the heater switch after the cooling water has warmed up.

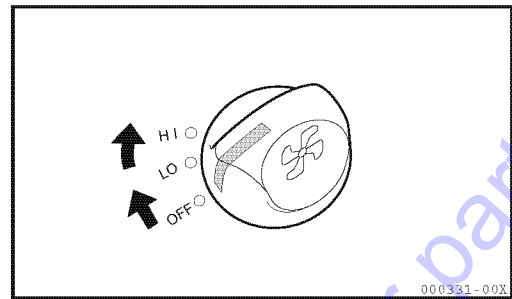

**(6) Travel alarm switch**

When the travel levers are pushed or pulled, the travel alarm switches are turned on and alarm sounds.

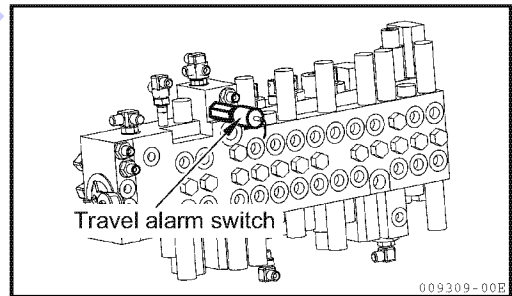
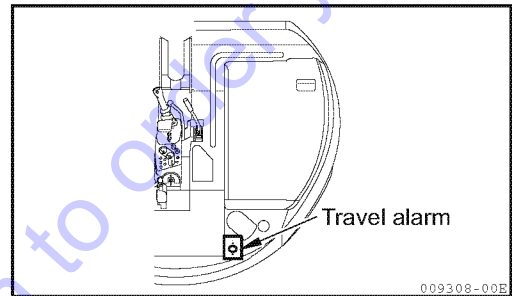

**(7) Room lamp switch (for cabin)**

The room lamp goes on when the switch is turned on with starter switch set to "ON" position.

- ON : The lamp goes on.
- OFF : The lamp goes off.

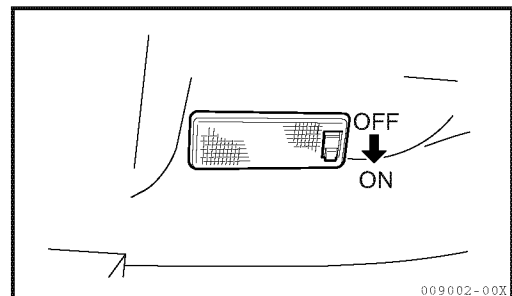

**13-3. Control levers and pedals**

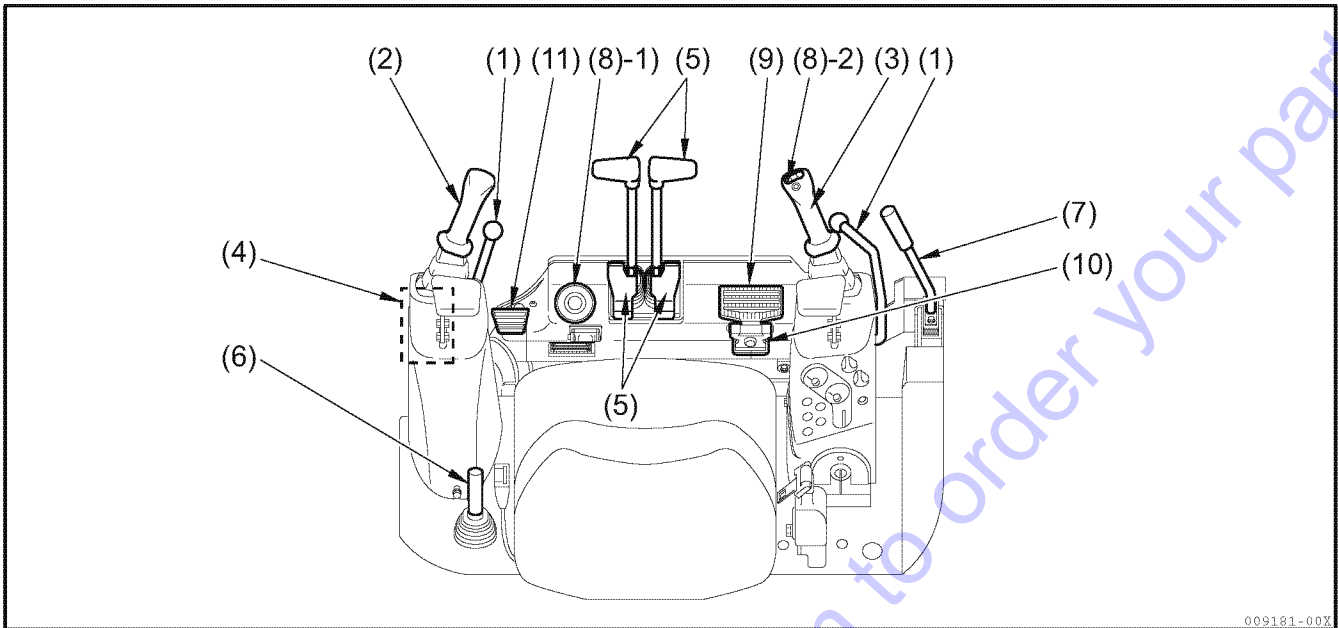

**(1) Lock levers (for implement control levers on both sides and travel lever)**

The lock levers lock the implement control and travel levers. When pulling the left lock lever back, the control lever stand (L) comes up. While the control lever stand (R) does not come up when pulling the right lock lever back.

**⚠ WARNING**

- When leaving the operator's seat, be sure to put the bucket on the ground and move the lock levers to the lock positions. Keep in mind that if you should touch the unlocked lever inadvertently, a serious accident could occur.
- Be sure to place the lock levers securely in position. If not, they could come out of the lock position. Thus always make sure that the lock levers are in position as illustrated in the right figure.
- When pulling the lock levers back, be careful not to touch the implement control lever.
- Remember that if the lock levers are not pulled back fully, the implement will not be locked.

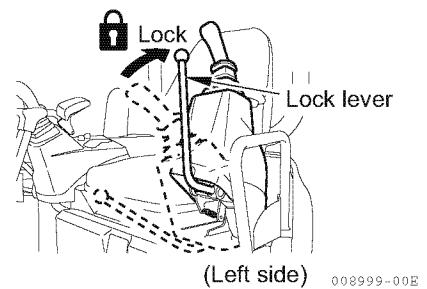

**IMPORTANT**

The machine uses a hydraulic lock system. If the lock levers are in the lock position, all the hydraulic cylinders for the boom, arm, bucket, blade and an actuator in the P.T.O. circuit as well as the swing and travel motors will not activate although the right and left implement control levers and the P.T.O. switches are free to move.



**⚠ WARNING**

When pushing the lock levers down forward, be careful not to touch the implement control lever.

**⚠ WARNING**

The relationship between the control lever shift configuration and the implement movement is detailed in this manual. To prevent an accident due to operational error, therefore, the hydraulic system must not be modified by reconnecting the hydraulic hoses and valves.

**(2) Control lever (L)**

**(3) Control lever (R)**

Use these levers to control the implements and swinging of upperstructure.

Refer to Section "14-8. Operating the implements".

**(4) 2 way valve**

STD : ISO pattern

OPT : OPT pattern

Refer to Section "14-8. Operating the implements".

- 1) Stop engine and make sure the lock lever is in lock position.
- 2) Open the cover.
- 3) Unlock the selector handle to move it to "STD" or "OPT" position.
- 4) Securely lock the selector handle.
- 5) Close the cover.

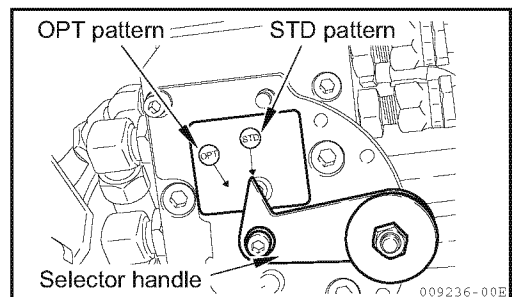
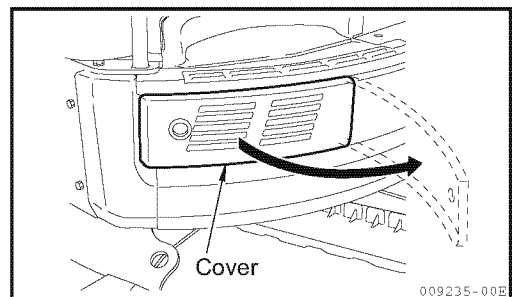
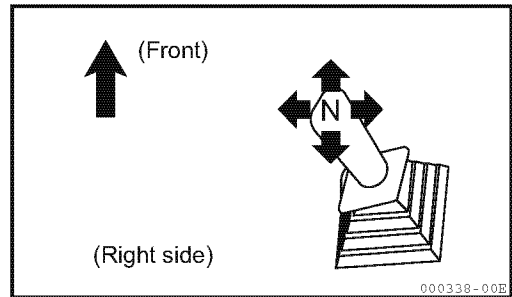
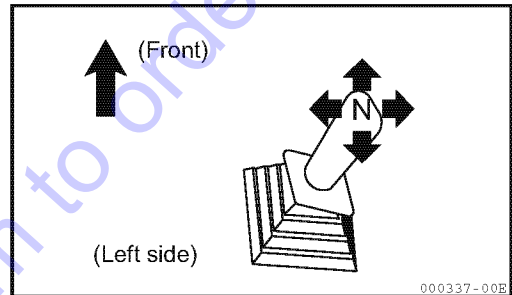
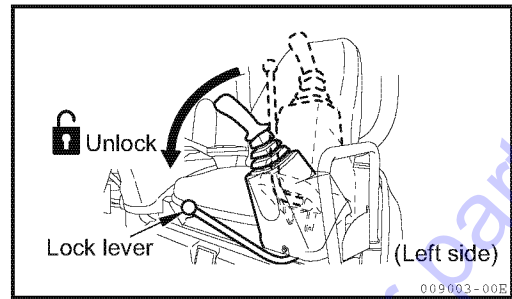

**(5) Travel levers and pedals**

The travel levers and pedals control the traveling of the machine.

**⚠ WARNING**

- If the blade is in the reverse direction, the travel levers and pedals should also be operated in reverse for forward and backward travel.
  - When operating the travel levers and pedals, you must check to see if the blade is in the normal position or in the reverse position. Note that the blade is in the normal position when the sprocket is in the rear.
- Refer to Section "12-1. Overview of the machine".**

When the blade is in the normal position:

Forward : Push the travel levers forward.

Step on the front of the pedals.

Reverse : Pull the travel levers backward.

Step on the rear of the pedals.

N : Neutral...The machine stops.

**(6) Accelerator lever**

The accelerator lever controls the engine speed (output).

(A) Idling : Push the lever forward fully.

(B) Run : Pull the lever backward fully.

**(7) Blade lever**

Use this lever to control the blade.

**IMPORTANT**

The blade lever is not locked by setting the lock lever to the lock position. Do not touch the blade lever when not operating the blade.

(A) : Down : Push the lever forward.

(B) : Up : Pull the lever backward.

N : Neutral...When released, the lever will return to the neutral position and the blade is held as it is.

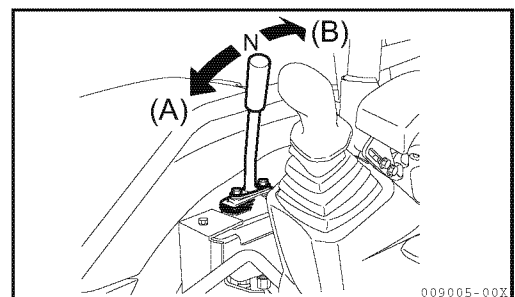
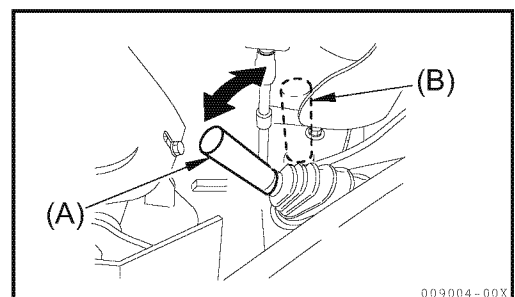
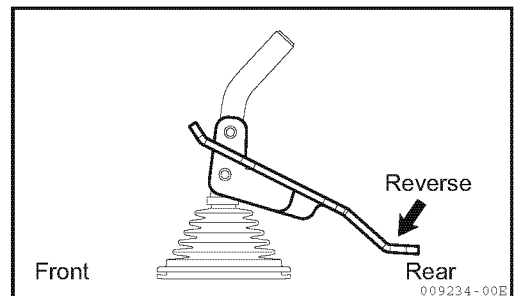
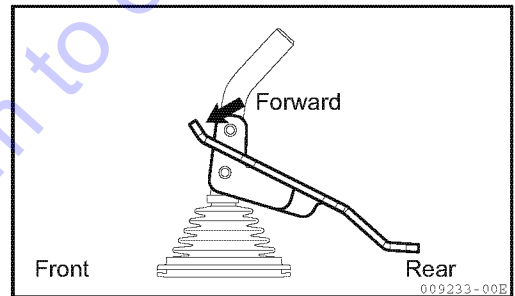
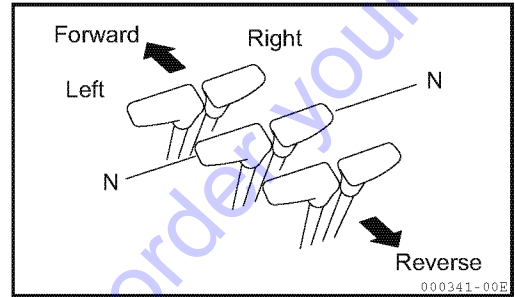
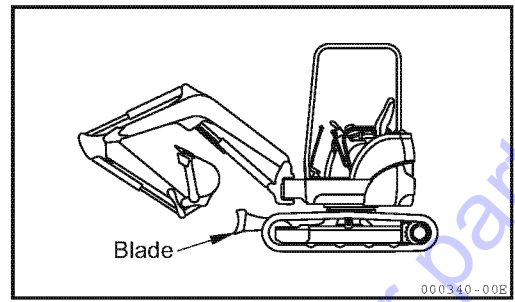

**(8) P.T.O. switches**

1) Foot switch

Unfold the foot rest and press the foot switch to operate a single acting attachment.

2) Lever switch

Use this switch to control the attachment.

- Single acting attachment (hammer)

Operate the lever switch with pressing the foot switch.

- Double acting attachment (tilt bucket, auger, etc.)

Operate the lever switch only.

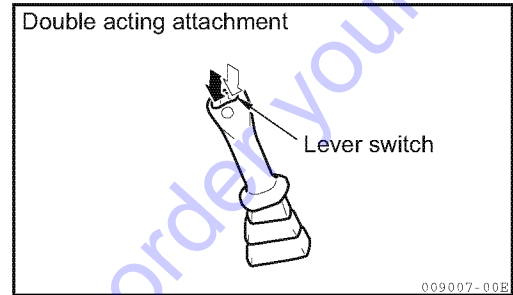
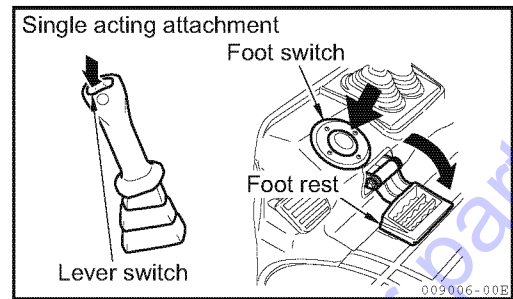

**(9) Boom swing pedal**

Use this pedal to swing the boom to right and left after unfolding it flat.

(A) : Swing right : move to the right

(B) : Swing left : move to the left

N : Neutral...When released, the pedal will return to the neutral position and the boom is held as it is.

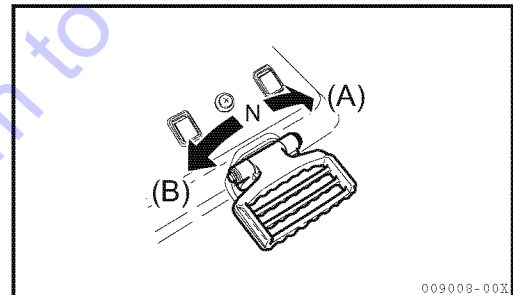

**(10) Non-use position of the boom swing pedal**

Fold the boom swing pedal forward to put it into the non-use position.

To prevent misuse, always set the pedal in the non-use position when the boom swing pedal is not being operated.

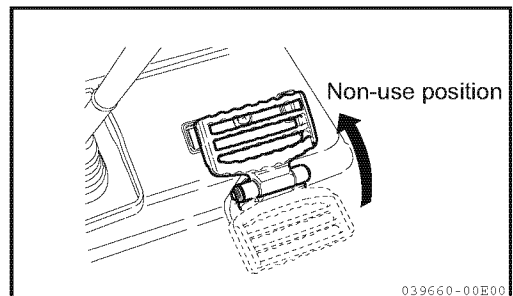

**(11) High-speed pedal**

Step on this pedal to control the travel speed. Step on the pedal while the travel levers are in operation to increase the travel speed.

**IMPORTANT**

**Do not travel at high speed for many hours.**

**Do not step on the pedal while operating the blade.**

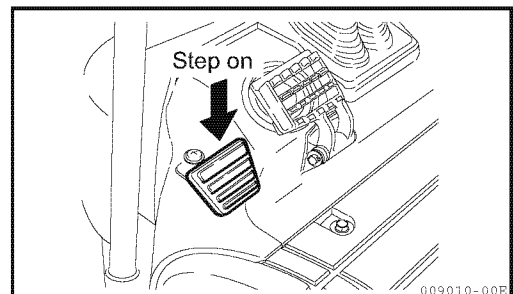

### 13-4. Engine hood B

#### (1) Opening the engine hood B

- 1) Insert the starter switch key and turn counterclockwise to unlock.
- 2) Pull the engine hood B lever to release the lock, and then the engine hood B opens.
- 3) The engine hood B fully opens to be locked with the stopper.

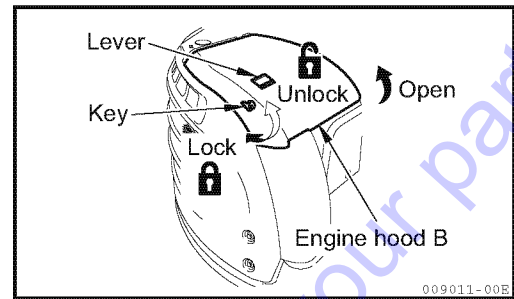

#### (2) Closing the engine hood rear cover

- 1) Close the engine hood B and press it down fully until it clicks.
- 2) Turn the starter switch key clockwise and engage the lock.

### 13-5. Engine hood rear cover

#### **⚠ WARNING**

**Do not open the engine hood while the engine is running. Rotating fan and fan belt and high temperature components can cause personal injury. Check and service the inside of the engine hood after the engine stops.**

#### (1) Opening the engine hood rear cover

- 1) Insert the starter switch key and turn counterclockwise to unlock.
- 2) Pull the engine hood rear cover lever to release the lock, and then the engine hood rear cover opens.
- 3) The engine hood rear cover fully opens to be locked with the stopper.

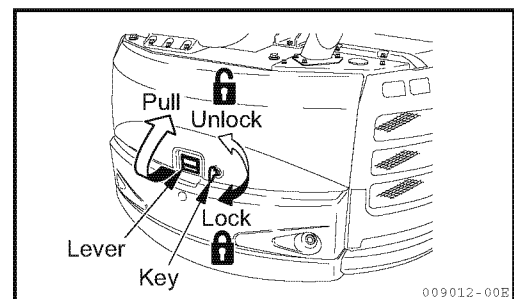

#### (2) Closing the engine hood rear cover

- 1) Lift up the engine hood rear cover slightly and pull the rod to disengage the lock.
- 2) Close the engine hood rear cover and press it down fully until it clicks.
- 3) Turn the starter switch key clockwise and engage the lock.

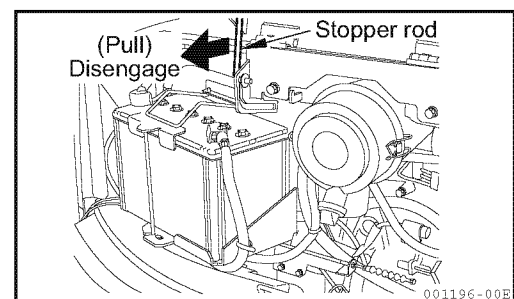

**13-6. Storage space for the operation & maintenance manual**

Storage space for the operation and maintenance manual is under the operator's seat.

Pull the lever and open the cover.

Press the cover until it clicks when closing.

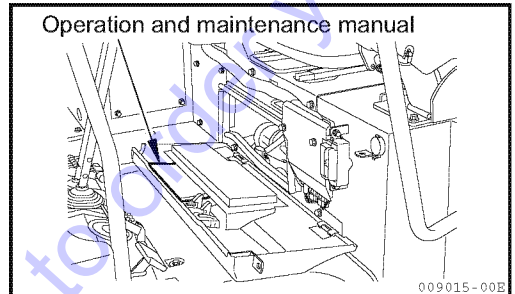
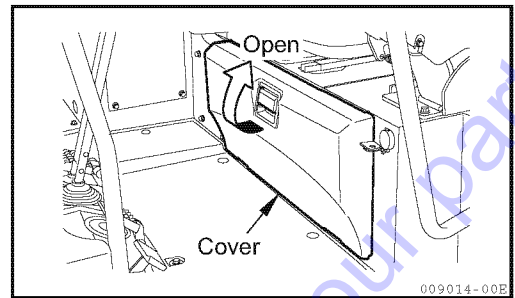

13-7. Windshield (for cabin)

**⚠ WARNING**

- To avoid bodily injury while operating the machine, make sure the door and windshield are locked in either the open or shut position.
- When the side door or the windshield is opened and it is not securely locked, it may be closed suddenly on impact during operation. It may cause bodily injury : for example, your hands are put between the door or the windshield and the cabin frame or your head is hit against them.
- Do not put your hand or head out of the opened side door or windshield. When opening the side door or the windshield, lock it securely.

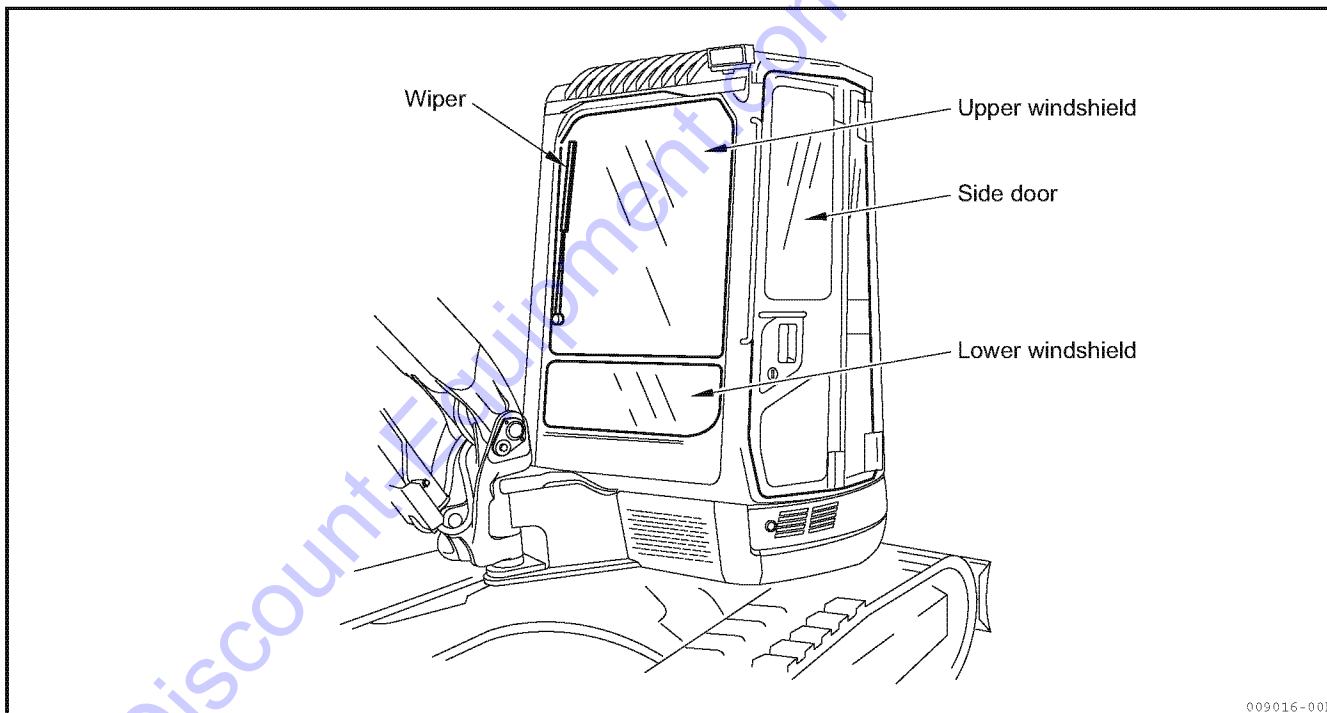

**⚠ WARNING**

Both the upper and lower windshields can be opened and closed.  
When housing or closing the upper and / or lower windshields, they may get down suddenly. To prevent this, lock them securely with the lock levers.

## ⚠ WARNING

- To avoid bodily injury, securely grasp the handles with both hands when opening and closing the windshield.
- Securely lock the windshield using the lock levers and the window locks when storing or closing the upper and lower front windshields.
- When opening or closing the front windshield, be sure to place the lock levers securely in the lock position.

### ■ Opening the upper windshield

- 1) Hold the handles with your hands and turn the right and left lock levers (A) to the arrowed direction to release the lock.
- 2) Slide the windshield to the upper rear side while pulling it to this side.
- 3) Lock the upper windshield housed under the ceiling securely with the right and left lock levers (A).

### ■ Closing the upper windshield

- 1) Hold the handles with your hands and release the right and left lock levers (A).
- 2) Holding the handles, lower the upper windshield slowly.
- 3) Lock the upper windshield securely with the right and left lock levers (A).

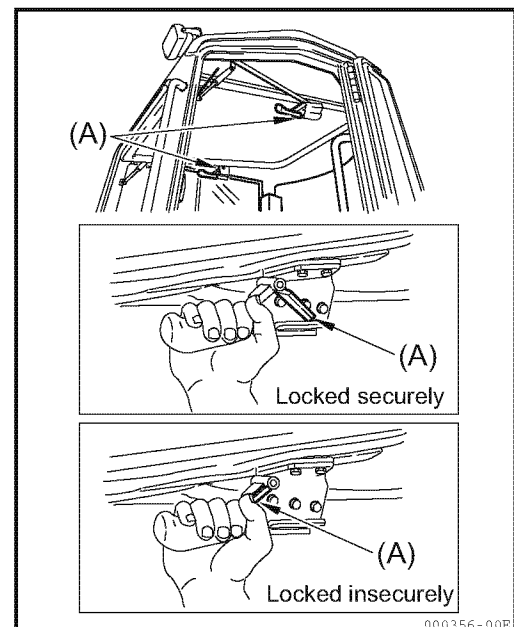
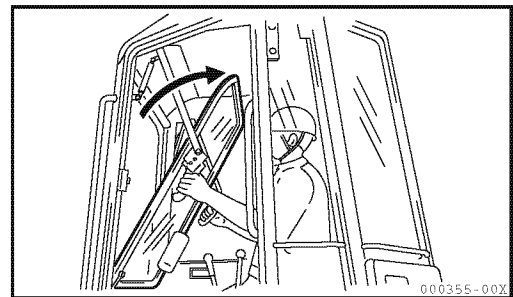
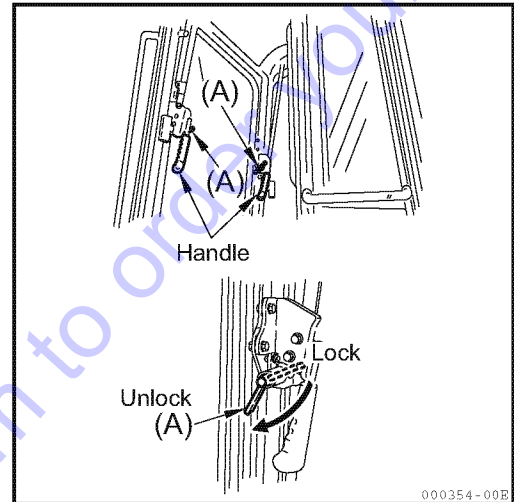
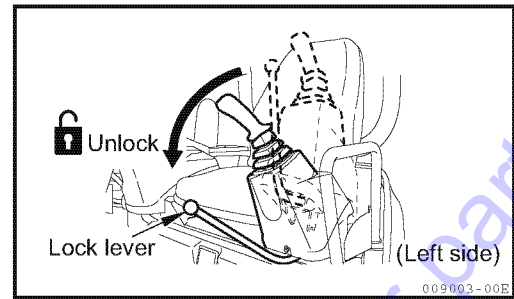

■ Opening and closing the lower windshield

**CAUTION**

Open and close the lower windshield after housing the upper windshield.

- 1) Hold the lower windshield with both hands to lift it up.
- 2) Put the lower windshield in the storage area on the rear left of the cabin.
- 3) Lock the lower windshield securely by pressing it against the window locks (D).
- 4) Push the upper side of each window lock (D) to remove the windshield put in storage.

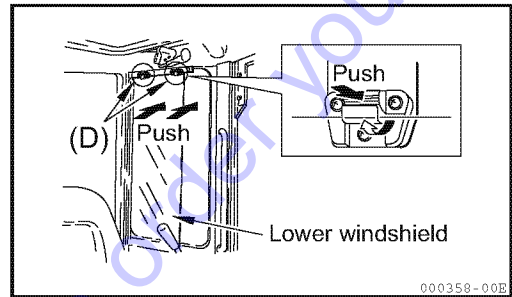
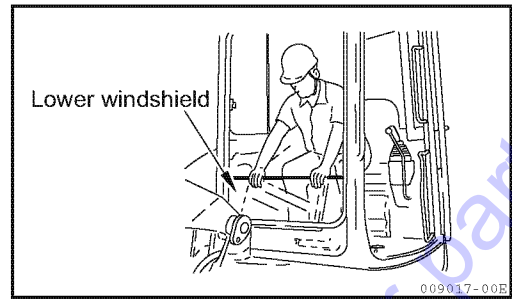

13-8. Operator's seat

**WARNING**

- Be sure to adjust the seat slide to obtain the best operating position whenever you start operation or a new operator begins to operate the machine.
- Do not place any objects within the moving area of the operator's seat.
- Do not adjust the operator's seat while operating the machine.

Adjust the seat so that the operator can easily operate the control levers in good posture.

■ Seat position control adjustment (forward and backward)

Pull the slide lever (A) under the seat upward to slide the seat forward or backward.

The adjustable amount of the seat for forward and backward sliding is 2.95 in. (75 mm)

And the seat can be adjusted at any of the five levels within 2.95 in. (75 mm)

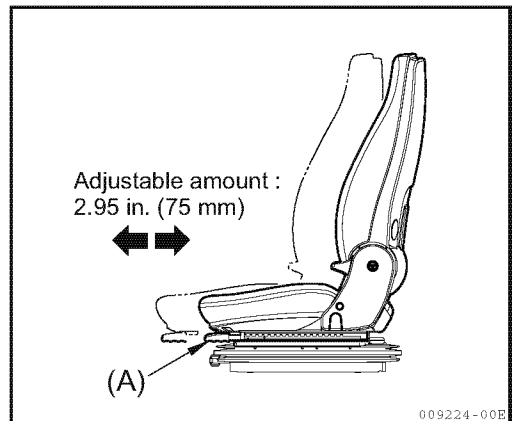



■ **Weight adjustment (Except air conditioner spec. type)**

- 1) The seat can be adjusted for the operator's weight by turning the weight adjuster lever (B) with the seat empty.  
The setting weight can be read at the indicator (C).
- 2) Turn the weight adjuster lever (B) clockwise the setting weight is increased.
- 3) Turn the weight adjuster lever (B) counterclockwise, the setting weight is decreased.

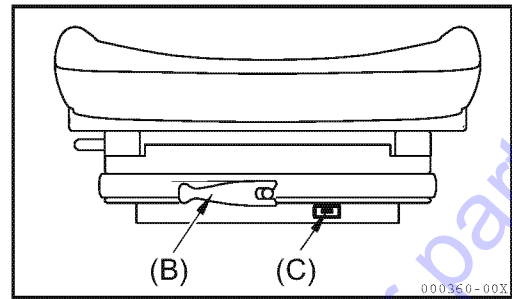

**13-9. Ash tray (for cabin)**

**⚠ WARNING**

**Do not place any combustible matter in the ash tray.**

Open the ash tray by pulling the lid to use it. Be sure to close the ash tray lid when it is not in use.

To empty and clean the ash tray, lift it up by holding both ends.

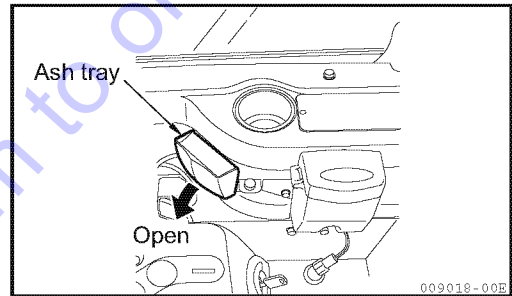

**13-10. Headlight**

**⚠ WARNING**

**The headlight gets hot when it is turned on. Do not touch it carelessly with your bare hand to prevent burns.**

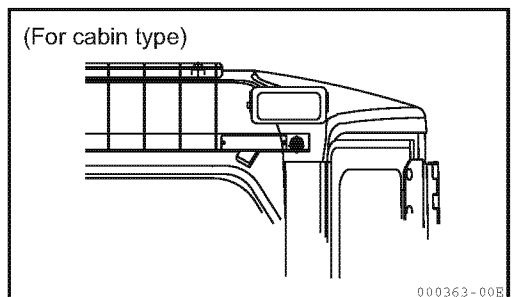
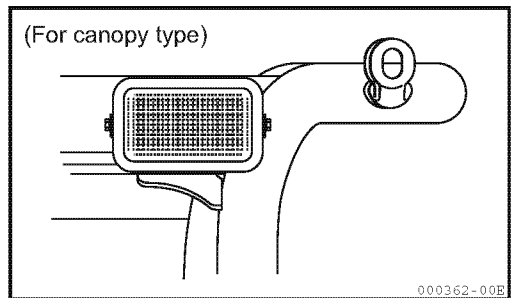

**13-11. Air outlet (for cabin)**

The wind direction is adjusted by changing the grille direction.

Move the grille to the desired position with a knob in the center of the grille.

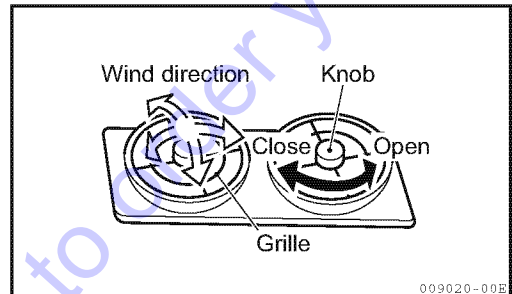
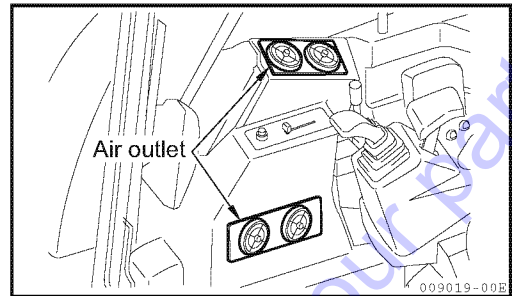

**13-12. Right window glass (for cabin)**

Open the right window glass in the arrowed direction.

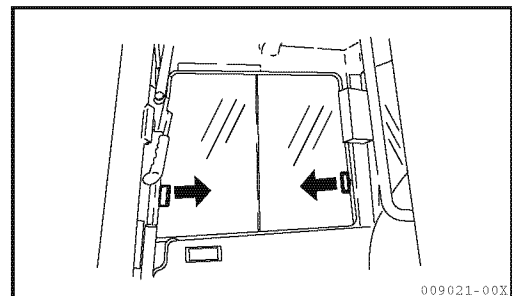

### 13-13. Cabin side door

#### 13-13-1. Opening and closing the cabin side door

- (1) From outside.
- 1) Turn the starter switch key counterclockwise to unlock the side door.
  - 2) Pull the outer handle to this side to open the side door.
  - 3) Close the side door and turn the key clockwise to lock to door.

(2) From the inside.

- 1) Pull the inner handle to this side to open the side door.

#### 13-13-2. Door lock

The door lock is used to hold the side door open.

- 1) Press the side door into the lock section to hold it open.
- 2) Press the lever (1) on the left side of the seat down to release the locked side door.

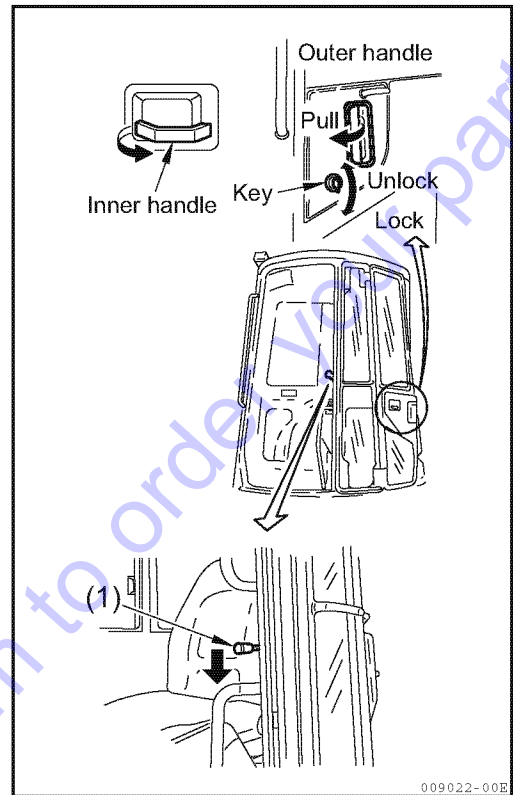

### 13-14. Replenishment of windshield washer fluid

- 1) Add windshield washer fluid, if necessary, to the reservoir.

#### ⚠ CAUTION

- When you add the reservoir with windshield washer fluid, take care not to enter dust into the reservoir.
- Determine the mixing ratio of the windshield washer fluid to water on the basis of the lowest past temperature

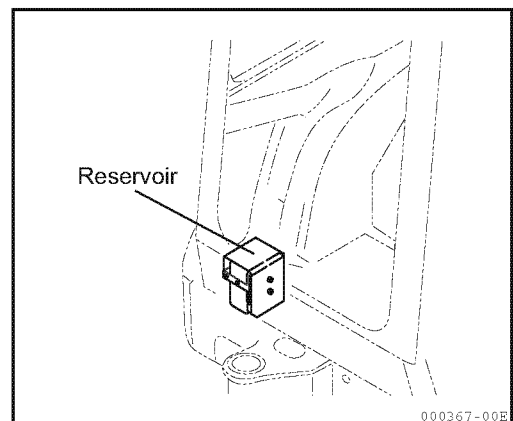

13-15. Fuse

**CAUTION**

- When replacing the fuse, be sure to turn off the power by setting the starter switch at the OFF position.
- Using a wire, aluminum foil or the like instead of the fuse could cause burnouts of the gauges, the electrical equipment and the wiring due to overheating.
- If a new fuse is blown out immediately after replacement, there may be a problem with the electrical system. Ask the nearest dealer for check and service.

The fuse protects the electrical equipment and wiring from becoming overheated. If the fuse is corroded with white deposits or if the fuse is loose in the holder, the fuse must be replaced with a new one.

**Position of the fuse box**

Blade fuse

It is installed on the front left of the sheet mount.

Slow-blow fuse

It is installed by the battery inside the engine hood rear cover.

**Replacing the fuses**

If the electrical equipment does not operate, the fuse may have been blown out. Follow the procedure below:

- 1) Set the starter switch at the "OFF" position.
- 2) Remove the fuse box cover.
- 3) If the fuse is blown out, replace it with a spare fuse of rated capacity.

| Symbol | Fuse capacity | Circuit name  |
|--------|---------------|---|
| A      | 15 A          | (Room lamp), (Window washer), Quick coupler, (Heater), (Air conditioner)              |
| B      | 30 A          | (Air conditioner)   |
| C      | 15 A          | Horn, (Head lamp), Monitor light, Boom lamp, 2-speed travel valve, Cab or Canopy lamp |
| D      | 15 A          | (Wiper), (Heater relay)   |
| E      | 15 A          | Timer, Safety relay, Generator, Fuel feed pump, Engine stop solenoid                  |
| F      | 15 A          | Indicator box, Buzzer, Cut-off valve, Travel alarm                                    |
| G      | 5 A           | (Radio), Controller   |
| H      | 5 A           | Spare   |
| I      | 30 A          |   |
| J      | 15 A          |   |

The (oblique character) parts:  
Applicable to models with the relevant equipment.

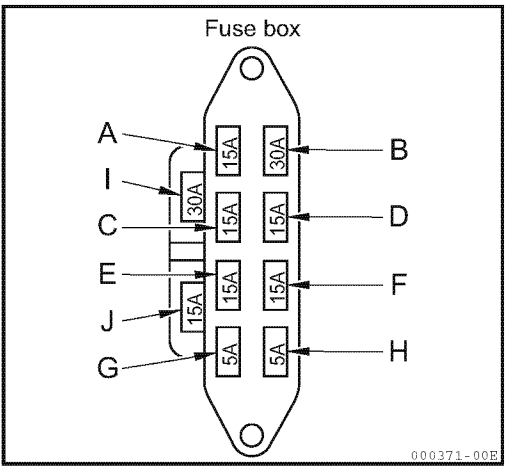
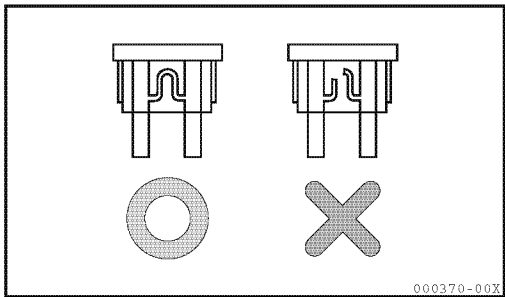
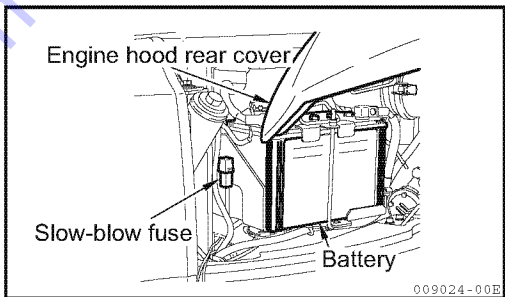
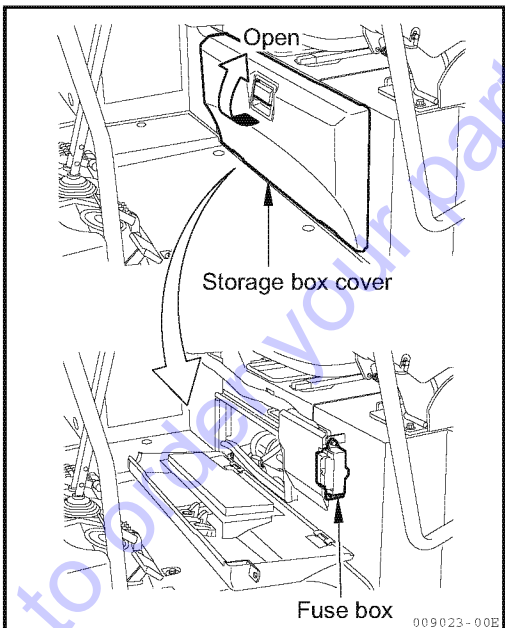

## 14. Operating Instructions

### 14-1. Checking before starting the engine

#### 14-1-1. Walking check (visual inspection) around the machine

#### **⚠ WARNING**

- If there are any combustibles in any heat build-up areas, or if there are any fuel and/or oil leaks, a fire can result.
- Check for possible fire causes carefully. If there is anything abnormal, be sure to take corrective action or contact your dealer.

Before starting the engine, visually check the outside and underside of the machine as follows: Check bolts and nuts for loose connections; check the fuel, oil, and water for leaks; and also check the implement and the hydraulic system to see that they are operating properly. In addition, check the electrical wiring for loose connections and for dust deposits in the heat build-up areas.

Check the following points before initial start-up for the day.

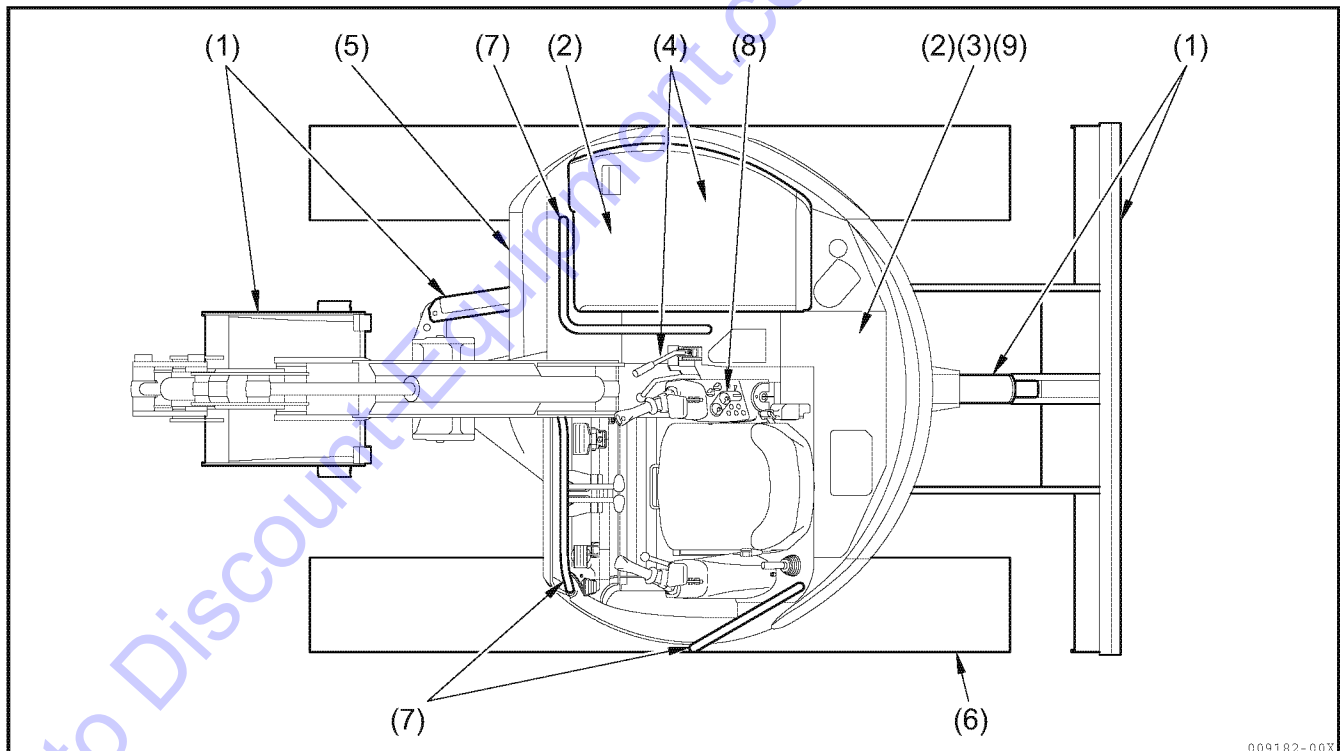

#### **(1) Checking the implement, hydraulic cylinders, linkages, and hoses for damage, wear and loose connections**

Check the implement, hydraulic cylinders, linkages, and hoses for damage, wear and loose connections. If any abnormality is found, take corrective action.

### **(2) Removing dust deposits from around the engine, battery, and radiator**

Check that there are no dust deposits around the engine or on the radiator, and that there are no combustibles (dead leaves, twigs, etc.) in the heat build-up areas, such as the engine muffler, or around the battery. If there are any, remove them.

### **(3) Checking the engine and its accessories for oil or water leakage**

Check the engine for oil leakage and the cooling water system for water leakage.

If oil or water leakage is found, take a corrective action.

### **(4) Checking the hydraulic system, hydraulic oil tank, hoses, and joints for oil leakage**

Check for oil leakage. If oil leakage is found, take corrective action.

### **(5) Checking the grease piping for grease leakage**

Check for grease leakage or ooze. If grease leakage or ooze is found, take corrective action.

### **(6) Checking the undercarriage (tracks, sprockets, and idlers) for breakage, wear, loose bolts, and oil leakage around the rollers**

If any breakage or wear is found, correct it. Retighten the bolts if necessary.

If oil leakage is found, take corrective action.

### **(7) Checking the handrails and steps for breakage and loose bolts.**

If any breakage is found, take corrective action. Retighten the bolts if necessary.

### **(8) Checking the gauges and the monitor for breakage and loose bolts**

Check the gauges and the monitor for breakage and loose bolts. If any abnormality is found, replace the gauge or the monitor with a new one, or retighten the bolts if necessary. Clean the surfaces of the gauges and monitor.

### **(9) Checking the fuel filter to see whether the red ring has sunk down at the cup bottom**

If the red ring has sunk down at the cup bottom, no water has mixed into the oil; if the red ring is floating in the cup, water is mixed into the oil under the red ring. In this case, take out the cup to remove the water.

**14-1-2. Checking before start-up**

Check the following points before initial start-up for the day.

■ **Checking and replenishing the cooling water**

**⚠ WARNING**

- **Do not remove the fill cap from the radiator unless refilling the coolant.**
- **Check the coolant water level in the sub-tank when the engine is cool.**

- 1) Open the engine hood rear cover. Then check that the cooling water level in the sub-tank (1) (illustrated in the right figure) is between the FULL and LOW marks. If the water level is below the LOW mark, refill the sub-tank up to the FULL mark through the water supply port of the sub-tank (1).

For the quality of cooling water to be used, refer to Section "23. Fueling, Oiling and Greasing Based on Temperature Range".

- 2) After replenishing, securely tighten the radiator cap.
- 3) If the sub-tank is empty, check it for water leakage, and then, check the water level in the radiator.  
If the water level is low, refill the radiator first, then refill the sub-tank.
- 4) If the cooling water level is appropriate, close the engine hood rear cover.

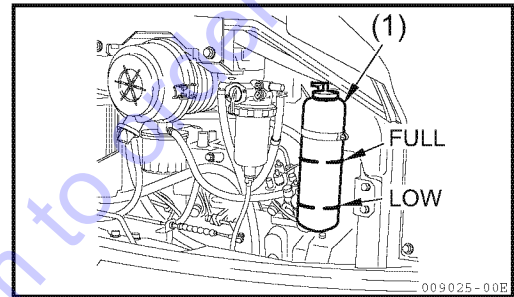

### ■ Checking and replenishing the engine oil

#### ⚠ WARNING

- At operating temperature, oil and dipstick areas are hot.  
Do not allow hot oil or components to contact skin to prevent bodily injury.
- Check oil level and refill oil after engine has cooled down.

- 1) Open the engine hood rear cover and securely lock it with the stopper.
- 2) Pick up the dipstick (G) and wipe it with a rag to remove oil deposits.
- 3) Insert the dipstick (G) into the dipstick tube fully, then draw it out.
- 4) If the dipstick (G) is wet above the midpoint between the H and L marks, the engine oil level is appropriate. If the oil level is below the midpoint between the H and L marks, supply engine oil through the oil supply port (F). For the quality of the engine oil to be used, refer to Section "23. Fueling, Oiling and Greasing Based on Temperature Range".
- 5) If the engine oil level is above the H mark, remove the excessive amount of oil through the drain plug (P), then recheck the engine oil level.
- 6) After verifying that the amount of engine oil is appropriate, securely retighten the oil supply port cap and close the engine hood rear cover.

#### Note :

When checking the engine oil level after starting up the engine, stop the engine and allow more than 15 minutes for the engine to cool down.

If the machine is slanted, reposition the machine to ensure it is level before checking the engine oil level.

Keep in mind that the excess engine oil must not be disposed of on the ground or the road.

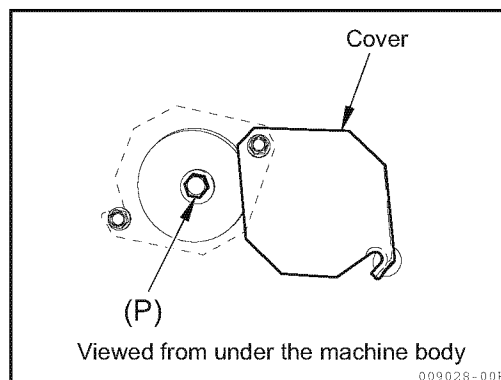
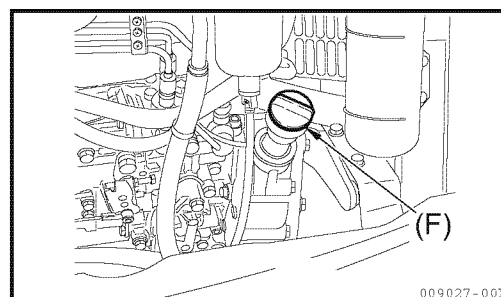
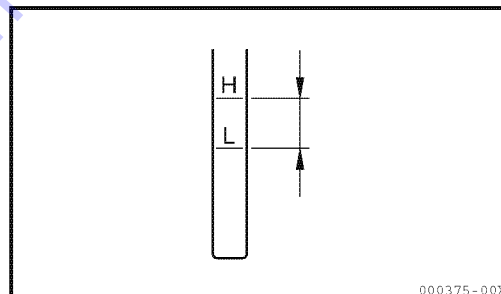
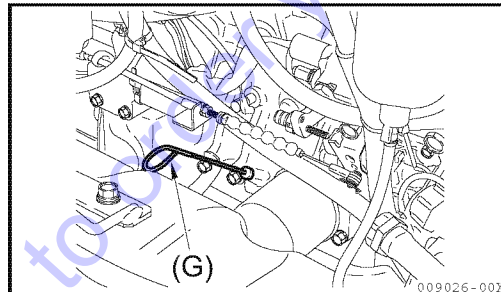



■ Checking the fuel level in the fuel tank and refueling

**⚠ WARNING**

Be careful not to overfill the fuel tank because it could cause a fire. If the tank is overfilled, completely wipe off the spilled fuel.

**⚠ CAUTION**

- Do not remove the strainer from the fuel supply port of the fuel tank to refill the tank.
- Be careful not to allow water settled at the bottom of the fuel container or dirt on refueling equipment to enter into the fuel tank.

- 1) Turn the starter switch to the "ON" position, and check the fuel level with the fuel gauge. Open the engine hood B, and supply fuel from the fuel supply port while checking the level gauge.

When the fuel gauge pointer indicates "E", approximately 3 Gals. (12 L) of fuel is left in the tank.

Capacity : 16.9 Gals. (64 L)

For the quality of the fuel to be used, refer to Section "23. Fueling, Oiling and Greasing Based on Temperature Range".

- 2) After refueling, securely retighten the fuel supply port cap, and close the engine hood B.

**Note :**

If the breather hole (1) in the cap is clogged, the pressure in the tank may decrease and the fuel may not be supplied adequately to the engine. Clean the engine breather hole from time to time.

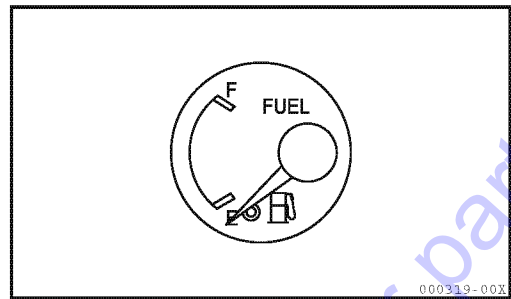

000319-003

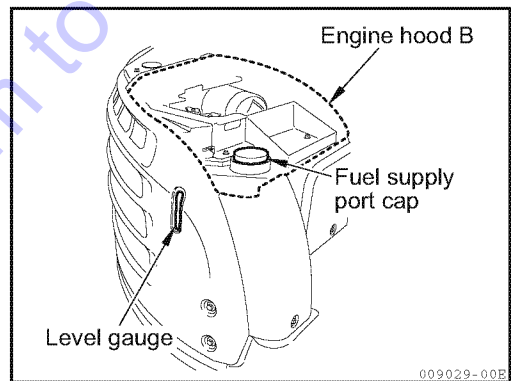

009029-00E

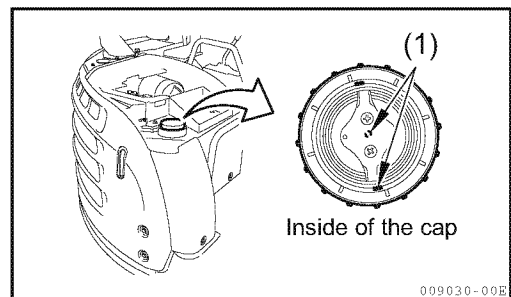

009030-00E

### ■ Checking and replenishing the hydraulic oil tank

#### **⚠ WARNING**

**When removing the plug of the oil supply port, slowly loosen it to release the pressure in the tank to prevent a dangerous high-pressure leak.**

- 1) Park the machine as illustrated in the right figure.  
When the machine is not in the posture in the right figure, start the engine, retract the bucket and arm cylinders to their stroke ends at low speed, lower the boom until the bucket teeth is placed on the ground, lower the blade to the ground, and stop the engine.
- 2) Check the oil level with the oil level gauge on the left side of the machine. The oil level must be between the upper and lower limit marks on the gauge.

#### **IMPORTANT**

**Do not replenish hydraulic oil above the upper limit mark on the oil level gauge. An excessive amount of hydraulic oil may damage the hydraulic system by placing stress on its components, causing a dangerous high-pressure leak.**

- 3) Open the engine hood rear cover to replenish oil from the oil supply port (F) if the oil level is below the lower limit.

For the quality of the oil to be used, refer to Section "23. Fueling, Oiling and Greasing Based on Temperature Range".

#### **Note :**

*Note that the oil level varies with the oil temperature. When reading the oil level, follow these guidelines:*

- *Before start-up, the oil level gauge should read the level around the midpoint of the gauge scale [oil temperature : 50 to 86°F (10 to 30°C)].*
- *During normal operation, the oil level gauge should read the level around the upper limit mark of the gauge scale [oil temperature : 122 to 176°F (50 to 80°C)].*

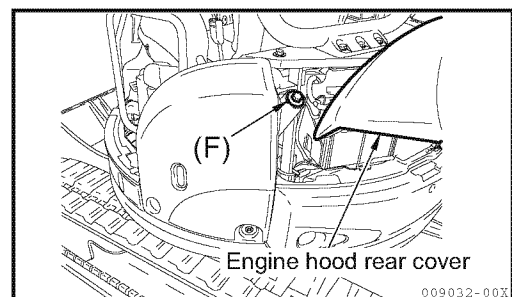
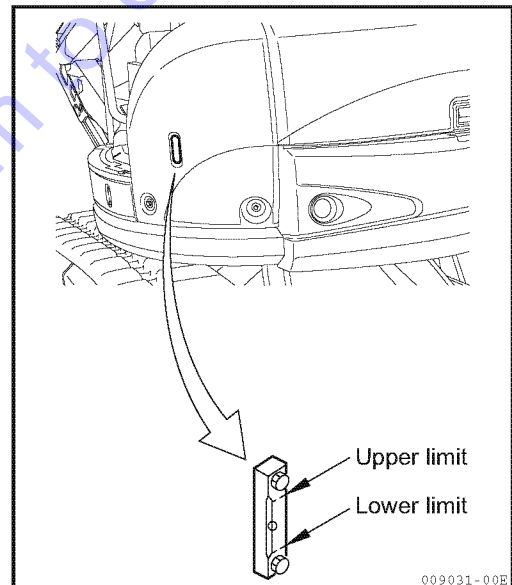
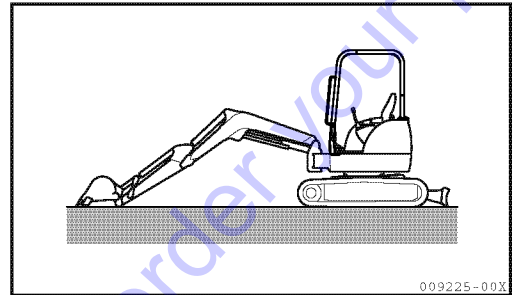

■ **Checking the fan belt tension**

- 1) Open the engine hood rear cover.
- 2) Press down the fan belt between the crankshaft pulley (1) and the generator pulley (2) with a finger to check the fan belt tension.  
Pressing load : Approximately 22.1 lbs. (10 kgf)  
Adequate slack : 0.39 to 0.59 in. (10 to 15 mm)
- 3) Adjust the tension if necessary.  
Refer to Section "27-6. Maintenance every 250 service hours" for the adjustment procedure.
- 4) When the tension is proper, close the engine hood rear cover.

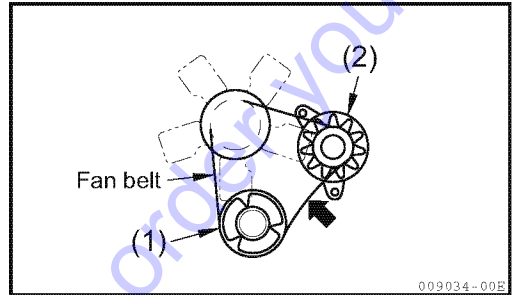
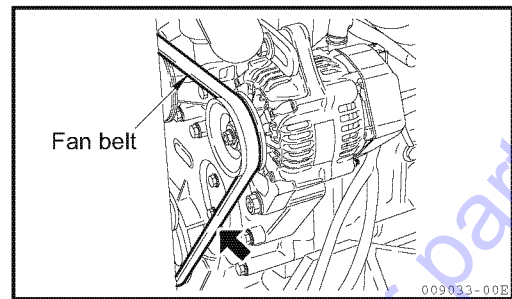

■ **Checking and replenishing the battery electrolyte**

**⚠ DANGER**

- **The battery generates flammable gas and can cause a fire and an explosion. Keep sparks, flames and lit cigarettes away from the battery.**
- **Battery electrolyte is strong acid. To avoid serious injury, do not allow the electrolyte to contact your skin or splash into your eyes.**
- **Always wear safety goggles and protective clothing, when adding electrolyte.**
- **Do not use the machine with the battery which is short of battery electrolyte. The shortage of battery electrolyte not only will reduce the life of the battery but also could cause an explosion.**

- 1) Open the engine hood rear cover to check the electrolyte level. The level must be between the upper and lower level marks.
- 2) If the electrolyte level is lower than the lower level mark, replenish it.

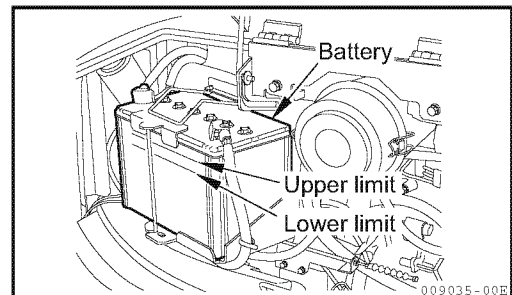

■ Greasing

**IMPORTANT**

Grease the fittings thoroughly after washing the machine or after operation in rain, on soft ground, or in muddy water.

- 1) Put the bucket and the blade on the ground and stop the engine.
- 2) Clean the grease nipples indicated with the arrows in the right figures and grease them using a grease gun.
- 3) After greasing, wipe off the excessive grease with waste cloth or the like.

Refer to Section "14-14-10. Maintenance" for the quick coupler.

■ Implement

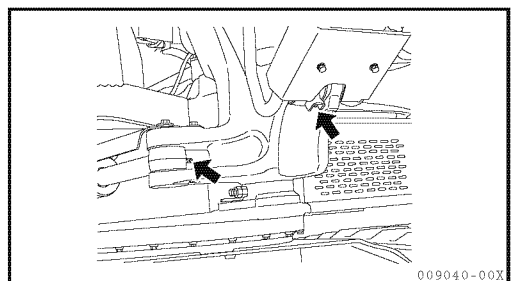
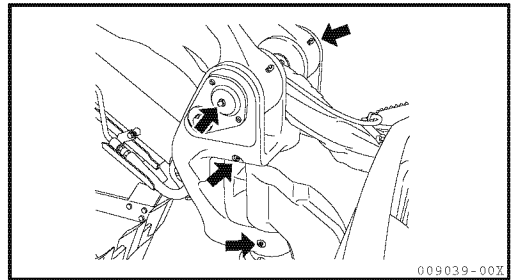
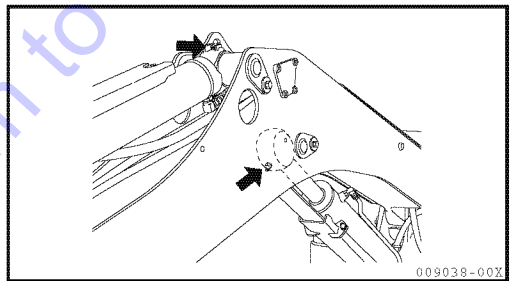
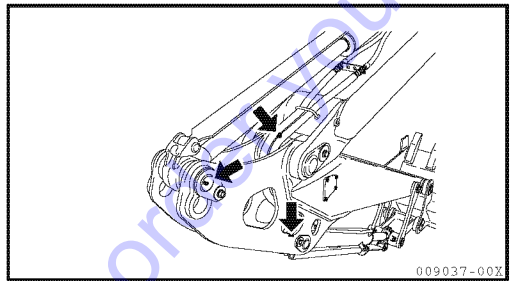
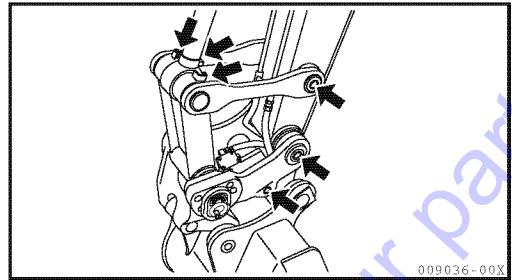

■ Blade

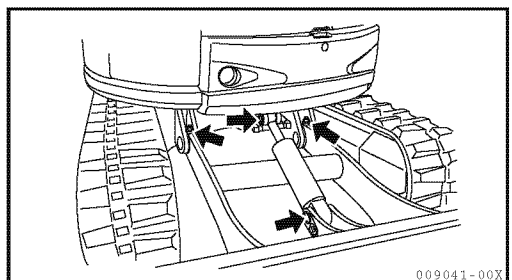

■ Checking the electrical equipment

**⚠ CAUTION**

**If a fuse blows out frequently, contact your dealer for assistance.**

Check fuses for damage, wiring for poor connections or short circuits, and battery terminals for corrosion or loose fits. Take corrective action.

Check the following items after the starter switch is turned to the "ON" position.

1) Check the monitor functions

- Check the fuel gauge, the water temp. meter and the hourmeter function.
- Check engine oil pressure alarm lamp, battery charge alarm lamp and water temperature alarm lamp for lighting.

2) Check that all switches function correctly and lamps light correctly.

- Check the headlight and the boom light.
- Check the wiper function. (for cabin)
- Check the room lamp for lighting. (for cabin)
- Check the heater function. (for cabin)

3) Check the travel alarm function.

- To check the travel alarm function, push or pull the travel levers after the lock levers are unlocked.

### 14-1-3. Operating and checking instructions before starting up the engine

#### **! WARNING**

- **Accidentally operating a control lever can cause the machine to move suddenly, possibly causing a serious accident.**
- **When leaving the operator's seat, be sure to place the lock levers securely in the lock position.**

1) Check that the lock levers (1) are in the lock position.

#### **Note :**

When both the lock levers are in the unlock position, the engine cannot be started. Pull either lock lever up to start the engine.

2) Check that all other levers are in their appropriate positions.

3) Fasten the seatbelt snugly.

4) Insert the key into the starter switch (2) and set it to the "ON" position. Then check the following points:

[1] The buzzer will sound, and the following alarm lamps will go on.

- Engine oil pressure alarm lamp (3)
- Battery charge alarm lamp (4)
- Water temp. alarm lamp (5) (turns off in 2 to 3 seconds)

If any of the alarm lamps does not go on or the buzzer does not sound, it may mean that the alarm lamp has blown out or the wire is broken. In this event, ask the dealer for repair.

[2] Position the light switch to "ON" whether the head light and boom light will go on. If they do not go on, the lamp might have blown out or the wire might be broken. In this event, ask the dealer for repair.

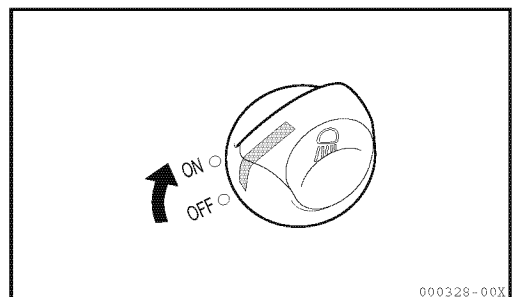
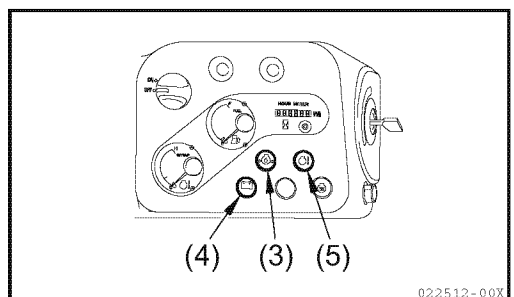
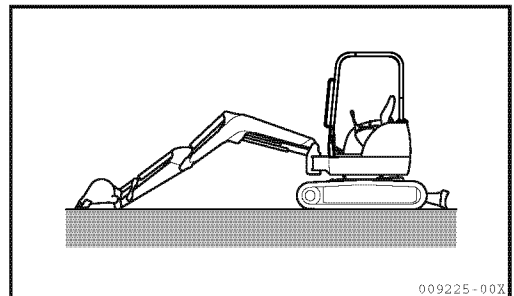
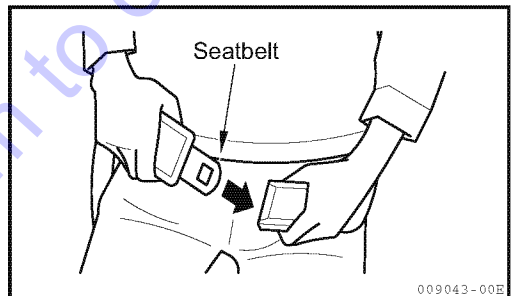
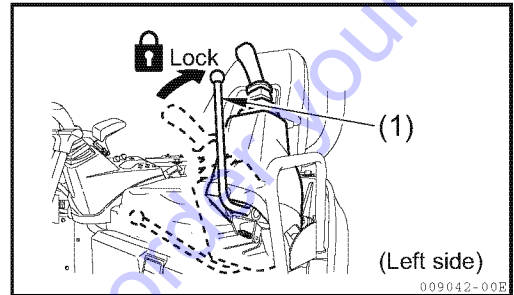
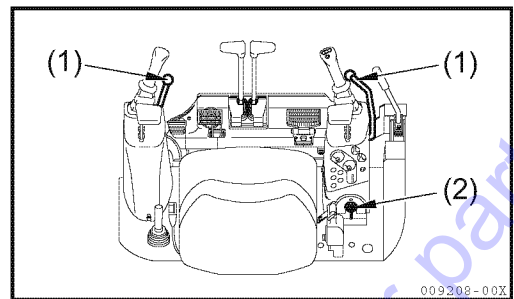

**14-2. Starting up the engine**

14-2-1. Normal start-up

**! WARNING**

- First check that there are no people or obstacles around the machine.  
Then sound the horn and start the engine.
- Be sure that you are seated in the operator's seat when starting the engine.
- When starting the engine in an enclosed place, be sure that there is adequate ventilation so that the exhaust gases can escape.

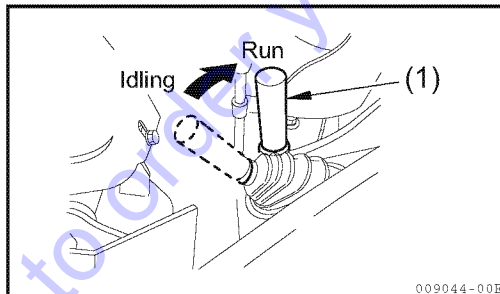
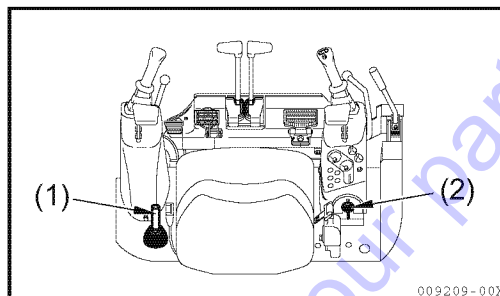

1) Pull the accelerator lever (1) back to the "RUN" position.

2) Set the key in the starter switch (2) to the "START" position. The engine will start.

3) After the engine has started, let go of the starter switch key.  
The starter switch key will return to the "ON" position by itself.

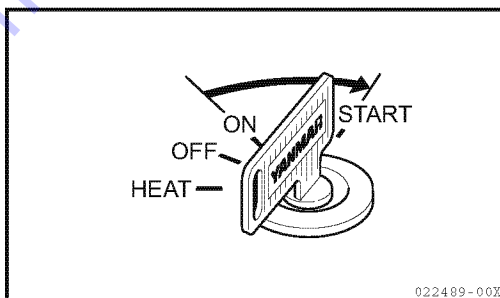

**Note :**

When the engine is warm, the engine can start up even if the accelerator lever is left in the "IDLING" position.

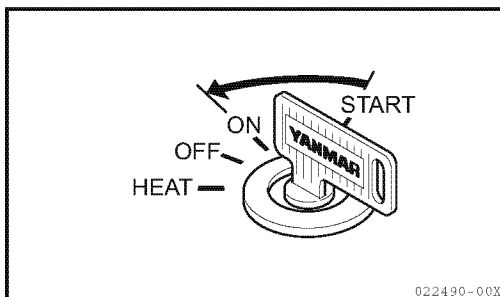

**IMPORTANT**

To protect the starter motor and the battery:

- Do not keep the key in the "START" position for more than 10 seconds.
- If the engine fails to start, do not attempt to start the engine immediately again, but set the switch to the "OFF" position and wait for approximately 30 seconds, then start the engine again.

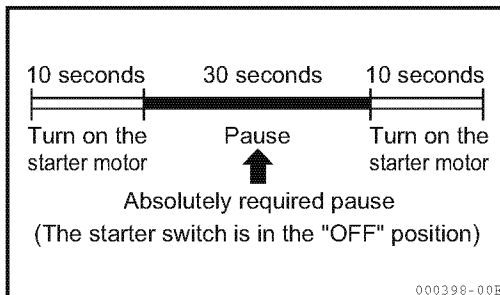

The swing motor with a brake is used. The brake of the swing motor is released when the engine starts.

### 14-2-2. Starting the engine in cold weather

#### **⚠ WARNING**

- First check to see that there are no people or obstacles around the machine.  
Then sound the horn and start the engine.
- Be sure that you are seated in the operator's seat when starting the engine.
- When starting the engine in an enclosed place, be sure that there is adequate ventilation so that the exhaust gases can escape.

To start the engine at a low outside air temperature, follow the steps below:

1) Pull the accelerator lever (1) back to the "RUN" position.

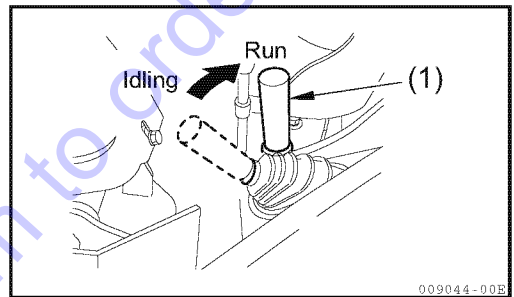
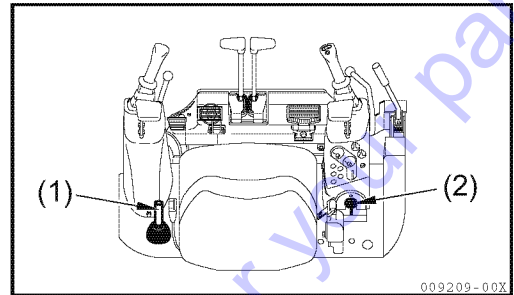

2) Turn the key in the starter switch (2) to the "HEAT" position and keep it there for approximately 10 to 15 seconds to preheat the intake air of the engine.

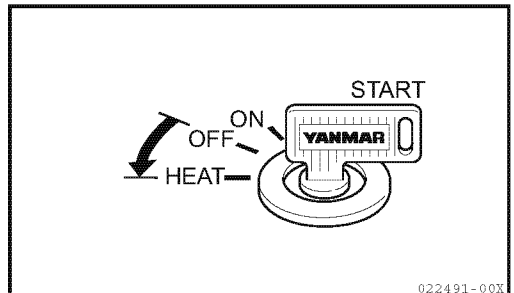

3) Turn the key in the starter switch (2) to the "START" position to start the engine.

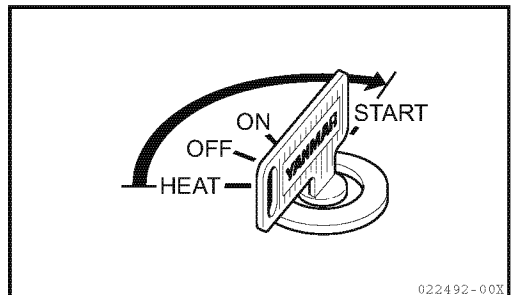

4) After the engine has started, let go of the starter switch key.

The starter switch key will return to the "ON" position by itself.

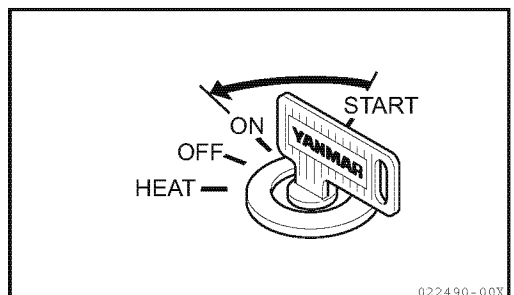



- 5) When the engine speed has increased, push the accelerator (1) forward to the "IDLING" position immediately.

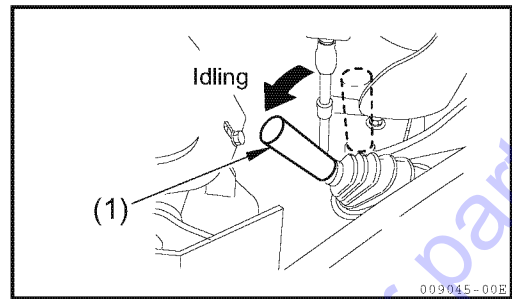

**IMPORTANT**

To protect the starter motor and the battery:

- Do not keep the key in the "START" position for more than 10 seconds.
- If the engine fails to start, do not start the engine immediately again, but set the switch to the "OFF" position and wait for approximately 30 seconds, then start the engine again.
- Traveling or operating the machine without adequate warming up in cold weather may adversely affect the machine performance, which causes low operating speed or traveling with deviation.

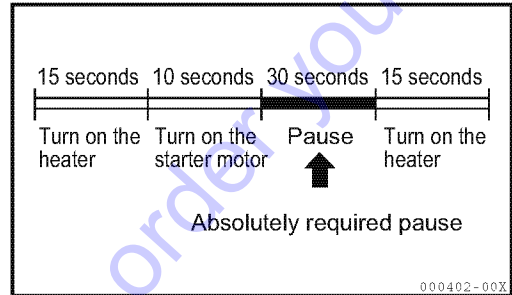

14-3. Operating and checking instructions after starting the engine

**⚠ WARNING**

- **Emergency stop.**  
If abnormal operation occurs, turn the starter switch key to the "OFF" position, to stop the electrical system and the engine. Then ask your dealer to check the machine.
- **Be sure to warm up the engine.** If you operate the implement without full warm-up, the machine may not respond or operate properly.  
Especially in cold weather, fully warm up the engine.

**IMPORTANT**

- The proper hydraulic oil temperature is between 122°F and 176°F (50°C and 80°C).  
If you have to operate the machine at a low hydraulic oil temperature, increase the hydraulic oil temperature to about 68°F (20°C) before operating the implement.
- In the event that you have to operate any control lever at a temperature of lower than 68°F (20°C), operate it gently.
- Do not accelerate the engine rapidly until the engine warms up.

After starting the engine, do not start operating the machine immediately but follow this procedure:

- 1) Idle the engine to check that the engine oil pressure alarm lamp is off.
- 2) Pull the accelerator lever (1) to the midpoint between the "IDLING" and "RUN" positions, and run the engine with no load at medium speed for approximately five minutes.

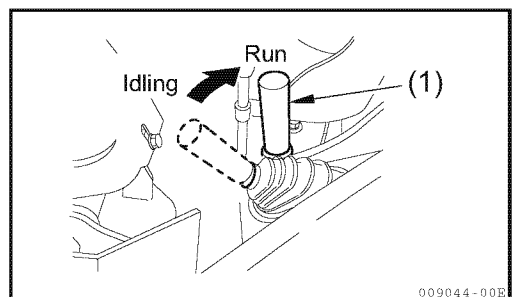
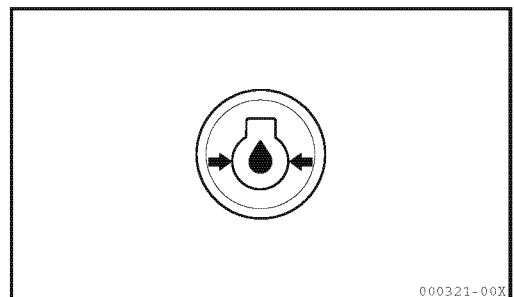
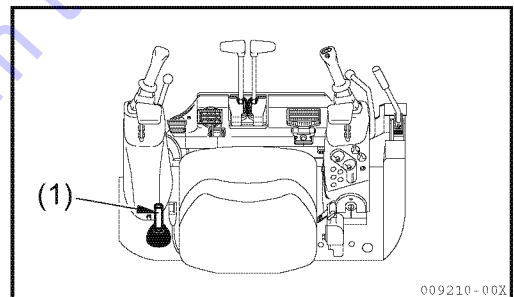

- 3) Unlock the lock levers, and lift the bucket from the ground.
- 4) Operate the bucket and arm control levers slowly to move the bucket and arm cylinders to their stroke ends. Operate the bucket for thirty seconds and the arm for thirty seconds alternately for approximately five minutes to increase the hydraulic oil temperature to 68°F (20°C).

**IMPORTANT**

**When moving the implement, be careful not to bump it against the machine or the ground.**

- 5) After warming up the engine, check that the gauges and the monitor are in the following status. If there is anything abnormal, take corrective action.

- Fuel gauge (1)..... Normal
- Water temp. meter (2)..... Normal
- Hourmeter (3)..... Normal
- Engine oil pressure alarm lamp (4) ..... Off
- Battery charge alarm lamp (5)..... Off
- Water temperature alarm lamp (6) ..... Off

- 6) Check the exhaust gas color, the machine noise, and the vibration level for abnormality. If something is abnormal, take corrective action.

- 7) Set the lock levers to the "LOCK" position to check that the implement cannot be operated and the upperstructure cannot be swung with the left and right control levers.

- 8) Unlock the lock levers and operate the control levers to check that the implement can be operated and the upperstructure can be swung normally with the control levers. If something is abnormal, take corrective action.

- 9) Check to see that the swing brake valve operates normally. If something is abnormal, take corrective action.

- 10) Check that no abnormal noise is heard from the hydraulic system. If any abnormal noise is heard, take corrective action.

Ask your dealer to resolve the problems described in the steps 1) to 10) above.

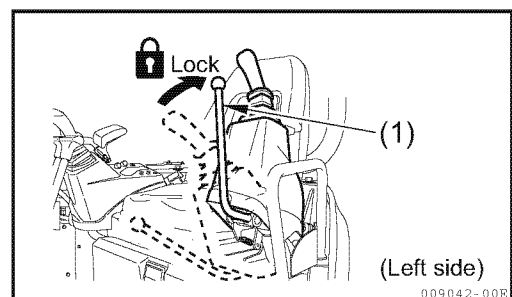
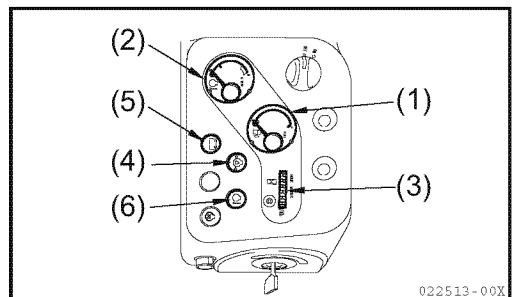
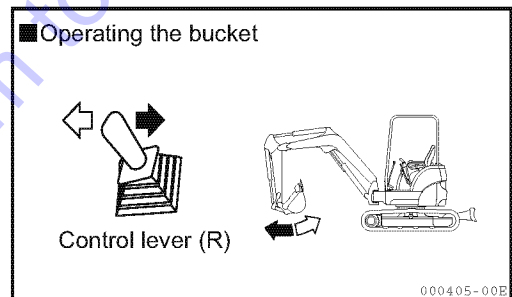
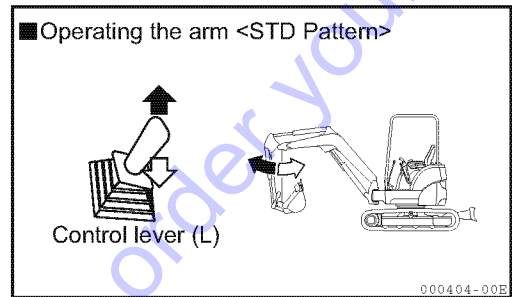
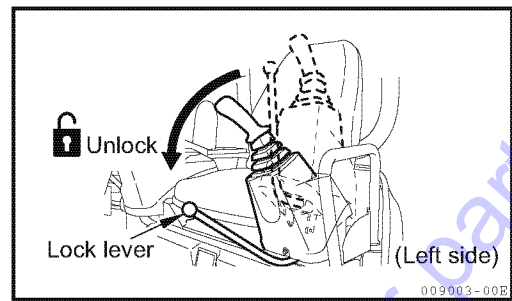

## 14-4. Traveling

### 14-4-1. Traveling forward

#### **! WARNING**

- Always check the position of the blade before operating the travel levers and pedals.
- When the blade is in the rear, the travel levers and pedals operate in the reverse of the normal operation.
- A signal person should be in attendance to give signals at sites which are dangerous or not clearly in view of the operator.
- Clear all people from the working area.
- Sound the horn before beginning travel, to alert the people near the machine.
- Clear obstacles from the path of the machine.
- Do not operate the travel levers and pedals rapidly while the engine is running at high speed. Otherwise, the machine may move unexpectedly, causing a serious accident.

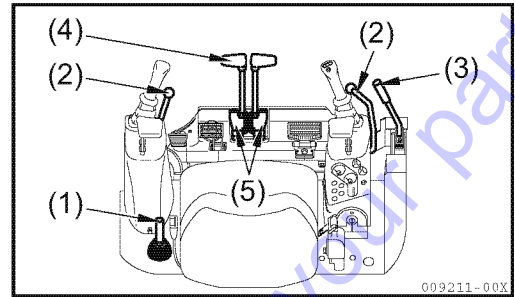

- 1) Pull the accelerator lever (1) back to the "RUN" position to increase the engine speed.

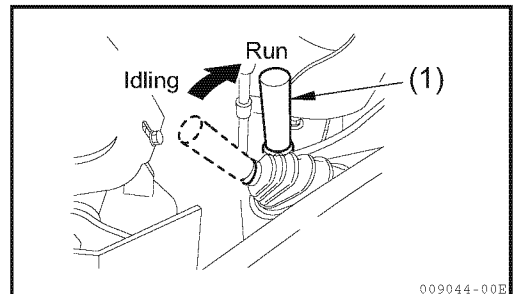

- 2) Unlock the lock levers (2), and retract the implement to lift it 16 to 20 in. (40 to 50 cm) above the ground.

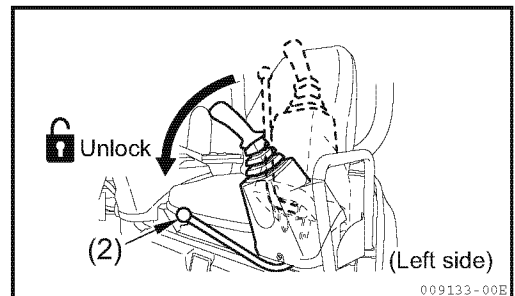

3) Pull back the blade lever (3) to lift the blade.

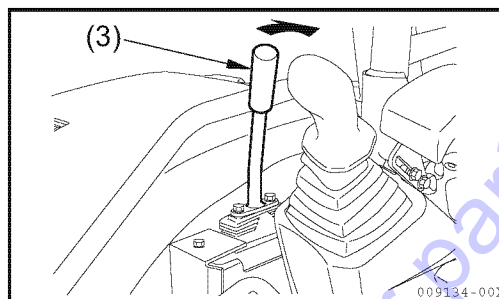

4) Operate the left and right travel levers (4) or pedals (5) as follows:

- When the blade is in the front of the machine; Slowly push the travel levers (4) forward or step on the front of the pedals (5) to move the machine forward.

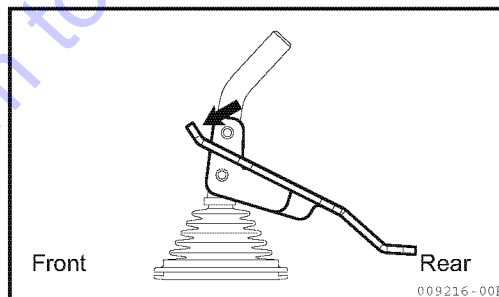
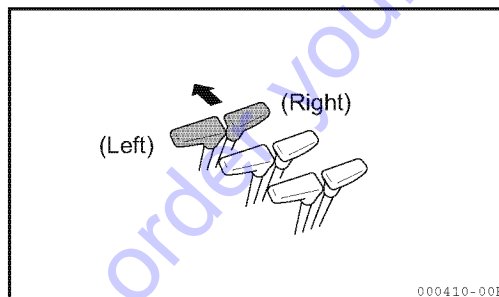

- When the blade is in the rear of the machine; Slowly pull the travel levers (4) back or step on the rear of the pedals in order to move the machine forward.

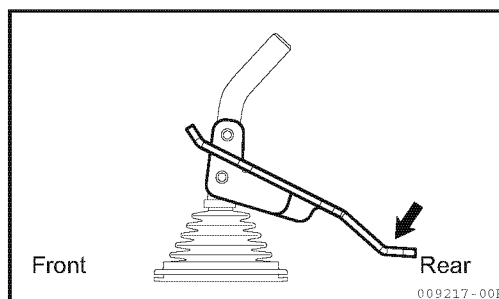
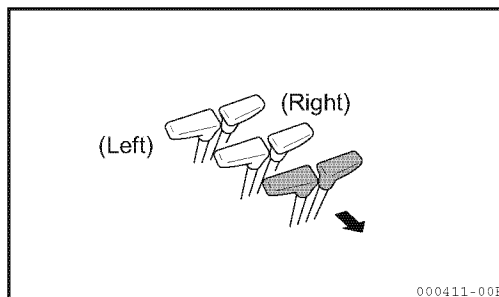

14-4-2. Traveling in reverse

**⚠ WARNING**

- Always check the position of the blade before operating the travel levers and pedals. When the blade is in the rear, the travel levers and pedals operate in the reverse of the normal operation.
- A signal person should be in attendance to give signals at sites which are dangerous or not clearly in view of the operator.
- Clear all people from the working area.
- Sound the horn before beginning travel, to alert the people near the machine.
- Clear obstacles from the path of the machine.
- There is a blind spot behind the machine. Make sure that no people are in the blind spot before traveling backwards.
- Do not operate the travel levers and pedals rapidly while the engine is running at high speed. Otherwise, the machine may move unexpectedly, causing a serious accident.

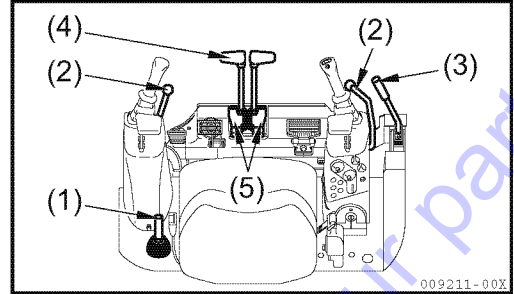

1) Pull the accelerator lever (1) back to the "RUN" position to increase the engine speed.

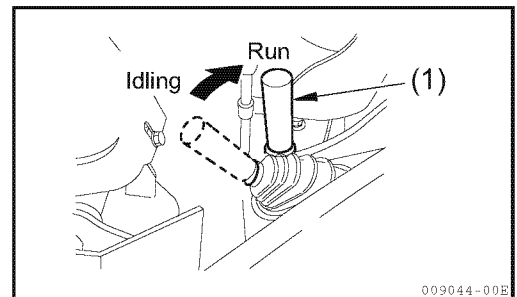

2) Unlock the lock levers (2), and retract the implement to lift it 16 to 20 in. (40 to 50 cm) above the ground.

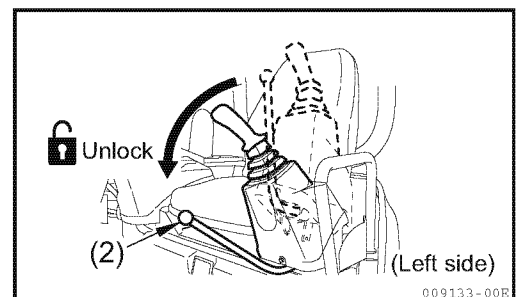

3) Pull back the blade lever (3) to lift the blade.

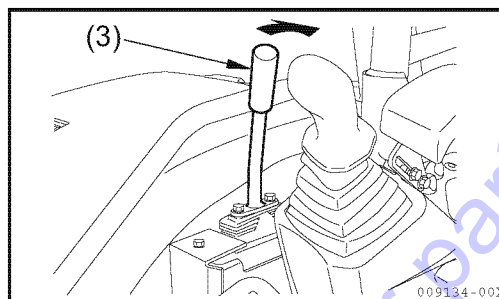

4) Operate the left and right travel levers (4) or pedals (5) as follows:

- When the blade is in the front of the machine; Slowly pull the travel levers (4) back or step on the rear of the pedals in order to move the machine backward.

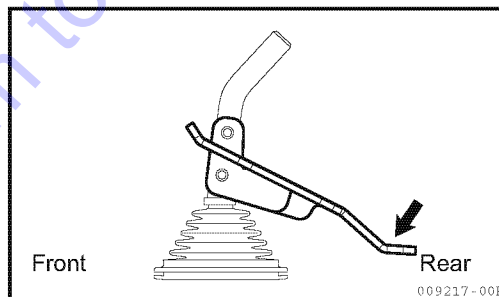
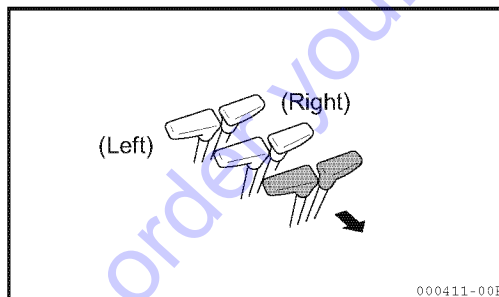

- When the blade is in the rear of the machine; Slowly push the travel levers (4) forward or step on the front of the pedals (5) to move the machine backward.

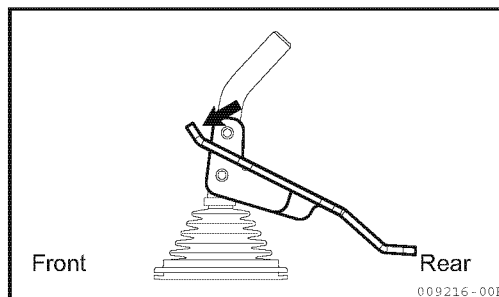
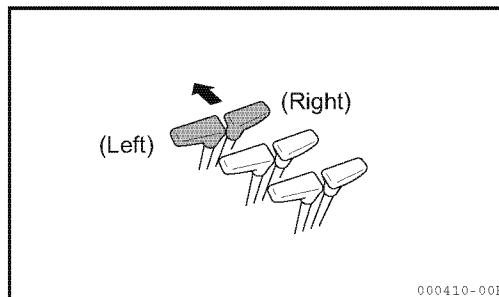

## 14-5. Steering

### 14-5-1. Steering (Turning the machine)

#### **⚠ WARNING**

Always check the position of the blade before operating the travel levers.

When the blade is in the rear, the travel levers operate in the reverse of the normal operation.

Do not use the travel pedals to steer the machine, or the machine may not be controlled expectedly, causing a serious accident.

To steer the machine, operate the travel levers only. Do not turn the machine too sharply. Before spin-turning, stop the machine.

Operate the two travel levers (1) as follows:

#### ■ Steering the machine when it is not traveling

To turn left, push the right travel lever forward and start traveling forward on the left. Pull the right travel lever back and start traveling in reverse on the left.

#### **Note :**

To turn right, operate the left travel lever in the same manner as above.

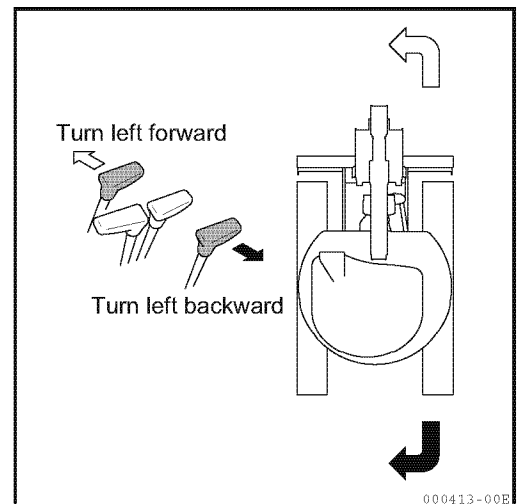
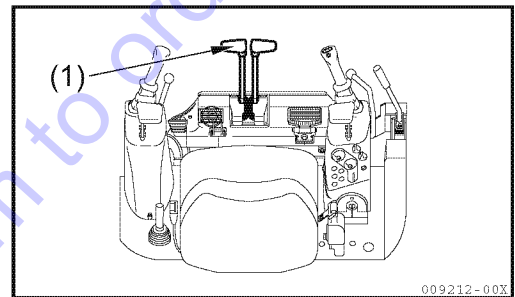



■ **Steering the machine while traveling (the left and right travel levers are both tilted in the same direction)**

To turn left, return the left travel lever to the neutral position.

**Note :**

To turn right, operate the right travel lever in the same manner as above.

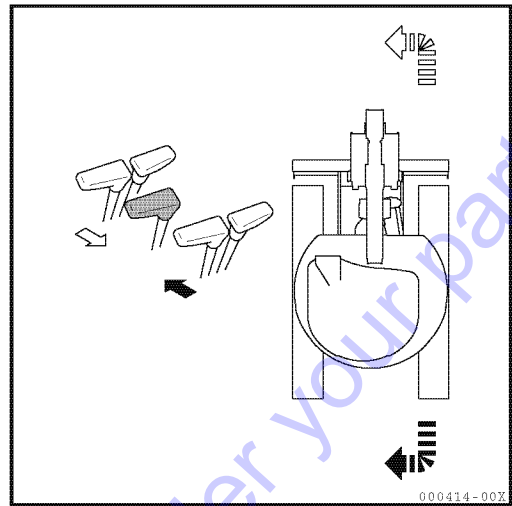

■ **Spin-turning the machine when it is not traveling**

To spin-turn left, push the right travel lever forward while pulling the left travel lever back.

**Note :**

To spin-turn right, push the left travel lever forward while pulling the right travel lever back.

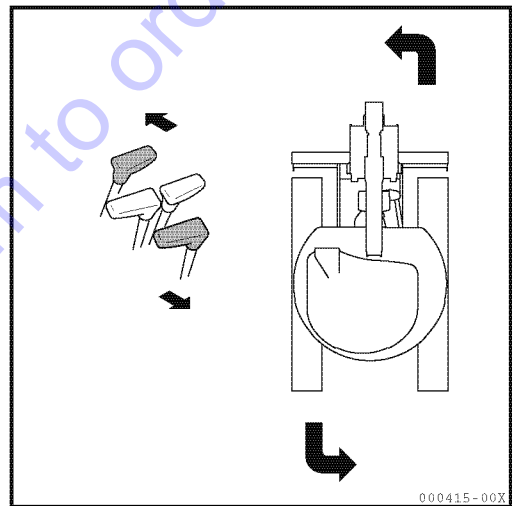

14-6. Stopping the machine

**⚠ CAUTION**

Do not stop the machine suddenly but provide a safety margin.

**⚠ WARNING**

- Park on solid, level ground.
- Do not park on a slope. If it is unavoidable to park on a slope, put solid pieces of wood under the track as blocks, place the blade on the ground, and dig the bucket into the ground.

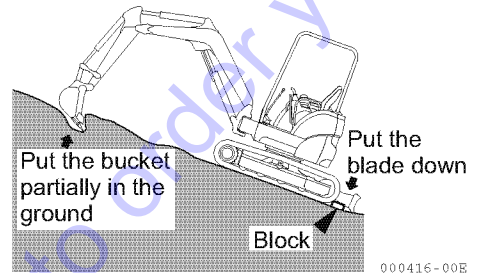

**⚠ WARNING**

- Do not touch the control levers and pedals accidentally. Otherwise, the implement or the machine may move unexpectedly, causing serious bodily injury.
- Whenever leaving the operator's seat, be sure to place the lock levers securely in the lock position and remove the starter switch key.

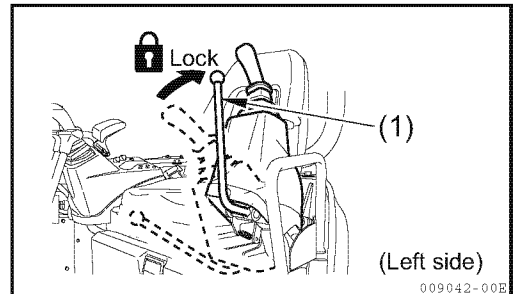

- 1) Set the right and left travel levers (1) or pedals (2) to the neutral position to stop the machine.

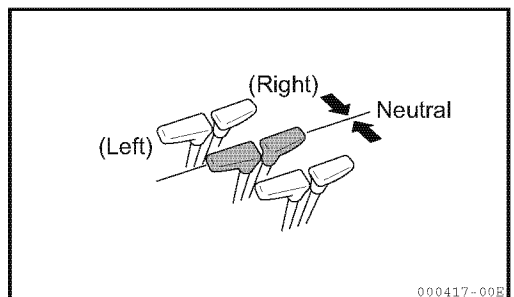
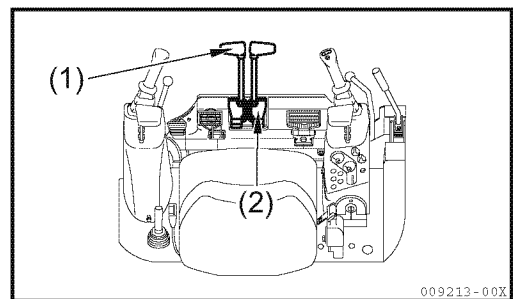

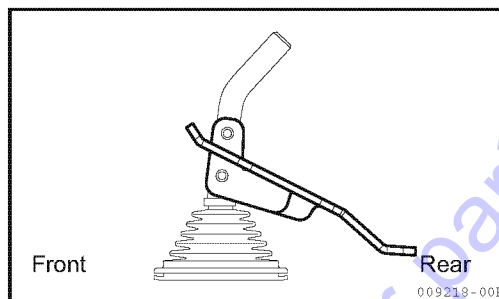

**14-7. Swinging the upperstructure**

**⚠ WARNING**  
Before swinging, make sure that there are no people or obstacles within the swing range of the implement or the machine tail.

- 1) To swing the upperstructure, operate the left control lever as illustrated in the right figure.  
(A) : Swing right  
(B) : Swing left

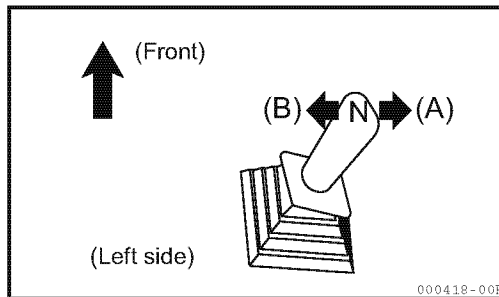

14-8. Operating the implements

**⚠ WARNING**

- Check the area around the machine for safety and sound the horn before beginning to operate the machine.
- According to the switching of pattern change lever, control lever operation can be chosen in two patterns.
- To prevent accidental injury, never operate Excavator before confirming location of pattern change lever.

Operate the machine using the right and left control levers, the boom swing pedal and the blade lever.

<STD Pattern>

- Control lever (L) : Operates arm and upperstructure swing.
- Control lever (R) : Operates boom and bucket.

<OPT Pattern>

- Control lever (L) : Operates boom and upperstructure swing.
- Control lever (R) : Operates arm and bucket.
- Boom swing pedal : Operates boom swing.
- Blade lever : Operates blade.

The relation between the operation of the levers and the boom swing pedal, and the movement of the implement are shown in the illustrations on the right.

On releasing the levers and the boom swing pedal, they return to the neutral position and the implement will stop as they are.

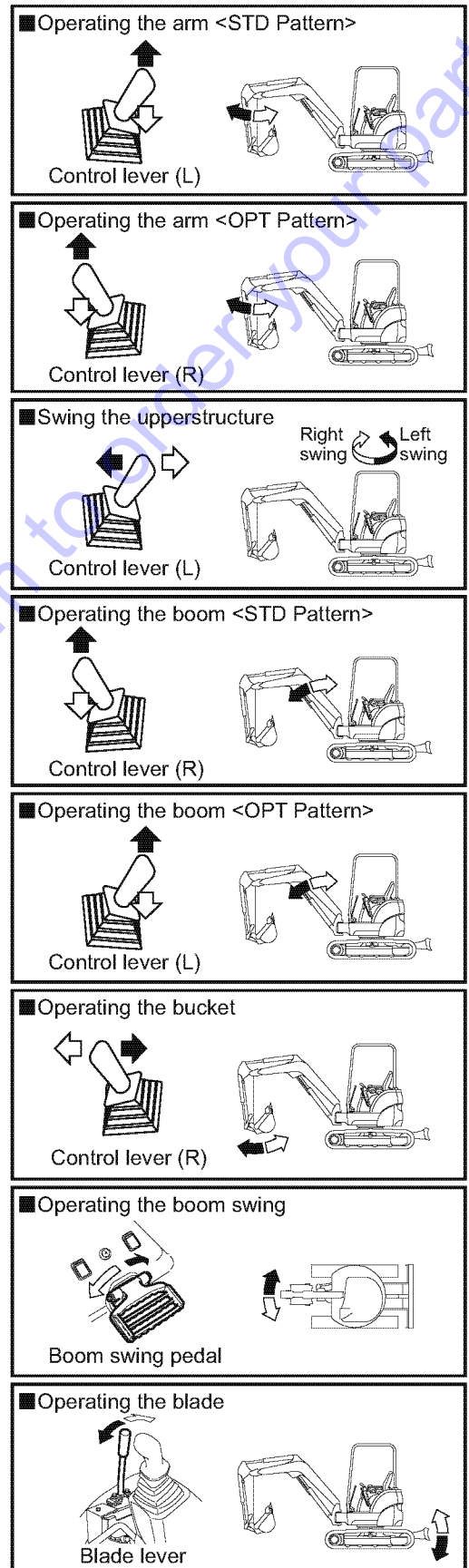

009135-00E

## 14-9. Precautions for operating the implement

**⚠ WARNING**

- Do not operate the implement control levers while traveling. Stop traveling first and then operate the implement.
- Do not operate the implement on a rocky surface (on hard and soft rocks).

**■ Do not use the implement's swing force**

Do not level the ground or break down a wall by the use of swing force, and do not dig the bucket teeth into the ground while swinging. Doing these may cause the implement to be damaged.

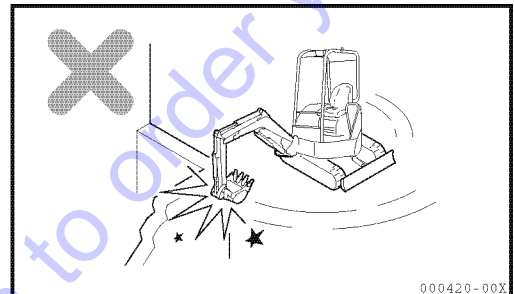
**■ Do not use the implement's travel force**

Do not excavate the ground by the use of travel force with the bucket teeth in contact with the ground. Doing this may cause excessive force to be imposed on the rear of the machine, shortening the machine life.

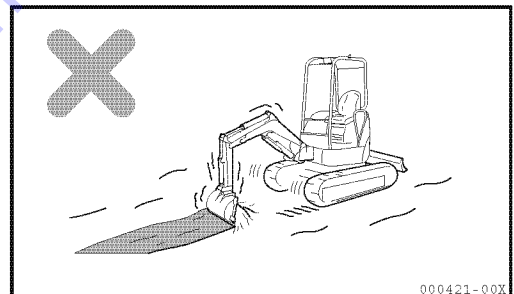
**■ Take care not to operate the hydraulic cylinder to the stroke end.**

Operating the hydraulic cylinder to the stroke end may impose an undue force on the stopper in the hydraulic cylinder, shortening the implement life. Operate with a small safety margin.

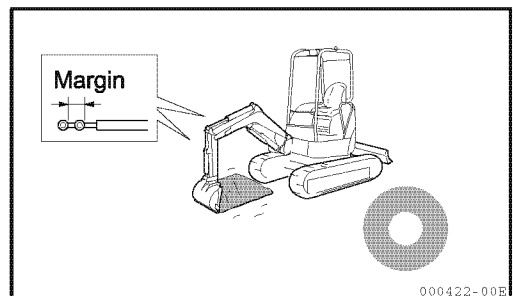
**■ Do not operate the implement by the using the dropping force of the bucket**

Do not excavate the ground by using the dropping force of the bucket as a pickaxe or pile driver. Doing this may cause excessive force to be imposed on the rear of the machine, shortening the machine life and possibly causing a serious accident.

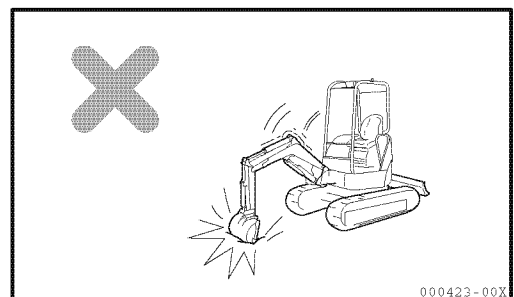

## 14. Operating Instructions

### ■ Do not operate the implement by using the dropping force of the machine

Do not excavate the ground by using the dropping force of the machine.

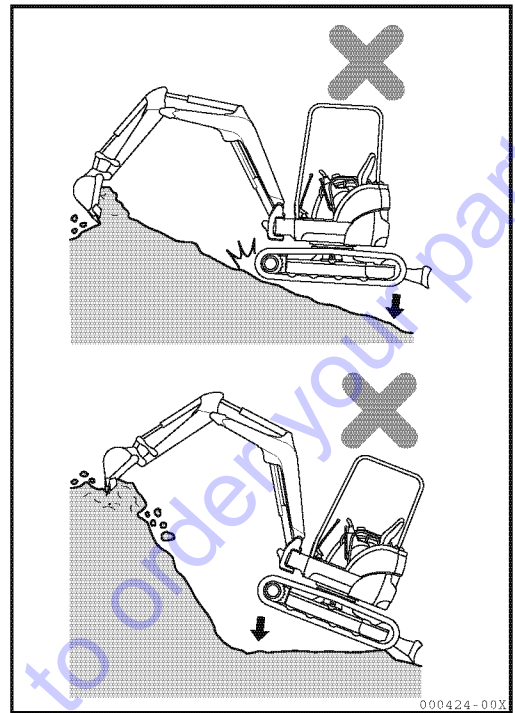

### ■ Excavating a hard rock

It is recommended that a hard rock first be broken into small pieces by other means. Doing so will prevent damage to the machine and will increase economy.

### ■ Do not suspend a load unless you use a hooked bucket

Suspending a load safely requires the use of a hooked bucket. Refer to Section "32. Handling the Hooked Bucket".

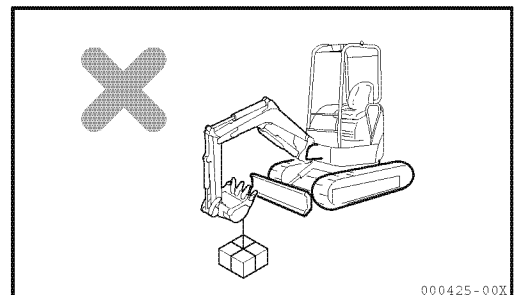

■ **Do not bump the blade against a large rock or boulder**

Do not bump the blade against a large rock or boulder. Doing so may cause the blade or the hydraulic cylinder to be damaged.

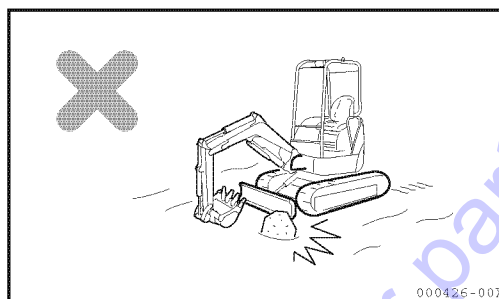

■ **Be careful when retracting the implement**

When retracting the implement for travel or transport, be careful that the bucket and the blade never bump against each other.

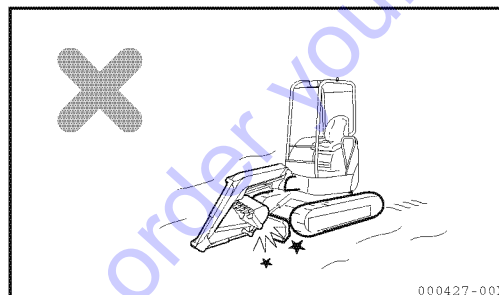

■ **Support the blade on both sides**

When you use the blade as an outrigger, support the blade on both sides.

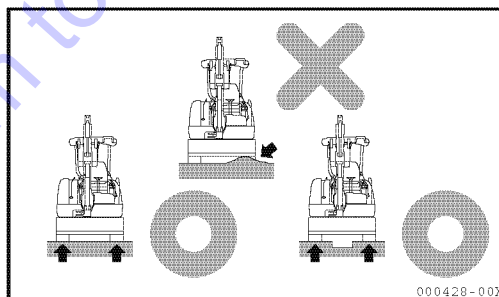

■ **Be careful not to bump the blade when excavating**

When excavating the ground with the blade in front, never let the blade bump against the boom cylinder. Place the blade in rear, if it is not being used.

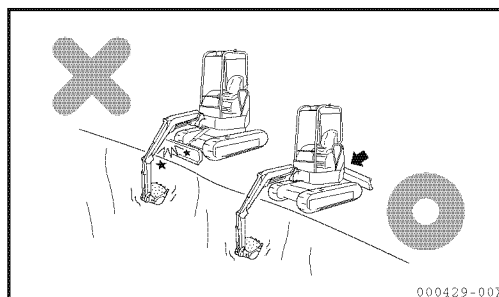

## 14-10. Precautions for working

### ■ Precautions for traveling

Driving over a stone or a stump subjects the machine (especially undercarriage) to a shock, which may cause damage to the machine.

Avoid such obstacles by driving around them, or removing them.

If driving over them is unavoidable, reduce speed, hold the implement close to the ground, and drive over the obstacles with the center of the track shoes.

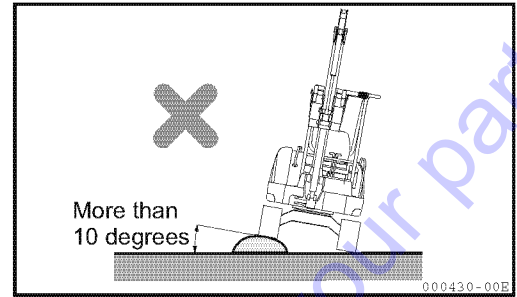

### ■ Allowable water depth

#### IMPORTANT

When driving out of water, if the machine climbs a slope at an angle of more than 15 degrees, the rear of the upperstructure may submerge too deeply in the water, which may damage the radiator fan since the radiator fan paddles the water. Avoid this if possible when driving out of water.

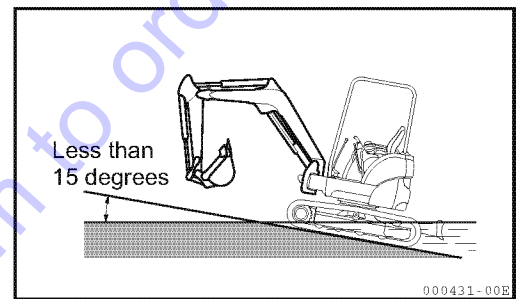

The limit of the water depth in which the machine can be used in is up to the center of the carrier roller.

Apply a generous amount of grease to the moving parts (especially bucket pin) that have been submerged in the water for a long time until the used grease is extruded out of the bearings.

Wipe the extruded used grease off with a waste cloth.

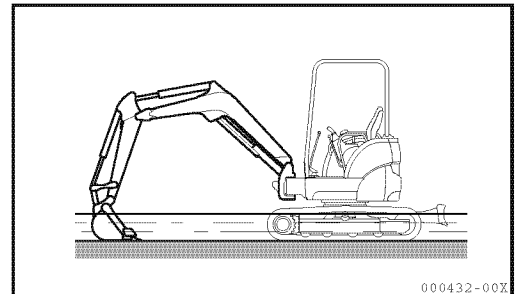



## 14-11. Precautions for going up and down a slope

**⚠ WARNING**

- When traveling on a slope, place the implement in the direction of travel and raise the bucket 8 to 12 in. (20 to 30 cm) above the ground.
- When driving over obstacles such as foot paths, hold the implement close to the ground and drive the machine slowly.
- Never turn on or traverse a slope. Descend to flat ground to make a course change.
- If the machine is starting to slip or you feel that the machine is unstable, place the bucket on the ground and stop the machine at once.
- Recognize that the machine may roll over when swinging the upperstructure or operating the implement on a slope. Do not swing the upperstructure toward the downward side of the slope with a load in the bucket. If swinging is unavoidable, first lay earth on the slope to maintain the machine as horizontal as possible, then swing the upperstructure.
- Do not travel on a slope of 20 degrees or more, as the machine may upset.

1) Go down slopes at low speed, using the travel levers and accelerator lever to control your speed.

When going down a slope, drive the machine at low engine speed and position the implement as shown in the right figure.

2) When climbing a slope, drive the machine with the implement positioned as shown in the right figure.

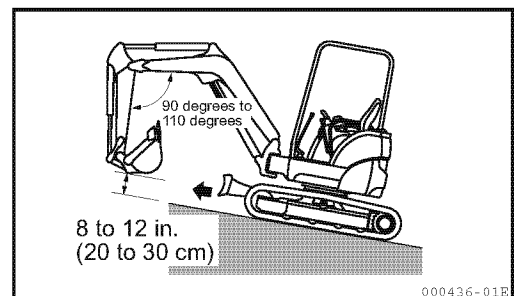
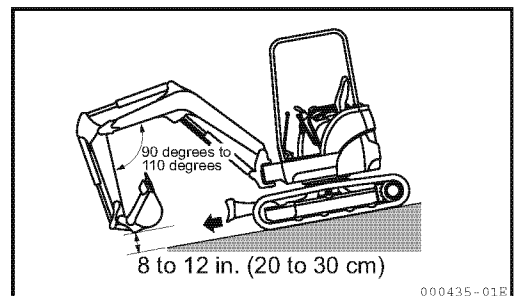
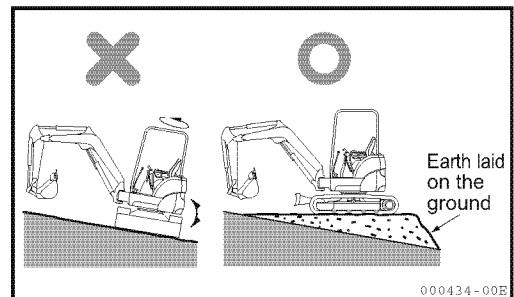
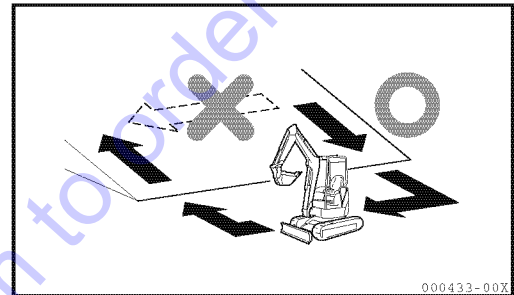

### ■ Braking when going down a slope

When going down a slope, you can automatically brake the machine by setting the travel levers to the neutral position.

### ■ When the tracks are slipping

If you cannot climb a slope by operating the travel levers because the tracks are slipping, retract the arm and make use of the pull-back power of the implement to climb the slope.

### ■ When the engine stops

If the engine stops while climbing a slope, set the travel levers to the neutral position, stop the machine, and restart the engine.

### ■ Precautions for traveling on a slope.

Do not open or close the cabin side door on a slope.

Doing this may cause the door to swing open or closed very rapidly.

Be sure to lock the cabin side door in either the open or closed position.

## 14-12. Escaping from the mud

Carefully operate the machine not to allow it to get mired in mud. If the machine is mired in mud, the machine can escape as follows:

### 14-12-1. If only one track is mired in the mud

If only one track is mired in the mud, place the bucket on the muddy side, lift the track above the ground, lay a log or a wood block under the track shoe, and raise the bucket to escape.

#### IMPORTANT

**When lifting the machine above the ground with the boom or the arm, press on the ground with the bottom of the bucket. (Do not press on the ground with the bucket teeth.)**

**In doing this, the angle between the boom and the arm should be 90 degrees to 110 degrees.**

**The same manner as above should be applied when the bucket is in the reverse position.**

### 14-12-2. If both tracks are mired in the mud

If both tracks are mired in the mud, lay a log or a wood block under the track shoes in the same manner as mentioned above, dig the bucket into the solid ground, retract the arm just as when excavating, and set the travel lever to the "FORWARD" position to escape from the mud.

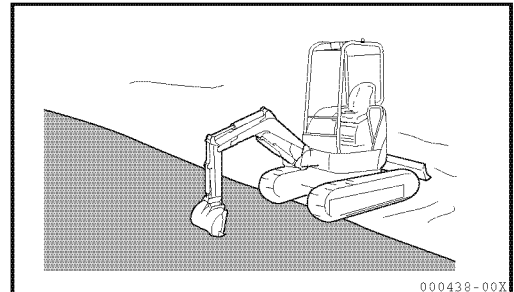
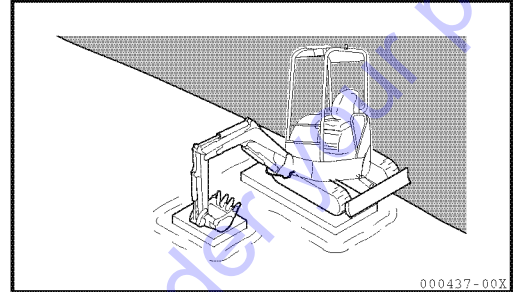

### 14-13. Operations using the bucket

You can greatly widen the range of work described here by using optional attachments.

#### 14-13-1. Backhoe operation

Backhoe operation is suitable for digging the ground below the machine.

Suppose that the machine is operating as illustrated in the right figure : a maximum digging force of each cylinder can be obtained when the angle between the bucket cylinder and the bucket arm as well as between the arm cylinder and the arm is maintained at 90 degrees.

When digging, make good use of this angle to increase the operating efficiency.

To excavate the ground efficiently by manipulating the arm, the arm needs to be operated within a range of angles between 45 degrees forward and 30 degrees backwards, as illustrated in the right figure. Though the range differs according to the depth of the work, do not move the implement to the cylinder stroke end.

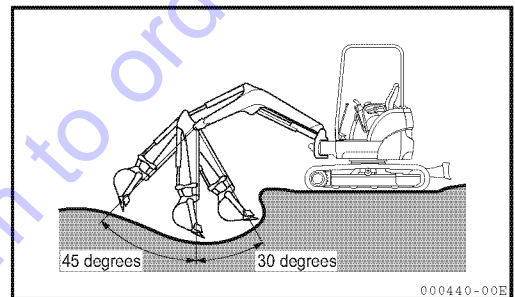
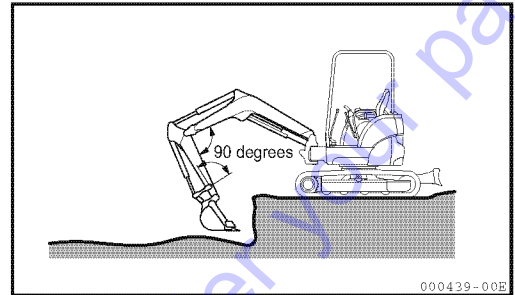

#### 14-13-2. Ditching

To increase work efficiency, install a suitable bucket for ditching and position the tracks in parallel with the ditch to be made.

To make a wide ditch, first dig the two sides, and then dig the center.

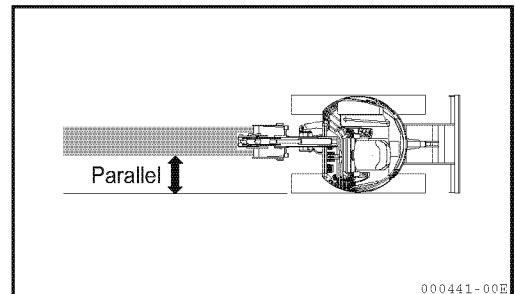

#### 14-13-3. Loading

To increase work efficiency, locate the dump truck at a position where the swing angle of the machine will be minimized and the operator can clearly view the dump truck.

Load earth from the rear of the dump truck, because it can be loaded more easily and in larger amount than from the side.

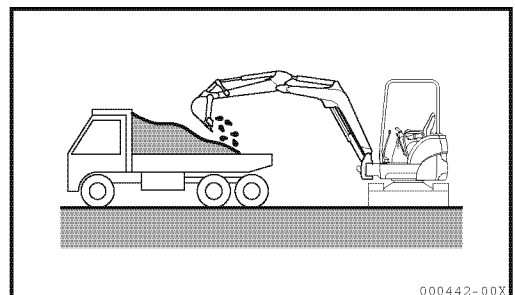

**14-14. Handling quick coupler**

**14-14-1. Features of quick coupler**

The quick coupler is the device to simplify the replacement of a variety of attachments for hydraulic implement. The distance between pins is adjustable so that the attachments with different distances between pins are available.

**14-14-2. Description of switches**

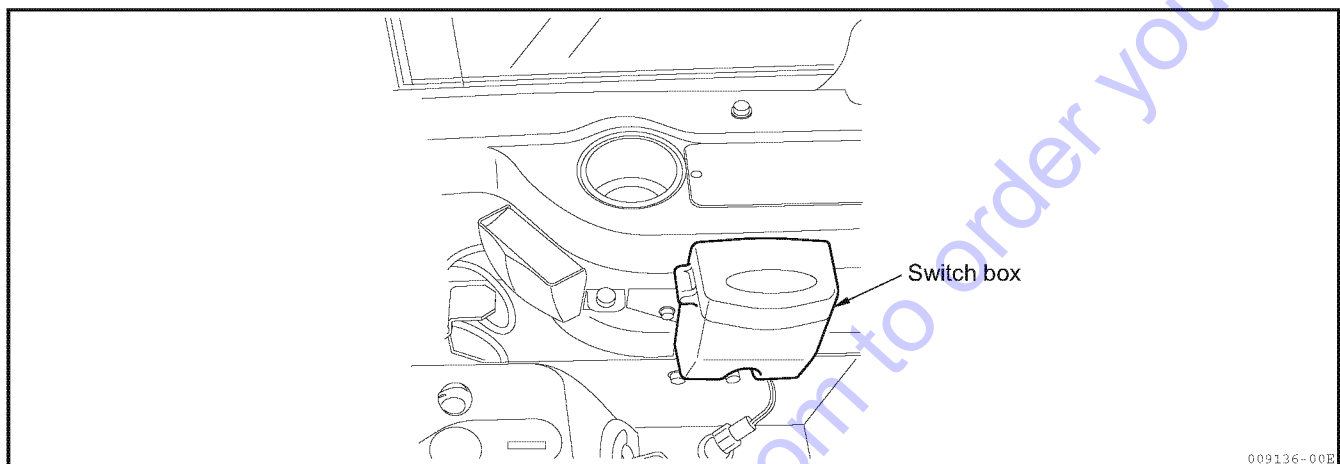

009136-00E

**⚠ WARNING**

Never open the Switch Box cover except when mounting or dismounting the Attachment to prevent accidental activation of the Quick Coupler. This may cause breakdown or sudden operation of the Attachment, causing serious accident.

1) Control switch of quick coupler

Use this switch to dismount or mount the attachment.

| Operating control switch to dismount or mount the attachment  |  |
|---|--|
| Dismounting of attachment   | Mounting of attachment                                   |
| <p>(1) Press (2) Turn to the left</p> <p>Power supply switch goes on, and beeps sound.</p> <p>Lamp goes on.</p> <p>000483-00E</p> | <p>(1) Turn to the right (2) Press</p> <p>000484-00E</p> |

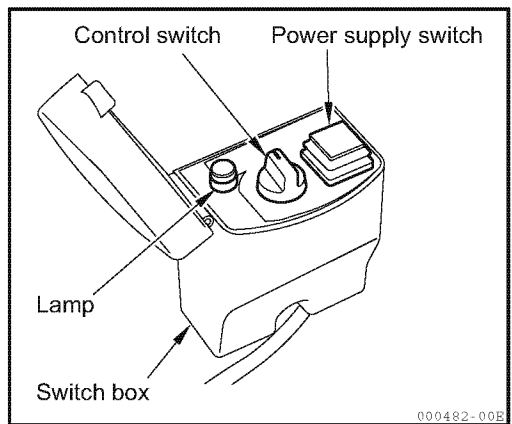

000482-00E

14-14-3. Structure of quick coupler

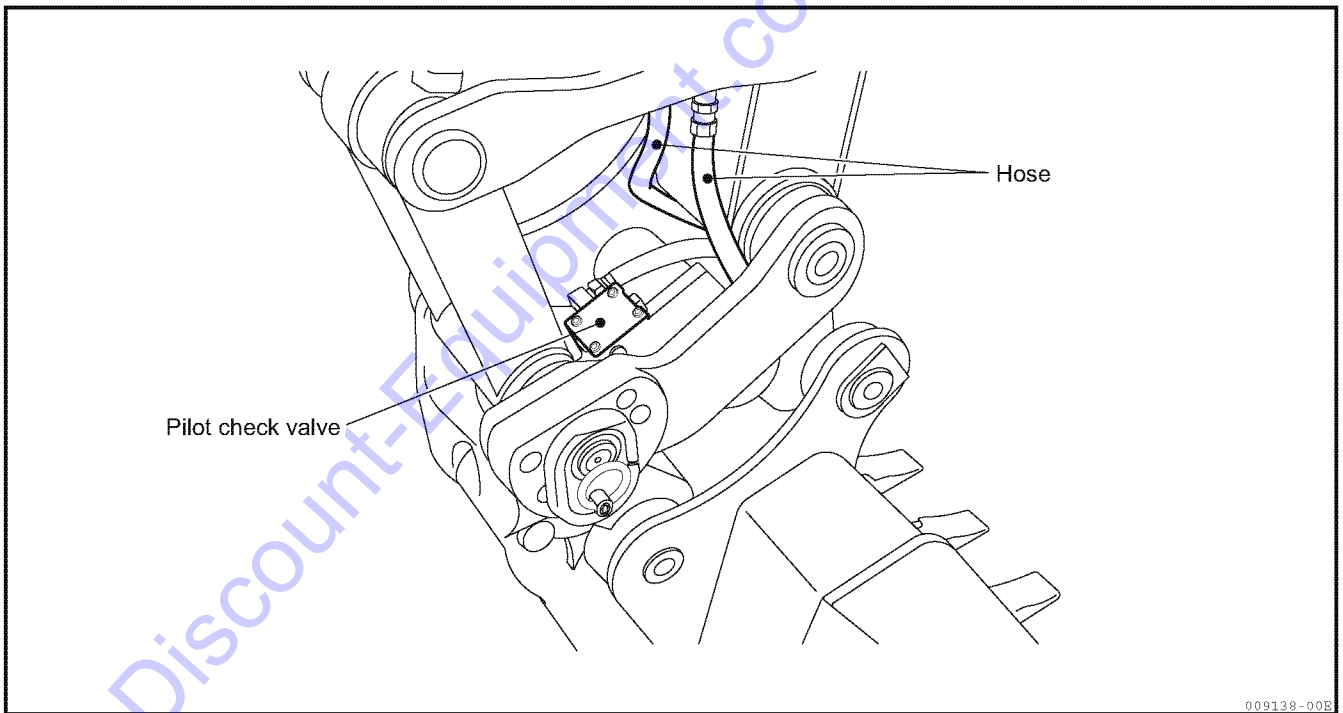
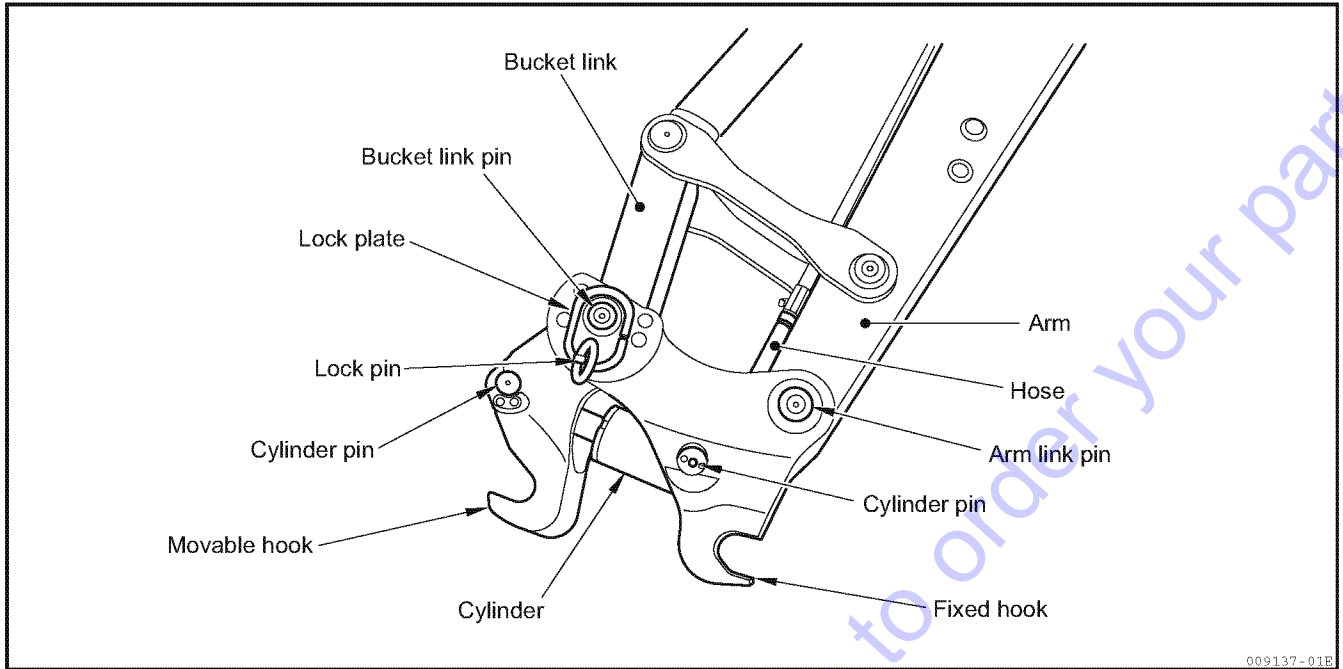

**14-14-4. Attachment types**

- 1) The attachments, which can be mounted on the machine with quick coupler, are only the same 2-pin type as the bucket. The 1-pin type such as clamshell cannot be mounted in the quick coupler.
- 2) The following 2-pin type of attachments exceptionally cannot be mounted in the quick coupler.
  - (1) Attachments much different from the standard bucket in shape of mounting part
  - (2) Attachments with excessively long or short pin pitch
- 3) Do not use any attachments improper for the machine with the quick coupler.

**14-14-5. Allowable size of bucket**

Allowable size of bucket to be mounted in the quick coupler

Unit : in. (mm)

| Mark | Part                       | ViO45-5B / ViO55-5B        |                              |
|------|----------------------------|----------------------------|------------------------------|
| A    | Attachment width           | 5.51 (140) or more         |                              |
| B    | Distance between pins      | Pin diameter<br>Ø1.57 (40) | 7.52 to 11.7<br>(191 to 298) |
|      |                            | Pin diameter<br>Ø1.77 (45) | 7.95 to 12.5<br>(202 to 317) |
| C    | Operating radius of bucket | 34.6 (880) or less         |                              |
| D    | Pin diameter               | Ø1.57 to 1.77 (40 to 45)   |                              |

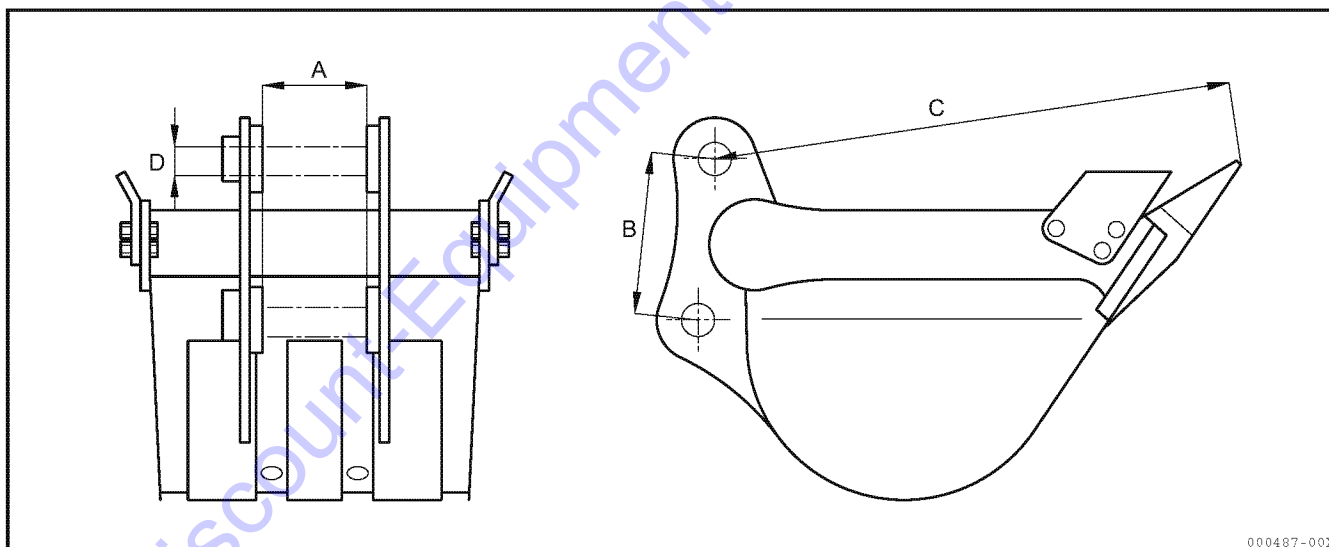

000487-00X

**14-14-6. Phenomena that are not breakdowns**

While setting the control switch of the quick coupler in the dismantling mode, stop the engine and then restart it to open the hook of the quick coupler.

**14-14-7. Posture for storing the machine without attachment**

Place the quick coupler on the ground as illustrated in the right figure for a long-term storage.

If the quick coupler is placed on the ground when the control switch is in the dismantling mode, the hook will open when the engine is restarted, causing the floor surface scratches or the machine breakdown.

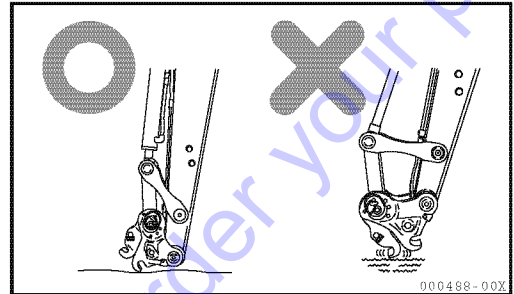



14-14-8. Dismounting attachment

**⚠ WARNING**

- Never dismount the Attachment while it is still elevated, as it will drop to the ground and could cause bodily injury.
- Never dismount the Attachment unless it is resting on stable level ground, as it could otherwise fall over.

1) Park the machine on stable level ground.

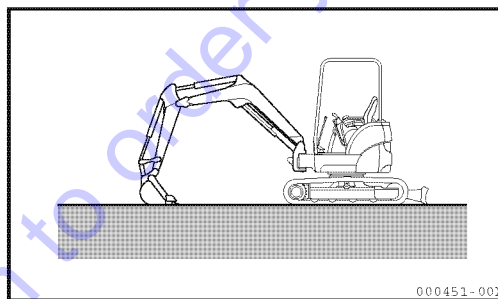

2) Lower the attachment onto the ground.

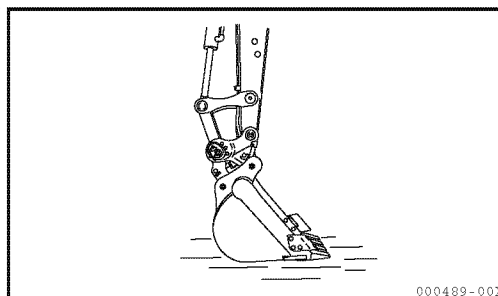

3) Set up the handle of the lock pin.

4) Turn the arrow on the head of the lock pin from the lock position to the unlock position, and then pull it up.

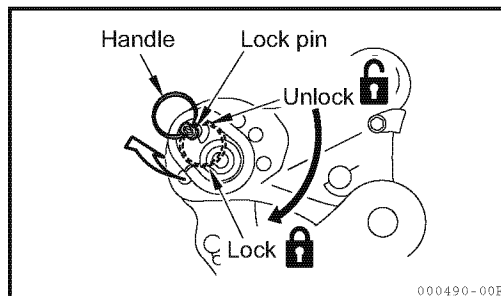

**IMPORTANT**

The lock pin cannot be removed from the body.

## 14. Operating Instructions

5) Open the switch box cover.

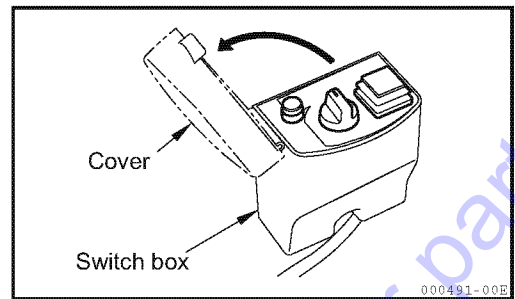

6) Press the power supply switch.

Then, beeps sound and the power supply switch blinks.

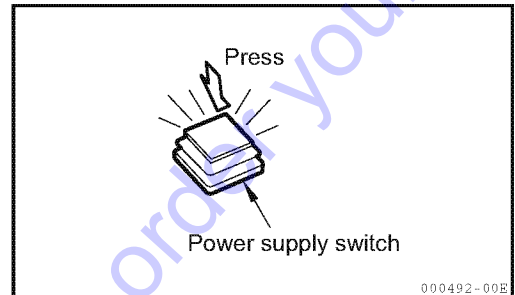

7) Turn the control switch to the dismounting position on the left side, and the attachment is dismounted.

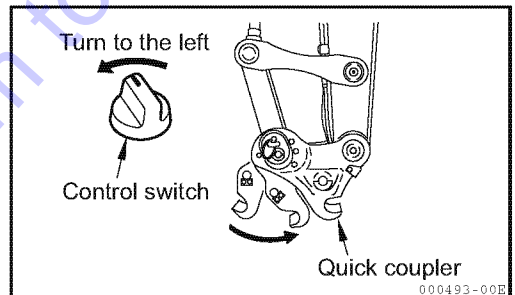

8) Remove the quick coupler from the attachment.

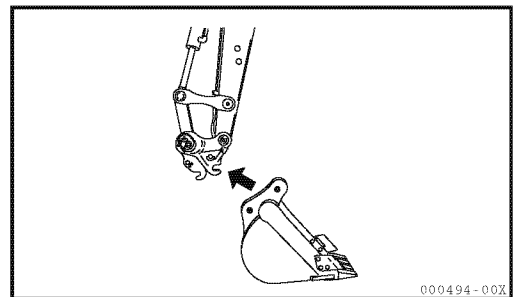

## 14-14-9. Mounting attachment

**⚠ WARNING**

- Never place your hands or any other part of your body between the Quick Coupler and the Attachment to prevent bodily injury.
- Never stand near the Attachment unless it is resting on stable level ground to avoid bodily injury.
- Never use a newly mounted Attachment before confirming that it has been properly secured to the Quick Coupler, and that the Lock Pin has been correctly installed, as accidental detachment could otherwise result.
- Always replace the Lock Pin if damaged or lost. Failure to do so could result in death or serious injury.

- 1) Place the attachment on stable level ground.  
Be sure to install the pins into the attachment.

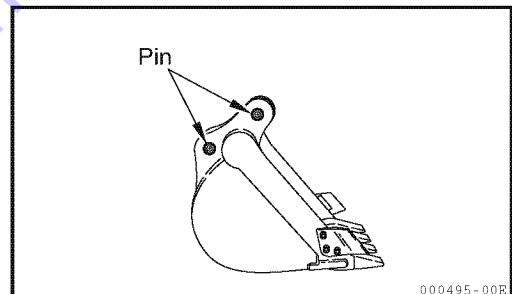

- 2) Close the movable hook.
- 3) Put the fixed hook onto the pin of the attachment on the arm side and set the quick hitch level with the ground as illustrated in the right figure.

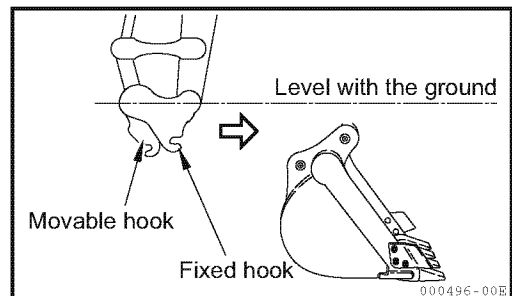

- 4) Lift the attachment up in that state.

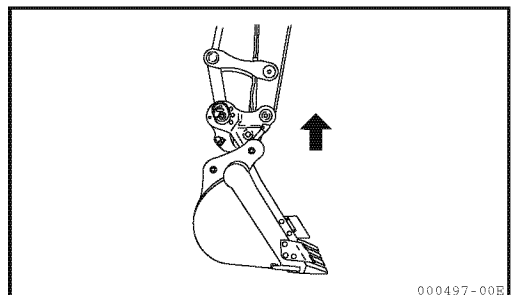

## 14. Operating Instructions

5) Curl the attachment so that it is level.

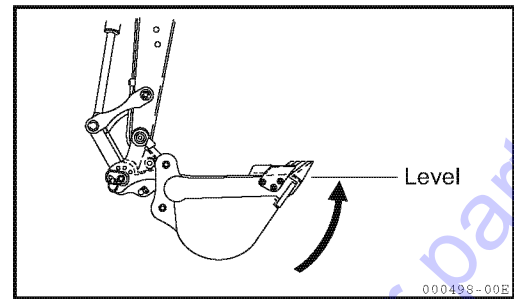

6) Turn the control switch to the mounting position on the right side, and the attachment is mounted.

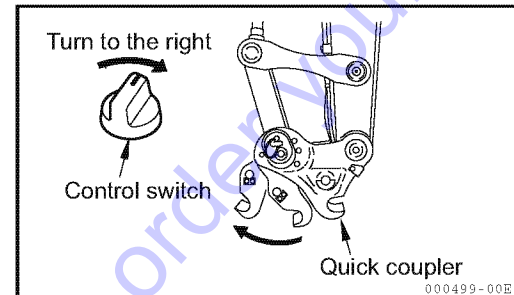

7) Only one of the bores allows the whole lock pin. Install the lock pin to that bore.

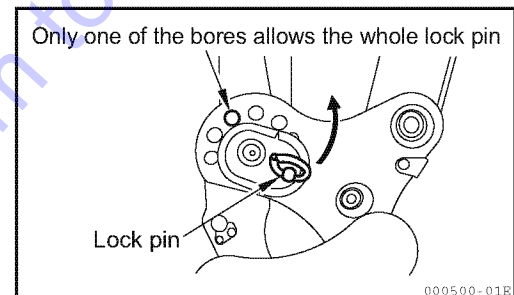

8) Turn the arrow on the lock pin to the lock side.

9) Put the handle of the lock pin down to the arrowed side.

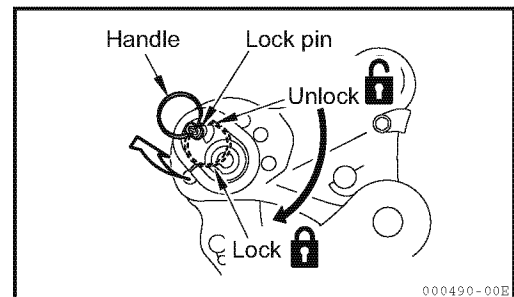

10) Make sure the attachment is securely mounted in the quick coupler before pressing the power supply switch on. The beeps stop sounding and the red lamp goes off.

11) Close the switch box cover.

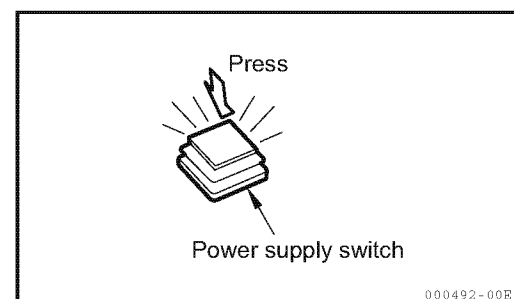

**14-14-10. Maintenance**

1) Checking specifications

- Check there are no cracks and plays.
- Check the bolts and nuts for looseness.
- Check the hydraulic piping for oil leak.

2) Installation instruction of the Lock Pin

- (1) Remove the damaged lock pin if any, and clean the bore of the lock plate.

**Note:**

*Replace the lock plate with a new one if it is damaged.*

- (2) Put a new lock pin into the bore of the lock plate.

- (3) Install the washer and nut onto the lock pin from the back side of the lock plate.

**Note:**

*Apply a lock agent ThreeBond 1324 on the thread.*

- (4) Tighten the nut (M6, Hex 10 mm) to 7.5 to 8.5 ft•lb.

- (5) Confirm if the new lock pin can smoothly move to the lock and unlock positions.

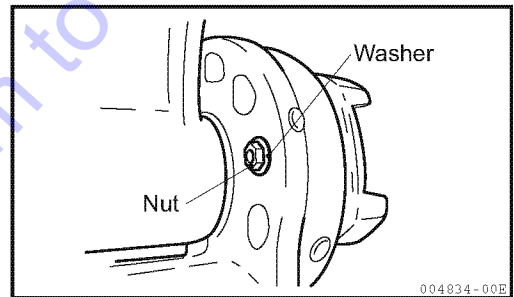
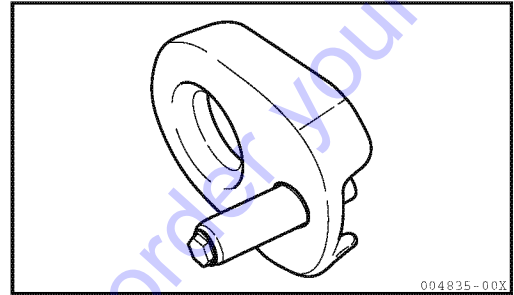

3) Greasing

**IMPORTANT**

**Grease the fittings thoroughly after washing the machine or after operation in rain, on soft ground, or in muddy water.**

- (1) Put the bucket and the blade on the ground and stop the engine.

- (2) Clean the grease nipples indicated with the arrows in the right figures and grease them using a grease gun.

- (3) After greasing, wipe off the excessive grease with waste cloth or the like.

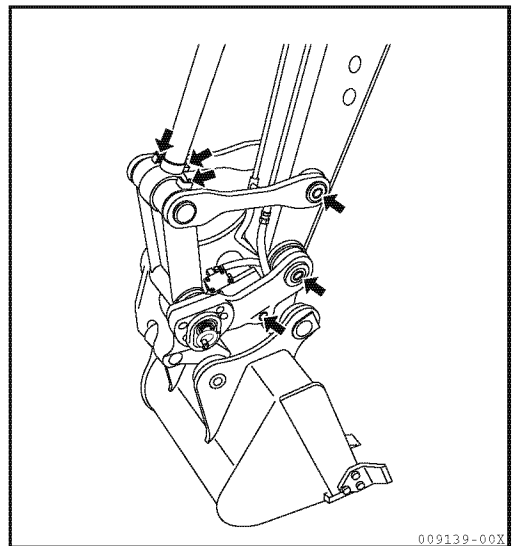

## ***14. Operating Instructions***

---

### 4) Nonperiodic inspection

- The pins in the attachment are free from rotation and cannot be worn.

Apply antirust solvent or grease to them to prevent rust.

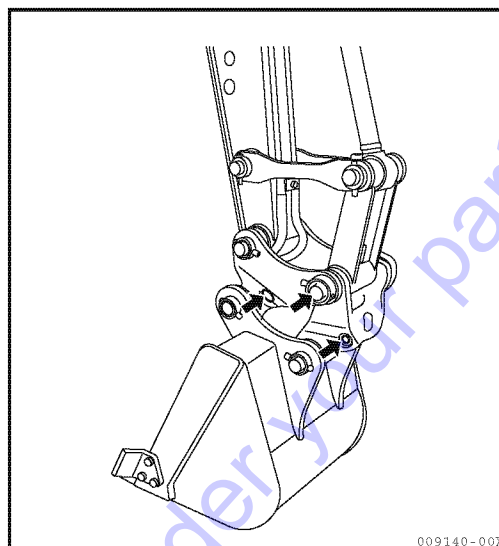

14-15. Parking the machine

**⚠ CAUTION**  
 Do not stop the machine suddenly, but try to stop with a safety margin.

**⚠ WARNING**

- Park on solid, level ground.
- Do not park on a slope. If parking on a slope is unavoidable, block the tracks with solid pieces of wood, place the blade on the ground, and dig the bucket into the ground.

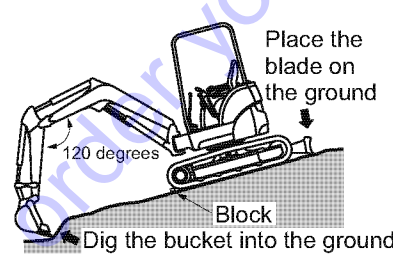

**⚠ WARNING**

- Do not touch the control levers and pedals accidentally. Otherwise, the implement or the machine may move unexpectedly, causing a serious accident.
- When leaving the operator's seat, be sure to place the lock levers securely in the lock position and remove the starter switch key.

1) Set the left and right travel levers (1) or pedals (3) to the neutral position to stop the machine.

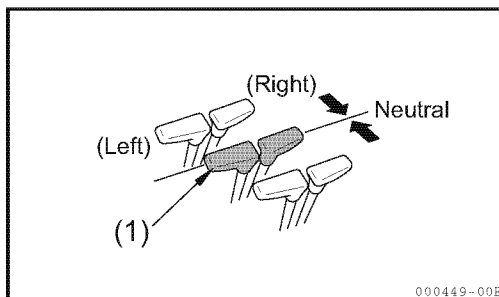
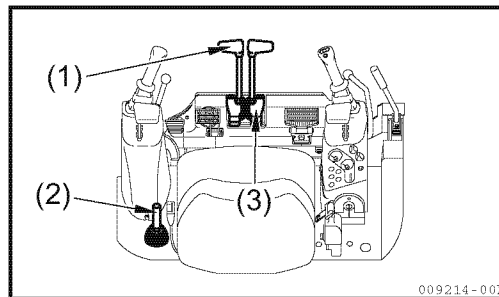

2) Idle the engine with the accelerator lever (2).

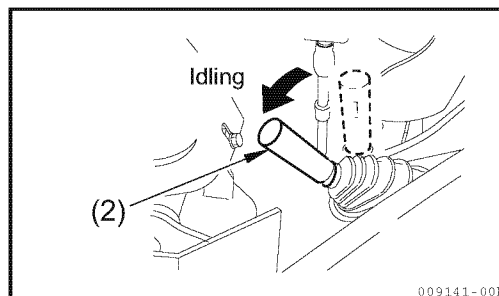

## 14. Operating Instructions

- 3) Place the bucket on the ground with its bottom surface in contact with the ground.
- 4) Place the blade on the ground.
- 5) Set the lock levers to the "LOCK" position.

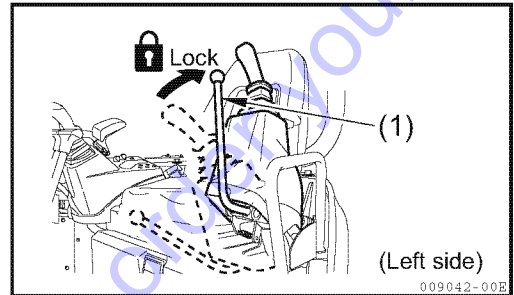
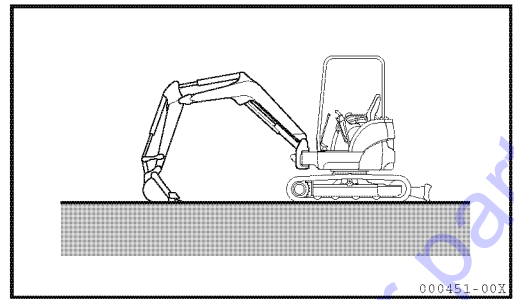

### 14-16. Inspection requirements after completing operation

Check the water temp. meter (1) and the engine oil pressure alarm lamp (2), and also check the residual quantity of fuel with the fuel level gauge (3).

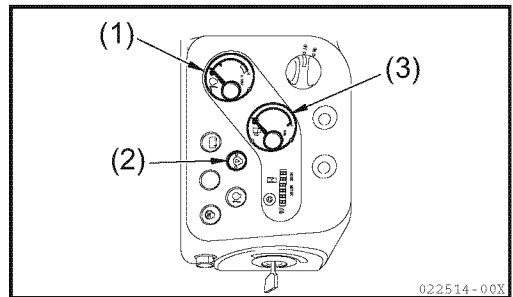



## 14-17. Stopping the engine

### IMPORTANT

- Stopping the engine after rotation at high speed may shorten the engine life. Do not stop the engine suddenly except in case of emergency.
- If the engine is overheated, do not stop the engine immediately. Gradually lower the engine temperature by rotating the engine at medium rotational speed before stopping the engine.

1) Idle the engine for approximately five minutes with no load.

(The engine temperature gradually lowers.)

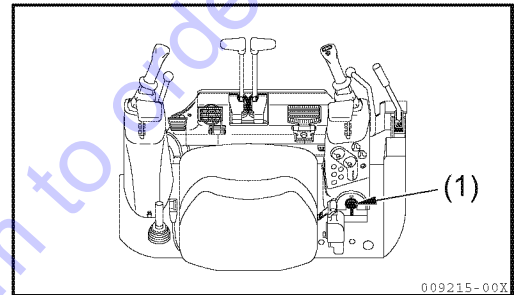

2) To stop the engine, turn the starter switch key (1) to the "OFF" position.

3) Take the key out of the starter switch (1).

### Note :

As long as the starter switch key is in "ON" position and the lock lever(s) is(are) in unlock position, each implement can be moved by its own weight when respective control levers are operated soon after the engine is stopped.

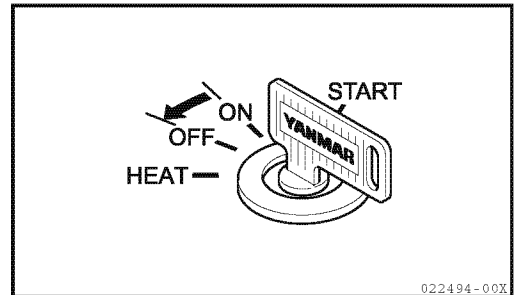

### 14-18. Inspection requirements after stopping the engine

- 1) Check oil and water for leaks, and visually inspect the implement, the machine, and the undercarriage by walking around them.  
If there are any leaks of oil or water, or any observed abnormality, take corrective action.
- 2) Completely fill the fuel oil tank.
- 3) Confirm that the engine room compartment is free of any foreign matter.  
Paper or dust in the engine room may cause fire. Remove them if any.
- 4) Remove mud adhering to the undercarriage of the machine.

### 14-19. Locking

Make sure to lock up the following parts :

(1) Engine hood B

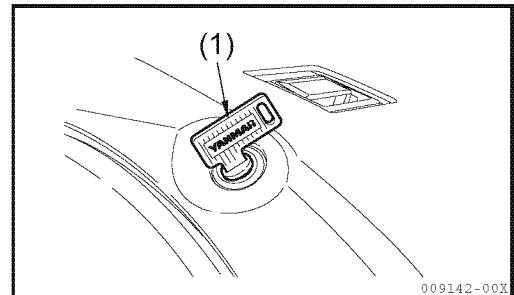

(2) Engine hood rear cover

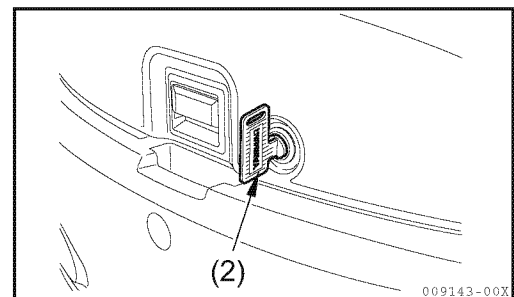

(3) Side door (for cabin)

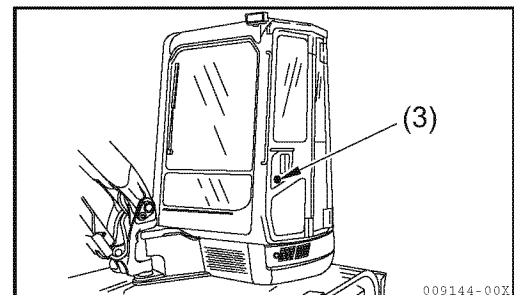

**Note :**

The starter switch key (1) is used to lock all of the parts mentioned above.

## 14-20. Handling the rubber track (for rubber track type)

### 14-20-1. Using the rubber track properly

The rubber track has some advantages over the steel track.

However, you cannot take full advantage of it if you use it in the same manner as for the steel one. Take care in operating with the rubber track according to the conditions of the work site and the type of work.

### Comparison Table of Rubber and Steel Tracks

|                                     | Rubber | Steel |
|-------------------------------------|--------|-------|
| Low vibration                       | ◇      | □     |
| Smooth travel (with no creak)       | ◇      | ○     |
| Silent travel                       | ◇      | □     |
| Less damage to paved roads          | ◇      | □     |
| Simple handling                     | ◇      | □     |
| Susceptibility to damage (strength) | □      | ◇     |
| Tractive force                      | ◇      | ◇     |

◇ : Excellent

○ : Good

□ : Ordinary

Rubber track has many advantages inherent in the unique properties of the material. On the other hand, however, it is low in strength. It is essential that you fully understand the properties of rubber track, and observe the precautions for operating and handling it to prolong its life and get the most out of it. Sure to read Section "14-20-3. Precautions for using the rubber track" before using it.

### 14-20-2. Warranty for rubber track

The rubber track is not warranted for free repair or replacement if it is damaged because of careless misuse by the customer, including the failure to comply with the prohibitions and the instructions for safe operation; for example, failure to check the tension of the rubber track or service the rubber track properly, or "operation of the rubber track on the edge of a steel plate, a U groove, a block or sharp rubbles and rocks, or on reinforcing bars or iron scraps, which could physically damage the rubber track".

### 14-20-3. Precautions for using the rubber track

#### ■ Prohibitions

Observe the following prohibitions:

- Do not operate or swing on sharp stones, a hard, uneven rock base, or around steel rods, scrap iron, or edges of iron plates. Failure to observe these prohibitions may damage the rubber track.
- Do not operate the machine on a stony surface like a riverbed. Doing this may damage the rubber track by catching gravel in the track or may cause the track to come off. Forcibly pushing obstacles with the track slipped will shorten the life of the rubber track.
- Prevent the rubber from getting exposed to oil, fuel, or chemical solvents. If it is exposed, immediately wipe it. Also, do not travel on a road which has an oil pool.
- When storing the rubber track for a long time period (more than three months), avoid placing it in a place subject to direct exposure to sunlight or rain.
- Do not operate the machine on heated places such as in an open-air fire, on a steel plate exposed to the blazing sun, or on a hot asphalt road.
- Never run on one rubber track while the other is held above the ground with the implement. Doing this may damage the rubber track or cause it to come off.

**14-20-4. Other precautions for using the rubber track**

Observe the following precautions when operating the machine:

- Never spin-turn on concrete or asphalt roads.
- Do not change course suddenly. Doing this will cause the rubber track to wear early or be damaged.
- Do not swing on the ground over a large level gap. Remember that running over a level gap at a right angle will prevent the track from coming off.
- Slowly lower the machine after it has been lifted above the ground with the implement.
- It is not recommended that the machine be used to handle any materials that become oily after being crushed (e.g., soybeans, corn, rapeseed oil seeds, etc.). After unavoidably using the machine to handle such materials, fully clean the machine with water.
- It is not recommended that the machine is used to handle materials such as salt, ammonium sulfate, potassium chloride, potassium sulfate, or superbiphosphate of lime. Handling these materials may affect the core metal adversely. After using the machine to handle such materials, fully clean with water.
- Do not operate the machine at the seashore. Doing this may affect the core metal adversely due to the salt content.
- If the rubber track is cracked, it could be easily damaged when handling salt, sugar, wheat, or soybeans. Be sure to repair any cracks in the rubber track to prevent rubber chips from getting into the materials being handled.
- Do not allow the rubber track to rub against a concrete wall.
- The rubber track is prone to slipping on snow or on a frozen road. Be careful of skidding when traveling or operating on a slope in cold weather.
- Operating the machine in extremely cold weather will deteriorate the rubber track, shortening its life.
- Use the rubber track between -13°F to +131°F (-25°C to +55°C) because of the physical characteristics of rubber.
- Be careful not to damage the rubber track with the bucket while operating the machine.

## 14. Operating Instructions

- Keep the track in appropriate tension to prevent it from coming off.  
If the tension is too low, the rubber track may come off under the following conditions.  
Even if the tension is adequate, take care when operating the track.

- Do not steer the machine on a large level gap created by a curbstone or a rock [approximately more than 7.87 in. (20 cm)]. Run over a level gap at a right angle to prevent the track from coming off.

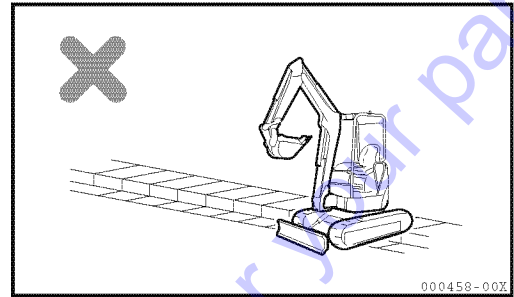

- Do not steer the machine to a boundary between the flat ground and a slope while moving backward. If such steering is not avoidable, slow down the speed.

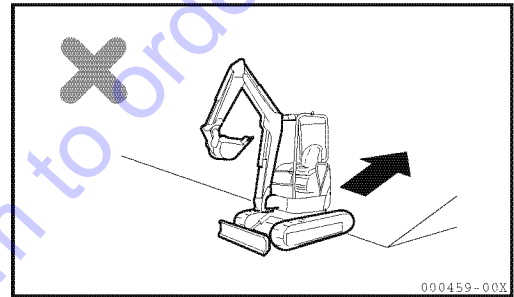

- Do not travel with the track at one end on a slope or on convex ground (at a machine inclination angle of approximately more than 10 degrees), with the track at the other end on flat ground, to prevent the rubber track from being damaged. Be sure to travel with the track at both ends on the same level surface.

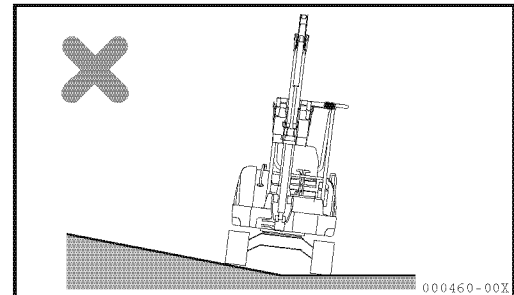

- The three cases illustrated above are those which could cause the rubber track to loosen. In addition, do not steer the machine under such ground conditions as illustrated in the right figure.

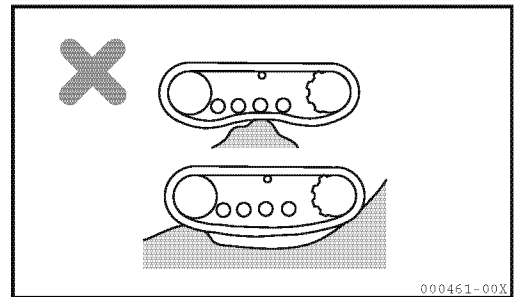

### [How the rubber track comes off]

- 1) When running over a level gap, a clearance is created between the track and the track rollers. At this point, the track tends to come off.

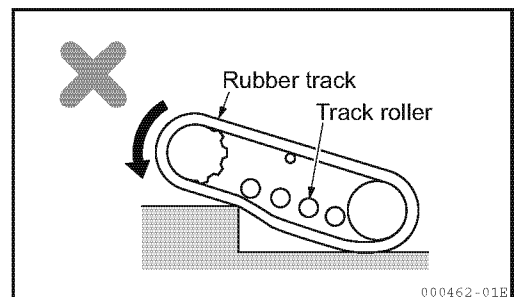

2) If the machine further travels in reverse, clearance may also be created between the track rollers and the idler and, the rubber track, causing the rubber track to easily come off.

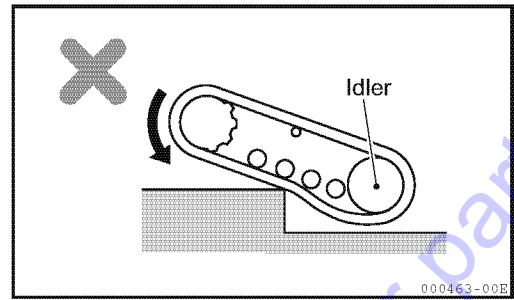

- When the machine is steered while the rubber track is blocked in the transverse direction by an obstacle or the like.

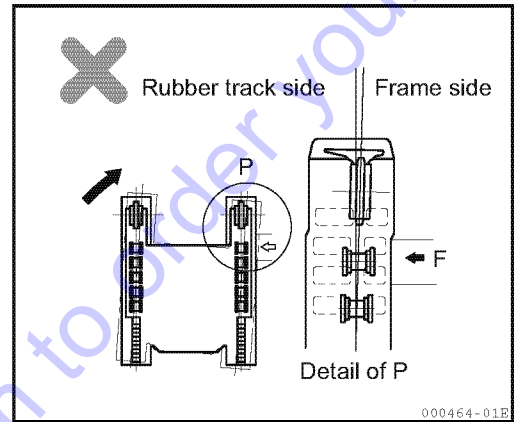

- When the idler and the track rollers are misaligned from the core metal due to rubber track misalignment.

- Traveling in reverse under this condition will cause the rubber track to come off.

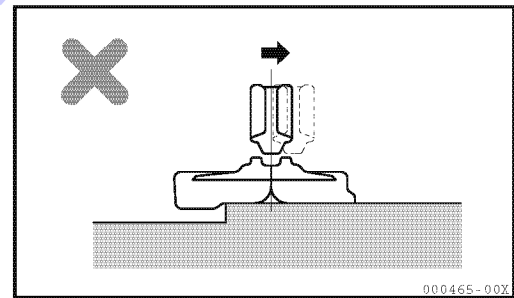

- Steering the machine under this condition will cause the rubber track to come off.

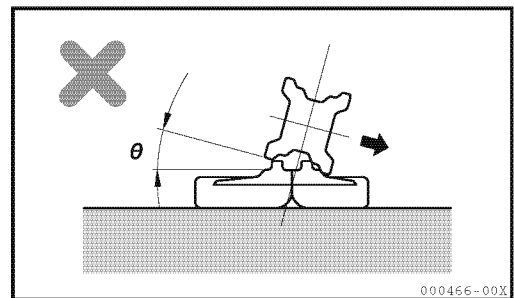

**14-20-5. Checking and servicing the machine with rubber track**

To check and service the machine with rubber track, refer to and follow Section "26-1. Table of service time intervals".

**14-21. Handling hydraulic P.T.O.**

**14-21-1. Description of stop valve, P.T.O. selector valve, P.T.O. pedal and pedal lock**

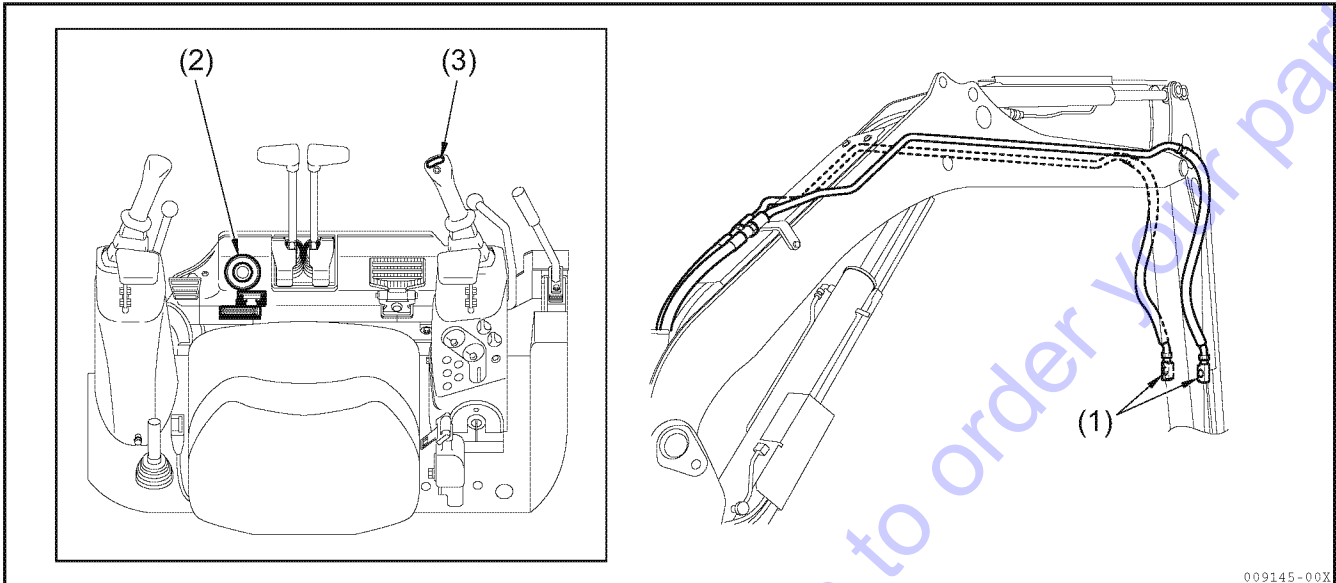

**(1) Stop valve**

This valve can stop the flow of the hydraulic oil.

(A) Open : The hydraulic oil flows

(B) Close: The hydraulic oil stops.

Set this valve at the closed position when removing and installing an attachment.

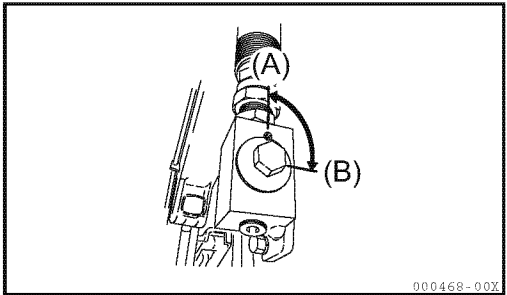

**P.T.O. selector valve**

**(2) Foot switch**

Unfold the foot rest and press the foot switch to operate a single acting attachment.

**(3) Lever switch**

Use the right hand lever switch to control attachments.

- Single acting attachment (hammer)

Operate the lever switch to the left side only (or operate the foot switch).

- Double acting attachment (tilt bucket, auger, etc.)

Operate the lever switch to right and left sides.

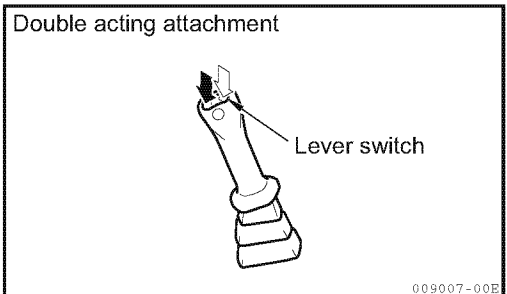
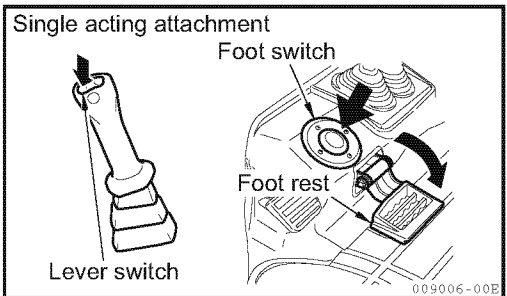



### 14-21-2. Hydraulic circuit

- 1) When mounting any attachment, follow the procedure below to connect the circuit.
  - (1) Make sure the stop valves are in the closed position and remove the screw plugs. Take care not to loose or damage the removed parts.
  - (2) Install the connectors supplied by the manufacturer of the attachment and connect the hoses.

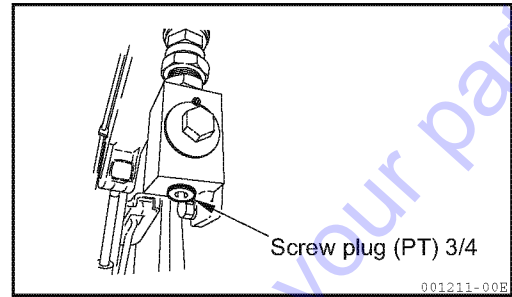

### ■ Oil flow system

The directions of lever switch operation and the oil flow system are described in the figure below.

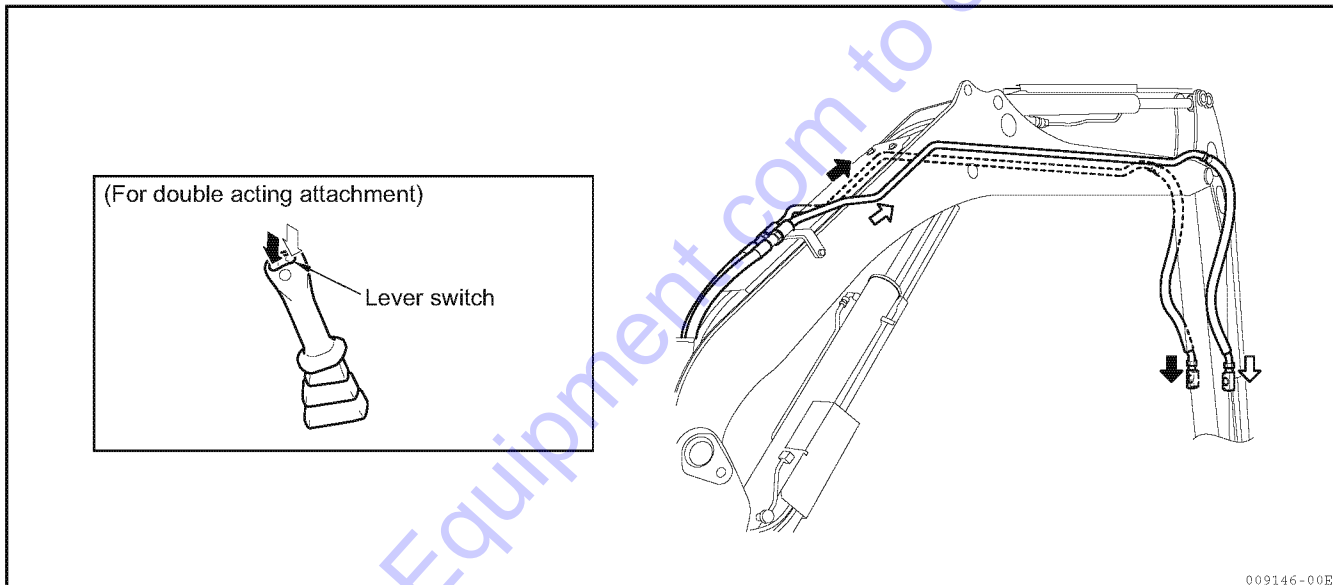

- 2) Before disconnecting the hydraulic piping to remove an attachment, relieve the hydraulic oil pressure in the circuit according to the following procedure.
  - (1) Stop the engine.
  - (2) Turn the starter key to "ON" position.
  - (3) Push the lock lever forward to set it in unlock position.
  - (4) Alternatively press the right and left sides of the lever switch several times.

14-21-3. Operating attachment

**⚠ WARNING**

**When changing the hydraulic piping connection, stop the engine and slowly loosen the connection to release the inner pressure.**

If you use the oil pressure for other hydraulic devices as the power source, connect the piping by using the following procedure after the engine has stopped.

- 1) Close the stop valve.
- 2) Remove the screw plugs.
- 3) Connect the hose for the hydraulic tool.
- 4) Open the stop valve.

Operate the attachment as follows:

**■ Precautions**

- Make sure the stop valves are in the open position.  
Refer to Section "14-21-2. Hydraulic circuit" for oil flow system.

- 1) When using the breaker (single acting attachment)

Set the return line selector valve inside of the cover to the single acting attachment position.

The breaker works when the lever switch or foot switch is operated.

- Make proper use of the breaker following the handling instructions in the operation manual provided by the manufacturer of the breaker.

- 2) When using general attachments such as tilt bucket

Set the return line selector valve to the double acting attachment position.

Move the lever switch to operate the attachment.

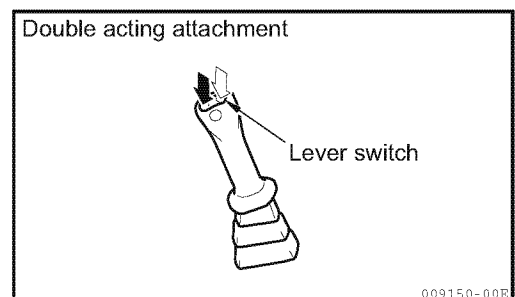
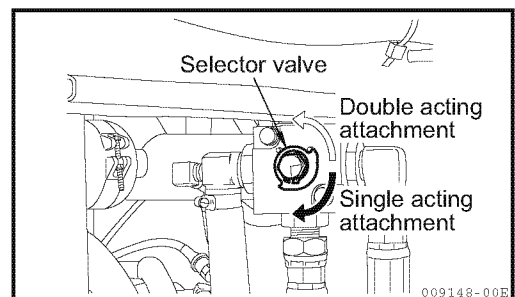
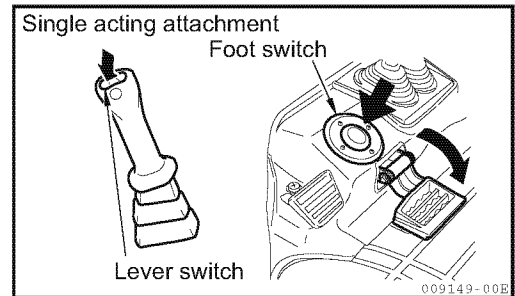
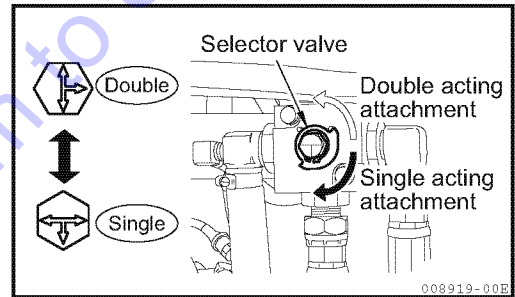
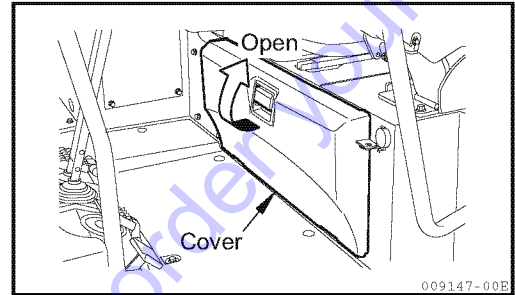
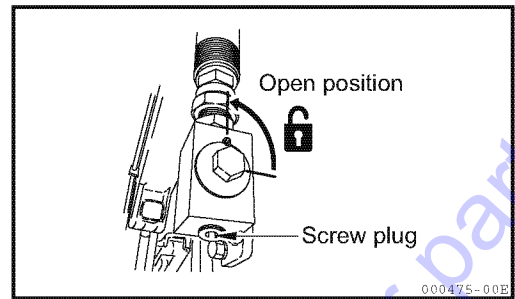

■ Precautions

- Make proper use of the general attachments following the handling instructions in the operation manual provided by the manufacturer of the general attachments.

**14-21-4. Long-term storage**

If the hydraulic tool is not used, do the followings:

- Close the stop valves.
- Disconnect the hoses for the hydraulic tool. Wind the screw plug R (PT) 3/4 with seal tape and tighten them to the stop valve.

**⚠ CAUTION**

Operating the P.T.O. switches when the breaker or general attachment is not mounted may cause overheating.

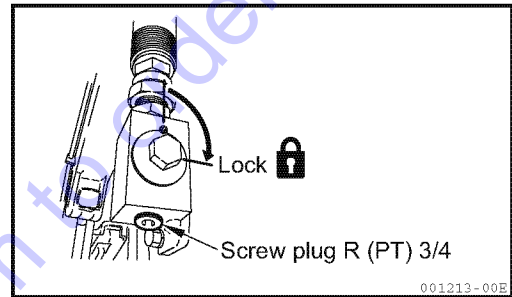

**14-21-5. Specification**

Hydraulic oil pressure specification

- Oil flow rate  
ViO45-5B : 21.1 GPM (80 L / min)  
ViO55-5B : 21.1 GPM (80 L / min)

14-22. Replacing the bucket without the quick coupler

**⚠ WARNING**

- When driving pins into the bucket with a hammer, metal chips may fly. If metal chips should get into your eyes, they can cause serious injury. Use goggles, a hard hat, and gloves for safety when replacing the bucket.
- After removing the bucket, place it on solid ground in a stable position.
- When aligning the holes for pin A and pin B, be careful not to insert your fingers into those holes to prevent serious injury to your fingers. Visually check the alignment of the holes.

Work on level ground with good footing. If two or more persons work together, communicate with signals selected beforehand for safety.

■ Replacement procedure

Replace the bucket according to the following procedure:

- 1) Park the machine on level, flat ground, and lower the bucket onto the ground.
- 2) Stop the engine.
- 3) Clean around the bucket pin to prevent foreign material from entering the pin holes.
- 4) Remove pins A and B.

**IMPORTANT**

- Keep the pins away from dirt or mud.
- The machines have dust seals on either end of the bushing. Be careful not to damage them.

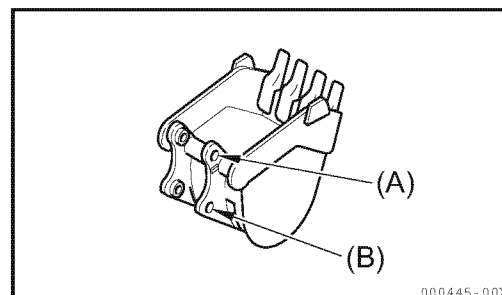
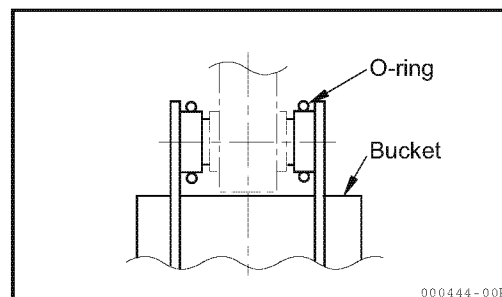
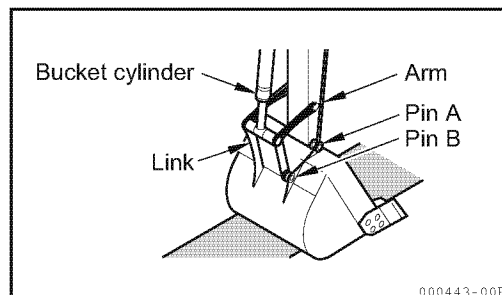

5) Clean the bucket boss section and install the O-ring.

**IMPORTANT**

- Check that the O-ring is not damaged. If it is damaged, replace it.
- We recommend that you replace the O-ring when you replace the bucket.

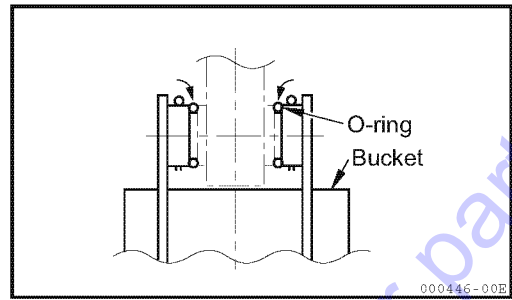

6) Connect the arm to hole (A), and then connect the link to hole (B).

7) Install the O-ring in position.

**IMPORTANT**

**Before mounting the bucket, clean the arm pin hole and grease it.**

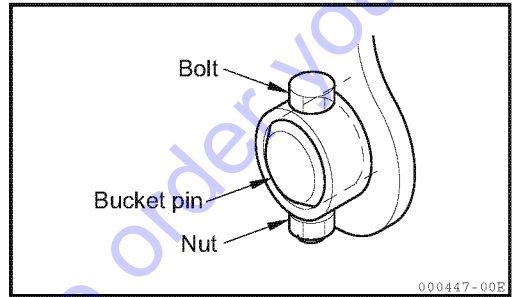

8) Install the bolt into the bucket pins A and B.

9) Grease the connecting parts.

## 15. Transportation

### 15-1. Loading and unloading the machine

For safety in transporting the machine, comply with all applicable regulations and laws.

#### **WARNING**

- **Be careful when loading and unloading the machine, because it is a job of high hazard potential.**
- **Load or unload the machine on level, solid ground far away from the shoulder of the road.**
- **Load or unload the machine at a low engine speed.**
- **Use ramp plates of adequate strength having hooks. Check to see that the ramp plates are wide, long, and thick enough to safely sustain the machine so that you can load or unload safely. To prevent the ramp plates from bending too much, support them with blocks.**
- **Securely hook the ramp plates to the deck of the truck so that they will not come off.**
- **Remove mud, grease, and other slippery deposits from the track shoes, and grease, oil, and ice deposits from the ramp plates to prevent the machine from skidding.**
- **Never change the travel direction on the ramp plates. If you need to change the travel direction, go back down on the ramp plates, then do this.**
- **Swing slowly on the truck bed if necessary since the foothold is unstable.**
- **Make sure that the side door of the cabin is locked, whether in the open or closed position. Never open or close the side door on the ramp plates, to prevent it from swinging violently.**

To load or unload the machine, be sure to use the ramp plates and follow the procedure below:

- 1) Firmly brake the truck and apply wheel stoppers to the tires. Securely install the ramp plates on the bed of the truck in a position where the center of the truck aligns with the center of the machine. Make sure that the left and right ramp plates are at the same level.

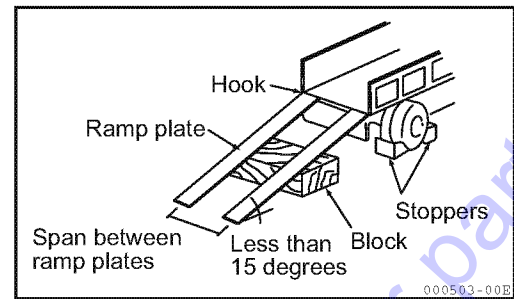

The ramp plates should be set at an angle of less than 15 degrees.

Determine the span between the ramp plates on the basis of the centers of the track shoes.

Do not operate the high-speed pedal.

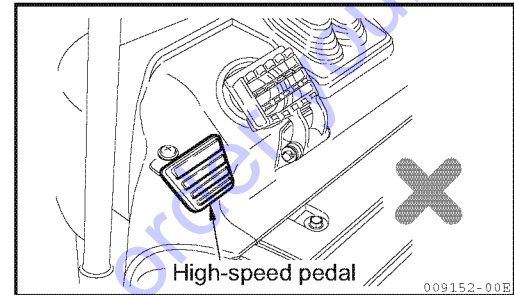

- 2) Return the accelerator lever to reduce engine speed.
- 3) Travel toward the ramp plates at a low speed, and load or unload the machine with the implement lowered as close as possible to the deck of the truck. Do not operate any levers other than the travel levers while driving on the ramp plates.

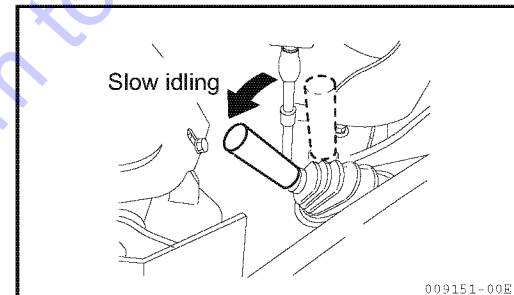

- 4) Load the machine in a safe position on the truck.

15-2. Precautions for loading the machine

**⚠ WARNING**

**Load or unload the machine on level, solid ground far away from the shoulder of the road.**

After loading the machine in a safe position on the truck, secure the machine as follows:

- 1) Place the blade down on the ground.
- 2) Extend the bucket and arm cylinders to the maximum limit, and slowly lower the boom down on a block of wood.
- 3) Stop the engine to take the key out of the starter switch. (The brake works to lock the swing motor.)
- 4) Be sure to lock the control levers with the lock levers.
- 5) Provide wood blocks in the front and back of the track and hook the shackles to the machine's hook bores, and secure the machine with a chain or a wire rope so that the machine will not move during shipping. In particular, be sure to secure it to prevent skidding.

**IMPORTANT**

To protect the bucket cylinder from being damaged during shipping, place a wooden block under one end of the bucket to prevent it from directly touching the deck of the truck.

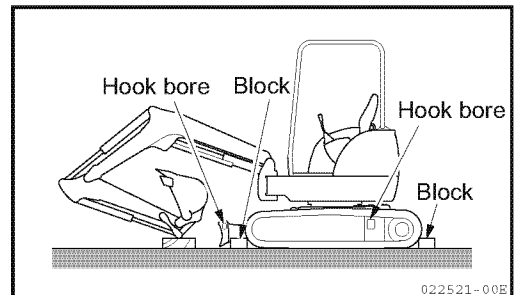
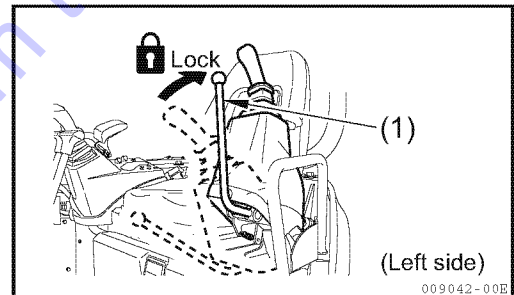
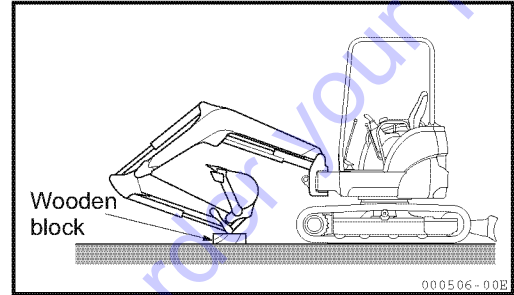



15-3. Precautions for transporting the machine

**⚠ WARNING**

- Select a route for transporting the machine based on the road width and clearance, and the height and weight of the machine.
- Make sure that the side door of the cabin is closed and locked before shipping.

For safer transportation, comply with all local regulations and laws.

Go to [Discount-Equipment.com](http://Discount-Equipment.com) to order your parts

**15-4. Suspending the machine**

**⚠ WARNING**

- Never suspend the machine if any person is on the machine or the implement.
- Use wire ropes strong enough for the weight of the machine.
- Do not suspend the machine in any way other than that explained on the following page.  
Failure to suspend the machine as prescribed will throw the machine off balance.
- Do not swing the machine being suspended.
- When suspending the machine, keep the machine in balance taking care on the center of gravity of the machine.
- Never stand near or under the suspended machine.

For safety in suspending the machine, comply with all applicable regulations.

Suspend the machine on the level ground as follows:

- 1) Swing the upperstructure so that the blade is behind the operator's seat.
- 2) Raise the blade to the highest limit.
- 3) Extend the hydraulic cylinders of the front implement (except for the swing cylinder) to the maximum.
- 4) Stop the engine, and make sure that nothing is left around the operator's seat before leaving the machine.
- 5) Fit the shackles to the suspending hooks on the front side (one point) and the rear side (two points), and securely fasten a sling belt (or a wire rope) to the shackles.
- 6) Suspend the machine above the ground, wait until the machine is stable and then suspend it slowly.

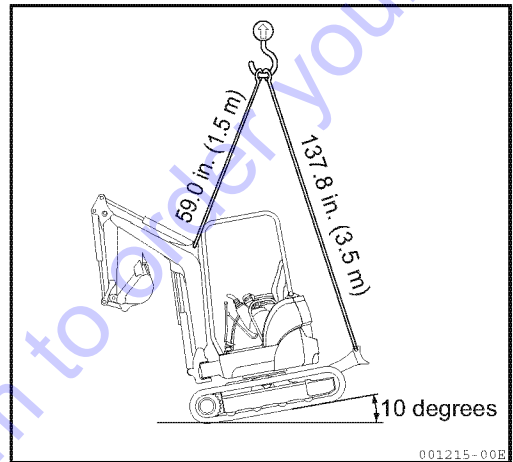
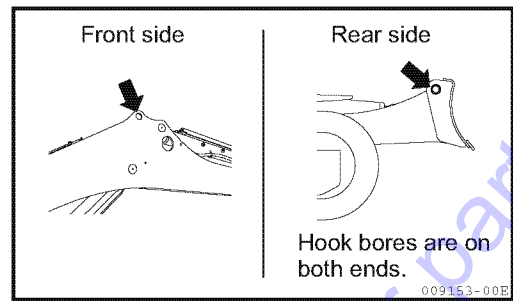

Approximate shipping weight:

lbs. (kg)

| Items         |        |              | ViO45-5B        | ViO55-5B        |
|---------------|--------|--------------|-----------------|-----------------|
| Quick coupler | Canopy | Steel track  | 10406<br>(4720) | 11574<br>(5250) |
|               |        | Rubber track | 10274<br>(4660) | 11530<br>(5230) |
|               | Cabin  | Steel track  | 10692<br>(4850) | 11861<br>(5380) |
|               |        | Rubber track | 10560<br>(4790) | 11817<br>(5360) |

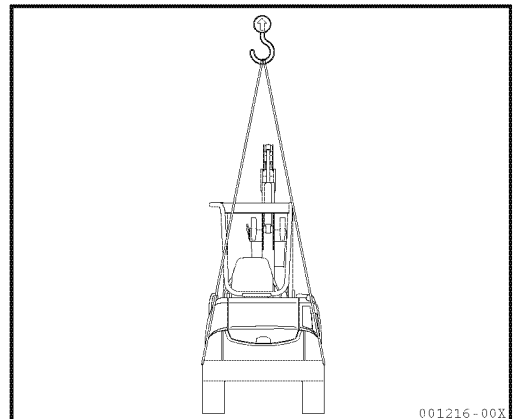

## 16. Care and Service in Cold Weather

### 16-1. Preparing for cold weather

In cold weather, you may have difficulty in starting the engine or the cooling water may freeze. So take measures as follows:

#### 16-1-1. Fuel and lube oil

Use low viscosity fuel and lube oil. For the specified viscosities, refer to Section "23. Fueling, Oiling and Greasing Based on Temperature Range".

#### 16-1-2. Cooling water

### WARNING

**Anti-freeze is flammable. When handling anti-freeze, keep away from any sources of ignition and do not smoke.**

#### IMPORTANT

**Never use an anti-freeze containing methanol, ethanol, or propanol.**

For the timing of cooling water change and the mixing ratio of the anti-freeze, refer to Section "27-2. Nonperiodic services".

#### **Note :**

*Because a YANMAR genuine long-life coolant (LLC) is added to the cooling water, you need not change it unless the temperature below  $-31^{\circ}\text{F}$  ( $-35^{\circ}\text{C}$ ).*

*If the temperature falls below  $-31^{\circ}\text{F}$  ( $-35^{\circ}\text{C}$ ), refer to Section "27-2. Nonperiodic services" to control the density of the cooling water.*

## 16-1-3. Battery

**⚠ WARNING**

- The battery generates flammable gas and it can cause a fire and an explosion. Keep sparks or flames away from the battery.
- Battery electrolyte contains dilute sulfuric acid which is a strong acid. To avoid serious injury, do not allow the electrolyte to contact skin or splash into eyes. If the electrolyte contacts your skin or gets in your eyes, flush immediately with large amounts of water, and obtain medical treatment at once.

Battery performance deteriorates as the temperature goes down. When the battery voltage is low, battery electrolyte will easily freeze. Keep the charging rate close to 100% (full charging) and keep the battery warm for easy start the next day.

**Note :**

Measure the specific gravity of the electrolyte to determine the charge ratio using the conversion table given below.

| Electrolyte temperature \ Charging rate | Electrolyte temperature |               |                 |                 |
|---|-------------------------|---------------|-----------------|-----------------|
|   | 68°F<br>(20°C)          | 32°F<br>(0°C) | 14°F<br>(-10°C) | -4°F<br>(-20°C) |
| 100%                                    | 1.28                    | 1.29          | 1.30            | 1.31            |
| 90%                                     | 1.26                    | 1.27          | 1.28            | 1.29            |
| 80%                                     | 1.24                    | 1.25          | 1.26            | 1.27            |
| 75%                                     | 1.23                    | 1.24          | 1.25            | 1.26            |

The specific gravity of the electrolyte varies with its temperature and recharged condition.

**16-1-4. Preparing heater**

Use the heater in cold weather, if equipped.

- 1) To use the heater, turn the handle (1) on the thermostat case of the engine section counterclockwise to open the valve.
- 2) Operate the heater switch in the cabin/canopy and send warm air into the operator's cabin/canopy.

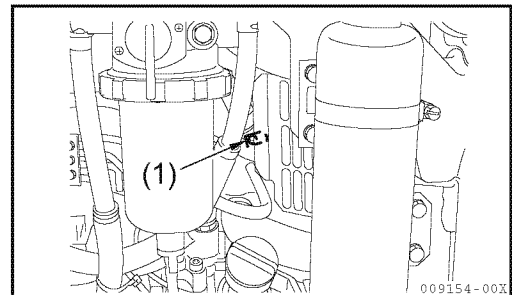

- When you do not use the heater for a long time during the off season, turn the handle (1) clockwise to close the valve.

### **16-2. Precautions after a day's work**

To prevent the machine from getting stuck in the morning due to the mud or water and frozen deposits on the undercarriage, be sure to observe the following precautions.

- Remove mud or water adhering to the machine. If mud or water droplets adhering to the hydraulic cylinder rods get into the seals, the seals could be damaged. So do this to prevent it.
- Park the machine on solid, dry ground.  
If no solid, dry ground is available, lay plates on the ground and park the machine on the plates to prevent the frozen tracks from sticking to the ground.
- Drain the water accumulated in the fuel system by turning on the drain plug to prevent freezing.
- As battery performance is deteriorated in low temperatures, cover the battery or move it to a warm place, and reinstall it in the machine on the next morning.  
If the level of the battery electrolyte is low, add distilled water before starting operation on the next morning. To prevent the battery from freezing at night, do not add distilled water after completing operation.

### **16-3. After cold weather ends**

When the temperature rises, do the following:

- Replace the lube oil and fuel with the specified viscosities according to Section "23. Fueling, Oiling and Greasing Based on Temperature Range".
- If you have added an AF-PT anti-freeze (for one winter season only), fully drain the cooling system, flush the inside of the cooling system well, and fill the cooling water tank with tap water.

## 17. Long-term Storage

### 17-1. Before storing

#### IMPORTANT

**When storing the machine, set up the machine as illustrated in the right figure to protect the hydraulic cylinder rods from being corroded.**

When storing the machine for a long period, do the following:

- Clean all parts and store the machine indoors. If you have to store the machine outdoors, park the machine on level ground and cover it with a protective sheet.
- Apply lube oil and grease to the machine and replace the engine oil.
- Apply a little amount of antirust to exposed parts of the hydraulic cylinder rods.
- Fill the battery with distilled water up to the upper level mark. After the battery has fully recharged, disconnect the negative terminal, and cover the battery or remove the battery from the machine to store it.
- Add an anti-freeze to the cooling water if the air temperature can fall below 32°F (0°C).

Because a YANMAR genuine long-life coolant (LLC) is added to the cooling water, you need not change it until the temperature falls down to -31°F (-35°C).

If the temperature falls below -31°F (-35°C), refer to Section "27-2. Nonperiodic services" to control the density of the cooling water.

- Lock the control levers and pedals with the lock levers and pedal guards respectively.
- Antirust

When stored near the sea or in a place exposed to sea breezes, the machine easily becomes rusty. Carefully apply an antirust to all exposed parts of the piston rods and cover the machine with a polyethylene sheet or oil paper.

| Recommended antirust                         | Manufacturer |
|--|--------------|
| P-1300 (Solvent cutback rust preventive oil) | Nippon Oil   |
| P-3 (Solvent cutback rust preventive oil)    | Japan Energy |
| P-300 (Solvent cutback rust preventive oil)  | Cosmo Oil    |

Some antirust solvent damages rubber materials. Be sure to use the recommended antirust or its equivalent.

- To prevent condensation inside the fuel tank, either drain off the fuel tank or fill the tank.

Retract the bucket and arm cylinders to place the bucket on the ground.

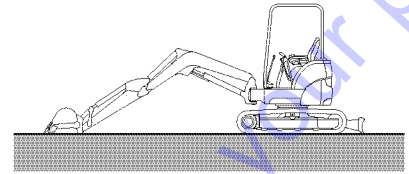

000512-00E

## 17-2. Storing

### **WARNING**

**When you have to operate the machine indoors for the antirust procedure, be sure to ventilate the area well by opening windows and doors to prevent asphyxiation.**

Move the machine at least once a month to form new oil films on all the moving parts during long-term storage, and recharge the battery at the same time.

## 17-3. Using the machine again

### **IMPORTANT**

**When reusing a machine stored for a long time without antirust treatment once a month, consult your dealer.**

To use the machine again after a long period of storage, follow the procedure below:

- Wipe antirust off the hydraulic cylinder rod.
- Apply a generous amount of grease or oil on the moving part.
- Drain water from the fuel tank, the engine oil pan and the hydraulic oil tank by removing the drain plugs.
- After starting the engine, warm-up the machine.



## 18. Troubleshooting

### 18-1. Phenomena that are not breakdowns

The following phenomena are not breakdowns:

- Shaking of the bucket  
When the boom is raised immediately after extending the arm while curling the bucket, the bucket may shake. This phenomenon is not a breakdown.
- Discontinuous arm movement  
When digging the ground with the arm, the arm may slow down at the almost vertical position momentarily. This phenomenon is not a breakdown. Especially, this phenomenon will occur when the engine speed is low.
- Shift in upperstructure position  
When turning the machine sharply such as spin-turning or pivot-turning, the upperstructure may be slightly shifted. This phenomenon is not a breakdown.
- Thermal shock of the travel motor  
If, in cold weather, the temperature of the hydraulic oil is raised 140°F (60°C) higher than the outside temperature by relief operation without traveling after the engine has started, sometimes the machine cannot pivot-turn because of thermal shock. This phenomenon is not a breakdown.
- The swing cylinder is extended when digging  
The swing cylinder may be extended in some digging situations or postures. This phenomenon is not a breakdown.
- Time lag in travel speed change response  
At low engine speed, a time lag in response may occur when the travel speed is changed from high-speed to low-speed. This phenomenon is not a breakdown.

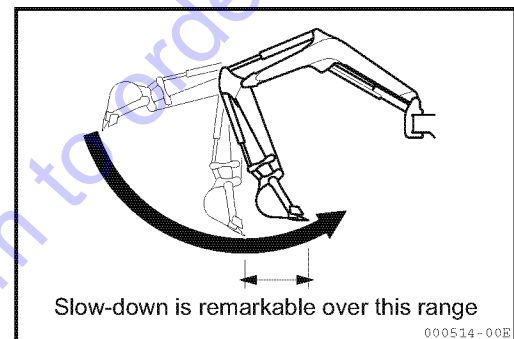
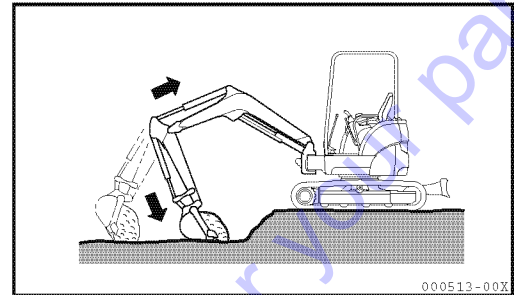

18-2. Towing

**⚠ WARNING**

Always safely tow a disabled machine by using the proper equipment and procedures. The use of incorrect methods or improper procedures could result in bodily injury. Follow the recommendations below to properly perform the towing procedure.

If the machine becomes mired in the muddy ground and cannot come out by itself, or when it is necessary to tow a heavy object with the machine tractive force, tie the sling belt as illustrated on the right.

**IMPORTANT**

- Check to see that the wire ropes, sling belts, and shackles to be used are of sufficient strength and are free from cracks and damage. Never tow the machine with the wire rope attached only to the hook.
- The hook is only intended for stabilizing the machine during shipping.

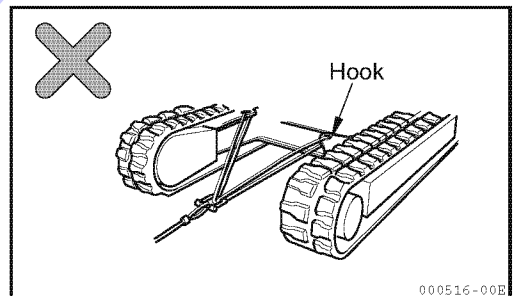
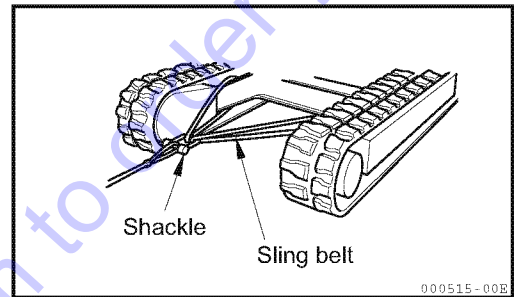

## 18-3. If the battery is overdischarged

**⚠ WARNING**

- Stop the engine and turn the starter switch key to the "OFF" position before checking or servicing the battery.
- Flammable hydrogen gas is produced by the battery, which may cause ignition. Keep flames, sparks and lit cigarettes away from the battery.
- The battery electrolyte contains dilute sulfuric acid, which is a strong acid.

If the battery electrolyte contacts your clothes, they may be damaged.

If the battery electrolyte gets into your eyes or contacts your skin, flush immediately with large amounts of water, and obtain medical treatment at once.

- Be sure to wear safety goggles when handling a battery.
  - To disconnect the terminals, begin with the negative terminal (ground side); to connect the terminals, begin with the positive terminal.
  - If a tool touches both the positive terminal and the machine, hazardous sparks may be generated.
  - If a terminal is loose, hazardous sparks may be generated due to poor contact, which could cause ignition and explosion.
- Be sure to securely connect the terminals.

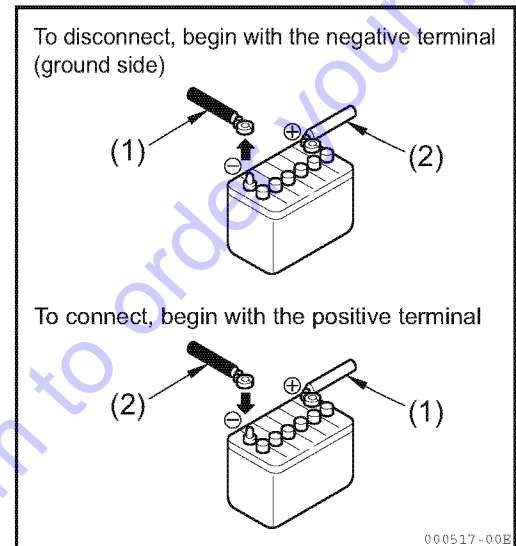

### 18-3-1. Starting the engine using booster cables

To start the engine using booster battery cables, do the following.

#### ■ Precautions for connecting and disconnecting the booster cables

#### **! WARNING**

- When you start the engine using booster cables, wear safety goggles.
- If you start the engine by taking electric power from another machine, do not allow contact between your machine and the other machine.
- To connect the booster cables, begin with the positive terminal, and to disconnect them, begin with the negative terminal (ground side).
- If a tool touches the positive terminal and the machine at the same time, hazardous sparks may be generated.
- Do not connect the booster cables to terminals of reverse polarity. That is, never connect a negative terminal on one machine to the positive terminal on the other machine.
- As the last step, connect the negative booster cable to the upperstructure. At this time, sparks will be generated. Connect the terminal to a point as far away from the battery as possible.

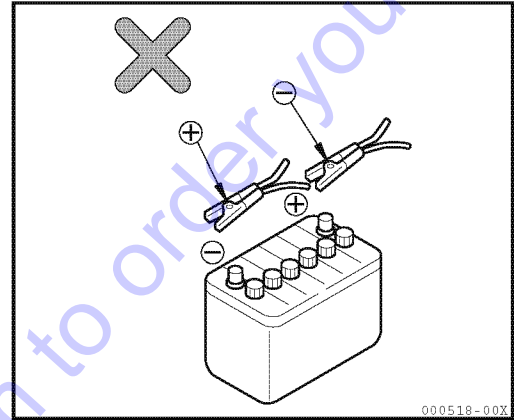

#### IMPORTANT

- The booster battery cables capacity and the clip size should be suitable for the battery size.
- The battery of the normal machine should be the same capacity as that of the machine in trouble.
- Check the booster battery cables and clips for an absence of damage, cracks, and corrosion.
- Securely connect the clips.

■ **Charging with the battery mounted on the machine**

- Remove the battery cables from the positive and negative terminals of the battery before charging it. If this is not done, abnormal voltage may be applied to the generator which could damage it.
- While charging the battery, remove all plugs to release the gases generated by charging.
- If the battery overheats [the temperature of the electrolyte exceeds 113°F (45°C)], interrupt charging.
- Stop charging as soon as the process has been completed.  
Overcharging could cause the following troubles:
  - Overheating of the battery
  - Decrease in battery electrolyte
  - Battery failure
- Do not reverse polarity of the battery cable connected to the battery (i.e., the negative to the positive, or the positive to the negative).  
Reversing the polarity in the connection will cause the generator to be damaged.
- Handling the battery (except for checking the electrolyte level and measuring the specific gravity of the electrolyte) should be performed after disconnecting the battery cables.

### ■ Connecting the booster battery cables

Turn the starter switch to the "OFF" position, and connect the booster battery cables as follows:

- 1) Turn the starter switches on the normal machine and the machine in trouble to the "OFF" position.
- 2) Connect the clip of the booster battery cables (A) (normally red) to the positive terminal on the machine in trouble.
- 3) Connect the other clip of the booster battery cables (A) to the positive terminal on the normal machine.
- 4) Connect the clip of the booster battery cables (B) (normally black) to the negative terminal on the normal machine.
- 5) Connect the other clip of the booster battery cables (B) to the engine block of the machine in trouble.

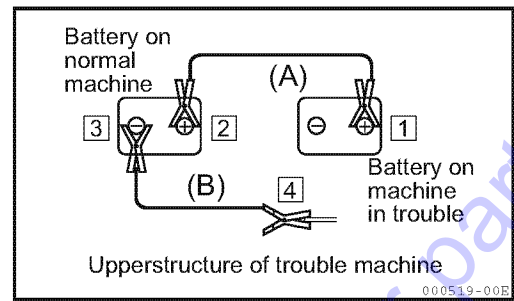

### ■ Starting the engine

- 1) Make sure that the clips are securely connected to the battery terminals.
- 2) Start the engine on the normal machine, and increase the engine speed to the maximum.
- 3) Turn the starter switch on the machine in trouble to the "START" position to start the engine.  
If the engine does not start, wait for more than two minutes and retry starting. (At this point, do not stop the engine on the normal machine and keep engine speed at full.)

### ■ Disconnecting the booster battery cables

After the engine on the machine in trouble has started, disconnect the booster battery cables in the reverse order of the connecting procedure.

- 1) Remove the clip of the booster battery cables (B) from the engine block on the machine in trouble.
- 2) Remove the clip of the booster battery cables (B) from the negative terminal on the normal machine.
- 3) Remove the clip of the booster battery cables (A) from the positive terminal on the normal machine.
- 4) Remove the clip of the booster battery cables (A) from the positive terminal on the machine in trouble.

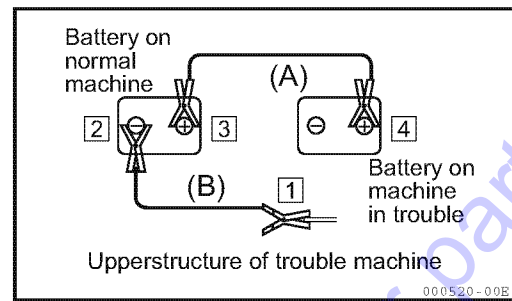

**18-4. Troubleshooting**

**18-4-1. Engine and electrical equipment**

- Contact your dealer about the measures shown in parentheses in the list below.
- If there is any abnormality or trouble whose cause is unknown other than those shown below, ask your dealer for repair.

| Problem              |  | Cause   | Measure  |
|----------------------|--|---|--|
| Engine               | Steam comes out of top of radiator.  | <ul style="list-style-type: none"> <li>• Shortage of cooling water</li> </ul>   | <ul style="list-style-type: none"> <li>• Check cooling water level. Refill, if necessary. (Check cooling water for leak from water port.)</li> <li>• Adjust belt tension.</li> <li>• Replace cooling water. Clean inside of cooling water system.</li> <li>• Replace thermostat.</li> <li>• Clean or repair fin.</li> <li>• Check or replace electrical system.</li> </ul> |
|                      | Water temp alarm lamp lights.  |   |  |
|                      | Turning on starter motor does not start engine.                              | <ul style="list-style-type: none"> <li>• Shortage of fuel</li> <li>• Air mixed in fuel system</li> <li>• Defective fuel injection pump or deteriorated nozzle performance</li> <li>• Improper compression</li> <li>• Blown out fusible link</li> <li>• Damaged key stop solenoid. Link disengagement</li> </ul> | <ul style="list-style-type: none"> <li>• Refill fuel tank.</li> <li>• Repair air leak. Release air from fuel system. (• Replace pump or nozzle.)</li> <li>(• Check and repair.)</li> <li>• Replace fusible link.</li> <li>(• Check and repair.)</li> </ul>   |
|                      | Dark fumes come out of machine.  | <ul style="list-style-type: none"> <li>• Clogged air cleaner element</li> <li>• Deteriorated nozzle performance</li> <li>• Improper compression</li> </ul>  | <ul style="list-style-type: none"> <li>• Clean or repair element.</li> <li>(• Check and repair.)</li> <li>(• Check and repair.)</li> </ul>   |
|                      | Exhaust color is white or bluish white.                                      | <ul style="list-style-type: none"> <li>• Too much oil in oil pan</li> <li>• Improper fuel</li> <li>• Worn cylinder or piston ring</li> </ul>  | <ul style="list-style-type: none"> <li>• Drain oil from oil pan to specified level.</li> <li>• Replace fuel with recommended one.</li> <li>(• Repair.)</li> </ul>  |
| Electrical equipment | Turning starter switch to "START" does not start starter motor.              | <ul style="list-style-type: none"> <li>• Defective wiring system</li> <li>• Defective starter switch</li> <li>• Insufficiently charged battery</li> <li>• Defective starter motor</li> </ul>  | <ul style="list-style-type: none"> <li>• Check and repair wiring system.</li> <li>• Replace starter switch.</li> <li>• Recharge battery.</li> <li>(• Check and repair.)</li> </ul>   |
|                      | Maximum engine speed does not provide enough brightness of lamps.            | <ul style="list-style-type: none"> <li>• Defective wiring system</li> <li>• Defective generator or regulator</li> </ul>   | <ul style="list-style-type: none"> <li>• Check terminals for looseness and disconnection. Repair terminal, if necessary.</li> <li>(• Check and repair.)</li> </ul>   |
|                      | During engine operation, lamp is extremely bright, and frequently burns out. | <ul style="list-style-type: none"> <li>• Defective regulator</li> </ul>   | <ul style="list-style-type: none"> <li>(• Replace regulator.)</li> <li>(• Repair.)</li> </ul>  |
|                      | Electrolyte leaks from battery.  |   |  |
|                      | Speed of starter motor is too low.   | <ul style="list-style-type: none"> <li>• Defective wiring system</li> <li>• Insufficiently charged battery</li> <li>• Defective starter motor</li> </ul>  | <ul style="list-style-type: none"> <li>• Check and repair wiring system.</li> <li>• Recharge battery.</li> <li>(• Check and repair.)</li> </ul>  |



**18-4-2. Machine body**

- Contact your dealer about the measures shown in parentheses in the list below.
- If there is any abnormality or trouble whose cause is unknown other than those shown below, ask your dealer for repair.

| Problem      |   | Cause   | Measure  |
|--------------|---|---|--|
| Machine body | Power or speed of moving part is low.                     | <ul style="list-style-type: none"> <li>• Deteriorated function caused by worn hydraulic pump</li> <li>• Pressures of main relief valve, or port relief valve of control valve are dropped below set value.</li> <li>• Damaged hydraulic cylinder</li> <li>• Insufficient amount of hydraulic oil</li> <li>• Clogged filter</li> </ul> | <ul style="list-style-type: none"> <li>(• Replace hydraulic pump.)</li> <li>(• Check and repair valves.)</li> <li>(• Check and repair.)</li> <li>• Replenish hydraulic oil up to specified level.</li> <li>• Clean or replace filter.</li> </ul> |
|              | Upperstructure does not swing or does not swing smoothly. | <ul style="list-style-type: none"> <li>• Swing brake is not released</li> <li>• Insufficient amount of grease</li> <li>• Defective swing brake valve</li> <li>• Defective swing motor</li> </ul>  | <ul style="list-style-type: none"> <li>(• Check and repair.)</li> <li>• Check and grease.</li> <li>(• Check and repair.)</li> <li>(• Check and repair.)</li> </ul>   |
|              | Temperature of hydraulic oil is too high.                 | <ul style="list-style-type: none"> <li>• Insufficient amount of hydraulic oil</li> <li>• Overload</li> </ul>  | <ul style="list-style-type: none"> <li>• Replenish hydraulic oil up to specified level.</li> <li>• Lower load.</li> </ul>  |
|              | Machine does not move straight.                           | <ul style="list-style-type: none"> <li>• Improperly adjusted track or trapped foreign material</li> <li>• Damaged hydraulic motor.</li> <li>• Defective hydraulic pump</li> <li>• Defective control valve</li> <li>• Damaged sprocket, idler or track roller.</li> </ul>  | <ul style="list-style-type: none"> <li>• Adjust or clean.</li> <li>(• Check and repair.)</li> <li>(• Check and repair.)</li> <li>(• Check and repair.)</li> <li>(• Check and repair.)</li> </ul>   |

# 19. OPERATION (ViO55-5B Angle blade spec.)

## 19-1. Identification of Important Parts

### 19-1-1. Overview of the machine

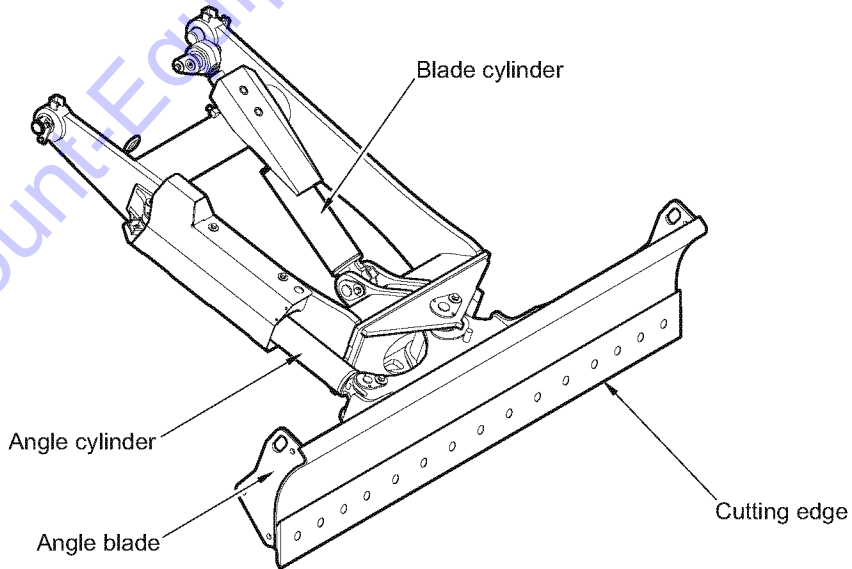
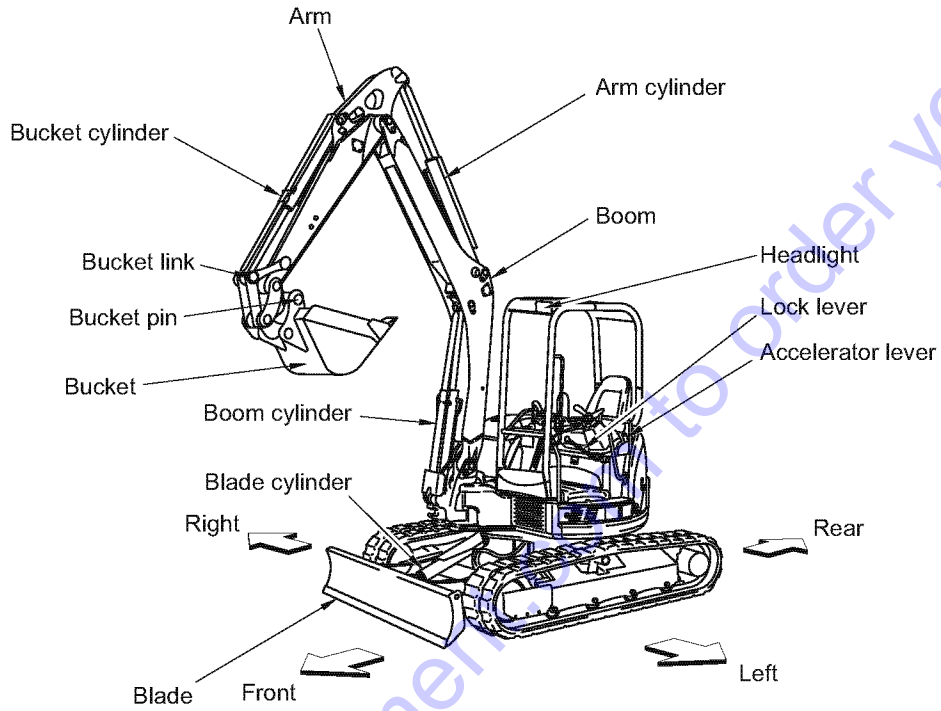

Detail of angle blade

026456-00E

19-1-2. Controls and switches

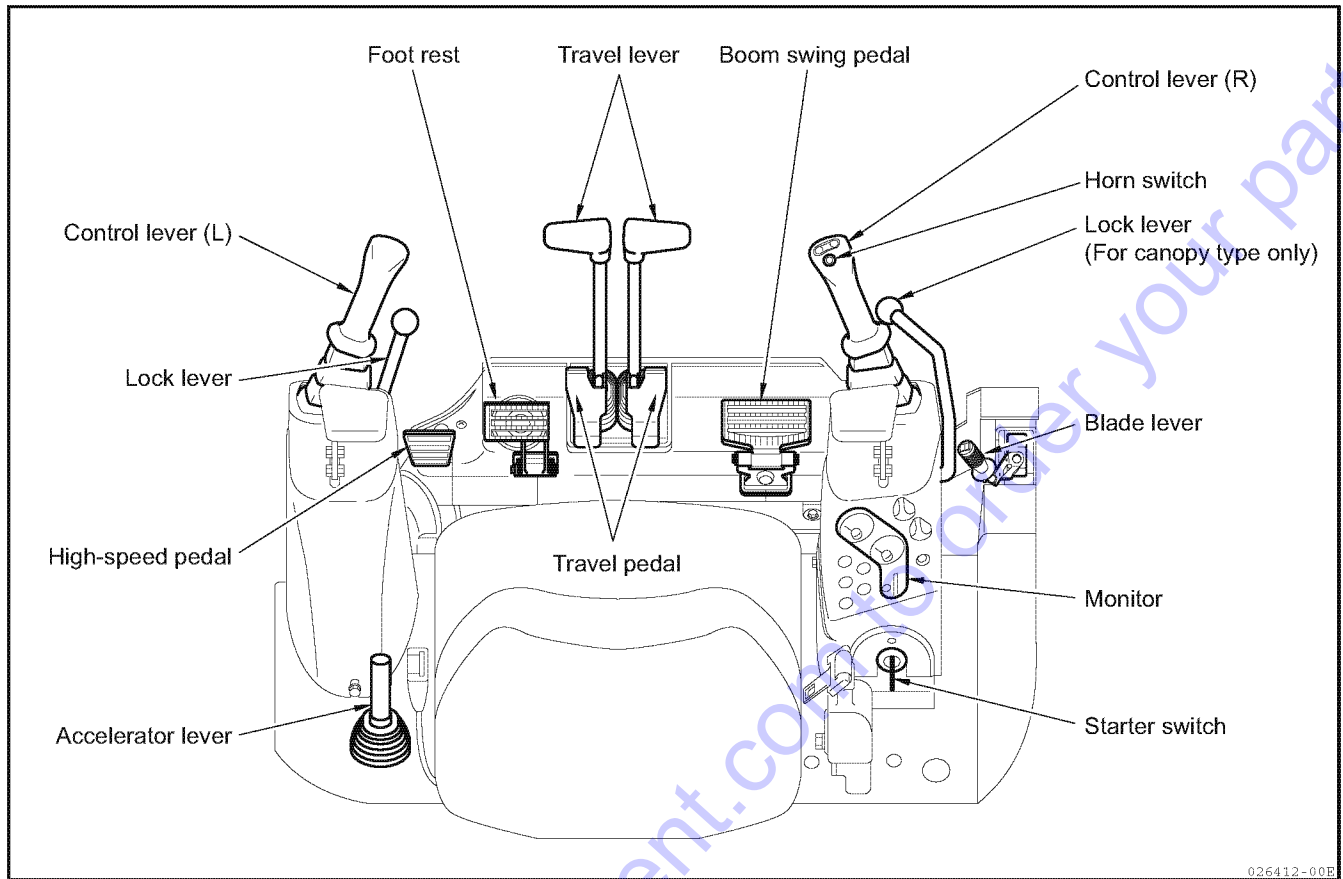

## 19-2. Description of Control Devices

### 19-2-1. Control levers and switches

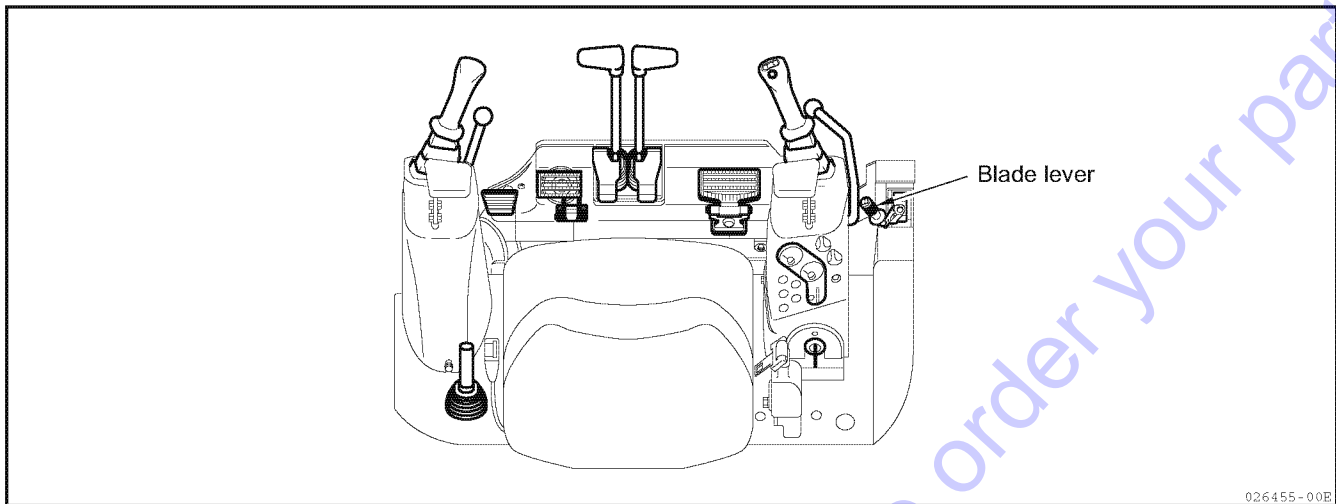

#### 1) Blade lever

Use this lever to control the blade.

#### IMPORTANT

**The blade lever is not locked by setting the lock lever to the lock position. Do not touch the blade lever when not operating the blade.**

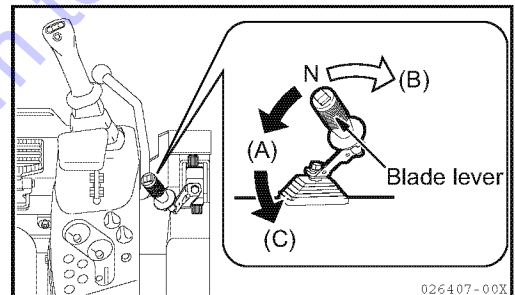

(A) : Down : Push the lever forward.

(B) : Up : Pull the lever backward.

N : Neutral : When the lever is released, it will return to neutral except for float position. The machine will remain positioned.

(C) : Float : When the lever is pushed forward and strongly pushed further from the down position, the blade will be in the float condition and the lever is held as it is. The blade will drop to the ground by gravity and will stop. If this mode is used for operation on a concrete-covered ground or land-leveling operation, the bucket will follow the contour of the ground by using the weight of the blade, so the work can be performed efficiently.

**! DANGER**

**NEVER** put the lever in the float position during digging the ground or lifting the machine, as it may get down suddenly and cause a serious accident.

2) Angle switch

Operate the switch on the top of the blade lever grip to control the angle of the blade.

Left angle : Control the switch to the (A) side.

Right angle : Control the switch to the (B) side.

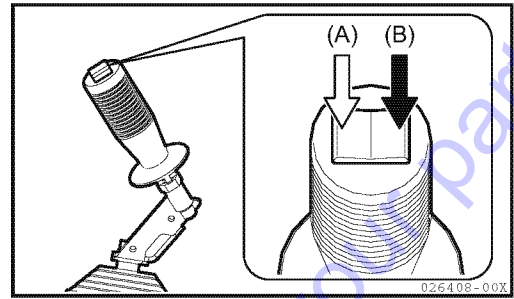

**19-3. Operating Instruction**

19-3-1. Operating the implements

**! DANGER**

Check the area around the machine for safety and sound the horn before beginning to operate the machine.

Operating Angle blade

1) Blade UP (B), DOWN (A) and Float (C)

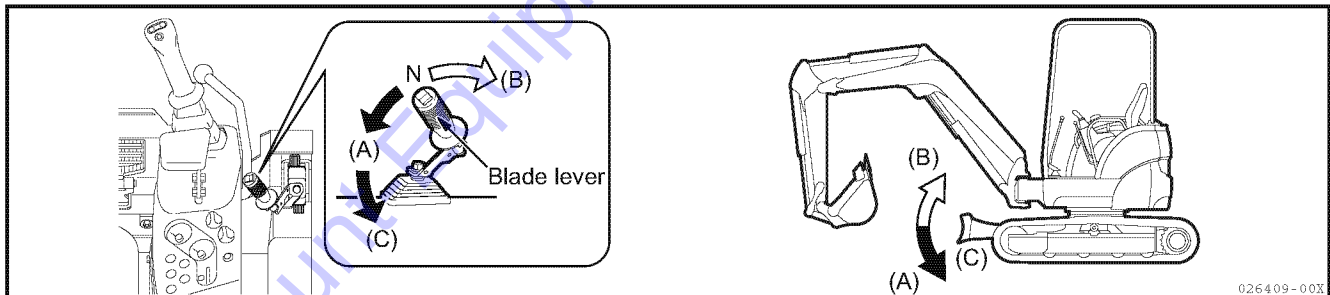

2) Blade ANGLE

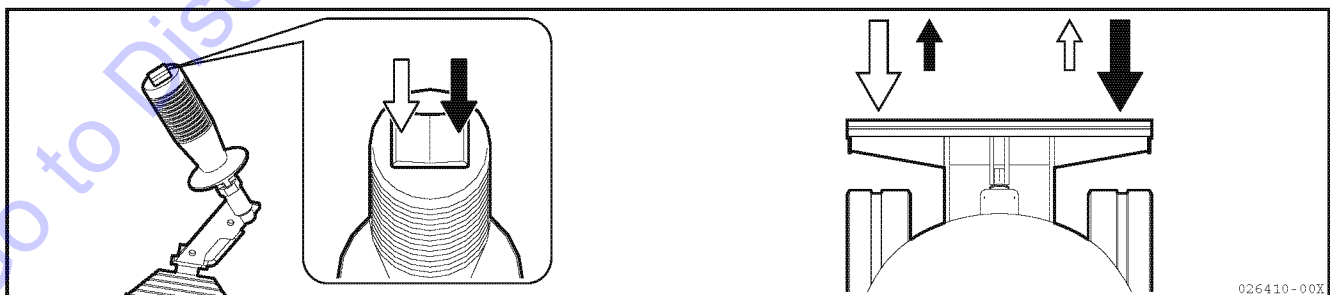

**19-4. Troubleshooting**

**19-4-1. Troubleshooting**

Contact your dealer about the measures shown in parentheses in the list below.

If there is any abnormally or trouble whose cause is unknown other than those shown below, ask your dealer for repair.

| Condition  | Cause  | Check item  | Action   |
|--|--|---|--|
| Angle speed is slow or it does not work                      | • Dust being caught in relief valve or malfunction               | • Measure set pressure  | • Adjust pressure after disassembly and washing or replace |
|  | • Hydraulic oil leakage in the swivel joint                      | • Inspect swivel joint seal   | • Replace seals after disassembly                          |
|  | • Malfunction of control valve (solenoid valve)                  | • Inspect fuse<br>• Inspect connection of couplers<br>• Inspect solenoid operation<br>• Inspect spool<br>• Inspect control switch<br>• Inspect solenoid valve-related harness | • Replace faulty parts<br>• Wash spool                     |
|  | • Hydraulic oil leakage in the cylinder                          | • Inspect seal in the cylinder  | • Replace seals after disassembly                          |
| When the angle is operated while traveling, it does not work | • Dust being caught in shuttle valve or malfunction              | • Overhaul shuttle valve  | • Disassemble and wash<br>• Replace faulty parts           |
| Not floating in the float position                           | • Dust being caught in blade remote control valve or malfunction | • Inspect pilot pressure<br>• Inspect blade remote control valve  | • Disassemble and wash<br>• Replace faulty parts           |
|  | • Dust being caught in control valve or malfunction              | • Inspect control valve, blade, and spool   | • Disassemble and wash<br>• Replace faulty parts           |

# MAINTENANCE

Go to [Discount-Equipment.com](http://Discount-Equipment.com) to order your parts

## 20. Precautions for Servicing

**Do not use any inspection or servicing procedures that are not described and recommended in this manual.**

**Park the machine on solid, level ground to inspect and service it.**

### **Check the hourmeter**

Read the hourmeter every day to check if any service item has reached the time prescribed for implementation.

Use YANMAR genuine replacement parts

### **Use YANMAR genuine parts specified in the parts catalog**

Use YANMAR genuine lube oil and grease

Use YANMAR genuine lube oil and grease of specified viscosity with regard to the temperature.

### **Use clean lube oil and grease**

Use clean lube oil, grease and containers to prevent dust from mixing into them.

### **Clean the machine**

Clean the machine for easy isolation of faulty parts.

Particularly clean the grease nipple, breather, and the oil level gauge glass to prevent dust from entering into them.

### **Be careful of high water and oil temperatures**

It is dangerous to replace the oil, the cooling water and the filter immediately after stopping the engine. Wait until their temperatures drop. When the engine oil is too cool, heat the oil to adequate temperature [approximately 68°F to 104°F (20°C to 40°C)] before draining oil to improve draining efficiency.

### **Check the drained oil and the old filter element**

When replacing the engine oil, the hydraulic oil, or the filter element, check the drained oil and the old filter element for metallic dust and foreign solid deposits.

### **Observe precautions for replenishing oil**

If a strainer is mounted on the oil port, do not remove the strainer to replenish oil.

### **Be careful of dust**

When checking or replacing the oil, do this in the place with no dust or other particles to prevent dust contamination.



### **Attach the warning tag**

When the oil or the cooling water is drained, attach the "SERVICING IN PROGRESS" tag to the operator's seat so that other persons will not start the engine.

### **Observe the warning labels**

Observe the warning labels affixed to the machine.

### **Observe the precautions for welding**

- Make sure to disconnect the battery cables (positive and negative terminals).
- Do not apply more than 200 V continuously.
- Ground the machine within 39.37 in. (1000 mm) from the welded part.
- Make sure that there is no seal or bearing between the welded part and the grounded part.
- Do not ground around the pins on the implement or the hydraulic cylinder.

### **Be careful of fire**

Clean parts with noncombustible detergent.

### **Relieve the internal pressure**

Before checking or servicing the hydraulic system, relieve the hydraulic oil pressure in the circuit according to the following procedure.

- (1) Stop the engine.
- (2) Turn the starter key to "ON" position.
- (3) Push the lock lever forward to set it in unlock position.
- (4) Alternatively press the right and left sides of the lever switch several times for the P.T.O. circuit and move levers or pedals to full stroke ends several times for the other actuator circuits.

### **Clean mating surfaces before assembly**

When you have removed a part with an O-ring or a gasket seal, clean the mating surfaces before installing the new part.

At this point, do not fail to refit the O-ring or the gasket

### **Do not drop anything from your breast pocket**

When you open the cover and attempt to look down into the inside of the machine, remove loose items from your breast pocket to eliminate the risk that they may drop into the machine.

### **Check the undercarriage**

After the machine is used at a rocky place, check the undercarriage for damage. Check for loose bolts and nuts, cracks, wear, and other damage. Loosen the tension of the track more than usual.

### **Observe the precautions for cleaning the machine**

- Do not spray steam directly at the connectors.
- Do not splash water on the monitors in the cabin.
- Do not spray high-pressure water directly at the radiator and the oil cooler.

### **Check before and after working**

If the machine is to be used in mud, rain, snow, or on a beach, check for loose plugs and cocks before working. After working, clean the machine and check each part for cracks and damage and check for loose or missing bolts and nuts. Apply grease earlier than usual. Particularly apply grease every day to the pins on the implement which are submerged in mud.

### **Observe the precautions for working in a dusty place**

If you use the machine in a dusty place, be careful of the following:

- Check the air cleaner for clogging.  
Clean the air cleaner element earlier than scheduled.
- Clean the radiator fin earlier to prevent it from clogging.
- Clean or replace the fuel filter element earlier than scheduled.
- Clean the electric equipment, especially the starter motor and the generator, to avoid dust deposits.

### **Do not mix oils**

Never mix oils of different makes or types. If you have to replenish an oil with a different make or type than the one already in the tank, remove the remaining oil completely.

## 21. Basic Servicing Practices

- Use YANMAR genuine replacement parts.
- Do not mix oils of different makes and types when replacing or replenishing oil.
- The following types of oil and cooling water are used in the factory for shipping unless otherwise specified:

| Item                  | Type   |
|-----------------------|--|
| Engine oil            | Engine oil SAE10W30, CD class                    |
| Travel reduction gear | SAE90 (GL-4)                                     |
| Hydraulic oil         | YANMAR SUPER HYDRO. OIL (ISO VG46)               |
| Fuel                  | No.3 Diesel light oil                            |
| Engine cooling water  | YANMAR genuine long-life coolant (LLC) 51% added |

**21-1. Oils, fuel, and cooling water**

**21-1-1. Oils**

- Because the oil is used in the engine and implement under extreme conditions (high temperature and pressure), it deteriorates as time elapses.  
Be sure to use oils of the grades which are specified in the Operation & Maintenance Manual and suitable for the operating temperature range.  
Even if the oil is not contaminated, be sure to replace the oil within the specified service hours.
- Oil is equivalent to blood in a human body. Be careful in handling it so that impurities (water, metallic dust, and foreign solids) will not be mixed into it.  
Most machine failures are caused by impurities in the oils.  
Be careful not to mix impurities into the oils especially after storing the machine and replenishing oils.
- Do not mix oils of different makes and types.
- Use the specified amount of oil.  
Larger or smaller amounts of oil than specified may cause machine problems.
- If the oil becomes cloudy, it may suggest that water or air could have been mixed into the hydraulic system. If this event happens, ask your dealer.
- Be sure to replace the oil filter element with a new one when changing the oil.
- To know what condition the machine is in, it is recommended that you analyze the properties of the oil periodically.  
Ask your dealer for more information on this issue.

### 21-1-2. Fuel

- Because the fuel injection pump is a precision device, using a fuel containing water or dust will cause problems.
- Be careful that impurities will not be mixed into the fuel especially after storing the machine and refueling.
- Be sure to use a fuel recommended in the Operation & Maintenance Manual.  
In addition, keep in mind that you should use a fuel appropriate for the operating temperature range because it will freeze at temperatures lower than -13°F (-25°C).
- Fully refuel every day after finishing the work so that the moisture in the fuel tank will not condense and water will not mix with the fuel.
- Before starting the engine, or ten minutes after refueling, drain any deposits and water through the drain plug on the fuel tank.
- If the fuel level becomes low or the filter element is replaced, the air should be released from the fuel system.

### 21-1-3. Cooling water

- Because unpotable water may contain much calcium and impurities, using it will cause water scale to build up in the engine or the radiator, causing poor heat exchange and overheating.  
Never use water which is not potable for cooling purposes.
- When using an anti-freeze, observe the precautions described in the Operation & Maintenance Manual.
- The YANMAR machine is shipped with YANMAR genuine anti-freeze. The anti-freeze is anticorrosive to protect the cooling system.  
Because the anti-freeze can be used continuously over two years, you need not remove it in hot weather.

#### **DANGER**

**Keep sources of ignition away from the antifreeze because it is flammable.**

- The mixing ratio of the anti-freeze to the water differs based on air temperature.  
For the mixing ratio, refer to Section "27-2-6. Cleaning the inside of the cooling system".
- If the engine is overheated, replenish the cooling water after the engine has cooled down.
- Shortage of cooling water will cause the cooling system not only to overheat but also to corrode due to air which comes in the system.

**21-1-4. Grease**

- Grease ensures smooth operation of moving parts such as connectors and prevent operating noises.
- The nipples not listed on the pages for periodic service are those for overhaul. Normally it is not necessary to refill them.  
Grease them if any abnormal condition arises after long term use.
- Wipe the extruded old grease off with a rag after greasing.  
Carefully wipe the old grease off completely from all moving parts which are easily worn by adhered sand or dust.

**21-1-5. Storing the oil and fuel**

- Store the oil and fuel indoors so that they will not be contaminated by impurities such as water or dust.
- When you store oil or fuel in drums for a long period, position them so that their outlets align in a straight line (to prevent moisture absorption).  
When storing the oil or the fuel outdoors, cover the drums with a waterproof sheet.
- To avoid deterioration caused by long-term storage, use the oil on a first-in first-out basis.

**21-1-6. Filter**

- The filters are very important parts which prevent impurities from getting into critical devices through the lube oil, fuel and air systems.  
Replace the filter elements periodically according to the instructions of the Operation & Maintenance Manual.  
Under difficult conditions, you need to replace the filter elements earlier than suggested in the Operation & Maintenance Manual depending on the type of oil and fuel (sulfur content).
- Never reuse the filter elements (cartridge type) by cleaning them.
- When replacing an oil filter element, check that no metallic dust or foreign solids are present on the old filter.  
If they are found to be present, contact the nearest dealer.
- Do not unpack the filter element before use.
- Use YANMAR genuine filter elements.

## **21-2. Electrical equipment**

- If electrical equipment gets wet or wiring insulation is broken, electric leaks may occur and the machine may malfunction which is very dangerous.
- Check the fan belt for tension and damage, and also check the battery for electrolyte level.
- Never disconnect or disassemble the electrical equipment mounted on the machine.
- Do not mount any electrical equipment other than those items provided by YANMAR.
- Be careful not to spray water on the electrical equipment when washing the machine or operating in the rain.
- After working near the sea, take necessary precautions to protect the electrical equipment from corrosion.

### 21-3. Hydraulic system

- The hydraulic system is hot during and immediately after operation. It is also given high pressure during operation. Therefore, check and service the hydraulic system carefully as follows:

- Put the bucket on the level ground so that no pressure is applied to the hydraulic cylinder circuits.
- Be sure to stop the engine.
- Wait until the temperature drops sufficiently and then start maintenance since the hydraulic oil and the lube oil are at high temperature and high pressure immediately after operation.

Do not suddenly remove any plugs, screws or connecting parts of the hoses. Otherwise oil may spout out due to residual internal pressure even when the oil temperature has lowered. Be careful not to face them when loosening them to prevent injury, and loosen them little by little to remove the internal pressure.

- Always relieve the internal pressure before checking and servicing the hydraulic system according to the following procedure.

- (1) Stop the engine.
- (2) Turn the starter key to "ON" position.
- (3) Push the lock lever forward to set it in unlock position.
- (4) Alternatively press the right and left sides of the lever switch several times for the P.T.O. circuit and move levers or pedals to full stroke ends several times for the other actuator circuits.

- Check the hydraulic oil level, replace the filter element, and replace the hydraulic oil when necessary.
- When removing the hydraulic hoses and pipings, check the O-ring and the packing for damage before reinstalling them.

Replace them if they are damaged.

- Release air after replacing or cleaning the hydraulic oil filter element or strainer, repairing or replacing the hydraulic equipment, or removing the hydraulic cylinder or piping.

Release air according to the following procedure:

- 1) Set the engine rotation to medium. That is, set the lever in the middle of the stroke.
- 2) Slowly operate each cylinder 4 to 5 times to approximately 3.9 in. (100 mm) before both stroke ends.
- 3) Operate the cylinder 4 to 5 times at full stroke.

- Failure to release air from the hydraulic cylinder and operating it suddenly to the stroke ends could cause piston seal damage.

- If air is left in the hydraulic circuit, air is compressed and swollen by the load and the hydraulic equipment does not operate smoothly.

Air in the hydraulic circuit may shorten the service life of the hydraulic pump.

- 4) Check the hydraulic oil level and replenish to the specified level if necessary.

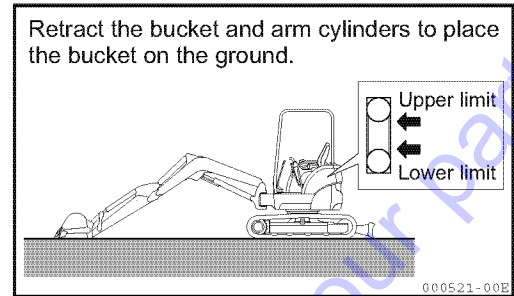



## 22. Consumables

Periodically replace consumable parts such as filter element and bucket teeth.

Periodic replacement prevents malfunction of the machine. When you replace a part, be sure to use a Yanmar genuine part.

When ordering consumables, let us know the parts numbers given in the parts catalog.

### List of consumables

The parts in ( ) represent those which must be replaced at the same time.

| Item                             | Name                          | Q'ty     | Replacing time interval                                 |
|----------------------------------|-------------------------------|----------|---|
| Engine oil filter                | Oil filter 80×80 L            | 1        | Every 250 service hours<br>(At first 50 service hours)  |
| Hydraulic oil tank return filter | Filter element                | 1        | Every 500 service hours<br>(At first 250 service hours) |
| Fuel filter                      | Fuel filter element           | 1        | Every 500 service hours                                 |
| Air cleaner                      | Cleaner element               | 1        | Every 500 service hours                                 |
| Bucket                           | Point teeth<br>(Lock pin CMP) | 4<br>(4) | -   |
|                                  | Side cutter (left)            | 1        |   |
|                                  | Side cutter (right)           | 1        |   |
|                                  | (Bolt 16×50)                  | (6)      |   |
|                                  | (Nut 16)                      | (6)      |   |
|                                  | (Spring washer 16)            | (6)      |   |

## 23. Fueling, Oiling and Greasing Based on Temperature Range

### 23-1. Fuel and oil

Select fuel and oil based on to the air temperature range.

The prescribed amount of oil means the total amount of oil included in the piping and equipment. The amount of oil to be changed means the amount of oil replaced in checking and servicing.

If you start the engine at air temperatures lower than 32°F (0°C), use SAE10W, SAE10W-30, or SAE15W-40 even if the temperature in the daytime rises to 50°F (10°C) or so.

### 23-2. Cooling water

Because a YANMAR genuine long-life coolant (LLC) is added to the cooling water, you need not change it unless the temperature falls bellow -31°F (-35°C).

If the temperature falls below -31°F (-35°C), refer to Section "27-2. Nonperiodic services" to control the density of the cooling water.

| Part be refilled      | Oil type      | Recommendations with regard to temperature ranges |             |             |           |            |            |                   | Prescribed amount of oil                                      |  | Amount of oil to be changed |          |
|-----------------------|---------------|---|-------------|-------------|-----------|------------|------------|-------------------|---|--|-----------------------------|----------|
|                       |               | (°F)<br>(°C)                                      | -4<br>(-20) | 14<br>(-10) | 32<br>(0) | 50<br>(10) | 68<br>(20) | 86<br>(30)        | VI045-5B  | VI055-5B                                       | VI045-5B                    | VI055-5B |
| Engine oil pan        | Engine oil    | SAE 10W CD  |             |             |           |            |            |                   | 9.4 Qts. (8.9 L)  | 9.4 Qts. (8.9 L)                               |                             |          |
|                       |               | SAE 10W-30 CD                                     |             |             |           |            |            |                   |   |  |                             |          |
|                       |               | SAE 15W-40 CD                                     |             |             |           |            |            |                   |   |  |                             |          |
| Travel reduction gear | Gear oil      | SAE 90 (GL-4)                                     |             |             |           |            |            |                   | 1.27 Qts. (1.2 L)<br>(For right and left each)                | 1.27 Qts. (1.2 L)<br>(For right and left each) |                             |          |
| Hydraulic oil system  | Hydraulic oil | ISO VG46  |             |             |           |            |            |                   | In the tank 10.0 Gals. (38 L)<br>Other parts 6.9 Gals. (26 L) | 10.0 Gals. (38 L)                              |                             |          |
| Fuel tank             | Light oil     | No.2-D  |             |             |           |            |            |                   | 16.9 Gals. (64 L)   | -  |                             |          |
|                       |               | No.3-D  |             |             |           |            |            |                   |   |  |                             |          |
|                       |               | No.3-D (S)  |             |             |           |            |            |                   |   |  |                             |          |
| Cooling system        | Water         | YANMAR genuine long-life coolant (LLC) added      |             |             |           |            |            |                   | Radiator  | -  |                             |          |
|                       |               |   |             |             |           |            |            |                   | 6.66 Qts. (6.3 L)   |  |                             |          |
|                       |               |   |             |             |           |            |            |                   | Subtank   |  |                             |          |
|                       |               |   |             |             |           |            |            | 0.42 Qts. (0.4 L) |   |  |                             |          |

## 24. Standard Tightening Torque for Bolts and Nuts

### 24-1. Required tools

The following tools are required for servicing:

| No. | Name                            | Part number  | Q'ty |
|-----|---------------------------------|--------------|------|
| 1   | Screw driver (universal system) | 104200-92350 | 1    |
| 2   | Filter wrench 68                | 119332-92751 | 1    |
| 3   | Filter wrench 80                | 119640-92750 | 1    |
| 4   | Filter wrench LO                | 171301-92750 | 1    |
| 5   | Pressuring nozzle               | 172122-05101 | 1    |
| 6   | Wrench 8×10                     | 28110-080100 | 1    |
| 7   | Wrench 12×14                    | 28110-120140 | 2    |
| 8   | Wrench 17×19                    | 28110-170190 | 1    |
| 9   | Wrench 22×24                    | 28110-220240 | 2    |
| 10  | Wrench 27×30                    | 28110-270300 | 1    |
| 11  | Wrench 32×36                    | 28110-320360 | 1    |
| 12  | Hexagon bar wrench 4            | 28150-040000 | 1    |
| 13  | Hexagon bar wrench 5            | 28150-050000 | 1    |
| 14  | Hexagon bar wrench 8            | 28150-080000 | 1    |
| 15  | Box wrench 27×140               | 28227-271400 | 1    |
| 16  | Turning handle 12×250           | 28230-120250 | 1    |
| 17  | Grease hose                     | 933110-09701 | 1    |
| 18  | Grease gun 800                  | 933110-09801 | 1    |
| 19  | Pliers 200                      | 933171-00470 | 1    |

## 24. Standard Tightening Torque for Bolts and Nuts

### 24-2. Torque table

Bolts or nuts in the metric system should be tightened at the torque described below unless specified otherwise.

| Item                     |                | Thread size × pitch             | Tightening torque ft·lbf (N·m)  | Remarks  |
|--------------------------|----------------|---------------------------------|---------------------------------|--|
| Hexagon bolt (7T)<br>Nut | Coarse threads | M6 × 1                          | 7.23 to 8.68 (9.8 to 11.8)      | 1) Apply 80% tightening torque when tightened to aluminum.<br>2) Apply 60% tightening torque for 4T bolt and lock nut.<br>3) Use fine thread screws for engine only. |
|                          |                | M8 × 1.25                       | 16.6 to 21.0 (22.6 to 28.4)     |  |
|                          |                | M10 × 1.5                       | 32.6 to 43.4 (44.1 to 58.8)     |  |
|                          |                | M12 × 1.75                      | 57.9 to 72.3 (78.5 to 98.1)     |  |
|                          |                | M14 × 2                         | 86.8 to 108.5 (117.7 to 147.1)  |  |
|                          |                | M16 × 2                         | 123.0 to 151.9 (166.7 to 206.0) |  |
|                          |                | M18 × 2.5                       | 173.6 to 209.8 (235.4 to 284.4) |  |
|                          | M20 × 2.5      | 238.7 to 296.6 (323.6 to 402.1) |                                 |  |
|                          | Fine threads   | M14 × 1.5                       | 94.0 to 108.5 (127.5 to 147.1)  |  |
| M16 × 1.5                |                | 155.5 to 177.2 (210.8 to 240.3) |                                 |  |
| PT plug                  |                | 1/8                             | 7.2 (9.8)                       |  |
|                          |                | 1/4                             | 14.5 (19.6)                     |  |
|                          |                | 3/8                             | 21.7 (29.4)                     |  |
|                          |                | 1/2                             | 43.4 (58.8)                     |  |
| Pipe joint bolt          |                | M8                              | 9.4 to 12.3 (12.7 to 16.7)      |  |
|                          |                | M12                             | 18.1 to 25.3 (24.5 to 34.3)     |  |
|                          |                | M14                             | 28.9 to 36.2 (39.2 to 49.0)     |  |
|                          |                | M16                             | 36.2 to 43.4 (49.0 to 58.8)     |  |

### IMPORTANT

If a part to be tightened is made of resin like a panel board, excessive tightening torque may damage the tightened part. Be careful when tightening.

## 25. Replacing Essential Parts Periodically

For safe operation, the machine must be serviced periodically. To increase safety, be sure to periodically replace the parts listed in the table of safety parts on the next page. A fire could result if they deteriorate or are damaged.

These parts are vulnerable to age and wear or deterioration and it is difficult to determine the degree to which they have deteriorated on the occasion of periodic service. To maintain their proper function at all times, therefore, replace them with new ones after using them for a specific period of time even if no abnormality is found with the parts.

If you find abnormalities in these parts before their scheduled replacement time is reached, repair or replace them immediately.

If a hose clamp is deformed or cracked, replace it immediately.

Check the hydraulic hoses (which are not periodic replacement parts). If any abnormality is found in them, retighten them or replace them immediately.

When replacing the hydraulic hoses, replace the O-rings and seals at the same time.

For further information about replacing the safety parts, ask your dealer.

Check the fuel and hydraulic hoses according to the periodic schedule described below.

| Check categories        | Check points   |
|-------------------------|--|
| Start-up check          | Oil leak from the connections or bodies of the fuel and hydraulic hoses  |
| Voluntary monthly check | Oil leak from the connections or bodies of the fuel and hydraulic hoses<br>Damage (crack, wear, or peeling) of the fuel and hydraulic hoses  |
| Prescribed annual check | Oil leak from the connections or bodies of the fuel and hydraulic hoses<br>Interference, crushing, aging, torsion, or damage (crack, wear, or peeling) of the fuel and hydraulic hoses |

## 25. Replacing Essential Parts Periodically

### ■ List of safety parts

| No. | Safety parts to be replaced periodically                 | Q'ty | Replacement time intervals                                  |
|-----|--|------|---|
| 1   | Fuel hose (fuel tank to water separator)                 | 1    | Earlier of either every 2 years or every 4000 service hours |
| 2   | Fuel hose (water separator to feed pump)                 | 1    |   |
| 3   | Fuel hose (feed pump to fuel filter)                     | 1    |   |
| 4   | Fuel hose (fuel filter to fuel injection pump)           | 1    |   |
| 5   | Fuel hose (fuel filter to fuel tank)                     | 1    |   |
| 6   | Fuel hose (fuel injection pump to fuel filter)           | 1    |   |
| 7   | Fuel hose (fuel injection valve to fuel injection valve) | 2    |   |
| 8   | Fuel hose (fuel injection valve to fuel injection pump)  | 1    |   |
| 9   | Fuel tube cap  | 1    |   |
| 10  | Main pump outlet hose (P1, P2, P3 to C/V)                | 3    |   |

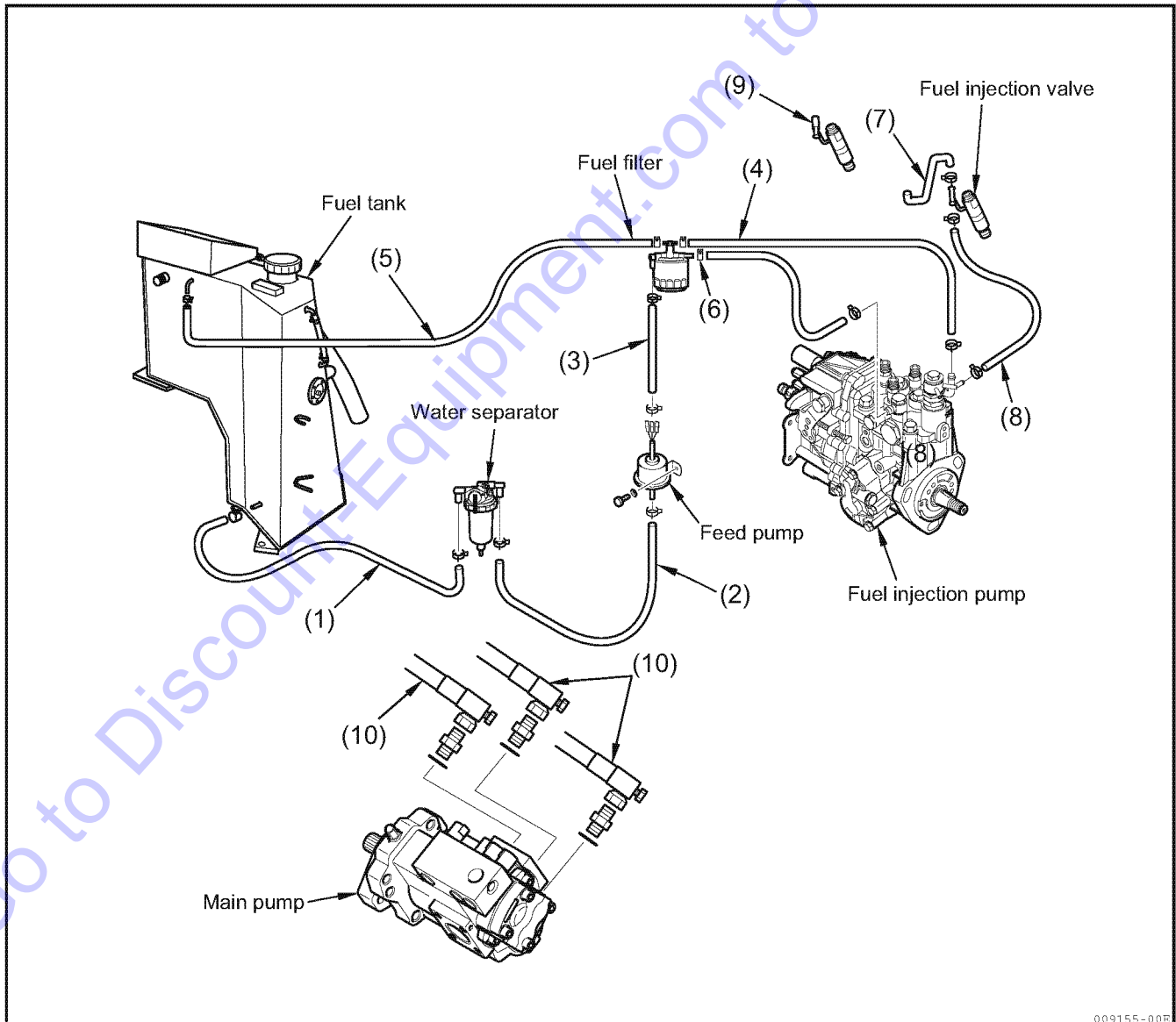

## 26. Maintenance Table

Daily and periodic inspection are important to keep the machine in its best condition. The following is a summary of inspection and servicing items by inspection interval. Periodic inspection intervals vary depending on the use, loads, fuels and lube oils used and handling conditions, and are hard to establish definitively. The following should be treated only as a general standard.

When the time for an inspection approaches, study the relevant pages in the Operation & Maintenance Manual. Keep a record of daily operation and the results of maintenance work.

### 26-1. Table of service time intervals

| Check and service points   | Page |
|--|------|
| <b>■ At first 50 hours (only once after the new machine has started to be used)</b>  |      |
| Replacing the engine oil and the engine oil filter element                           | 3-22 |
| <b>■ At first 100 hours (only once after the new machine has started to be used)</b> |      |
| Replacing the lube oil for the travel reduction gearbox                              | 3-22 |
| <b>■ At first 250 hours (only once after the new machine has started to be used)</b> |      |
| Replacing the hydraulic oil return filter element                                    | 3-22 |
| Cleaning the suction filter element in the hydraulic oil tank                        | 3-22 |
| <b>■ Nonperiodic servicing</b>   |      |
| Checking the rubber track (for rubber track type)                                    | 3-23 |
| Checking and adjusting the rubber track tension (for rubber track type)              | 3-25 |
| Replacing the rubber track (for rubber track type)                                   | 3-28 |
| Checking and adjusting the steel track tension (for steel track type)                | 3-31 |
| Replacing the bucket teeth   | 3-34 |
| Cleaning the inside of the cooling system  | 3-36 |
| <b>■ Checking before start-up</b>  |      |
| Checking and replenishing the cooling water  | 3-40 |
| Checking and replenishing the engine oil   | 3-41 |
| Checking and replenishing the fuel in the fuel tank                                  | 3-42 |
| Checking and replenishing the hydraulic oil in the hydraulic oil tank                | 3-43 |
| Checking and adjusting the fan belt tension  | 3-44 |
| Checking and replenishing the battery electrolyte                                    | 3-45 |
| Greasing   | 3-46 |
| Checking the electrical equipment  | 3-47 |

## 26. Maintenance Table

| Check and service points  | Page            |
|---|-----------------|
| <b>■ Every 50 hours</b>   |                 |
| Greasing the swing gear and the swing bearing                           | 3-48            |
| Draining the water and deposits in the fuel tank                        | 3-48            |
| <b>■ Every 100 hours</b>  |                 |
| (Perform the same maintenance every 50 service hours)                   | 3-49            |
| Cleaning the water separator element                                    | 3-49            |
| <b>■ Every 250 hours</b>  |                 |
| Replacing the engine oil and the engine oil filter element              | 3-50            |
| Checking and cleaning the air cleaner                                   | 3-52            |
| Checking and cleaning the radiator fin                                  | 3-54            |
| Adjusting the governor lever and accelerator device                     | 3-55            |
| Checking and replenishing the lube oil for the travel reduction gearbox | 3-56            |
| <b>■ Every 500 hours</b>  |                 |
| Replacing the fuel filter   | 3-57            |
| Replacing the air cleaner element                                       | 3-59            |
| Replacing the hydraulic oil return filter element                       | 3-60            |
| <b>■ Every 1000 hours</b>   |                 |
| Replacing the lube oil for the travel reduction gearbox                 | 3-61            |
| Replacing the hydraulic oil and cleaning the suction filter element     | 3-62            |
| Checking and adjusting the intake/exhaust valve clearances              | Ask your dealer |
| Checking and adjusting the fuel injection valve                         | Ask your dealer |
| Retightening the cylinder head bolts                                    | Ask your dealer |
| <b>■ Every 2000 hours</b>   |                 |
| Check and replace fuel oil pipe, cooling water pipe                     | Ask your dealer |
| Lapping the intake/exhaust valve  | Ask your dealer |
| Check fuel pump adjust  | Ask your dealer |
| Clean and check the cooling water system                                | Ask your dealer |



### ■ List of periodic inspection and servicing

◇ : Check ○ : Supply ● : Replace □ : Adjust (clean) ■ : Oil & grease

| Check & service items |   | Daily           | Every 50 | Every 100 | Every 250 | Every 500 | Every 1000 hrs |  |
|-----------------------|---|-----------------|----------|-----------|-----------|-----------|----------------|--|
| General               | Check falling off, breakage of parts                              | ◇               |          |           |           |           |                |  |
|                       | Check loosened bolts & nuts, retighten                            | ◇               |          |           |           |           |                |  |
|                       | Check engine condition  | ◇               |          |           |           |           |                |  |
|                       | Clean   | □               |          |           |           |           |                |  |
| Lube oil              | *Swing gear case oil  | Check, resupply |          |           |           | ○         |                |  |
|                       |   | Replace         |          |           | ●1st time |           | ●              |  |
|                       | Travel reduction gear oil   | Check, resupply |          |           |           | ○         |                |  |
|                       |   | Replace         |          |           | ●1st time |           | ●              |  |
|                       | *Transmission oil   | Check, resupply | ◇        |           |           |           |                |  |
|                       |   | Replace         |          |           | ●1st time |           | ●              |  |
|                       | *Differential gear oil  | Check, resupply |          |           | ◇         |           |                |  |
|                       |   | Replace         |          |           | ●1st time |           | ●              |  |
| Hydraulic system      | Hydraulic oil   | Check, resupply | ◇        |           |           |           |                |  |
|                       |   | Replace         |          |           |           |           | ●              |  |
|                       | Clean suction filter  |                 |          |           |           | □1st time | □              |  |
|                       | Replace return filter   |                 |          |           | ●1st time | ●         |                |  |
|                       | Check for abnormality of hydraulic pump                           | ◇               |          |           |           |           |                |  |
| Grease                | Check grease-up positions, grease                                 | ■               |          |           |           |           |                |  |
|                       | Greasing the swing gears and the swing bearings                   |                 | ■        |           |           |           |                |  |
|                       | *Greasing the track gauge change cylinder and the link fulcrum    |                 | ■        |           |           |           |                |  |
| Undercarriage         | Check, adjust track tension                                       | ◇               |          |           |           |           |                |  |
|                       | *Check air pressure, wear, flaw in tyres                          | ◇               |          |           |           |           |                |  |
| Steering equipment    | *Check performance, play of steering lever                        | ◇               |          |           |           |           |                |  |
|                       | Check performance, play of travel lever                           | ◇               |          |           |           |           |                |  |
|                       | *Check performance of speed change lever                          | ◇               |          |           |           |           |                |  |
|                       | *Check performance of forward/reverse pedal                       | ◇               |          |           |           |           |                |  |
|                       | *Check performance, play of steering wheel                        | ◇               |          |           |           |           |                |  |
|                       | *Brake pedal  | Stroke          | ◇        |           |           |           |                |  |
|                       |   | Performance     | ◇        |           |           |           |                |  |
|                       | *Parking brake  | Stroke          | ◇        |           |           |           |                |  |
| Performance           |   | ◇               |          |           |           |           |                |  |
|                       | Check performance of accel. lever                                 | ◇               |          |           |           |           |                |  |
| Electric equipment    | Check front & work lights, horn                                   | ◇               |          |           |           |           |                |  |
|                       | Check hourmeter function  | ◇               |          |           |           |           |                |  |
|                       | Check function of change, oil and pilot lamps                     | ◇               |          |           |           |           |                |  |
|                       | Check wire breakage, short-circuits, loosened terminals retighten | ◇               |          |           |           |           |                |  |
|                       | Check, resupply battery fluid                                     | ◇               |          |           |           |           |                |  |
|                       | Check specific gravity of electrolyte                             |                 |          |           |           |           | □As required   |  |
|                       | Check function of OK monitor                                      | ◇               |          |           |           |           |                |  |

## 26. Maintenance Table

◇ : Check ○ : Supply ● : Replace □ : Adjust (clean) ■ : Oil & grease

| Check & service items       |   | Daily | Every 50      | Every 100 | Every 250 | Every 500 | Every 1000 | Every 2000 hrs    |
|-----------------------------|---|-------|---------------|-----------|-----------|-----------|------------|-------------------|
| Fuel oil                    | Check & supply of oil to the tank                                   | ◇     |               |           |           |           |            |                   |
|                             | Drain the fuel tank   |       | □             |           |           |           |            |                   |
|                             | Clean the oil/water separator                                       |       |               | □         |           |           |            |                   |
|                             | Replace the fuel filter element                                     |       |               |           |           | ●         |            |                   |
| Lube oil                    | Check the quantity of engine oil                                    | ◇     |               |           |           |           |            |                   |
|                             | Replace the engine oil  |       | ●<br>1st time |           | ●         |           |            |                   |
|                             | Replace the engine oil filter element                               |       | ●<br>1st time |           | ●         |           |            |                   |
| Cooling water               | Check & supply of cooling water                                     | ◇     |               |           |           |           |            |                   |
|                             | Clean radiator fins   |       |               |           | □         |           |            |                   |
|                             | Check the fan-belt tension  | ◇ (□) |               |           |           |           |            |                   |
|                             | Replace the cooling water   |       |               |           |           |           | ●          |                   |
|                             | Clean & check the cooling water system                              |       |               |           |           |           |            | ● within two year |
| Rubber hose                 | Check & replace fuel oil pipe, cooling water pipe                   |       |               |           |           |           |            | ●                 |
| Operation system            | Check & adjust governor lever, accelerator                          | ◇     |               |           | □         |           |            |                   |
| Intake system               | Clean air cleaner & replace element                                 |       |               |           | □         | ●         |            |                   |
|                             | *Check turbocharger, adjust   |       |               |           |           |           | □          |                   |
| Cylinder head               | Adjust the intake and exhaust valve clearance                       |       |               |           |           |           | □          |                   |
|                             | Lapping the intake and exhaust valve                                |       |               |           |           |           |            | □                 |
|                             | Retightening the cylinder head bolts                                |       |               |           |           |           | □          |                   |
| Fuel pump & injection valve | Check fuel valve nozzle, clean                                      |       |               |           |           |           | □          |                   |
|                             | Check & adjustment of fuel injection pressure & atomizing condition |       |               |           |           |           | □          |                   |
|                             | Check fuel pump, adjust   |       |               |           |           |           |            | □                 |

\*Applicable to models with the relevant equipment

### Note :

- 1) When machine is used at dusty worksites clean and replace filter element twice or more frequently than specified in the table.
- 2) Execution of periodic inspection and servicing is indispensable to conform the EPA emission control regulations.  
Keep a record of the results.

## 26-2. Service intervals when using the hydraulic breaker

When a hydraulic breaker is used, the hydraulic oil deteriorates earlier than in usual bucket excavating work. Set up the service time intervals as follows:

- Replacing the hydraulic oil return filter element  
Replace the hydraulic oil return filter element on the new machine once after the first 100 to 150 hours. After that ; replace it referring to the chart at right.
- Replacing the hydraulic oil in the hydraulic oil tank  
Replace the hydraulic oil according to the chart at right.

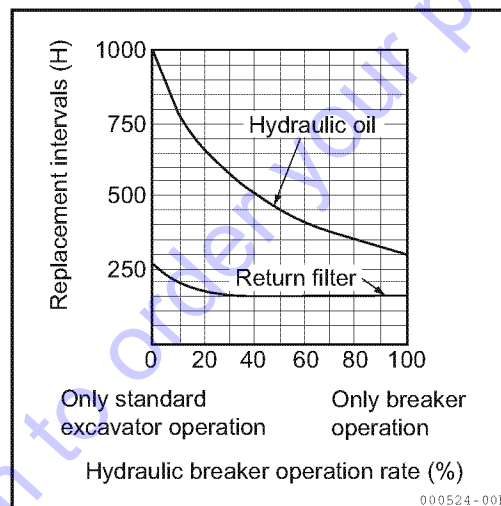

## 27. Procedures for Maintenance

### 27-1. First services

Service only once after the new machine has started to be used, as follows.

#### 27-1-1. At first 50 hours

- Replace the engine oil and the engine oil filter element.  
For these procedures, refer to Section "27-6. Maintenance every 250 service hours".

#### 27-1-2. At first 100 hours

- Replacing the lube oil for the travel reduction gearbox.  
For this procedure, refer to Section "27-8. Maintenance every 1000 service hours".

#### 27-1-3. At first 250 hours

- Replacing the hydraulic oil return filter element.  
For this procedure, refer to Section "27-7. Maintenance every 500 service hours".
- Cleaning the suction filter element in the hydraulic oil tank.  
For this procedure, refer to Section "27-8. Maintenance every 1000 service hours".

## 27-2. Nonperiodic services

### 27-2-1. Checking the rubber track (for rubber track type)

The rubber track in the following condition requires repair or replacement. Ask your dealer to repair or replace it.

#### ■ Height of lugs

- As the lug height "a" is reduced by wear, the tractive force decreases.

If "a" becomes 0.2 in. (5 mm) or less, replace the track with a new one.

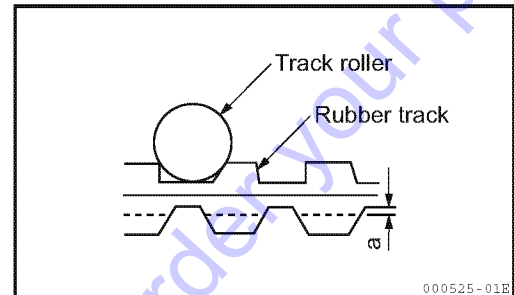

- If two links or more of the steel cord inside the track are exposed due to wear of the lugs, replace the track with a new one.

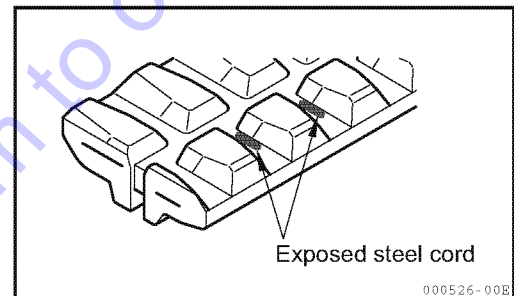

#### ■ Rubber track steel cord breakage

If half or more of either of the steel cords is broken, replace the rubber track with a new one.

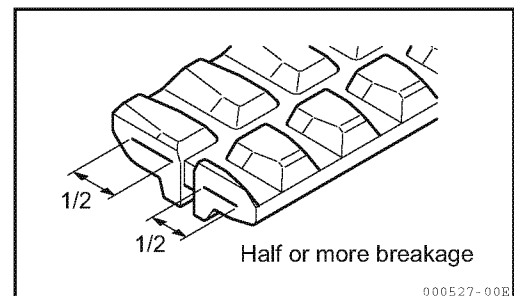

#### ■ Coming off of the core metal of the rubber track

If the core metal of the rubber track comes off even at one place, replace the rubber track with a new one.

#### ■ Rubber track tension

If the rubber track tension is loose even after grease is put in, the grease adjuster may be defective internally. Ask your dealer to repair the grease adjuster.

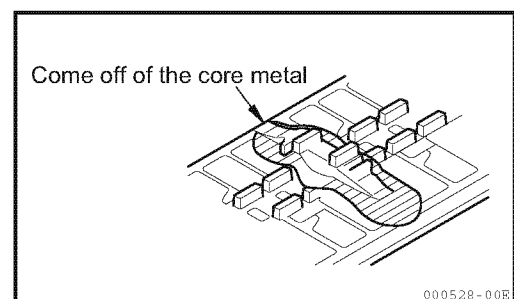

■ **Crack in the rubber track**

If a crack occurs between any lugs of the rubber track, repair if the crack length reaches approximately 2.4 in. (60 mm). If the inside steel cord is exposed even though the crack is small, repair the rubber track immediately.

If the crack length is less than 1.2 in. (30 mm) or the crack depth is less than 0.4 in. (10 mm), you do not need to repair the rubber track.

For a decision on whether the rubber track should be replaced, repaired or should continue to be used, ask your dealer.

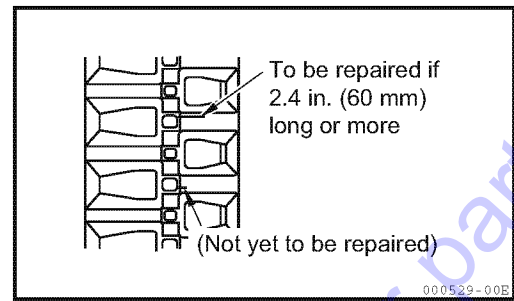

## 27-2-2. Checking and adjusting the rubber track tension (for rubber track type)

**⚠ WARNING**

- When adjusting the rubber track tension while raising the machine, do not support the machine with the implement only.  
The control levers could move or the hydraulic oil could flow out accidentally so that the machine would fall.
- When raising the machine, support it with safety blocks of sufficient strength.  
When the machine is being checked or adjusted by two persons, one must operate the machine in response to signs from the other.

How the rubber track wears out depends on the working conditions and the nature of the ground. Be sure to check the rubber track for wear and tension from time to time. When a new rubber track is mounted, perform the first check after 30 hours operation.

**■ Checking the rubber track tension**

- 1) Move the machine so that the joint (△ mark) on the inside surface of the rubber track should be positioned at the upper center of the track frame.
- 2) Lift the machine with the implement.  
To do this, operate the control lever slowly.
- 3) The tension is proper if the clearance (H in the right figure) between the outside rolling surface of the second track roller from the idler side and the inside surface of the rubber track is within the following range :
  - $H=0.3$  to  $0.5$  in. (8 to 13 mm)

Working with the rubber track loosened will cause the rubber track to come off or the core metal to wear out earlier.

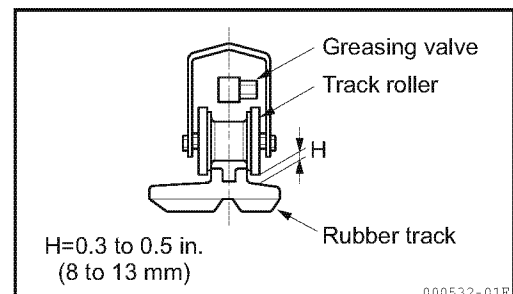
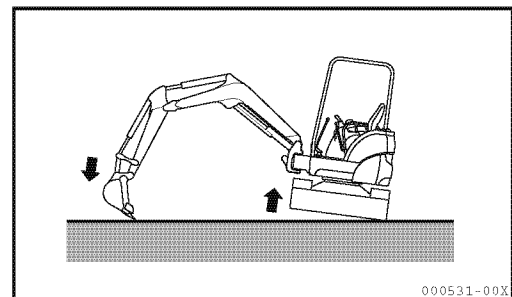
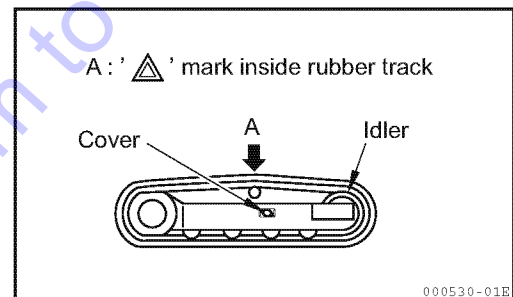

If the tension is improper, adjust it as follows:

■ **Adjusting the rubber track tension**

• **To increase the tension**

Prepare a grease gun.

1) Remove the cover.

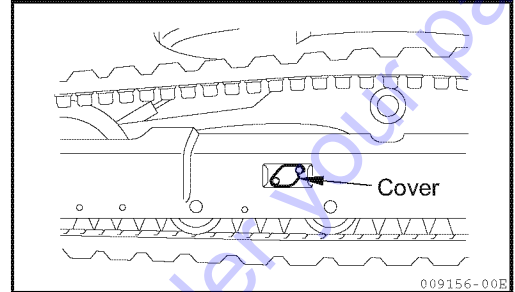

2) Raise the machine using the implement and inject grease through the greasing valve (1) using a grease gun until the rubber track tension is within the specified value of 0.3 to 0.5 in. (8 to 13 mm).

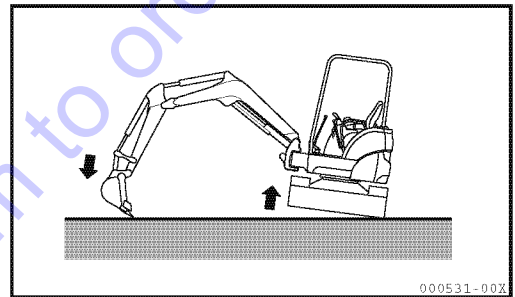

3) To check that the tension is proper, put down the machine and move the machine back and forth slightly.

4) Check the rubber track tension again. If the tension is improper, adjust it again.

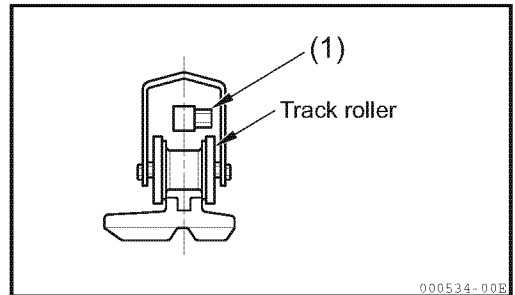

5) Install the cover.

6) The tension is adjustable until the clearance "a" is reduced to 0 in. (0 mm). If the tension is still loose, the rubber track needs repairing due to excessive wear. Contact your dealer and ask for repair.

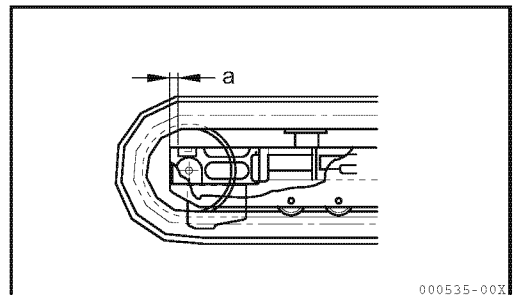

7) If the tension is loose even after grease injection, it is necessary to replace the rubber track or the grease adjuster. Contact your dealer and ask for replacement.



- Loosening the tension

### ⚠ WARNING

- Grease is under high pressure. If the greasing valve (1) is opened suddenly, grease could be ejected or the valve could blow, which could cause bodily injury.
- Do not rely on valve appearance alone to determine whether or not grease has been discharged, but check that by measuring the tension of the rubber track.
- Do not open the greasing valve (1) more than one turn.
- It is very dangerous to discharge the grease by any procedure other than that described below. If the tension of the rubber track cannot be loosened, contact your dealer and ask for repair.

- Remove the cover.
- Raise the machine with the implement and slowly loosen the greasing valve (1) and discharge the grease to adjust the rubber track tension to the specified value of 0.3 to 0.5 in. (8 to 13 mm).
- Never loosen the greasing valve more than one turn.  
(If the grease is not discharged completely, put down the machine and move the machine back and forth slightly.)
- Tighten the greasing valve (1).  
Tightening torque : 36.2 ft•lbf (49.0 N•m)
- To check that the tension is proper, put down the machine and move the machine back and forth slightly.
- Recheck the rubber track tension and readjust it if necessary.
- Completely wipe off the discharged grease with a waste cloth.

### IMPORTANT

The rubber track is not grease-resistant. Completely wipe off the grease because grease will shorten its service life.

- Install the cover.

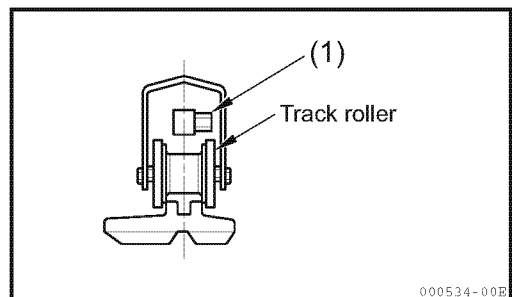
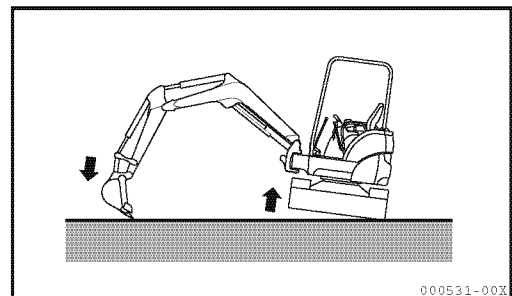
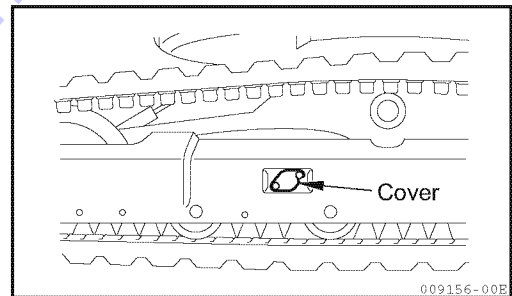

27-2-3. Replacing the rubber track (for rubber track type)

**⚠ WARNING**

- To replace the rubber track with a new one, work with a partner. You must operate the machine in response to signs from your partner.
- Because the rubber track is replaced with the machine in a raised position, there is a danger that the machine may accidentally fall. Do not move any parts other than the rubber track to be replaced in doing the job.
- The high internal pressure of the grease can cause the greasing valve to eject.  
When you loosen the greasing valve (1), do not loosen it more than one turn.  
At this point, do not loosen any parts other than the greasing valve (1). Also, do not turn your face toward the greasing valve (1).
- If the tension of the rubber track cannot be loosened by the procedure described here, ask your dealer to repair the rubber track.

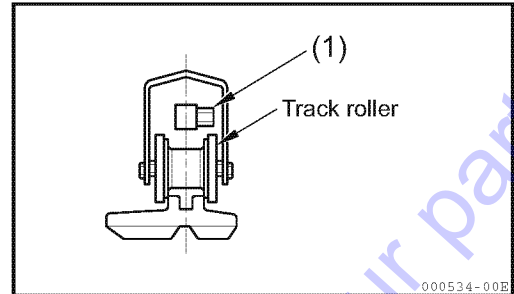

■ Replacing the rubber track

- Prepare a grease gun and steel pipes.

## ■ Removing the rubber track

### ⚠ WARNING

- It is very dangerous to discharge the grease by any procedure other than that described below.
- If the tension of the rubber track cannot be properly adjusted, ask your dealer to repair or replace the rubber track.
- When removing the rubber track, make sure that all of the grease has been completely discharged before turning the sprocket.

- 1) Raise the machine with the implement.  
To do this, slowly operate the control lever.

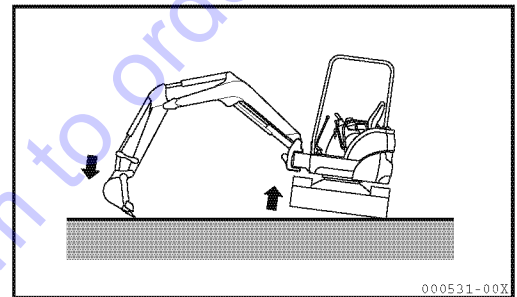

- 2) Loosen the greasing valve (1) little by little to discharge the grease.

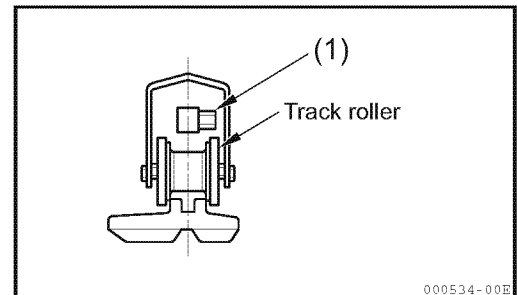

- 3) Do not loosen the greasing valve (1) more than one turn.

- 4) Insert the steel pipes into the rubber track and turn the sprocket in the reverse direction. When the rubber track is separated from the idler by the steel pipes, slide the rubber track off.

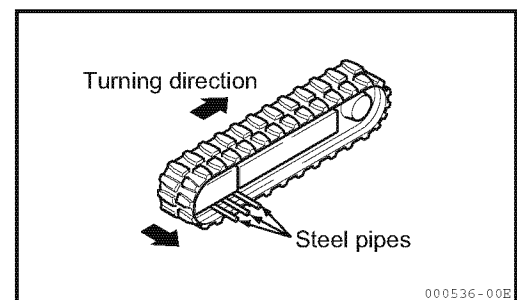

### ■ Installing the rubber track

- 1) Raise the machine with the implement.  
To do this, slowly operate the control lever.
- 2) Engage the rubber track with the sprocket, and put the rubber track on the idler.
- 3) Rotate the sprocket in the reverse direction to push the rubber track in and stop rotating it.
- 4) Insert a steel pipe into the rubber track, and rotate the sprocket again to put the rubber track on the idler securely.
- 5) Stop rotating the sprocket, and check that the rubber track is securely put on both the sprocket and the idler.
- 6) Adjust the rubber track tension, referring to Section "27-2-2. Checking and adjusting the rubber track tension (for rubber track type)".
- 7) Check that the rubber track is fully engaged with both the sprocket and the idler and that the rubber track tension is sufficient, then place the machine down on the ground.

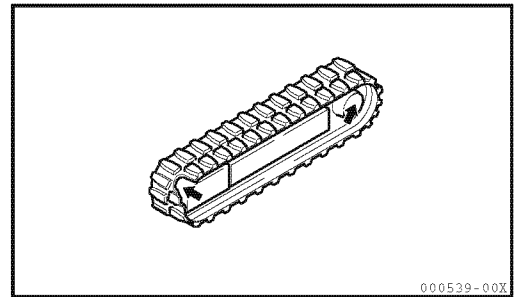
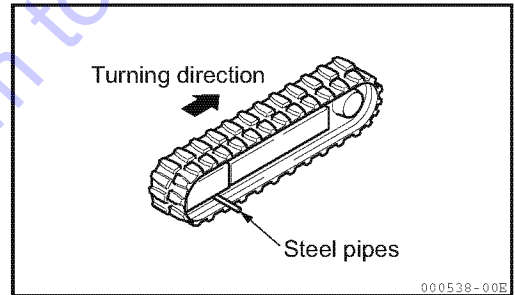
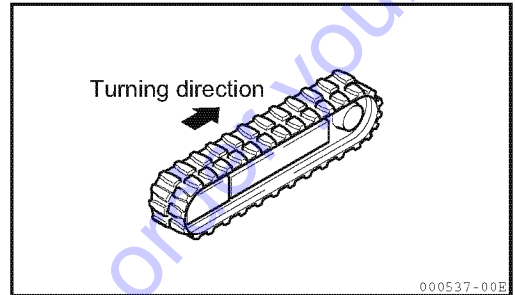
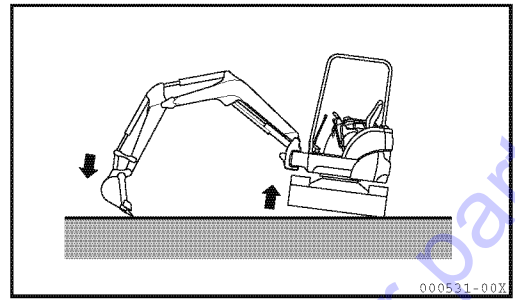

## 27-2-4. Checking and adjusting the steel track tension (for steel track type)

**⚠ WARNING**

- When adjusting the steel track tension while raising the machine, do not support the machine with the implement only. If the control levers should move or the hydraulic oil should flow out, the machine could fall.
- When raising the machine, support it with safety blocks of sufficient strength.
- When the machine is being checked or adjusted by two persons, one must operate the machine in response the signs from the other.

How the pins and bushes on the undercarriage will wear down depends on the working conditions and the ground conditions. Check the steel track tension from time to time to keep proper tension.

Check and adjust the steel track tension under the same conditions as in operation (for example, mud clogged condition in case of working in muddy ground.)

**■ Checking the steel track**

1) Raise the machine with the implement. To do this, operate the control lever slowly.

2) At a position that will be safe even if the machine should fall, measure the clearance between the bottom of the track frame and the upper surface of the shoe plate.

The tension is proper if the clearance is 4.9 to 5.3 in. (125 to 135 mm).

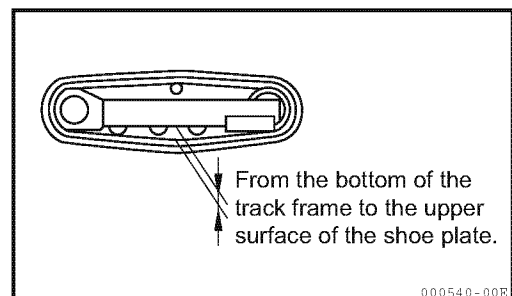
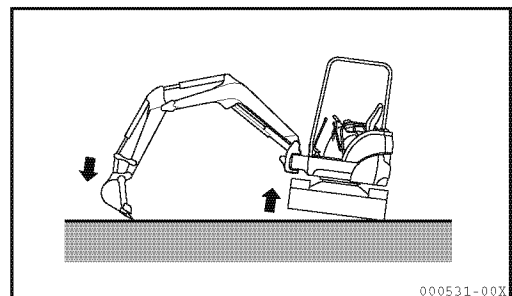

If the tension is improper, adjust it as follows:

■ **Adjusting the steel track tension**

• **To increase the tension**

Prepare a grease gun.

1) Remove the cover.

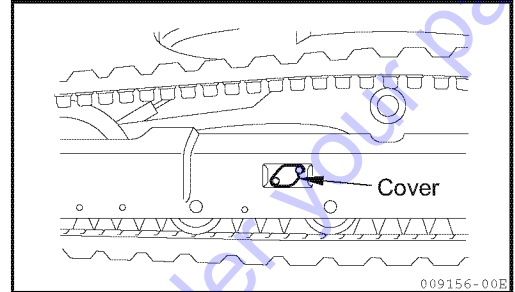

2) Raise the machine using the implement and inject grease through the greasing valve (1) using a grease gun until the steel track tension is within the specified value of 4.9 to 5.3 in. (125 to 135 mm).

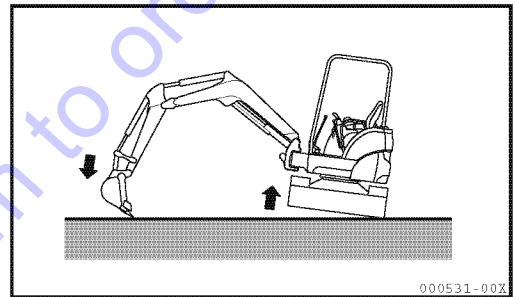

3) To check that the tension is proper, put down the machine and move the machine back and forth slightly.

4) Check the steel track tension again. If the tension is improper, adjust it again.

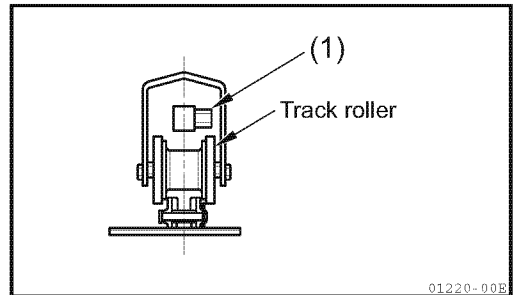

5) Install the cover.

6) The tension can be adjusted until the clearance "a" is reduced to 0 in. (0 mm). If the tension is still loose after adjustment, the pin and the bush should be reversed or replaced because they are worn excessively. Ask your dealer to repair the track.

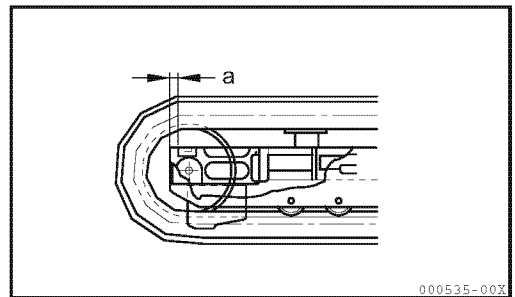

- Loosening the tension

### ⚠ WARNING

- Grease is under high pressure. If the greasing valve (1) is opened suddenly, grease could be ejected or the valve could blow, which could cause bodily injury.
- Do not rely on valve appearance alone to determine whether or not grease has been discharged, but check that by measuring the tension of the rubber track.
- Do not open the greasing valve (1) more than one turn.
- It is very dangerous to discharge the grease by any procedure other than that described below. If the tension of the rubber track cannot be loosened, contact your dealer and ask for repair.

- Remove the cover.
- Raise the machine with the implement and slowly loosen the greasing valve (1) and discharge the grease to adjust the steel track tension to the specified value of 4.9 to 5.3 in. (125 to 135 mm).
- Never loosen the greasing valve more than one turn. (If the grease is not discharged completely, put down the machine and move the machine back and forth slightly.)
- Tighten the greasing valve (1).  
Tightening torque : 36.2 ft•lbf (49.0 N•m)
- To check that the tension is proper, put down the machine and move the machine back and forth slightly.
- Recheck the steel track tension and readjust it if necessary.
- Completely wipe off the discharged grease with a waste cloth.
- Install the cover.

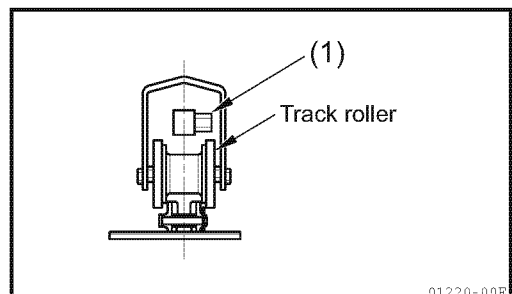
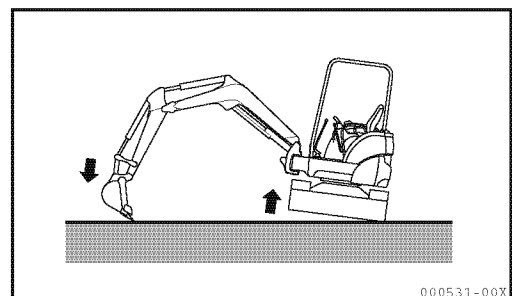
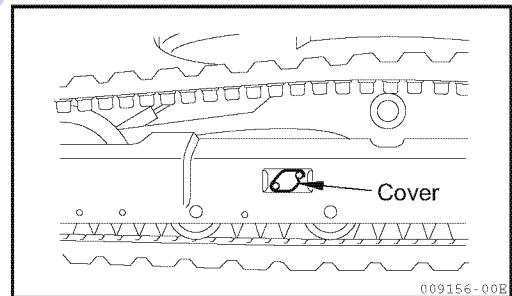

### 27-2-5. Replacing the bucket teeth

When the bucket teeth are worn, replace them in accordance with the following procedure:

## ⚠ WARNING

- When replacing the bucket teeth, be careful not to move the implement by mistake for safety. Place the implement in a stable position, stop the engine, and securely lock the lock levers.

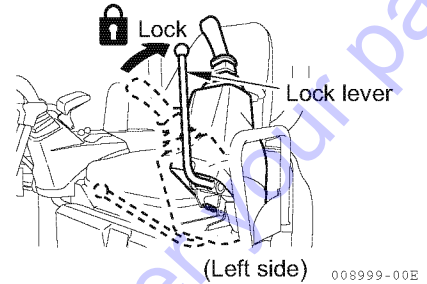

### ■ Replacing the point type teeth

Replace the point type teeth before they are worn to the adapter.

- Place the bucket so that the bottom is level.
- Removing a point:

- 1) Strike out the locking pin (3), which connects the point type tooth (1) to the adapter (4), with a hammer and a tool applied to the pin for removal of it.

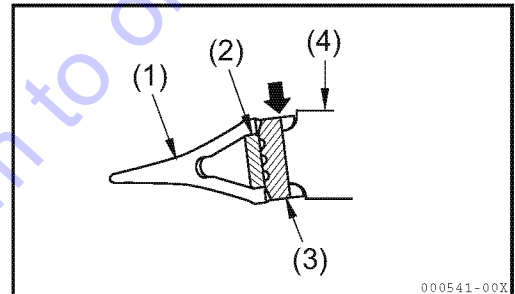

### IMPORTANT

**Do not strike the tool toward the rubber pin lock (2). Otherwise the rubber pin lock may be damaged. Strike the tool toward the back of locking pin (3).**

- 2) Remove the rubber pin lock (2).
- 3) Check the removed rubber pin lock (2) and locking pin (3).

Replace the damaged rubber pin lock and locking pin. Using the following rubber pin lock and locking pin may cause the points to come off during operation. So, replace them with new ones.

- There is a crack in the rubber of the pin lock and the roller may come off.
- When the roller is pressed with a finger, it sinks in the rubber.
- The locking pin is too short.

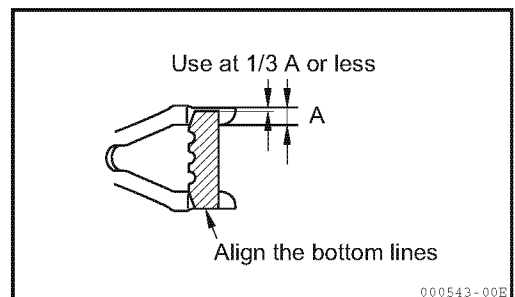
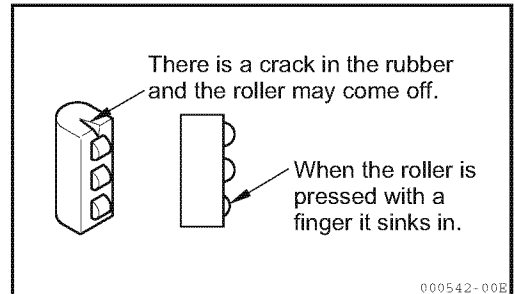



- 4) Clean the surface of adapter (4) with a putty knife to remove the hard mud on it.
- 5) Press-fit the rubber pin lock (2) into the hole in adapter (4) by hand or by a hammer.

**IMPORTANT**

**Do not let the rubber pin lock come out of the adapter surface.**

- 6) Fit the point (1) onto adapter (4) and check that the rear surface of the pin bore in the point is aligned with the rear surface of the pin bore in the adapter when the point is pressed strongly.

**IMPORTANT**

**If the rear surface of the pin (3) in the pin bore in the point (1) is in front of the rear surface of the pin bore in the adapter (4), do not strike the locking pin (3) in the bores.**

- 7) Press fit the locking pin (3) in the pin bore in the point (1) and strike the pin so that the upper end of the locking pin should be aligned with the surface of the point.

- Replace the rubber pin lock and the locking pin with new ones when replacing the point to prevent it from coming off.

**■ Replacing the side cutter**

Delay in replacing the side cutter could damage the bucket. Replace the side cutter before the bucket is damaged.

Tightening torque :

195.3 to 224.2 ft•lbf (264.8 to 304.0 N•m)

Adhesive : Loctite 262

- Replace the bolts, nuts and spring washers when replacing the side cutter.

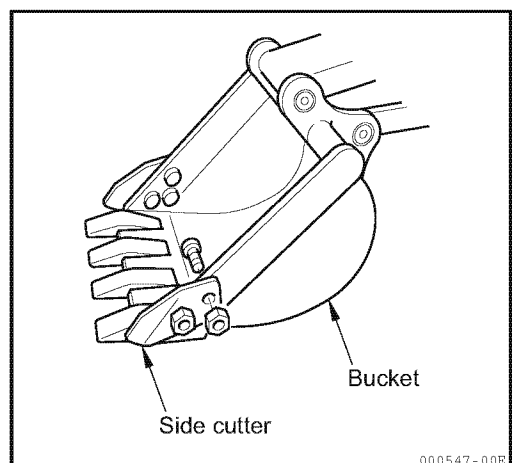
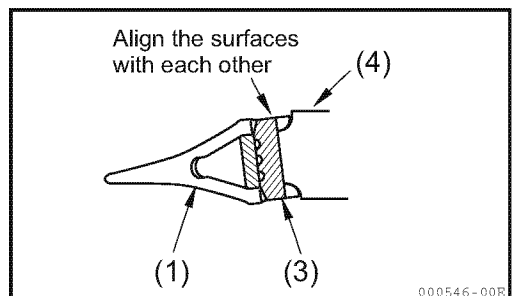
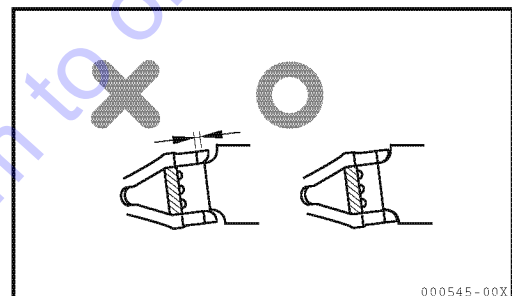
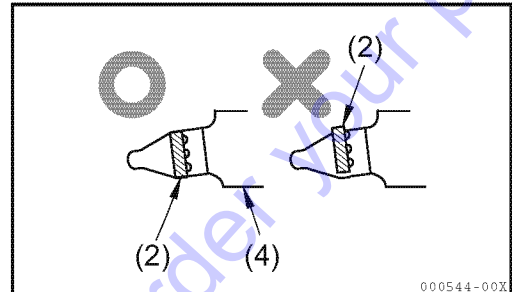

27-2-6. Cleaning the inside of the cooling system

**⚠ WARNING**

- The cooling water is very hot immediately after the engine has stopped. Discharging the cooling water immediately after the engine has stopped may cause burns. Start cleaning the inside of the cooling system after the engine has cooled down sufficiently.
- Stepping into the area behind the machine to clean the inside of the cooling system while the engine is running is very dangerous, because you may not be visible from the operator's seat and the machine could start moving.  
Also, with the engine hood being opened, contacting the radiator fan or fan belt could result in serious bodily injury.  
Never step into the area behind the machine while the engine is running.
- Do not remove the radiator cap while the water temperature in the radiator is high. Hot water may spout from the radiator.  
When you do remove the radiator cap after the water has cooled down, slowly turn the radiator cap to release the internal pressure before removing it.

Clean the inside of the cooling system and replace the anti-freeze according to the following table.

| Anti-freeze type  | Cleaning inside of cooling system and replacing anti-freeze       |
|---|---|
| YANMAR Super Long-Life Coolant (LLC anti-freeze)<br>(All season type for anticorrosion) | Every 2 years (autumn)  |
| LLC anti-freeze (all season type)   | Every 1 year (autumn)   |
| AF-PT anti-freeze (winter, one season type)   | Every 6 months (spring, autumn)<br>Add anti-freeze only in autumn |
| No anti-freeze  | Every 6 months  |

Park the machine on level ground to clean or replace the cooling water.

The YANMAR Long-Life Coolant has anticorrosive effect as well as anti-freeze effect.

Though the mixing ratio of an anti-freeze to water differs with air temperature, at least 30% of anti-freeze by volume is required to obtain anticorrosive effect.

Determine the mixing ratio of the anti-freeze to water on the basis of the lowest past temperature, referring to the ratio table below.

Actually set the temperature 18°F (10°C) lower than the lowest temperature.

Table of mixing ratio of anti-freeze to water

| Lowest temperature   |                       | °F<br>(°C)  | 23<br>(-5)    | 14<br>(-10)   | 5<br>(-15)    | -4<br>(-20)   | -13<br>(-25)  | -22<br>(-30)  | -31<br>(-35)  | -40<br>(-40)  |
|----------------------|-----------------------|-------------|---------------|---------------|---------------|---------------|---------------|---------------|---------------|---------------|
| ViO45-5B<br>ViO55-5B | Amount of anti-freeze | Qts.<br>(L) | 1.06<br>(1.0) | 1.80<br>(1.7) | 2.11<br>(2.0) | 2.43<br>(2.3) | 2.85<br>(2.7) | 3.17<br>(3.0) | 3.59<br>(3.4) | 3.91<br>(3.7) |
|                      | Amount of water       | Qts.<br>(L) | 6.02<br>(5.7) | 5.29<br>(5.0) | 4.97<br>(4.7) | 4.65<br>(4.4) | 4.23<br>(4.0) | 3.91<br>(3.7) | 3.49<br>(3.3) | 3.17<br>(3.0) |

**Note :**

At the delivery from the factory, water and anti-freeze are mixed in the ratio shown above for the -31°F (-35°C) temperature.

 **WARNING**

Keep sources of ignition away from the antifreeze because it is flammable.

Use soft water or distilled water. If you obtain water from a river, a well or a small water-supply system, consult your dealer.

Use a densitometer to control the mixing ratio.

 **WARNING**

When removing the drain plug, be careful that the anti-freeze does not contact your eyes or skin.

### ■ How to clean the inside of the cooling water system

- Container for cooling water  
Capacity : ViO45-5B : 6.34 Qts. (6.0 L) or more  
ViO55-5B : 8.46 Qts. (8.0 L) or more
  - Hose for supplying the water
- 1) Swing the upper structure so that the drain plug is positioned in the middle of the right and left tracks.
  - 2) Remove the bottom cover and put the container for cooling water under the drain plug.
  - 3) Open the engine hood B, slowly remove the radiator cap, pour in the washing agent and mount the cap.

### IMPORTANT

**Washing methods vary depending on the manufacturer of the washing agent.**

**Follow the instructions of the manufacturer.**

- 4) Start the engine until the water temperature rises to 176 °F (80°C) or more and idle the engine for 10 to 15 minutes. Then stop the engine.
- 5) After the engine has cooled down, slowly loosen the drain plug to drain the cooling water and remove the radiator cap.  
When the drain plug is removed, the cooling water in the radiator is completely drained.
- 6) After the water is completely drained, reinstall the drain plug and pour tap water through the water supply port of the radiator.
- 7) When the system is filled with water, remove the drain plug, idle the engine and wash the cooling water system with running water until clean water comes out.  
While washing with running water, always keep the water system filled with water by adjusting the amount of water to be drained out and poured in.  
Hold the water supply hose securely during washing with running water so that the hose should not come off from the water supply port of the radiator.

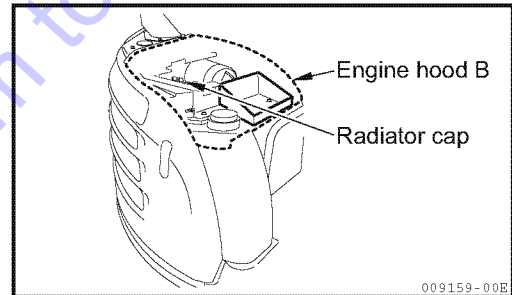
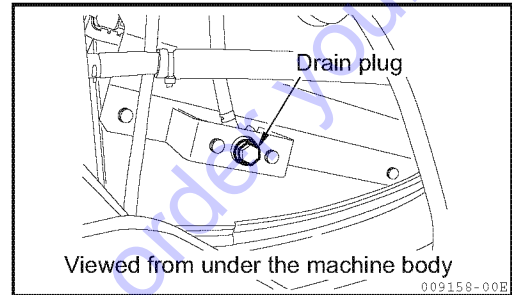
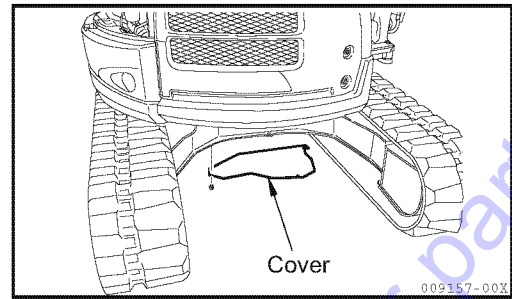

- 8) After washing with running water, stop the engine, stop pouring water, drain water completely and then securely reinstall the drain plug and the bottom cover.
- 9) Pour water mixed with anti-freeze through the water supply port of the radiator to fill it up.
- 10) To release air, idle the engine for 5 to 6 minutes and then run the engine without load at high speed for 5 to 6 minutes. (While running the engine, keep the radiator cap removed.)
- 11) Approximately 5 minutes after stopping the engine, pour water mixed with anti-freeze up to the water supply port of the radiator, and install and tighten the cap.
- 12) Open the engine hood rear cover, drain the cooling water from the sub-tank (1), wash the inside of the sub-tank (1) and pour water mixed with anti-freeze up to the "FULL" level.

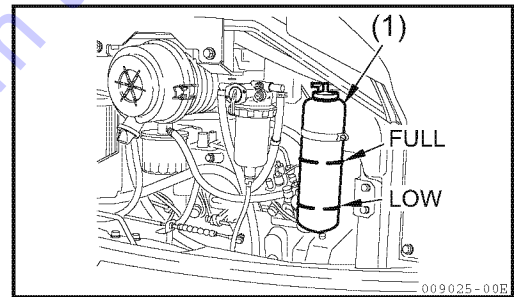

**27-3. Checking before start-up**

Check the items described here before starting the engine first in a day.

**27-3-1. Checking and replenishing the cooling water**

**⚠ WARNING**

**Normally do not open the radiator cap.  
Check the cooling water in the sub-tank when the  
engine is cool.**

1) Open the engine hood rear cover to check to see that the cooling water level is between the FULL and LOW marks on the sub-tank (1) (illustrated in the right figure). If the cooling water level is low, add cooling water to the FULL mark through the port of the sub-tank (1). For the cooling water to be used, refer to Section "23. Fueling, Oiling and Greasing Based on Temperature Range".

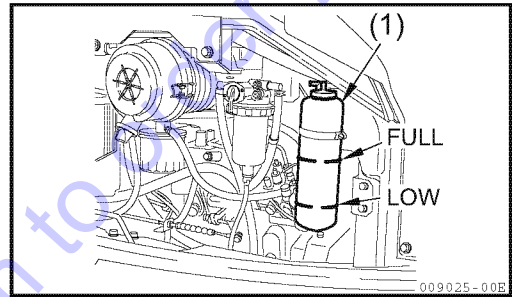

- 2) Securely close the cap after replenishing.
- 3) If the sub-tank is empty, check the sub-tank for leaks and then check the cooling water level in the radiator. If the cooling water is insufficient, refill the radiator and then the sub-tank with cooling water.
- 4) If the cooling water level is proper, close the engine hood rear cover.

## 27-3-2. Checking and replenishing the engine oil

**⚠ WARNING**

- At operating temperature, the oil and dipstick areas are hot.
- Do not allow hot oil or components to contact the skin to prevent bodily injury such as a burn. Check oil level and refill oil after engine has cooled down sufficiently.

- 1) Open the engine hood rear cover.
- 2) Pull out the oil dipstick (G) and wipe oil off it with a cloth.
- 3) Insert the oil dipstick (G) fully again and pull it out.
- 4) Check that the oil level is above the midpoint between the upper and lower limit marks (H and L), which is a proper level.  
Open the cap of the oil supply port (F) and replenish oil if the oil level is lower than the midpoint.  
See Section "23. Fueling, Oiling and Greasing Based on Temperature Range" for the engine oil to be used.
- 5) If the engine oil level is higher than the H mark, drain the excessive engine oil through the drain plug (P), and check the engine oil level again.
- 6) If the engine oil level is proper, securely close the port cap and close the engine hood rear cover.

**Note :**

When checking the engine oil level after the engine has been run, stop the engine and wait for 15 minutes at least before checking.

If the machine is inclined, make it horizontal before checking the engine oil level.

Do not discard the excessive engine oil onto the ground or the road.

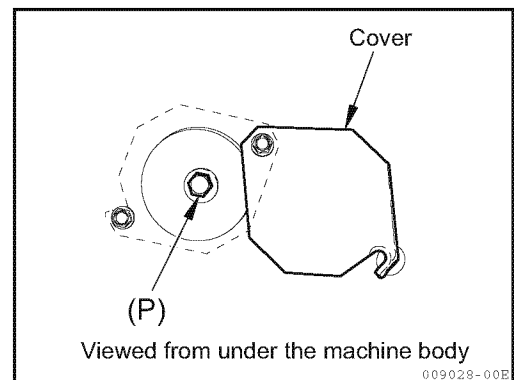
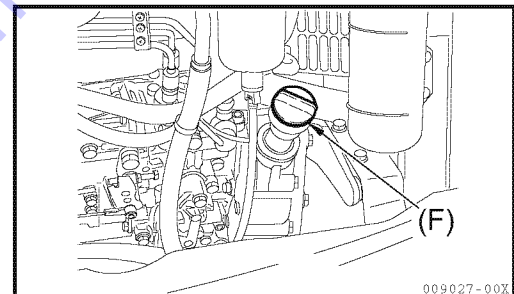
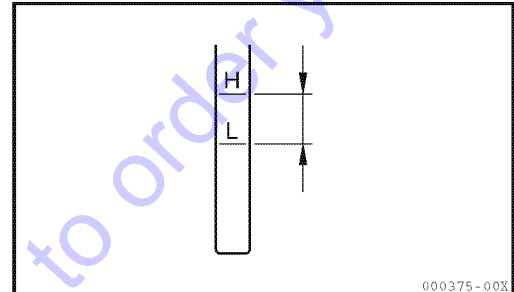
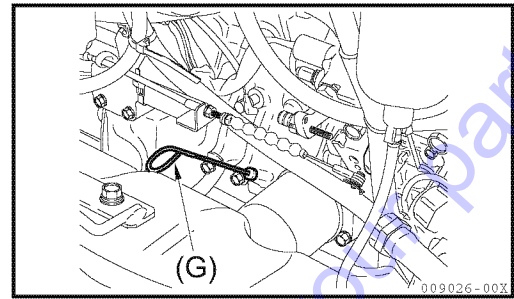

27-3-3. Checking and replenishing the fuel in the fuel tank

**⚠ WARNING**

Be careful not to overfill the fuel tank because it could cause a fire. If the fuel tank is overfilled, completely wipe off the spilled fuel.

**⚠ CAUTION**

- Do not remove the strainer from the fuel supply port of the fuel tank when supplying fuel.
- Be careful not to allow any water that may be in the fuel container or dirt on the refueling equipment to enter the fuel tank.

1) Turn the starter switch to the "ON" position, and check the fuel level with the fuel gauge. Open the engine hood B and pour the fuel through the fuel supply port while checking the level gauge.

When the fuel meter pointer indicates to "E", approximately 3.1 Gals. (12 L) of fuel is left in the tank.

Capacity...16.9 Gals. (64 L)

See Section "23. Fueling, Oiling and Greasing Based on Temperature Range" for the fuel to be used.

2) After refueling, securely retighten the fuel port cap and close the engine hood B.

**Note :**

If the breather hole (1) in the cap is clogged, the pressure in the tank may decrease and the fuel may not be delivered adequately to the engine. Clean the engine breather hole from time to time.

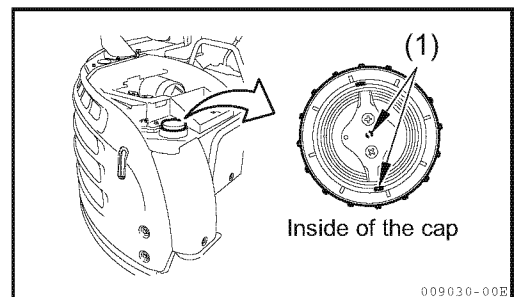
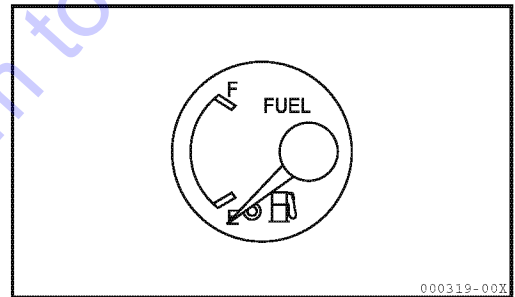



## 27-3-4. Checking and replenishing the hydraulic oil in the hydraulic oil tank

**⚠ WARNING**

When removing the plug of the oil supply port, slowly loosen it to release the internal pressure from the tank, or the oil will spout from the tank.

- 1) Park the machine as illustrated in the right figure. If the machine is not in the posture in the right figure, start the engine, retract the bucket and arm cylinders to their stroke ends at low speed, lower the boom until the bucket teeth is put on the ground, lower the blade to the ground, and stop the engine.
- 2) Check the oil level with the oil level gauge on the left side of the machine. The oil level must be between the upper and lower limit marks on the gauge.

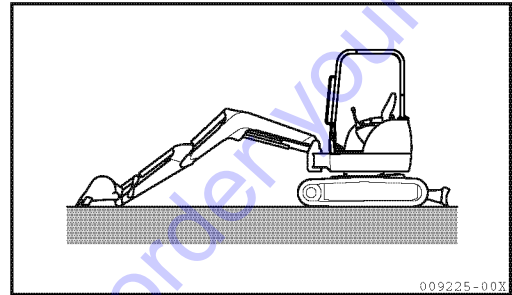

009225-00X

**IMPORTANT**

Do not replenish hydraulic oil above the upper limit mark on the oil level gauge. An excessive amount of hydraulic oil may damage the hydraulic system by placing stress on its components, causing a dangerous high-pressure leak.

- 3) Open the engine hood rear cover to replenish oil from the oil supply port (F) if the oil level is below the lower limit.

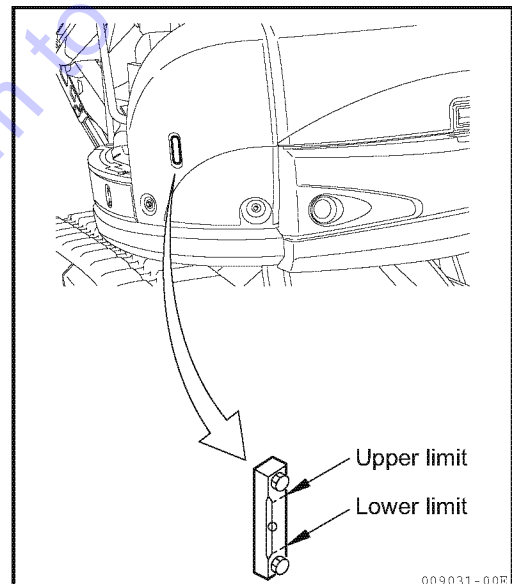

009031-00E

For the quality of the oil to be used, refer to Section "23. Fueling, Oiling and Greasing Based on Temperature Range".

**Note :**

As the oil level differs with the oil temperature, check the oil level by referring to the following guidelines:

- Before start-up : Near the middle of the oil level gauge [oil temperature 50 to 86°F (10 to 30°C)]
- During normal operation : Near the upper limit of the oil level gauge [oil temperature 122 to 176°F (50 to 80°C)]

27-3-5. Checking and adjusting the fan belt tension

**⚠ WARNING**

- Stop the engine, take out the starter switch key, and attach the "SERVICING IN PROGRESS" tag to a control lever.
- The fan belt is hot immediately after the engine is stopped.  
Do not adjust the fan belt tension immediately after stopping the engine.
- Adjust the fan belt tension after all parts of the engine have fully cooled down.

■ **Checking the fan belt tension**

- 1) Open the engine hood rear cover.
- 2) Press down fan belt between the crankshaft pulley (1) and the generator pulley (2) with a finger to check the generator belt tension.  
Pressing load : Approximately 22.1 lbs. (10 kgf)  
Adequate slack : 0.39 to 0.59 in. (10 to 15 mm)
- 3) Adjust the tension if necessary.
- 4) When the tension is proper, close the engine hood rear cover.

■ **Adjusting the fan belt tension**

- 1) Open the engine hood (3).
- 2) Loosen the generator (4) mounting bolts (5).
- 3) Loosen the adjuster's locknut (6).
- 4) Move the generator (4) by turning the adjuster bolt (7) to the right side (clockwise) so that the fan belt (8) tension is slacked approximately 10 to 15mm (Pressing load: 10kgf (98.1 N.m)).
- 5) Retighten the mounting bolts (5) to secure the generator (4).
- 6) Tighten the adjuster bolt's (7) locknut (6).
- 7) Check the pulleys, the V-groove, and the fan belt (8) for damage, and check to see that the fan belt (8) does not touch the bottom of the V-groove.
- 8) If the fan belt (8) cannot be adjusted since it has lost its elasticity or if it is damaged or cracked, replace the fan belt (8) with a new one.

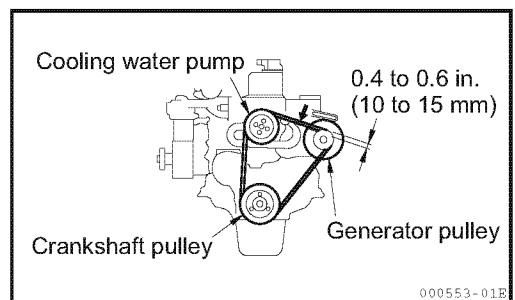
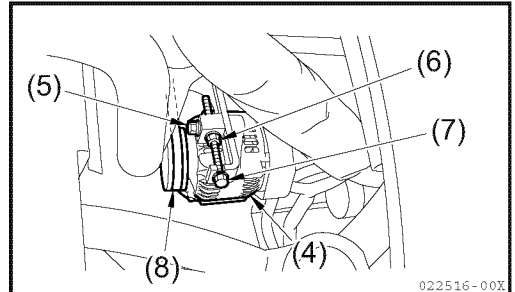
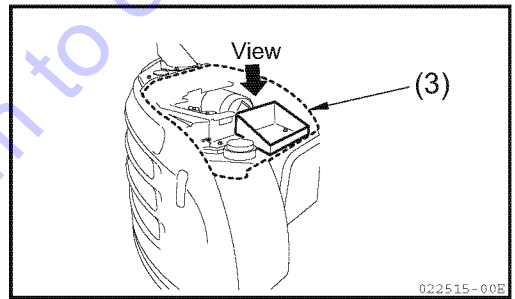
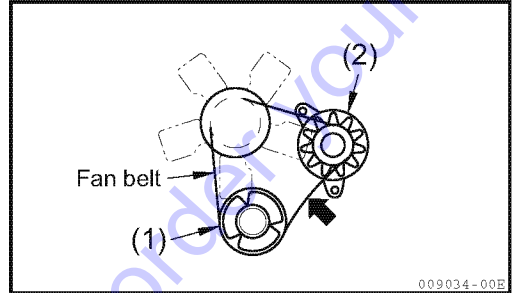
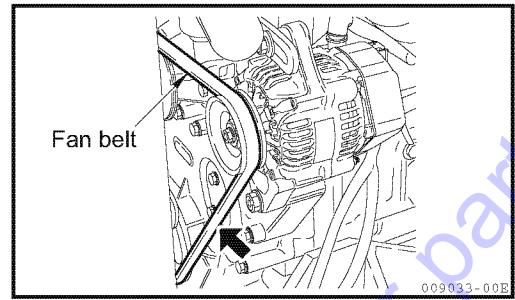

[Fan belt size] (Inch)

|          | Model    | Size  |
|----------|----------|-------|
| Fan belt | ViO45-5B | A37.5 |
|          | ViO55-5B | A37.5 |

27-3-6. Checking and replenishing the battery electrolyte

**⚠ DANGER**

- The battery generates flammable gas and can cause a fire and an explosion.  
Keep sparks, flames and lit cigarettes away from the battery.
- Battery electrolyte is strong acid. To avoid serious injury, do not allow the electrolyte to contact your skin or splash into your eyes.
- Always wear safety goggles and protective clothing, when adding electrolyte.
- Do not use the machine with the battery which is short of battery electrolyte. The shortage of battery electrolyte not only will reduce the life of the battery but also could cause an explosion.

- 1) Open the engine hood rear cover to check the electrolyte level. The level must be between the upper and lower level marks.
- 2) If the electrolyte level is lower than the lower level mark, replenish it.

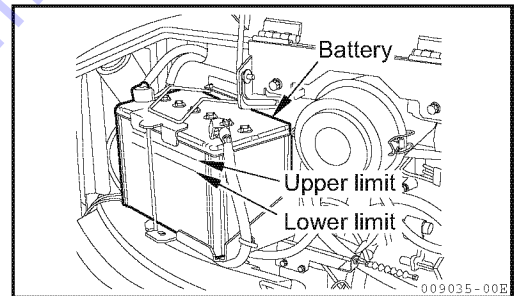

■ Greasing

**IMPORTANT**

Grease the fittings thoroughly after washing the machine or after operation in rain, on soft ground, or in muddy water.

- 1) Put the bucket and the blade on the ground and stop the engine.
- 2) Clean the grease nipples indicated with the arrows in the right figures and grease them using a grease gun.
- 3) After greasing, wipe off the excessive grease with waste cloth or the like.

Refer to Section "14-14-10. Maintenance" for the quick coupler.

■ Implement

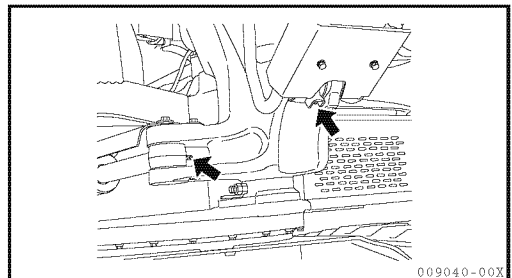
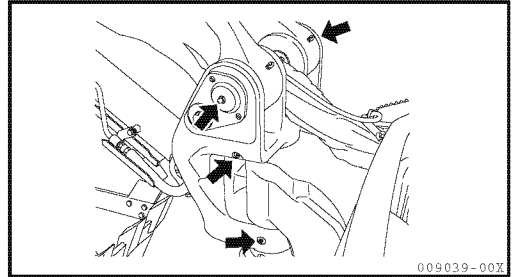
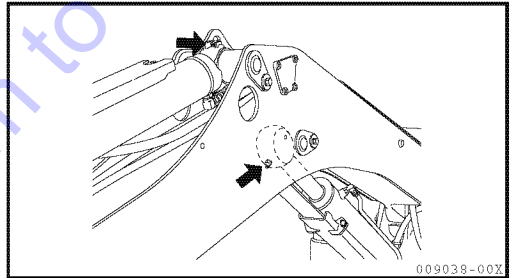
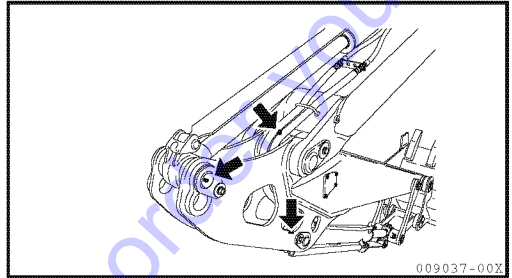
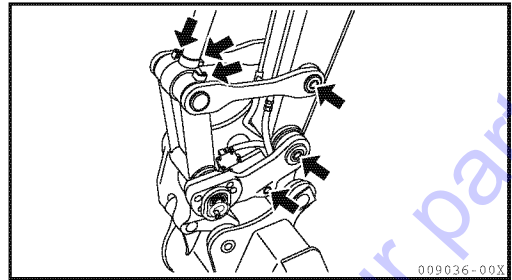

■ Blade

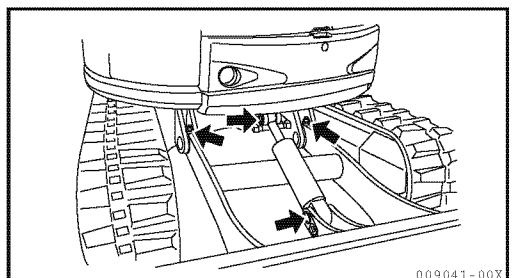

### 27-3-7. Checking the electrical equipment

#### CAUTION

**If a fuse blows out frequently, contact your dealer for assistance.**

Check fuses for damage, wiring for poor connections or short circuits, and battery terminals for corrosion or loose fits. Take corrective action.

Check the following items after the starter switch is turned to the "ON" position.

- 1) Check the monitor functions
  - Check the fuel gauge, the water temp. meter and the hourmeter functions.
  - Check engine oil pressure alarm lamp, battery charge alarm lamp and water temperature alarm lamp for lighting.
  
- 2) Check that all switches function correctly and lamps light correctly.
  - Check the headlight and the boom light.
  - Check the wiper function. (for cabin)
  - Check the room lamp for lighting. (for cabin)
  - Check the heater function. (for cabin)
  
- 3) Check the travel alarm function.
  - To check the travel alarm function, push or pull the travel levers after the lock levers are unlocked.

**27-4. Maintenance every 50 service hours**

**27-4-1. Greasing the swing gear and the swing bearing**

**⚠ WARNING**

**Do not swing the upperstructure while greasing.  
Swing the upperstructure after each stage of greasing is completed to avoid serious bodily injury.**

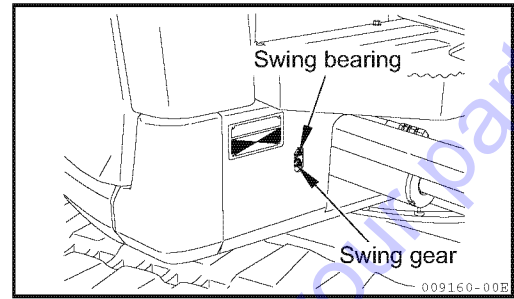

- 1) Grease the swing gear and bearing through the grease nipples indicated with the arrows in the right figure, using a grease gun.
- 2) Swing the upperstructure little by little to grease them until the upperstructure makes a full turn.

**27-4-2. Draining the water and deposits in the fuel tank**

**⚠ WARNING**

**Keep sparks, flames and lit cigarettes away.**

**■ Things to prepare**

- Container for fuel waste
- 1) Swing the upperstructure so that the drain cock under the fuel tank is positioned in the middle of the right and left tracks.
  - 2) Remove the bottom cover and put the container for fuel waste under the drain cock.
  - 3) Remove the drain plug to drain the water and dirt deposits in the fuel tank.  
Take care that the fuel does not splash your body.
  - 4) When clean fuel starts coming out, securely reinstall the drain plug and the bottom cover.

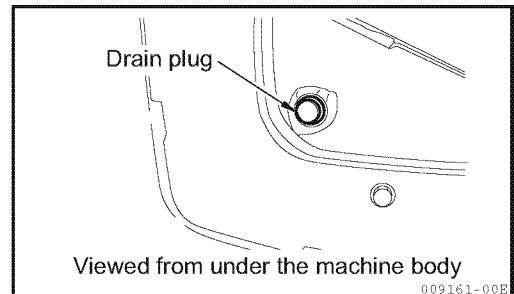
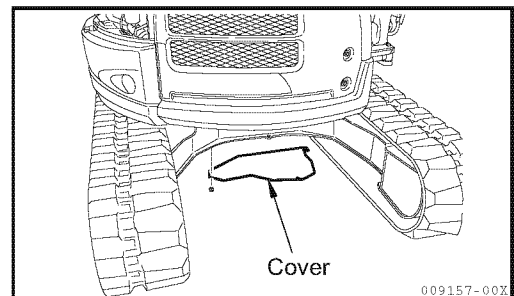

## 27-5. Maintenance every 100 service hours

Perform the same maintenance every 50 service hours.

### 27-5-1. Cleaning the water separator element

#### **⚠ WARNING**

- Keep sparks, flames and lit cigarettes away.
- At the operating temperature, the engine components are hot and can cause a burn.
- Disconnect the ground of the battery and clean the element after the engine has cooled sufficiently.
- Fuel oil leaked or spilled onto hot surfaces or electrical components could cause a fire.
- Drain the fuel from the water separator into a container before removing the water separator retainer ring.

#### ■ Things to prepare

- Container for fuel waste
- 1) Open the engine hood.
  - 2) Place the container for fuel waste under the water separator.
  - 3) After setting the water separator cock to the closed position, loosen the retainer ring to remove the cup and drain the water from the cup.  
Do not lose the red ring in the cup.
  - 4) Remove the element and clean it and the inside of the cup, using light oil or a washing agent.
  - 5) Check the O-ring and if it is damaged or deformed, replace it with a new one.
  - 6) Install the element and the cup and turn the cock to the open position.
  - 7) Close the engine hood.

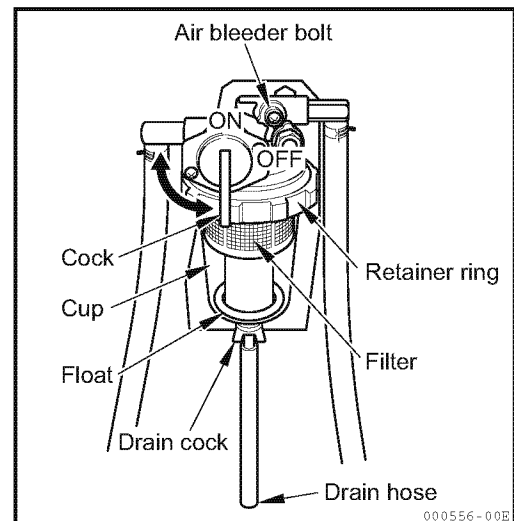

**27-6. Maintenance every 250 service hours**

Also perform the maintenance every 50 and 100 service hours.

**27-6-1. Replacing the engine oil and the engine oil filter element**

**⚠ WARNING**

- Do not replace the oil immediately after the engine stops to prevent bodily injury, because all the components are hot.
- Do not allow hot oil or components to contact skin.
- Replace the oil and the filter element after the oil and the components have cooled sufficiently.

■ Things to prepare

- Replacement new oil and container for waste oil

| Model    | Amount of oil     | Container         |
|----------|-------------------|-------------------|
| ViO45-5B | 7.71 Qts. (7.3 L) | 8.46 Qts. (8.0 L) |
| ViO55-5B | 9.40 Qts. (8.9 L) | 9.51 Qts. (9.0 L) |

- Filter wrench for engine oil filter cartridge
- 1) Swing the upperstructure so that the drain plug on the bottom of the engine is positioned in the middle of the right and left tracks.
  - 2) Remove the cover under the machine body put the container for waste oil under the drain plug.
  - 3) Slowly remove the drain plug (P) so that the oil should not splash your body and drain the waste oil.
  - 4) Check the waste oil, and contact your dealer if a lot of metallic particles or foreign objects are mixed in it.
  - 5) Reinstall the drain plug (P).
  - 6) Turn the oil filter cartridge (1) counterclockwise with the filter wrench to remove it.  
After removing the oil filter, wait for 10 to 15 minutes.
  - 7) Wipe the dirt and oil from the filter mount and apply engine oil (or apply grease lightly) to the seal surface of a new oil filter and mount the filter.

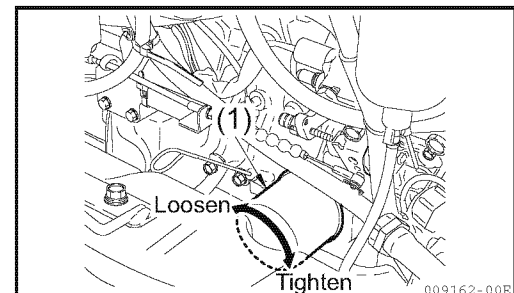
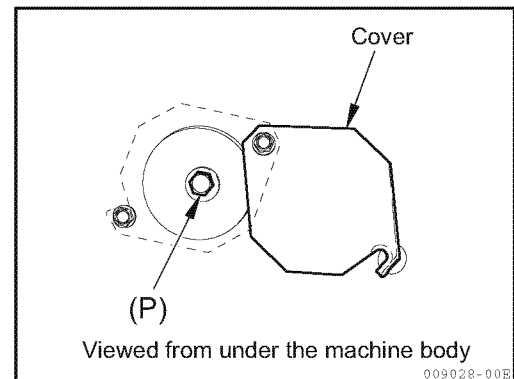



- 8) When mounting the filter, turn it 2/3 of a turn after the seal surface has contacted with the filter mount.
- 9) After replacing the oil filter (cartridge), supply engine oil to the upper limit mark on the oil dipstick through the oil supply port (F).  
Refer to Section "23. Fueling, Oiling and Greasing Based on Temperature Range" for the oil to be used.
- 10) Idle the engine for several minutes and then stop the engine. Then check that the oil level exceeds the mid-point between the upper and lower limit marks on the oil dipstick.  
Refer to Section "27-3. Checking before start-up".
- 11) Install and tighten the oil supply port cap securely.
- 12) Mount the cover under the body.

Replace the engine oil and the oil filter element 6 months after the previous replacement, even if the service hours have not reached 250 hours.  
Also replace them at 250 service hours, even if 6 months has not elapsed since the previous replacement.

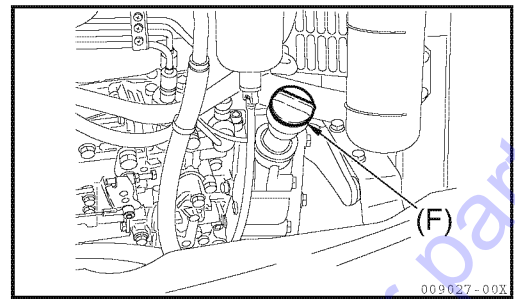

27-6-2. Checking and cleaning the air cleaner

**⚠ WARNING**

- Never attempt to clean and replace the air cleaner while the engine is running.  
Be sure to stop the engine when checking and cleaning it.
- Compressed air is used to clean the element. At that time, be sure to wear safety goggles to prevent scattered dust from coming into your eyes.
- The maximum air pressure should be less than 100 PSI (0.7 MPa) for cleaning purposes.

■ Cleaning procedure for element

- 1) Open the engine hood rear cover.
- 2) Remove the clip and remove the dust cap.
- 3) Remove the element.  
Cover the connector side in the back of the air cleaner body with a waste cloth and tape to prevent dirt from entering.
- 4) Clean the dust cup and the inside of the body.
- 5) Blow dry compressed air [100 PSI (0.7 MPa) or less] from inside the element along the pleats to initially remove the dirt. Then blow compressed air from outside the element along the pleats to remove dirt. The blow compressed air again from inside the element.

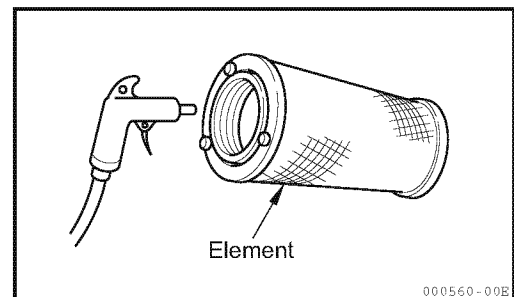
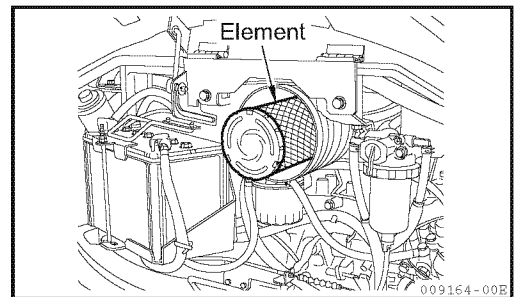
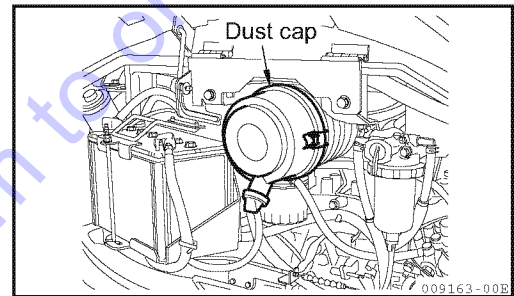

- 6) After cleaning, illuminate the element from inside with a light bulb to check it. If there are any small holes or thinner parts, replace the element with a new one.

**IMPORTANT**

- **When cleaning the element, do not tap it or strike it against other objects. Otherwise the element may be damaged.**
- **Do not reuse the element if the pleat, gasket or seal is damaged.**
- **Wrap an unused element with paper and store it in a dry place.**

- 7) Remove the clean cloth and the tape used to cover the connector in the back of the body.

- 8) Mount the cleaned element.

- 9) Install the dust cup while checking the arrow on it.

- 10) Close the engine hood rear cover.

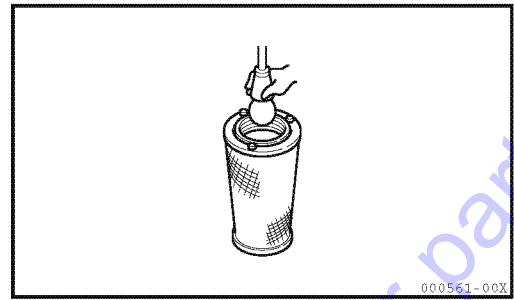

27-6-3. Checking and cleaning the radiator fin

**⚠ WARNING**

- Never attempt to check and clean the radiator fin while the engine is running.  
Always stop the engine and allow it to cool first, before checking and cleaning it.
- Compressed air can cause bodily injury since the objects around the radiator fin may scatter.
- Whenever using compressed air for cleaning, check that there are no other persons nearby, and always wear safety goggles and protective clothing and shoes.
- The maximum compressed air pressure should be less than 100 PSI (0.7 MPa) for cleaning purposes.

- 1) Open the engine hood rear cover.
- 2) Loosen cap screws to open the engine hood R.

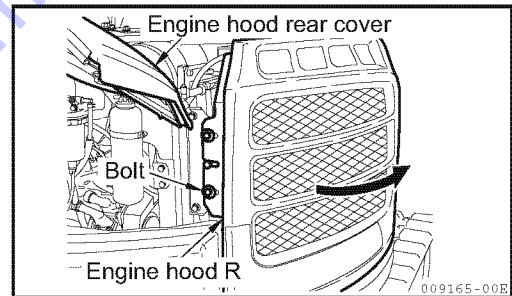

- 3) Fix the engine hood R with the stopper.

**IMPORTANT**

- Always blow the compressed air a little away from the fin to prevent damage to the fin.
- The damaged fin will cause water and oil leakage and overheating.

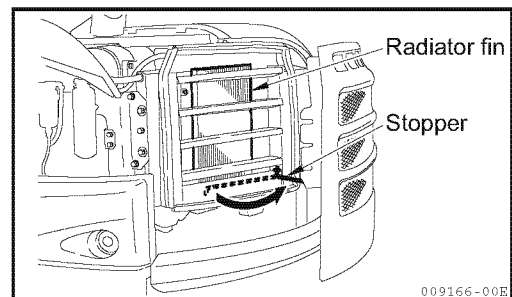

- 4) Check that the radiator fin is straight and all the dirt is removed completely.
- 5) Remove the stopper from the engine hood R to reinstall it in its original position.
- 6) Tighten the engine hood holding cap screws and close the engine hood rear cover.

**27-6-4. Adjusting the governor lever and accelerator device**

The governor lever and the accelerator devices (accelerator lever, pedal, etc.) of the auxiliary machinery are connected by an accelerator wire.

If the wire becomes stretched or the connections loose deviation in the position may result and make operation unsafe. Inspect the wire periodically and adjust if necessary.

- 1) Check to see that the governor lever on the engine side is touching the restraint bolt of the high speed side when the accelerator device is in the high speed position.
- 2) Check to see that the governor lever is touching the restraint bolt of the low speed side when the accelerator device is in the low speed position.
- 3) If the governor lever does not touch the restraint bolt for either the high or low speed side when you check them, loosen the setting screws on the fittings for the accelerator wire and adjust the position of the wire.

**⚠ CAUTION**

Never remove the restraint bolt for the fuel injection pump or the restraint bolt on the amount of fuel injected. Doing so will impair safe operation and lower the efficiency of the engine and shorten its life.

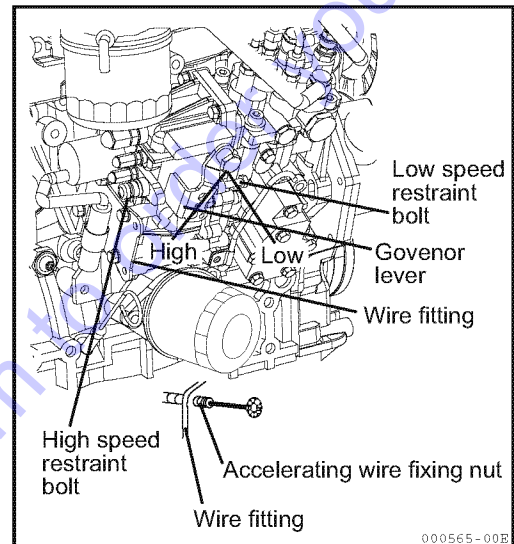

27-6-5. Checking and replenishing the lube oil for the travel reduction gearbox

**⚠ WARNING**

- The gear oil and casing of the reduction gearbox are hot immediately after ceasing machine operation and can cause bodily injury such as a burn. Do not allow hot oil or the gearbox to contact your skin.  
Replace the oil after the oil and the gearbox have cooled enough to permit touching the surface of the gearbox casing with your bare hand.
- At operating temperature, the reduction gearbox is hot and its contents are under pressure. In such condition, the oil or a plug may be ejected violently, causing bodily injury. Loosen a plug slowly to gradually relieve the residual pressure.

■ Things to prepare

- Container for oil
  - Oil jug
- 1) Align the three ports perpendicularly to the ground surface. (See the right figure).
  - 2) Place the container for oil under the level port.
  - 3) Remove the level port plug using a hexagon socket screw key and check that the oil level reaches the lower end of the plug port.
  - 4) When the oil quantity is insufficient, replenish gear oil through the oil supply port until gear oil overflows from the level plug port.  
See Section "23. Fueling, Oiling and Greasing Based on Temperature Range" for the oil to be used.
  - 5) Install the plug.  
Tightening torque : 15.9 to 17.4 ft•lbf (21.6 to 23.5 N•m)

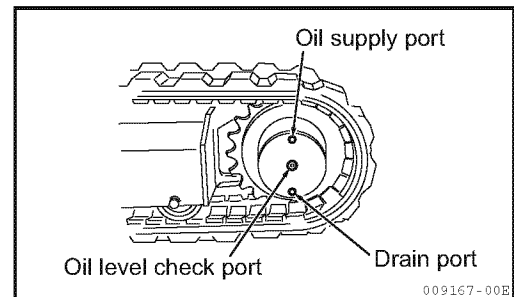

**27-7. Maintenance every 500 service hours**

Also perform the maintenance every 50, 100, and 250 service hours.

**27-7-1. Replacing the fuel filter****⚠ WARNING**

- Keep sparks, flames and lit cigarettes away.
- At the operating temperature, the engine components are hot and can cause a burn. Replace the element after the engine has cooled sufficiently. The fuel leaked or spilled onto hot surfaces or electrical components may cause a fire.

**■ Things to prepare**

- Container for fuel
- 1) Open the engine hood rear cover.
  - 2) Place the container for fuel under the fuel filter.
  - 3) Turn the fuel filter counterclockwise with the filter wrench to remove it.
  - 4) Wipe the dirt from the filter mount.
  - 5) Fill up the new filter with fuel and apply engine oil to the seal surface of it, then mount it.

**IMPORTANT**

**Be careful not to tighten the filter too much. Screw it in until its packing contacts the bracket and tighten it 2/3 turns more.**

- 6) Release air after the replacement of filter is completed. (Refer to P3-58).
- 7) After air releasing, start the engine to check for leaking and other problems.
- 8) Then, stop the engine and close the engine hood rear cover.

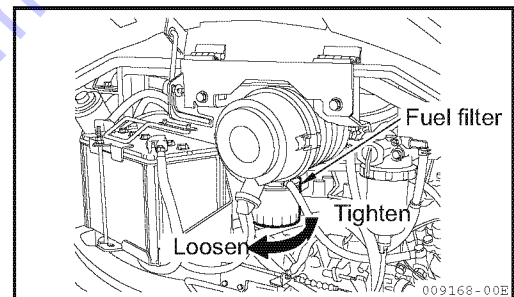

**How to release air:**

- 1) Fill up the fuel tank.
- 2) Set the accelerator lever to the "RUN" position.
- 3) Turn the starter switch to the "START" position to crank the engine for approximately 10 seconds.

Air is automatically released and the engine starts.

**IMPORTANT**

**If the engine is not started after this procedure, turn the starter switch to the "OFF" position after 10 seconds and at least a minute later turn it to the "START" position again to restart the engine.**

When you refuel, release air in the same way; that is, crank the engine for 10 seconds four or five times.

After the engine starts, sometimes it revolves irregularly and stops approximately 20 to 30 seconds later. In this case, turn the starter switch to the "OFF" position, wait for one minute or more and turn the starter switch to the "START" position again.



27-7-2. Replacing the air cleaner element

**⚠ WARNING**

Never attempt to replace the air cleaner element while the engine is running.

Replace the air cleaner element after the engine has been stopped and cooled sufficiently.

- 1) Open the engine hood rear cover.
- 2) Remove the clip to remove the dust cup.
- 3) Remove the element.  
Cover the connector side in the back of the air cleaner body with a clean cloth and tape to prevent dirt from entering.
- 4) Clean the dust cup and the inside of the body.  
Remove the clean cloth and the tape used to cover the connector in the back side of the body.
- 5) Install a new element.
- 6) Install the dust cup, while checking the arrow on it.
- 7) Close the engine hood rear cover.

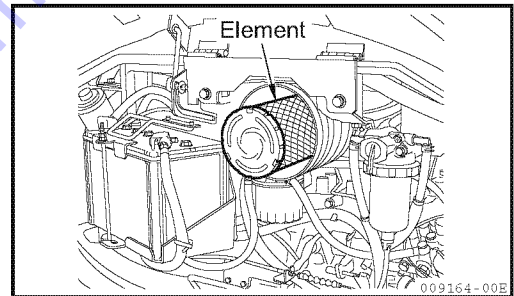
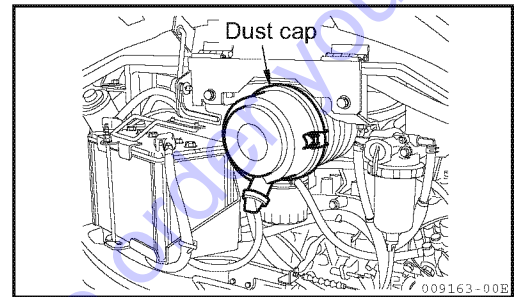

27-7-3. Replacing the hydraulic oil return filter element

**⚠ WARNING**

- The hydraulic oil and the tank are hot and under pressure at operating temperature. Never replace the oil immediately after operation is stopped. Wait until the tank has cooled enough to permit you to touch its surface with your bare hand.
- When removing the oil supply port cap, slowly loosen it to relieve the internal pressure, then remove the cap carefully.
- If the cover of the tank is removed too quickly, the cover may pop out due to the spring force applied to the filter. Also, the hydraulic oil may spout out if the pressure inside the tank has not been gradually relieved. Slowly loosen the bolts to remove the cap.

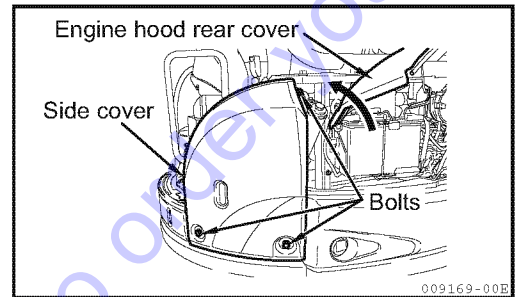

- 1) Open the engine hood rear cover.
- 2) Loosen three bolts to remove the side cover.
- 3) Clean around the cover.
- 4) Slowly loosen the bolts to release the internal pressure and remove the cover.
- 5) Remove the filter and install the valve to a new filter, then install the filter into the tank.

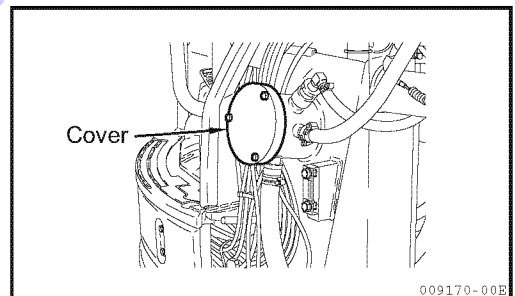

**IMPORTANT**

**Do not allow any dirt to enter the tank when installing the return filter.**

- 6) Clean around the cover using waste cloth and check the O-ring. If the O-ring is damaged, replace it with a new one and then reinstall the cover.
- 7) Reinstall the side cover and tighten its bolts securely.
- 8) Close the engine hood rear cover.

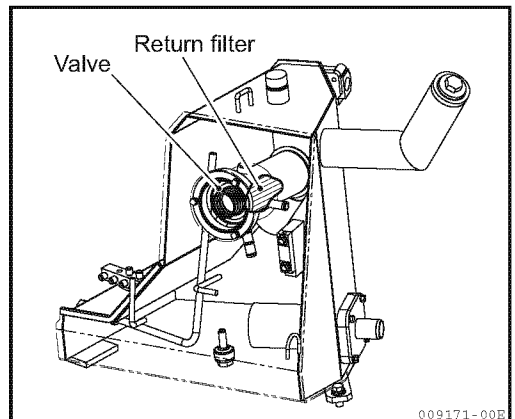

## 27-8. Maintenance every 1000 service hours

Also perform the maintenance every 50, 100, 250 and 500 service hours.

### 27-8-1. Replacing the lube oil for the travel reduction gearbox

#### **⚠ WARNING**

- The gear oil and casing of the reduction gearbox are hot immediately after ceasing machine operation and can cause bodily injury such as a burn. Do not allow hot oil or the gearbox to contact your skin.  
Replace the oil after the oil and the gearbox have cooled enough to permit touching the surface of the gearbox casing with your bare hand.
- At operating temperature, the reduction gearbox is hot and its contents are under pressure. In such condition, the oil or a plug may be ejected violently, causing bodily injury. Loosen a plug slowly to gradually relieve the residual pressure.

#### ■ Things to prepare

- Container for waste oil : Capacity of 1.27 Qts. (1.2 L) or more
- New oil : 1.27 Qts. (1.2 L) for right and left each
- Oil jug : Capacity of 1.27 Qts. (1.2 L) or more

- 1) Align the three ports perpendicularly to the ground surface. (See the right figure).
- 2) Put the container for the waste oil under the drain port.
- 3) Remove the drain port, and level port plugs with a hexagon socket screw key to drain the waste oil.
- 4) After draining the waste oil, install the plug to the drain port.  
[Tightening torque : 15.9 to 17.4 ft•lbf (21.6 to 23.5 N•m)]
- 5) Replenish gear oil to the specified level through the oil supply port. Refer to Section "23. Fueling, Oiling and Greasing Based on Temperature Range" for the oil to be used.
- 6) When the oil overflows from the level port, reinstall the oil supply port and level port plugs.  
[Tightening torque : 15.9 to 17.4 ft•lbf (21.6 to 23.5 N•m)]

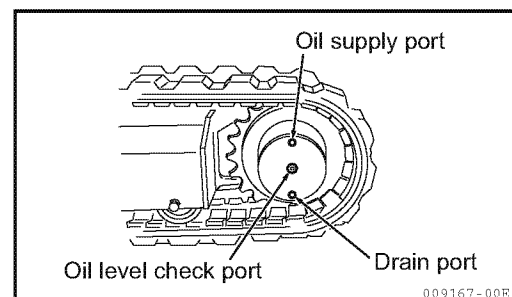

27-8-2. Replacing the hydraulic oil and cleaning the suction filter element

**⚠ WARNING**

- The hydraulic oil and the tank are hot and under pressure at operating temperature. Never replace the oil immediately after operation is stopped. Wait until the tank has cooled enough to permit you to touch its surface with your bare hand.
- When removing the oil supply port cap, slowly loosen it to relieve the internal pressure, then remove the cap carefully.
- If the cover of the tank is removed too quickly, the cover may pop out due to the spring force applied to the filter. Also, the hydraulic oil may spout out if the pressure inside the tank has not been gradually relieved. Slowly loosen the bolts to remove the cap.

■ Things to prepare

- Container for waste oil : Capacity of 10 Gals. (38 L) or more
  - New hydraulic oil : 10 Gals. (38 L)  
[When all oil is drained from all of the hydraulic equipment, pipes and hoses, the required new oil amount is 17.2 Gals. (65 L)].
  - O-ring
- 1) Swing the upperstructure so that the drain plug at the bottom of the hydraulic oil tank is positioned in the middle of the right and left tracks.
  - 2) Retract the bucket and arm cylinders to their stroke ends, lower the boom and put the bucket teeth on the ground.
  - 3) Put the blade on the ground and stop the engine.
  - 4) Remove the bottom cover and put the container for waste oil under the drain plug.
  - 5) Remove the drain plug and drain the waste oil. When removing the drain plug, take care that the oil does not splash your body.
  - 6) Open the engine hood rear cover.
  - 7) Loosen three bolts to remove the side cover.
  - 8) Clean the area around the cover on the top of the hydraulic oil tank using a waste cloth. Slowly loosen the bolts to remove the cover.

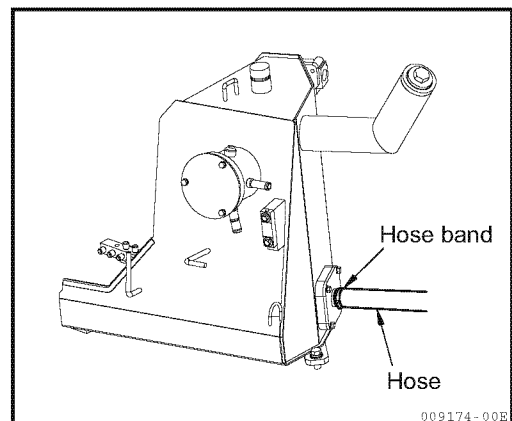
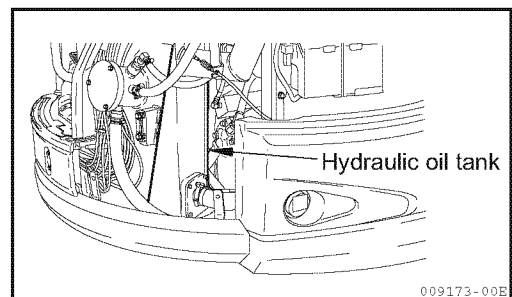
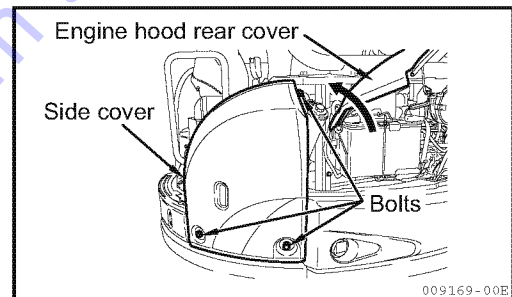
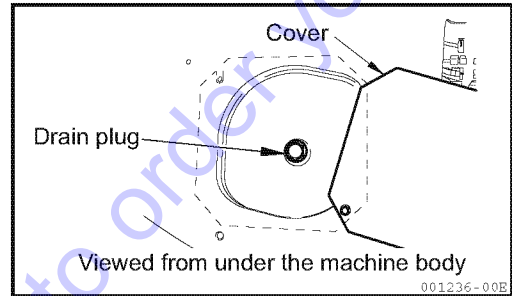
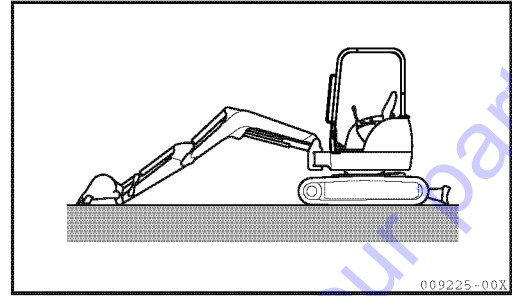

- 9) Degrease and wash the threads of the plug, and replace the O-ring installed onto the plug with a new one.
- 10) After draining the waste oil, reinstall and tighten the drain plug.  
Tightening torque : 115.7 to 137.4 ft•lbf (156.9 to 186.3 N•m)
- 11) Take out the filter to remove the dirt from it and wash it with clean wash oil or light oil.
- 12) Check the filter and the O-ring installed onto it. If the filter or the O-ring is damaged or cracked, replace the filter with a new one and install it in the tank.

**IMPORTANT**

**Do not allow any dirt to enter the tank when installing the filter.**

- 13) Put oil to the specified level through the oil supply port (F). Check the oil level with the oil level gauge on the side of the tank and do not put oil beyond the midpoint between the upper and lower limit marks on the oil level gauge.  
See Section "23. Fueling, Oiling and Greasing Based on Temperature Range" for the oil to be used.
- 14) Wipe off the cover mounting surface with waste cloth and check the O-ring of the oil supply port (F). If it is damaged, replace it with a new one, and then reinstall the oil supply port (F).
- 15) After replacing the oil, set all control levers to the neutral position and idle the engine for approximately 2 to 3 minutes and then control each implement to check their operation.
- 16) Reinstall the side cover and close the engine hood rear cover.

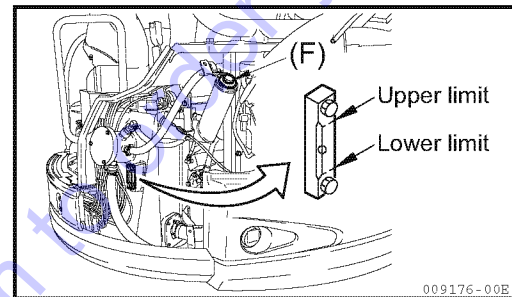
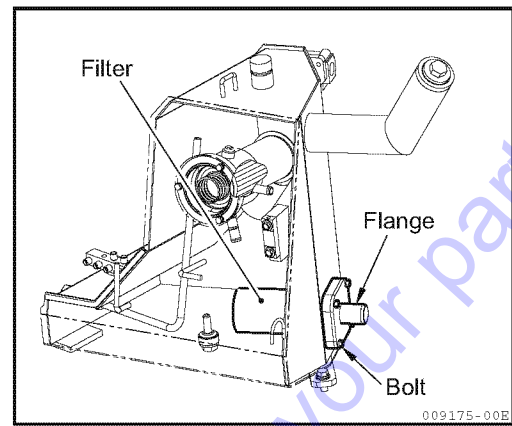

**27-8-3. Checking and adjusting the intake/exhaust valve clearances**

Ask your dealer for checking and adjusting.

**27-8-4. Checking and adjusting the fuel injection valve**

Ask your dealer for checking and adjusting.

**27-8-5. Retightening the cylinder head bolts**

Ask your dealer for retightening.

**27-9. Maintenance every 2000 service hours**

Also perform the maintenance every 50, 100, 250, 500 and 1000 service hours.

**27-9-1. Check and replace fuel oil pipe, cooling water pipe**

Ask your dealer.

**27-9-2. Lapping the intake/exhaust valve**

Ask your dealer.

**27-9-3. Check fuel pump adjust**

Ask your dealer.

**27-9-4. Clean and check the cooling water system**

Ask your dealer.

## 28. MAINTENANCE (ViO55-5B Angle blade spec.)

### 28-1. Procedures for maintenance

#### 28-1-1. Nonperiodic service

##### ■ Replacing the cutting edge

### ⚠ WARNING

When replacing the cutting edge, be careful not to move the blade by mistake for safety.

Place the blade in a stable position, stop the engine, and securely lock the lock levers.

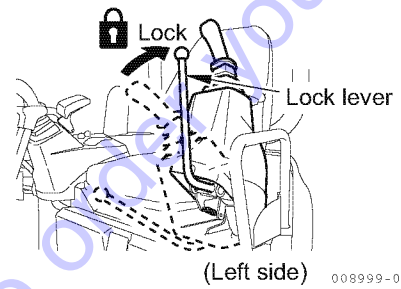

When the cutting edge is worn, loosen the nuts as shown in the figure and replace the cutting edge.

When installing the cutting edge, apply adhesive to the bolts and tighten the nuts with the following tightening torque.

Tightening torque:

151.8 to 173.5 ft•lbf (205.8 to 235.2 N•m)

Adhesive: Loctite 262

- Replace the bolts, nuts and spring washers when replacing the cutting edge.

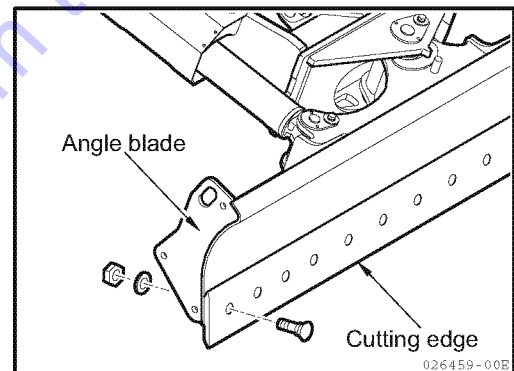

#### 28-1-2. Checking before start-up

##### ■ Greasing

##### IMPORTANT

- Grease the fittings thoroughly after washing the machine or after operation in rain, on soft ground, or in muddy water.
- Be sure to perform the greasing daily before start-up.
  - 1) Put the blade on the ground and stop the engine.
  - 2) Clean the grease nipples indicated with the arrows in the right figures and grease them using a grease gun.
  - 3) After greasing, wipe off the excessive grease with waste cloth or the like.

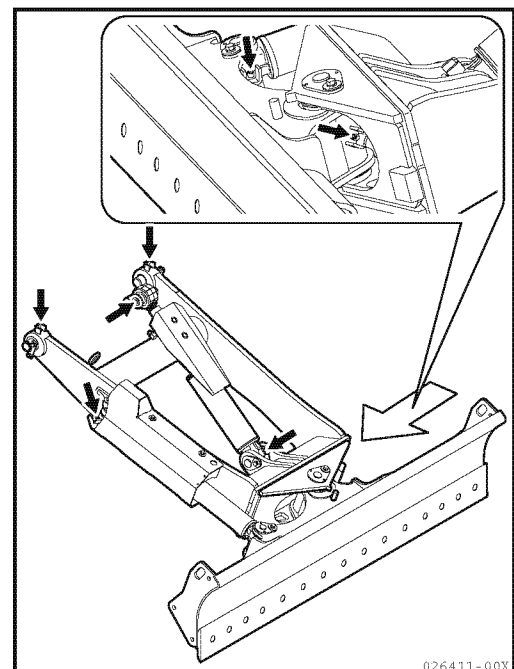

# **SPECIFICATIONS AND DIMENSIONAL DIAGRAMS**

Go to [Discount-Equipment.com](http://Discount-Equipment.com) to order your parts



## 29. Specifications and Dimensional Diagrams

### ■ Specifications (ViO45-5B Quick coupler)

| Items | Type | ViO45-5B    |       |              |       |
|-------|------|-------------|-------|--------------|-------|
|       |      | Steel track |       | Rubber track |       |
|       |      | Canopy      | Cabin | Canopy       | Cabin |

- Weight (in compliance with SAE standards)

| Operating mass | lbs. (kg) | 10406 (4720) | 10692 (4850) | 10274 (4660) | 10560 (4790) |
|----------------|-----------|--------------|--------------|--------------|--------------|
|----------------|-----------|--------------|--------------|--------------|--------------|

- Working range and performance

|   |               |   |             |             |             |
|---|---------------|---|-------------|-------------|-------------|
| Bucket capacity, standard                         | cu.ft (cu.m)  | 4.94 (0.14)   |             |             |             |
| Bucket width, standard                            | in. (mm)      | 25.6 (650)  |             |             |             |
| Maximum digging depth <at down the blade>         | in. (mm)      | 144.9 (3680) <151.6 (3850)>   |             |             |             |
| Maximum vertical wall digging depth               | in. (mm)      | 106.3 (2700)  |             |             |             |
| Maximum cutting height                            | in. (mm)      | 234.3 (5950)  |             |             |             |
| Maximum dumping height                            | in. (mm)      | 153.9 (3910)  |             |             |             |
| Maximum digging radius of the ground              | in. (mm)      | 226.4 (5750)  |             |             |             |
| Front minimum swing radius <at swinging the boom> | in. (mm)      | 92.1 (2340) <78.3 (1990)>   |             |             |             |
| Boom swing angle : left / right                   | degrees       | 70 / 70   |             |             |             |
| Maximum digging force (bucket)                    | lbs. (k•N)    | 6725 (29.9)   |             |             |             |
| Travel speed : high / low                         | MPH (km / h)  | 2.86 (4.6) / 1.43 (2.3)   |             |             |             |
| Swing speed                                       | rpm           | 10  |             |             |             |
| Average ground pressure, standard track           | PSI (kPa)     | 4.20 (29.0)   | 4.31 (29.7) | 4.15 (28.6) | 4.27 (29.3) |
| Hydraulic pump displacement                       | GPM (L / min) | 10.6 (40.3)×2 <Variable displacement pump><br>10.6 (40.3)×1, 3.1 (11.8)×1 <Gear pump> |             |             |             |
| System relief set pressure                        | PSI (MPa)     | 3128 (21.6)×3   |             |             |             |

- Engine

|                           |                |   |
|---------------------------|----------------|---|
| Type                      | -              | Vertical three cylinder water-cooled direct injection diesel engine |
| Model                     | -              | 4TNV88-BXBV   |
| Rated output/revs         | HP (kW) / rpm  | 38.7 (28.8) / 2400  |
| Displacement              | cu.in. (cu.cm) | 133.5 (2189)  |
| Compression pressure      | PSI (MPa)      | 500 (3.4) at 250 rpm  |
| Nozzle injection pressure | PSI (MPa)      | 2844 (19.6) to 2986 (20.6)  |
| Fan belt (V-belt) size    | -              | A37.5   |
| Generator capacity        | V / A          | 12 / 40   |

- **Battery type and capacity.....115D31R / 12V, 72Ah (5 hours rate capacity)**

■ Specifications (ViO55-5B Quick coupler)

| Items | Type | ViO55-5B    |       |              |       |
|-------|------|-------------|-------|--------------|-------|
|       |      | Steel track |       | Rubber track |       |
|       |      | Canopy      | Cabin | Canopy       | Cabin |

- Weight (in compliance with SAE standards)

|                |           |              |              |              |              |
|----------------|-----------|--------------|--------------|--------------|--------------|
| Operating mass | lbs. (kg) | 11574 (5250) | 11861 (5380) | 11530 (5230) | 11817 (5360) |
|----------------|-----------|--------------|--------------|--------------|--------------|

- Working range and performance

|   |               |   |             |             |             |
|---|---------------|---|-------------|-------------|-------------|
| Bucket capacity, standard                         | cu.ft (cu.m)  | 5.65 (0.16)   |             |             |             |
| Bucket width, standard                            | in. (mm)      | 27.6 (700)  |             |             |             |
| Maximum digging depth <at down the blade>         | in. (mm)      | 156.7 (3980) <163.8 (4160)>   |             |             |             |
| Maximum vertical wall digging depth               | in. (mm)      | 114.1 (2900)  |             |             |             |
| Maximum cutting height                            | in. (mm)      | 253.5 (6440)  |             |             |             |
| Maximum dumping height                            | in. (mm)      | 173.2 (4400)  |             |             |             |
| Maximum digging radius of the ground              | in. (mm)      | 244.1 (6200)  |             |             |             |
| Front minimum swing radius <at swinging the boom> | in. (mm)      | 156.7 (2320) <77.1 (1960)>  |             |             |             |
| Boom swing angle : left / right                   | degrees       | 70 / 70   |             |             |             |
| Maximum digging force (bucket)                    | lbs. (k•N)    | 7607 (33.8)   |             |             |             |
| Travel speed : high / low                         | MPH (km / h)  | 2.73 (4.4) / 1.43 (2.3)   |             |             |             |
| Swing speed                                       | rpm           | 10  |             |             |             |
| Average ground pressure, standard track           | PSI (kPa)     | 4.02 (27.7)   | 4.18 (28.8) | 3.96 (27.3) | 4.12 (28.4) |
| Hydraulic pump displacement                       | GPM (L / min) | 10.6 (40.3)×2 <Variable displacement pump><br>10.6 (40.3)×1, 3.1 (11.8)×1 <Gear pump> |             |             |             |
| System relief set pressure                        | PSI (MPa)     | 3555 (24.5)×3   |             |             |             |

- Engine

|                           |                |  |
|---------------------------|----------------|--|
| Type                      | -              | Vertical four cylinder water-cooled direct injection diesel engine |
| Model                     | -              | 4TNV88-BXBV  |
| Rated output/revs         | HP (kW) / rpm  | 38.7 (28.8) / 2400   |
| Displacement              | cu.in. (cu.cm) | 133.5 (2189)   |
| Compression pressure      | PSI (MPa)      | 500 (3.4) at 250 rpm   |
| Nozzle injection pressure | PSI (MPa)      | 2844 (19.6) to 2986 (20.6)   |
| Fan belt (V-belt) size    | -              | A37.5  |
| Generator capacity        | V / A          | 12 / 40  |

- Battery type and capacity.....115D31R / 12V, 72Ah (5 hours rate capacity)

■ Model view and working range Unit : in. (mm)

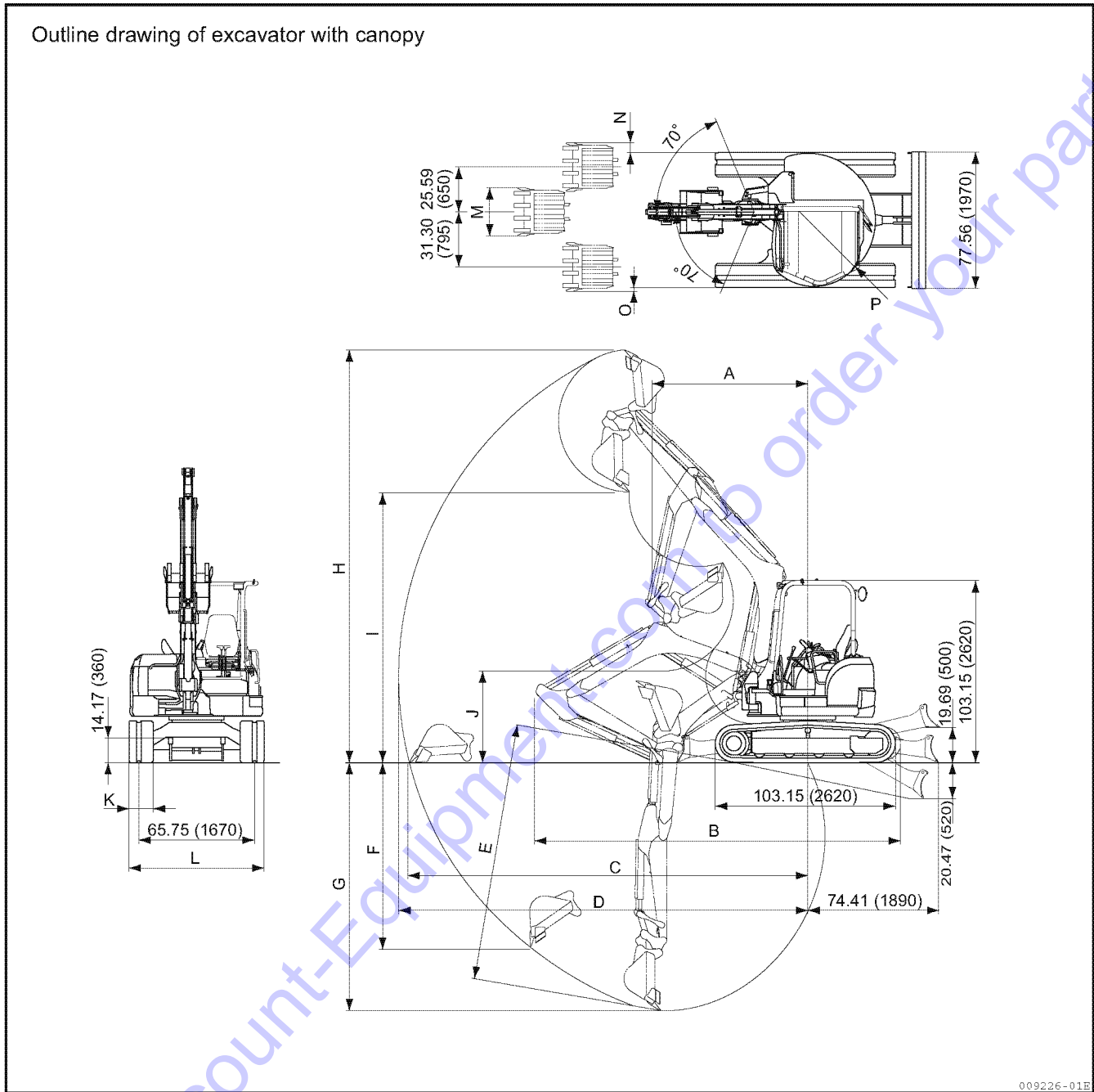

|          | A <at boom swing>              | B                | C                | D                | E                | F                | G                | H                | I                | J               |
|----------|--------------------------------|------------------|------------------|------------------|------------------|------------------|------------------|------------------|------------------|-----------------|
| ViO45-5B | 92.13 <78.35><br>(2340 <1990>) | 207.09<br>(5260) | 226.38<br>(5750) | 232.28<br>(5900) | 151.57<br>(3850) | 106.30<br>(2700) | 144.88<br>(3680) | 234.25<br>(5950) | 153.94<br>(3910) | 52.36<br>(1330) |
| ViO55-5B | 91.34 <77.17><br>(2320 <1960>) | 218.90<br>(5560) | 244.09<br>(6200) | 250.00<br>(6350) | 163.78<br>(4160) | 114.17<br>(2900) | 156.69<br>(3980) | 253.54<br>(6440) | 173.23<br>(4400) | 59.84<br>(1520) |

|          | K              | L               | M              | N             | O            | P                |
|----------|----------------|-----------------|----------------|---------------|--------------|------------------|
| ViO45-5B | 13.78<br>(350) | 76.77<br>(1950) | 25.59<br>(650) | 5.12<br>(130) | 1.57<br>(40) | R38.39<br>(R975) |
| ViO55-5B | 15.75<br>(400) | 78.35<br>(1990) | 27.56<br>(700) | 5.31<br>(135) | 1.77<br>(45) | R39.17<br>(R995) |

■ Model view and working range Unit : in. (mm)

Outline drawing of excavator with cabin

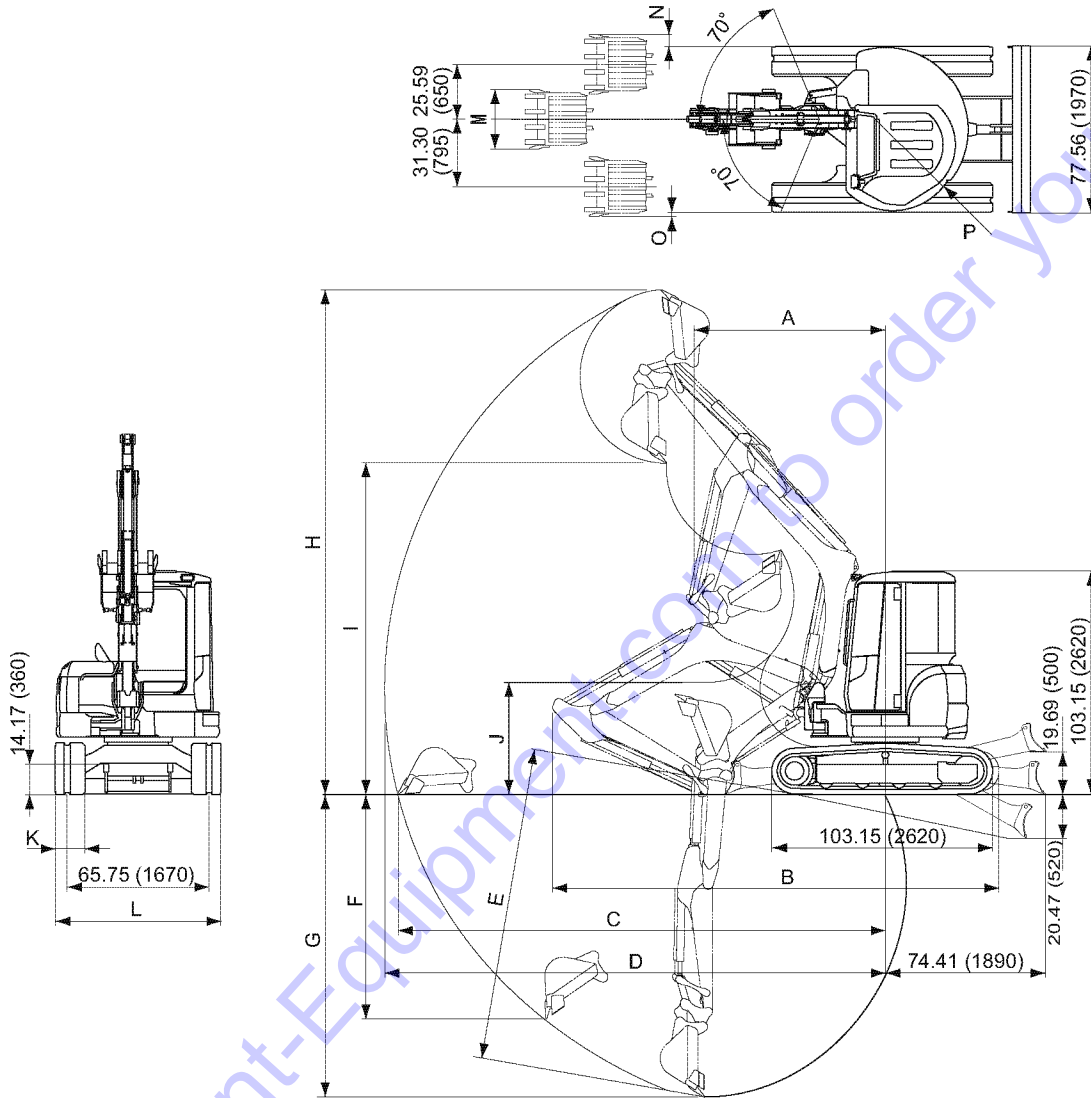

009227-01B

|          | A <at boom swing>              | B                | C                | D                | E                | F                | G                | H                | I                | J               |
|----------|--------------------------------|------------------|------------------|------------------|------------------|------------------|------------------|------------------|------------------|-----------------|
| ViO45-5B | 92.13 <78.35><br>(2340 <1990>) | 207.09<br>(5260) | 226.38<br>(5750) | 232.28<br>(5900) | 151.57<br>(3850) | 106.30<br>(2700) | 144.88<br>(3680) | 234.25<br>(5950) | 153.94<br>(3910) | 52.36<br>(1330) |
| ViO55-5B | 91.34 <77.17><br>(2320 <1960>) | 218.90<br>(5560) | 244.09<br>(6200) | 250.00<br>(6350) | 163.78<br>(4160) | 114.17<br>(2900) | 156.69<br>(3980) | 253.54<br>(6440) | 173.23<br>(4400) | 59.84<br>(1520) |

|          | K              | L               | M              | N             | O            | P                |
|----------|----------------|-----------------|----------------|---------------|--------------|------------------|
| ViO45-5B | 13.78<br>(350) | 76.77<br>(1950) | 25.59<br>(650) | 5.12<br>(130) | 1.57<br>(40) | R38.39<br>(R975) |
| ViO55-5B | 15.75<br>(400) | 78.35<br>(1990) | 27.56<br>(700) | 5.31<br>(135) | 1.77<br>(45) | R39.17<br>(R995) |

## 30. SPECIFICATIONS AND DIMENSIONAL DIAGRAMS (ViO55-5B Angle Blade Spec.)

### ■ Specifications (ViO55-5B Angle Blade)

| Items | Type | ViO55-5B    |       |              |       |
|-------|------|-------------|-------|--------------|-------|
|       |      | Steel track |       | Rubber track |       |
|       |      | Canopy      | Cabin | Canopy       | Cabin |

- Weight (in compliance with SAE standards)

|                |           |              |              |              |              |
|----------------|-----------|--------------|--------------|--------------|--------------|
| Operating mass | lbs. (kg) | 11883 (5390) | 12170 (5520) | 11839 (5370) | 12125 (5500) |
|----------------|-----------|--------------|--------------|--------------|--------------|

- Working range and performance

|   |               |   |             |             |             |
|---|---------------|---|-------------|-------------|-------------|
| Bucket capacity, standard                         | cu.ft (cu.m)  | 5.65 (0.16)   |             |             |             |
| Bucket width, standard                            | in. (mm)      | 27.6 (700)  |             |             |             |
| Maximum digging depth <at down the blade>         | in. (mm)      | 156.7 (3980) <163.4 (4150)>   |             |             |             |
| Maximum vertical wall digging depth               | in. (mm)      | 114.1 (2900)  |             |             |             |
| Maximum cutting height                            | in. (mm)      | 253.5 (6440)  |             |             |             |
| Maximum dumping height                            | in. (mm)      | 173.2 (4400)  |             |             |             |
| Maximum digging radius of the ground              | in. (mm)      | 244.1 (6200)  |             |             |             |
| Front minimum swing radius <at swinging the boom> | in. (mm)      | 156.7 (2320) <77.1 (1960)>  |             |             |             |
| Boom swing angle : left / right                   | degrees       | 70 / 70   |             |             |             |
| Maximum digging force (bucket)                    | lbs. (k•N)    | 7607 (33.8)   |             |             |             |
| Travel speed : high / low                         | MPH (km / h)  | 2.73 (4.4) / 1.43 (2.3)   |             |             |             |
| Swing speed                                       | rpm           | 10  |             |             |             |
| Average ground pressure, standard track           | PSI (kPa)     | 4.29 (29.6)   | 4.39 (30.3) | 4.22 (29.1) | 4.32 (29.8) |
| Hydraulic pump displacement                       | GPM (L / min) | 10.6 (40.3)×2 <Variable displacement pump><br>10.6 (40.3)×1, 3.1 (11.8)×1 <Gear pump> |             |             |             |
| System relief set pressure                        | PSI (MPa)     | 3555 (24.5)×3   |             |             |             |
| Blade angle: left / right                         | degrees       | 25 / 25   |             |             |             |

- Engine

|                           |                |  |
|---------------------------|----------------|--|
| Type                      | -              | Vertical four cylinder water-cooled direct injection diesel engine |
| Model                     | -              | 4TNV88-BXBV  |
| Rated output/revs         | HP (kW) / rpm  | 38.7 (28.8) / 2400   |
| Displacement              | cu.in. (cu.cm) | 133.5 (2189)   |
| Compression pressure      | PSI (MPa)      | 500 (3.4) at 250 rpm   |
| Nozzle injection pressure | PSI (MPa)      | 2844 (19.6) to 2986 (20.6)   |
| Fan belt (V-belt) size    | -              | A37.5  |
| Generator capacity        | V / A          | 12 / 40  |

- **Battery type and capacity.....115D31R / 12V, 72Ah (5 hours rate capacity)**

#### Note:

There is no angle blade type in ViO45-5B.

■ Model view and working range Unit : in. (mm)

Outline drawing of excavator with canopy

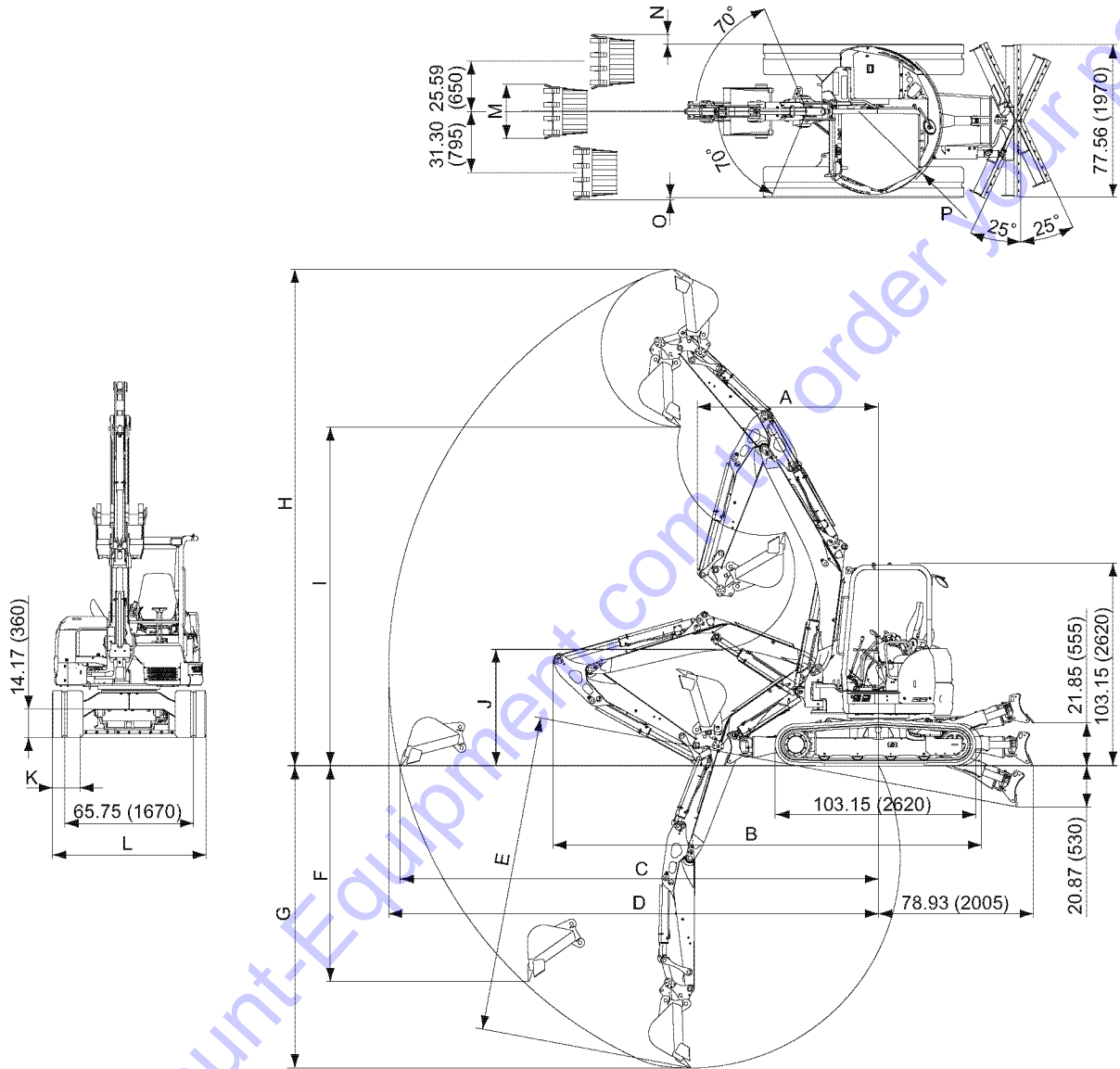

026458-00B

| A <at boom swing>              | B                | C                | D                | E                | F                | G                | H                | I                | J               | K              | L               |
|--------------------------------|------------------|------------------|------------------|------------------|------------------|------------------|------------------|------------------|-----------------|----------------|-----------------|
| 91.34 <77.17><br>(2320 <1960>) | 218.90<br>(5560) | 244.09<br>(6200) | 250.00<br>(6350) | 163.39<br>(4150) | 114.17<br>(2900) | 156.69<br>(3980) | 253.54<br>(6440) | 173.23<br>(4400) | 59.84<br>(1520) | 15.75<br>(400) | 78.35<br>(1990) |

| M              | N             | O            | P                |
|----------------|---------------|--------------|------------------|
| 27.56<br>(700) | 5.31<br>(135) | 1.77<br>(45) | R39.17<br>(R995) |

■ Model view and working range Unit : in. (mm)

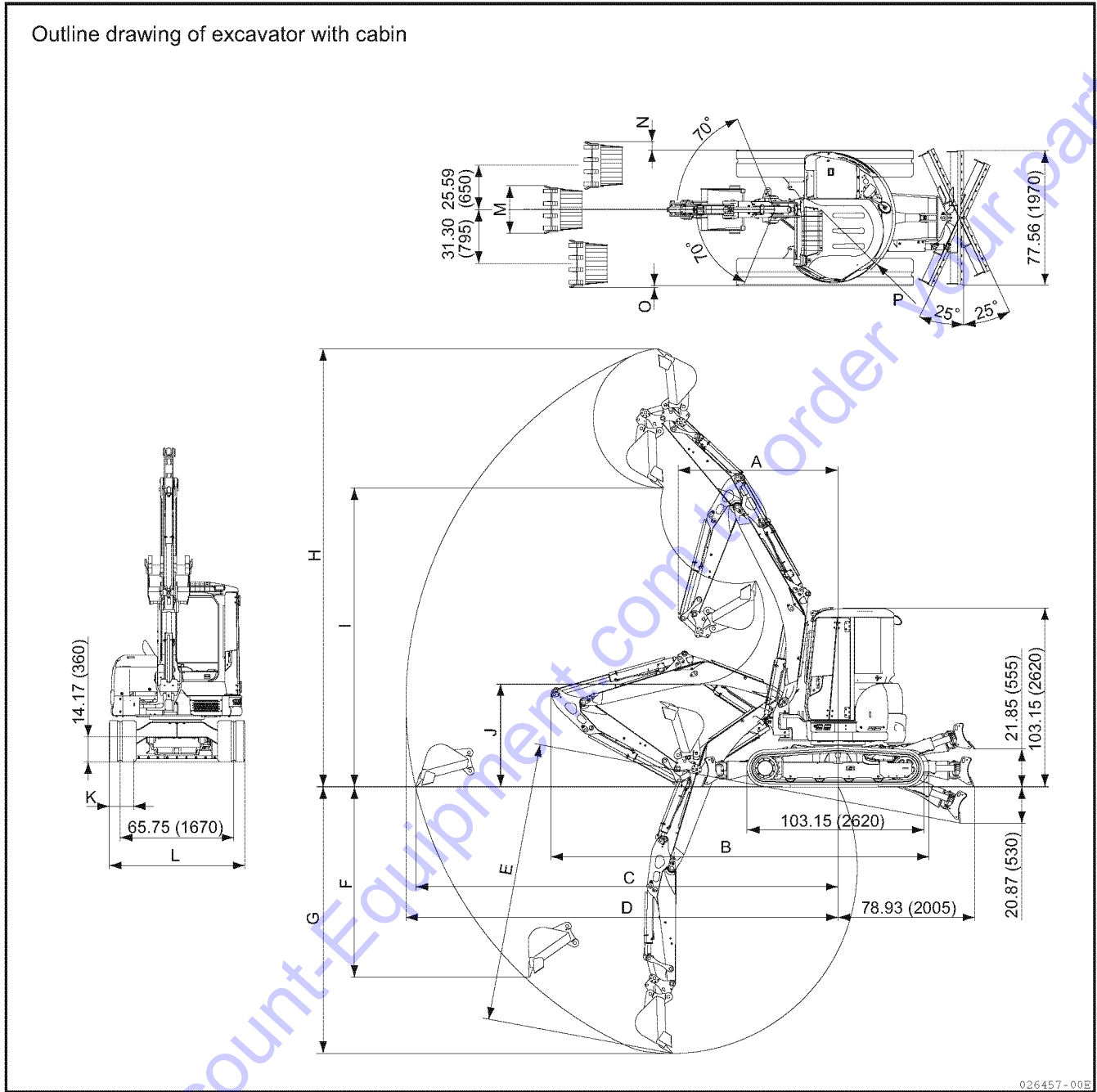

| A <at boom swing>              | B                | C                | D                | E                | F                | G                | H                | I                | J               | K              | L               |
|--------------------------------|------------------|------------------|------------------|------------------|------------------|------------------|------------------|------------------|-----------------|----------------|-----------------|
| 91.34 <77.17><br>(2320 <1960>) | 218.90<br>(5560) | 244.09<br>(6200) | 250.00<br>(6350) | 163.39<br>(4150) | 114.17<br>(2900) | 156.69<br>(3980) | 253.54<br>(6440) | 173.23<br>(4400) | 59.84<br>(1520) | 15.75<br>(400) | 78.35<br>(1990) |

| M              | N             | O            | P                |
|----------------|---------------|--------------|------------------|
| 27.56<br>(700) | 5.31<br>(135) | 1.77<br>(45) | R39.17<br>(R995) |

# OPTIONAL PARTS AND ATTACHMENTS

Go to [Discount-Equipment.com](http://Discount-Equipment.com) to order your parts



## 31. General Precautions

### 31-1. Safety precautions

The mounting of attachments and optional parts that are not authorized by YANMAR may cause accidents as well as shorten the machine life.

If you need to mount any attachments other than those described in this manual, contact your dealer. If you fail to do so, the installation and use of unauthorized attachments and parts may void your Warranty.

### **WARNING**

#### **Precautions for mounting and dismounting an attachment**

**When mounting or dismounting an attachment, observe the following precautions for safety.**

- **When mounting or dismounting a heavy implement or attachment, place the machine on level, solid ground.**
- **When you work together with a partner, define hand signals and communicate in accordance with those signals.**
- **When moving a heavy load [more than 55.1 lbs. (25 kg)], use a crane.**
- **When removing a heavy part, be sure to support it adequately.**  
**When lifting such a part with a crane, be aware of its center of gravity.**
- **Do not mount or dismount a heavy part while suspending it with a crane. Be sure to support it securely on a stable base.**
- **Securely support any attachment that has been removed or is to be installed, and take adequate precautions not to let it fall down.**
- **Never stand directly under a load suspended by a crane.**  
**Stand far enough away to be safe if the load should fall.**

#### **IMPORTANT**

**Comply with all licensing requirements before operating a crane.**

**Do not permit an unauthorized person to operate a crane.**

**For more information about the procedures for mounting and dismounting attachments, ask your dealer.**

## 31-2. Precautions for mounting an attachment (implement)

**! WARNING**

A long implement may throw a machine off balance, and may cause the machine to roll over when the machine descends or swings on a slope.

The following operations are especially dangerous, and must never be done.

- Descending a slope with the implement raised
- Traversing across a slope
- Swinging on a slope

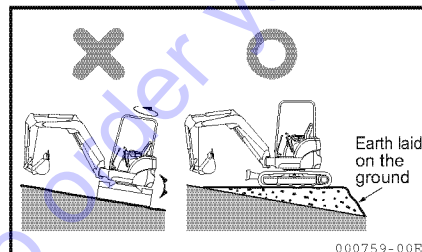
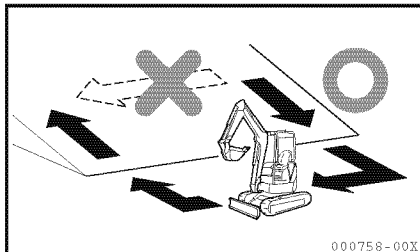
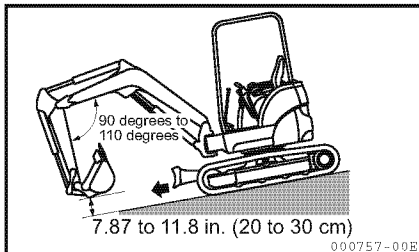

- If you mount an unusually heavy implement (attachment) on the machine, the inertia of the upperstructure will increase so that the upperstructure will continue to turn over a longer distance after it has been deactivated. This can mislead the operator about the safe distance between the swinging implement and an object nearby and could cause the implement to bump against the object. To avoid this type of accident, deactivate the upperstructure a little earlier than usual. Because of increased inertia, the implement will also drop a greater distance after it has been stopped in mid-air. (The unintentional drifting of the implement will be greater).
- Be sure that the boom and the arm have been mounted correctly. Otherwise, serious accidents or damage may occur. If you do not know how to mount the boom or the arm correctly, ask your dealer.
- If you mount a long implement, you may misjudge the distance between the implement and a nearby object, and cause the implement to bump against the object.  
Be sure to provide adequate clearance between long implements and nearby objects.

## 32. Handling the Hooked Bucket

### 32-1. Checking the hooked bucket for damage

Check the hook, the lock, and the hook mounting base for damage.

If any damage is found, ask your dealer to repair the bucket.

### 32-2. Prohibitions

#### ■ Do not suspend a load without the dedicated hook

A dedicated hook is required to suspend a load with the machine.

For the details, ask your dealer.

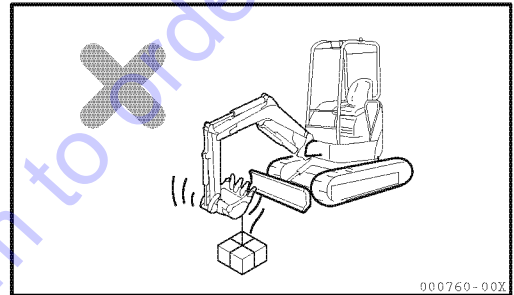

### 32-3. Precautions

#### ■ Precautions for suspending a load

- Reduce the engine speed when suspending a load.
- The wire rope or the suspending ring may slip off the bucket hook if the hook is not maintained in a vertical position due to the working posture of the machine. Be careful to maintain a vertical hook position, so that the wire rope or the suspending ring will not slip off.
- When the hooked bucket is used in a reverse position, take care that the bucket hook should not interfere with the arm when dumping the bucket.
- The weight of a load to be suspended must not exceed 253.6 lbs. (115 kg) for ViO45-5B, 308.7 lbs. (140 kg) for ViO55-5B.
- Ask your dealer to mount a hook on the bucket.

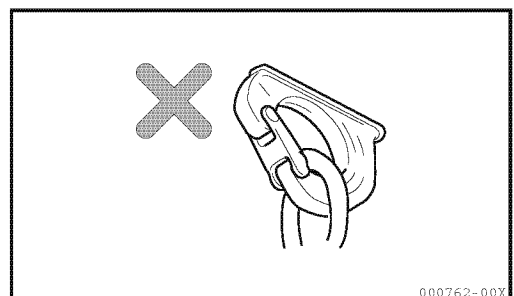
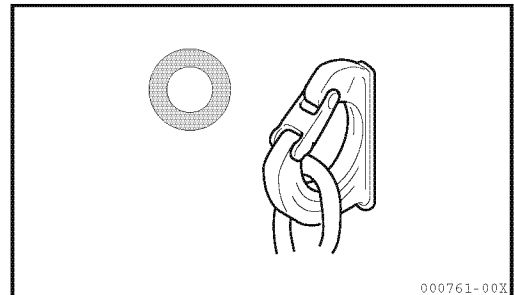

## 33. Optional Parts and Attachments

### 33-1. Optional parts and attachments

The following options are available. Select options useful for your work.

If you need an option, contact your dealer.

- **Bucket (Teeth...Point type)**

| Width in. (mm) | Capacity cu.ft (cu.m) | Remarks                    |
|----------------|-----------------------|----------------------------|
| 17.7 (450)     | 3.53 (0.10)           |                            |
| 23.6 (600)     | 4.59 (0.13)           |                            |
| 25.6 (650)     | 4.94 (0.14)           | ViO45-5B Standard          |
| 27.6 (700)     | 5.65 (0.16)           | ViO55-5B Standard          |
| 29.5 (750)     | 6.36 (0.18)           | Not available for ViO45-5B |

# 34. Handling Air Conditioner (for Cabin)

## 34-1. Description of lever and switches for air conditioner

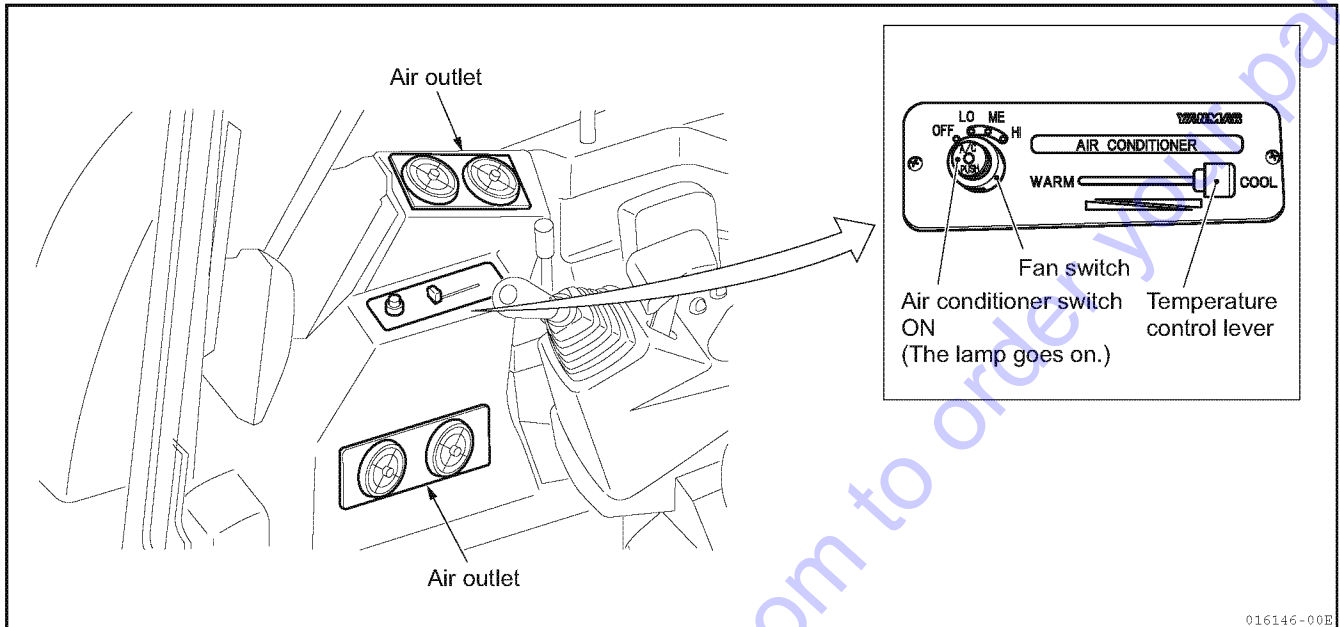

### Temperature control lever :

It is used to control the temperature of the air blown by the air conditioner.

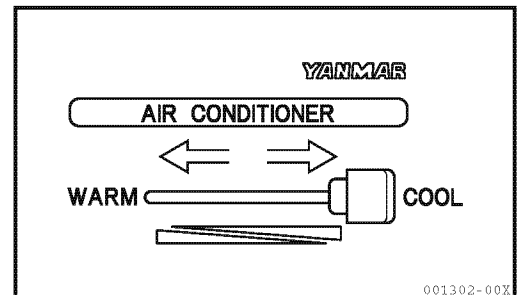

### Fan switch :

It is used to set the air volume at one of the three levels.

- LO : Low
- ME : Medium
- HI : High
- OFF : Stop

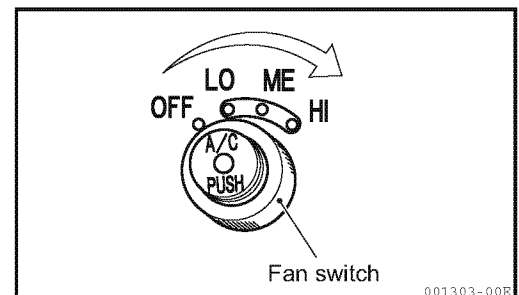

### Air conditioner switch :

It is used to turn the compressor ON or OFF.



The compressor is turned OFF : The lamp goes off.



The compressor is turned ON : The lamp goes on.

Press the switch in the OFF state to turn the compressor ON, and press it again to turn the compressor OFF. When the fan switch is at the OFF position, the lamp does not go on and the compressor does not work even if the air conditioner switch is turned ON.

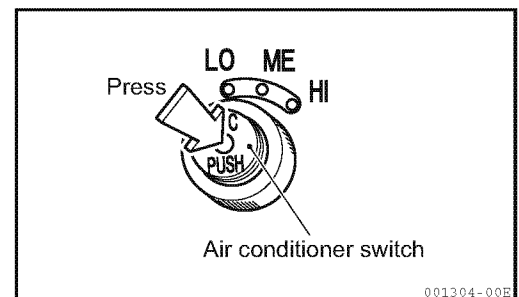

## 34-2. How to use air conditioner

**⚠ CAUTION**

- The eyes might get sore from smoking when the cabin is air conditioned. Ventilate the cabin by opening the window slightly when smoking.
- Some mist might blow off with cooled air when the cabin is air conditioned. This occurs because the water particles in the wet air are frozen and blown out. So, it is not abnormal.
- When using the air conditioner after parking the cabin in the hot weather, ventilate the cabin by opening the door and windows to let the hot air inside go out of the cabin so that the air-conditioning can work efficiently.
- Take care to adjust the temperature properly not to cool the air inside the cabin too long because it is not good for the operator's health.
- If the air does not blow off, the air volume is small or the cabin is not air conditioned well when the air conditioner is turned ON, turn the air conditioner switch OFF and ask your dealer to check the air conditioner. If you keep using the air conditioner in the abnormal state, it will cause damage to the fan motor or the compressor.
- Even in the seasons when the air conditioner is not used, operate the air conditioner for a few minutes once or twice every two or three weeks. That prevents the rotating parts such as the compressor from running out of oil, which prevents malfunction of the parts in turn.

**34-2-1. Air conditioning**

- 1) Set the fan switch at any of the three positions (Low, Medium or High).
- 2) Set the temperature control lever at the COOL position (the right position).
- 3) Turn the air conditioner switch ON. (The lamp goes on.)
- 4) Adjust the temperature inside the cabin properly with the temperature control lever and the fan switch after the cabin is cooled off.

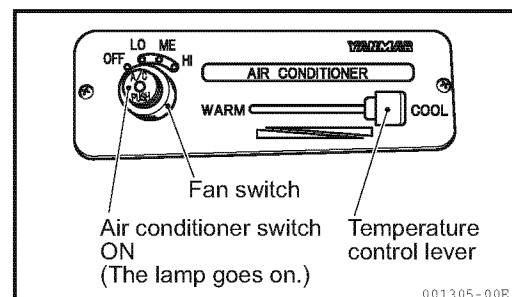

### 34. Handling Air Conditioner (for Cabin)

5) Adjust the air direction with the air outlet grille.

- Set the fan switch for ventilation to apply preload to the inside of the cabin when the air conditioner is not used, so that no dust can come into the cabin easily during operation.

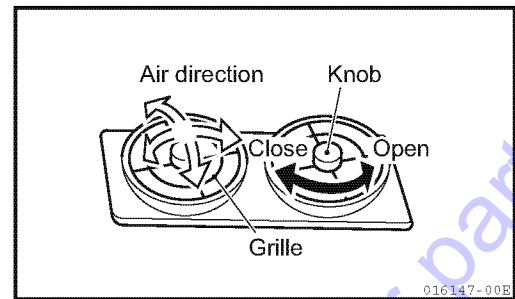

#### IMPORTANT

**Be sure to turn the air conditioner ON after starting the engine to prevent excessive force to the compressor etc.**

#### 34-2-2. Heating

- 1) Set the fan switch at any of the three positions (Low, Medium or High).
- 2) Set the temperature control lever at the WARM position (the left position).
- 3) Turn the air conditioner switch OFF. (The lamp goes off.)

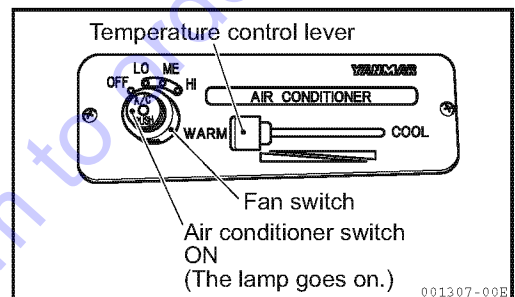

#### 34-2-3. Heating for dehumidification

(In the case that the window glass tends to get fogged in rainy weather in spring or autumn.)

With the heating turned on, turn the air conditioner switch ON (the lamp goes on).

- If the temperature inside the cabin is low, dehumidification might not work because the compressor does not operate even if the air conditioner switch is turned ON.

#### 34-2-4. Stop

- 1) Turn the air conditioner switch OFF. (The lamp goes off.)
  - 2) Turn the fan switch OFF.
- The air conditioner also stops only by turning the fan switch OFF.

**34-3. Maintenance, inspection and servicing of air conditioner**

Daily maintenance and periodic inspection and servicing are required for the air conditioner to use it comfortably in the best condition.

Proper maintenance allows reduction in trouble and longer life of the air conditioner.

Exact inspection and servicing prevent trouble and reduce the cost for repair.

It is recommended that the rubber hoses and electrical wires should be replaced every two years to use the air conditioner in the best condition.

List of inspection items for air conditioner

|                  | Part                    | Check item  | Servicing         |
|------------------|-------------------------|---|-------------------|
| Daily inspection | Condenser               | Check the cover and the fin for contamination and clogging. | Clean             |
|                  | Compressor driving belt | Check the belt for tension and damage.                      | Repair or replace |
|                  | Sight glass             | Check the refrigerant quantity.                             |                   |

**34-3-1. Checking and cleaning condenser**

**⚠ WARNING**

- Be sure to stop the engine and remove the starter key before checking and servicing the condenser.
- Be sure to reinstall the cover and other parts, which have been removed for checking and servicing, to their original positions after completion of the work.

Check the condenser cover, if there is any mud or dirt on the cover, then remove the cover to wash it off with water.

- If there is some mud or dirt on the fin, it causes the degradation of the air conditioner performance. Wash it off from the fin with water by using a soft brush.
- If the fin is crushed or deformed, it also causes the deterioration of the air conditioner performance. Repair it with a screwdriver or the like while taking care not to damage the fin.

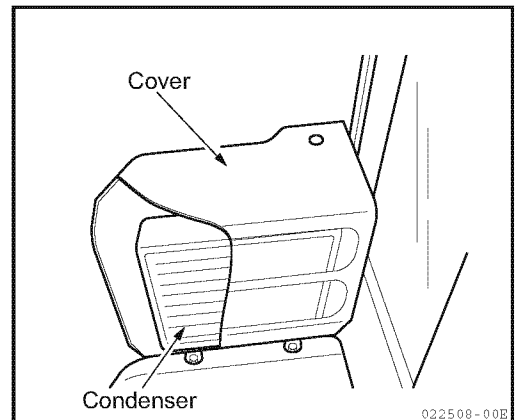



#### 34-3-2. Checking and servicing compressor driving belt

## ⚠ WARNING

Stop the engine and remove the starter key before checking and adjusting the compressor driving belt.

Press the middle of the condenser driving belt to check the slack of the condenser driving belt.

Driving belt

Pressing load : Approx. 22 lbs. (98.1 N)

Adequate slack : 0.3 to 0.35 in. (8 to 9 mm)

If the slack of the belt is inadequate, adjust it according to the following procedure :

1) Remove the cover to press the middle of the belt with a load of approximately 22 lbs. (98.1 N).

Adjust the belt tension by tightening the tension pulley bolt and lock nut, tighten the adjust nut so that the slack of the belt should be adequate.

- If the belt tension cannot be adjusted to the specified slack since the belt has lost its elasticity, replace the belt with a new one.

2) Tighten the tension pulley bolt.

3) Check if each pulley or the belt is damaged especially if the belt has contact with the bottom of the pulley groove.

- If there are any cuts on the belt or cracks in it, replace it with a new one.

**Compressor driving belt :**

**Mitsuboshi : MPMF-6370 or its equivalent**

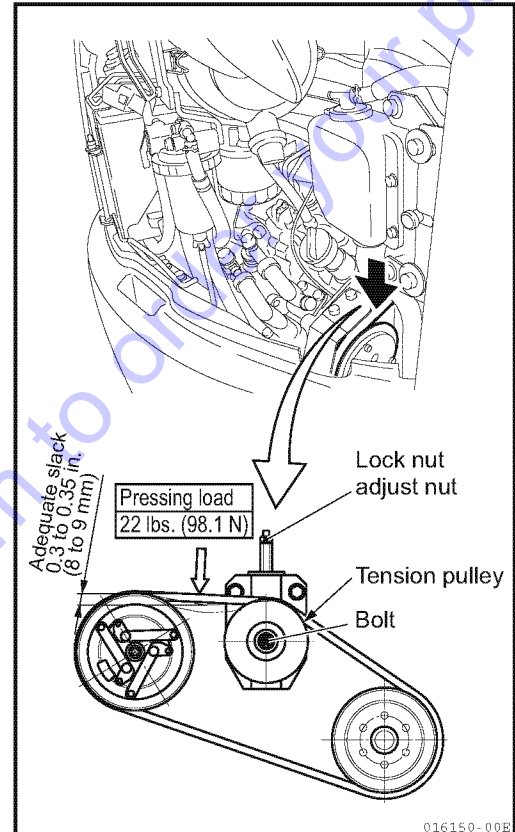

**34-3-3. Checking refrigerant quantity**

Open the engine hood B to see the flow of the refrigerant air foam from the sight glass (inspection window) of the liquid tank according to the following procedure to check the refrigerant quantity.

- 1) Start the engine and run it at the maximum speed.
- 2) Set the fan switch at "High".
- 3) Set the temperature control lever at "COOL" (the right position).
- 4) Turn the air conditioner switch ON. (The lamp goes on.)
- 5) Check the refrigerant condition from the sight glass and compare it with the check list shown below.

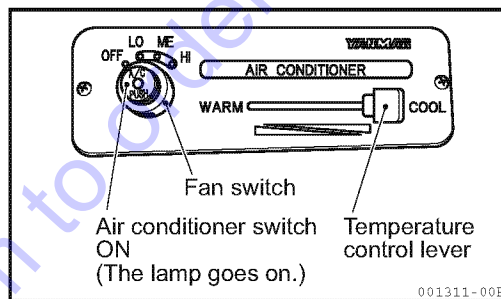
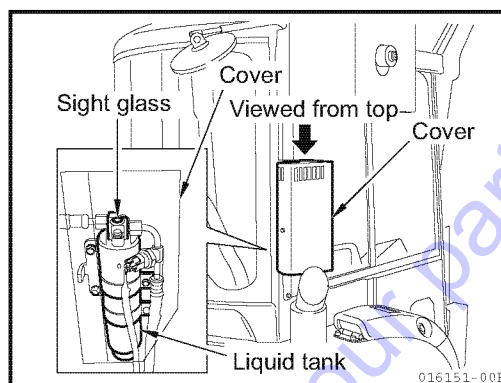

**IMPORTANT**

**If the refrigerant quantity is not normal, ask your dealer for check and repair.**

**Check list for refrigerant quantity**

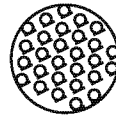
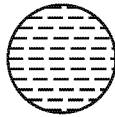
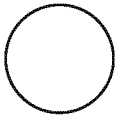
| Cooler state                               | Normal  | Abnormal   |  |  |
|--|---|--|--|--|
| Temperature of high and low pressure pipes | Temperature difference is big.<br>High pressure pipe : hot<br>Low pressure pipe : cold<br>Compressor discharge side temp. : 158°F (70°C)<br>Compressor intake side temp. : 41°F (5°C)                             | High pressure pipe is warm and low pressure pipe is rather cold.<br>Temperature difference is not so big.  | There is almost no difference in temperature between high and low pressure pipes.  | High pressure pipe is hot and low pressure pipe is rather warm.<br>There is some difference in temperature between them.   |
| Sight glass                                | Almost transparent.<br>Even if air foam flow is seen, it becomes transparent as the engine speed changes.<br><br>001312-00X *1 | Air foam flow can always be seen. It is sometimes transparent or white.<br><br>001313-00X | Flow of mist or the like can be seen slightly.<br><br>001314-00X | No air foam flow can be seen by fully opening cabin windows, idling engine, and rotating fan to the maximum.<br><br>001315-00X *2 |
| Pipe joints                                | Normal  | Some parts are contaminated by oil.  | Some parts are badly contaminated by oil.  | Normal   |
| Refrigerant quantity                       | The quantity is adequate and normal.  | Refrigerant might leak in a small amount from some part.   | Almost all refrigerant leaks and does not remain.  | Refrigerant is too much.   |

\*1 : When the outside air temperature is low, air foam might be seen even if the refrigerant quantity is adequate.

\*2 : No air foam can be seen either when there is no refrigerant. Therefore, be sure to check the difference in temperature between the high and low pressure pipes.



Copyright© 2010 YANMAR CONSTRUCTION EQUIPMENT CO., LTD. All Rights Reserved.  
This manual may not be reproduced or copied in whole or in part, without the written consent of  
YANMAR CONSTRUCTION EQUIPMENT CO., LTD.

**YANMAR CONSTRUCTION EQUIPMENT CO.,LTD.**

# PARTS FINDER

**Search Website  
by Part Number**



**Search Manual  
Library For Parts  
Manual & Lookup Part  
Numbers – Purchase  
or Request Quote**

**Search Manuals**

Enter your information to help us find the right parts manual for your machine.

\* Brand:

\* Model:

\* Serial:

\* Part Number:

SEARCH

**Can't Find Part or  
Manual? Request Help  
by Manufacturer,  
Model & Description**

**Parts Order Form**

Please fill in the following information to help us find the right part for your machine.

|               |                      |
|---------------|----------------------|
| Manufacturer: | <input type="text"/> |
| Model:        | <input type="text"/> |
| Description:  | <input type="text"/> |
| Part Number:  | <input type="text"/> |
| Quantity:     | <input type="text"/> |
| Notes:        | <input type="text"/> |

Submit

Discount-Equipment.com is your online resource for quality parts & equipment.

Florida: **561-964-4949** Outside Florida TOLL FREE: **877-690-3101**

**Need parts?**

Click on this link: <http://www.discount-equipment.com/category/5443-parts/> and choose one of the options to help get the right parts and equipment you are looking for. Please have the machine model and serial number available in order to help us get you the correct parts. If you don't find the part on the website or on one of the online manuals, please fill out the request form and one of our experienced staff members will get back to you with a quote for the right part that your machine needs.

We sell worldwide for the brands: Genie, Terex, JLG, MultiQuip, Mikasa, Essick, Whiteman, Mayco, Toro Stone, Diamond Products, Generac Magnum, Airman, Haulotte, Barreto, Power Blanket, Nifty Lift, Atlas Copco, Chicago Pneumatic, Allmand, Miller Curber, Skyjack, Lull, Skytrak, Tsurumi, Husquvarna Target, Stow, Wacker, Sakai, Mi-T-M, Sullair, Basic, Dynapac, MBW, Weber, Bartell, Bennar Newman, Haulotte, Ditch Runner, Menegotti, Morrison, Contec, Buddy, Crown, Edco, Wyco, Bomag, Laymor, EZ Trench, Bil-Jax, F.S. Curtis, Gehl Pavers, Heli, Honda, ICS/PowerGrit, IHI, Partner, Imer, Clipper, MMD, Koshin, Rice, CH&E, General Equipment, Amida, Coleman, NAC, Gradall, Square Shooter, Kent, Stanley, Tamco, Toku, Hatz, Kohler, Robin, Wisconsin, Northrock, Oztec, Toker TK, Rol-Air, APT, Wylie, Ingersoll Rand / Doosan, Innovatech, Con X, Ammann, Mecalac, Makinex, Smith Surface Prep, Small Line, Wanco, Yanmar