



YANMAR

MINI EXCAVATOR

Universal

ViO_{45-5B} ViO_{55-5B}

YANMAR Vio Series
True Zero Tail Swing Excavator

**Discount
Equipment**

www.discount-equipment.com

YANMAR - YOUR BEST PARTNER FOR BUILDING THE FUTURE

TO PURCHASE THIS PRODUCT PLEASE CONTACT US



**Equipment Financing and
Extended Warranties Available**



**Discount-Equipment.com is your online resource for
commercial and industrial quality parts and equipment sales.**

561-964-4949

visit us on line @ www.discount-equipment.com

Select an option below to find your Equipment

Search by Manufacturer

Search by Product Type

Request a Quote

We sell worldwide for the brands: Genie, Terex, JLG, MultiQuip, Mikasa, Essick, Whiteman, Mayco, Toro Stone, Diamond Products, Generac Magnum, Airman, Haulotte, Barreto, Power Blanket, Nifty Lift, Atlas Copco, Chicago Pneumatic, Allmand, Miller Curber, Skyjack, Lull, Skytrak, Tsurumi, Husquvarna Target, Stow, Wacker, Sakai, Mi-T-M, Sullair, Basic, Dynapac, MBW, Weber, Bartell, Bennar Newman, Haulotte, Ditch Runner, Menegotti, Morrison, Contec, Buddy, Crown, Edco, Wyco, Bomag, Laymor, EZ Trench, Bil-Jax, F.S. Curtis, Gehl Pavers, Heli, Honda, ICS/PowerGrit, IHI, Partner, Imer, Clipper, MMD, Koshin, Rice, CH&E, General Equipment, Amida, Coleman, NAC, Gradall, Square Shooter, Kent, Stanley, Tamco, Toku, Hatz, Kohler, Robin, Wisconsin, Northrock, Oztec, Toker TK, Rol-Air, APT, Wylie, Ingersoll Rand / Doosan, Innovatech, Con X, Ammann, Mecalac, Makinex, Smith Surface Prep, Small Line, Wanco, Yanmar

The Mini Excavator, Reinvented by Yanmar

A Whole Line Up of High Performance Features for Professionals

Fast and Easy Bucket Attachment Changing

The Hydraulic Quick Coupler Makes Bucket Attachment and Removal Quick and Clean

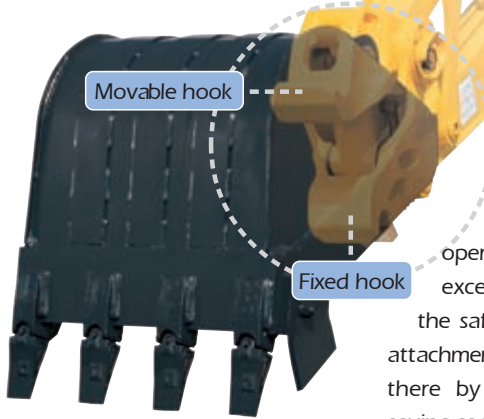

The Quick Coupler makes the once troublesome task of changing buckets fast and easy without even getting your hands dirty. It's all performed by switch operation while you remain seated, except for fitting and removal of the safety lock pin. You can also use attachments made by other companies, there by reducing storage costs and saving space.

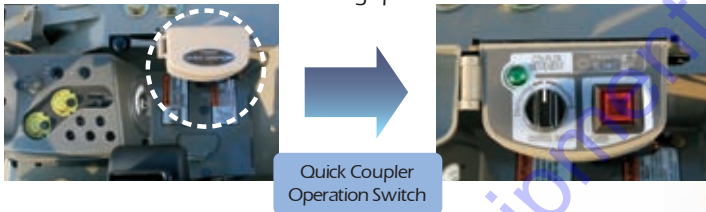

Bucket Removal



Bucket Attachment

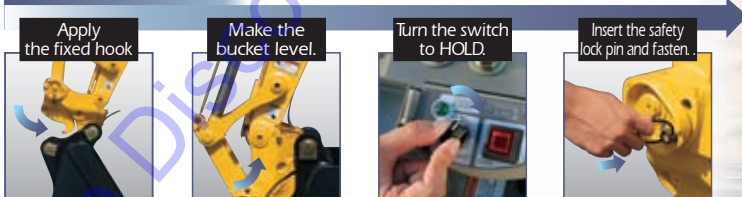

YANMAR

Originality

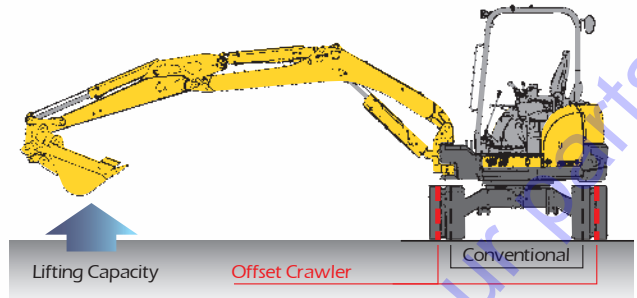

Stability Equal to a Standard-sized Machine
Highly Balanced Structure

The Yanmar-devised Offset Crawler Holds onto the Ground with a Broad, Firm Grip



Excellent Front Turning, Too

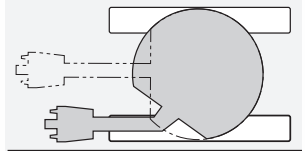

No Sticking Out

**True Zero Tail Swing,
 No Bother at the Rear**

Side Ditch Digging up to the Wall with Nothing Sticking Out beyond the Track

VIPPS (3 pumps activate each movements)

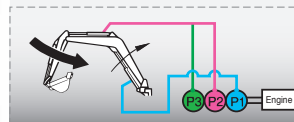

ARM x Boom
 pump 2+pump 3 activate "ARM"
 pump 1 activates "BOOM"

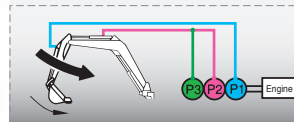

ARM x Bucket
 pump 1 activates "BUCKET"
 pump 2+pump 3 activate "ARM"

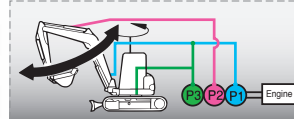

ARM x Bucket x Swivel
 pump 1+pump 3 activate "BOOM"
 pump 2 activates "ARM"
 pump 3 activates "SWIVEL"

Smooth even while using both the boom and arm during turning!

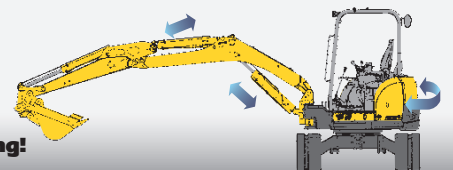

Operation So Easy it's a Joy

All-Round Comfort and Convenience

Large Space for Unrestricted Operation

Even a zero tail swing, the cabin is the largest in this class to provide easy and unrestricted operating space. The big seat reduces operating stress and fatigue.

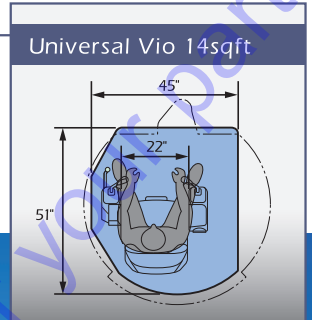

The powerful air conditioner provides the same comfort as in an air-conditioned passenger car. (Cabin spec.)



The convenient light arrangement expands the operator's range of sight excellent for night work.

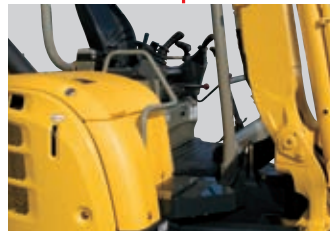

Get on and off from the either side. Walk-through operator's area (Canopy spec.)



Socket-convenient for charging mobile telephones or other appliances.

Broad Range of Sight for Safe and Comfortable Operation

The standard, lightweight canopy has ROPS and FOPS to protect the operator in rollovers and from falling objects. No wall hinders the view. Work is safe and efficient.

(Cabin specs. for ROPS and FOPS.)



Lever operation from the wrist and the armrest alleviate the fatigue of a long working day.

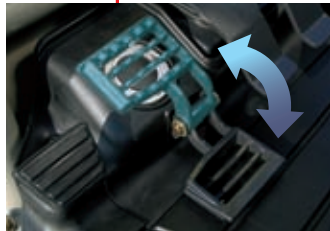

Foldable footrests for ample legroom



Large traveling pedal



Hand control for remote hydraulics

Proven Durability and Ease of Maintenance

Simple Engine Access Brings Big Improvements to Maintenance Efficiency



Daily Checks

Just open the rear engine cover to check the battery and engine oil, clean the air cleaner and replenish cooling water.



Checking and Cleaning the Radiator

The right-hand cover is opened by loosening just two bolts. Open the maintenance cover on the top right hand side to clean quickly and easily behind the radiator.



Hood

Open the hood for easy access to the alternator and the handy tool storage tray.



Replacing the Implement Hose

Remove the right-hand step to reveal the hose joint at the front of the frame. Replacement of the hydraulic hose is simple if necessary.

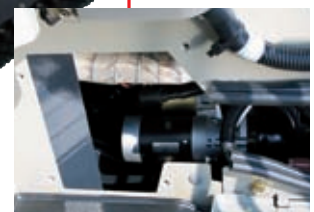

Electric Motor

Open the cover beneath the operator's seat and then the side cover to reveal the starter motor.

Cylinder Guard and Underside Protector for Damage Protection

The plate spring cylinder guard is resilient against shocks and used to protect the bucket arm and boom cylinders. The frame corners are reinforced with ultra-high strength steel. The side cover has a thicker plate for higher resilience.



Underside protector



Cylinder guard

Lifting capacity

Excavator equipped with ROPS and rubber crawlers (without quick coupler and bucket)

r: Reach from swing center line : ft-in(mm)

h: Lift point height : ft-in(mm)

w: Lifting capacity : lbs(kg)

P: Load point

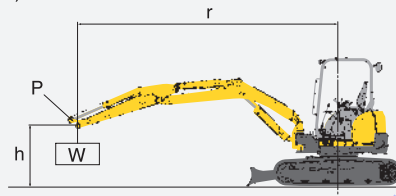
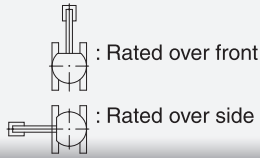

- The rated lifting capacities that are indicated below are based on ISO 10567 and do not exceed 87% of the excavator's hydraulic lifting capacity or 75% of its static tilt load (tipping load) capacity.
- The following operating criteria are also applicable to the calculation of these maximum loads;
 - The "load point" is the location of the front bolt on the arm.
 - The three indicated machine positions are :
 - arm over the front end (blade down),
 - arm over the front end (blade up), and
 - arm over the side (blade up).
 - The operating cylinder is the boom cylinder.
- The weight of the excavator's bucket, hook, sling and other lifting accessories have been taken into consideration when calculating these maximum loads.

Vio45-5B

LIFT POINT HEIGHT	r:REACH ft-in (mm)				r:REACH ft-in (mm)				r:REACH ft-in (mm)			
h:ft-in (mm)	RATED LIFT CAPACITY OVER END BLADE DOWN lbs (kg)				RATED LIFT CAPACITY OVER END BLADE UP lbs (kg)				RATED LIFT CAPACITY OVER SIDE BLADE DOWN lbs (kg)			
	MAX	13'1" (4000)	9'10" (3000)	8'3" (2500)	MAX	13'1" (4000)	9'10" (3000)	8'3" (2500)	MAX	13'1" (4000)	9'10" (3000)	8'3" (2500)
13'1" (4000)	*1768(802)				*1740(789)				*1808(820)			
9'10" (3000)	*1808(820)	*1760(798)	*2507(1137)	*3063(1389)	1327(602)	*1702(772)	*2412(1094)	*2988(1355)	1261(572)	*1749(793)		
6'7" (2000)	*2000(907)	*2018(915)	*3409(1546)	*4580(2077)	1144(519)	1559(707)	2344(1063)	3294(1494)	1078(489)	1493(677)	*2430(1102)	*2988(1355)
3'3" (1000)	*2000(907)	*2384(1081)	*3821(1733)	*4800(2177)	1120(508)	1493(677)	2320(1052)	3080(1397)	1021(463)	1394(632)	2179(988)	3294(1494)
Ground (0)	*2115(959)	*2564(1163)	*3638(1650)	*4494(2038)	1162(527)	1475(669)	2220(1007)	2961(1352)	1069(485)	1327(602)	2121(962)	3080(1397)
-3'3" (-1000)	*2267(1028)	*2401(1089)	*2708(1228)	*3457(1568)	1376(624)	1460(662)	2335(1059)	2972(1348)	1261(572)	1327(602)	2070(939)	2981(1352)
-6'7" (-2000)	*2287(1037)				1989(902)				1890(857)		2187(992)	2972(1348)

Vio55-5B

LIFT POINT HEIGHT	r:REACH ft-in (mm)				r:REACH ft-in (mm)				r:REACH ft-in (mm)			
h:ft-in (mm)	RATED LIFT CAPACITY OVER END BLADE DOWN lbs (kg)				RATED LIFT CAPACITY OVER END BLADE UP lbs (kg)				RATED LIFT CAPACITY OVER SIDE BLADE DOWN lbs (kg)			
	MAX	13'1" (4000)	9'10" (3000)	8'3" (2500)	MAX	13'1" (4000)	9'10" (3000)	8'3" (2500)	MAX	13'1" (4000)	9'10" (3000)	8'3" (2500)
13'1" (4000)	*2075(941)	*1969(893)			*2018(915)	*1923(872)			*2055(932)	*1969(893)		
9'10" (3000)	*2055(932)	*2046(928)			1475(669)	*2057(933)			1409(639)	*2057(933)		
6'7" (2000)	*2095(950)	*2441(1107)	*3246(1472)	*4051(1837)	1327(602)	2029(920)	*3226(1463)	*3993(1811)	1244(564)	1956(867)	3246(1472)	3993(1811)
3'3" (1000)	*2152(976)	*2822(1280)	*4051(1837)	*5528(2507)	1277(579)	2004(909)	2915(1322)	4055(1839)	1211(549)	1824(827)	2717(1232)	3658(1659)
Ground (0)	*2209(1002)	*3111(1411)	*4494(2038)	*5585(2533)	1327(602)	1905(864)	2930(1329)	3808(1727)	1252(568)	1824(827)	2699(1224)	3435(1558)
-3'3" (-1000)	*2267(1028)	*2900(1315)	*4120(1959)	*5221(2368)	1484(673)	1839(834)	2831(1284)	3709(1682)	1409(639)	1749(793)	2683(1217)	3468(1543)
-6'7" (-2000)	*2209(1002)			*4242(1924)	1923(872)			3658(1659)	1824(827)			3625(1644)

Note : The maximum loads marked with an asterisk (*) were limited by the Excavator's hydraulic lifting capacity rather than by its static tilt load (tipping load) capacity.

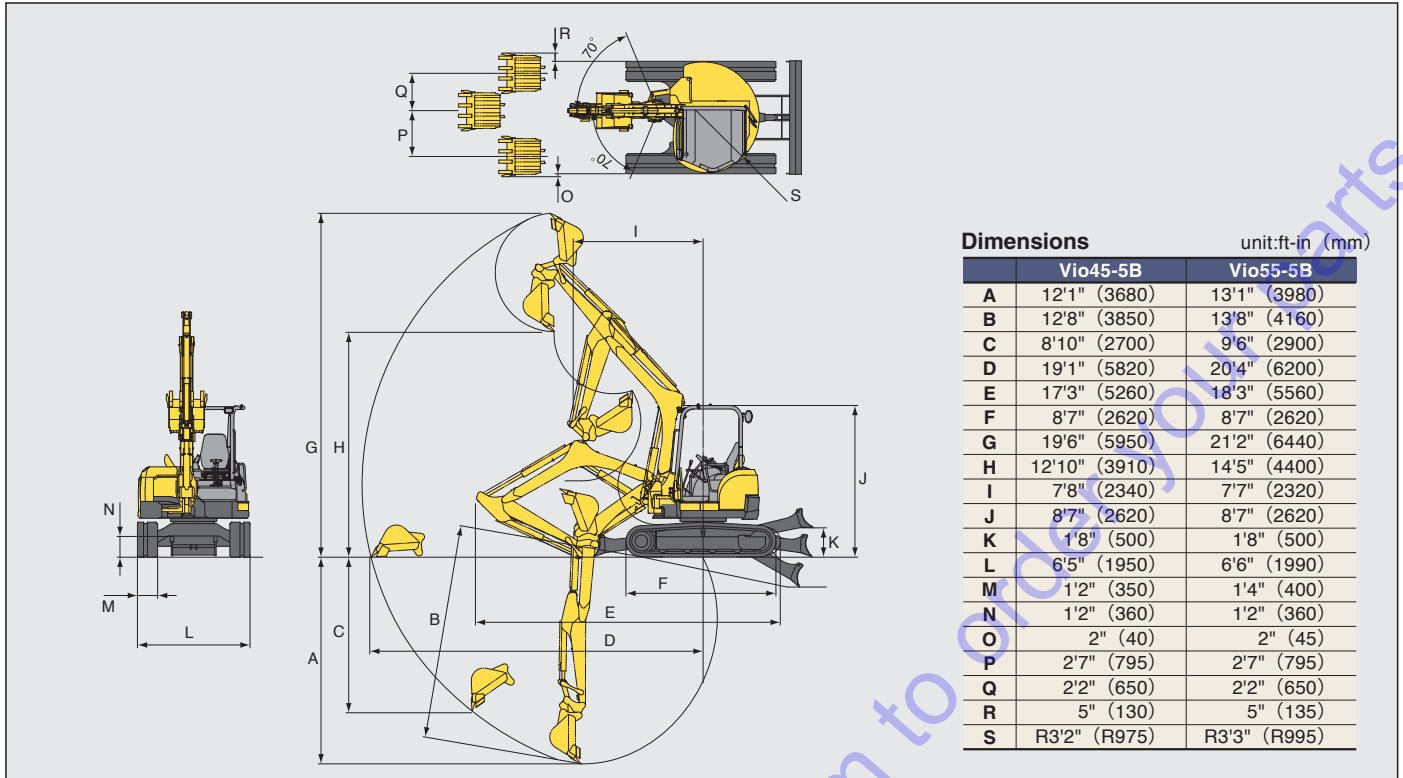

	Dimensions	
	unit:ft-in (mm)	
	Vio45-5B	Vio55-5B
A	12'1" (3680)	13'1" (3980)
B	12'8" (3850)	13'8" (4160)
C	8'10" (2700)	9'6" (2900)
D	19'1" (5820)	20'4" (6200)
E	17'3" (5260)	18'3" (5560)
F	8'7" (2620)	8'7" (2620)
G	19'6" (5950)	21'2" (6440)
H	12'10" (3910)	14'5" (4400)
I	7'8" (2340)	7'7" (2320)
J	8'7" (2620)	8'7" (2620)
K	1'8" (500)	1'8" (500)
L	6'5" (1950)	6'6" (1990)
M	1'2" (350)	1'4" (400)
N	1'2" (360)	1'2" (360)
O	2" (40)	2" (45)
P	2'7" (795)	2'7" (795)
Q	2'2" (650)	2'2" (650)
R	5" (130)	5" (135)
S	R3'2" (R975)	R3'3" (R995)

Specifications

Model	Type	Vio45-5B		Vio55-5B		
		Canopy	Cabin	Canopy	Cabin	
Operating weight	Rubber track	lbs (kg)	10275 (4660)	10562 (4790)	11532 (5230)	11819 (5360)
	Steel track	lbs (kg)	10408 (4720)	10694 (4850)	11576 (5250)	11863 (5380)
Engine	Type	Water-cooled 4 cycle diesel				
	Model	YANMAR 4TNV88-BXBV				
	Output	hp (kW) /RPM	39.5 (29.5) /2400			
Performance	Max. digging force, bucket/arm	lbs (kN)	6722 (29.9) /4995 (22.2)		7598 (33.8) /5062 (22.5)	
	Traveling speed	MPH (km/h)	2.8/1.4 (4.6/2.3)		2.7/1.4 (4.4/2.3)	
	Swing speed	RPM	10.0			
	Boom swing angle, (L/R)	degrees	70/70			
Ground contact pressure	Rubber track	PSI (kPa)	4.19 (28.9)	4.31 (29.7)	4.10 (28.3)	4.22 (29.1)
	Steel track	PSI (kPa)	3.76 (25.9)	3.86 (26.6)	4.18 (28.8)	4.28 (29.5)
Hydraulic system	Pump capacity	GPM	10.6+10.6+10.6+3.1			
		(L/min)	40.3+40.3+40.3+11.7			
	Main relief set pressure	PSI (MPa)	3133 (21.6)		3553 (24.5)	
Undercarriage	Track type	Rubber or Steel				
Blade dimensions	Width x height	ft-in (mm)	6'6" x 1'4" (1970x400)			
Fuel tank capacity		Gals (L)	16.9 (64)			

Hydraulic P.T.O.

Model	Output	Vio45-5B		Vio55-5B			
		PSI (MPa)	GPM (L/min)	PSI (MPa)	GPM (L/min)		
Specification			2400RPM	1200RPM	2400RPM	1200RPM	
Combined flow, double actions		3133 (21.6)	19.7 (74.6)	9.8 (37.3)	3553 (24.5)	21.3 (80.6)	10.6 (40.3)

Standard equipment

<ul style="list-style-type: none"> Blade Boom swing function Rubber or Steel tracks Hydraulic quick coupler 2way control pattern change Auxiliary valve and piping (arm end) Cylinder cover (boom, arm, bucket, blade) 	<ul style="list-style-type: none"> ROPS / FOPS cabin or canopy Windshield washer (cabin spec) Defroster (cabin spec) Joystick pilot controls Arm rests (adjustable) Suspension and reclining seat 	<ul style="list-style-type: none"> Seat belt Traveling levers and pedals Traveling alarm Built-in type boom light Exterior canopy or cabin work light Operation manual 	<p>(Please note that the standard equipment may vary from this list. Consult your Yanmar dealer for confirmation)</p>
---	---	--	---

YANMAR AMERICA CORP.

Note : All information presented in this Brochure is subject to change without notice.



www.discount-equipment.com

Printed in U.S.A.

TO PURCHASE THIS PRODUCT PLEASE CONTACT US



**Equipment Financing and
Extended Warranties Available**



**Discount-Equipment.com is your online resource for
commercial and industrial quality parts and equipment sales.**

561-964-4949

visit us on line @ www.discount-equipment.com

Select an option below to find your Equipment

Search by Manufacturer

Search by Product Type

Request a Quote

We sell worldwide for the brands: Genie, Terex, JLG, MultiQuip, Mikasa, Essick, Whiteman, Mayco, Toro Stone, Diamond Products, Generac Magnum, Airman, Haulotte, Barreto, Power Blanket, Nifty Lift, Atlas Copco, Chicago Pneumatic, Allmand, Miller Curber, Skyjack, Lull, Skytrak, Tsurumi, Husquvarna Target, Stow, Wacker, Sakai, Mi-T-M, Sullair, Basic, Dynapac, MBW, Weber, Bartell, Bennar Newman, Haulotte, Ditch Runner, Menegotti, Morrison, Contec, Buddy, Crown, Edco, Wyco, Bomag, Laymor, EZ Trench, Bil-Jax, F.S. Curtis, Gehl Pavers, Heli, Honda, ICS/PowerGrit, IHI, Partner, Imer, Clipper, MMD, Koshin, Rice, CH&E, General Equipment, Amida, Coleman, NAC, Gradall, Square Shooter, Kent, Stanley, Tamco, Toku, Hatz, Kohler, Robin, Wisconsin, Northrock, Oztec, Toker TK, Rol-Air, APT, Wylie, Ingersoll Rand / Doosan, Innovatech, Con X, Ammann, Mecalac, Makinex, Smith Surface Prep, Small Line, Wanco, Yanmar