



TELEHANDLER ATTACHMENT CATALOG

• PIPE GRAPPLE • TRUSS BOOMS • TRASH HOPPER • WORK PLATFORMS • MATERIAL BUCKETS • SWING CARRIAGES • FO

www.Discount-Equipment.com

**Discount
Equipment**

JLG

JLG Genuine Attachments and Forks for JLG®, Gradall, SkyTrak® and Lull Telehandlers

Quick Reference Attachment Guide, By Model 4

CURRENT PRODUCTION MODELS

742/943/1043 8
 1055 9
 1255 10
 1644/1732 11
 G5-18A 12
 SkyTrak T4F 13

CURRENT AND NON-CURRENT ATTACHMENTS

Attachment Catalog/Load Chart Information 14

Carriages

Dual Fork Positioning Carriage 15
 Side-Shift Carriage 17
 Side-Tilt Carriage 19
 Standard Carriage 23
 Swing Carriage 28
 Tower Carriage 31

Auger 34

Bale Clamp 36

Buckets

4-in-1 Bucket 37
 Fork Mounted Bucket 38
 Grapple Bucket 40
 Material Bucket 43

Coupler Mounted Lifting Hook 47

Fork Mounted Lifting Hook 49

Fork Mounted Work Platform 52

Fork Mounted Extendable Truss Boom 55

Material Handling Arm 56

Pipe Grapple 58

Round Fork Tines 59

Sheet Material Adapter 60

Sweeper 63

Trash Hopper 65

Truss Boom 67

Universal Skid Steer Adapter 70

Quick Coupling Assembly 70

FORKS

Forks - Pallet, Cubing, Drywall and Lumber 71

Fork Pins/Bars 80

Fork Extensions 81

Fork Caliper 83

To Place an Order

- Online: onlineexpress2.jlg.com
- Call: 1-877-JLG-LIFT (1-877-554-5438)
- Fax: 1-800-733-8939
- Email: partsprograms@jlg.com

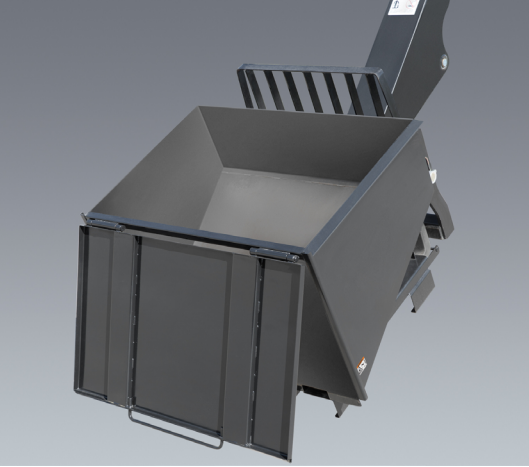

QUICK REFERENCE ATTACHMENT GUIDE

		Dual Fork Positioning Page 15	Side-Shift Page 17	Side Tilt Page 19	Standard Page 23	Swing Page 28	Tower Page 31	Auger Page 34	Bale Clamp Page 36	4 in 1 Bucket Page 37	Fork Mounted Bucket Page 38	Grapple Bucket Page 40	Material Bucket Page 43	Coupler Mounted Lifting Hook Page 47
JLG														
CURRENT	742
	943
	1043
	1055
	1255
	1644
	1732
	G5-18A
NON-CURRENT	642
	619A
	723A
	G5-19A
	G6-23A
	G6-42A
	G9-43A
	G10-43A
	G10-55A
	G12-55A
	G15-44A
TF6-42	
SkyTrak														
CURRENT	6036
	6042
	8042
	10042
	10054
NON-CURRENT	4266
	4270
	4290
	5028

Not all versions of each model will support all of the noted attachments. Please verify that your exact machine can support the desired attachment by checking the detailed attachment page prior to placing an order

QUICK REFERENCE ATTACHMENT GUIDE

		Fork Mounted Lifting Hook Page 49	Fork Mounted Platform Page 52	Fork Mounted Truss Boom Page 55	Material Handling Arm Page 56	Pipe Grapple Page 58	Round Fork Tines Page 59	Sheet Material Adapter Page 60	Sweeper Page 63	Trash Hopper Page 65	Truss Boom Page 67	Skid Steer Adapter Page 70	Forks Page 71	Fork Extensions Page 81
JLG														
CURRENT	742
	943
	1043
	1055
	1255
	1644
	1732
	G5-18A
NON-CURRENT	642
	619A
	723A
	G5-19A
	G6-23A
	G6-42A
	G9-43A
	G10-43A
	G10-55A
	G12-55A
	G15-44A
TF6-42	
SkyTrak														
CURRENT	6036
	6042
	8042
	10042
	10054
NON-CURRENT	4266
	4270
	4290
	5028

Not all versions of each model will support all of the noted attachments. Please verify that your exact machine can support the desired attachment by checking the detailed attachment page prior to placing an order

QUICK REFERENCE ATTACHMENT GUIDE

	Dual Fork Positioning Page 15	Side-Shift Page 17	Side Tilt Page 19	Standard Page 23	Swing Page 28	Tower Page 31	Auger Page 34	Bale Clamp Page 36	4 in 1 Bucket Page 37	Fork Mounted Bucket Page 38	Grapple Bucket Page 40	Material Bucket Page 43	Coupler Mounted Lifting Hook Page 47
Lull													
NON-CURRENT	644B-37												
	644B-42												
	644D-34												
	644E-42												
	844C-42												
	944E-42												
	1044C-42												
	1044C-54												
	1044C-54 SII												
	6K-37												
	6K-42												
	8K-42												
	10K-42/10K-54												
Gradall													
NON-CURRENT	522D/524D												
	534C-9												
	534C-10												
	534D-6												
	534D-9												
	534D-10												
	534D10-45												
	534D10-55												
	544C												
	544D												
	G6-42P												

Not all versions of each model will support all of the noted attachments. Please verify that your exact machine can support the desired attachment by checking the detailed attachment page prior to placing an order

QUICK REFERENCE ATTACHMENT GUIDE

	Fork Mounted Lifting Hook Page 49	Fork Mounted Platform Page 52	Fork Mounted Truss Boom Page 55	Material Handling Arm Page 56	Pipe Grapple Page 58	Round Fork Tines Page 59	Sheet Material Adapter Page 60	Sweeper Page 63	Trash Hopper Page 65	Truss Boom Page 67	Skid Steer Adapter Page 70	Forks Page 71	Fork Extensions Page 81
Lull													
NON-CURRENT	644B-37												
	644B-42												
	644D-34												
	644E-42												
	844C-42												
	944E-42												
	1044C-42												
	1044C-54												
	1044C-54 SII												
	6K-37												
	6K-42												
	8K-42												
	10K-42/10K-54												
Gradall													
NON-CURRENT	522D/524D												
	534C-9												
	534C-10												
	534D-6												
	534D-9												
	534D-10												
	534D10-45												
	534D10-55												
	544C												
	544D												
	G6-42P												

Not all versions of each model will support all of the noted attachments. Please verify that your exact machine can support the desired attachment by checking the detailed attachment page prior to placing an order



PART NUMBER	ATTACHMENT
1170021	Carriage, 50" Std, 12K lb.
1170024	Carriage, 60" Std, 12K lb.
1001211516	Carriage, 72" Std, 15K lb.
7301295	Carriage, 50" Dual Fork Positioning, 10K lb.
1001233383	Carriage, 50" Side Tilt, 12K lb.
1001233384	Carriage, 60" Side Tilt, 12K lb.
1001233385	Carriage, 72" Side Tilt, 12K lb.
1001142790	Carriage, 50" Side Shift, 12K lb.
1001095418	Carriage, 72" 90 Deg. Swing, 10K lb.
1001108668	Carriage, 50" Standard W/ 8' Mast, 4.5K lb.
1001218255	Carriage, 50" Elec. Side Tilt W/ 8' Mast, 4.5K lb.
1001100967	Truss Boom, 3' With Winch, 4K lb.
1001099902	Truss Boom, 12' W/O Winch, 2K lb.
1001099351	Truss Boom, 12' With Winch, 2K lb.
1001099901	Truss Boom, 15' W/O Winch, 2K lb.
1001176515	Truss Boom, Adjustable Material Handler
1001100822	Bucket, 72" 1.0 CU YD
1001100823	Bucket, 96" 1.5 CU YD
1001100824	Bucket, 102" 2.0 CU YD
0930020	Bucket, 96" Grapple
1001202904	Sweeper, 0.53 CU YD
1001207606	Hook, Lifting

PART NUMBER	ATTACHMENT
1001230241	Truss Boom, Low Profile, Adjustable
1001195970	Bucket, 60" 13 CU YD
1001195082	Hopper, Trash
1001103637	Work Platform, 4'x8' Domestic 1K lb.
1001103730	Work Platform, 4'x8' ISO 1K lb.
1001103736	Work Platform, 4'x8' French 1K lb.
1001097205	Hook, Crane

PART NUMBER	ATTACHMENT
1001094134	Fork Stops, Kit of 4
1001137512	Fork Extension, 90"

PART NUMBER	ATTACHMENT
2340045	Fork, Pallet, 2.4"x4"x48"
2340038	Fork, Pallet, 2.4"x5"x48"
7301408	Fork, Pallet, 2.4"x4"x48" (use w/ DFP carriage)
1001227379	Fork, Pallet, 2.4"x4"x60" (use w/ DFP carriage)
1001232355	Fork, Pallet, 2.36"x5"x72"
1001099457	Fork, Lumber, 1.6"x5.9"x60"
1001097110	Fork, Lumber, 2"x7"x60"
2340039	Fork, Lumber, 2.36"x6"x60"
1001092391	Fork, Dual Taper, 2"x6"x72"
2340037	Fork, Block, 2"x2"x48"

PART NUMBER	ATTACHMENT
1001146084	Carriage, 50" Std, 12K lb., W/ Lift Lug
1001146086	Carriage, 60" Std, 12K lb., W/ Lift Lug
1001193794	Carriage, 72" Std, 12K lb., W/ Lift Lug
7301295	Carriage, 50" Dual Fork Positioning, 10K lb.
1170054	Carriage, 50" Side Tilt, 10K lb.
1001101956	Carriage, 60" Side Tilt, 10K lb.
1170057	Carriage, 72" Side Tilt, 10K lb.
1001142790	Carriage, 50" Side Shift, 12K lb.
1001095418	Carriage, 72" 90 Deg. Swing, 10K lb.
1001104992	Carriage, 72" 180 Deg. Swing, 8K lb.
1001108668	Carriage, 50" Standard W/ 8' Mast, 4.5K lb.
1001218255	Carriage, 50" Elec. Side Tilt W/ 8' Mast, 4.5K lb.
1001100967	Truss Boom, 3' With Winch, 4K lb.
1001099902	Truss Boom, 12' W/O Winch, 2K lb.
1001099351	Truss Boom, 12' With Winch, 2K lb.
1001099901	Truss Boom, 15' W/O Winch, 2K lb.
1001176515	Truss Boom, Adjustable Material Handler
1001100822	Bucket, 72" 1.0 CU YD
1001100823	Bucket, 96" 1.5 CU YD
1001100824	Bucket, 102" 2.0 CU YD
0930020	Bucket, 96" Multi-Purpose
1001202904	Sweeper, 0.53 CU YD
1001207606	Hook, Lifting
1001142247	Grapple, Pipe

PART NUMBER	ATTACHMENT
1001230241	Truss Boom, Low Profile, Adjustable
1001195970	Bucket, 60" 13 CU YD
1001195082	Hopper, Trash
1001103637	Work Platform, 4'x8' Domestic 1K lb.
1001103730	Work Platform, 4'x8' ISO 1K lb.
1001103736	Work Platform, 4'x8' French 1K lb.
1001097205	Hook, Crane

PART NUMBER	ATTACHMENT
1001094134	Fork Stops, Kit of 4
1001137512	Fork Extension, 90"

PART NUMBER	ATTACHMENT
2340045	Fork, Pallet, 2.4"x4"x48"
2340038	Fork, Pallet, 2.4"x5"x48"
7301408	Fork, Pallet, 2.4"x4"x48" (use w/ DFP carriage)
1001227379	Fork, Pallet, 2.4"x4"x60" (use w/ DFP carriage)
1001232355	Fork, Pallet, 2.36"x5"x72"
1001099457	Fork, Lumber, 1.6"x5.9"x60"
1001097110	Fork, Lumber, 2"x7"x60"
2340039	Fork, Lumber, 2.36"x6"x60"
1001092391	Fork, Dual Taper, 2"x6"x72"
2340037	Fork, Block, 2"x2"x48"

NOTES:
 · Use only JLG approved attachments with proper material handler model/attachment load capacity charts displayed in the operator's cab.
 · Never use your attachment as a work platform or personnel carrier.
 Can't find the attachment you are looking for? Contact your JLG Aftermarket Parts representative at 1-877-JLG-LIFT or visit www.jlg.com.

NOTES:
 · Use only JLG approved attachments with proper material handler model/attachment load capacity charts displayed in the operator's cab.
 · Never use your attachment as a work platform or personnel carrier.
 Can't find the attachment you are looking for? Contact your JLG Aftermarket Parts representative at 1-877-JLG-LIFT or visit www.jlg.com.



PART NUMBER	ATTACHMENT
1001146084	Carriage, 50" Std., 12K lb., W/ Lift Lug
1001146086	Carriage, 60" Std., 12K lb., W/ Lift Lug
1001193794	Carriage, 72" Std., 12K lb., W/ Lift Lug
1001189211	Carriage, 50" Dual Fork Positioning, 12K lb.
1170054	Carriage, 50" Side Tilt, 10K lb.
1001101956	Carriage, 60" Side Tilt, 10K lb.
1170057	Carriage, 72" Side Tilt, 10K lb.
1001142790	Carriage, 50" Side Shift, 12K lb.
1001095418	Carriage, 72" 90 Deg. Swing, 10K lb.
1001104992	Carriage, 72" 180 Deg. Swing, 8K lb.
1001108668	Carriage, 50" Standard W/ 8' Mast, 4.5K lb.
10012188255	Carriage, 50" Elec. Side Tilt W/ 8' Mast, 4.5K lb.
1001100967	Truss Boom, 3' With Winch, 4K lb.
1001099902	Truss Boom, 12' W/O Winch, 2K lb.
1001099351	Truss Boom, 12' With Winch, 2K lb.
1001099901	Truss Boom, 15' W/O Winch, 2K lb.
1001176515	Truss Boom, Adjustable Material Handler
1001100822	Bucket, 72" 1.0 CU YD
1001100823	Bucket, 96" 1.5 CU YD
1001100824	Bucket, 102" 2.0 CU YD
0930020	Bucket, 96" Multi-Purpose
1001202904	Sweeper, 0.53 CU YD
1001207606	Hook, Lifting
1001142247	Grapple, Pipe

PART NUMBER	ATTACHMENT
1001230241	Truss Boom, Low Profile, Adjustable
1001195970	Bucket, 60" 1.3 CU YD
1001195082	Hopper, Trash
1001103637	Work Platform, 4'x8' Domestic 1K lb.
1001103730	Work Platform, 4'x8' ISO 1K lb.
1001103736	Work Platform, 4'x8' French 1K lb.
1001097205	Hook, Crane

PART NUMBER	ATTACHMENT
1001094134	Fork Stops, Kit of 4
1001137512	Fork Extension, 90"

PART NUMBER	ATTACHMENT
2340038	Fork, Pallet, 2.4"x5"x48"
1001232355	Fork, Pallet, 2.36"x5"x72"
1001227382	Fork, Pallet, 2.36"x5"x60"
1001097110	Fork, Lumber, 2"x7"x60"
2340039	Fork, Lumber, 2.36"x6"x60"
1001099457	Fork, Lumber, 1.6"x5.9"x60"
2340037	Fork, Block, 2"x2"x48"
1001092391	Fork, Dual Taper, 2"x6"x72"

PART NUMBER	ATTACHMENT
1001183447	Carriage, 60" Std., 16.8k
1001214415	Carriage, 72" Std., 16.8k
1001192339	Carriage, 87" Std., 16.8k
1001192342	Carriage, 72" Dual Fork Positioning, 16.8k
1001192344	Carriage, 72" Side Shift W/ Dual Fork Positioning, 16.8k
1001192614	Bucket, Multi-Purpose, 94", 2.6 CU YD
1001192615	Bucket, General Purpose, 94", 2.6 CU YD
1001192616	Bucket, Light Material, 94", 5.2 CU YD
1001192617	Bucket, Grapple, 94", 2.6 CU YD
1001228427	Bucket, Multi-Purpose, 94", 1.3 CU YD
1001223435	Bucket, Grapple, 94", 1.7 CU YD
1001192723	Truss Boom, Adjustable Material Handler
1001192649	Clamp, Round Bale
1001192650	Clamp, Square Bale
1001192722	Grapple, Pipe
1001192707	Handler, Tire
1001192732	Handler, Cylinder FUTURE
1001192734	Handler, Log
1001192735	Handler, Steel Coil
1001192702	Winch
1001192700	Hook, Lifting

PART NUMBER	ATTACHMENT
1001192691	Smart Platform, Extendable COMING SOON
1001195970	Bucket, 60" 1.3 CU YD
1001193803	Hook, Lifting

PART NUMBER	ATTACHMENT
1001196778	Fork Transport Latches

PART NUMBER	ATTACHMENT
1001196949	Fork, Pallet, 2.25"x6"x96"
1001196950	Fork, Pallet, 2.25"x6"x72"
1001196951	Fork, Pallet, 2.25"x6"x60"
1001196952	Fork, Pallet, 2.25"x6"x48"

NOTES:
 · Use only JLG approved attachments with proper material handler model/attachment load capacity charts displayed in the operator's cab.
 · Never use your attachment as a work platform or personnel carrier.
 Can't find the attachment you are looking for? Contact your JLG Aftermarket Parts representative at 1-877-JLG-LIFT or visit www.jlg.com.

NOTES:
 · Use only JLG approved attachments with proper material handler model/attachment load capacity charts displayed in the operator's cab.
 · Never use your attachment as a work platform or personnel carrier.
 Can't find the attachment you are looking for? Contact your JLG Aftermarket Parts representative at 1-877-JLG-LIFT or visit www.jlg.com.



PART NUMBER	ATTACHMENT
COUPLER MOUNTED ATTACHMENTS	1001104435 Carriage, 50" Std., 7k lb.
	1001102331 Carriage, 48" Side Tilt, 7k lb.
	1001242501 Carriage, 48" Side Shift, 5.5k lb.
	1001242506 Carriage, 48" Dual Fork Positioning, 5.5k lb.
	1001242517 Carriage, 48" Dual Tine Baling 2.2k lb.
	1001102323 Bucket, Light Material, 72", 1.7 CU YD
	1001102324 Bucket, Light Material, 72", 1.0 CU YD
	1001102327 Bucket, Manure/Scrap
	1001242509 Lifting Hook, 5.5k lb.
	1001242617 Auger Drive

PART NUMBER	ATTACHMENT
UNIVERSAL QUICK-ATTACH STYLE ATTACHMENTS	1001113038 Carriage, 48" Standard, 5.5k lb.
	1001104009 Carriage, 48" Side Tilt, 5.5k lb.
	1001104025 Carriage, 48" Side Shift, 5.5k lb.
	1001242508 Carriage, 48" Dual Fork Positioning, 5.5k lb.
	1001242511 Carriage, 48" Dual Tine Baling 2.2k lb.
	1001242510 Lifting Hook, 5.5k lb.
	1001242616 Auger Drive

PART NUMBER	ATTACHMENT
FORK MOUNTED ATTACHMENTS	1001097205 Hook, Crane
	1001195970 Bucket, 60" 1.3 CU YD
	1001238566 Hopper, Trash

PART NUMBER	ATTACHMENT
SPECIAL APPLICATIONS	1001102332 Adapter, Universal Quick-Attach
	1001162898 Cutting Edge, 72" Bolt-On

PART NUMBER	ATTACHMENT
FORKS	2340037 Fork, Cubing, 2"x2"x48", 1,940 lb.
	1001099457 Fork, Pallet, 2"x4"x48", 3,800 lb.
	1001099458 Fork, Lumber, 1.5"x6"x60", 3,650 lb.

PART NUMBER	ATTACHMENT
COUPLER MOUNTED ATTACHMENTS	1170021 Carriage, 50" Std., 12k lb.
	1170024 Carriage, 60" Std., 12k lb.
	1001211516 Carriage, 72" Std., 15k lb.
	7301295 Carriage, 50" Dual Fork Positioning, 10k lb.
	1001233383 Carriage, 50" Side Tilt, 12k lb.
	1001233384 Carriage, 60" Side Tilt, 12k lb.
	1001233385 Carriage, 72" Side Tilt, 12k lb.
	1001142790 Carriage, 50" Side Shift, 12k lb.
	1001095418 Carriage, 72" 90 Deg. Swing, 10k lb.
	1001108668 Carriage, 50" Standard W/ 8' Mast, 4.5K lb.
	1001100967 Truss Boom, 3' With Winch, 4K lb.
	1001099902 Truss Boom, 12' W/O Winch, 2K lb.
	1001099351 Truss Boom, 12' With Winch, 2K lb.
	1001099901 Truss Boom, 15' W/O Winch, 2K lb.
	1001176515 Truss Boom, Adjustable Material Handler
	1001100822 Bucket, 72" 1.0 CU YD
	1001100823 Bucket, 96" 1.5 CU YD
	1001100824 Bucket, 102" 2.0 CU YD
	0930020 Bucket, 96" Multi-Purpose
	1001202904 Sweeper, 0.53 CU YD
	1001207606 Hook, Lifting
	1001142247 Grapple, Pipe

PART NUMBER	ATTACHMENT
FORK MOUNTED ATTACHMENTS	1001230241 Truss Boom, Low Profile, Adjustable
	1001195970 Bucket, 60" 1.3 CU YD
	1001195082 Hopper, Trash
	1001103637 Work Platform, 4x8' Domestic 1K lb.
	1001103730 Work Platform, 4x8' ISO 1K lb.
	1001103736 Work Platform, 4x8' French 1K lb.
	1001097205 Hook, Crane

PART NUMBER	ATTACHMENT
SPECIAL APPLICATIONS	1001100227 Sheet Handler, 3k LB Capacity
	1001137512 Fork Extension, 90"

PART NUMBER	ATTACHMENT
FORKS	2340045 Fork, Pallet, 2.4"x4"x48"
	2340038 Fork, Pallet, 2.4"x5"x48"
	7301408 Fork, Pallet, 2.4"x4"x48" (use w/ DFP carriage)
	1001227379 Fork, Pallet, 2.4"x4"x60" (use w/ DFP carriage)
	1001232355 Fork, Pallet, 2.36"x5"x72"
	2340039 Fork, Dual Taper, 2.36"x6"x60"
	1001092391 Fork, Dual Taper, 2"x6"x72"
	2340046 Fork, Dual Taper, 1.75"x7"x60"
	2340037 Fork, Block, 2"x2"x48"

NOTES:
 · Use only JLG approved attachments with proper material handler model/attachment load capacity charts displayed in the operator's cab.
 · Never use your attachment as a work platform or personnel carrier.
 Can't find the attachment you are looking for? Contact your JLG Aftermarket Parts representative at 1-877-JLG-LIFT or visit www.jlg.com.

NOTES:
 · Use only JLG approved attachments with proper material handler model/attachment load capacity charts displayed in the operator's cab.
 · Never use your attachment as a work platform or personnel carrier.
 Can't find the attachment you are looking for? Contact your JLG Aftermarket Parts representative at 1-877-JLG-LIFT or visit www.jlg.com.

Attachment Catalog/Load Chart Information

Electronic Load Charts

Electronic load charts are available only for models with optional multi-functional displays - JLG 642, 643, 1043, 1055 and 1255 ONLY.

Please follow step-by-step instructions below to download latest load chart software for in-dash display.

Instructions to Download from Online Express

- Click **Service** in the navigation menu on Online Express
- Click **Machine Control Software**
- Select **Brand** from drop down menu
- Select **Model** from drop down menu
- Click **Search**
- Look for software description relevant to the machine (lifting lug/no lifting lug, ANSI/Metric)
- Click **Download this File**



1001187087 is a reference number only - It is not an orderable load chart part number.

An Interface cable is required to download software to JLG Modules.

The display must have a P2.0 or later software to use the Trash Hopper chart.

For any load charts not listed - Please call the parts contact center for assistance



Important Reminders

- Use only JLG approved attachments with proper material handler model/attachment load capacity charts displayed in the operator's cab.
- Never use your attachment as a work platform or personnel carrier.

Can't find what you're looking for?

Contact the Aftermarket Parts Team at 877-jlg-lift (877-554-5438) or visit online at www.jlg.com.

NOTES:

- Use only JLG approved attachments with proper material handler model/attachment load capacity charts displayed in the operator's cab.
 - Never use your attachment as a work platform or personnel carrier.
- Can't find the attachment you are looking for? Contact your JLG Aftermarket Parts representative at 1-877-JLG-LIFT or visit www.jlg.com.

Dual Fork Positioning Carriage

The dual fork positioning carriage allows the operator to adjust the width between the forks without leaving the cab.

Features

- Dual fork positioning carriages require auxiliary hydraulics
- Standard up-and-down tilt on horizontal plane
- Dual fork positioning carriage is not compatible with fork mounted attachments
- Fork and Carriage sold separately

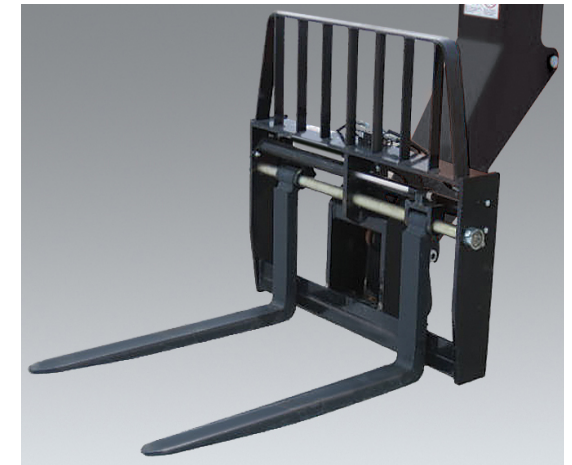

Current Production - Dual Fork Positioning Carriages
Available Through JLG Aftermarket Or With New Machine Orders

CARRIAGE SIZE		48 in.	48 in.	50 in.	50 in.	72 in.	
APPROX. WEIGHT		638 lbs.	695 lbs.	1090 lbs.	1202 lbs.	1,035 lbs.	
PART NO.		1001242506	1001242508	73012955	10011892115	1001192342	
FORK PIN NO.		70027283	70027283	90451058	70027283	70028507	
MODEL	SN BREAKS	LOAD CHART BOOKLET					
JLG	642, 943, 1043, 1055, 1255 ONLY	1001187087 (Ref No.)					
	742	1001226012					
	943/1043	Without Outriggers	1001212420				
		With Outriggers	1001212419				
	1055	Prior To 0160074169	1001212227				
		0160074169 - Present	1001211156				
	1255	Prior To 0160074168	1001212225				
		0160074168 - Present	1001211153				
	1644	ALL	1001233430				
	1732	ALL	1001233431				
G5-18A	with the Universal (skid steer) quick coupler: 0160040809-Present	1001126677					
	with Standard Coupler: 0160040809-Present	1001126677					
SKYTRAK™	6036	0160069720 - 0160075649, incl 0160065792, 0160065798, 0160065824, 0160069383, 0160069411, 0160075653 & 0160075722	1001199500				
		0160075650 - Present, excl 0160075653 & 0160075722	1001211867				
	6042	0160069720 - 0160075656, incl 0160065792, 0160065798, 0160065824, 0160069383 & 0160069411	1001199504				
		0160075657 - Present	1001211869				
	8042	0160069722 - 0160075670, incl 0160065791, 0160065796, 0160065825, 0160065826, 0160069336, 0160069359 & 0160069441	1001199508				
		0160075671 - Present	1001211871				
	10042	0160069722 - 0160075987, incl 0160065791, 0160065796, 0160065825, 0160065826, 0160069336, 0160069359 & 0160069441	1001199512				
0160075988 - Present		1001211873					
10054	0160069722 - 0160075682, incl 0160065791, 0160065796, 0160065825, 0160065826, 0160069336, 0160069359, 0160069441 & 0160075696	1001199518					
	0160075683 - Present, excl 0160075696	1001211875					

NOTES:

- Use only JLG approved attachments with proper material handler model/attachment load capacity charts displayed in the operator's cab.
 - Never use your attachment as a work platform or personnel carrier.
- Can't find the attachment you are looking for? Contact your JLG Aftermarket Parts representative at 1-877-JLG-LIFT or visit www.jlg.com.

Non-Current Production - Dual Fork Positioning Carriage, JLG
Available Through JLG Aftermarket Parts

CARRIAGE SIZE			50 in.
APPROX. WEIGHT			1090 lbs.
INCLUDED FORK LENGTH			48 in.
PART NO.			73012955
FORK PIN NO.			90451058
MODEL	SN BREAKS	LOAD CHART BOOKLET	
JLG	642	ALL	1001212421
	G6-42A	0160037722 - 0160040659	100110401
		0160040678 - Present	1001130739
	G9-43A	0160037671 - 0160040674, excl 0160040468 & 0160040672	100110402
		0160040675 - Present, incl 0160040468 & 0160040672	1001130708
	G10-43A	0160037671 - 0160040674, excl 0160040468 & 0160040672	1001115257
		0160040675 - Present, incl 0160040468 & 0160040672	1001130844
	G10-55A	0160037690 - Present, incl 0160038505, 0160038507, 0160038324, 016003489 & 0160038493	1001115138
	G12-55A	0160037689 - Present	1001115540
	G15-44A	Prior To 0160074142	1001194130
0160074142 - Present		1001211953	

Non-Current Production - Dual Fork Positioning Carriage, SkyTrak
Available Through JLG Aftermarket Parts

CARRIAGE SIZE			50 in.
APPROX. WEIGHT			1090 lbs.
INCLUDED FORK LENGTH			48 in.
PART NO.			73012955
FORK PIN NO.			90451058
MODEL	SN BREAKS	LOAD CHART BOOKLET	
SKYTRAK	6036	0160031200 - 0160069719, excl 0160065792, 0160065798, 0160065824, 0160069383 & 0160069411	1001199500
	6042	0160031200 - 0160069719, excl 0160065792, 0160065798, 0160065824, 0160069383 & 0160069411	1001199504
	8042	0160031235 - 0160069721, excl 0160065791, 0160065796, 0160065825, 0160065826, 0160069336, 0160069359 & 0160069441	1001199508
	10042	0160031425 - 0160069721, excl 0160065791, 0160065796, 0160065825, 0160065826, 0160069336, 0160069359 & 0160069441	1001199512
	10054	0160031255 - 0160069721, excl 0160065791, 0160065796, 0160065825, 0160065826, 0160069336, 0160069359 & 0160069441	1001199518

Non-Current Production - Dual Fork Positioning Carriage, Lull
Available Through JLG Aftermarket Parts

CARRIAGE SIZE			50 in.	50 in.	
APPROX. WEIGHT			1000 lbs.	1090 lbs.	
INCLUDED FORK LENGTH			42 in.	48 in.	
PART NO.			10448045	73012955	
FORK PIN NO.			10165685	90451058	
MODEL	SN BREAKS	LOAD CHART BOOKLET			
LULL	644E-42	Prior To 0160031500	7300628	.	
		0160037900 - Present	1001110410	.	
	944E-42	Prior To 0160031500	7301586	.	.
		0160037794 - Present, incl 0160045421	1001110411	.	.
	1044C-42	ALL	Consult Factory	.	.
	1044C-54	ALL	Consult Factory	.	.
	1044C-54 SII	Prior To 0160037893	1001105327	.	.
		0160037794 - Present	1001110409	.	.

NOTES:
 · Use only JLG approved attachments with proper material handler model/attachment load capacity charts displayed in the operator's cab.
 · Never use your attachment as a work platform or personnel carrier.
 Can't find the attachment you are looking for? Contact your JLG Aftermarket Parts representative at 1-877-JLG-LIFT or visit www.jlg.com.

Side-Shift Carriage

The side-shift carriage allows the operator to move the load left or right for precise placement.

Features

- Side-shift carriages require auxiliary hydraulics
- Standard up-and-down tilt on horizontal plane

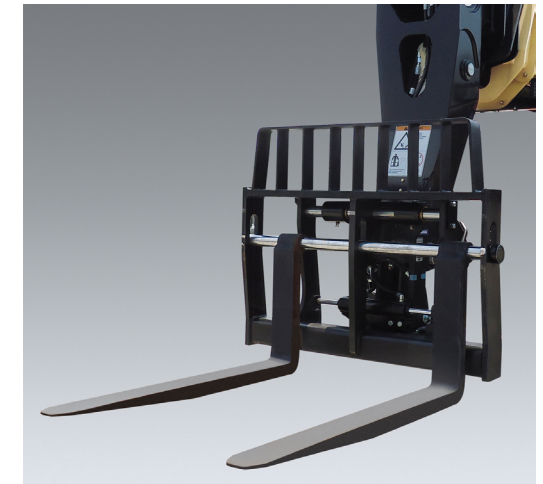

Current Production - Side-Shift Carriages
Available Through JLG Aftermarket Or With New Machine Orders

CARRIAGE SIZE			48 in.	48 in.	50 in.	72 in.
APPROX. WEIGHT			751 lbs.	768 lbs.	930 lbs.	1256 lbs.
PART NO.			1001242501	1001104025*	1001142790	1001192344
FORK PIN NO.			70029504	70022105	N/A	N/A
MODEL	SN BREAKS	LOAD CHART BOOKLET				
JLG	642, 943, 1043, 1055, 1255 ONLY	Software, Chart Library	1001187087 (Ref No.)			
	742	ALL	1001226012		.	
	943/1043	Without Outriggers	1001212420		.	
		Without Outriggers	1001212419		.	
	1055	Prior To 0160074169	1001212227		.	
		0160074169 - Present	1001211156		.	
	1255	Prior To 0160074168	1001212225		.	
		0160074168 - Present	1001211153		.	
	1644	ALL	1001233430			.
	1732	ALL	1001233431			.
G5-18A	0160040809 - Present	100126677	.	.		
SKYTRAK T4F	6036	0160069720 - 0160075649, incl 0160065792, 0160065798, 0160065824, 0160069383, 0160069411, 0160075653 & 0160075722	1001199500		.	
		0160075650 - Present, excl 0160075653 & 0160075722	1001211867		.	
	6042	0160069720 - 0160075656, incl 0160065792, 0160065798, 0160065824, 0160069383 & 0160069411	1001199504		.	
		0160075657 - Present	1001211869		.	
	8042	0160069722 - 0160075670, incl 0160065791, 0160065796, 0160065825, 0160065826, 0160069336, 0160069359 & 0160069441	1001199508		.	
		0160075671 - Present	1001211871		.	
	10042	0160069722 - 0160075987, incl 0160065791, 0160065796, 0160065825, 0160065826, 0160069336, 0160069359 & 0160069441	1001199512		.	
		0160075988 - Present	1001211873		.	
	10054	0160069722 - 0160075682, incl 0160065791, 0160065796, 0160065825, 0160065826, 0160069336, 0160069359, 0160069441 & 0160075696	1001199518		.	
		0160075683 - Present, excl 0160075696	1001211875		.	

For SkyTrak Legacy machines, please refer to Non-Current Production SkyTrak table.

*Used with Universal Quick Switch (Skid Steer) Coupler.

NOTES:
 · Use only JLG approved attachments with proper material handler model/attachment load capacity charts displayed in the operator's cab.
 · Never use your attachment as a work platform or personnel carrier.
 Can't find the attachment you are looking for? Contact your JLG Aftermarket Parts representative at 1-877-JLG-LIFT or visit www.jlg.com.

Non-Current Production - Side-Shift Carriages, JLG
Available Through JLG Aftermarket Parts

CARRIAGE SIZE			50 in.	50 in.	50 in.	
APPROX. WEIGHT			898 lbs.	930 lbs.	905 lbs.	
PART NO.			1001193799	1001142790	1170002	
FORK PIN NO.			N/A	N/A	7028136	
MODEL	SN BREAKS	LOAD CHART BOOKLET				
JLG	642	ALL	1001212421	.		
	619A	ALL	Consult Factory		.	
	723A	ALL	Consult Factory		.	
	G5-19A	ALL	1706970		.	
	G6-23A	ALL	1706975		.	
	G6-42A	0160037722 - 0160040659	1001110401		.	
		0160040678 - Present	1001130739		.	
	G9-43A	0160037671 - 0160040674, excl 0160040468 & 0160040672	1001110402		.	
		0160040675 - Present, incl 0160040468 & 0160040672	1001130708		.	
	G10-43A	0160037671 - 0160040674, excl 0160040468 & 0160040672	1001115257		.	
		0160040675 - Present, incl 0160040468 & 0160040672	1001130844		.	
	G10-55A	0160037690 - Present, incl 0160038505, 0160038507, 0160038324, 0160038489 & 0160038493	1001115138		.	
	G12-55A	0160037689 - Present	1001115540		.	
	G15-44A	Prior To 0160074142	1001194130	.		
		0160074142 - Present	1001211953	.		

Non-Current Production - Side-Shift Carriages, SkyTrak
Available Through JLG Aftermarket Parts

CARRIAGE SIZE			50 in.
APPROX. WEIGHT			930 lbs.
PART NO.			1001142790
FORK PIN NO.			N/A
MODEL	SN BREAKS	LOAD CHART BOOKLET	
SKYTRAK	6036	0160031200 - 0160069719, excl 0160065792, 0160065798, 0160065824, 0160069383 & 0160069411	1001199500
	6042	0160031200 - 0160069719, excl 0160065792, 0160065798, 0160065824, 0160069383 & 0160069411	1001199504
	8042	0160031235 - 0160069721, excl 0160065791, 0160065796, 0160065825, 0160065826, 0160069336, 0160069359 & 0160069441	1001199508
	10042	0160031425 - 0160069721, excl 0160065791, 0160065796, 0160065825, 0160065826, 0160069336, 0160069359 & 0160069441	1001199512
	10054	0160031255 - 0160069721, excl 0160065791, 0160065796, 0160065825, 0160065826, 0160069336, 0160069359 & 0160069441	1001199518

Non-Current Production - Side-Shift Carriages, Lull
Available Through JLG Aftermarket Parts

CARRIAGE SIZE			50 in.
APPROX. WEIGHT			930 lbs.
PART NO.			1001142790
FORK PIN NO.			N/A
MODEL	SN BREAKS	LOAD CHART BOOKLET	
LULL	644E-42	0160037900 - Present	1001106009
	944E-42	0160037794 - Present, incl 0160045421	1001134329
	1044C-54 SII	0160037794 - Present	1001106011

NOTES:
 · Use only JLG approved attachments with proper material handler model/attachment load capacity charts displayed in the operator's cab.
 · Never use your attachment as a work platform or personnel carrier.
 Can't find the attachment you are looking for? Contact your JLG Aftermarket Parts representative at 1-877-JLG-LIFT or visit www.jlg.com.

Side-Tilt Carriage

Adding to the versatility of the telehandler, the side-tilt carriage keeps the load level even when the terrain isn't. The carriage tilts loads from side-to-side to allow for uneven landing areas like a roof or sloped bank.

Features

- Side-to-side tilt on vertical plane
 - +/- 10 degrees on SkyTrak or Lull
 - +/- 10 degrees on JLG or Gradall
- Load or unload at any angle

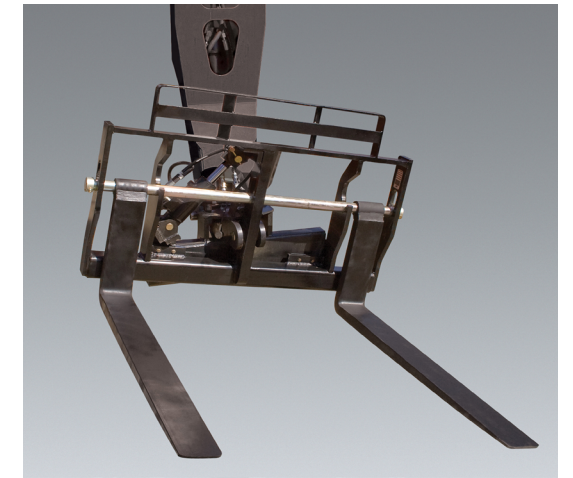

Current Production - Side-Tilt Carriages
Available Through JLG Aftermarket Or With New Machine Orders

CARRIAGE SIZE			48 in.	48 in.	50 in.	60 in.	72 in.
APPROX. WEIGHT			660 lbs.	817 lbs.	12,000 lbs.	12,000 lbs.	12,000 lbs.
PART NO.			1001102331	1001104009	10012333835	10012333845	10012333855
FORK PIN NO.			70021339	70022105	3423275	3423242	3423276
MODEL	SN BREAKS	LOAD CHART BOOKLET					
JLG	642, 943, 1043, 1055, 1255 ONLY	Software, Chart Library	1001187087 (Ref No.)
	742	ALL	1001226012
	943/1043	Without Outriggers	1001212420
		With Outriggers	1001212419
	1055	Prior To 0160074169	1001212227
		0160074169 - Present	1001211156
	1255	Prior To 0160074168	1001212225
		0160074168 - Present	1001211153
	G5-18A	Universal (skid steer) quick coupler 0160040809 - Present	1001126677*
		Quick coupler (hydraulic or manual)	1001102000
SKYTRAK T4F	6036	0160069720 - 0160075649, incl 0160065792, 0160065798, 0160065824, 0160069383, 0160069411, 0160075653 & 0160075722	1001199500
		0160075650 - Present, excl 0160075653 & 0160075722	1001211867
	6042	0160069720 - 0160075656, incl 0160065792, 0160065798, 0160065824, 0160069383 & 0160069411	1001199504
		0160075657 - Present	1001211869
	8042	0160069722 - 0160075670, incl 0160065791, 0160065796, 0160065825, 0160065826, 0160069336, 0160069359 & 0160069441	1001199508
		0160075671 - Present	1001211871
	10042	0160069722 - 0160075987, incl 0160065791, 0160065796, 0160065825, 0160065826, 0160069336, 0160069359 & 0160069441	1001199512
		0160075988 - Present	1001211873
	10054	0160069722 - 0160075682, incl 0160065791, 0160065796, 0160065825, 0160065826, 0160069336, 0160069359, 0160069441 & 0160075696	1001199518
		0160075683 - Present, excl 0160075696	1001211875

* Used with Universal Quick Switch (Skid Steer) Coupler.

NOTES:
 · Use only JLG approved attachments with proper material handler model/attachment load capacity charts displayed in the operator's cab.
 · Never use your attachment as a work platform or personnel carrier.
 Can't find the attachment you are looking for? Contact your JLG Aftermarket Parts representative at 1-877-JLG-LIFT or visit www.jlg.com.

Non-Current Production - Side-Tilt Carriages, JLG
Available Through JLG Aftermarket Parts

CARRIAGE SIZE			48 in.	48 in.	50 in.	60 in.	72 in.	72 in.
APPROX. WEIGHT			607 lbs.	763 lbs.	12,000 lbs	12,000 lbs	948 lbs.	12,000 lbs
PART NO.			1170046	91405101	10012333835	10012333845	91405079	10012333855
FORK PIN NO.			(2) 4040283	91401303	3423275	3423242	91401324	3423276
MODEL	SN BREAKS	LOAD CHART BOOKLET						
JLG	642	ALL	1001212421		.	.		.
	619A	ALL	Consult Factory	.				
	723A	ALL	Consult Factory	.				
	G5-19A	ALL	Consult Factory	.				
	G6-23A	ALL	Consult Factory	.				
	G6-42A	Prior To 0160037722	1001105323		.			.
		0160037722 - 0160040659	1001106001		.	.		.
		0160040678 - Present	1001130793		.	.		.
	G9-43A	Prior To 0160037671	1001105325		.			.
		0160037671 - 0160040674, excl 0160040468 & 0160040672	1001106002		.	.		.
		0160040675 - Present, incl 0160040468 & 0160040672	1001130663		.	.		.
	G10-43A	Prior To 0160037671	1001130935		.			.
		0160037671 - 0160040674, excl 0160040468 & 0160040672	1001113013		.	.		.
		0160040675 - Present, incl 0160040468 & 0160040672	1001130935		.	.		.
	G10-55A	Prior To 0160037689	1001105707		.			.
		0160037690 - 0160038486, incl 0160038505 & 0160038507, excl 0160038324, 0160038489 & 0160038493	1001106003		.	.		.
		0160038500 - Present, incl 0160038324, 0160038489 & 0160038493, excl 0160038505 & 0160038507	1001115135		.	.		.
	G12-55A	Prior To 0160037689	1001105326		.			.
		0160037689 - 0160038533	1001106004		.	.		.
		0160038538 - Present	1001115536		.	.		.
G15-44A	Prior To 0160074142	1001194130					.	
	0160074142 - Present	1001211953					.	
TF6-42	ALL	Consult Factory		.			.	

Non-Current Production - Side-Tilt Carriages, Gradall
Available Through JLG Aftermarket Parts

CARRIAGE SIZE			48 in.	48 in.	50 in.	60 in.	66 in.	72 in.	72 in.
APPROX. WEIGHT			700 lbs.	763 lbs.	12,000 lbs.	12,000 lbs.	820 lbs.	948 lbs.	12,000 lbs.
PART NO.			91085058	91405101	10012333835	10012333845	91305016	91405079	10012333855
FORK PIN NO.			90451058	91401303	3423275	3423242	91301083	91401324	3423276
MODEL	SN BREAKS	LOAD CHART BOOKLET							
GRADALL	522D/524D	ALL	Consult Factory	.			.		
	534C-9	ALL	Consult Factory	.			.		
	534D-6	ALL	Consult Factory	.			.		
	534D-9	Prior To 0160037689	1001102719		.			.	
		0160037689 - Present	1001112753	
	534D-10	Prior To 0160037689	1001102720		.			.	
		0160037689 - Present	1001112753	
	544C	ALL	Consult Factory	.			.		
	544D	Prior To 0160037689	1001102721		.			.	
		0160037689 - Present	1001106008	
	G6-42P	Prior To 0160037689	1001105324		.			.	.
		0160037689 - Present	1001106005	

Non-Current Production - Side-Tilt Carriages, SkyTrak
Available Through JLG Aftermarket Parts

CARRIAGE SIZE			48 in.	50 in.	60 in.	60 in.	72 in.	72 in.
APPROX. WEIGHT			640 lbs.	12,000 lbs.	472 lbs.	1047 lbs.	677 lbs.	800 lbs.
PART NO.			7134400	10012333835	10011019565	7134500	11700575	7134600
FORK PIN NO.			7128772	3423275	3423242	7128792	3423276	9055103
MODEL	SN BREAKS	LOAD CHART BOOKLET						
SKYTRAK	4266	ALL	Consult Factory	.			.	.
	4270	ALL	Consult Factory	.			.	.
	4290	ALL	Consult Factory	.			.	.
	5028	ALL	Consult Factory	.			.	.
	6036	Prior To 0160031200	Consult Factory	.			.	.
		0160031200 - 0160069719, excl 0160065792, 0160065798, 0160065824, 0160069383 & 0160069411	1001199500	
	6042	Prior To 0160031200	Consult Factory	.			.	.
		0160031200 - 0160069719, excl 0160065792, 0160065798, 0160065824, 0160069383 & 0160069411	1001199504	
	8042	Prior To 0160031235	Consult Factory	.			.	.
		0160031235 - 0160069721, excl 0160065791, 0160065796, 0160065825, 0160065826, 0160069336, 0160069359 & 0160069441	1001199508	
	10042	Prior To 0160031425	Consult Factory	.			.	.
		0160031425 - 0160069721, excl 0160065791, 0160065796, 0160065825, 0160065826, 0160069336, 0160069359 & 0160069441	1001199512	
	10054	Prior To 0160031255	Consult Factory	.			.	.
		0160031255 - 0160069721, excl 0160065791, 0160065796, 0160065825, 0160065826, 0160069336, 0160069359 & 0160069441	1001199518	

* Used with Universal Quick Switch (Skid Steer) Coupler.

NOTES:
 · Use only JLG approved attachments with proper material handler model/attachment load capacity charts displayed in the operator's cab.
 · Never use your attachment as a work platform or personnel carrier.
 Can't find the attachment you are looking for? Contact your JLG Aftermarket Parts representative at 1-877-JLG-LIFT or visit www.jlg.com.

NOTES:
 · Use only JLG approved attachments with proper material handler model/attachment load capacity charts displayed in the operator's cab.
 · Never use your attachment as a work platform or personnel carrier.
 Can't find the attachment you are looking for? Contact your JLG Aftermarket Parts representative at 1-877-JLG-LIFT or visit www.jlg.com.

Non-Current Production - Side-Tilt Carriages, Lull
Available Through JLG Aftermarket Parts

CARRIAGE SIZE			48 in.	50 in.	50 in.	50 in.	60 in.	60 in.	72 in.	72 in.	74 in.	74 in.	
APPROX. WEIGHT			640 lbs.	678 lbs.	844 lbs.	12,000 lbs.	1047 lbs.	12,000 lbs.	800 lbs.	12,000 lbs.	920 lbs.	1028 lbs.	
PART NO.			7134400	7161300	48041	1001233383S	7134500	1001233384S	7134600	1001233385S	48043	48003	
FORK PIN NO.			7128772	90451058	10223049	3423275	7128792	3423242	90551013	3423276	10124495	10116207	
MODEL	SN BREAKS	LOAD CHART BOOKLET											
LULL	644B-37	ALL	Consult Factory		•							•	
	644B-42	ALL	Consult Factory		•							•	
	644D-34	ALL	Consult Factory		•							•	
	644E-42	Prior To 0160031500	7300628		•	•		•		•			
		0160037900 - Present	1001106009				•		•		•		
	844C-42	ALL	Consult Factory		•							•	
	944E-42	Prior To 0160031500	7301586		•	•		•		•			
		0160037794 - Present, incl 0160045421	1001134329				•		•		•		
	1044C-54 SII	Prior To 0160037893	1001105327			•						•	
		0160037794 - Present	1001106011				•		•		•		
	6K-37	ALL	Consult Factory		•							•	
	6K-42	ALL	Consult Factory		•							•	
8K-42	ALL	Consult Factory		•							•		
10K-42/10K-54	ALL	Consult Factory		•							•		

Standard Carriage

The standard carriage is manufactured with high quality steel and is available in various sizes. This attachment is essential on most job sites, allowing operators to pick and place materials – from pallets of concrete block to loads of lumber.

Features

- Standard up-and-down tilt on horizontal plane
- Multiple fork options
- Available with 8000 lb. lifting hook for most current production applications

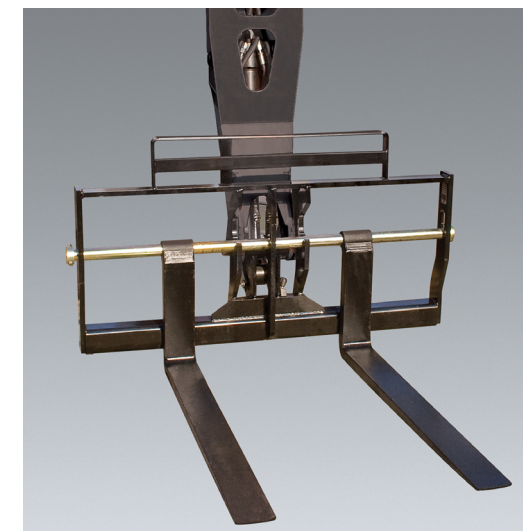

Current Production - Standard Carriages
Available Through JLG Aftermarket Or With New Machine Orders

CARRIAGE SIZE			50 in.	50 in.	50 in.	60 in.	60 in.	72 in.	72 in.	72 in.	87 in.
LIFTING HOOK			No	Yes	No	Yes	No	Yes	No	No	No
APPROX. WEIGHT			460 lbs.	478 lbs.	526 lbs.	503 lbs.	16,800 lbs.	639 lbs.	639 lbs.	16.8K lbs.	16.8K lbs.
PART NO.			1001104435	1001146084S**	1001130385**	1001146086S**	1001183447	1001193794S	1001211516S	1001214415S	1001192339S
FORK PIN NO.			3423275	3423275	3423275	3423242	1001191108	3423276	3223276	1001214254	1001218754
MODEL	SN BREAKS	LOAD CHART BOOKLET									
JLG	642, 943, 1043, 1055, 1255 ONLY	Software, Chart Library	1001187087 (Ref No.)								
	742	ALL	1001226012		•		•		•		
	943/1043	Without Outriggers	1001212420		•		•		•		
		With Outriggers	1001212419		•		•		•		
	1055	Prior To 0160074169	1001212227		•		•		•		
		0160074169 - Present	1001211156		•		•		•		
	1255	Prior To 0160074168	1001212225		•		•		•		
		0160074168 - Present	1001211153		•		•		•		
	1644	ALL	1001233430					•			•
	1732	ALL	1001233431					•			•
	G5-18A	Quick coupler (hydraulic or manual)	1001102000		•		•				
		Universal (skid steer) quick coupler Prior To 0160040809	1001126677		•		•				
6036	0160069720 - 0160075649, incl 0160065792, 0160065798, 0160065824, 0160069383, 0160069411, 0160075653 & 0160075722	1001199500		•		•		•		•	
	0160075650 - Present, excl 0160075653 & 0160075722	1001211867		•		•		•			
6042	0160069720 - 0160075656, incl 0160065792, 0160065798, 0160065824, 0160069383 & 0160069411	1001199504		•		•		•		•	
	0160075657 - Present	1001211869		•		•		•			

Continues on next page

NOTES:
 • Use only JLG approved attachments with proper material handler model/attachment load capacity charts displayed in the operator's cab.
 • Never use your attachment as a work platform or personnel carrier.
 Can't find the attachment you are looking for? Contact your JLG Aftermarket Parts representative at 1-877-JLG-LIFT or visit www.jlg.com.

* Used with optional Skid Steer Coupler.
 ** May require purchase of new load chart booklet on some models.

NOTES:
 • Use only JLG approved attachments with proper material handler model/attachment load capacity charts displayed in the operator's cab.
 • Never use your attachment as a work platform or personnel carrier.
 Can't find the attachment you are looking for? Contact your JLG Aftermarket Parts representative at 1-877-JLG-LIFT or visit www.jlg.com.

Current Production - Standard Carriages
Available Through JLG Aftermarket Or With New Machine Orders

Continued from previous page

CARRIAGE SIZE			50 in.	60 in.	72 in.	72 in.
LIFTING HOOK			Yes	Yes	Yes	No
APPROX. WEIGHT			478 lbs.	503 lbs.	639 lbs.	639 lbs.
PART NO.			10011460845**	10011460865**	10011937945	10012115165
FORK PIN NO.			3423275	3423242	3423276	3223276
MODEL	SN BREAKS	LOAD CHART BOOKLET				
SKYTRAK™ TF	8042	0160069722 - 0160075670, incl 0160065791, 0160065796, 0160065825, 0160065826, 0160069336, 0160069359 & 0160069441	1001199508	.	.	.
		0160075671 - Present	1001211871	.	.	.
10042		0160069722 - 0160075987, incl 0160065791, 0160065796, 0160065825, 0160065826, 0160069336, 0160069359 & 0160069441	1001199512	.	.	.
		0160075988 - Present	1001211873	.	.	.
10054		0160069722 - 0160075682, incl 0160065791, 0160065796, 0160065825, 0160065826, 0160069336, 0160069359, 0160069441 & 0160075696	1001199518	.	.	.
		0160075683 - Present, excl 0160075696	1001211875	.	.	.

Non-Current Production - Standard Carriages, JLG
Available Through JLG Aftermarket Parts

CARRIAGE SIZE			48 in.	48 in.	50 in.	50 in.	50 in.	50 in.	60 in.	60 in.	72 in.	72 in.	
LIFTING HOOK			No	No	No	No	Yes	No	No	Yes	No	Yes	
APPROX. WEIGHT			417 lbs.	377 lbs.	460 lbs.	471 lbs.	478 lbs.	479 lbs.	497 lbs.	503 lbs.	639 lbs.	639 lbs.	
PART NO.			100112618	1001107581	1001104435	11700215	10011460845**	11700195	11700245	10011460865**	10012115165	10011937945	
FORK PIN NO.			(2) 4040283	1001107336	3423275	3423275	3423275	3423275	3423242	3423242	3223276	3423276	
MODEL	SN BREAKS	LOAD CHART BOOKLET											
JLG	642	ALL	1001212421				.			.		.	
	619A	ALL	Consult Factory	.		.							
	723A	ALL	Consult Factory	.		.							
	G5-19A	ALL	Consult Factory	.	.								
	G6-23A	ALL	Consult Factory	.	.								
	G6-42A	Prior To 0160037722	1001105323				.						
		0160037722 - 0160040659	1001106001		
		0160040678 - Present	1001130793		
	G9-43A	Prior To 0160037671	1001105325			
	G9-43A	0160037671 - 0160040674, excl 0160040668 & 0160040672	1001106002		
		0160040675 - Present, incl 0160040668 & 0160040672	1001130663		

Continues on next page

* Used with optional Skid Steer Coupler.
** May require purchase of new load chart booklet on some models.

NOTES:
· Use only JLG approved attachments with proper material handler model/attachment load capacity charts displayed in the operator's cab.
· Never use your attachment as a work platform or personnel carrier.
Can't find the attachment you are looking for? Contact your JLG Aftermarket Parts representative at 1-877-JLG-LIFT or visit www.jlg.com.

Non-Current Production - Standard Carriages, JLG
Available Through JLG Aftermarket Parts

Continued from previous page

CARRIAGE SIZE			50 in.	50 in.	50 in.	60 in.	60 in.	60 in.	60 in.	72 in.	72 in.	
LIFTING HOOK			No	Yes	No	No	Yes	Yes	No	No	Yes	
APPROX. WEIGHT			471 lbs.	478 lbs.	479 lbs.	497 lbs.	503 lbs.	548 lbs.	15,000 lbs.	639 lbs.	639 lbs.	
PART NO.			11700215	10011460845**	11700195	11700245	10011460865**	1001192915**	10012117115	10012115165	10011937945	
FORK PIN NO.			3423275	3423275	3423275	3423242	3423242	3423242	3423242	3223276	3423276	
MODEL	SN BREAKS	LOAD CHART BOOKLET										
JLG	G10-43A	Prior To 0160037671	100130935	
		0160037671 - 0160040674, excl 0160040468 & 0160040672	1001113013	
		0160040675 - Present, incl 0160040468 & 0160040672	100130935	
	G10-55A	Prior To 0160037689	1001105707		.							
		0160037690 - 0160038486, incl 0160038505 & 0160038507, excl 0160038324, 0160038489 & 0160038493	1001106003	
	G12-55A	Prior To 0160037689	1001105326		.							
		0160037689 - 0160038533	1001106004	
	G15-44A	0160038500 - Present, incl 0160038324, 0160038489 & 0160038493, excl 0160038505 & 0160038507	1001115135	
		Prior To 0160074142	1001194130						.	.	.	
	TF6-42	ALL	Consult Factory			.						

** May require purchase of new load chart booklet on some models.

NOTES:
· Use only JLG approved attachments with proper material handler model/attachment load capacity charts displayed in the operator's cab.
· Never use your attachment as a work platform or personnel carrier.
Can't find the attachment you are looking for? Contact your JLG Aftermarket Parts representative at 1-877-JLG-LIFT or visit www.jlg.com.

Non-Current Production - Standard Carriages, Gradall
Available Through JLG Aftermarket Parts

CARRIAGE SIZE			50 in.	50 in.	50 in.	60 in.	72 in.	72 in.	
LIFTING HOOK			No	No	No	No	No	No	
APPROX. WEIGHT			471 lbs.	479 lbs.	490 lbs.	534 lbs.	586 lbs.	639 lbs.	
PART NO.			1170021S	1170019S	1170020S	1170023	1170026S	1001211516S	
FORK PIN NO.			3423275	3423275	3423275	3423242	3423276	3223276	
MODEL	SN BREAKS	LOAD CHART BOOKLET							
GRADALL	522D/524D	ALL	Consult Factory						
	534C-9	ALL	Consult Factory						
	534C-10	ALL	Consult Factory						
	534D-6	ALL	Consult Factory						
	534D-9	Prior To 0160037689	1001102719						
		0160037689 - Present	1001112753						
	534D-10	Prior To 0160037689	1001102720						
		0160037689 - Present	1001112753						
	544C	ALL	Consult Factory						
	544D	Prior To 0160037689	1001102721						
		0160037689 - Present	1001106008						
	G6-42P	Prior To 0160037689	1001105324						
0160037689 - Present		1001106005							

Non-Current Production - Standard Carriages, SkyTrak
Available Through JLG Aftermarket Parts

CARRIAGE SIZE			48 in.	50 in.	50 in.	60 in.	60 in.	60 in.	72 in.	72 in.	72 in.	
LIFTING HOOK			No	No	Yes	No	Yes	No	No	No	Yes	
APPROX. WEIGHT			509 lbs.	471 lbs.	478 lbs.	497 lbs.	503 lbs.	510 lbs.	509 lbs.	639 lbs.	639 lbs.	
PART NO.			6040500S	1170021S	1001146084S**	1170024S	1001146086S**	6040600S	6040700S	1001211516S	1001193794S	
FORK PIN NO.			7128772	3423275	3423275	3423242	3423242	7128792	90551013	3223276	3423276	
MODEL	SN BREAKS	LOAD CHART BOOKLET										
SKYTRAK	4266	ALL	Consult Factory									
	4270	ALL	Consult Factory									
	4290	ALL	Consult Factory									
	5028	ALL	Consult Factory									
	6036	Prior To 0160031200	Consult Factory									
		0160031200 - 0160069719, excl 0160065792, 0160065798, 0160065824, 0160069383 & 0160069411	1001199500									
	6042	Prior To 0160031200	Consult Factory									
		0160031200 - 0160069719, excl 0160065792, 0160065798, 0160065824, 0160069383 & 0160069411	1001199504									
	8042	Prior To 0160031235	Consult Factory									
		0160031235 - 0160069721, excl 0160065791, 0160065796, 0160065825, 0160065826, 0160069336, 0160069359 & 0160069441	1001199508									
	10042	Prior To 0160031425	Consult Factory									
		0160031425 - 0160069721, excl 0160065791, 0160065796, 0160065825, 0160065826, 0160069336, 0160069359 & 0160069441	1001199512									
	10054	Prior To 0160031255	Consult Factory									
		0160031255 - 0160069721, excl 0160065791, 0160065796, 0160065825, 0160065826, 0160069336, 0160069359 & 0160069441	1001199518									

** May require purchase of new load chart booklet on some models.

NOTES:

- Use only JLG approved attachments with proper material handler model/attachment load capacity charts displayed in the operator's cab.
- Never use your attachment as a work platform or personnel carrier.
- Can't find the attachment you are looking for? Contact your JLG Aftermarket Parts representative at 1-877-JLG-LIFT or visit www.jlg.com.

Non-Current Production - Standard Carriages, Lull
Available Through JLG Aftermarket Parts

CARRIAGE SIZE			48 in.	50 in.	50 in.	50 in.	50 in.	60 in.	60 in.	60 in.	72 in.	72 in.	72 in.	74 in.	
LIFTING HOOK			No	No	Yes	No	No	No	Yes	No	No	No	Yes	No	
APPROX. WEIGHT			509 lbs.	471 lbs.	478 lbs.	500 lbs.	532 lbs.	497 lbs.	503 lbs.	510 lbs.	509 lbs.	639 lbs.	639 lbs.	598 lbs.	
PART NO.			6040500S	1170021S	1001146084S**	48040	7161200S	1170024S	1001146086S**	6040600S	6040700S	1001211516S	1001193794S	48042	
FORK PIN NO.			7128772	3423275	3423275	10223049	90451058	3423242	3423242	7128792	90551013	3223276	3423276	10124495	
MODEL	SN BREAKS	LOAD CHART BOOKLET													
LULL	644B-42	ALL	Consult Factory												
	644D-34	ALL	Consult Factory												
	644E-42	Prior To 0160031500	7300628												
		0160031500 - Present	1001134329												
	844C-42	ALL	Consult Factory												
	944E-42	Prior To 0160031500	7301586												
		0160031500 - Present	1001106011												
	1044C-54 SII	Prior To 0160037893	1001105327												
		0160037893 - Present	1001106009												
	6K-37	ALL	Consult Factory												
	6K-42	ALL	Consult Factory												
	8K-42	ALL	Consult Factory												
	10K-42/ 10K-54	ALL	Consult Factory												

** May require purchase of new load chart booklet on some models.

NOTES:

- Use only JLG approved attachments with proper material handler model/attachment load capacity charts displayed in the operator's cab.
- Never use your attachment as a work platform or personnel carrier.
- Can't find the attachment you are looking for? Contact your JLG Aftermarket Parts representative at 1-877-JLG-LIFT or visit www.jlg.com.

Swing Carriage

The swing carriage permits the operator to maneuver loads through openings and tight spaces like windows or scaffolding by swinging the carriage to the right or left.

Features

- Right and left 90° swing option
- Right and left 180° swing option
- Standard up-and-down tilt on horizontal plane

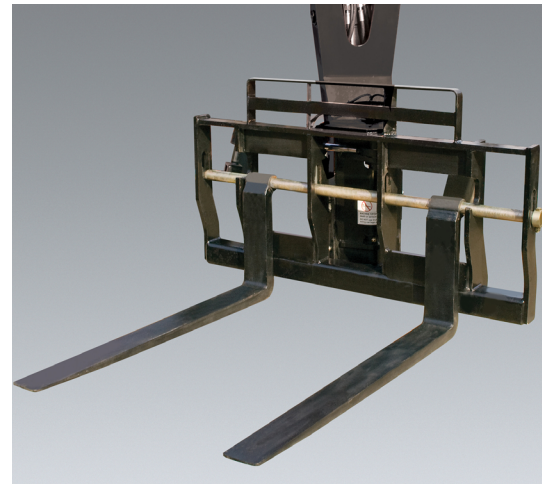

Current Production - Swing Carriages

Available Through JLG Aftermarket Or With New Machine Orders

CARRIAGE SIZE		72 in.	72 in.	
APPROX. WEIGHT		1154 lbs.	1,878 lbs.	
CARRIAGE SWING		90°	180°	
PART NO.		1001095418S	1001238627	
FORK PIN NO.		3423276	70020027	
MODEL	SN BREAKS	LOAD CHART BOOKLET		
JLG	642, 943, 1043, 1055, 1255 ONLY	Software, Chart Library	1001187087 (Ref No.)	
	742	ALL	1001226012	
	943/1043	Without Outriggers	1001212420	•
		With Outriggers	1001212419	•
	1055	Prior To 0160074169	1001212227	•
		0160074169 - Present	1001211156	•
	1255	Prior To 0160074168	1001212225	•
		0160074168 - Present	1001211153	•
	SKYTRAK™	6036	0160069720 - 0160075649, incl 0160065792, 0160065798, 0160065824, 0160069383, 0160069411, 0160075653 & 0160075722	1001199500
			0160075650 - Present, excl 0160075653 & 0160075722	1001211867
6042		0160069720 - 0160075656, incl 0160065792, 0160065798, 0160065824, 0160069383 & 0160069411	1001199504	•
		0160075657 - Present	1001211869	•
8042		0160069722 - 0160075670, incl 0160065791, 0160065796, 0160065825, 0160069336, 0160069359 & 0160069441	1001199508	•
		0160075671 - Present	1001211871	•
10042		0160069722 - 0160075987, incl 0160065791, 0160065796, 0160065825, 0160069336, 0160069359 & 0160069441	1001199512	•
		0160075988 - Present	1001211873	•
10054		0160069722 - 0160075682, incl 0160065791, 0160065796, 0160065825, 0160069336, 0160069359, 0160069441 & 0160075696	1001199518	•
		0160075683 - Present, excl 0160075696	1001211875	•

NOTES:
 • Use only JLG approved attachments with proper material handler model/attachment load capacity charts displayed in the operator's cab.
 • Never use your attachment as a work platform or personnel carrier.
 Can't find the attachment you are looking for? Contact your JLG Aftermarket Parts representative at 1-877-JLG-LIFT or visit www.jlg.com.

Non-Current Production - Swing Carriages, JLG

Available Through JLG Aftermarket Parts

CARRIAGE SIZE		72 in.	72 in.	72 in.	72 in.
APPROX. WEIGHT		1154 lbs.	1252 lbs.	1,878 lbs.	2112 lbs.
CARRIAGE SWING		90°	100°	180°	180°
PART NO.		1001095418S	91405075	1001238627	91563146
FORK PIN NO.		3423276	91401324	70020027	70020027
MODEL	SN BREAKS	LOAD CHART BOOKLET			
JLG	642	ALL	1001212421	•	
	G6-42A	Prior To 0160037722	1001105323	•	
		0160037722 - 0160040659	1001106001	•	
		0160040678 - Present	1001130793	•	
	G9-43A	Prior To 0160037671	1001105325	•	
		0160037671 - 0160040674, excl 0160040468 & 0160040672	1001106002	•	
		0160040675 - Present, incl 0160040468 & 0160040672	1001130663	•	
	G10-43A	0160037671 - 0160040674, excl 0160040468 & 0160040672	100113013	•	
		0160040675 - Present, incl 0160040468 & 0160040672	1001130935	•	
	G10-55A	Prior To 0160037689	1001105707	•	
		0160037690 - 0160038486, incl 0160038505 & 0160038507, excl 0160038324, 0160038489 & 0160038493	1001106003	•	
		0160038500 - Present, incl 0160038324, 0160038489 & 0160038493, excl 0160038505 & 0160038507	1001115135	•	
	G12-55A	0160037690 - Present, incl 0160038505, 0160038507, 0160038324, 0160038489 & 0160038493	1001115138		•
		Prior To 0160037689	1001105326		•
	G15-44A	0160037689 - 0160038533	1001106004	•	
0160038538 - Present		1001115536	•		
TF6-42	Prior To 0160074142	1001194130	•		
	0160074142 - Present	1001211953	•		
	ALL	Consult Factory		•	

Non-Current Production - Swing Carriages, Gradall

Available Through JLG Aftermarket Parts

CARRIAGE SIZE		72 in.	72 in.	72 in.	72 in.	72 in.
APPROX. WEIGHT		914 lbs.	1154 lbs.	1230 lbs.	1252 lbs.	1,878 lbs.
CARRIAGE SWING		90°	90°	100°	100°	180°
PART NO.		7125800S	1001095418S	90455044	91405075	1001238627
FORK PIN NO.		90551013	3423276	90551013	91401324	70020027
MODEL	SN BREAKS	LOAD CHART BOOKLET				
GRADALL	522D/524D	ALL	Consult Factory		•	
	534C-9	ALL	Consult Factory		•	
	534C-10	ALL	Consult Factory	•	•	
	534D-6	ALL	Consult Factory		•	
	534D-9	Prior To 0160037689	1001102719		•	
		0160037689 - Present	1001112753		•	
	534D-10	Prior To 0160037689	1001102720		•	
		0160037689 - Present	1001112753		•	
		0160037689 - Present	100110407			•
	544C	ALL	Consult Factory		•	
544D	Prior To 0160037689	1001102721		•		
	0160037689 - Present	1001106008		•		
	0160037689 - Present	1001110408			•	
G6-42P	Prior To 0160037689	1001105324			•	
	0160037689 - Present	1001106005		•		

NOTES:
 • Use only JLG approved attachments with proper material handler model/attachment load capacity charts displayed in the operator's cab.
 • Never use your attachment as a work platform or personnel carrier.
 Can't find the attachment you are looking for? Contact your JLG Aftermarket Parts representative at 1-877-JLG-LIFT or visit www.jlg.com.

Non-Current Production - Swing Carriages, SkyTrak
Available Through JLG Aftermarket Parts

CARRIAGE SIZE			52 in.	72 in.	72 in.	
APPROX. WEIGHT			959 lbs.	914 lbs.	1154 lbs.	
CARRIAGE SWING			90°	90°	90°	
PART NO.			7125900	7125800S	1001095418S	
FORK PIN NO.			7128782	90551013	3423276	
MODEL	SN BREAKS	LOAD CHART BOOKLET				
SKYTRAK	4266	ALL	Consult Factory	•	•	
	4270	ALL	Consult Factory	•	•	
	4290	ALL	Consult Factory	•	•	
	5028	ALL	Consult Factory	•	•	
	6036	Prior To 0160031200	Consult Factory	•	•	
		0160031200 - 0160069719, excl 0160065792, 0160065798, 0160065824, 0160069383 & 0160069411	1001199500			•
	6042	Prior To 0160031200	Consult Factory	•	•	
		0160031200 - 0160069719, excl 0160065792, 0160065798, 0160065824, 0160069383 & 0160069411	1001199504			•
	8042	Prior To 0160031235	Consult Factory	•	•	
		0160031235 - 0160069721, excl 0160065791, 0160065796, 0160065825, 0160065826, 0160069336, 0160069359 & 0160069441	1001199508			•
	10042	Prior To 0160031425	Consult Factory	•	•	
		0160031425 - 0160069721, excl 0160065791, 0160065796, 0160065825, 0160065826, 0160069336, 0160069359 & 0160069441	1001199512			•
10054	Prior To 0160031255	Consult Factory	•	•		
	0160031255 - 0160069721, excl 0160065791, 0160065796, 0160065825, 0160065826, 0160069336, 0160069359 & 0160069441	1001199518			•	

Non-Current Production - Swing Carriages, Lull
Available Through JLG Aftermarket Parts

CARRIAGE SIZE			52 in.	72 in.	72 in.	72 in.
APPROX. WEIGHT			959 lbs.	914 lbs.	1154 lbs.	1440 lbs.
CARRIAGE SWING			90°	90°	90°	90°
PART NO.			7125900	7125800S	1001095418S	1100532
FORK PIN NO.			7128782	90551013	3423276	7029710
MODEL	SN BREAKS	LOAD CHART BOOKLET				
LULL	644E-42	0160037900 - Present	1001106009			•
		Prior To 0160031500	7300628	•	•	
944E-42	944E-42	0160037794 - Present, incl 0160045421	1001134329			•
		Prior To 0160031500	7301586	•	•	
1044C-54 SII	1044C-54 SII	0160037794 - Present	1001106011			•
		Prior To 0160037893	1001105327			•



NOTES:
 • Use only JLG approved attachments with proper material handler model/attachment load capacity charts displayed in the operator's cab.
 • Never use your attachment as a work platform or personnel carrier.
 Can't find the attachment you are looking for? Contact your JLG Aftermarket Parts representative at 1-877-JLG-LIFT or visit www.jlg.com.

Tower Carriages

The tower increases mobility and efficiency on the job site. It allows the operator to move materials to a higher row of scaffolding by extending the vertical reach without any additional boom extension.

Features

- Tower requires auxiliary hydraulics
- Available with side-tilt carriage
 - JLG and Gradall models equipped with tower with side-tilt carriage requires auxiliary electrics
 - Lull 1044C-54 and 1044C-54 SII models equipped with tower with side-tilt carriage requires second auxiliary circuit
- Available with side-shift 100° swing carriage



Current Production - Tower Carriages
Available Through JLG Aftermarket Or With New Machine Orders

TOWER HEIGHT			8 ft.	8 ft.	8 ft.
CARRIAGE TYPE			Standard	Side-Tilt	Side-Tilt
CARRIAGE WIDTH			50 in.	50 in.	50 in.
INCLUDED FORK LENGTH			None	None	None
LIFTING CAPACITY			4500 lbs.	4500 lbs.	4500 lbs.
PART NO.			1001108668	1001108669	1001218255
FORK PIN NO.			70022990	70022990	70022990
MODEL	SN BREAKS	LOAD CHART BOOKLET			
JLG	642, 943, 1043, 1055, 1255 ONLY	Software, Chart Library	1001187087 (Ref No.)		
	742	ALL	1001226012	•	•
	943/1043	Without Outriggers	1001212420	•	•
		With Outriggers	1001212419	•	•
	1055	Prior To 0160074169	1001212227	•	
		0160074169 - Present	1001211156	•	
1255	Prior To 0160074168	1001212225	•	•	
	0160074168 - Present	1001211153	•	•	
SKYTRAK T4E	6036	0160069720 - 0160075649, incl 0160065792, 0160065798, 0160065824, 0160069383, 0160069411, 0160075653 & 0160075722	1001199500	•	
		0160075650 - Present, excl 0160075653 & 0160075722	1001211867	•	
	6042	0160069720 - 0160075656, incl 0160065792, 0160065798, 0160065824, 0160069383 & 0160069411	1001199504	•	
		0160075657 - Present	1001211869	•	
	8042	0160069722 - 0160075670, incl 0160065791, 0160065796, 0160065825, 0160065826, 0160069336, 0160069359 & 0160069441	1001199508	•	
		0160075671 - Present	1001211871	•	
	10042	0160069722 - 0160075987, incl 0160065791, 0160065796, 0160065825, 0160065826, 0160069336, 0160069359 & 0160069441	1001199512	•	
		0160075988 - Present	1001211873	•	
	10054	0160069722 - 0160075682, incl 0160065791, 0160065796, 0160065825, 0160065826, 0160069336, 0160069359, 0160069441 & 0160075696	1001199518	•	
		0160075683 - Present, excl 0160075696	1001211875	•	

NOTES:
 • Use only JLG approved attachments with proper material handler model/attachment load capacity charts displayed in the operator's cab.
 • Never use your attachment as a work platform or personnel carrier.
 Can't find the attachment you are looking for? Contact your JLG Aftermarket Parts representative at 1-877-JLG-LIFT or visit www.jlg.com.

Non-Current Production - Tower Carriages, JLG
Available Through JLG Aftermarket Parts

TOWER HEIGHT		6 ft.	6 ft.	8 ft.	8 ft.
CARRIAGE TYPE		Standard	Swing w/S.S.	Standard	Side-Tilt
CARRIAGE WIDTH		72 in.	72 in.	50 in.	50 in.
INCLUDED FORK LENGTH		None	60 in.	None	None
LIFTING CAPACITY		4500 lbs.	2878 lbs.	4500 lbs.	4500 lbs.
PART NO.		91405061	91415026	1001108668	1001108669
FORK PIN NO.		70020388	N/A	70022990	70022990
MODEL	SN BREAKS	LOAD CHART BOOKLET			
JLG G6-42A	642	ALL	1001212421		•
	G6-42A	Prior To 0160037722	1001105323	•	
		0160037722 - 0160040659	1001110401		•
		0160040678 - Present	1001130793		•
G9-43A	Prior To 0160037671	1001105325	•	•	
	0160037671 - 0160040674, excl 0160040468 & 0160040672	1001110402		•	
	0160040675 - Present, incl 0160040468 & 0160040672	1001130708		•	
G10-43A	0160037671 - 0160040674, excl 0160040468 & 0160040672	1001115257		•	
	0160040675 - Present, incl 0160040468 & 0160040672	1001130844		•	
G10-55A	Prior To 0160037689	1001105707	•	•	
	0160037690 - Present, incl 0160038505, 0160038507, 0160038324, 0160038489 & 0160038493	1001115138		•	
G12-55A	Prior To 0160037689	1001105326	•	•	
	0160037689 - Present	1001115540		•	
TF6-42	ALL	Consult Factory	•		

Non-Current Production - Tower Carriages, Gradall
Available Through JLG Aftermarket Parts

TOWER HEIGHT		6 ft.	8 ft.	8 ft.
CARRIAGE TYPE		Standard	Standard	Side-Tilt
CARRIAGE WIDTH		66 in.	50 in.	50 in.
INCLUDED FORK LENGTH		None	None	None
LIFTING CAPACITY		4000 lbs.	4500 lbs.	4500 lbs.
PART NO.		90455037	1001108668	1001108669
FORK PIN NO.		91034432	70022990	70022990
MODEL	SN BREAKS	LOAD CHART BOOKLET		
GRADALL	522D/524D	ALL	Consult Factory	•
	534C-9	ALL	Consult Factory	•
	534C-10	ALL	Consult Factory	•
	534D-6	ALL	Consult Factory	•
		Prior To 0160037689	1001102719	•
	534D-9	Prior To 0160037689	1001102720	•
		0160037689 - Present	1001110406	•
	534D-10	Prior To 0160037689	1001102721	•
		0160037689 - Present	1001110407	•
	544C	ALL	Consult Factory	•
	544D	Prior To 0160037689	1001102721	•
		0160037689 - Present	1001106008	•
	G6-42P	Prior To 0160037689	1001105324	•
		0160037689 - Present	1001106005	•

Continues on next page

- NOTES:
- Use only JLG approved attachments with proper material handler model/attachment load capacity charts displayed in the operator's cab.
 - Never use your attachment as a work platform or personnel carrier.
- Can't find the attachment you are looking for? Contact your JLG Aftermarket Parts representative at 1-877-JLG-LIFT or visit www.jlg.com.

Non-Current Production - Tower Carriages, SkyTrak
Available Through JLG Aftermarket Parts

TOWER HEIGHT		8 ft.
CARRIAGE TYPE		Standard
CARRIAGE WIDTH		50 in.
INCLUDED FORK LENGTH		None
LIFTING CAPACITY		4500 lbs.
PART NO.		1001108668
FORK PIN NO.		70022990
MODEL	SN BREAKS	LOAD CHART BOOKLET
SKYTRAK	6036	0160031200 - 0160069719, excl 0160065792, 0160065798, 0160065824, 0160069383 & 0160069411
	6042	0160031200 - 0160069719, excl 0160065792, 0160065798, 0160065824, 0160069383 & 0160069411
	8042	0160031235 - 0160069721, excl 0160065791, 0160065796, 0160065825, 0160065826, 0160069336, 0160069359 & 0160069441
	10042	0160031425 - 0160069721, excl 0160065791, 0160065796, 0160065825, 0160065826, 0160069336, 0160069359 & 0160069441
		0160037798 - Present
	10054	0160031255 - 0160069721, excl 0160065791, 0160065796, 0160065825, 0160065826, 0160069336, 0160069359 & 0160069441
0160037793 - Present		

Non-Current Production - Tower Carriages, Lull
Available Through JLG Aftermarket Parts

TOWER HEIGHT		8 ft.	8 ft.	8 ft.
CARRIAGE TYPE		Standard	Standard	Side-Tilt
CARRIAGE WIDTH		50 in.	50 in.	50 in.
INCLUDED FORK LENGTH		None	None	None
LIFTING CAPACITY		2629 lbs.	4500 lbs.	4500 lbs.
PART NO.		48056	1001108668	1001108670
FORK PIN NO.		10138064	70022990	70022990
MODEL	SN BREAKS	LOAD CHART BOOKLET		
LULL	644E-42	0160037900 - Present	1001106009	•
	944E-42	0160037794 - Present, incl 0160045421	1001134329	•
		Prior To 0160037893	1001105327	•
	1044C-54 SII	0160037900 - Present	1001110409	•

- NOTES:
- Use only JLG approved attachments with proper material handler model/attachment load capacity charts displayed in the operator's cab.
 - Never use your attachment as a work platform or personnel carrier.
- Can't find the attachment you are looking for? Contact your JLG Aftermarket Parts representative at 1-877-JLG-LIFT or visit www.jlg.com.

Auger

An auger expands the functionality of your telehandler. Not only can the machine go up in the air but also down into the ground. With various auger bit sizes available, the operator can be precise in choosing one to best fit the task at hand.

Features

- Auger Drive Motor Part No. 1001092816 & Adapter Part No. 6043600 Required for SkyTrak and Lull E-Series applications
- Auger Drive Motor Part No. 51012 Required for Lull C-Series applications

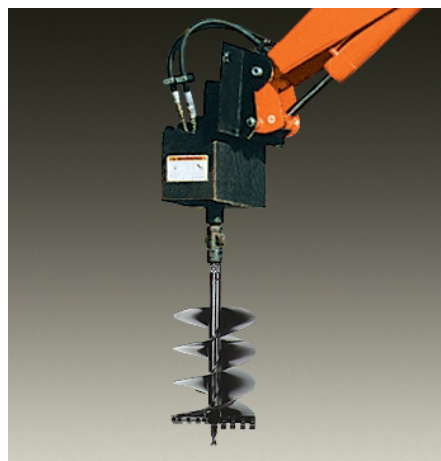

Auger Bits

Current Production - Auger Bits
Available Through JLG Aftermarket Parts

DIAMETER			6 to 18 in.
DEPTH			48 in.
PART NO.			1001242616
	MODEL	SN BREAKS	LOAD CHART BOOKLET
JLG	G5-18A	with the Universal (skid steer) quick coupler 0160040809 - Present	1001126677

Non-Current Production - Auger Bits, SkyTrak
Available Through JLG Aftermarket Parts

DIAMETER			6 in.	9 in.	12 in.	15 in.	18 in.	24 in.
DEPTH			50 in.	50 in.	50 in.	50 in.	50 in.	50 in.
PART NO.			8866415	8866416	8866417	8866418	8866419	8866420
	MODEL	SN BREAKS	LOAD CHART BOOKLET					
SKYTRAK	6036	Prior To 0160031200	Consult Factory	•	•	•	•	•
	6042	Prior To 0160031200	Consult Factory	•	•	•	•	•
	8042	Prior To 0160031235	Consult Factory	•	•	•	•	•
	10042	Prior To 0160031425	Consult Factory	•	•	•	•	•
	10054	Prior To 0160031255	Consult Factory	•	•	•	•	•

Non-Current Production - Auger Bits, Lull
Available Through JLG Aftermarket Parts

DIAMETER			6 in.	9 in.	12 in.	15 in.	18 in.	24 in.	8 in.	12 in.	16 in.	18 in.
DEPTH			50 in.	50 in.	50 in.	50 in.	50 in.	50 in.	60 in.	60 in.	60 in.	60 in.
PART NO.			8866415	8866416	8866417	8866418	8866419	8866420	10166297	10166298	10166994	10166299
	MODEL	SN BREAKS	LOAD CHART BOOKLET									
LULL	644E-42	Prior To 0160031500	7300628	•	•	•	•	•	•	•	•	•
	944E-42	Prior To 0160031500	7301586	•	•	•	•	•	•	•	•	•
	1044C-54 Sil	Prior To 0160037893	1001105327						•	•	•	•

NOTES:
 • Use only JLG approved attachments with proper material handler model/attachment load capacity charts displayed in the operator's cab.
 • Never use your attachment as a work platform or personnel carrier.
 Can't find the attachment you are looking for? Contact your JLG Aftermarket Parts representative at 1-877-JLG-LIFT or visit www.jlg.com.

Auger Extensions

Non-Current Production - Auger Extensions, SkyTrak
Available Through JLG Aftermarket Parts

LENGTH			14 in.	24 in.
PART NO.			8866422	8866423
	MODEL	SN BREAKS	LOAD CHART BOOKLET	
SKYTRAK	6036	Prior To 0160031200	Consult Factory	•
	6042	Prior To 0160031200	Consult Factory	•
	8042	Prior To 0160031235	Consult Factory	•
	10042	Prior To 0160031425	Consult Factory	•
	10054	Prior To 0160031255	Consult Factory	•

Non-Current Production - Auger Extensions, Lull
Available Through JLG Aftermarket Parts

LENGTH			14 in.
PART NO.			8866422
	MODEL	SN BREAKS	LOAD CHART BOOKLET
LULL	644E-42	Prior To 0160031500	7300628
	944E-42	Prior To 0160031500	7301586



NOTES:
 • Use only JLG approved attachments with proper material handler model/attachment load capacity charts displayed in the operator's cab.
 • Never use your attachment as a work platform or personnel carrier.
 Can't find the attachment you are looking for? Contact your JLG Aftermarket Parts representative at 1-877-JLG-LIFT or visit www.jlg.com.

Bale Clamp

The bale clamp attachment is used in the agriculture industry, making it easy to maneuver hay or straw bales. The bale clamps can grab bales that are approximately 79 inches in diameter.

Features

- Spike-style bale clamp available (shown) and tube-style bale clamp available

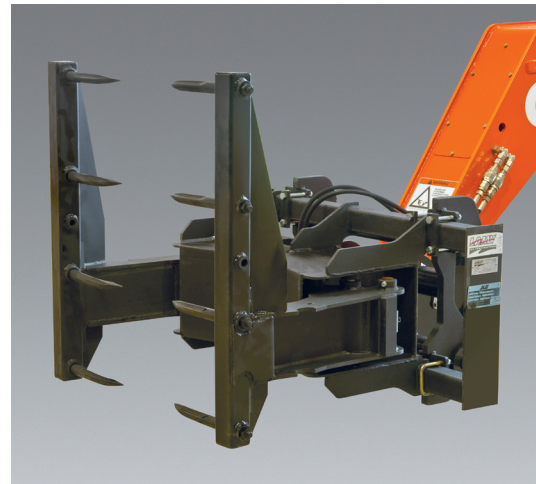

Current Production - Dual Baling Tine Carriage

Available Through JLG Aftermarket Parts

PART NO.			1001242511	1001242517
MODEL		SN BREAKS	LOAD CHART BOOKLET	
JLG	G5-18A	Quick coupler (hydraulic or manual)	1001102000	•
		Universal (skid steer) quick coupler	1001126677	•

Current Production - Bale Clamp

Available Through JLG Aftermarket Parts

STYLE			Round	Square
PART NO.			1001192649	1001192650
MODEL		SN BREAKS	LOAD CHART BOOKLET	
JLG	1644	ALL	1001233430	•
	1732	ALL	1001233431	•
	G5-18A	ALL	001126677	•

Non-Current Production - Bale Clamp, JLG

Available Through JLG Aftermarket Parts

STYLE			Tube	Spike
PART NO.			0240117	0240118
MODEL		SN BREAKS	LOAD CHART BOOKLET	
JLG	619A	ALL	Consult Factory	•
	723A	ALL	Consult Factory	•

NOTES:

- Use only JLG approved attachments with proper material handler model/attachment load capacity charts displayed in the operator's cab.
 - Never use your attachment as a work platform or personnel carrier.
- Can't find the attachment you are looking for? Contact your JLG Aftermarket Parts representative at 1-877-JLG-LIFT or visit www.jlg.com.

4-in-1 Bucket

This bucket saves you time and money. The 4-in-1 bucket can be used for loading, leveling, bottom dumping or as a grapple bucket. 4-in-1 buckets are not designed for digging.



Current Production - 4-in-1 Bucket

Available Through JLG Aftermarket Parts

BUCKET SIZE			94 in.
CAPACITY			2.6 cu. yd
APPROX. WEIGHT			3,473 lbs.
PART NO.			1001192614
MODEL		SN BREAKS	LOAD CHART BOOKLET
JLG	1644	ALL	1001233430
	1732	ALL	1001233431

Non-Current Production - 4-in-1 Bucket- JLG

Available Through JLG Aftermarket Parts

BUCKET SIZE			81 in.	96 in.
CAPACITY			.78 cu. yd.	13 cu. yd.
APPROX. WEIGHT			1503 lbs.	1806 lbs.
PART NO.			0930006	0930003
MODEL		SN BREAKS	LOAD CHART BOOKLET	
JLG	619A	ALL	Consult Factory	•
	723A	ALL	Consult Factory	•
	G5-19A	ALL	Consult Factory	•
	G6-23A	ALL	Consult Factory	•

NOTES:

- Use only JLG approved attachments with proper material handler model/attachment load capacity charts displayed in the operator's cab.
 - Never use your attachment as a work platform or personnel carrier.
- Can't find the attachment you are looking for? Contact your JLG Aftermarket Parts representative at 1-877-JLG-LIFT or visit www.jlg.com.

Fork Mounted Bucket

The fork mounted bucket provides the versatility of a bucket with the convenience of not needing to remove forks and carriages.

Features

- Cost effective alternative to a coupler mounted bucket
- For use with approved JLG telehandlers

Specifications

- Maximum capacity: 2000 lbs
- Maximum weight: 705 lbs
- 60" bucket
- Bucket width: 1 cu. yd.
- 48" forks
- Distance to center of gravity: 22.5 in.

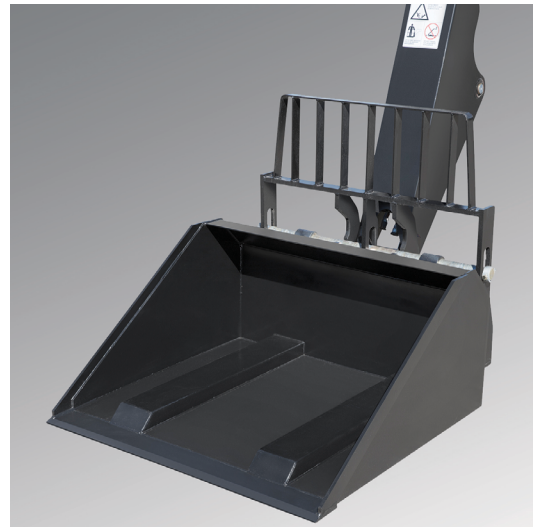

Non-Current Production - Fork Mounted Bucket, JLG Available Through JLG Aftermarket Parts

BUCKET WIDTH		60"
CAPACITY		2000 lbs.
APPROX. WEIGHT		705 lbs.
PART NO.		1001195970
	MODEL	SN BREAKS
JLG	642	ALL
	G6-42A	0160037722 - 0160040659
		0160040678 - Present
	G9-43A	0160037671 - 0160040674, excl 0160040468 & 0160040672
		0160040675 - Present, incl 0160040468 & 0160040672
	G10-43A	0160037671 - 0160040674, excl 0160040468 & 0160040672
		0160040675 - Present, incl 0160040468 & 0160040672
	G10-55A	0160037690 - Present, incl 0160038505, 0160038507, 0160038324, 0160038489 & 0160038493
	G12-55A	0160037689 - Present

Current Production - Fork Mounted Bucket Available Through JLG Aftermarket Or With New Machine Orders

BUCKET WIDTH		60"
CAPACITY		2000 lbs.
APPROX. WEIGHT		705 lbs.
PART NO.		1001195970
	MODEL	SN BREAKS
JLG	742	ALL
	943/1043	Without Outriggers
		With Outriggers
	1055	Prior To 0160074169
		0160074169 - Present
	1255	Prior To 0160074168
		0160074168 - Present
1644	ALL	
1732	ALL	
SKYTRAK™	6036	0160069720 - 0160075649, incl 0160065792, 0160065798, 0160065824, 0160069383, 0160069411, 0160075653 & 0160075722
		0160075650 - Present, excl 0160075653 & 0160075722
	6042	0160069720 - 0160075656, incl 0160065792, 0160065798, 0160065824, 0160069383 & 0160069411
		0160075657 - Present
	8042	0160069722 - 0160075670, incl 0160065791, 0160065796, 0160065825, 0160065826, 0160069336, 0160069359 & 0160069441
		0160075671 - Present
	10042	0160069722 - 0160075987, incl 0160065791, 0160065796, 0160065825, 0160065826, 0160069336, 0160069359 & 0160069441
		0160075988 - Present
	10054	0160069722 - 0160075682, incl 0160065791, 0160065796, 0160065825, 0160065826, 0160069336, 0160069359, 0160069441 & 0160075696
		0160075683 - Present, excl 0160075696

Use Appropriate Carriage Attachment Load Chart

- NOTES:
- Use only JLG approved attachments with proper material handler model/attachment load capacity charts displayed in the operator's cab.
 - Never use your attachment as a work platform or personnel carrier.
- Can't find the attachment you are looking for? Contact your JLG Aftermarket Parts representative at 1-877-JLG-LIFT or visit www.jlg.com.



Use Appropriate Carriage Attachment Load Chart

- NOTES:
- Use only JLG approved attachments with proper material handler model/attachment load capacity charts displayed in the operator's cab.
 - Never use your attachment as a work platform or personnel carrier.
- Can't find the attachment you are looking for? Contact your JLG Aftermarket Parts representative at 1-877-JLG-LIFT or visit www.jlg.com.

Grapple Bucket

The grapple bucket uses hydraulic arms to secure bulky loads and materials. This feature is useful when cleaning up natural disaster sites and day-to-day job site scraps. Grapple buckets are not designed for digging.

Features

- Independent grapple arms require auxiliary hydraulics (except 619A, 723A, G5-19A and G6-23A)



Current Production - Grapple Bucket Available Through JLG Aftermarket Or With New Machine Orders

BUCKET SIZE		72 in.	94 in.	94 in.	96 in.		
CAPACITY		1 cu. yd.	1.7 cu. yd.	2.6 cu. yd.	1.75 cu. yd.		
APPROX. WEIGHT		1096 lbs.	1,514 lbs.	1,514 lbs.	1514 lbs.		
PART NO.		1001102327	1001233435	1001192617	0930020		
MODEL	SN BREAKS	LOAD CHART BOOKLET					
JLG	642, 943, 1043, 1055, 1255 ONLY	Software, Chart Library				1001187087 (Ref No.)	
	742	ALL				100226012	
	943/1043	Without Outriggers				1001212420	
		With Outriggers				1001212419	
	1055	Prior To 0160074169				1001212227	
		0160074169 - Present				1001211156	
	1255	Prior To 0160074168				1001212225	
		0160074168 - Present				1001211153	
	1644	ALL				1001233430	
	1732	ALL				1001233431	
	G5-18A	Quick coupler (hydraulic or manual)				1001102000	
	SKYTRAK™	6036	0160069720 - 0160075649, incl 0160065792, 0160065798, 0160065824, 0160069383, 0160069411, 0160075653 & 0160075722				1001199500
			0160075650 - Present, excl 0160075653 & 0160075722				1001211867
		6042	0160069720 - 0160075656, incl 0160065792, 0160065798, 0160065824, 0160069383 & 0160069411				1001199504
0160075657 - Present				1001211869			
8042		0160069722 - 0160075670, incl 0160065791, 0160065796, 0160065825, 0160065826, 0160069336, 0160069359 & 0160069441				1001199508	
		0160075671 - Present				1001211871	
10042		0160069722 - 0160075987, incl 0160065791, 0160065796, 0160065825, 0160065826, 0160069336, 0160069359 & 0160069441				1001199512	
		0160075988 - Present				1001211873	
10054		0160069722 - 0160075682, incl 0160065791, 0160065796, 0160065825, 0160065826, 0160069336, 0160069359, 0160069441 & 0160075696				1001199518	
		0160075683 - Present, excl 0160075696				1001211875	

NOTES:
 · Use only JLG approved attachments with proper material handler model/attachment load capacity charts displayed in the operator's cab.
 · Never use your attachment as a work platform or personnel carrier.
 Can't find the attachment you are looking for? Contact your JLG Aftermarket Parts representative at 1-877-JLG-LIFT or visit www.jlg.com.

Non-Current Production - Grapple Buckets, JLG Available Through JLG Aftermarket Parts

BUCKET SIZE		83 in.	96 in.	96 in.	96 in.	
CAPACITY		1.96 cu. yd.	1.75 cu. yd.	2.35 cu. yd.	1.75 cu. yd.	
APPROX. WEIGHT		1403 lbs.	1740 lbs.	1554 lbs.	1514 lbs.	
PART NO.		0930005	09300215*	0930004	0930020	
MODEL	SN BREAKS	LOAD CHART BOOKLET				
JLG	642	ALL				1001212421
	619A	ALL				Consult Factory
	723A	ALL				Consult Factory
	G5-19A	ALL				Consult Factory
	G6-23A	ALL				Consult Factory
	G6-42A	Prior To 0160037722				1001105323
		0160037722 - 0160040659				100110401
		0160040678 - Present				1001130739
	G9-43A	Prior To 0160037671				1001105325
		0160037671 - 0160040674, excl 0160040468 & 0160040672				100110402
		0160040675 - Present, incl 0160040468 & 0160040672				1001130708
	G10-43A	0160037671 - 0160040674, excl 0160040468 & 0160040672				100115257
		0160040675 - Present, incl 0160040468 & 0160040672				1001130844
	G10-55A	Prior To 0160037689				1001105707
		0160037690 - Present, incl 0160038505, 0160038507, 0160038324, 0160038489 & 0160038493				1001151358
G12-55A	Prior To 0160037689				1001105326	
	0160037689 - Present				100115540	
G15-44A	Prior To 0160074142				1001194130	
	0160074142 - Present				1001211953	

* Includes Load Chart

Non-Current Production - Grapple Buckets, Gradall Available Through JLG Aftermarket Parts

BUCKET SIZE		96 in.	
CAPACITY		1.75 cu. yd.	
APPROX. WEIGHT		1514 lbs.	
PART NO.		0930020	
MODEL	SN BREAKS	LOAD CHART BOOKLET	
GRADALL	534D-9	0160037689 - Present	100110406
	534D-10	0160037689 - Present	100110407
	544D	0160037689 - Present	100110408
	G6-42P	0160037689 - Present	100110405

NOTES:
 · Use only JLG approved attachments with proper material handler model/attachment load capacity charts displayed in the operator's cab.
 · Never use your attachment as a work platform or personnel carrier.
 Can't find the attachment you are looking for? Contact your JLG Aftermarket Parts representative at 1-877-JLG-LIFT or visit www.jlg.com.

Non-Current Production - Grapple Buckets, SkyTrak
Available Through JLG Aftermarket Parts

BUCKET SIZE				96 in.
CAPACITY				1.75 cu. yd.
APPROX. WEIGHT				1514 lbs.
PART NO.				0930020
	MODEL	SN BREAKS	LOAD CHART BOOKLET	
SKYTRAK	6036	0160031200 - 0160069719, excl 0160065792, 0160065798, 0160065824, 0160069383 & 0160069411	1001199500	•
	6042	0160031200 - 0160069719, excl 0160065792, 0160065798, 0160065824, 0160069383 & 0160069411	1001199504	•
	8042	0160031235 - 0160069721, excl 0160065791, 0160065796, 0160065825, 0160065826, 0160069336, 0160069359 & 0160069441	1001199508	•
	10042	0160031425 - 0160069721, excl 0160065791, 0160065796, 0160065825, 0160065826, 0160069336, 0160069359 & 0160069441	1001199512	•
	10054	0160031255 - 0160069721, excl 0160065791, 0160065796, 0160065825, 0160065826, 0160069336, 0160069359 & 0160069441	1001199518	•

Non-Current Production - Grapple Buckets, Lull
Available Through JLG Aftermarket Parts

BUCKET SIZE				96 in.
CAPACITY				1.75 cu. yd.
APPROX. WEIGHT				1514 lbs.
PART NO.				0930020
	MODEL	SN BREAKS	LOAD CHART BOOKLET	
LULL	644E-42	0160037900 - Present	100110410	•
	944E-42	0160037794 - Present, incl 0160045421	100110411	•
	1044C-54 SII	0160037794 - Present	100110409	•

Material Bucket

Use the material bucket to scoop and carry loose material and debris like gravel or dirt. The material bucket can also be used for clean up around the job site. Material buckets are not designed for digging.

Features

- Available in different widths and capacities for various jobsite requirements
- Bucket teeth kits available for 0930008, 0930009, 0930015 and 0930016 material buckets (purchase part number 1001094612)

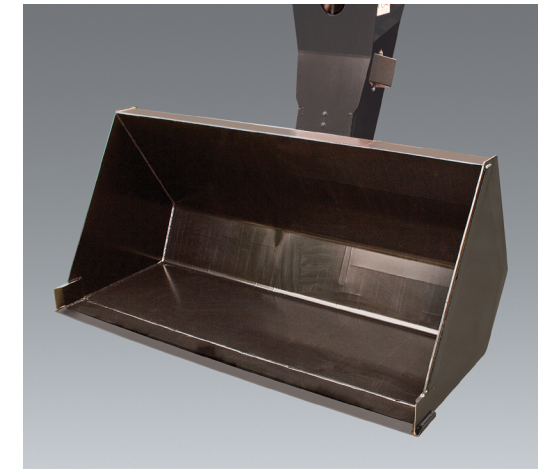

Current Production - Material Bucket
Available Through JLG Aftermarket Or With New Machine Orders

BUCKET WIDTH			72 in.	72 in.	73 in.	94 in.	94 in.	94 in.	96 in.	102 in.	
CAPACITY			1.0 cu. yd.	1.7 cu. yd.	1.0 cu. yd.	1.3 cu. yd.	2.6 cu. yd.	5.2 cu. yd.	1.5 cu. yd.	2.0 cu. yd.	
APPROX. WEIGHT			733 lbs.	838 lbs.	710 lbs.	2528 lbs.	1692 lbs.	2210 lbs.	899 lbs.	1089 lbs.	
PART NO.			1001100822	1001102323*	1001102324*	1001228427	1001192615	1001192616	1001100823	1001100824	
	MODEL	SN BREAKS	LOAD CHART BOOKLET								
JLG	642, 943, 1043, 1055, 1255 ONLY	Software, Chart Library	1001187087 (Ref No.)								
	742	Without Outriggers	1001226012	•					•	•	
	943/1043	Without Outriggers	1001212420	•						•	•
		With Outriggers	1001212419	•						•	•
	1055	Prior To 0160074169	1001212227	•						•	•
		0160074169 - Present	1001211156	•						•	•
	1255	Prior To 0160074168	1001212225	•						•	•
		0160074168 - Present	1001211153	•						•	•
	1644	ALL	1001233430				•	•	•		
	1732	ALL	1001233431				•	•	•		
G5-18A	Quick coupler (hydraulic or manual)	1001102000									
SKYTRAK THF	6036	0160069720 - 0160075649, incl 0160065792, 0160065798, 0160065824, 0160069383, 0160069411, 0160075653 & 0160075722	1001199500	•						•	•
		0160075650 - Present, excl 0160075653 & 0160075722	1001211867	•						•	•
	6042	0160069720 - 0160075656, incl 0160065792, 0160065798, 0160065824, 0160069383 & 0160069411	1001199504	•						•	•
		0160075657 - Present	1001211869	•						•	•
	8042	0160069722 - 0160075670, incl 0160065791, 0160065796, 0160065825, 0160065826, 0160069336, 0160069359 & 0160069441	1001199508	•						•	•
		0160075671 - Present	1001211871	•						•	•
	10042	0160069722 - 0160075987, incl 0160065791, 0160065796, 0160065825, 0160065826, 0160069336, 0160069359 & 0160069441	1001199512	•						•	•
		0160075988 - Present	1001211873	•						•	•
	10054	0160069722 - 0160075682, incl 0160065791, 0160065796, 0160065825, 0160065826, 0160069336, 0160069359, 0160069441 & 0160075696	1001199518	•						•	•
		0160075683 - Present, excl 0160075696	1001211875	•						•	•

* Replacement cutting edge not available separately

NOTES:
 • Use only JLG approved attachments with proper material handler model/attachment load capacity charts displayed in the operator's cab.
 • Never use your attachment as a work platform or personnel carrier.
 Can't find the attachment you are looking for? Contact your JLG Aftermarket Parts representative at 1-877-JLG-LIFT or visit www.jlg.com.

NOTES:
 • Use only JLG approved attachments with proper material handler model/attachment load capacity charts displayed in the operator's cab.
 • Never use your attachment as a work platform or personnel carrier.
 Can't find the attachment you are looking for? Contact your JLG Aftermarket Parts representative at 1-877-JLG-LIFT or visit www.jlg.com.

Non-Current Production - Material Buckets, JLG
Available Through JLG Aftermarket Parts

BUCKET WIDTH			60 in.	72 in.	74 in.	83 in.	83 in.	96 in.	96 in.	96 in.	102 in.	102 in.	
CAPACITY			.75 cu. yd.	1.0 cu. yd.	1.25 cu. yd.	1.05 cu. yd.	1.96 cu. yd.	1.18 cu. yd.	1.5 cu. yd.	2.35 cu. yd.	1.25 cu. yd.	2.0 cu. yd.	
APPROX. WEIGHT			500 lbs.	733 lbs.	675 lbs.	639 lbs.	940 lbs.	712 lbs.	899 lbs.	1041 lbs.	720 lbs.	1089 lbs.	
PART NO.			91405054	1001100822	91405055	0930008	0930009	0930015	1001100823	0930016	91405071	1001100824	
MODEL	SN BREAKS	LOAD CHART BOOKLET											
JLG	642	ALL	1001212421	.				.				.	
	619A	ALL	Consult Factory			.	.	.					
	723A	ALL	Consult Factory					.		.			
	G5-19A	ALL	Consult Factory			.	.						
	G6-23A	ALL	Consult Factory					.		.			
	G6-42A	Prior To 0160037722	1001105323	.	.						.		
		0160037722 - 0160040659	1001106001
		0160040678 - Present	1001130793
	G9-43A	Prior To 0160037671	1001105325
		0160037671 - 0160040674, excl 0160040468 & 0160040672	1001106002
		0160040675 - Present, incl 0160040468 & 0160040672	1001130663
	G10-43A	Prior To 0160037671	1001130935
		0160037671 - 0160040674, excl 0160040468 & 0160040672	100113013
		0160040675 - Present, incl 0160040468 & 0160040672	1001130935
G10-55A	Prior To 0160037689	1001105707	
	0160037690 - 0160038486, incl 0160038505 & 0160038507, excl 0160038324, 0160038489 & 0160038493	1001106003	
	0160038500 - Present, incl 0160038324, 0160038489 & 0160038493, excl 0160038505 & 0160038507	1001115135	
G12-55A	Prior To 0160037689	1001105326	
	0160037689 - 0160038533	1001106004	
G15-44A	Prior To 0160074142	1001194130	
	0160074142 - Present	1001211953	
TF6-42	ALL	Consult Factory	

NOTES:
 · Use only JLG approved attachments with proper material handler model/attachment load capacity charts displayed in the operator's cab.
 · Never use your attachment as a work platform or personnel carrier.
 Can't find the attachment you are looking for? Contact your JLG Aftermarket Parts representative at 1-877-JLG-LIFT or visit www.jlg.com.

Non-Current Production - Material Buckets, Gradall
Available Through JLG Aftermarket Parts

BUCKET WIDTH			60 in.	60 in.	72 in.	74 in.	74 in.	96 in.	102 in.	102 in.	
CAPACITY			.75 cu. yd.	.75 cu. yd.	1.0 cu. yd.	1.25 cu. yd.	1.25 cu. yd.	1.5 cu. yd.	1.25 cu. yd.	2 cu. yd.	
APPROX. WEIGHT			465 lbs.	500 lbs.	733 lbs.	643 lbs.	675 lbs.	899 lbs.	720 lbs.	1089 lbs.	
PART NO.			90455049	91405054	1001100822	90555020	91405055	1001100823	91405071	1001100824	
MODEL	SN BREAKS	LOAD CHART BOOKLET									
GRADALL	522D/524D	ALL	Consult Factory	.		.					
	534C-10	ALL	Consult Factory	.		.					
	534D-6	ALL	Consult Factory	.		.					
	534D-9	Prior To 0160037689	1001102719	.		.					
		Prior To 0160037689	1001102720	.		.					
	534D-10	Prior To 0160037689	1001102721	.		.					
		0160037689 - Present	1001112753			.			.		.
	544D	Prior To 0160037689	1001102721			.			.		.
		0160037689 - Present	1001106008
	G6-42P	Prior To 0160037689	1001105324	
0160037689 - Present		1001106005		

Non-Current Production - Material Buckets, SkyTrak
Available Through JLG Aftermarket Parts

BUCKET WIDTH			72 in.	96 in.	96 in.	102 in.	
CAPACITY			1.0 cu. yd.	1.25 cu. yd.	1.5 cu. yd.	2.0 cu. yd.	
APPROX. WEIGHT			733 lbs.	795 lbs.	899 lbs.	1089 lbs.	
PART NO.			1001100822	7110744	1001100823	1001100824	
MODEL	BREAK	LOAD CHART BOOKLET					
SKYTRAK	4266	ALL	Consult Factory	.			
	4270	ALL	Consult Factory	.			
	4290	ALL	Consult Factory	.			
	5028	ALL	Consult Factory	.			
	6036	Prior To 0160031200	Consult Factory	.	.		
		0160031200 - 0160069719, excl 0160065792, 0160065798, 0160065824, 0160069383 & 0160069411	1001199500
	6042	Prior To 0160031200	Consult Factory	.	.		
		0160031200 - 0160069719, excl 0160065792, 0160065798, 0160065824, 0160069383 & 0160069411	1001199504
	8042	Prior To 0160031235	Consult Factory	.	.		
		0160031235 - 0160069721, excl 0160065791, 0160065796, 0160065825, 0160065826, 0160069336, 0160069359 & 0160069441	1001199508
	10042	Prior To 0160031425	Consult Factory	.	.		
		0160031425 - 0160069721, excl 0160065791, 0160065796, 0160065825, 0160065826, 0160069336, 0160069359 & 0160069441	1001199512
	10054	Prior To 0160031255	Consult Factory	.	.		
		0160031255 - 0160069721, excl 0160065791, 0160065796, 0160065825, 0160065826, 0160069336, 0160069359 & 0160069441	1001199518

NOTES:
 · Use only JLG approved attachments with proper material handler model/attachment load capacity charts displayed in the operator's cab.
 · Never use your attachment as a work platform or personnel carrier.
 Can't find the attachment you are looking for? Contact your JLG Aftermarket Parts representative at 1-877-JLG-LIFT or visit www.jlg.com.

Non-Current Production - Material Buckets, Lull
Available Through JLG Aftermarket Parts

BUCKET WIDTH			72 in.	96 in.	96 in.	96 in.	102 in.	
CAPACITY			1.0 cu. yd.	1.25 cu. yd.	1.25 cu. yd.	1.5 cu. yd.	2.0 cu. yd.	
APPROX. WEIGHT			733 lbs.	540 lbs.	795 lbs.	899 lbs.	1089 lbs.	
PART NO.			1001100822	1101435	7110744	1001100823	1001100824	
MODEL	SN BREAKS	LOAD CHART BOOKLET						
LULL	644B-37	ALL	Consult Factory		•			
	644B-42	ALL	Consult Factory		•			
	644D-34	ALL	Consult Factory		•			
	644E-42	Prior To 0160031500	7300628			•		
		0160037900 - Present	1001106009		•		•	•
	844C-42	ALL	Consult Factory		•			
	944E-42	Prior To 0160031500	7301586			•		
		0160037794 - Present, incl 0160045421	1001134329		•		•	•
	1044C-54 SII	Prior To 0160037893	1001105327			•		
		0160037794 - Present	1001106011		•		•	•
	6K-37	ALL	Consult Factory		•			
	6K-42	ALL	Consult Factory		•			
	8K-42	ALL	Consult Factory		•			
	10K-42/10K-54	ALL	Consult Factory		•			



To order go to Discount-Equipment.com

NOTES:
 • Use only JLG approved attachments with proper material handler model/attachment load capacity charts displayed in the operator's cab.
 • Never use your attachment as a work platform or personnel carrier.
 Can't find the attachment you are looking for? Contact your JLG Aftermarket Parts representative at 1-877-JLG-LIFT or visit www.jlg.com.

Coupler Mounted Lifting Hook

Optimize the use of your JLG telehandler with the new coupler mounted lifting hook. The lifting hook attaches directly to your machine, without the need of a carriage or forks. The lifting hook allows the ability to lift a suspended load without the obstruction of forks extending beyond the attachment.

Features

- Directly mounts onto machine coupler
- Picks up and carries loads as easily as a fork mounted lifting hook
- Increased visibility of load for operator

Specifications

- Maximum capacity: 15,000 lbs
- Maximum weight: 178 lbs
- Distance to center of gravity: 4.4 in

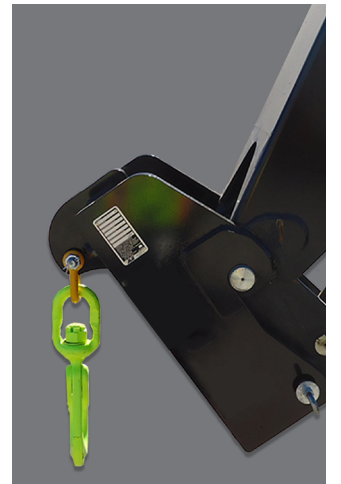
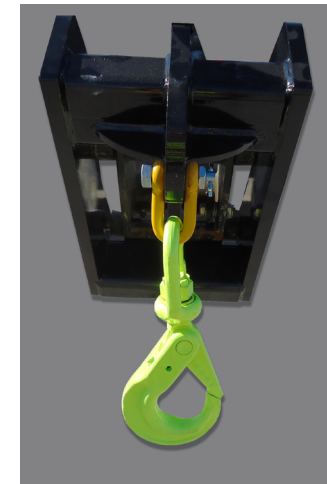

Current Production - Coupler Mounted Lifting Hook
Available Through JLG Aftermarket Or With New Machine Orders

CAPACITY			5,500 lbs.	15,000 lbs.	16,755 lbs.	
APPROX. WEIGHT			133 lbs.	178 lbs.	354 lbs.	
PART NO.			1001242510	1001207606	1001192700	
MODEL	SN BREAKS	LOAD CHART BOOKLET				
JLG	642, 943, 1043, 1055, 1255 ONLY	Software, Chart Library	1001187087 (Ref No.)			
	742	ALL	1001226012		•	
	943/1043	Without Outriggers	1001212420		•	
		With Outriggers	1001212419		•	
	1055	Prior To 0160074169	1001212227		•	
		0160074169 - Present	1001211156		•	
	1255	Prior To 0160074168	1001212225		•	
		0160074168 - Present	1001211153		•	
	1644	ALL	1001233430			•
	1732	ALL	1001233431			•
	G5-18A	with the Universal (skid steer) quick coupler 0160040809 - Present	100126677	•	•	
	SKYTRAK T4F	6036	0160069720 - 0160075649, incl 0160065792, 0160065798, 0160065824, 0160069383, 0160069411, 0160075653 & 0160075722	1001199500		•
			0160075650 - Present, excl 0160075653 & 0160075722	1001211867		•
		6042	0160069720 - 0160075656, incl 0160065792, 0160065798, 0160065824, 0160069383 & 0160069411	1001199504		•
0160075657 - Present			1001211869		•	
8042		0160069722 - 0160075670, incl 0160065791, 0160065796, 0160065825, 0160065826, 0160069336, 0160069359 & 0160069441	1001199508		•	
		0160075671 - Present	1001211871		•	
10042		0160069722 - 0160075987, incl 0160065791, 0160065796, 0160065825, 0160065826, 0160069336, 0160069359 & 0160069441	1001199512		•	
		0160075988 - Present	1001211873		•	
10054		0160069722 - 0160075682, incl 0160065791, 0160065796, 0160065825, 0160065826, 0160069336, 0160069359, 0160069441 & 0160075696	1001199518		•	
		0160075683 - Present, excl 0160075696	1001211875		•	

NOTES:
 • Use only JLG approved attachments with proper material handler model/attachment load capacity charts displayed in the operator's cab.
 • Never use your attachment as a work platform or personnel carrier.
 Can't find the attachment you are looking for? Contact your JLG Aftermarket Parts representative at 1-877-JLG-LIFT or visit www.jlg.com.

Non-Current Production - Coupler Mounted Lifting Hook, JLG
Available Through JLG Aftermarket Parts

CAPACITY			15,000 lbs.
APPROX. WEIGHT			178 lbs.
PART NO.			1001207606
MODEL	SN BREAKS	LOAD CHART BOOKLET	
JLG	642	ALL	1001212421
	G6-42A	0160037722-0160040659	1001110401
		0160040678 - Present	1001130739
	G9-43A	0160037671 - 0160040674, excl 0160040468 & 0160040672	1001110402
		0160040675 - Present, incl 0160040468 & 0160040672	1001130708
	G10-43A	0160037671 - 0160040674, excl 0160040468 & 0160040672	1001115257
		0160040675 - Present, incl 0160040468 & 0160040672	1001130844
	G10-55A	0160037690 - Present, incl 0160038505, 0160038507, 0160038324, 0160038489 & 0160038493	1001115138
	G12-55A	0160037689 - Present	1001115540
	G15-44A	Prior To 0160074142	1001194130
0160074142 - Present		1001211953	

Fork Mounted Lifting Hook

The fork mounted lifting hook provides the operator with the ability to lift and lower suspended loads without removing the carriage.

Features

- Not for use with cubing or block forks
- Maximum fork size: 2.36 in. x 7.09 in.
- Use standard load chart for all fork mounted lifting hooks.
- Fork drop must be at least 3.75" below bottom of carriage to lock pin.



Current Production - Fork Mounted Lifting Hook
Available Through JLG Aftermarket Or With New Machine Orders

LIFTING CAPACITY		5,500 lbs.	12,000 lbs.	15,000 lbs.
PART NO.		1001242510	1001097205	1001193803
MODEL	SN BREAKS			
JLG	742	ALL		
	943/1043	Without Outriggers		
		With Outriggers		
	1055	Prior To 0160074169		
		0160074169 - Present		
	1255	Prior To 0160074168		
		0160074168 - Present		
	1644	ALL		
1732	ALL			
G5-18-A	Universal (skid steer) quick coupler; 0160040809-Present			
SKYTRAK™	6036	0160069720 - 0160075649, incl 0160065792, 0160065798, 0160065824, 0160069383, 0160069411, 0160075653 & 0160075722		
		0160075650 - Present, excl 0160075653 & 0160075722		
	6042	0160069720 - 0160075656, incl 0160065792, 0160065798, 0160065824, 0160069383 & 0160069411		
		0160075657 - Present		
	8042	0160069722 - 0160075670, incl 0160065791, 0160065796, 0160065825, 0160065826, 0160069336, 0160069359 & 0160069441		
		0160075671 - Present		
10042	0160069722 - 0160075987, incl 0160065791, 0160065796, 0160065825, 0160065826, 0160069336, 0160069359 & 0160069441			
	0160075988 - Present			
10054	0160069722 - 0160075682, incl 0160065791, 0160065796, 0160065825, 0160065826, 0160069336, 0160069359, 0160069441 & 0160075696			
	0160075683 - Present, excl 0160075696			

Use Appropriate Carriage Attachment Load Chart

NOTES:

- Use only JLG approved attachments with proper material handler model/attachment load capacity charts displayed in the operator's cab.
 - Never use your attachment as a work platform or personnel carrier.
- Can't find the attachment you are looking for? Contact your JLG Aftermarket Parts representative at 1-877-JLG-LIFT or visit www.jlg.com.

NOTES:

- Use only JLG approved attachments with proper material handler model/attachment load capacity charts displayed in the operator's cab.
 - Never use your attachment as a work platform or personnel carrier.
- Can't find the attachment you are looking for? Contact your JLG Aftermarket Parts representative at 1-877-JLG-LIFT or visit www.jlg.com.

Non-Current Production - Fork Mounted Lifting Hook, JLG
Available Through JLG Aftermarket Parts

LIFTING CAPACITY		8,800 lbs.	12,000 lbs.	15,000 lbs.	
PART NO.		2700118	1001097205	1001193803	
MODEL	SN BREAKS				
JLG	642	ALL		•	
	619A	ALL	•	•	
	723A	ALL	•	•	
	G5-19A	ALL	•		
	G6-23A	ALL	•		
	G6-42A	0160037722 - 0160040659		•	
		0160040678 - Present		•	
	G9-43A	0160037671 - 0160040674, excl 0160040468 & 0160040672		•	
		0160040675 - Present, incl 0160040468 & 0160040672		•	
	G10-43A	0160037671 - 0160040674, excl 0160040468 & 0160040672		•	
		0160040675 - Present, incl 0160040468 & 0160040672		•	
	G10-55A	0160037690 - 0160038486, incl 0160038505 & 0160038507, excl 0160038324, 0160038489 & 0160038493		•	
		0160038500 - Present, incl 0160038324, 0160038489 & 0160038493, excl 0160038505 & 0160038507		•	
	G12-55A	0160037689-0160038533		•	
		0160038538 - Present		•	
G15-44A	Prior To 0160074142			•	
	0160074142 - Present			•	

Non-Current Production - Fork Mounted Lifting Hook, Gradall
Available Through JLG Aftermarket Parts

LIFTING CAPACITY		12,000 lbs.	
PART NO.		1001097205	
MODEL	SN BREAKS		
GRADALL	522D/524D	ALL	•
	534C-9	ALL	•
	534C-10	ALL	•
	534D-6	ALL	•
	534D-9	0160037689 - Present	•
	534D-10	0160037689 - Present	•
	544C	ALL	•
	544D	0160037689 - Present	•
	G6-42P	0160037689 - Present	•

Use Appropriate Carriage Attachment Load Chart

NOTES:
 • Use only JLG approved attachments with proper material handler model/attachment load capacity charts displayed in the operator's cab.
 • Never use your attachment as a work platform or personnel carrier.
 Can't find the attachment you are looking for? Contact your JLG Aftermarket Parts representative at 1-877-JLG-LIFT or visit www.jlg.com.

Non-Current Production - Fork Mounted Lifting Hook, SkyTrak
Available Through JLG Aftermarket Parts

LIFTING CAPACITY		12,000 lbs.	
PART NO.		1001097205	
MODEL	SN BREAKS		
SKYTRAK	4266	ALL	•
	4270	ALL	•
	4290	ALL	•
	5028	ALL	•
	6036	0160031200 - 0160069719, excl 0160065792, 0160065798, 0160065824, 0160069383 & 0160069411	•
	6042	0160031200 - 0160069719, excl 0160065792, 0160065798, 0160065824, 0160069383 & 0160069411	•
	8042	0160031235 - 0160069721, excl 0160065791, 0160065796, 0160065825, 0160065826, 0160069336, 0160069359 & 0160069441	•
	10042	0160031425 - 0160069721, excl 0160065791, 0160065796, 0160065825, 0160065826, 0160069336, 0160069359 & 0160069441	•
	10054	0160031255 - 0160069721, excl 0160065791, 0160065796, 0160065825, 0160065826, 0160069336, 0160069359 & 0160069441	•

Non-Current Production - Fork Mounted Lifting Hook, Lull
Available Through JLG Aftermarket Parts

LIFTING CAPACITY		12,000 lbs.	
PART NO.		1001097205	
MODEL	SN BREAKS		
LULL	644B-37	ALL	•
	644B-42	ALL	•
	644D-34	ALL	•
	644E-42	0160037900 - Present	•
	844C-42	ALL	•
	944E-42	0160037794 - Present, incl 0160045421	•
	1044C-42	ALL	•
	1044C-54	ALL	•
	1044C-54 SII	Prior To 0160037793	•
	1044C-54 SII	0160037794 - Present	•

Use Appropriate Carriage Attachment Load Chart

NOTES:
 • Use only JLG approved attachments with proper material handler model/attachment load capacity charts displayed in the operator's cab.
 • Never use your attachment as a work platform or personnel carrier.
 Can't find the attachment you are looking for? Contact your JLG Aftermarket Parts representative at 1-877-JLG-LIFT or visit www.jlg.com.

Fork Mounted Work Platform

Simply slide the forks into the work platform pockets, secure the locking pins and begin lifting people to working heights. The only ANSI approved fork mounted platform for JLG telehandlers.

Features

- Only for use with 48 in. pallet forks
- 4 ft. x 8 ft. platform
- Side entry with removable front rail
- 1000 lbs. capacity
- 3 lanyard attach points
- Fork pocket dimensions: 2.5 in. x 5.5 in. x 48 in.
- Fork drop must be 3.75" below carriage to be able to lock pin.



Current Production - Fork Mounted Work Platform Available Through JLG Aftermarket Or With New Machine Orders

LENGTH		48 in.
CAPACITY		1000 lbs.
VERSION		English
PART NO.		10011036375
MODEL	SN BREAKS	
JLG	742	Without Outriggers
	943/1043	Without Outriggers
		With Outriggers
	1055	Prior To 0160074169
		0160074169 - Present
1255	Prior To 0160074168	
	0160074168 - Present	
SKYTRAK™	6036	0160069720 - 0160075649, incl 0160065792, 0160065798, 0160065824, 0160069383, 0160069411, 0160075653 & 0160075722
		0160075650 - Present, excl 0160075653 & 0160075722
	6042	0160069720 - 0160075656, incl 0160065792, 0160065798, 0160065824, 0160069383 & 0160069411
		0160075657 - Present
	8042	0160069722 - 0160075670, incl 0160065791, 0160065796, 0160065825, 0160065826, 0160069336, 0160069359 & 0160069441
		0160075671 - Present
	10042	0160069722 - 0160075987, incl 0160065791, 0160065796, 0160065825, 0160065826, 0160069336, 0160069359 & 0160069441
		0160075988 - Present
	10054	0160069722 - 0160075682, incl 0160065791, 0160065796, 0160065825, 0160065826, 0160069336, 0160069359, 0160069441 & 0160075696
		0160075683 - Present, excl 0160075696

Use Appropriate Carriage Attachment Load Chart

NOTES:
 • Use only JLG approved attachments with proper material handler model/attachment load capacity charts displayed in the operator's cab.
 Can't find the attachment you are looking for? Contact your JLG Aftermarket Parts representative at 1-877-JLG-LIFT or visit www.jlg.com.

Non-Current Production - Fork Mounted Work Platform, JLG Available Through JLG Aftermarket Parts

LENGTH		48 in.
CAPACITY		1000 lbs.
VERSION		English
PART NO.		10011036375
MODEL	SN BREAKS	
JLG	642	ALL
	619A	ALL
	723A	ALL
	G5-19A	ALL
	G6-23A	ALL
	G6-42A	0160037722 - 0160040659
		0160040678 - Present
	G9-43A	0160037671 - 0160040674, excl 0160040468 & 0160040672
		0160040675 - Present, incl 0160040468 & 0160040672
	G10-43A	0160037671 - 0160040674, excl 0160040468 & 0160040672
		0160040675 - Present, incl 0160040468 & 0160040672
	G10-55A	0160037690 - 0160038486, incl 0160038505 & 0160038507, excl 0160038324, 0160038489 & 0160038493
		0160038500 - Present, incl 0160038324, 0160038489 & 0160038493, excl 0160038505 & 0160038507
	G12-55A	0160037689 - 0160038533
		0160038538 - Present
G15-44A	Prior To 0160074142	
	0160074142 - Present	
TF6-42	ALL	

Non-Current Production - Fork Mounted Work Platform, Gradall Available Through JLG Aftermarket Parts

LENGTH		48 in.
CAPACITY		1000 lbs.
VERSION		English
PART NO.		10011036375
MODEL	SN BREAKS	
GRADALL	522/524D	ALL
	534C9	ALL
	534C10	ALL
	534D6	ALL
	534D-9	Prior To 0160037689
		0160037689 - Present
	534D-10	Prior To 0160037689
		0160037689 - Present
	534D10-45	ALL
	544C	ALL
	544D	Prior To 0160037689
		0160037689 - Present
	544D10-55	ALL
	G6-42P	Prior To 0160037689

Use Appropriate Carriage Attachment Load Chart

NOTES:
 • Use only JLG approved attachments with proper material handler model/attachment load capacity charts displayed in the operator's cab.
 Can't find the attachment you are looking for? Contact your JLG Aftermarket Parts representative at 1-877-JLG-LIFT or visit www.jlg.com.

Non-Current Production - Fork Mounted Work Platform, SkyTrak
Available Through JLG Aftermarket Parts

LENGTH		48 in.
CAPACITY		1000 lbs.
VERSION		English
PART NO.		1001103637S
MODEL	SN BREAKS	
4266	ALL	•
4270	ALL	•
4290	ALL	•
5028	ALL	•
6036	0160031200 - 0160069719, excl 0160065792, 0160065798, 0160065824, 0160069383 & 0160069411	•
6042	0160031200 - 0160069719, excl 0160065792, 0160065798, 0160065824, 0160069383 & 0160069411	•
8042	0160031235 - 0160069721, excl 0160065791, 0160065796, 0160065825, 0160065826, 0160069336, 0160069359 & 0160069441	•
10042	0160031425 - 0160069721, excl 0160065791, 0160065796, 0160065825, 0160065826, 0160069336, 0160069359 & 0160069441	•
10054	0160031255 - 0160069721, excl 0160065791, 0160065796, 0160065825, 0160065826, 0160069336, 0160069359 & 0160069441	•

Non-Current Production - Fork Mounted Work Platform, Lull
Available Through JLG Aftermarket Parts

LENGTH		48 in.
CAPACITY		1000 lbs.
VERSION		English
PART NO.		1001103637S
MODEL	SN BREAKS	
644B-37	ALL	•
644B-42	ALL	•
644D-34	ALL	•
644E-42	0160037900 - Present	•
844C-42	ALL	•
944E-42	0160037794 - Present, incl 0160045421	•
1044C-42	ALL	•
1044C-54	0160037893 - Present	•
1044C-54 SII	0160037794 - Present	•

Use Appropriate Carriage Attachment Load Chart

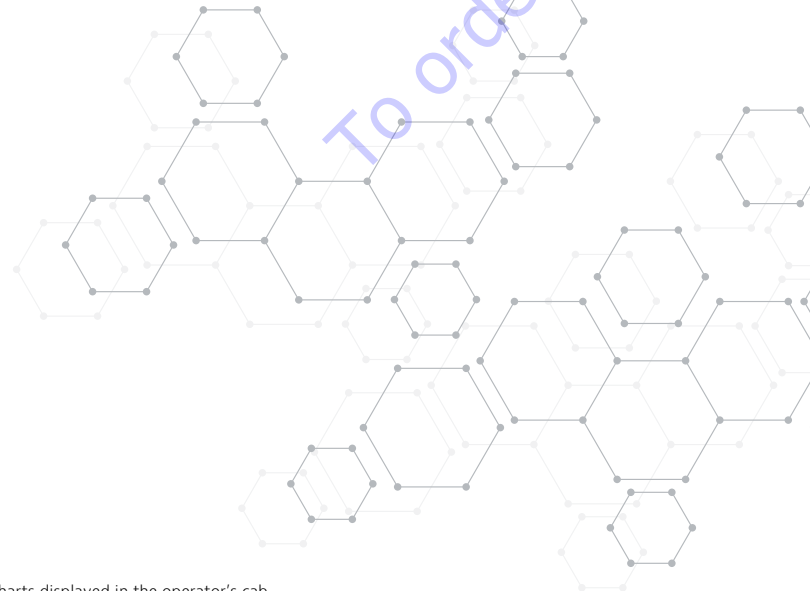

Fork Mounted Extendable Truss Boom

The Fork-Mounted Extendable Truss attachment is ideal for metal building erection, setting wooden trusses, putting up post frame building and many more "low rise" applications. This attachment is designed to mount on most existing forks, and is extendable, allowing for convenient lifting and placing of objects around the worksite.

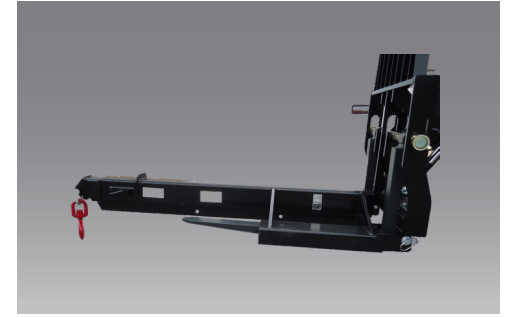

Features

- Designed to accommodate a maximum fork size of 2.36 x 7 x 72 in
- Fits JLG and SkyTrak Models
- Fork Mounted Extendable Truss Load Chart advising length and capacity restrictions depicted below

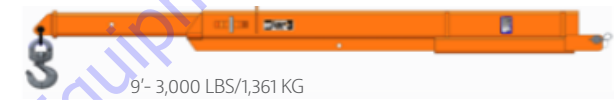
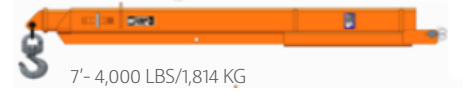
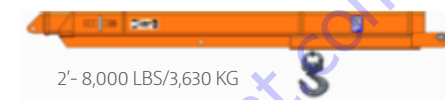

Current Production - Truss Boom
Available Through JLG Aftermarket Or With New Machine Orders

LENGTH		Adjustable
WINCH		NO
CAPACITY		8,000 lbs.
PART NO.		1001230241
MODEL	SN BREAKS	LOAD CHART BOOKLET
JLG	742	ALL
	943/1043	Without Outriggers
		With Outriggers
	1055	Prior To 0160074169
		0160074169 - Present
	1255	Prior To 0160074168
0160074168 - Present		
SKYTRAK T4E	6036	0160069720 - 0160075649, incl 0160065792, 0160065798, 0160065824, 0160069383, 0160069411, 0160075653 & 0160075722
		0160075650 - Present, excl 0160075653 & 0160075722
	6042	0160069720 - 0160075656, incl 0160065792, 0160065798, 0160065824, 0160069383 & 0160069411
		0160075657 - Present
	8042	0160069722 - 0160075670, incl 0160065791, 0160065796, 0160065825, 0160065826, 0160069336, 0160069359 & 0160069441
		0160075671 - Present
	10042	0160069722 - 0160075987, incl 0160065791, 0160065796, 0160065825, 0160065826, 0160069336, 0160069359 & 0160069441
		0160075988 - Present
	10054	0160069722 - 0160075682, incl 0160065791, 0160065796, 0160065825, 0160065826, 0160069336, 0160069359, 0160069441 & 0160075696
		0160075683 - Present, excl 0160075696

NOTES:
• Use only JLG approved attachments with proper material handler model/attachment load capacity charts displayed in the operator's cab.
Can't find the attachment you are looking for? Contact your JLG Aftermarket Parts representative at 1-877-JLG-LIFT or visit www.jlg.com.

Material Handling Arm

Optimize the use of your telehandler with the JLG material handling arm. The three-way adjustable arm allows your machine more movement and versatility, adding to jobsite productivity and efficiency.

The material handling arm is excellent for various industries, including: construction, civil engineering applications, contractors and the rental industry.

Features

- Telescoping capabilities in three locked positions.
- Multiple lift points allow the material handling arm to handle different load lengths and weights
 - Fully extended: 2000 lbs lift capacity
 - Mid-boom extension: 3000 lbs lift capacity
 - Fully retracted: 4000 lbs lift capacity
- Arm extends and retracts manually for reliable operation.

Specifications

- Distance to center of gravity: 3.7 inches



Current Production - Material Handling Arm Available Through JLG Aftermarket Or With New Machine Orders

CAPACITY			2000 - 4000 lbs.	
WEIGHT			952 lbs.	
PART NO.			1001176515	
MODEL	SN BREAKS	LOAD CHART BOOKLET		
JLG	642, 943, 1043, 1055, 1255 ONLY	Software, Chart Library	1001187087 (Ref No.)	
	742	ALL	1001226012	
	943/1043	Without Outriggers	1001212420	
		With Outriggers	1001212419	
	1055	Prior To 0160074169	1001212227	
		0160074169 - Present	1001211156	
	1255	Prior To 0160074168	1001212225	
		0160074168 - Present	1001211153	
	SKYTRAK™	6036	0160069720 - 0160075649, incl 0160065792, 0160065798, 0160065824, 0160069383, 0160069411, 0160075653 & 0160075722	1001199500
			0160075650 - Present, excl 0160075653 & 0160075722	1001211867
6042		0160069720 - 0160075656, incl 0160065792, 0160065798, 0160065824, 0160069383 & 0160069411	1001199504	
		0160075657 - Present	1001211869	
8042		0160069722 - 0160075670, incl 0160065791, 0160065796, 0160065825, 0160065826, 0160069336, 0160069359 & 0160069441	1001199508	
		0160075671 - Present	1001211871	
10042		0160069722 - 0160075987, incl 0160065791, 0160065796, 0160065825, 0160065826, 0160069336, 0160069359 & 0160069441	1001199512	
		0160075988 - Present	1001211873	
10054		0160069722 - 0160075682, incl 0160065791, 0160065796, 0160065825, 0160065826, 0160069336, 0160069359, 0160069441 & 0160075696	1001199518	
		0160075683 - Present, excl 0160075696	1001211875	

NOTES:
 • Use only JLG approved attachments with proper material handler model/attachment load capacity charts displayed in the operator's cab.
 • Never use your attachment as a work platform or personnel carrier.
 Can't find the attachment you are looking for? Contact your JLG Aftermarket Parts representative at 1-877-JLG-LIFT or visit www.jlg.com.

Non-Current Production - Material Handling Arm, JLG Available Through JLG Aftermarket Parts

CAPACITY			2000 - 4000 lbs.
WEIGHT			952 lbs.
JLG PART NO.			1001176515
MODEL	SN BREAKS	LOAD CHART BOOKLET	
JLG	642	ALL	1001212421
	G6-42A	0160037722 - 0160040659	1001104401
		0160040678 - Present	1001130739
	G9-43A	0160037671 - 0160040674, excl 0160040468 & 0160040672	1001104402
		0160040675 - Present, incl 0160040468 & 0160040672	1001130708
	G10-43A	0160037671 - 0160040674, excl 0160040468 & 0160040672	100115257
		0160040675 - Present, incl 0160040468 & 0160040672	1001130844
	G10-55A	0160037690 - Present, incl 0160038505, 0160038507, 0160038324, 0160038489 & 0160038493	100115138
	G12-55A	0160037689 - Present	100115540

Non-Current Production - Material Handling Arm, SkyTrak Available Through JLG Aftermarket Parts

CAPACITY			2000 - 4000 lbs.
WEIGHT			952 lbs.
JLG PART NO.			1001176515
MODEL	SN BREAKS	LOAD CHART BOOKLET	
SKYTRAK™	6036	0160031200 - 0160069719, excl 0160065792, 0160065798, 0160065824, 0160069383 & 0160069411	1001199500
	6042	0160031200 - 0160069719, excl 0160065792, 0160065798, 0160065824, 0160069383 & 0160069411	1001199504
	8042	0160031235 - 0160069721, excl 0160065791, 0160065796, 0160065825, 0160065826, 0160069336, 0160069359 & 0160069441	1001199508
	10042	0160031425 - 0160069721, excl 0160065791, 0160065796, 0160065825, 0160065826, 0160069336, 0160069359 & 0160069441	1001199512
	10054	0160031255 - 0160069721, excl 0160065791, 0160065796, 0160065825, 0160065826, 0160069336, 0160069359 & 0160069441	1001199518

NOTES:
 • Use only JLG approved attachments with proper material handler model/attachment load capacity charts displayed in the operator's cab.
 • Never use your attachment as a work platform or personnel carrier.
 Can't find the attachment you are looking for? Contact your JLG Aftermarket Parts representative at 1-877-JLG-LIFT or visit www.jlg.com.

Pipe Grapple

Optimize the use of your Telehandler with the JLG Pipe Grapple. The Pipe Grapple handles various pipe diameters and configurations. The arms fold down on the pipe/poles to secure and prevent the load from rolling off or tipping sideways. The arm design offers the most versatility for handling various diameters and lengths. When idle, the arm assembly pivots to the full vertical position so the truck can be utilized for typical loads.

Features

- Can handle long pipe or pole material efficiently
- Help to stabilize a load of long pipes or poles
- Specially designed clamping arms mounted on top of carriage

Specifications

- 72" carriage
- 48" Forks (ITA - hook mounted)
- 2" - 30" pipe diameter



Current Production - Pipe Grapple
Available Through JLG Aftermarket Or With New Machine Orders

CARRIAGE SIZE		72 in.	72 in.	72 in.	96 in.
CAPACITY		2000 lbs.	3000 lbs.	6000 lbs.	8,000 lbs.
APPROX. WEIGHT		1701 lbs.	1701 lbs.	1701 lbs.	2,060 lbs.
PART NO.		1001142247	1001142247	1001142247	1001192722
MODEL	SN BREAKS	LOAD CHART BOOKLET			
JLG	1055, 1255 ONLY	Software, Chart Library			
	1055	Prior To 0160074169	1001212227		•
		0160074169 - Present	1001211156		•
	1255	Prior To 0160074168	1001212225		•
		0160074168 - Present	1001211153		•
	1644	ALL	1001233430		•
1732	ALL	1001233431		•	
SKYTRAK T4F	10042	0160069722 - 0160075987, incl 0160065791, 0160065796, 0160065825, 0160065826, 0160069336, 0160069359 & 0160069441	1001199512	•	•
		0160075988 - Present	1001211873	•	•
	10054	0160069722 - 0160075682, incl 0160065791, 0160065796, 0160065825, 0160065826, 0160069336, 0160069359, 0160069441 & 0160075696	1001199518	•	•
		0160075683 - Present, excl 0160075696	1001211875	•	•

Non-Current Production - Pipe Grapple, JLG
Available Through JLG Aftermarket Parts

CARRIAGE SIZE		72 in.	
CAPACITY		3000 lbs.	
APPROX. WEIGHT		1701 lbs.	
PART NO.		1001142247	
MODEL	SN BREAKS	LOAD CHART BOOKLET	
JLG	G10-55A	0160037690 - Present, incl 0160038505, 0160038507, 0160038324, 0160038489 & 0160038493	
	G12-55A	0160037689 - Present	
	G15-44A	Prior To 0160074142	1001194130
		0160074142 - Present	1001211953

NOTES:
 • Use only JLG approved attachments with proper material handler model/attachment load capacity charts displayed in the operator's cab.
 • Never use your attachment as a work platform or personnel carrier.
 Can't find the attachment you are looking for? Contact your JLG Aftermarket Parts representative at 1-877-JLG-LIFT or visit www.jlg.com.

Round Fork Tines

The round fork tines allow for stability of the hay bale while maneuvering around objects.

Features

- Work range of 4 ft.

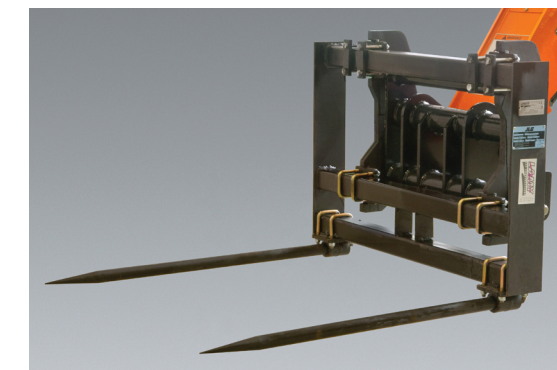

Non-Current Production - Round Fork Tines, JLG
Available Through JLG Aftermarket Parts

PART NO.		2340035	
MODEL	SN BREAKS	LOAD CHART BOOKLET	
JLG	619A	ALL	Consult Factory
	723A	ALL	Consult Factory



NOTES:
 • Use only JLG approved attachments with proper material handler model/attachment load capacity charts displayed in the operator's cab.
 • Never use your attachment as a work platform or personnel carrier.
 Can't find the attachment you are looking for? Contact your JLG Aftermarket Parts representative at 1-877-JLG-LIFT or visit www.jlg.com.

Sheet Material Adapters

The sheet material adapter is ideal for carrying large, flat materials such as drywall, steel plates or plywood, limiting damage during transport.

Features

- May be used with standard, side-tilt or swing carriage
- May be used with pallet or lumber forks
- Includes swing function: 45 degrees right or left
- 72 in. carriage required

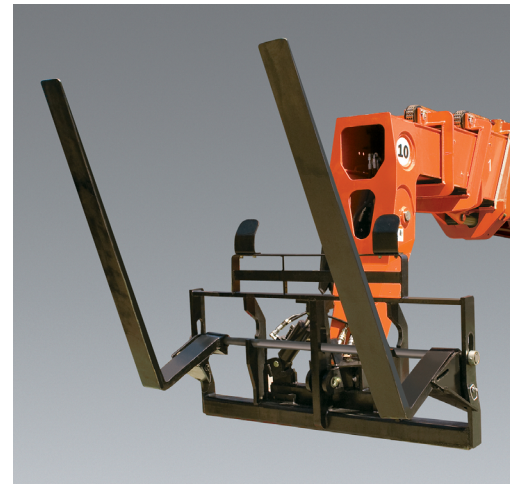

Current Production - Sheet Material Adapters

Available Through JLG Aftermarket Or With New Machine Orders

PART NO.			10011002275*
MODEL	SN BREAKS	LOAD CHART BOOKLET	
6036	0160069720 - 0160075649, incl 0160065792, 0160065798, 0160065824, 0160069383, 0160069411, 0160075653 & 0160075722	1001199500	•
	0160075650 - Present, excl 0160075653 & 0160075722	1001211867	•
6042	0160069720 - 0160075656, incl 0160065792, 0160065798, 0160065824, 0160069383 & 0160069411	1001199504	•
	0160075657 - Present	1001211869	•
8042	0160069722 - 0160075670, incl 0160065791, 0160065796, 0160065825, 0160065826, 0160069336, 0160069359 & 0160069441	1001199508	•
	0160075671 - Present	1001211871	•
10042	0160069722 - 0160075987, incl 0160065791, 0160065796, 0160065825, 0160065826, 0160069336, 0160069359 & 0160069441	1001199512	•
	0160075988 - Present	1001211873	•
10054	0160069722 - 0160075682, incl 0160065791, 0160065796, 0160065825, 0160065826, 0160069336, 0160069359, 0160069441 & 0160075696	1001199518	•
	0160075683 - Present, excl 0160075696	1001211875	•

*PN 10011002275 is just the adapter - no carriage included

Non-Current Production - Sheet Material Carriage and Adapters, JLG

Available Through JLG Aftermarket Parts

CARRIAGE SIZE		72 in.	72 in.	72 in.	N/A
CARRIAGE TYPE		Swing	Swing	Standard	N/A
PART NO.		71293005	91405078	91405077	10011002275*
MODEL	SN BREAKS	LOAD CHART BOOKLET			
JLG* G6-42A	Prior To 0160037722	1001105323	•	•	
	0160037722 - 0160040659	1001106001	•		•
	0160040678 - Present	1001130793	•		•
G9-43A	Prior To 0160037671	1001105325	•	•	
	0160037671 - 0160040674, excl 0160040468 & 0160040672	1001106002	•		•
	0160040675 - Present, incl 0160040468 & 0160040672	1001130663	•		•

*PN 10011002275 is just the adapter - no carriage included

Continues on next page

*Swing material handler carriage on JLG and Gradall models requires auxillary hydraulics

NOTES:
 • Use only JLG approved attachments with proper material handler model/attachment load capacity charts displayed in the operator's cab.
 • Never use your attachment as a work platform or personnel carrier.
 Can't find the attachment you are looking for? Contact your JLG Aftermarket Parts representative at 1-877-JLG-LIFT or visit www.jlg.com.

Non-Current Production - Sheet Material Carriage and Adapters, JLG

Available Through JLG Aftermarket Parts

Continued from previous page

CARRIAGE SIZE		72 in.	72 in.	72 in.	N/A
CARRIAGE TYPE		Swing	Swing	Standard	N/A
PART NO.		71293005	91405078	91405077	10011002275*
MODEL	SN BREAKS	LOAD CHART BOOKLET			
G10-43A	0160037671 - 0160040674, excl 0160040468 & 0160040672	100113013	•		•
	0160040675 - Present, incl 0160040468 & 0160040672	1001130935	•		•
G10-55A	Prior To 0160037689	1001105707		•	•
	0160037690 - 0160038486, incl 0160038505 & 0160038507, excl 0160038324, 0160038489 & 0160038493	1001106003	•		•
	0160038500 - Present, incl 0160038324, 0160038489 & 0160038493, excl 0160038505 & 0160038507	100115135	•		•
G12-55A	Prior To 0160037689	1001105326		•	•
	0160037689 - 0160038533	1001106004	•		•
	0160038538 & Present	100115536	•		•
TF6-42	ALL	Consult Factory		•	•

*PN 10011002275 is just the adapter - no carriage included

Non-Current Production - Sheet Material Carriage and Adapters, Gradall

Available Through JLG Aftermarket Parts

CARRIAGE SIZE		72 in.	72 in.	72 in.	N/A
CARRIAGE TYPE		Swing	Swing	Standard	N/A
PART NO.		90555013	91405078	91405077	10011002275*
MODEL	SN BREAKS	LOAD CHART BOOKLET			
534D-9	Prior To 0160037689	1001102719	•		
	0160037689 - Present	100112753			•
534D-10	Prior To 0160037689	1001102720	•		
	0160037689 - Present	100112753			•
544D	Prior To 0160037689	1001102721	•		
	0160037689 - Present	1001106008			•
G6-42P	Prior To 0160037689	1001105324		•	•
	0160037689 - Present	1001106005			•

*Swing material handler carriage on JLG and Gradall models requires auxillary hydraulics

NOTES:
 • Use only JLG approved attachments with proper material handler model/attachment load capacity charts displayed in the operator's cab.
 • Never use your attachment as a work platform or personnel carrier.
 Can't find the attachment you are looking for? Contact your JLG Aftermarket Parts representative at 1-877-JLG-LIFT or visit www.jlg.com.



Non-Current Production - Sheet Material Carriage and Adapters, SkyTrak
Available Through JLG Aftermarket Parts

CARRIAGE SIZE			N/A	72 in.
CARRIAGE TYPE			N/A	Swing
PART NO.			10011002275*	71293005
MODEL	SN BREAKS	LOAD CHART BOOKLET		
SKYTRAK	4266	ALL	Consult Factory	•
	4270	ALL	Consult Factory	•
	4290	ALL	Consult Factory	•
	5028	ALL	Consult Factory	•
	6036	Prior To 0160031200	Consult Factory	•
		0160031200 - 0160069719, excl 0160065792, 0160065798, 0160065824, 0160069383 & 0160069411	1001199500	•
	6042	Prior To 0160031200	Consult Factory	•
		0160031200 - 0160069719, excl 0160065792, 0160065798, 0160065824, 0160069383 & 0160069411	1001199504	•
	8042	Prior To 0160031235	Consult Factory	•
		0160031235 - 0160069721, excl 0160065791, 0160065796, 0160065825, 0160065826, 0160069336, 0160069359 & 0160069441	1001199508	•
	10042	Prior To 0160031425	Consult Factory	•
		0160031425 - 0160069721, excl 0160065791, 0160065796, 0160065825, 0160065826, 0160069336, 0160069359 & 0160069441	1001199512	•
	10054	Prior To 0160031255	Consult Factory	•
0160031255 - 0160069721, excl 0160065791, 0160065796, 0160065825, 0160065826, 0160069336, 0160069359 & 0160069441		1001199518	•	

*PN 10011002275 is just the adapter - no carriage included

Non-Current Production - Sheet Material Carriage and Adapters, Lull
Available Through JLG Aftermarket Parts

CARRIAGE SIZE			72 in.	N/A
CARRIAGE TYPE			Swing	N/A
PART NO.			71293005	10011002275*
MODEL	SN BREAKS	LOAD CHART BOOKLET		
LULL	644E-42	Prior To 0160031500	7300628	•
		0160037794 - Present, incl 0160045421	1001134329	•
	944E-42	Prior To 0160031500	7301586	•
		0160037794 - Present	1001106011	•
1044C-54SII	0160037900 - Present	1001106009	•	

*PN 10011002275 is just the adapter - no carriage included

Sweeper

Our heavy duty sweeper is durable enough to perform under the most challenging conditions and is capable of handling all types of materials, including fine dirt, gravel, millings and other debris.

Features

- Increased bucket capacity by 22% with less carry over
- Increase efficiency by dumping less frequently with a larger capacity bucket
- A simple tool-less adjustment knob allows you to accommodate brush wear and still maintain increased bucket capacity.
- Ideal for heavy duty cleanup, millings and snow removal
- High dump feature activated by reversing flow
- Hopper positioned in front
- Powered from loader hydraulics
- Designed and manufactured to construction grade
- Quick Attach mounts
- Industrial quality motor
- Broom rotates clockwise for maneuverability
- Hopper opens for dumping



Specifications

- Max Capacity: 1717 lbs.
- Max. Weight: 1490 lbs
- Width (overall): 105 in
- Length (w/o quick coupler): 72.25 in
- Max. Hydraulic Pressure: 3500 PSI
- Distance to Center of Gravity: 32 in.
- Brush Diameter: 26 in.
- Flow Range: 15-50 GPM
- Brush Width: 7ft.
- Sweeping Width: 84 in.
- Hopper Capacity: .53 yd³

Current Production - Sweeper
Available Through JLG Aftermarket Or With New Machine Orders

CAPACITY			1717 lbs.	
APPROX. WEIGHT			1490 lbs.	
PART NO.			1001202904	
MODEL	SN BREAKS	LOAD CHART BOOKLET		
JLG	642, 943, 1043, 1055, 1255 ONLY	Software, Chart Library	1001187087 (Ref No.)	
	742	ALL	1001226012	
	943/ 1043	No Outriggers	1001212420	
		With Outriggers	1001212419	
	1055	Prior To 0160074169	1001212227	
		0160074169 - Present	1001211156	
	1255	Prior To 0160074168	1001212225	
		0160074168 - Present	1001211153	
	SKYTRAK T4F	6036	0160069720 - 0160075649, incl 0160065792, 0160065798, 0160065824, 0160069383, 0160069411, 0160075653 & 0160075722	1001199500
			0160075650 - Present, excl 0160075653 & 0160075722	1001211867
6042		0160069720 - 0160075656, incl 0160065792, 0160065798, 0160065824, 0160069383 & 0160069411	1001199504	
		0160075657 - Present	1001211869	
8042		0160069722 - 0160075670, incl 0160065791, 0160065796, 0160065825, 0160065826, 0160069336, 0160069359 & 0160069441	1001199508	
		0160075671 - Present	1001211871	
10042		0160069722 - 0160075987, incl 0160065791, 0160065796, 0160065825, 0160065826, 0160069336, 0160069359 & 0160069441	1001199512	
		0160075988 - Present	1001211873	
10054		0160069722 - 0160075682, incl 0160065791, 0160065796, 0160065825, 0160065826, 0160069336, 0160069359, 0160069441 & 0160075696	1001199518	
		0160075683 - Present, excl 0160075696	1001211875	

Additional/Replacement Parts:
Dust cap that installs on female quick connect fitting is PN 8420055
Replacement polyester/wire sweeper brush is PN 70011926

NOTES:
• Use only JLG approved attachments with proper material handler model/attachment load capacity charts displayed in the operator's cab.
• Never use your attachment as a work platform or personnel carrier.
Can't find the attachment you are looking for? Contact your JLG Aftermarket Parts representative at 1-877-JLG-LIFT or visit www.jlg.com.

Non-Current Production - Sweeper, JLG
Available Through JLG Aftermarket Parts

CAPACITY		1717 lbs.		
APPROX. WEIGHT		1490 lbs.		
PART NO.		1001202904		
MODEL	SN BREAKS	LOAD CHART BOOKLET		
JLG	642	ALL	1001212421	•
	G6-42A	0160037722 - 0160040659	1001110401	•
		0160040678 - Present	1001130739	•
	G9-43A	0160037671 - 0160040674, excl 0160040468 & 0160040672	1001110402	•
		0160040675 - Present, incl 0160040468 & 0160040672	1001130708	•
	G10-43A	0160037671 - 0160040674, excl 0160040468 & 0160040672	1001115257	•
		0160040675 - Present, incl 0160040468 & 0160040672	1001130844	•
	G10-55A	0160037690 - Present, incl 0160038505, 0160038507, 0160038324, 0160038489 & 0160038493	1001115138	•
	G12-55A	0160037689 - Present	1001115540	•

Additional/Replacement Parts:
Dust cap that installs on female quick connect fitting is PN 8420055
Replacement polyester/wire sweeper brush is PN 70011926

Trash Hopper

The Trash Hopper can increase job site efficiency by reducing the time and personnel required to move trash and other debris to and from elevated sites. Once the bar under the hopper is placed on the trash bin and pressure is applied, the hopper can be tilted forward and the door will open to allow trash to fall out. To latch the door again, simply tilt the hopper back. The exclusive JLG design of the bar mechanism does not allow the door to open when no pressure has been applied.

Features

- Saves time from moving trash to and from elevated sites
- Allows operator to remain safely in the cab with the hands-off bar design
- Increases productivity as operator can quickly empty the hopper without leaving the seat

Specifications

- Maximum Capacity:
 - 72"
 - 1.9 cubic yard capacity
 - 2000 lbs. maximum weight capacity
- Maximum Weight: 864 lbs.
- Distance to center of gravity: 32.5 in.

Note: The fork pockets on this attachment will not allow use of forks larger than 5.5" wide and 60" long.

Current Production - Trash Hopper
Available Through JLG Aftermarket Or With New Machine Orders

CAPACITY		2000 lbs.			
APPROX. WEIGHT		864 lbs.			
PART NO.		1001195082			
MODEL	SN BREAKS	LOAD CHART BOOKLET			
JLG	642, 943, 1043, 1055, 1255 ONLY	Software, Chart Library	1001187087 (Ref No.)		
	742	Without Outriggers	1001226012	•	
	943/1043	Without Outriggers	1001212420	•	
		With Outriggers	1001212419	•	
	1055	Prior To 0160074169	1001212227	•	
		0160074169 - Present	1001211156	•	
	1255	Prior To 0160074168	1001212225	•	
		0160074168 - Present	1001211153	•	
	SKYTRAK™ T4F	6036	0160069720 - 0160075649, incl 0160065792, 0160065798, 0160065824, 0160069383, 0160069411, 0160075653 & 0160075722	1001199500	•
			0160075650 - Present, excl 0160075653 & 0160075722	1001211867	•
6042		0160069720 - 0160075656, incl 0160065792, 0160065798, 0160065824, 0160069383 & 0160069411	1001199504	•	
		0160075657 - Present	1001211869	•	
8042		0160069722 - 0160075670, incl 0160065791, 0160065796, 0160065825, 0160065826, 0160069336, 0160069359 & 0160069441	1001199508	•	
		0160075671 - Present	1001211871	•	
10042		0160069722 - 0160075987, incl 0160065791, 0160065796, 0160065825, 0160065826, 0160069336, 0160069359 & 0160069441	1001199512	•	
		0160075988 - Present	1001211873	•	
10054	0160069722 - 0160075682, incl 0160065791, 0160065796, 0160065825, 0160065826, 0160069336, 0160069359, 0160069441 & 0160075696	1001199518	•		
	0160075683 - Present, excl 0160075696	1001211875	•		

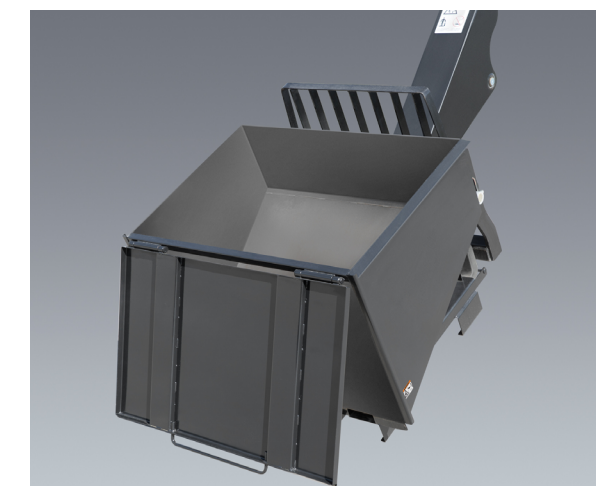

SEE IT IN ACTION!
Visit <https://goo.gl/FHyNbP> or on Online Express, click on Attachments/Trash Hopper and look for the link.

NOTES:
• Use only JLG approved attachments with proper material handler model/attachment load capacity charts displayed in the operator's cab.
• Never use your attachment as a work platform or personnel carrier.
Can't find the attachment you are looking for? Contact your JLG Aftermarket Parts representative at 1-877-JLG-LIFT or visit www.jlg.com.

NOTES:
• Use only JLG approved attachments with proper material handler model/attachment load capacity charts displayed in the operator's cab.
• Never use your attachment as a work platform or personnel carrier.
Can't find the attachment you are looking for? Contact your JLG Aftermarket Parts representative at 1-877-JLG-LIFT or visit www.jlg.com.

Non-Current Production - Trash Hoppe, JLG
Available Through JLG Aftermarket Parts

CAPACITY			2000 lbs.
APPROX. WEIGHT			864 lbs.
PART NO.			1001195082
MODEL	SN BREAKS	LOAD CHART BOOKLET	
642	ALL	1001212421	•
G6-42A	0160037722 - 0160040659	100110401	•
	0160040678 - Present	100130739	•
G9-43A	0160037671 - 0160040674, excl 0160040468 & 0160040672	100110402	•
	0160040675 - Present, incl 0160040468 & 0160040672	100130708	•
G10-43A	0160037671 - 0160040674, excl 0160040468 & 0160040672	1001115257	•
	0160040675 - Present, incl 0160040468 & 0160040672	100130844	•
G10-55A	0160037690 - Present, incl 0160038505, 0160038507, 0160038324, 0160038489 & 0160038493	1001115138	•
G12-55A	0160037689 - Present	1001115540	•

Truss Boom

When lifting and lowering roof trusses, framing walls or steel beams into place, use the truss boom; available with or without a winch.

Features

- Truss boom with winch feature requires auxiliary hydraulics



Current Production - Truss Boom
Available Through JLG Aftermarket Or With New Machine Orders

LENGTH			3 ft.	12 ft.	12 ft.	15 ft.	Adjustable
WINCH			Yes	No	Yes	No	NO
CAPACITY			4000 lbs.	2000 lbs.	2000 lbs.	2000 lbs.	16,755 lbs.
PART NO.			10011009675	10010999025	1001099351	10010999015	1001192723
MODEL	SN BREAKS	LOAD CHART BOOKLET					
JLG	642, 943, 1043, 1055, 1255 ONLY	Software, Chart Library	1001187087 (Ref No.)				
	742	ALL	1001226012	•	•	•	•
	943/1043	Without Outriggers	1001212420	•	•	•	•
		Without Outriggers	1001212419	•	•	•	•
	1055	Prior To 0160074169	1001212227	•	•	•	•
		0160074169 - Present	1001211156	•	•	•	•
	1255	Prior To 0160074168	1001212225	•	•	•	•
		0160074168 - Present	1001211153	•	•	•	•
	1644	ALL	1001233430				•
	1732	ALL	1001233431				•
SKYTRAK™	6036	0160069720 - 0160075649, incl 0160065792, 0160065798, 0160065824, 0160069383, 0160069411, 0160075653 & 0160075722	1001199500		•	•	•
		0160075650 - Present, excl 0160075653 & 0160075722	1001211867		•	•	•
	6042	0160069720 - 0160075656, incl 0160065792, 0160065798, 0160065824, 0160069383 & 0160069411	1001199504		•	•	•
		0160075657 - Present	1001211869		•	•	•
	8042	0160069722 - 0160075670, incl 0160065791, 0160065796, 0160065825, 0160065826, 0160069336, 0160069359 & 0160069441	1001199508		•	•	•
		0160075671 - Present	1001211871		•	•	•
	10042	0160069722 - 0160075987, incl 0160065791, 0160065796, 0160065825, 0160065826, 0160069336, 0160069359 & 0160069441	1001199512		•	•	•
		0160075988 - Present	1001211873		•	•	•
10054	0160069722 - 0160075682, incl 0160065791, 0160065796, 0160065825, 0160065826, 0160069336, 0160069359, 0160069441 & 0160075696	1001199518		•	•	•	
	0160075683 - Present, excl 0160075696	1001211875		•	•	•	

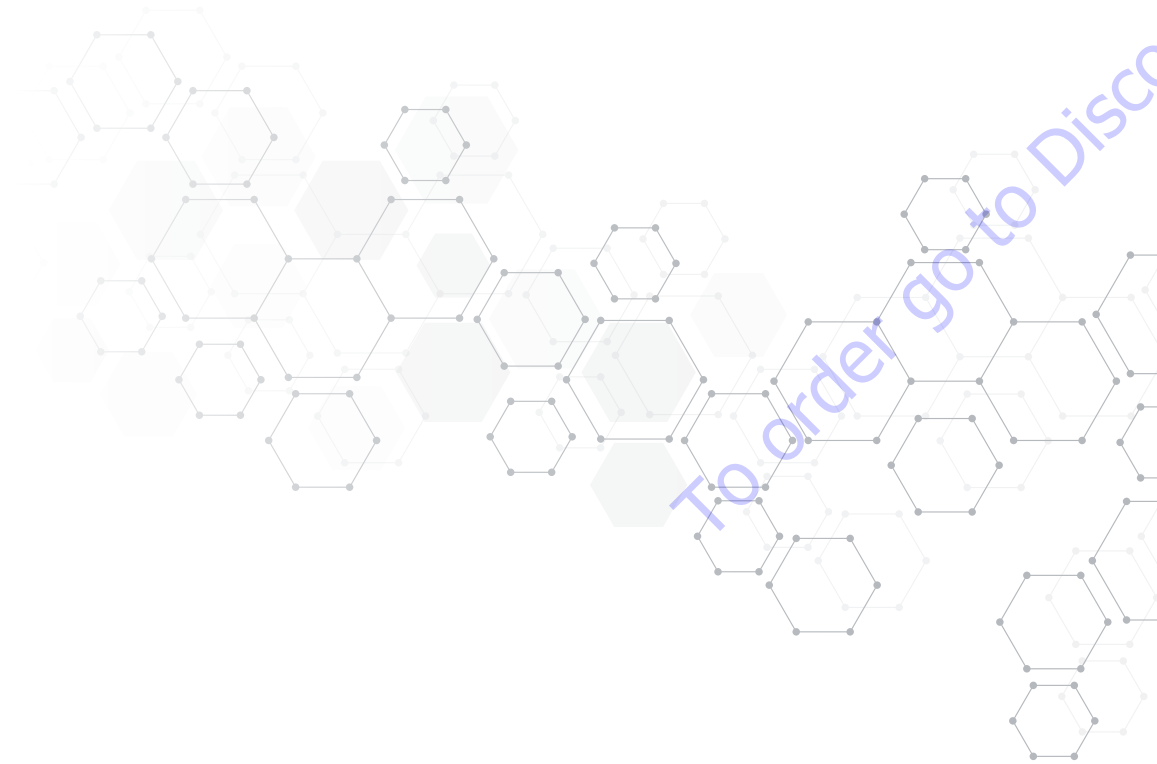

NOTES:

- Use only JLG approved attachments with proper material handler model/attachment load capacity charts displayed in the operator's cab.
 - Never use your attachment as a work platform or personnel carrier.
- Can't find the attachment you are looking for? Contact your JLG Aftermarket Parts representative at 1-877-JLG-LIFT or visit www.jlg.com.

NOTES:

- Use only JLG approved attachments with proper material handler model/attachment load capacity charts displayed in the operator's cab.
 - Never use your attachment as a work platform or personnel carrier.
- Can't find the attachment you are looking for? Contact your JLG Aftermarket Parts representative at 1-877-JLG-LIFT or visit www.jlg.com.

Non-Current Production - Truss Boom, JLG
Available Through JLG Aftermarket Parts

LENGTH			3 ft.	10 ft.	11.86 ft.	12 ft.	12 ft.	15 ft.	15 ft.	
WINCH			Yes	No	No	No	Yes	No	No	
CAPACITY			4000 lbs.	2000 lbs.	1433 lbs.	2000 lbs.	2000 lbs.	2000 lbs.	2000 lbs.	
PART NO.			10011009675	91405083	0240110	10010999025	1001099351	91405082	10010999015	
MODEL	SN BREAKS	LOAD CHART BOOKLET								
JLG	642	ALL	1001212421	•		•	•		•	
	619A	ALL	Consult Factory		•					
	723A	ALL	Consult Factory			•	•		•	
	G5-19A	ALL	Consult Factory			•				
	G6-23A	ALL	Consult Factory			•				
	G6-42A	Prior To 0160037722	1001105323		•				•	
		0160037722 - 0160040659	1001110401	•			•	•		•
		0160040678 - Present	1001130739	•			•	•		•
	G9-43A	Prior To 0160037671	1001105325		•				•	
		0160037671 - 0160040674, excl 0160040468 & 0160040672	1001110402	•			•	•		•
		0160040675 - Present, incl 0160040468 & 0160040672	1001130708	•			•	•		•
	G10-43A	Prior To 0160037671	1001130935		•				•	
		0160037671 - 0160040674, excl 0160040468 & 0160040672	1001115257	•			•	•		•
		0160040675 - Present, incl 0160040468 & 0160040672	1001130844	•			•	•		•
	G10-55A	Prior To 0160037689	1001105707		•				•	
		0160037690 - Present, incl 0160038505, 0160038507, 0160038324, 0160038489 & 0160038493	1001115138				•	•		•
	G12-55A	Prior To 0160037689	1001105326		•				•	
		0160037689 - Present	1001115540					•		
	G15-44A	Prior To 0160074142	1001194130				•	•		•
		0160074142 - Present	1001211953				•	•		•
TF6-42	ALL	Consult Factory		•				•		

Non-Current Production - Truss Boom, Gradall
Available Through JLG Aftermarket Parts

LENGTH			10 ft.	10 ft.	12 ft.	12 ft.	15 ft.	15 ft.
WINCH			No	No	No	Yes	No	No
CAPACITY			2000 lbs.	2000 lbs.	2000 lbs.	2000 lbs.	2000 lbs.	2000 lbs.
PART NO.			90455011	91405083	10010999025	1001099351	91405082	10010999015
MODEL	SN BREAKS	LOAD CHART BOOKLET						
GRADALL	522D/524D	ALL	Consult Factory	•				
	534C-10	ALL	Consult Factory	•				
	534D-6	ALL	Consult Factory	•				
	534D-9	Prior To 0160037689	1001102720	•				
		0160037689 - Present	1001110406		•	•		•
	534D-10	Prior To 0160037689	1001102721	•				
		0160037689 - Present	1001110407		•	•		•
	544C	ALL	Consult Factory	•				
	544D	Prior To 0160037689	1001102721	•				
		0160037689 - Present	1001110408		•	•		•
	G6-42P	Prior To 0160037689	1001105324		•			•
		0160037689 - Present	1001110405		•	•		•

NOTES:
 • Use only JLG approved attachments with proper material handler model/attachment load capacity charts displayed in the operator's cab.
 • Never use your attachment as a work platform or personnel carrier.
 Can't find the attachment you are looking for? Contact your JLG Aftermarket Parts representative at 1-877-JLG-LIFT or visit www.jlg.com.

Non-Current Production - Truss Boom, SkyTrak
Available Through JLG Aftermarket Parts

LENGTH			3 ft.	12 ft.	12 ft.	15 ft.	15 ft.
WINCH			Yes	No	Yes	No	No
CAPACITY			4000 lbs.	2000 lbs.	2000 lbs.	2000 lbs.	2000 lbs.
PART NO.			71396085	10010999025	1001099351	7119800	10010999015
MODEL	SN BREAKS	LOAD CHART BOOKLET					
SKYTRAK	4266	ALL	Consult Factory	•			
	4270	ALL	Consult Factory	•			
	4290	ALL	Consult Factory	•			
	5028	ALL	Consult Factory	•			
	6036	Prior To 0160031200	Consult Factory	•			
		0160031200 - 016009719, excl 0160065792, 0160065798, 0160065824, 0160069383 & 0160069411	1001199500		•	•	•
	6042	Prior To 0160031200	Consult Factory	•			
		0160031200 - 016009719, excl 0160065792, 0160065798, 0160065824, 0160069383 & 0160069411	1001199504		•	•	•
	8042	Prior To 0160031235	Consult Factory	•			
		0160031235 - 0160069721, excl 0160065791, 0160065796, 0160065825, 0160065826, 0160069336, 0160069359 & 0160069441	1001199508		•	•	•
	10042	Prior To 0160031425	Consult Factory	•			•
		0160031425 - 0160069721, excl 0160065791, 0160065796, 0160065825, 0160065826, 0160069336, 0160069359 & 0160069441	1001199512		•	•	•
	10054	Prior To 0160031255	Consult Factory	•			•
		0160031255 - 0160069721, excl 0160065791, 0160065796, 0160065825, 0160065826, 0160069336, 0160069359 & 0160069441	1001199518		•	•	•

Non-Current Production - Truss Boom, Lull
Available Through JLG Aftermarket Parts

LENGTH			3 ft.	10 ft.	10 ft.	10 ft.	10 ft.	12 ft.	12 ft.	15 ft.
WINCH			Yes	No	No	Yes	Yes	No	Yes	No
CAPACITY			4000 lbs.	2000 lbs.	2000 lbs.	2000 lbs.	2000 lbs.	2000 lbs.	2000 lbs.	2000 lbs.
PART NO.			71396085	73011785	10338932	7301179	10338933	10010999025	1001099351	10010999015
MODEL	SN BREAKS	LOAD CHART BOOKLET								
LULL	644B-37	ALL	Consult Factory		•		•			
	644B-42	ALL	Consult Factory		•		•			
	644D-34	ALL	Consult Factory		•		•			
	644E-42	Prior To 0160031500	7300628	•	•		•			
		0160037900 - Present	1001110410					•	•	•
	844C-42	ALL	Consult Factory		•		•			
	944E-42	Prior To 0160031500	7301586	•	•		•			
		0160037794 - Present, incl 0160045421	1001110411					•	•	•
	1044C-54 SII	Prior To 0160037893	1001105327		•		•			
		0160037794 - Present	1001110409					•	•	•
	6K-37	ALL	Consult Factory		•		•			
	6K-42	ALL	Consult Factory		•		•			
8K-42	ALL	Consult Factory		•		•				
10K-42/10K-54	ALL	Consult Factory		•		•				

NOTES:
 • Use only JLG approved attachments with proper material handler model/attachment load capacity charts displayed in the operator's cab.
 • Never use your attachment as a work platform or personnel carrier.
 Can't find the attachment you are looking for? Contact your JLG Aftermarket Parts representative at 1-877-JLG-LIFT or visit www.jlg.com.

Universal Skid Steer Adapter

Increase your JLG compact telehandler machine's versatility with the universal skid steer adapter. The adapter can be placed over the standard JLG attachment coupler assembly to allow for use of many skid steer coupling style attachments.

Features

- Not designed for load bearing attachments, lifting or placement of materials
- Ideal for sweeper and trencher attachments

Current Production - Universal Skid Steer Adapter Available Through JLG Aftermarket Parts

PART NO.		100T102332
MODEL	SN BREAKS	
JLG	G5-18A	Quick coupler (hydraulic or manual)
		Universal (skid steer) quick coupler Prior To 0160040809

Non-Current Production - Universal Skid Steer Adapter Available Through JLG Aftermarket Parts

PART NO.		100T102332
MODEL	SN BREAKS	
JLG	619A	ALL
	723A	ALL
	G5-19A	ALL
	G6-23A	ALL

NOTES:

- Reduces capacity of machine, rated at 3,750 capacity. Please refer to load chart.
- For compatibility or attachment usage information, contact your JLG Representative or the Parts Contact Center.

ACCESSORY

Quick Coupling Assembly

The quick coupling assembly is a skid steer coupling that replaces the standard JLG style coupler.

Features

- Heavy duty
- Optimizes machine versatility
- Expands attachment options

Current Production - Quick Coupling Assembly Available Through JLG Aftermarket Parts

PART NO.		1001117498
MODEL	SN BREAKS	
JLG	G5-18A	ALL

NOTE: When coupling is installed, JLG coupling style attachments cannot be utilized.

NOTES:

- Use only JLG approved attachments with proper material handler model/attachment load capacity charts displayed in the operator's cab.
 - Never use your attachment as a work platform or personnel carrier.
- Can't find the attachment you are looking for? Contact your JLG Aftermarket Parts representative at 1-877-JLG-LIFT or visit www.jlg.com.

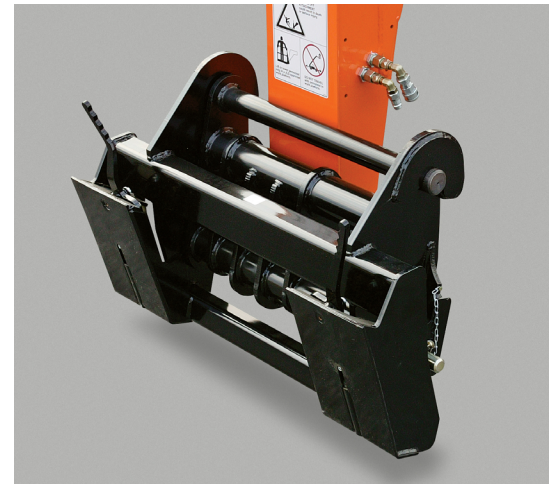

Forks

There are three main fork types available: the pallet fork, the cubing fork and the lumber fork.



Pallet Forks

- handle palletized material and other loads that require transportation and placement



Cubing Forks

- smaller width
- used to load, unload and place cubes of brick and block



Lumber Forks

- wider width
- ideal for separating stacks of lumber

Current Production - Pallet Forks

Available Through JLG Aftermarket Or With New Machine Orders

TYPE		Pallet							
CAPACITY PER FORK AT 24 IN. LOAD CENTER		3,800 lbs.	5475 lbs.	5650 lbs.	6850 lbs.	9,050 lbs.	9,050 lbs.	9,050 lbs.	9,050 lbs.
FORK DIMENSIONS		2" X 4" X 48"	2.25" x 4" x 48"	2.25" x 6" x 72"	2.25" x 5" x 48"	2.25" X 6" X 96"	2.25" X 6" X 72"	2.25" X 6" X 60"	2.25" X 6" X 48"
EYE DIAMETER		2.25 in.	2.25 in.	2.25 in.	2.25 in.	2.75 in.	2.75 in.	2.75 in.	2.75 in.
FORK DROP		24 in.	24 in.	24 in.	24 in.	24 in.	24 in.	24 in.	24 in.
PART NO.		1001099458	2340045	1001092391	2340038	1001196949	1001196950	1001196951	1001196952
Model	SN Break								
JLG	742	ALL	•	•	•				
	943	ALL	•	•	•				
	1043	ALL	•	•	•				
	1055	ALL	•	•	•				
	1255	ALL	•	•	•				
	1644	ALL				•	•	•	•
	1732	ALL				•	•	•	•
G5-18A	ALL	•							
SKYTRAK™	6036	0160069720 - Present, incl 0160065792, 0160065798, 0160065824, 0160069383 & 0160069411	•	•	•				
	6042	0160069720 - Present, incl 0160065792, 0160065798, 0160065824, 0160069383 & 0160069411	•	•	•				
	8042	0160069722 - Present, incl 0160065791, 0160065796, 0160065825, 0160065826, 0160069336, 0160069359 & 0160069441	•	•	•				
	10042	0160069722 - Present, incl 0160065791, 0160065796, 0160065825, 0160065826, 0160069336, 0160069359 & 0160069441	•	•	•				
	10054	0160069722 - Present, incl 0160065791, 0160065796, 0160065825, 0160065826, 0160069336, 0160069359 & 0160069441	•	•	•				

NOTES:

- Use only JLG approved attachments with proper material handler model/attachment load capacity charts displayed in the operator's cab.
 - Forks rated less than the attachment and/or machine capacity decrease the capacity of the attachment and machine to that of the forks.
 - Forks rated more than the attachment and/or machine capacity do not increase the attachment or machine capacity.
 - Never use your attachment as a work platform or personnel carrier.
- Can't find the attachment you are looking for? Contact your JLG Aftermarket Parts representative at 1-877-JLG-LIFT or visit www.jlg.com.

Current Production - Cubing and Lumbar Forks
Available Through JLG Aftermarket Or With New Machine Orders

TYPE		Cubing	Lumber			
CAPACITY PER FORK AT 24 IN. LOAD CENTER		1940 lbs.	3650 lbs.	5400 lbs.	6850 lbs.	8150 lbs.
FORK DIMENSIONS		2"x2"x48"	1.5"x6"x60"	1.75"x7"x60"	2"x7"x60"	2.25"x6"x60"
EYE DIAMETER		2.25 in.	2.25 in.	2.25 in.	2.25 in.	2.25 in.
FORK DROP		24 in.	24 in.	24 in.	24 in.	24 in.
PART NO.		2340037	1001099457	2340046	1001097110	2340039
Model	SN Break					
JLG	742	ALL
	943	ALL
	1043	ALL
	1055	ALL
	1255	ALL
	1644	ALL
	1732	ALL
	G5-18A	ALL
SKYTRAK™	6036	0160069720 - Present, incl 0160065792, 0160065798, 0160065824, 0160069383 & 0160069411
	6042	0160069720 - Present, incl 0160065792, 0160065798, 0160065824, 0160069383 & 0160069411
	8042	0160069722 - Present, incl 0160065791, 0160065796, 0160065825, 0160065826, 0160069336, 0160069359 & 0160069441
	10042	0160069722 - Present, incl 0160065791, 0160065796, 0160065825, 0160065826, 0160069336, 0160069359 & 0160069441
	10054	0160069722 - Present, incl 0160065791, 0160065796, 0160065825, 0160065826, 0160069336, 0160069359 & 0160069441

Non-Current Production - Pallet Forks, JLG
Available Through JLG Aftermarket Parts

TYPE		Pallet						
CAPACITY PER FORK AT 24 IN. LOAD CENTER		3800 lbs.	4409 lbs. (rated at 20" load center)	4409 lbs. (rated at 20" load center)	5475 lbs.	5475 lbs.	5650 lbs.	5650 lbs.
FORK DIMENSIONS		2"x4"x48"	1.75"x5"x48"	2"x4"x48"	2.25"x4"x48"	2.25"x4"x48"	2"x6"x60"	2.25"x6"x72"
EYE DIAMETER		2.25 in.	2.375 in.	2.375 in.	2.25 in.	2.25 in.	2.25 in.	2.25 in.
FORK DROP		24 in.	28 in.	28 in.	20 in.	24 in.	25.5 in.	24 in.
PART NO.		1001099458	2340029	2340030	91513206	2340045	91403580	1001092391
Model	SN Break							
JLG	642	ALL
	619A	ALL
	723A	ALL
	G5-19A	ALL
	G6-23A	ALL
	G6-42A	Prior To 0160037722
	G6-42A	0160037722 - Present
	G9-43A	Prior To 0160037671
	G9-43A	0160037671 - Present
	G10-43A	ALL
	G10-55A	Prior To 0160037689
	G10-55A	0160037689 - Present
	G12-55A	Prior To 0160037689
	G12-55A	0160037689 - Present
	TF6-42	ALL

Pallet options continue on next page

- NOTES:
- Use only JLG approved attachments with proper material handler model/attachment load capacity charts displayed in the operator's cab.
 - Forks rated less than the attachment and/or machine capacity decrease the capacity of the attachment and machine to that of the forks.
 - Forks rated more than the attachment and/or machine capacity do not increase the attachment or machine capacity.
 - Never use your attachment as a work platform or personnel carrier.
- Can't find the attachment you are looking for? Contact your JLG Aftermarket Parts representative at 1-877-JLG-LIFT or visit www.jlg.com.

Non-Current Production - Pallet Forks, JLG
Available Through JLG Aftermarket Parts

TYPE		Pallet				Pallet (Sold as Set)			Pallet (Fork Positioning Carriage Only)
CAPACITY PER FORK AT 24 IN. LOAD CENTER		6850 lbs.	6850 lbs.	7500 lbs.	8150 lbs.	4409 lbs. (rated at 20" load center)	4409 lbs. (rated at 20" load center)	4409 lbs.	5000 lbs.
FORK DIMENSIONS		2.25"x5"x48"	2.25"x5"x48"	2.36"x6"x48"	2.25"x6"x60"	2"x4"x48"	2"x5"x48"	2.25"x4"x48"	2.25"x4"x48"
EYE DIAMETER		2.25 in.	2.25 in.	2.31 in.	2.25 in.	2.375 in.	2.375 in.	2.375 in.	2 in.
FORK DROP		20 in.	24 in.	24 in.	20 in.	21.5 in.	21.5 in.	21.5 in.	24 in.
PART NO.		91563141	2340038	1001193801	91563142	2340041	1001117945	1001107586	7301408
Model	SN Break								
JLG	642	ALL
	723A	ALL
	G5-19A	ALL
	G6-23A	ALL
	G6-42A	Prior To 0160037722
	G6-42A	0160037722 - Present
	G9-43A	Prior To 0160037671
	G9-43A	0160037671 - Present
	G10-43A	ALL
	G10-55A	Prior To 0160037689
	G10-55A	0160037689 - Present
	G12-55A	Prior To 0160037689
	G12-55A	0160037689 - Present
	G15-44A	ALL
	TF6-42	ALL

Non-Current Production - Cubing and Drywall Forks, JLG
Available Through JLG Aftermarket Parts

TYPE		Cubing		Cubing (Sold as Set)	Drywall
CAPACITY PER FORK AT 24 IN. LOAD CENTER		1940 lbs.	1940 lbs.	1940 lbs.	2500 lbs.
FORK DIMENSIONS		2"x2"x48"	2"x2"x48"	2"x2"x48"	1.75"x4"x48"
EYE DIAMETER		2.25 in.	2.25 in.	2.375"	2.25 in.
FORK DROP		20 in.	24 in.	21.5 in.	29 in.
PART NO.		91403359	2340037	1001097922S	91403366
Model	SN Break				
JLG	642	ALL	.	.	.
	619A	ALL	.	.	.
	723A	ALL	.	.	.
	G5-19A	ALL	.	.	.
	G6-23A	ALL	.	.	.
	G6-42A	Prior To 0160037722	.	.	.
	G6-42A	0160037722 - Present	.	.	.
	G9-43A	Prior To 0160037671	.	.	.
	G9-43A	0160037671 - Present	.	.	.
	G10-43A	ALL	.	.	.
	G10-55A	Prior To 0160037689	.	.	.
	G10-55A	0160037689 - Present	.	.	.
	G12-55A	Prior To 0160037689	.	.	.
	G12-55A	0160037689 - Present	.	.	.
	TF6-42	ALL	.	.	.

- NOTES:
- Use only JLG approved attachments with proper material handler model/attachment load capacity charts displayed in the operator's cab.
 - Forks rated less than the attachment and/or machine capacity decrease the capacity of the attachment and machine to that of the forks.
 - Forks rated more than the attachment and/or machine capacity do not increase the attachment or machine capacity.
 - Never use your attachment as a work platform or personnel carrier.
- Can't find the attachment you are looking for? Contact your JLG Aftermarket Parts representative at 1-877-JLG-LIFT or visit www.jlg.com.

Non-Current Production - Lumber Forks, JLG
Available Through JLG Aftermarket Parts

TYPE		Lumber						Dual Taper
CAPACITY PER FORK AT 24 IN. LOAD CENTER		3050 lbs.	3650 lbs.	5400 lbs.	6850 lbs.	8150 lbs.	8150 lbs.	7500 lbs.
FORK DIMENSIONS		1.75"x4"x48"	1.5"x6"x60"	1.75"x7"x60"	2"x7"x60"	2.25"x6"x60"	2.25"x6"x72"	2.36"x6"x72"
EYE DIAMETER		2.25 in.	2.2 in.	2.25 in.	2.25 in.	2.25 in.	2.25 in.	2.31 in.
FORK DROP		25.5 in.	24 in.	24 in.	24 in.	24 in.	20 in.	24 in.
PART NO.		91403364	1001099457	2340046	1001097110	2340039	91563143	1001193802
Model	SN Break							
642	ALL		•		•		•	
619A	ALL		•					
723A	ALL		•					
G6-42A	Prior To 0160037722	•		•		•		•
G6-42A	0160037722 - Present			•		•		
G9-43A	Prior To 0160037671	•		•		•		•
G9-43A	0160037671 - Present			•		•		
G10-43A	ALL			•		•		
G10-55A	Prior To 0160037689	•		•		•		•
G10-55A	0160037689 - Present			•		•		
G12-55A	Prior To 0160037689	•		•		•		•
G12-55A	0160037689 - Present			•		•		
G15-44A	ALL					•		
TF6-42	ALL	•		•		•		

Non-Current Production - Pallet Forks, Gradall
Available Through JLG Aftermarket Parts

TYPE		Pallet							
CAPACITY PER FORK AT 24 IN. LOAD CENTER		3750 lbs. (rated at 48" load center)	4000 lbs.	4500 lbs.	5000 lbs.	5000 lbs.	5000 lbs.	5475 lbs.	5475 lbs.
FORK DIMENSIONS		2"x6"x96"	2"x4"x48"	1.75"x6"x48"	2"x6"x48"	2"x6"x60"	2"x6"x72"	2.25"x4"x48"	2.25"x4"x48"
EYE DIAMETER		2 in.	2 in.	2 in.	2 in.	2 in.	2 in.	2 in.	2.25 in.
FORK DROP		20 in.	20 in.	20 in.	20 in.	20 in.	20 in.	20.5 in.	20 in.
PART NO.		H0453002	90453002	90601819	90553005	90601015	90553018	90453048	91513206
Model	SN Break								
522D/524D	ALL		•	•		•	•	•	
534C-9	ALL	•	•	•		•	•	•	
534C-10	ALL		•	•		•	•	•	
534D-6	ALL		•	•		•	•	•	
534D-9	Prior To 0160037689	•		•		•		•	
	0160037689 - Present								
534D-10	Prior To 0160037689	•		•		•		•	
	0160037689 - Present								
544C	ALL		•	•		•	•	•	
544D	Prior To 0160037689	•		•		•		•	
	0160037689 - Present								
G6-42P	Prior To 0160037689								•
	0160037689 - Present								

Non-Current Production - Pallet Forks, Gradall
Available Through JLG Aftermarket Parts

TYPE		Pallet						Pallet (Swing Mast Carriage Only)	
CAPACITY PER FORK AT 24 IN. LOAD CENTER		5475 lbs.	5650 lbs.	5650 lbs.	6850 lbs.	6850 lbs.	8150 lbs.	2500 lbs.	5650 lbs.
FORK DIMENSIONS		2.25"x4"x48"	2"x6"x60"	2.25"x6"x72"	2.25"x5"x48"	2.25"x5"x48"	2.25"x6"x60"	1.75"x4"x48"	2"x6"x60"
EYE DIAMETER		2.25 in.	2.25 in.	2.25 in.	2.25 in.	2.25 in.	2.25 in.	2 in.	2 in.
FORK DROP		24 in.	25.5 in.	24 in.	20 in.	24 in.	20 in.	25.5 in.	25.5 in.
PART NO.		2340045	91403580	1001092391	91563141	2340038	91563142	90553008	90453045
Model	SN Break								
522D/524D	ALL								
534C-9	ALL							•	•
534C-10	ALL							•	•
534D-6	ALL							•	•
534D-9	Prior To 0160037689	•		•		•		•	•
	0160037689 - Present								
534D-10	Prior To 0160037689	•		•		•		•	•
	0160037689 - Present								
544C	ALL							•	•
544D	Prior To 0160037689	•		•		•		•	•
	0160037689 - Present								
G6-42P	Prior To 0160037689	•		•		•		•	
	0160037689 - Present								

NOTES:
 • Use only JLG approved attachments with proper material handler model/attachment load capacity charts displayed in the operator's cab.
 • Forks rated less than the attachment and/or machine capacity decrease the capacity of the attachment and machine to that of the forks.
 • Forks rated more than the attachment and/or machine capacity do not increase the attachment or machine capacity.
 • Never use your attachment as a work platform or personnel carrier.
 Can't find the attachment you are looking for? Contact your JLG Aftermarket Parts representative at 1-877-JLG-LIFT or visit www.jlg.com.

NOTES:
 • Use only JLG approved attachments with proper material handler model/attachment load capacity charts displayed in the operator's cab.
 • Forks rated less than the attachment and/or machine capacity decrease the capacity of the attachment and machine to that of the forks.
 • Forks rated more than the attachment and/or machine capacity do not increase the attachment or machine capacity.
 • Never use your attachment as a work platform or personnel carrier.
 Can't find the attachment you are looking for? Contact your JLG Aftermarket Parts representative at 1-877-JLG-LIFT or visit www.jlg.com.

Non-Current Production - Cubing and Drywall Forks, Gradall
Available Through JLG Aftermarket Parts

TYPE		Cubing			Drywall		
CAPACITY PER FORK AT 24 IN. LOAD CENTER		1500 lbs.	1940 lbs.	1940 lbs.	2500 lbs.	2500 lbs.	
FORK DIMENSIONS		2"x2"x48"	2"x2"x48"	2"x2"x48"	1.75"x4"x48"	1.75"x4"x48"	
EYE DIAMETER		2 in.	2.25 in.	2.25 in.	2 in.	2.25 in.	
FORK DROP		20 in.	20 in.	24 in.	29 in.	29 in.	
PART NO.		90600390	91403359	2340037	90453013	91403366	
Model	SN Break						
GRADALL	522D/524D	ALL	
	534C-9	ALL	
	534C-10	ALL	
	534D-6	ALL	
	534D-9	Prior To 0160037689
		0160037689 - Present
	534D-10	Prior To 0160037689
		0160037689 - Present
	544C	ALL	
	544D	Prior To 0160037689
		0160037689 - Present
	G6-42P	Prior To 0160037689
0160037689 - Present		

Non-Current Production - Lumber Forks, Gradall
Available Through JLG Aftermarket Parts

TYPE		Lumber						
CAPACITY PER FORK AT 24 IN. LOAD CENTER		3050 lbs.	5000 lbs.	5400 lbs.	5650 lbs.	8150 lbs.	8150 lbs.	
FORK DIMENSIONS		1.75"x4"x48"	2"x6"x72"	1.75"x7"x60"	2"x6"x60"	2.25"x6"x60"	2.25"x6"x72"	
EYE DIAMETER		2.25 in.	2 in.	2.25 in.	2 in.	2.25 in.	2.25 in.	
FORK DROP		25.5 in.	20 in.	24 in.	20 in.	24 in.	20 in.	
PART NO.		91403364	91123132	2340046	91163269	2340039	91563143	
Model	SN Break							
GRADALL	522D/524D	ALL	
	534C-9	ALL	
	534C-10	ALL	
	534D-6	ALL	
	534D-9	Prior To 0160037689
		0160037689 - Present
	534D-10	Prior To 0160037689
		0160037689 - Present
	544C	ALL	
	544D	Prior To 0160037689
		0160037689 - Present
	G6-42P	Prior To 0160037689
0160037689 - Present		

NOTES:
 • Use only JLG approved attachments with proper material handler model/attachment load capacity charts displayed in the operator's cab.
 • Forks rated less than the attachment and/or machine capacity decrease the capacity of the attachment and machine to that of the forks.
 • Forks rated more than the attachment and/or machine capacity do not increase the attachment or machine capacity.
 • Never use your attachment as a work platform or personnel carrier.
 Can't find the attachment you are looking for? Contact your JLG Aftermarket Parts representative at 1-877-JLG-LIFT or visit www.jlg.com.

Non-Current Production - Pallet Forks, SkyTrak
Available Through JLG Aftermarket Parts

TYPE		Pallet							
CAPACITY PER FORK AT 24 IN. LOAD CENTER		3000 lbs.	4000 lbs.	5000 lbs.	5060 lbs.	5475 lbs.	5600 lbs.	6850 lbs.	
FORK DIMENSIONS		1.75"x4"x48"	2"x4"x48"	2"x4"x48"	2"x5"x72"	2.25"x4"x48"	2.25"x6"x72"	2.25"x5"x48"	
EYE DIAMETER		2 in.	2 in.	2 in.	2 in.	2.25 in.	2.25 in.	2.25 in.	
FORK DROP		22 in.	24 in.	24 in.	24 in.	24 in.	24 in.	24 in.	
PART NO.		7048233	7097523	7301408	2340042	2340045	1001092391	2340038	
Model	SN Break								
SKYTRAK	4266	ALL	
	4270	ALL	
	4290	ALL	
	6036	Prior To 0160031200
		0160031200 - 016009719, excl 0160065792, 0160065798, 0160065824, 0160069383 & 0160069411
	6042	Prior To 0160031200
		0160031200 - 016009719, excl 0160065792, 0160065798, 0160065824, 0160069383 & 0160069411
	8042	Prior To 0160031235
		0160031235 - 0160069721, excl 0160065791, 0160065796, 0160065825, 0160065826, 0160069336, 0160069359 & 0160069441
	10042	Prior To 0160031425
		0160031425 - 0160069721, excl 0160065791, 0160065796, 0160065825, 0160065826, 0160069336, 0160069359 & 0160069441
	10054	Prior To 0160031255
0160031255 - 0160069721, excl 0160065791, 0160065796, 0160065825, 0160065826, 0160069336, 0160069359 & 0160069441		

Non-Current Production - Cubing, Drywall and Lumber Forks, SkyTrak
Available Through JLG Aftermarket Parts

TYPE		Cubing		Drywall	Lumber					
CAPACITY PER FORK AT 24 IN. LOAD CENTER		1940 lbs.	2000 lbs.	5000 lbs.	3000 lbs.	5400 lbs.	5650 lbs.	6000 lbs.	8150 lbs.	
FORK DIMENSIONS		2"x2"x48"	2"x2"x48"	1.75"x7"x48"	1.75"x5"x60"	1.75"x7"x60"	2"x6"x60"	1.75"x7"x60"	2.25"x6"x60"	
EYE DIAMETER		2.25 in.	2 in.	2 in.	2 in.	2.25 in.	2 in.	2 in.	2.25 in.	
FORK DROP		24 in.	22 in.	24 in.	24 in.	24 in.	24 in.	24 in.	24 in.	
PART NO.		2340037	7139747	7130453	7092793	2340046	2340036	7139746	2340039	
Model	SN Break									
SKYTRAK	4266	ALL	
	4270	ALL	
	4290	ALL	
	6036	Prior To 0160031200
		0160031200 - 016009719, excl 0160065792, 0160065798, 0160065824, 0160069383 & 0160069411
	6042	Prior To 0160031200
		0160031200 - 016009719, excl 0160065792, 0160065798, 0160065824, 0160069383 & 0160069411
	8042	Prior To 0160031235
		0160031235 - 0160069721, excl 0160065791, 0160065796, 0160065825, 0160065826, 0160069336, 0160069359 & 0160069441
	10042	Prior To 0160031425
		0160031425 - 0160069721, excl 0160065791, 0160065796, 0160065825, 0160065826, 0160069336, 0160069359 & 0160069441
	10054	Prior To 0160031255
0160031255 - 0160069721, excl 0160065791, 0160065796, 0160065825, 0160065826, 0160069336, 0160069359 & 0160069441		

NOTES:
 • Use only JLG approved attachments with proper material handler model/attachment load capacity charts displayed in the operator's cab.
 • Forks rated less than the attachment and/or machine capacity decrease the capacity of the attachment and machine to that of the forks.
 • Forks rated more than the attachment and/or machine capacity do not increase the attachment or machine capacity.
 • Never use your attachment as a work platform or personnel carrier.
 Can't find the attachment you are looking for? Contact your JLG Aftermarket Parts representative at 1-877-JLG-LIFT or visit www.jlg.com.

Non-Current Production - Pallet Forks, Lull
Available Through JLG Aftermarket Parts

TYPE		Pallet								
CAPACITY PER FORK AT 24 IN. LOAD CENTER		4000 lbs.	4000 lbs.	4000 lbs.	5000 lbs.	5000 lbs.	5000 lbs.	5000 lbs.	5000 lbs.	
FORK DIMENSIONS		2"x4"x42"	2"x4"x48"	2"x4"x60"	2"x4"x48"	2"x5"x42"	2"x5"x48"	2"x5"x60"	2.25"x4"x42"	2.25"x4"x60"
EYE DIAMETER		1.875 in.	1.875 in.	1.875 in.	2 in.	2 in.	2 in.	2 in.	2 in.	2 in.
FORK DROP		25 in.	27 in.	25 in.	24 in.	25 in.	27 in.	27 in.	25 in.	25 in.
PART NO.		10238026	1001099850	10238117	7301408	10238568	1001099846	1001099848	10239893	10239895
Model	SN Break									
644B-37	ALL	•	•	•						
644B-42	ALL	•	•	•						
644D-34	ALL	•	•	•						
644E-42	Prior To 0160037794				•					
	0160037794 - Present				•					
844C-42	ALL	•	•	•						
944E-42	Prior To 0160037794				•					
1044C-42	ALL				•	•	•	•	•	•
1044C-54	ALL				•	•	•	•	•	•
1044C-54 SII	Prior To 0160037893		•			•	•	•		
	0160037893 - Present				•					
6K-37	ALL	•	•	•						
6K-42	ALL	•	•	•						
8K-42	ALL	•	•	•						
10K-42/10K-54	ALL				•	•	•	•	•	•

Non-Current Production - Pallet Forks, Lull
Available Through JLG Aftermarket Parts

Pallet options continue below

TYPE		Pallet				Pallet (Swing Carriage Only)		Pallet (Fork Positioning Carriage Only)		
CAPACITY PER FORK AT 24 IN. LOAD CENTER		5000 lbs.	5475 lbs.	5600 lbs.	6850 lbs.	5000 lbs.	5060 lbs.	4000 lbs.	4000 lbs.	5000 lbs.
FORK DIMENSIONS		2.25"x4"x48"	2.25"x4"x48"	2.25"x6"x72"	2.25"x5"x48"	2"x5"x60"	2"x5"x48"	2"x4"x42"	2"x4"x48"	2"x5"x42"
EYE DIAMETER		2 in.	2.25 in.	2.25 in.	2.25 in.	2.25 in.	2.25 in.	2.75 in.	2.75 in.	2.75 in.
FORK DROP		27 in.	24 in.	24 in.	24 in.	22 in.	22 in.	25 in.	25 in.	25 in.
PART NO.		1001099847	2340045	1001092391	2340038	10239970	2340048	10338502 (LH) 10338503 (RH)	10339345 (LH) 10339346 (RH)	10365687 (LH) 10365686 (RH)
Model	SN Break									
644B-37	ALL							•	•	
644B-42	ALL							•	•	
644D-34	ALL									
644E-42	Prior To 0160037794		•		•					
	0160037794 - Present		•	•	•					
844C-42	ALL				•			•		
944E-42	Prior To 0160037794		•		•					
1044C-42	ALL	•								•
1044C-54	ALL	•								•
1044C-54 SII	Prior To 0160037893	•			•	•				•
	0160037893 - Present		•	•	•					
6K-37	ALL							•	•	
6K-42	ALL							•	•	
8K-42	ALL							•	•	
10K-42/10K-54	ALL	•								

NOTES:

- Use only JLG approved attachments with proper material handler model/attachment load capacity charts displayed in the operator's cab.
 - Forks rated less than the attachment and/or machine capacity decrease the capacity of the attachment and machine to that of the forks.
 - Forks rated more than the attachment and/or machine capacity do not increase the attachment or machine capacity.
 - Never use your attachment as a work platform or personnel carrier.
- Can't find the attachment you are looking for? Contact your JLG Aftermarket Parts representative at 1-877-JLG-LIFT or visit www.jlg.com.

Non-Current Production - Cubing and Lumber Forks, Lull
Available Through JLG Aftermarket Parts

TYPE		Cubing				Lumber		
CAPACITY PER FORK AT 24 IN. LOAD CENTER		1940 lbs.	2000 lbs.	2000 lbs.	2000 lbs.	4000 lbs.	4000 lbs.	5000 lbs.
FORK DIMENSIONS		2"x2"x48"	2"x2"x48"	2"x2"x48"	2"x2"x48"	1.75"x6"x48"	1.75"x6"x60"	1.75"x7"x48"
EYE DIAMETER		2.25 in.	2 in.	2 in.	2 in.	1.875 in.	1.875 in.	2 in.
FORK DROP		24 in.	22 in.	25 in.	27 in.	25 in.	25 in.	25 in.
PART NO.		2340037	7139747	10238118	1001099845	10217103	10223610	10239094
Model	SN Break							
644B-37	ALL			•		•	•	
644B-42	ALL			•		•	•	
644D-34	ALL			•		•	•	
644E-42	Prior To 0160037794	•	•					
	0160037794 - Present	•						
844C-42	ALL			•		•	•	
944E-42	Prior To 0160037794	•	•					
1044C-42	ALL			•		•		•
1044C-54	ALL			•		•		•
1044C-54 SII	Prior To 0160037893			•		•		
	0160037893 - Present	•						
6K-37	ALL			•		•	•	
6K-42	ALL			•		•	•	
8K-42	ALL			•		•	•	
10K-42/10K-54	ALL			•		•		•

Non-Current Production - Lumber Forks, Lull
Available Through JLG Aftermarket Parts

Lumber options continue below

TYPE		Lumber						Lumber (Swing Carriage Only)		
CAPACITY PER FORK AT 24 IN. LOAD CENTER		5000 lbs.	5000 lbs.	5000 lbs.	5400 lbs.	5650 lbs.	6000 lbs.	8150 lbs.	4000 lbs.	5000 lbs.
FORK DIMENSIONS		1.75"x7"x60"	2"x6"x48"	2"x6"x60"	1.75"x7"x60"	2"x6"x60"	1.75"x7"x60"	2.25"x6"x60"	1.75"x6"x48"	1.75"x7"x60"
EYE DIAMETER		2 in.	2 in.	2 in.	2.25 in.	2 in.	2 in.	2.25 in.	2.25 in.	2.25 in.
FORK DROP		27 in.	29.5 in.	29.5 in.	24 in.	24 in.	24 in.	24 in.	22 in.	22 in.
PART NO.		1001099849	10238181	10238182	2340046	2340036	7139746	2340039	10239954	10239969
Model	SN Break									
644B-37	ALL									
644B-42	ALL									
644D-34	ALL									
644E-42	Prior To 0160037794					•	•	•		
	0160037794 - Present				•			•		
844C-42	ALL									
944E-42	Prior To 0160037794					•	•	•		
1044C-42	ALL	•	•	•						
1044C-54	ALL	•	•	•						
1044C-54 SII	Prior To 0160037893	•						•	•	
	0160037893 - Present				•			•		
6K-37	ALL									
6K-42	ALL									
8K-42	ALL									
10K-42/10K-54	ALL	•	•	•						

NOTES:

- Use only JLG approved attachments with proper material handler model/attachment load capacity charts displayed in the operator's cab.
 - Forks rated less than the attachment and/or machine capacity decrease the capacity of the attachment and machine to that of the forks.
 - Forks rated more than the attachment and/or machine capacity do not increase the attachment or machine capacity.
 - Never use your attachment as a work platform or personnel carrier.
- Can't find the attachment you are looking for? Contact your JLG Aftermarket Parts representative at 1-877-JLG-LIFT or visit www.jlg.com.

Fork Pins and Bars

Whether you call it a fork pin, fork bar or fork shaft, we can supply your JLG Telehandler with the size you need. Looking for a specific size? Please refer to the table below. If your size is not listed, or for compatibility questions, consult the JLG Parts Department prior to purchase.

Features

- Available in diameters from 1 7/8" to 2.36"
- Zinc Plated for durability



SIZE (in.)	PART NO.
1 7/8" x 53 3/4"	10138064
1 7/8" x 54.06"	10138499
1 7/8" x 76 1/2"	10116207
2 3/8" x 50 13/16"	7028136
2" x 51.12"	7128772
2" x 54 1/2"	90451058
2" x 54.06"	10165685
2" x 54.25"	10223049
2" x 55.38"	7128782
2" x 63.12"	7128792
2" x 71"	90402478
2" x 72 1/8"	91301083
2" x 74"	70012208
2" x 76 1/2"	90551013
2" x 77.25"	10124495
2.25" x 12 3/4"	91401340
2.25" x 48.38"	70021339

SIZE (in.)	PART NO.
2.25" x 50.25"	70022105
2.25" x 52.44"	70022990
2.25" x 54 3/8"	91401303
2.25" x 55.125"	3423275
2.25" x 64.5" (non plated)	70011218
2.25" x 64.5" (plated)	70011215
2.25" x 74"	70011217
2.25" x 74" (non plated)	70011220
2.25" x 65.125"	3423242
2.25" x 69" (non plated)	70011219
2.25" x 69" (plated)	70011216
2.25" x 75"	70011990
2.25" x 77.125"	3423276
2.25" x 78 3/8"	91401324
2.25" x 79"	70020027
2.36" x 24.69"	4040283
3" x 84"	70011759



NOTES:
 • Use only JLG approved attachments with proper material handler model/attachment load capacity charts displayed in the operator's cab.
 • Forks rated less than the attachment and/or machine capacity decrease the capacity of the attachment and machine to that of the forks.
 • Forks rated more than the attachment and/or machine capacity do not increase the attachment or machine capacity.
 • Never use your attachment as a work platform or personnel carrier.
 Can't find the attachment you are looking for? Contact your JLG Aftermarket Parts representative at 1-877-JLG-LIFT or visit www.jlg.com.

Fork Extensions

The fork extensions increase your machine's versatility on the jobsite.

Features

- Factory approved
- Designed specifically for JLG manufactured telehandlers
- Requires two per machine
- Requires fork part number 1001092391 or 2340039 for use

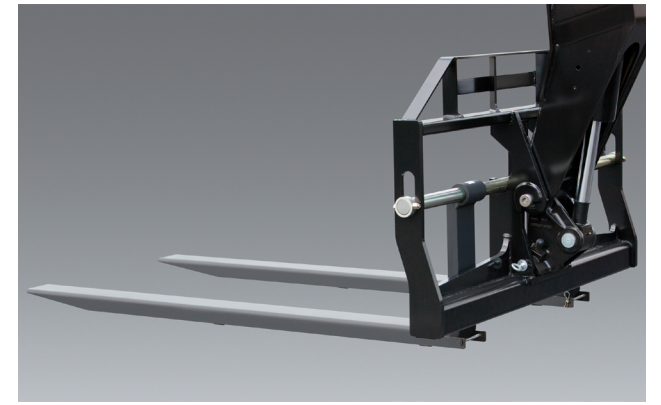

Current Production - Fork Extensions
 Available Through JLG Aftermarket Or With New Machine Orders

FORK DIMENSIONS		2'x6"x60"	2.36'x6"x60"	2'x6"x60"	2.36'x6"x60"
LOAD CENTER		24 in.	24 in.	45 in.	45 in.
CAPACITY (MAX)		4200 lbs.	6000 lbs.	2240 lbs.	3200 lbs.
APPROX. WEIGHT		1490 lbs.			
PART NO.		1001137512			
LENGTH		90"			
MODEL	SN BREAKS				
JLG	742	ALL			
	943/ 1043	Without Outriggers			
		With Outriggers			
	1055	Prior To 0160074169			
		0160074169 - Present			
1255	Prior To 0160074168				
	0160074168 - Present				
SKYTRAK T4E	6036	0160069720 - 0160075649, incl 0160065792, 0160065798, 0160065824, 0160069383, 0160069411, 0160075653 & 0160075722			
		0160075650 - Present, excl 0160075653 & 0160075722			
	6042	0160069720 - 0160075656, incl 0160065792, 0160065798, 0160065824, 0160069383 & 0160069411			
		0160075657 - Present			
	8042	0160069722 - 0160075670, incl 0160065791, 0160065796, 0160065825, 0160065826, 0160069336, 0160069359 & 0160069441			
		0160075671 - Present			
	10042	0160069722 - 0160075987, incl 0160065791, 0160065796, 0160065825, 0160065826, 0160069336, 0160069359 & 0160069441			
		0160075988 - Present			
	10054	0160069722 - 0160075682, incl 0160065791, 0160065796, 0160065825, 0160065826, 0160069336, 0160069359, 0160069441 & 0160075696			
		0160075683 - Present, excl 0160075696			

NOTES:
 • Use only JLG approved attachments with proper material handler model/attachment load capacity charts displayed in the operator's cab.
 • Forks rated less than the attachment and/or machine capacity decrease the capacity of the attachment and machine to that of the forks.
 • Forks rated more than the attachment and/or machine capacity do not increase the attachment or machine capacity.
 • Never use your attachment as a work platform or personnel carrier.
 Can't find the attachment you are looking for? Contact your JLG Aftermarket Parts representative at 1-877-JLG-LIFT or visit www.jlg.com.

Non-Current Production - Fork Extensions, JLG
Available Through JLG Aftermarket Parts

FORK DIMENSIONS		2"x6"x60"	2.36"x6"x60"	2"x6"x60"	2.36"x6"x60"
LOAD CENTER		24 in.	24 in.	45 in.	45 in.
CAPACITY (MAX)		4200 lbs.	6000 lbs.	2240 lbs.	3200 lbs.
APPROX. WEIGHT		1490 lbs.			
PART NO.		1001137512			
LENGTH		90 in.			
MODEL	SN BREAKS				
JLG	642	ALL			
	G6-42A	0160037722 - 0160040659			
		0160040678 - Present			
	G9-43A	0160037671 - 0160040674, excl 0160040468 & 0160040672			
		0160040675 - Present, incl 0160040468 & 0160040672			
	G10-43A	0160037671 - 0160040674, excl 0160040468 & 0160040672			
		0160040675 - Present, incl 0160040468 & 0160040672			
	G10-55A	0160037690 - 0160038486, incl 0160038505 & 0160038507, excl 0160038324, 0160038489 & 0160038493			
		0160038500 - Present, incl 0160038324, 0160038489 & 0160038493, excl 0160038505 & 0160038507			
	G12-55A	0160037689 - 0160038533			
0160038538 - Present					
G15-44A	Prior To 0160074142				
	0160074142 - Present				

Non-Current Production - Fork Extensions, SkyTrak
Available Through JLG Aftermarket Parts

FORK DIMENSIONS		2"x6"x60"	2.36"x6"x60"	2"x6"x60"	2.36"x6"x60"
LOAD CENTER		24 in.	24 in.	45 in.	45 in.
CAPACITY (MAX)		4200 lbs.	6000 lbs.	2240 lbs.	3200 lbs.
APPROX. WEIGHT		1490 lbs.			
PART NO.		1001137512			
LENGTH		90 in.			
MODEL	SN BREAKS				
SKYTRAK	6036	0160031200 - 0160069719, excl 0160065792, 0160065798, 0160065824, 0160069383 & 0160069411			
	6042	0160031200 - 0160069719, excl 0160065792, 0160065798, 0160065824, 0160069383 & 0160069411			
	8042	0160031235 - 0160069721, excl 0160065791, 0160065796, 0160065825, 0160065826, 0160069336, 0160069359 & 0160069441			
	10042	0160031425 - 0160069721, excl 0160065791, 0160065796, 0160065825, 0160065826, 0160069336, 0160069359 & 0160069441			
	10054	0160031255 - 0160069721, excl 0160065791, 0160065796, 0160065825, 0160065826, 0160069336, 0160069359 & 0160069441			

Non-Current Production - Fork Extensions, Lull
Available Through JLG Aftermarket Parts

FORK DIMENSIONS		2"x6"x60"	2.36"x6"x60"	2"x6"x60"	2.36"x6"x60"
LOAD CENTER		24 in.	24 in.	45 in.	45 in.
CAPACITY (MAX)		4200 lbs.	6000 lbs.	2240 lbs.	3200 lbs.
APPROX. WEIGHT		1490 lbs.			
PART NO.		1001137512			
LENGTH		90 in.			
MODEL	SN BREAKS				
LULL	644E-42	0160037900 - Present			
	944E-42	0160037794 - Present, incl 0160045421			
	1044C-54 SII	0160037794 - Present			

NOTES:

- Use only JLG approved attachments with proper material handler model/attachment load capacity charts displayed in the operator's cab.
 - Forks rated less than the attachment and/or machine capacity decrease the capacity of the attachment and machine to that of the forks.
 - Forks rated more than the attachment and/or machine capacity do not increase the attachment or machine capacity.
 - Never use your attachment as a work platform or personnel carrier.
- Can't find the attachment you are looking for? Contact your JLG Aftermarket Parts representative at 1-877-JLG-LIFT or visit www.jlg.com.

Fork Caliper

Worn out forks are unreliable and inefficient on the job site. A fork caliper can help you to identify fork wear before it becomes an issue.

If the inner jaws pass over the fork, wear is more than 10%. When wear is more than 10%, the fork must be removed from service and replaced. If the inner jaws hit the fork, wear is within the tolerance and the fork is approved for use.

Features

- Pocket portable
- Easy to use on the job
- Measure the thickness of the fork arm shank



DESCRIPTION	PART NO.
Fork Inspection Safety Kit (Includes fork arm wear caliper guide, inspection log and caliper)	70011840
Caliper	7025304

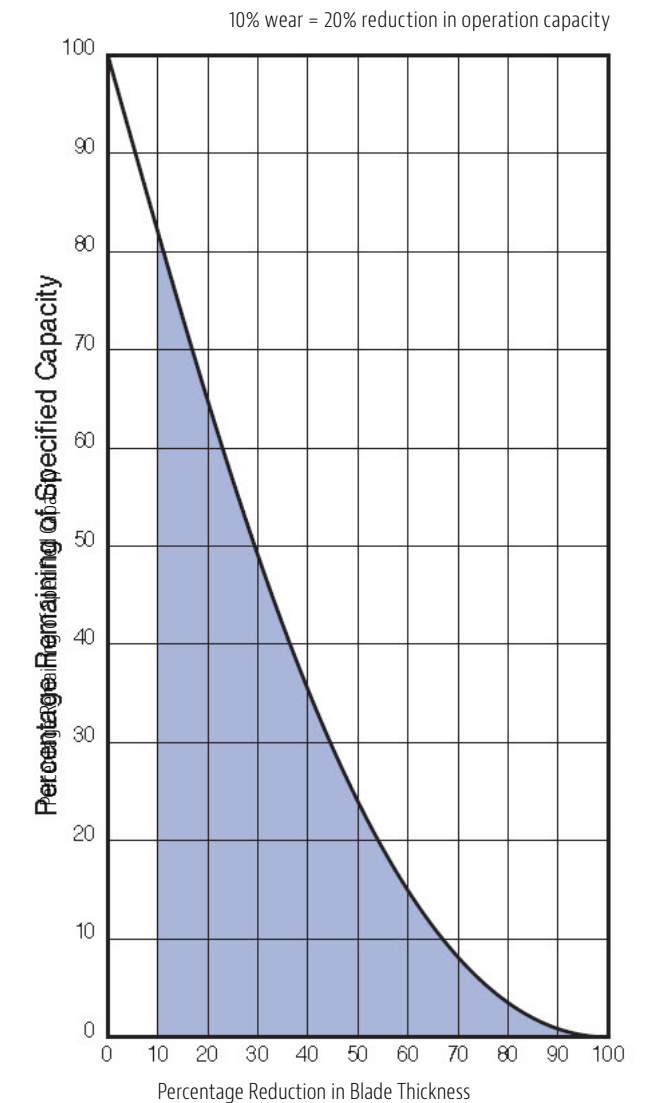

This chart shows how fork wear reduces truck capacity. ANSI/ITSDF B56.1-2012 standards require that each fork be at least half the capacity of the truck at the rated load center distance as shown on the truck nameplate. Refer to ANSI website: www.itsdf.org/pB56.asp

To order go to www.Discount-Equipment.com



www.Discount-Equipment.com