



An Oshkosh Corporation Company



www.Discount-Equipment.com

---

# **Operation and Safety Manual**

*Original Instructions - Keep this manual with the machine at all times.*

**Model(s)**

**X600AJ**

**ANSI**



**3121637**

June 29, 2018 - Rev F

---

**TO PURCHASE THIS PRODUCT PLEASE CONTACT US**



**Equipment Financing and  
Extended Warranties Available**



**Discount-Equipment.com is your online resource for  
commercial and industrial quality parts and equipment sales.**

**561-964-4949**

**visit us on line @ [www.discount-equipment.com](http://www.discount-equipment.com)**

Select an option below to find your Equipment

**Search by Manufacturer**

**Search by Product Type**

**Request a Quote**

We sell worldwide for the brands: Genie, Terex, JLG, MultiQuip, Mikasa, Essick, Whiteman, Mayco, Toro Stone, Diamond Products, Generac Magnum, Airman, Haulotte, Barreto, Power Blanket, Nifty Lift, Atlas Copco, Chicago Pneumatic, Allmand, Miller Curber, Skyjack, Lull, Skytrak, Tsurumi, Husquvarna Target, Stow, Wacker, Sakai, Mi-T-M, Sullair, Basic, Dynapac, MBW, Weber, Bartell, Bennar Newman, Haulotte, Ditch Runner, Menegotti, Morrison, Contec, Buddy, Crown, Edco, Wyco, Bomag, Laymor, EZ Trench, Bil-Jax, F.S. Curtis, Gehl Pavers, Heli, Honda, ICS/PowerGrit, IHI, Partner, Imer, Clipper, MMD, Koshin, Rice, CH&E, General Equipment, Amida, Coleman, NAC, Gradall, Square Shooter, Kent, Stanley, Tamco, Toku, Hatz, Kohler, Robin, Wisconsin, Northrock, Oztec, Toker TK, Rol-Air, APT, Wylie, Ingersoll Rand / Doosan, Innovatech, Con X, Ammann, Mecalac, Makinex, Smith Surface Prep, Small Line, Wanco, Yanmar



## **WARNING**

Operating, servicing and maintaining this vehicle or equipment can expose you to chemicals including engine exhaust, carbon monoxide, phthalates, and lead, which are known to the State of California to cause cancer and birth defects or other reproductive harm. To minimize exposure, avoid breathing exhaust, do not idle the engine except as necessary, service your vehicle or equipment in a well-ventilated area and wear gloves or wash your hands frequently when servicing. For more information go to [www.P65Warnings.ca.gov](http://www.P65Warnings.ca.gov).

## **FOREWORD**

This manual is a very important tool! Keep it with the machine at all times.

The purpose of this manual is to provide owners, users, operators, lessors, and lessees with the precautions and operating procedures essential for the safe and proper machine operation for its intended purpose.

Due to continuous product improvements, JLG Industries, Inc. reserves the right to make specification changes without prior notification. Contact JLG Industries, Inc. for updated information.

To order go to [Discount-Equipment.com](http://Discount-Equipment.com)

**SAFETY ALERT SYMBOLS AND SAFETY SIGNAL WORDS**



This is the Safety Alert Symbol. It is used to alert you to the potential personal injury hazards. Obey all safety messages that follow this symbol to avoid possible injury or death.

**⚠ DANGER**

INDICATES AN IMMINENTLY HAZARDOUS SITUATION. IF NOT AVOIDED, WILL RESULT IN SERIOUS INJURY OR DEATH. THIS DECAL WILL HAVE A RED BACKGROUND.

**⚠ WARNING**

INDICATES A POTENTIALITY HAZARDOUS SITUATION. IF NOT AVOIDED, COULD RESULT IN SERIOUS INJURY OR DEATH. THIS DECAL WILL HAVE AN ORANGE BACKGROUND.

**⚠ CAUTION**

INDICATES A POTENTIALITY HAZARDOUS SITUATION. IF NOT AVOIDED, MAY RESULT IN MINOR OR MODERATE INJURY. IT MAY ALSO ALERT AGAINST UNSAFE PRACTICES. THIS DECAL WILL HAVE A YELLOW BACKGROUND.

**NOTICE**

INDICATES INFORMATION OR A COMPANY POLICY THAT RELATES DIRECTLY OR INDIRECTLY TO THE SAFETY OF PERSONNEL OR PROTECTION OF PROPERTY.

## SECTION - SAFETY ALERT SYMBOLS AND SAFETY SIGNAL WORDS

### **WARNING**

**THIS PRODUCT MUST COMPLY WITH ALL SAFETY RELATED BULLETINS. CONTACT JLG INDUSTRIES, INC. OR THE LOCAL AUTHORIZED JLG REPRESENTATIVE FOR INFORMATION REGARDING SAFETY RELATED BULLETINS WHICH MAY HAVE BEEN ISSUED FOR THIS PRODUCT.**

### **NOTICE**

**JLG INDUSTRIES, INC. SENDS SAFETY RELATED BULLETINS TO THE OWNER OF RECORD OF THIS MACHINE. CONTACT JLG INDUSTRIES, INC. TO ENSURE THAT THE CURRENT OWNER RECORDS ARE UPDATED AND ACCURATE.**

### **NOTICE**

**JLG INDUSTRIES, INC. MUST BE NOTIFIED IMMEDIATELY IN ALL INSTANCES WHERE JLG PRODUCTS HAVE BEEN INVOLVED IN AN ACCIDENT INVOLVING BODILY INJURY OR DEATH OF PERSONNEL OR WHEN SUBSTANTIAL DAMAGE HAS OCCURRED TO PERSONAL PROPERTY OR THE JLG PRODUCT.**

### **For :**

- Accident Reporting
- Product Safety Publications
- Current Owner Updates
- Questions Regarding Product Safety
- Standards and Regulations Compliance Information
- Questions Regarding Special Product Applications
- Questions Regarding Product Modifications

### **Contact :**

Product Safety and Reliability Department  
JLG Industries, Inc.  
13224 Fountainhead Plaza  
Hagerstown, MD 21742  
USA

or Your Local JLG Office  
(See addresses on inside of manual cover)

### **In USA:**

Toll Free: 877-JLG-SAFE (877-554-7233)

### **Outside USA:**

Phone: 240-420-2661  
E-mail: ProductSafety@JLG.com

## SECTION - REVISION LOG

---

### REVISION LOG

Original Issue	A - 05-07-2014
Revised	B - January 22, 2016
Revised	C - July 25, 2016
Revised	D - January 19, 2017
Revised	E - March 16, 2017
Revised	F - June 29, 2018 - Revised Covers, Prop 65

To order go to [Discount-Equipment.com](http://Discount-Equipment.com)

<b>SECTION - PARAGRAPH, SUBJECT</b>	<b>PAGE</b>	<b>SECTION - PARAGRAPH, SUBJECT</b>	<b>PAGE</b>
FOREWORD .....	A	Operator Training.....	2-1
SAFETY ALERT SYMBOLS AND SAFETY SIGNAL WORDS .....	B	Training Supervision .....	2-1
Contact : .....	C	Operator Responsibility .....	2-1
In USA: .....	C	2.2 PREPARATION, INSPECTION, AND MAINTENANCE .....	2-2
Outside USA: .....	C	Pre-Start Inspection .....	2-4
REVISION LOG .....	D	Daily Walk-Around Inspection .....	2-6
		General.....	2-6
		Function Check.....	2-8
<b>SECTION - 1 - SAFETY PRECAUTIONS</b>		<b>SECTION - 3 - MACHINE CONTROLS, INDICATORS AND OPERATION</b>	
1.1 GENERAL.....	1-1	3.1 GROUND CONTROL STATION .....	3-3
1.2 PRE-OPERATION.....	1-1	Ground Control Station - With Enable Lever....	3-4
Operator Training and Knowledge .....	1-1	Ground Control Station - With Enable Knob....	3-7
Workplace Inspection.....	1-2	3.2 PLATFORM/REMOTE CONTROL STATION .....	3-10
Machine Inspection .....	1-3	Maintenance Control Position On The Ground.....	3-10
1.3 OPERATION .....	1-3	Platform/Remote Control Position From The Ground.....	3-11
General.....	1-3	Control Position From In The Platform .....	3-11
Trip and Fall Hazards.....	1-4	Platform/Remote Control Station Functions .	3-13
Electrocution Hazards.....	1-5	Platform/Remote Control Station LCD Display	3-17
Tipping Hazards .....	1-7		
Crushing and Collision Hazards.....	1-9	<b>SECTION - 4 - MACHINE OPERATION</b>	
1.4 TOWING, LIFTING, AND HAULING .....	1-10	4.1 DESCRIPTION.....	4-1
1.5 MAINTENANCE .....	1-10	4.2 BOOM OPERATING CHARACTERISTICS AND	
Maintenance Hazards.....	1-10		
Battery Hazards.....	1-12		
<b>SECTION - 2 - PREPARATION AND INSPECTION</b>			
2.1 PERSONNEL TRAINING.....	2-1		



## TABLE OF CONTENTS

SECTION - PARAGRAPH, SUBJECT	PAGE	SECTION - PARAGRAPH, SUBJECT	PAGE
LIMITATIONS .....	4-1	Telescope The Main Boom .....	4-17
Capacities .....	4-1	Platform Rotation .....	4-17
Stability .....	4-1	Raise And Lower The Jib .....	4-17
4.3 ENGINE OPERATION .....	4-2	SkyGuard Operation (If Equipped) .....	4-19
Gas Engine Starting Procedure .....	4-2	4.8 PLATFORM REMOVAL/INSTALLATION .....	4-20
Gas Engine Shutdown Procedure .....	4-3	4.9 BATTERY CHARGING - GAS/AC-ELECTRIC .....	4-21
Electric Engine Starting Procedure -		Battery Charging - Daily .....	4-21
AC Voltage Machine .....	4-4	4.10 BATTERY CHARGING - LITHIUM-ION MACHINE .....	4-22
Electric Engine Starting Procedure -		Charging the Battery Pack .....	4-22
LITHIUM-ION Machine .....	4-5	Charge Curve .....	4-24
4.4 BASE AND BOOM/JIB ALIGNMENT .....	4-6	4.11 SHUT DOWN AND PARK .....	4-25
4.5 TRACKS - DRIVING, STEERING AND		4.12 LIFTING AND TIE DOWN .....	4-26
TRACK WIDTH ADJUST .....	4-7	Lifting - Outrigger Lifting Rings .....	4-26
Track Width Adjust .....	4-7	Lifting - Fork Lift Pockets .....	4-29
Travelling (Drive and Steer) .....	4-7	Loading and Unloading the Machine on	
Travelling (Grades and Side Slopes) .....	4-7	Transport Vehicles Using Ramps .....	4-30
Jib Position for Travelling .....	4-10	Tie Down .....	4-31
4.6 OUTRIGGER OPERATION .....	4-11	4.13 MACHINE DECALS .....	4-33
Setting Outriggers From the			
Platform/Remote Console .....	4-13		
Retracting The Outriggers .....	4-14		
4.7 BOOM/PLATFORM OPERATION .....	4-15		
Overload Alarm .....	4-15		
Engine Pre-Heat .....	4-15		
Platform Level Adjustment .....	4-15		
Raise And Lower The Tower Boom .....	4-17		
Raise And Lower The Main Boom .....	4-17		
		<b>SECTION - 5 - EMERGENCY PROCEDURES</b>	
		5.1 GENERAL .....	5-1
		5.2 INCIDENT NOTIFICATION .....	5-1
		5.3 EMERGENCY OPERATION .....	5-1
		Power Main Cut-Off Switch Location .....	5-1
		Operator Unable to Control Machine .....	5-2
		Platform or Boom Caught Overhead .....	5-2

<b>SECTION - PARAGRAPH, SUBJECT</b>	<b>PAGE</b>	<b>SECTION - PARAGRAPH, SUBJECT</b>	<b>PAGE</b>
Manual Descent with Engine Running and Electrical Power.....	5-2	Lubrication.....	6-7
Manual Descent with Engine Running but without Electrical Power (Combustion Engines Only).....	5-7	Hydraulic Oil Specifications.....	6-8
Manual Descent without Engine and Electrical Power.....	5-8	Rubber Track Maintenance/Replacement....	6-14
Outrigger/Track Movement Emergency Procedure.....	5-10	Wear Pad Inspection.....	6-17
5.4 SAFETY DEVICES BYPASS KEY USE.....	5-14	Turntable Attach Bolts.....	6-17
Using The Emergency Descent In The Case Of An Outrigger Losing Contact With The Ground.....	5-15	Battery Maintenance and Charging - Gas/AC-Electric.....	6-18
Machine Realignment Emergency Procedure.....	5-16	6.4 ELECTRIC MOTOR MAINTENANCE.....	6-19
<b>SECTION - 6 - GENERAL SPECIFICATIONS AND OPERATOR MAINTENANCE</b>		Electric Motor.....	6-19
6.1 INTRODUCTION.....	6-1	6.5 PLATFORM/REMOTE CONTROL SERVICE MENU.....	6-20
6.2 OPERATING SPECIFICATIONS.....	6-2	Service Button.....	6-20
Dimensional Data.....	6-2	Menu Input.....	6-21
Chassis.....	6-3	Errors Menu.....	6-32
Capacities.....	6-3	Working Hours Menu.....	6-32
Engine Data.....	6-4	Set-up Menu.....	6-32
Lithium-Ion Specifications.....	6-4	Joystick Menu.....	6-32
Machine Major Component Weights.....	6-5	6.6 LITHIUM-ION MACHINE ONLY - ADDITIONAL MAINTAINANCE INFORMATION.....	6-33
Performance.....	6-5	Cleaning the Machine.....	6-33
6.3 SERVICE/MAINTENANCE.....	6-6	Battery Pack System Components and Maintenance.....	6-34
		Lithium-Ion Machine Fault Codes.....	6-36
		BMS Fault Codes - (Battery Management System).....	6-39
		Battery Charger Fault Codes.....	6-40
		6.5 LITHIUM-ION BATTERY PACK - HANDLING IN DANGEROUS CONDITIONS.....	6-42

## TABLE OF CONTENTS

SECTION - PARAGRAPH, SUBJECT	PAGE	SECTION - PARAGRAPH, SUBJECT	PAGE
Procedure For Handling Hot Cells .....	6-42	<b>LIST OF FIGURES</b>	
Procedure For Handling Vented Cells.....	6-43	2-1. Daily Walk-Around Inspection .....	2-7
Procedure For Exploded Cells .....	6-45	2-2. SkyGuard™ Sensor and Override Switch Location .....	2-9
Lithium Battery Fire.....	6-46	3-1. Basic Machine Nomenclature .....	3-1
<b>SECTION - 7 - INSPECTION AND REPAIR LOG</b>		3-2. Ground Control Station - With Enable Lever.....	3-3
		3-3. Ground Control Station - With Enable Knob .....	3-3
		3-4. Ground Control Station - with Enable Lever ..	3-6
		3-5. Ground Control Station - with Enable Knob ..	3-9
		3-6. Platform/Remote Control Station .....	3-15
		4-1. Ground/Emergency Control Box .....	4-2
		4-2. Ground/Emergency Control Box .....	4-3
		4-3. Ground/Emergency Control Box - Lithium Ion .....	4-5
		4-4. Grade and Side Slope Definition .....	4-9
		4-5. Platform/Remote Control Box .....	4-16
		4-6. Platform - Load/Reach Chart - X600AJ.....	4-18
		4-7. SkyGuard™ Sensor and Override Switch Location .....	4-19
		4-8. Lifting Machine - Lifting Lugs Location.....	4-27
		4-9. Lifting Machine - Lifting Bar Rigging .....	4-28
		4-10. Lifting Machine - Fork Lift Pockets Location ..	4-29
		4-11. Machine Tie-Down Points .....	4-32
		4-12. Decal installation - Standard - Left Side.....	4-33
		4-13. Decal Installation - Standard - Right Side ...	4-34

<b>SECTION - PARAGRAPH, SUBJECT</b>	<b>PAGE</b>
4-14. Decal installation - Lithium-Ion - Left Side . . .	4-38
4-15. Decal Installation - Lithium-Ion - Right Side. . .	4-39
5-1. Platform/Remote Control Station . . . . .	5-3
5-2. Ground Control Station - with Enable Lever . . .	5-5
5-3. Ground Control Station - Boom Control Valve - with Enable Knob . . . . .	5-6
5-4. Hand Pump - At Front Of Hydraulic Tank . . . . .	5-8
5-5. Hand Pump Control Decal . . . . .	5-8
5-6. Ground Component Valves - Outriggers/ Track Control - Location . . . . .	5-13
6-1. Lubrication and Maintenance Point Locations . . . . .	6-6
6-2. Hydraulic Oil Specifications . . . . .	6-8
6-3. Hydraulic Oil Operating Temperatures . . . . .	6-9
6-4. Component Maintenance Intervals - with Honda Engine . . . . .	6-10
6-5. Component Maintenance Intervals - X600AJ - Lithium-Ion Machine . . . . .	6-11
6-6. Example of Lithium-Ion Battery Pack Components . . . . .	6-34

<b>SECTION - PARAGRAPH, SUBJECT</b>	<b>PAGE</b>
-------------------------------------	-------------

**LIST OF TABLES**

1-1	Minimum Approach Distances (M.A.D.) . . . . .	1-6
1-2	Beaufort Scale (For Reference Only). . . . .	1-8
2-1	Inspection and Maintenance Table . . . . .	2-3
3-1	LCD Display Icon Descriptions . . . . .	3-20
3-2	LCD Display Error Descriptions. . . . .	3-22
4-1	SkyGuard™ Function Table . . . . .	4-19
4-2	X600AJ - Decal Installation -Standard . . . . .	4-35
4-3	X600AJ - Decal Installation - Lithium Machine . . . . .	4-40
6-1	Operating Specifications . . . . .	6-2
6-2	Dimensional Data . . . . .	6-2
6-3	Chassis Data . . . . .	6-3
6-4	Capacities. . . . .	6-3
6-5	Honda iGX440 Specifications . . . . .	6-4
6-6	Lithium Ion Specifications . . . . .	6-4
6-7	Major Component Weights. . . . .	6-5
6-8	Function Speeds . . . . .	6-5
6-9	Hydraulic Oil Specifications. . . . .	6-7
6-10	Inverter Fault Codes. . . . .	6-36
6-11	Battery Charger Fault Codes . . . . .	6-40

**TO PURCHASE THIS PRODUCT PLEASE CONTACT US**



**Equipment Financing and  
Extended Warranties Available**



**Discount-Equipment.com is your online resource for  
commercial and industrial quality parts and equipment sales.**

**561-964-4949**

**visit us on line @ [www.discount-equipment.com](http://www.discount-equipment.com)**

Select an option below to find your Equipment

**Search by Manufacturer**

**Search by Product Type**

**Request a Quote**

We sell worldwide for the brands: Genie, Terex, JLG, MultiQuip, Mikasa, Essick, Whiteman, Mayco, Toro Stone, Diamond Products, Generac Magnum, Airman, Haulotte, Barreto, Power Blanket, Nifty Lift, Atlas Copco, Chicago Pneumatic, Allmand, Miller Curber, Skyjack, Lull, Skytrak, Tsurumi, Husquvarna Target, Stow, Wacker, Sakai, Mi-T-M, Sullair, Basic, Dynapac, MBW, Weber, Bartell, Bennar Newman, Haulotte, Ditch Runner, Menegotti, Morrison, Contec, Buddy, Crown, Edco, Wyco, Bomag, Laymor, EZ Trench, Bil-Jax, F.S. Curtis, Gehl Pavers, Heli, Honda, ICS/PowerGrit, IHI, Partner, Imer, Clipper, MMD, Koshin, Rice, CH&E, General Equipment, Amida, Coleman, NAC, Gradall, Square Shooter, Kent, Stanley, Tamco, Toku, Hatz, Kohler, Robin, Wisconsin, Northrock, Oztec, Toker TK, Rol-Air, APT, Wylie, Ingersoll Rand / Doosan, Innovatech, Con X, Ammann, Mecalac, Makinex, Smith Surface Prep, Small Line, Wanco, Yanmar

## SECTION 1. SAFETY PRECAUTIONS

### 1.1 GENERAL

This section outlines the necessary precautions for proper and safe machine usage and maintenance. It is mandatory that a daily routine is established based on the content of this manual to promote proper machine usage. A maintenance program, using the information provided in this manual and the Service and Maintenance Manual, must also be established by a qualified person and must be followed to ensure that the machine is safe to operate.

The owner/user/operator/lessor/lessee of the machine must not accept operating responsibility until this manual has been read, training is accomplished, and operation of the machine has been completed under the supervision of an experienced and qualified operator.

This section contains the responsibilities of the owner, user, operator, lessor, and lessee concerning safety, training, inspection, maintenance, application, and operation. If there are any questions with regard to safety, training, inspection, maintenance, application, and operation, please contact JLG Industries, Inc. ("JLG").

### **⚠ WARNING**

**FAILURE TO COMPLY WITH THE SAFETY PRECAUTIONS LISTED IN THIS MANUAL COULD RESULT IN MACHINE DAMAGE, PROPERTY DAMAGE, PERSONAL INJURY OR DEATH.**

### 1.2 PRE-OPERATION

#### Operator Training and Knowledge

- The Operation and Safety Manual must be read and understood in its entirety before operating the machine. For clarification, questions, or additional information regarding any portions of this manual, contact JLG Industries, Inc.

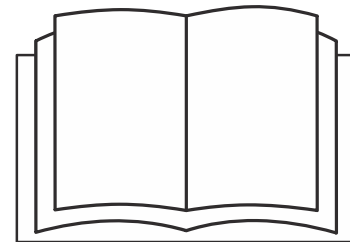

## **SECTION 1 - SAFETY PRECAUTIONS**

---

- An operator must not accept operating responsibilities until adequate training has been given by competent and authorized persons.
- Allow only those authorized and qualified personnel to operate the machine who have demonstrated that they understand the safe and proper operation and maintenance of the unit.
- Read, understand, and obey all DANGERS, WARNINGS, CAUTIONS, and operating instructions on the machine and in this manual.
- Ensure that the machine is to be used in a manner which is within the scope of its intended application as determined by JLG.
- All operating personnel must be familiar with the emergency controls and emergency operation of the machine as specified in this manual.
- Read, understand, and obey all applicable employer, local, and governmental regulations as they pertain to your utilization and application of the machine.

### **Workplace Inspection**

- Precautions to avoid all hazards in the work area must be taken by the user before and during operation of the machine.
- Do not operate or raise the platform from a position on trucks, trailers, railway cars, floating vessels, scaffolds or other equipment unless the application is approved in writing by JLG.
- Before operation, check work area for overhead hazards such as electric lines, bridge cranes, and other potential overhead obstructions.
- Check operating surfaces for holes, bumps, drop-offs, obstructions, debris, concealed holes, and other potential hazards.
- Check the work area for hazardous locations. Do not operate the machine in hazardous environments unless approved for that purpose by JLG.
- Ensure that the ground conditions are adequate to support the maximum outrigger load indicated on the outrigger load decals located on the machine. Do not travel on unsupported surfaces.

### Machine Inspection

- Do not operate this machine until the inspections and functional checks as specified in Section 2 of this manual have been performed.
- Do not operate this machine until it has been serviced and maintained according to the maintenance and inspection requirements as specified in the machine's Service and Maintenance Manual.
- Ensure all safety devices are operating properly. Modification of these devices is a safety violation.

### **WARNING**

**MODIFICATION OR ALTERATION OF AN AERIAL WORK PLATFORM SHALL BE MADE ONLY WITH PRIOR WRITTEN PERMISSION FROM THE MANUFACTURER.**

- Do not operate any machine on which the safety or instruction placards or decals are missing or illegible.
- Check the machine for modifications to original components. Ensure that any modifications have been approved by JLG.
- Avoid accumulation of debris on platform floor. Keep mud, oil, grease, and other slippery substances from footwear and platform floor.

### 1.3 OPERATION

#### General

- Machine operation requires your full attention. Bring the machine to a full stop before using any device, i.e. cell phones, two-way radios, etc. that will distract your attention from safely operating the machine.
- Do not use the machine for any purpose other than positioning personnel, their tools, and equipment.
- Before operation, the user must be familiar with the machine capabilities and operating characteristics of all functions.
- Never operate a malfunctioning machine. If a malfunction occurs, shut down the machine. Remove the unit from service and notify the proper authorities.
- Do not remove, modify, or disable any safety devices.
- Never slam a control switch or lever through neutral to an opposite direction. Always return switch to neutral and stop before moving the switch to the next function. Operate controls with slow and even pressure.



## SECTION 1 - SAFETY PRECAUTIONS

---

- Do not allow personnel to tamper with or operate the machine from the ground with personnel in the platform, except in an emergency.
- Do not carry materials directly on platform railing unless approved by JLG.
- When two or more persons are in the platform, the operator shall be responsible for all machine operations.
- Always ensure that power tools are properly stowed and never left hanging by their cord from the platform work area.
- When driving, always position boom over rear axle in line with the direction of travel. Remember, if boom is over the front axle, steer and drive functions will be reversed.
- Do not assist a stuck or disabled machine by pushing or pulling except by pulling at the chassis tie-down lugs.
- Fully lower platform and shut off all power before leaving machine.
- Remove all rings, watches, and jewelry when operating machine. Do not wear loose fitting clothing or long hair unrestrained which may become caught or entangled in equipment.

- Persons under the influence of drugs or alcohol or who are subject to seizures, dizziness or loss of physical control must not operate this machine.

### Trip and Fall Hazards

- During operation, occupants in the platform must wear a full body harness with a lanyard attached to an authorized lanyard anchorage point. Attach only one (1) lanyard per lanyard anchorage point..

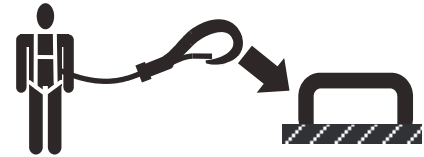

- Enter and exit only through gate area. Use extreme caution when entering or leaving platform. Ensure that the platform assembly is fully lowered. Face the machine when entering or leaving the platform. Always maintain "three point contact" with the machine, using two hands and one foot or two feet and one hand at all times during entry and exit.

- Before operating the machine, make sure all gates are closed and fastened in their proper position.

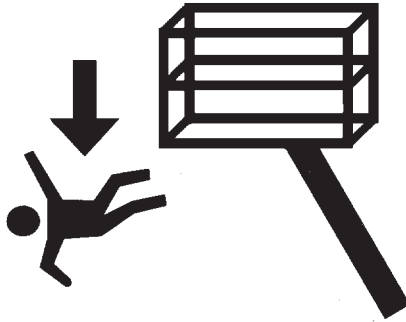

- Keep both feet firmly positioned on the platform floor at all times. Never position ladders, boxes, steps, planks, or similar items on unit to provide additional reach for any purpose.
- Keep oil, mud, and slippery substances cleaned from footwear and the platform floor.

### Electrocution Hazards

- This machine is not insulated and does not provide protection from contact or proximity to electrical current.

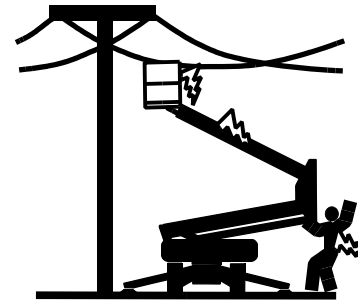
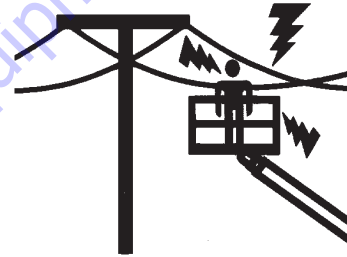

## SECTION 1 - SAFETY PRECAUTIONS

- Maintain distance from electrical lines, apparatus, or any energized (exposed or insulated) parts according to the Minimum Approach Distance (MAD) as shown in Table 1-1.
- Allow for machine movement and electrical line swaying.

**Table 1-1. Minimum Approach Distances (M.A.D.)**

Voltage Range (Phase to Phase)	MINIMUM APPROACH DISTANCE in Feet (Meters)
0 to 50 KV	10 (3)
Over 50KV to 200 KV	15 (5)
Over 200KV to 350 KV	20 (6)
Over 350KV to 500 KV	25 (8)
Over 500KV to 750 KV	35 (11)
Over 750 KV to 1000 KV	45 (14)

**NOTE:** *This requirement shall apply except where employer, local or governmental regulations are more stringent.*

- Maintain a clearance of at least 10 ft. (3m) between any part of the machine and its occupants, their tools, and their equipment from any electrical line or apparatus carrying up to 50,000 volts. One foot addi-

tional clearance is required for every additional 30,000 volts or less.

- The minimum approach distance may be reduced if insulating barriers are installed to prevent contact, and the barriers are rated for the voltage of the line being guarded. These barriers shall not be part of (or attached to) the machine. The minimum approach distance shall be reduced to a distance within the designed working dimensions of the insulating barrier. This determination shall be made by a qualified person in accordance with the employer, local, or governmental requirements for work practices near energized equipment

### **DANGER**

**DO NOT MANEUVER MACHINE OR PERSONNEL INSIDE PROHIBITED ZONE (MAD). ASSUME ALL ELECTRICAL PARTS AND WIRING ARE ENERGIZED UNLESS KNOWN OTHERWISE.**

### Tipping Hazards

- The user must be familiar with the surface before driving. Do not exceed the allowable sideslope and grade while driving.

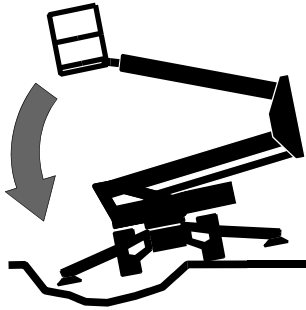

- Do not elevate platform or drive with platform elevated while on or near a sloping, uneven, or soft surface. Ensure machine is positioned on a firm, level and smooth surface before elevating platform or driving with the platform in the elevated position.
- Before driving on floors, bridges, trucks, and other surfaces, check allowable capacity of the surfaces.
- Do not raise the platform unless the machine is on firm surfaces and outriggers are properly set.

- Never exceed the maximum work load as specified on the platform. Keep all loads within the confines of the platform, unless authorized by JLG.
- Keep the chassis and outriggers of the machine a minimum of 2 ft. (0.6m) from holes, bumps, drop-offs, obstructions, debris, concealed holes, and other potential hazards at the ground level.
- Do not push or pull any object with the boom.
- Never attempt to use the machine as a crane. Do not tie-off machine to any adjacent structure. Never attach wire, cable, or any similar items to platform.
- Do not operate the machine when wind conditions exceed 28 mph (12.5 m/s). Refer to Table 1-2, Beaufort Scale (For Reference Only).
- Do not increase the surface area of the platform or the load. Increase of the area exposed to the wind will decrease stability.
- Do not increase the platform size with unauthorized deck extensions or attachments.
- If boom assembly or platform is in a position that one or more outriggers are off the ground, all persons must be removed before attempting to stabilize the machine. Use cranes, forklift trucks, or other appropriate equipment to stabilize machine.

## SECTION 1 - SAFETY PRECAUTIONS

### NOTICE

DO NOT OPERATE THE MACHINE WHEN WIND CONDITIONS EXCEED 28 MPH (12.5 M/S).

Table 1-2. Beaufort Scale (For Reference Only)

Beaufort Number	Wind Speed		Description	Land Conditions
	mph	m/s		
0	0	0-0.2	Calm	Calm. Smoke rises vertically
1	1-3	0.3-1.5	Light air	Wind motion visible in smoke
2	4-7	1.6-3.3	Light breeze	Wind felt on exposed skin. Leaves rustle
3	8-12	3.4-5.4	Gentle breeze	Leaves and smaller twigs in constant motion
4	13-18	5.5-7.9	Moderate breeze	Dust and loose paper raised. Small branches begin to move.
5	19-24	8.0-10.7	Fresh breeze	Smaller trees sway.
6	25-31	10.8-13.8	Strong breeze	Large branches in motion. Flags waving near horizontal. Umbrella use becomes difficult.
7	32-38	13.9-17.1	Near Gale/Moderate Gale	Whole trees in motion. Effort needed to walk against the wind.
8	39-46	17.2-20.7	Fresh Gale	Twigs broken from trees. Cars veer on road.
9	47-54	20.8-24.4	Strong Gale	Light structure damage.

### Crushing and Collision Hazards

- Approved head gear must be worn by all operating and ground personnel.
- Check work area for clearances overhead, on sides, and bottom of platform when lifting or lowering platform, and driving.

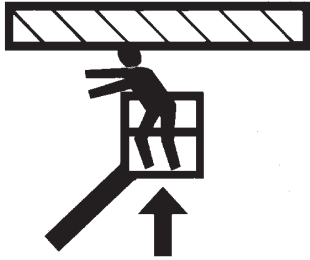

- During operation, keep all body parts inside platform railing.
- Use the boom functions, not the drive function, to position the platform close to obstacles.
- Always post a lookout when driving in areas where vision is obstructed.
- Keep non-operating personnel at least 6 ft. (1.8m) away from machine during all driving and swing operations.

- Under all travel conditions, the operator must limit travel speed according to conditions of ground surface, congestion, visibility, slope, location of personnel, and other factors which may cause collision or injury to personnel.
- Be aware of stopping distances in all drive speeds. When driving in high speed, switch to low speed before stopping. Travel grades in low speed only.
- Do not use high speed drive in restricted or close quarters or when driving in reverse.
- Exercise extreme caution at all times to prevent obstacles from striking or interfering with operating controls and persons in the platform.
- Be sure that operators of other overhead and floor level machines are aware of the aerial work platform's presence. Disconnect power to overhead cranes.
- Warn personnel not to work, stand, or walk under a raised boom or platform. Position barricades on floor if necessary.

## **SECTION 1 - SAFETY PRECAUTIONS**

---

### **1.4 TOWING, LIFTING, AND HAULING**

- Never allow personnel in platform while towing, lifting, or hauling.
- Ensure boom is in the stowed position and the turntable locked prior to towing, lifting or hauling. The platform must be completely empty of tools.
- When lifting machine, lift only at designated areas of the machine. Lift the unit with equipment of adequate capacity.
- Refer to the Machine Operation section of this manual for lifting information.

### **1.5 MAINTENANCE**

This sub-section contains general safety precautions which must be observed during maintenance of this machine. Additional precautions to be observed during machine maintenance are inserted at the appropriate points in this manual and in the Service and Maintenance Manual. It is of utmost importance that maintenance personnel pay strict attention to these precautions to avoid possible injury to personnel or damage to the machine or property. A maintenance program must be established by a qualified person and must be followed to ensure that the machine is safe.

#### **Maintenance Hazards**

- Shut off power to all controls and ensure that all moving parts are secured from inadvertent motion prior to performing any adjustments or repairs.
- Never work under an elevated platform until it has been fully lowered to the full down position, if possible, or otherwise supported and restrained from movement with appropriate safety props, blocking, or overhead supports.
- DO NOT attempt to repair or tighten any hydraulic hoses or fittings while the machine is powered on or when the hydraulic system is under pressure.

## SECTION 1 - SAFETY PRECAUTIONS

- Always relieve hydraulic pressure from all hydraulic circuits before loosening or removing hydraulic components.
- DO NOT use your hand to check for leaks. Use a piece of cardboard or paper to search for leaks. Wear gloves to help protect hands from spraying fluid.



- Ensure replacement parts or components are identical or equivalent to original parts or components.
- Never attempt to move heavy parts without the aid of a mechanical device. Do not allow heavy objects to rest in an unstable position. Ensure adequate support is provided when raising components of the machine.
- Do not use machine as a ground for welding.

- When performing welding or metal cutting operations, precautions must be taken to protect the chassis from direct exposure to weld and metal cutting spatter.
- Do not refuel the machine with the engine running.
- Use only approved non-flammable cleaning solvents.
- Do not replace items critical to stability, such as batteries or solid tires, with items of different weight or specification. Do not modify unit in any way to affect stability.
- Refer to the Service and Maintenance Manual for the weights of critical stability items.

### **⚠ WARNING**

**MODIFICATION OR ALTERATION OF AN AERIAL WORK PLATFORM SHALL BE MADE ONLY WITH PRIOR WRITTEN PERMISSION FROM THE MANUFACTURER.**



## SECTION 1 - SAFETY PRECAUTIONS

---

### Battery Hazards

- Always disconnect batteries when servicing electrical components or when performing welding on the machine.
- Do not allow smoking, open flame, or sparks near battery during charging or servicing.
- Do not contact tools or other metal objects across the battery terminals.
- Always wear hand, eye, and face protection when servicing batteries. Ensure that battery acid does not come in contact with skin or clothing.

### CAUTION

**BATTERY FLUID IS HIGHLY CORROSIVE. AVOID CONTACT WITH SKIN AND CLOTHING AT ALL TIMES. IMMEDIATELY RINSE ANY CONTACTED AREA WITH CLEAN WATER AND SEEK MEDICAL ATTENTION.**

- Charge batteries only in a well ventilated area.
- Avoid overfilling the battery fluid level. Add distilled water to batteries only after the batteries are fully charged.

**TO PURCHASE THIS PRODUCT PLEASE CONTACT US**



**Equipment Financing and  
Extended Warranties Available**



**Discount-Equipment.com is your online resource for  
commercial and industrial quality parts and equipment sales.**

**561-964-4949**

**visit us on line @ [www.discount-equipment.com](http://www.discount-equipment.com)**

Select an option below to find your Equipment

**Search by Manufacturer**

**Search by Product Type**

**Request a Quote**

We sell worldwide for the brands: Genie, Terex, JLG, MultiQuip, Mikasa, Essick, Whiteman, Mayco, Toro Stone, Diamond Products, Generac Magnum, Airman, Haulotte, Barreto, Power Blanket, Nifty Lift, Atlas Copco, Chicago Pneumatic, Allmand, Miller Curber, Skyjack, Lull, Skytrak, Tsurumi, Husquvarna Target, Stow, Wacker, Sakai, Mi-T-M, Sullair, Basic, Dynapac, MBW, Weber, Bartell, Bennar Newman, Haulotte, Ditch Runner, Menegotti, Morrison, Contec, Buddy, Crown, Edco, Wyco, Bomag, Laymor, EZ Trench, Bil-Jax, F.S. Curtis, Gehl Pavers, Heli, Honda, ICS/PowerGrit, IHI, Partner, Imer, Clipper, MMD, Koshin, Rice, CH&E, General Equipment, Amida, Coleman, NAC, Gradall, Square Shooter, Kent, Stanley, Tamco, Toku, Hatz, Kohler, Robin, Wisconsin, Northrock, Oztec, Toker TK, Rol-Air, APT, Wylie, Ingersoll Rand / Doosan, Innovatech, Con X, Ammann, Mecalac, Makinex, Smith Surface Prep, Small Line, Wanco, Yanmar

## **SECTION 2. PREPARATION AND INSPECTION**

### **2.1 PERSONNEL TRAINING**

The aerial platform is a personnel handling device; so it is necessary that it be operated and maintained only by trained personnel.

Persons under the influence of drugs or alcohol or who are subject to seizures, dizziness or loss of physical control must not operate this machine.

#### **Operator Training**

Operator training must cover:

1. Use and limitations of the controls in the platform and at the ground, emergency controls and safety systems.
2. Control labels, instructions, and warnings on the machine.
3. Rules of the employer and government regulations.
4. Use of approved fall protection device.
5. Enough knowledge of the mechanical operation of the machine to recognize a malfunction or potential malfunction.

6. The safest means to operate the machine where overhead obstructions, other moving equipment, obstacles, depressions, holes, and drop-offs exist.
7. Means to avoid the hazards of unprotected electrical conductors.
8. Specific job requirements or machine application.

#### **Training Supervision**

Training must be done under the supervision of a qualified person in an open area free of obstructions until the trainee has developed the ability to safely control and operate the machine.

#### **Operator Responsibility**

The operator must be instructed that he/she has the responsibility and authority to shut down the machine in case of a malfunction or other unsafe condition of either the machine or the job site.

## **SECTION 2 - PREPARATION AND INSPECTION**

---

### **2.2 PREPARATION, INSPECTION, AND MAINTENANCE**

The following table covers the periodic machine inspections and maintenance required by JLG Industries, Inc. Consult local regulations for further requirements for aerial work platforms. The frequency of inspections and maintenance must be increased as necessary when the machine is used in a harsh or hostile environment, if the machine is used with increased frequency, or if the machine is used in a severe manner.

#### **NOTICE**

**JLG INDUSTRIES, INC. RECOGNIZES A FACTORY TRAINED SERVICE TECHNICIAN AS A PERSON WHO HAS SUCCESSFULLY COMPLETED THE JLG SERVICE TRAINING SCHOOL FOR THE SPECIFIC JLG PRODUCT MODEL.**

## SECTION 2 - PREPARATION AND INSPECTION

**Table 2-1. Inspection and Maintenance Table**

Type	Frequency	Primary Responsibility	Service Qualification	Reference
Pre-Start Inspection	Before using each day; or whenever there's an Operator change.	User or Operator	User or Operator	Operation and Safety Manual
Pre-Delivery Inspection (See Note)	Before each sale, lease, or rental delivery.	Owner, Dealer, or User	Qualified JLG Mechanic	Service and Maintenance Manual and applicable JLG inspection form
Frequent Inspection	In service for 3 months or 150 hours, whichever comes first; or Out of service for a period of more than 3 months; or Purchased used.	Owner, Dealer, or User	Qualified JLG Mechanic	Service and Maintenance Manual and applicable JLG inspection form
Annual Machine Inspection	Annually, no later than 13 months from the date of prior inspection.	Owner, Dealer, or User	Factory Trained Service Technician (Recommended)	Service and Maintenance Manual and applicable JLG inspection form
Preventative Maintenance	At intervals as specified in the Service and Maintenance Manual.	Owner, Dealer, or User	Qualified JLG Mechanic	Service and Maintenance Manual
<b>NOTE:</b> Inspection forms are available from JLG. Refer to Section 6 - Operators Maintenance when performing inspections.				

## SECTION 2 - PREPARATION AND INSPECTION

### Pre-Start Inspection

The Pre-Start Inspection should include each of the following:

1. **Cleanliness** – Check all surfaces for leakage (oil, fuel, or battery fluid) or foreign objects. Report any leakage to the proper maintenance personnel.
2. **Structure** - Inspect the machine structure for dents, damage, weld or parent metal cracks or other discrepancies.

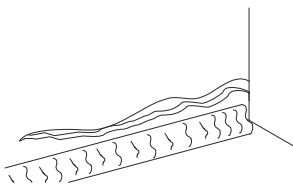

Parent Metal Crack

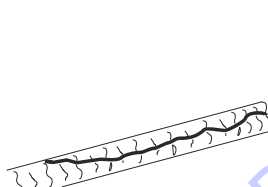

Weld Crack

3. **Decals and Placards** – Check all for cleanliness and legibility. Make sure none of the decals and placards are missing. Make sure all illegible decals and placards are cleaned or replaced.
4. **Operation and Safety Manuals** – Make sure a copy of the Operation and Safety Manual, AEM Safety Manual (ANSI markets only), and ANSI Manual of Responsibilities (ANSI markets only) is

enclosed in the weather resistant storage container.

5. **Walk-Around Inspection** – Refer to Figure 2-1.
6. **Battery** – Charge as required.
7. **Fuel** (Combustion Engine Powered Machines) – Add the proper fuel as necessary.
8. **Engine Oil Supply** (Combustion Engine Powered Machines) - Ensure the engine oil level is at the Full mark on the dipstick and the filler cap is secure.
9. **Hydraulic Oil** – Check the hydraulic oil level. Ensure hydraulic oil is added as required.
10. **Accessories/Attachments** - Reference the Operation and Safety Manual of each attachment or accessory installed upon the machine for specific inspection, operation, and maintenance instructions.
11. **Function Check** – Once the “Walk-Around” Inspection is complete, perform a functional check of all systems in an area free of overhead and ground level obstructions. Refer to Section 4 for more specific operating instructions.

**⚠ WARNING**

IF THE MACHINE DOES NOT OPERATE PROPERLY, TURN OFF THE MACHINE IMMEDIATELY! REPORT THE PROBLEM TO THE PROPER MAINTENANCE PERSONNEL. DO NOT OPERATE THE MACHINE UNTIL IT IS DECLARED SAFE FOR OPERATION.

**NOTICE**

MAKE SURE THE ENGINE KEY SWITCH IS ON, THE BATTERY DISCONNECT SWITCH IS TURNED ON, AND THE POWER/EMERGENCY STOP BUTTONS AT THE GROUND AND PLATFORM CONTROL BOX IS TURNED CLOCKWISE (ON).

To order go to [Discount-Equipment.com](http://Discount-Equipment.com)

## SECTION 2 - PREPARATION AND INSPECTION

---

### Daily Walk-Around Inspection

#### General

Begin the "Walk-Around Inspection" at Item 1, as noted on the diagram. Continue checking each item in sequence for the conditions listed in the following checklist.

#### **WARNING**

**TO AVOID POSSIBLE INJURY, BE SURE MACHINE POWER IS OFF.**

**DO NOT OPERATE MACHINE UNTIL ALL MALFUNCTIONS HAVE BEEN CORRECTED.**

**INSPECTION NOTE:** *On all components, make sure there are no loose or missing parts, that they are securely fastened, and no visible damage, leaks or excessive wear exists in addition to any other criteria mentioned.*

- 1. Platform Assembly, Footswitch, Ladder and Gate** - Footswitch in good working order, not modified, disabled or blocked. Manuals in storage container, access bar slides up and down properly, platform properly installed and with both caps screwed on. See Inspection Note.

- 2. Platform/Remote Control Station** - Switches and levers return to neutral, decals/placards secure and legible, control markings legible.
- 3. Platform Rotator & Machine Bubble Level** - See Inspection Note.
- 4. Outriggers** - See Inspection Note; pads pivot freely.
- 5. Electrical Components/Cover Assembly** - See Inspection Note.
- 6. Boom Sections & Ground Control Station** - See Inspection Note.
- 7. Drive Tracks** - Properly Adjusted. See Inspection Note.
- 8. Gas/Diesel Engine & Main Hydraulic Pump, Lithium ION Battery Pack** - Free of debris and See Inspection Note.
- 9. Swing Drive & Turntable Bearing**- Check for proper lubrication. See Inspection Note.
- 10. Hydraulic Tank and Hand Pump Assembly** - Hydraulic oil level correct and See Inspection Note.
- 11. Electric Motor and Ground Components Hydraulic Valve Sets** - See Inspection Note.



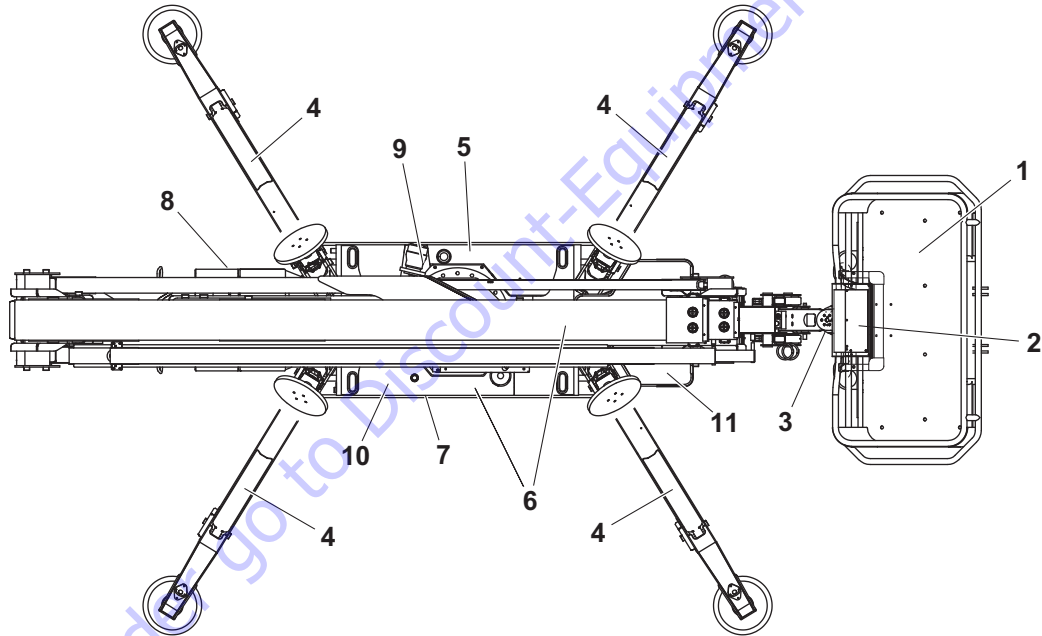

Figure 2-1. Daily Walk-Around Inspection

### Function Check

#### **WARNING**

#### **ENSURE NO FUNCTIONS (EXCEPT TRACK FUNCTIONS) OPERATE WHEN THE OUTRIGGERS ARE NOT PROPERLY SET.**

After properly setting up on outriggers, perform the function check as follows:

1. From the ground control console with no load in the platform:
  - a. Check that all guards protecting the function control switches and controllers are in place.
  - b. Operate all functions.
  - c. Ensure all machine functions are disabled when Emergency Stop Button is pushed in.
  - d. Ensure all boom functions stop when the function enable switch is released.
2. From the platform control console:
  - a. Ensure that the control console is firmly secured in the proper location.
  - b. Check that all guards protecting the function control switches and controllers are in place;
  - c. Operate all functions.
  - d. Ensure all boom functions stop when the foot switch is released.
3. SkyGuard™ Function Test (If Equipped)
  - e. Ensure all machine functions are disabled when Emergency Stop Button is pushed in.
  - f. Ensure main lift down, tower lift down, and jib lift down, work properly when using the emergency lowering controls.

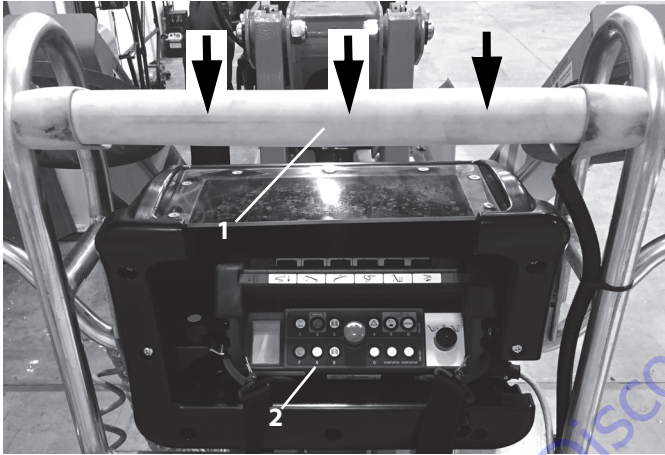

1. SkyGuard™ Sensor

2. SkyGuard™ Override Switch  
(button number 8)

**Figure 2-2. SkyGuard™ Sensor and Override Switch  
Location**

**TO PURCHASE THIS PRODUCT PLEASE CONTACT US**



**Equipment Financing and  
Extended Warranties Available**



**Discount-Equipment.com is your online resource for  
commercial and industrial quality parts and equipment sales.**

**561-964-4949**

**visit us on line @ [www.discount-equipment.com](http://www.discount-equipment.com)**

Select an option below to find your Equipment

**Search by Manufacturer**

**Search by Product Type**

**Request a Quote**

We sell worldwide for the brands: Genie, Terex, JLG, MultiQuip, Mikasa, Essick, Whiteman, Mayco, Toro Stone, Diamond Products, Generac Magnum, Airman, Haulotte, Barreto, Power Blanket, Nifty Lift, Atlas Copco, Chicago Pneumatic, Allmand, Miller Curber, Skyjack, Lull, Skytrak, Tsurumi, Husquvarna Target, Stow, Wacker, Sakai, Mi-T-M, Sullair, Basic, Dynapac, MBW, Weber, Bartell, Bennar Newman, Haulotte, Ditch Runner, Menegotti, Morrison, Contec, Buddy, Crown, Edco, Wyco, Bomag, Laymor, EZ Trench, Bil-Jax, F.S. Curtis, Gehl Pavers, Heli, Honda, ICS/PowerGrit, IHI, Partner, Imer, Clipper, MMD, Koshin, Rice, CH&E, General Equipment, Amida, Coleman, NAC, Gradall, Square Shooter, Kent, Stanley, Tamco, Toku, Hatz, Kohler, Robin, Wisconsin, Northrock, Oztec, Toker TK, Rol-Air, APT, Wylie, Ingersoll Rand / Doosan, Innovatech, Con X, Ammann, Mecalac, Makinex, Smith Surface Prep, Small Line, Wanco, Yanmar

SECTION 3. MACHINE CONTROLS, INDICATORS AND OPERATION

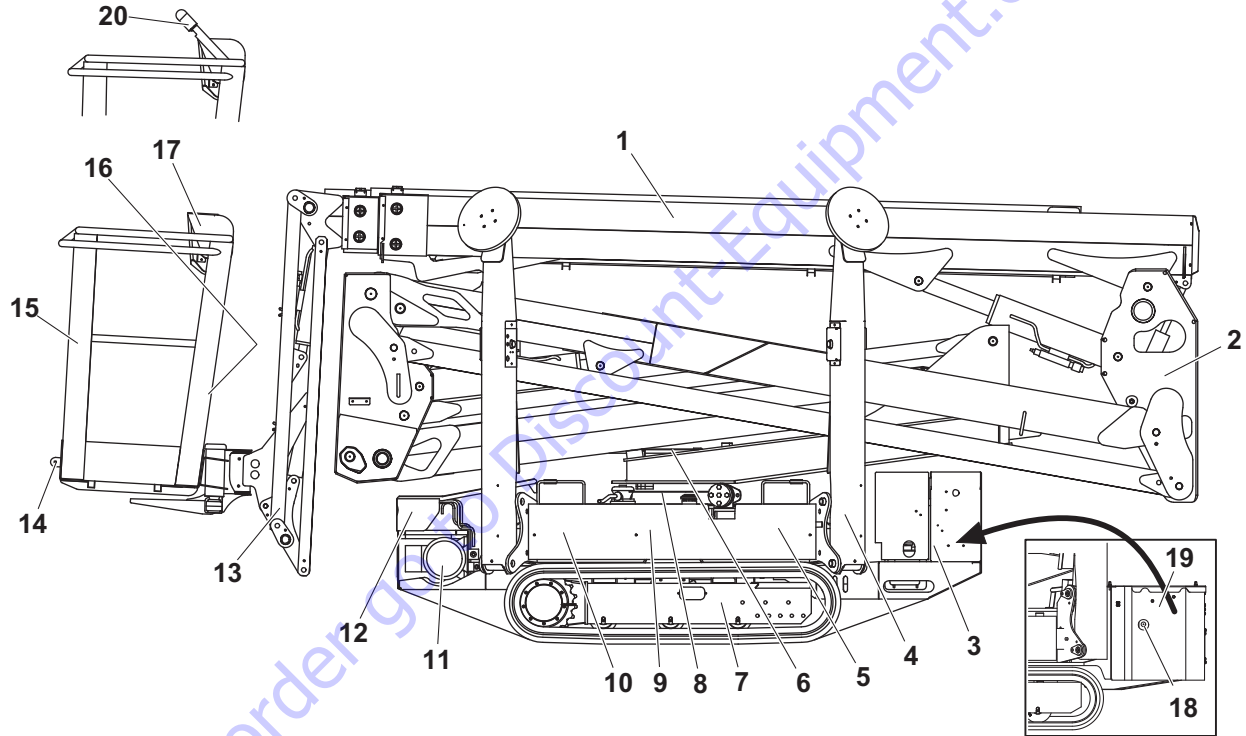

Figure 3-1. Basic Machine Nomenclature (Right Side View)

## **SECTION 3 - MACHINE CONTROLS, INDICATORS AND OPERATION**

---

### **Basic Machine Nomenclature**

- 1.** Main Boom
- 2.** Tower Boom Assembly
- 3.** Gas or Diesel Engine
- 4.** Outriggers (4 places)
- 5.** Electric Components Compartment - (Left Side of Machine)
- 6.** Ground/Emergency controls (Left Side of Machine)
- 7.** Tracked Undercarriage
- 8.** Turntable
- 9.** Hydraulic Oil tank - (Right Side of Machine)
- 10.** Hand Pump - (Right Side of Machine)
- 11.** Electric Motor
- 12.** Track and Outrigger Valves/Manual Controls - (Under Cover)
- 13.** Jib
- 14.** Platform Ladder
- 15.** Platform
- 16.** Manuals Compartment (In Platform)
- 17.** Platform/Remote Control Station
- 18.** Lithium ION - Battery Charger LED Indicator
- 19.** Lithium ION - Battery Pack, Inverter, and Battery Charger Compartment
- 20.** SkyGuard™ Sensor (If Equipped)

### 3.1 GROUND CONTROL STATION

Before operating the Ground Control Station, determine which control valve is installed on your machine.

If your ground control station looks like this with the (RED) Function Enable Lever on the left side of the valve set, See “Ground Control Station - With Enable Lever” on page 3-4.



Figure 3-2. See “Ground Control Station - With Enable Lever” on page 3-4.

If your ground control station looks like this with the (BLACK) Function Enable Knob on the right side of the valve set, See “Ground Control Station - With Enable Knob” on page 3-7.

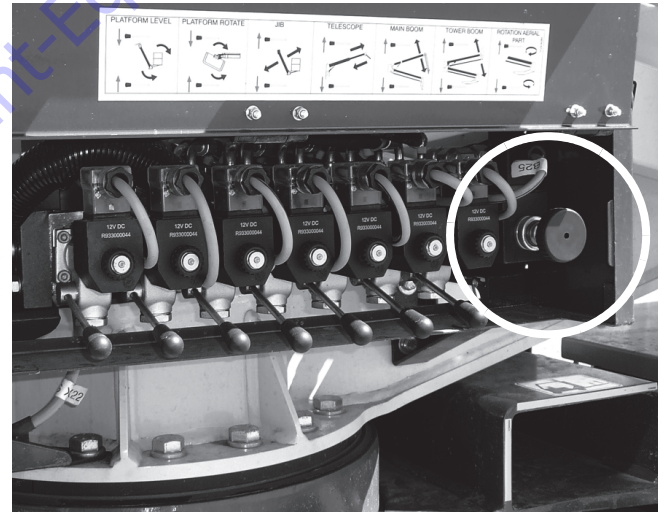

Figure 3-3. See “Ground Control Station - With Enable Knob” on page 3-7.

## SECTION 3 - MACHINE CONTROLS, INDICATORS AND OPERATION

---

### Ground Control Station - With Enable Lever

See Figure 3-4., Ground Control Station - with Enable Lever

#### **WARNING**

**TO AVOID SERIOUS INJURY, DO NOT OPERATE MACHINE IF ANY CONTROL LEVERS OR SWITCHES CONTROLLING PLATFORM MOVEMENT DO NOT RETURN TO THE OFF POSITION WHEN RELEASED.**

#### **NOTICE**

**WHEN THE MACHINE IS SHUT DOWN BOTH EMERGENCY STOP SWITCHES AND THE KEY SWITCH ON THE ENGINE MUST BE SET TO THE OFF POSITION TO PREVENT DRAINING THE BATTERY. FOR PROLONGED SHUTDOWN OR WHILE PERFORMING MAINTENANCE/REPAIRS, TURN OFF THE BATTERY DISCONNECT SWITCH.**

#### 1. Main Power Key Switch

This switch must be turned to the ON (I) position before power is supplied to the Power/Emergency Stop switch. When machine is not in use, the key can be removed in the OFF (O) position.

#### 2. Power/Emergency Stop Switch

A two-position red switch supplies power to PLATFORM/GROUND/REMOTE SELECT switch when twisted clockwise to be in the out (on) position. When pushed in (off), power is shut off to the PLATFORM and GROUND controls.

#### 3. Platform/Ground/Remote Select Switch

This three position selector switch provides power to the platform when in the center (neutral) position.

With the key switch turned clockwise and held, only the ground controls are operational.

With the key switch turned counter-clockwise, the ground control electrical connector is enabled and the platform (remote) control station can be operated from the ground position.

#### 4. Engine Start Buttons

To start the engine at the ground control, the main power key switch (*item 1*) must be set to ON, emergency stop button (*item 2*) reset to ON and set the select switch (*item 3*) in the center (neutral) position. The engine start button (*item 4*) must be pushed in until the engine starts. The button on the RIGHT is for ELECTRIC MOTOR start, the button on the LEFT is for GAS/DIESEL ENGINE start.

**NOTE:** *When the machine is not stabilized and the engine is not running, an alarm will sound to indicate that the key switch on the engine is ON. Turn OFF the key switch on the engine when not in operation.*



## SECTION 3 - MACHINE CONTROLS, INDICATORS AND OPERATION

### 5. Function Enable Light

Illuminates when outriggers are properly set and boom functions are allowed. Not illuminated indicates outriggers are not properly set and boom functions are not allowed.

### 6. Function Enable Lever

This lever must be engaged and held UP in order to operate the boom functions from the ground controls, item 7 through 13. Do not operate the boom controls unless the green light (*item 5*) is illuminated to indicate if operation is possible (*machine stabilized*) from these controls.

### 7. Swing Control

Provides swing to the left or right of the turntable/boom assembly.

### 8. Tower Boom Lift Control

Provides raising and lowering of the tower boom section.

### 9. Main Boom Lift Control

Provides raising and lowering of the main boom section.

### 10. Main Boom Telescope Control

Provides extension and retraction of the main boom section.

### 11. Jib Lift

Provides raising and lowering of the jib arms.

### 12. Platform Rotate Control

Provides rotation of the platform assembly to the right or left.

### **WARNING**

**ONLY USE THE PLATFORM LEVELING OVERRIDE FUNCTION FOR SLIGHT LEVELING OF THE PLATFORM. INCORRECT USE COULD CAUSE THE LOAD/OCCUPANT TO SHIFT OR FALL. FAILURE TO DO SO COULD RESULT IN DEATH OR SERIOUS INJURY.**

### 13. Platform Level Control

Provides for positioning the platform assembly up and down to adjust the level of the platform.

## SECTION 3 - MACHINE CONTROLS, INDICATORS AND OPERATION

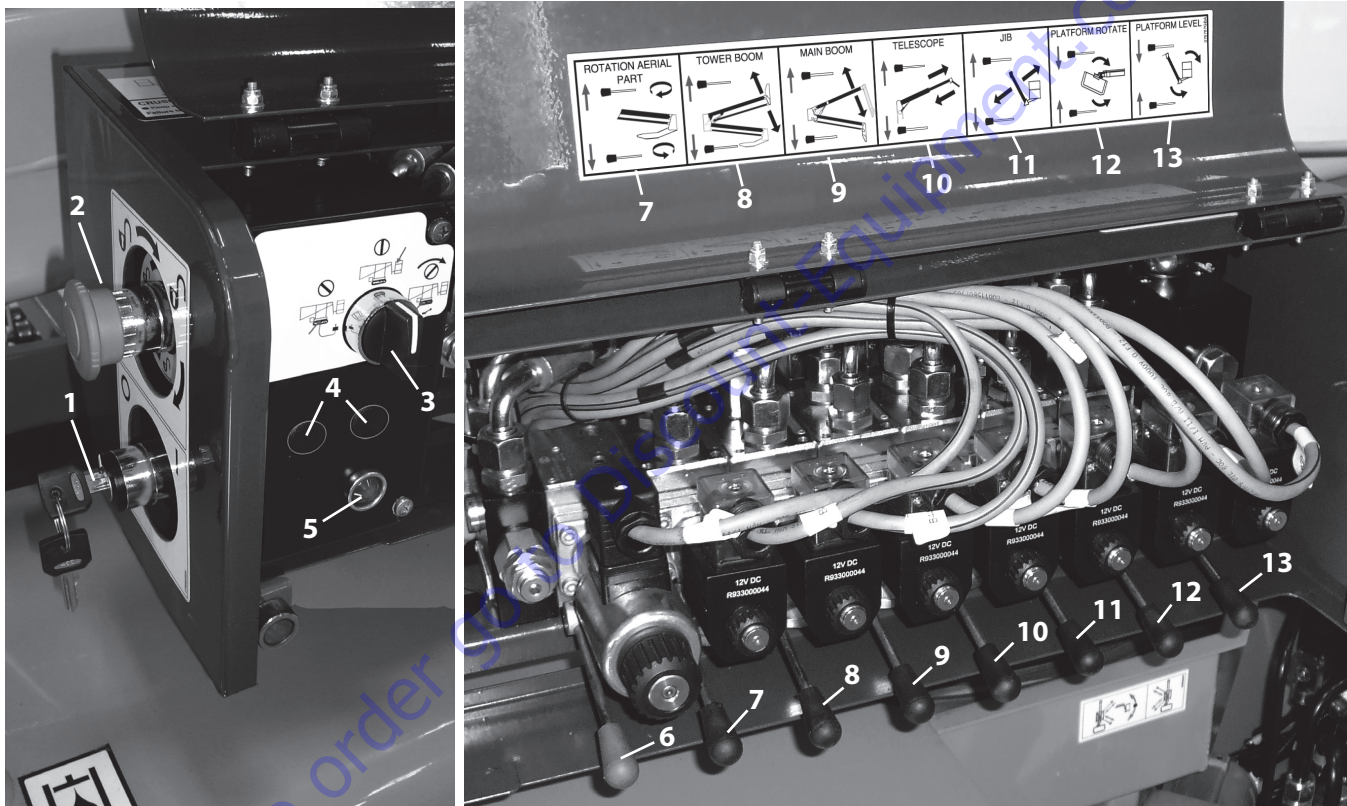

Figure 3-4. Ground Control Station - with Enable Lever

### Ground Control Station - With Enable Knob

See Figure 3-5., Ground Control Station - with Enable Knob

#### WARNING

**TO AVOID SERIOUS INJURY, DO NOT OPERATE MACHINE IF ANY CONTROL LEVERS OR SWITCHES CONTROLLING PLATFORM MOVEMENT DO NOT RETURN TO THE OFF POSITION WHEN RELEASED.**

#### NOTICE

**WHEN THE MACHINE IS SHUT DOWN BOTH EMERGENCY STOP SWITCHES AND THE KEY SWITCH ON THE ENGINE (IF EQUIPPED) MUST BE SET TO THE OFF POSITION TO PREVENT DRAINING THE BATTERY. FOR PROLONGED SHUTDOWN OR WHILE PERFORMING MAINTENANCE/REPAIRS, TURN OFF THE BATTERY DISCONNECT SWITCH.**

#### 1. Power/Emergency Stop Switch

A two-position red switch supplies power to PLATFORM/GROUND/REMOTE SELECT switch when twisted clockwise to be in the out (on) position. When pushed in (off), power is shut off to the PLATFORM and GROUND controls.

#### 2. Platform/Ground/Remote Select Switch

A three position, switch that provides power to the platform when in the center (neutral) position. With the switch turned clockwise and held, only the ground controls are operational. With the switch turned counter clockwise, the plat-

form (remote) control box may be connected to the ground/maintenance cable port located in the electrical components compartment and operated from the ground.

#### 3. Engine Start Buttons

To start the engine at the ground control, the select switch (*item 2*) must be in place and in the center (neutral) position. The engine start button (*item 3*) must be pushed in until the engine starts. The button on the RIGHT is for ELECTRIC MOTOR start, the button on the LEFT is for GAS/DIESEL ENGINE start.

**NOTE:** *When the machine is not stabilized and the engine is not running, an alarm will sound to indicate that the key switch on the engine is ON. Turn OFF the select switch on the engine when not in operation.*

#### 4. Function Enable Indicator

In order to operate the boom functions from the ground controls, *item 5* through *11*. When the select switch (*item 2*) is turned clockwise and held in that position, this green light will illuminate to indicate if operation is possible (*machine stabilized*).

## SECTION 3 - MACHINE CONTROLS, INDICATORS AND OPERATION

---

### 5. Platform Level Control

Provides for positioning the platform up and down to adjust the level of the platform.

### WARNING

**ONLY USE THE PLATFORM LEVELING OVERRIDE FUNCTION FOR SLIGHT LEVELING OF THE PLATFORM. INCORRECT USE COULD CAUSE THE LOAD/OCCUPANT TO SHIFT OR FALL. FAILURE TO DO SO COULD RESULT IN DEATH OR SERIOUS INJURY.**

### 6. Platform Rotate Control

Provides rotation the platform assembly to the right or left.

### 7. Jib Lift

Provides raising and lowering of the jib arms.

### 8. Telescope Control

Provides extension and retraction of the main boom section.

### 9. Main Boom Lift Control

Provides raising and lowering of the main boom section.

### 10. Tower Boom Lift Control

Provides raising and lowering of the tower boom section.

### 11. Swing Control

Provides swing to the left or right of the turntable/boom assembly.

### 12. Hydraulic Manual Control Valve - (Enable Knob)

This knob used during emergency ground operation (*see Section-5*), must be pressed in all the way before any of the hydraulic valve ground controls will function.

## SECTION 3 - MACHINE CONTROLS, INDICATORS AND OPERATION

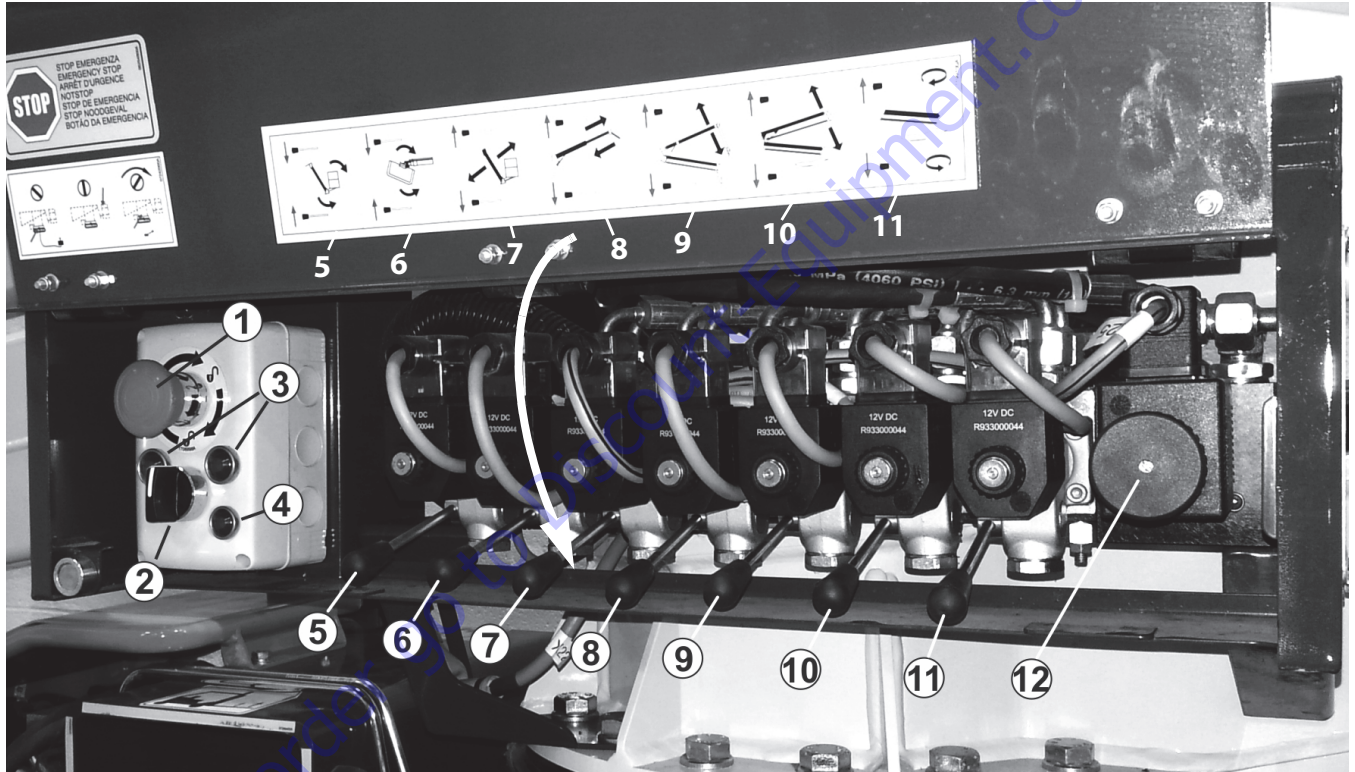

Figure 3-5. Ground Control Station - with Enable Knob

## SECTION 3 - MACHINE CONTROLS, INDICATORS AND OPERATION

### 3.2 PLATFORM/REMOTE CONTROL STATION

#### Maintenance Control Position On The Ground

This control position is for function check and maintenance only.

Do not operate the machine from this position if anyone is in the platform.

#### **⚠ WARNING**

**WHEN OPERATING THE MACHINE FROM THE GROUND POSITION KEEP AT A DISTANCE OF AT LEAST 3 FT. (1M) FROM THE TRACKS.**

Ground maintenance control position for the platform/remote control is possible by connecting the platform/remote control station using the (*optional*) service cable (*item 2*) to the service cable connector port (*item 1*) located under the small flap opening on the side of the electrical components box.

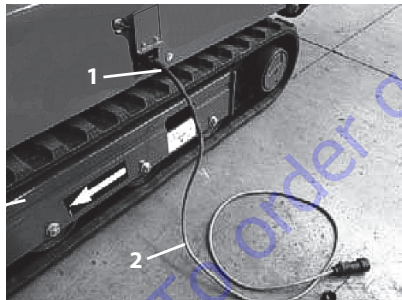

**NOTE:** Before removing or connecting the platform flex cable connector plug from the control box, depress the emergency stop buttons and the key on the engine must be in the OFF position.

1. Disconnect and remove the platform/remote control station from the platform storage box.
2. Disconnect the platform flex cable from the platform/remote control station.

**NOTE:** Before connecting the special adapter plug ensure there is no moisture in the electrical connectors at any time.

3. The special adapter supplied with the (*optional*) service cable, must be attached to the end of the platform flexible cable before the platform/remote control station will operate in the ground maintenance position.
4. Next unscrew the cable connector cover from the service port connector plug (*item 1*) on the electrical components box.
5. Attach the (*optional*) service cable (*item 2*) to the platform/remote control station.
6. Attach the other end of the service cable to the service port connector (*item 1*).

To enable this position it is necessary to have the select switch at the ground controls (*Item 2 - Figure 3-5.*) turned counterclockwise after connecting the platform/remote

control station to the ground/remote cable connector. This key switch overrides the footswitch in the platform.

### **⚠ WARNING**

**TO AVOID SERIOUS INJURY, DO NOT OPERATE MACHINE IF ANY CONTROL LEVERS OR CONTROL SWITCHES CONTROLLING PLATFORM MOVEMENT DO NOT RETURN TO THE OFF OR NEUTRAL POSITION WHEN RELEASED.**

**NOTE:** *Before removing or connecting the special adapter plug, depress the emergency stop buttons and the key on the engine must be in the OFF position.*

### **Platform/Remote Control Position From The Ground**

The machine can also be controlled using the platform/remote control station from standing outside the platform. This position can be used for example, while loading the machine, or moving machine through a doorway with the platform removed.

To control the machine from this position, there must be no load in the platform, and boom must be in the stowed (aligned) position.

From this control position walking along side or behind the machine, the operator IS NOT enabled to control the aerial part of the machine, but only the tracks, stabilizers and track extension function.

### **⚠ DANGER**

**WHEN CONTROLLING THE MACHINE FROM THE GROUND POSITION, KEEP A DISTANCE OF AT LEAST 3 FT. (1 M) FROM THE TRACKS. ALWAYS BE CERTAIN THE COMPONENT THAT IS BEING MOVED IS COMPLETELY VISIBLE AND CONSTANTLY CHECK ITS TRAJECTORY.**

### **Control Position From In The Platform**

The platform/remote control is connected to the machine at the platform using a flexible cable.

**NOTE:** *Before removing or connecting the flex cable, the machine must be turned OFF and the key on the engine must be in the OFF position.*

### **Installing the Platform/Remote Control Station At The Platform**

1. Connect the flexible control cable at the platform to the Platform/Remote Control Station box connector on the right side of the control box.

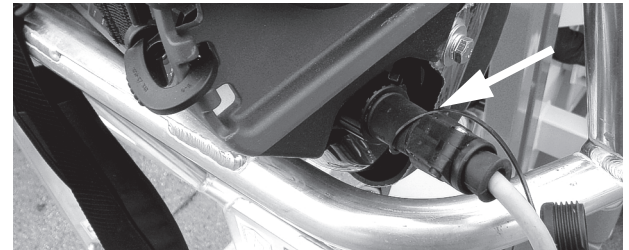

## SECTION 3 - MACHINE CONTROLS, INDICATORS AND OPERATION

2. In the platform, slide the control station assembly into the storage box, on the right side of the control station ensure the attached flexible cable slides into the slot in the box. Now place the rib on the right side of the control station assembly under the metal tab attached to the storage box assembly

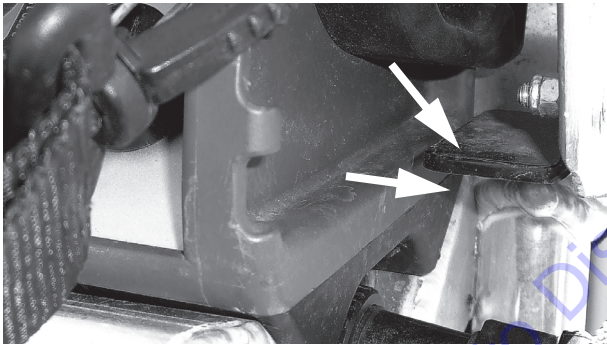

3. Lower the control station assembly further into the storage box, and secure the left side of the control station by turning the thumbscrew on the locking tab clockwise locking the rib of the control station under the rotating metal tab of the thumbscrew.

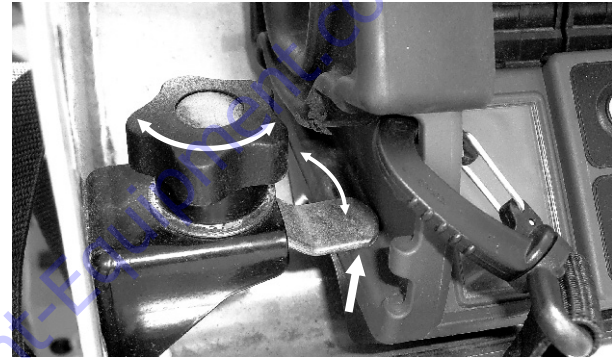

4. To remove the control station assembly, reverse the three steps above.

**NOTE:** *The Platform/Remote control box may also be used to operate the tracks, outriggers and track widening (if equipped) by removing it from the platform while still connected to the flex cable. All boom functions will be disabled when the platform/remote box is operated in this manner.*



### Platform/Remote Control Station Functions

Footswitch (see photo below)

To operate any function, the footswitch must be depressed and a function selected within seven seconds. If a function is not selected within seven seconds, or if a seven second lapse between ending one function and beginning the next function, the footswitch must be released and depressed again to enable the controls.

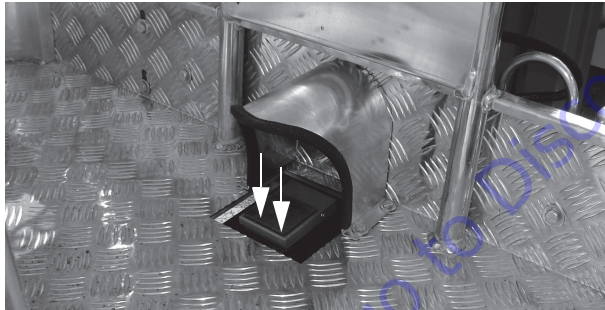

See Figure 3-6., Platform Control Console for remaining items.

**NOTE:** Buttons 1, 2, 3, 4, 5, 6, 7, 8, 9, serve a double function, they can be used to operate a machine function (icon on button) or used as numerical keys (per number below the button) when the SERVICE button 6 (item 6) sub-menus is activated on the LCD display.

1. Outrigger - Automatic Retract  
This control allows the operator to control the retraction of all 4 outriggers at one time.
2. Outrigger - Manual  
This control allows the operator to control the extension or retraction of one outrigger at a time.
3. Track Width Adjust  
This control allows the operator to widen the track.
4. Emergency Lowering  
This button allows the operator to lower the boom if engine power is not working.

**NOTE:** Buttons 5 and 6 when pressed simultaneously also activate the horn.

5. Speed Selector/Horn  
This button allows the operator to select the desired engine speed for operation.
6. Service Menu/Horn  
This button allows the operator to access the Service Menu.
7. Outrigger - Automatic Set And Level  
This control allows the operator to control the extension of all 4 outriggers at one time.

## SECTION 3 - MACHINE CONTROLS, INDICATORS AND OPERATION

---

### 8. Override/Selector

If the machine is driven into a tilt condition, this button may be pressed to override the drive cut-out. Each press of the button will allow the drive function to operate for approximately 8 seconds to back the machine from the tilt condition.

This button is also used for selecting an item when in the Service Menu (*item 6*).

### 9. Track Width Adjust

This control allows the operator to narrow the track.

### 10. Power/Emergency Stop

A two-position red switch supplies power to PLATFORM Controls when turned counterclockwise (on). When pushed in (off), power is shut off to the platform and ground controls.

### 11. Gas/Diesel Engine Starter

This button allows the operator to start or stop the gas/diesel engine.

### 12. Electric Engine Start

This button allows the operator to start or stop the electric engine.

### 13. Platform Level Key Switch

The control allows the operator to adjust the level of the platform up or down.

### 14. Display

The display shows the status of the machine and operating information. Wait until a display screen appears before beginning operation.

**NOTE:** *Controllers (16 through 23), the speed of component movement is proportional to the controller distance from the center neutral position.*

### ERROR



The movement of a controller without first pressing the platform footswitch is indicated by the depress footswitch error icon on the platform/remote LCD display.

## SECTION 3 - MACHINE CONTROLS, INDICATORS AND OPERATION

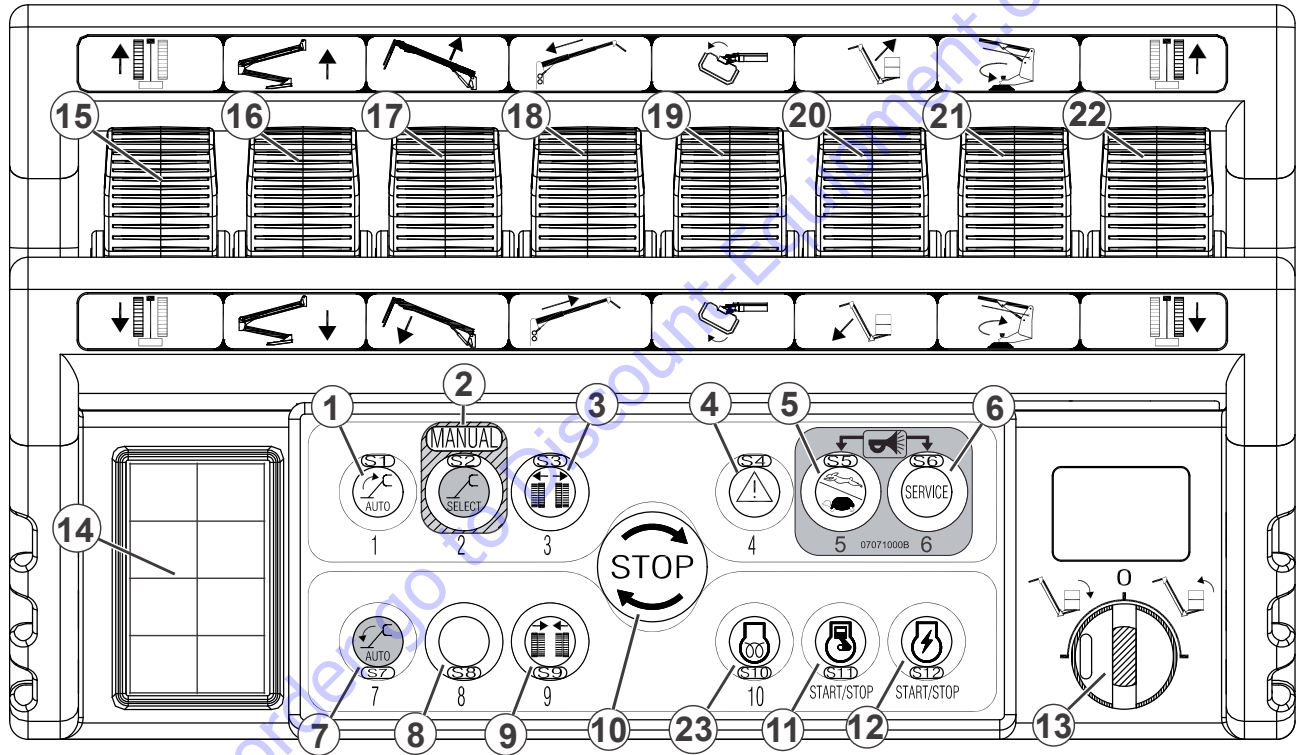

**Figure 3-6. Platform/Remote Control Station**

## **SECTION 3 - MACHINE CONTROLS, INDICATORS AND OPERATION**

---

**15. Left Side Track Drive And Steer**

This control when moved forward or rearward simultaneously with the right side track control (22), allows the operator to move the machine in a straight forward or reverse direction. If each control is moved individually, different amounts or in opposite directions steering the machine occurs.

**16. Tower Boom Lift**

This control allows the operator to raise and lower the tower boom.

**17. Main Boom Lift**

This control allows the operator to raise and lower the main boom.

**18. Main Boom Telescope**

This switch allows the operator to extend and retract the main boom.

**19. Platform Rotate**

This switch allows the operator to rotate the platform to the right or left.

**20. Jib**

This control allows the operator to raise and lower the jib.

**21. Swing**

This control allows the operator to swing the boom assembly to the right or left.

**22. Right Side Track Drive And Steer**

This control when moved forward or rearward simultaneously with the left side track control (15), allows the operator to move the machine in a straight forward or reverse direction or, if each control is moved individually or in opposite directions, to steer the machine.

**23. Engine Pre-Heat**

Allows pre-heating of the gasoline engine. One press on the button sets the engine at 2200 RPM for 20 seconds, in order to pre-heat the engine and improve machine operation after initial start.

**Platform/Remote Control Station LCD Display**

At machine start-up and during machine operation the main LCD display screen (item 14 - Figure 3-6.) is activated. There are eight (8) display positions which indicate machine status during various stages of operation.

1	2
3	4
5	6
7	8

**Position 1** Not Used.

1	2
3	4
5	6
7	8

**Position 2** Not Used.

1	2
3	4
5	6
7	8

**Position 3** Displays the selected engine (gas/diesel or electric) and whether it is on or off. The X on the icon indicates the engine is off.

1	2
3	4
5	6
7	8



**Position 4** Displays the selected engine speed.

1	2
3	4
5	6
7	8



## SECTION 3 - MACHINE CONTROLS, INDICATORS AND OPERATION

### Position 5

1	2
3	4
5	6
7	8

Displays that the outriggers are properly set and boom functions are allowed. No display indicates that the outriggers are not properly set and boom functions are not allowed.



If an overload occurs the main screen goes blank for 3 seconds followed by the overload error display and an alarm.



### Position 6

1	2
3	4
5	6
7	8

Indicates that boom, jib, turntable and base are aligned. Drive, steer, track width adjustment and outrigger functions are operational if this symbol below is present. No symbol indicates these functions are not operational. Drive and steer are operational if all 4 outriggers are not contacting the ground.



### Position 7

1	2
3	4
5	6
7	8

Can indicate any of the following situations:

- An emergency stop is pushed in (off).
- A low battery. The batteries need charged by running the gas engine or connecting to a power source.
- CANBUS communication is faulty.
- Electronic fault.
- Lithium ION - Signals an error in the BMS - Battery Management System
- Skyguard™ System enabled.



or:

- 50 Hr. - 1st Service Interval - See Section 6 - Figure 6-4. and Figure 6-5., Component Maintenance Intervals.



### Position 8



















1	2
3	4
5	6
7	<b>8</b>

- Indicates that emergency lowering has been selected.
- Lithium ION - Battery Charge Status
- Lithium ION - Battery Charger Plugged In.



## SECTION 3 - MACHINE CONTROLS, INDICATORS AND OPERATION

Table 3-1. LCD Display Icon Descriptions

	Max Capacity Overload		Weight in platform too low		Lower and Retract Boom		Machine Maximum Tilt Angle Exceeded
	Gas/Diesel engine running		Electric motor running		Gas/Diesel engine OFF		RPM signal missing
	Minimum speed		Standard speed		Boom retracted and aligned		Electric motor OFF
	Emergency lowering		Battery voltage low		Maximum speed		Emergency stop pressed
					Press footswitch		Select a control



**Table 3-1. LCD Display Icon Descriptions (Continued)**



Safety  
bypass  
active



Board or  
software  
wrong



Raise  
outrigger



Close the  
jib arm.



CAN BUS  
signal  
missing



Remove weight  
or remote  
control from  
platform



Machine  
stabilized



Platform/  
Remote control  
box is not  
connected  
properly



It is possible  
to only operate  
the jib

To order go to [Discount-Equipment.com](http://Discount-Equipment.com)

## SECTION 3 - MACHINE CONTROLS, INDICATORS AND OPERATION

**Table 3-2. LCD Display Error Descriptions**

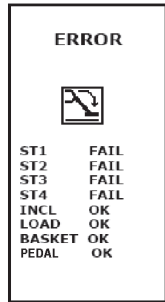

One of the most important error displays in regard to boom movements; this visualization displays why boom movement has been prohibited; in regard to outrigger set, inclination (tilt) platform load, platform/remote control box and footswitch status.



Platform/Remote Control Box is not connected properly



An emergency stop is pressed

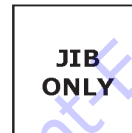

It is possible to only operate the JIB



Lift the outriggers to move the tracks

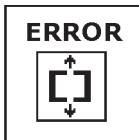

Retract and align the machine

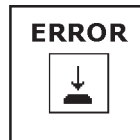

Press the footswitch to operate the controls

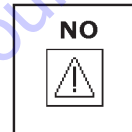

Operation not permitted with emergency lowering



Retract the JIB to work with 200kg



Overload in platform

**TO PURCHASE THIS PRODUCT PLEASE CONTACT US**



**Equipment Financing and  
Extended Warranties Available**



**Discount-Equipment.com is your online resource for  
commercial and industrial quality parts and equipment sales.**

**561-964-4949**

**visit us on line @ [www.discount-equipment.com](http://www.discount-equipment.com)**

Select an option below to find your Equipment

**Search by Manufacturer**

**Search by Product Type**

**Request a Quote**

We sell worldwide for the brands: Genie, Terex, JLG, MultiQuip, Mikasa, Essick, Whiteman, Mayco, Toro Stone, Diamond Products, Generac Magnum, Airman, Haulotte, Barreto, Power Blanket, Nifty Lift, Atlas Copco, Chicago Pneumatic, Allmand, Miller Curber, Skyjack, Lull, Skytrak, Tsurumi, Husquvarna Target, Stow, Wacker, Sakai, Mi-T-M, Sullair, Basic, Dynapac, MBW, Weber, Bartell, Bennar Newman, Haulotte, Ditch Runner, Menegotti, Morrison, Contec, Buddy, Crown, Edco, Wyco, Bomag, Laymor, EZ Trench, Bil-Jax, F.S. Curtis, Gehl Pavers, Heli, Honda, ICS/PowerGrit, IHI, Partner, Imer, Clipper, MMD, Koshin, Rice, CH&E, General Equipment, Amida, Coleman, NAC, Gradall, Square Shooter, Kent, Stanley, Tamco, Toku, Hatz, Kohler, Robin, Wisconsin, Northrock, Oztec, Toker TK, Rol-Air, APT, Wylie, Ingersoll Rand / Doosan, Innovatech, Con X, Ammann, Mecalac, Makinex, Smith Surface Prep, Small Line, Wanco, Yanmar

## **SECTION 4. MACHINE OPERATION**

### **4.1 DESCRIPTION**

This machine is a hydraulic personnel lift equipped with a work platform on the end of an elevating and rotating boom.

The primary operator control station is in the platform. The operator can control drive, steer, boom/platform functions and outriggers. The machine has a Ground Control Station which will override the Platform Control Station. Ground Controls operate boom and platform functions. They are to be used in an emergency to lower the platform to the ground should the operator in the platform be unable to do so. The ground control station is to be used for a Pre-Start Inspection too.

This machine is equipped with an ALL MOTION alarm warning system to alert other personnel in the work area of any machine movement during operation. The motion alarm system is activated during machine function movement such as track, boom, or outrigger operation.

### **4.2 BOOM OPERATING CHARACTERISTICS AND LIMITATIONS**

#### **Capacities**

The boom can be raised from the transport position with or without any load in platform, if:

- Machine is positioned on a firm surface and outriggers set properly with the outrigger pads on horizontal surfaces.
- Load is within manufacturer's rated capacity.
- All machine systems are functioning properly.

#### **Stability**

In addition to the conditions listed above under Capacities, machine stability also depends on the following:

- A work surface capable of supporting the machine and a slope within machine leveling specifications.
- Platform is only operated within its work area specification for rated load and boom reach. (See Figure 4-6.)

## SECTION 4 - MACHINE OPERATION

### 4.3 ENGINE OPERATION

**NOTE:** Before operating the Ground/Emergency Control box, determine which box is installed on your machine. Although the controls work the same they are configured slightly different. (See Figure 4-1. and Figure 4-2.)

**NOTE:** Initial starting must always be performed from the ground controls.

The gas engine key switch on the engine must be switched to ON, the battery disconnect switch must be ON (see Section 4.11 on page 4-25) and power/emergency stop buttons at the platform and ground controls must be ON (turned clockwise) to start the engine.

#### Gas Engine Starting Procedure

**NOTE:** If gas engine fails to start promptly, do not crank for an extended time. Should engine fail to start again, allow starter to cool off for 2-3 minutes. If engine fails after several attempts, refer to manufacturers engine maintenance manual.

1. Set the key at the Ground/Emergency Control box in the neutral (vertical) position, then push the appropriate ENGINE START switch until engine starts.

**NOTE:** Allow gas engine to warm-up for a few minutes at low speed before applying any load. If starting from the platform press the engine pre-heat button (Item 23, Figure 4-5.).

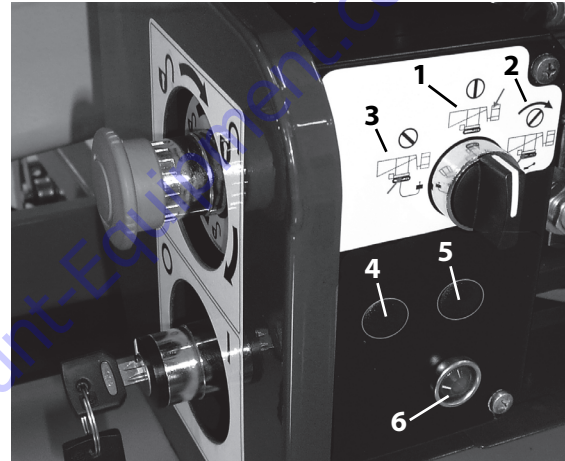

**Figure 4-1. Ground/Emergency Control Box**

- |  |   |
|--|---|
| 1. Platform/Remote (Center) Platform Position                              | 4. Gas Engine Start Button <sup>(1)</sup> (if equipped) |
| 2. Ground Control Position - (Turn ClockWise and Hold)                     | 5. Electric Engine Start Button <sup>(1)</sup>          |
| 3. Platform/Remote Ground Maintenance Position - (Turned CounterClockWise) | 6. Enable Light   |

**NOTE:** <sup>(1)</sup> Key switch must be set to ON, battery disconnect switch must be ON, and both the ground and platform emergency stop switches must be reset to ON.

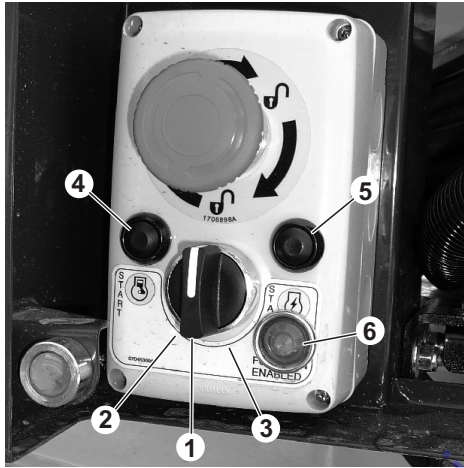

**Figure 4-2. Ground/Emergency Control Box**

- |  |   |
|--|---|
| 1. Platform/Remote (Center) Platform Position                              | 4. Gas Engine Start Button <sup>(1)</sup> (if equipped) |
| 2. Ground Control Position - (Turn ClockWise and Hold)                     | 5. Electric Engine Start Button <sup>(1)</sup>          |
| 3. Platform/Remote Ground Maintenance Position - (Turned CounterClockWise) | 6. Function Enable Indicator                            |

**NOTE:** (1) Switch at engine must be set to ON, main battery disconnect switch must be ON, and both the ground and platform emergency stop switches must be set to ON.

**NOTE:** At low temperatures start the motor and let it run for a few minutes, until the hydraulic oil circulates and reaches at least 50°F (10°C) before operating the platform.

### Gas Engine Shutdown Procedure

1. Remove all load and allow engine to operate at low speed for 3-5 minutes; this allows further reduction of internal engine temperature.
2. Turn off the gas engine by using the gas engine button (item 11, Figure 4-5.) on the platform/remote control box.
3. The shutdown procedure takes about 1 minute, wait for complete shut-off (display off).
4. Push POWER/EMERGENCY STOP switches at the platform and ground in, to the off position.
5. Turn engine key to off.

## SECTION 4 - MACHINE OPERATION

### Electric Engine Starting Procedure - AC Voltage Machine

#### **⚠ CAUTION**

ENSURE THE ELECTRICAL CIRCUIT BEING USED IS THE SAME VOLTAGE AND FREQUENCY INDICATED ON THE ELECTRIC ENGINE PLATE. USE AN AC EXTENSION CORD WITH SUFFICIENT AMPERAGE CAPACITY TO PROPERLY POWER THE MACHINE.

CHECK THE EFFICIENCY OF THE GROUND ON THE AC CIRCUIT, IF THE CIRCUIT IS NOT GROUNDED, INSERT A GROUND DISCHARGER TO GROUND AND CONNECT IT TO THE GROUND CLAMP ON THE MACHINE (ITEM 3 – SEE PHOTO).

1. Before connecting the machine to the electrical circuit, ensure the key on the gas engine is in the ON position.
2. Power the machine using a heavy duty AC power cord with sufficient amperage capacity, through the connector (item 2) positioned near the electric engine.
3. Turn on the circuit breaker switch (item 1) positioned behind the clear cover near the electric engine (— symbol is ON - O symbol is OFF).
4. Start the electric engine using the engine start button at the ground/emergency control box. (item 5 - Figure 4-2.) and operate machine.

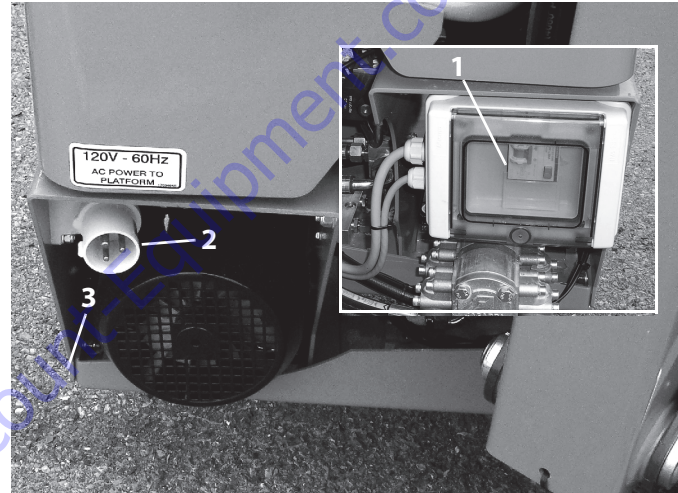

5. When finished operating with the electric engine, turn off switch (item 1 - opposite side of machine), unhook the electric AC cord from receptacle (item 2), and disconnect ground discharger cable (item 3), if it was required.

**NOTE:** At low temperatures start the motor and let it run for a few minutes, so that the hydraulic oil circulates and reaches at least 50°F (10°C) before operating the platform.

**Electric Engine Starting Procedure - LITHIUM-ION Machine**

1. Set the ON/OFF switch on the lithium-ion battery pack to the ON position, (0 symbol is OFF, 1 is ON).

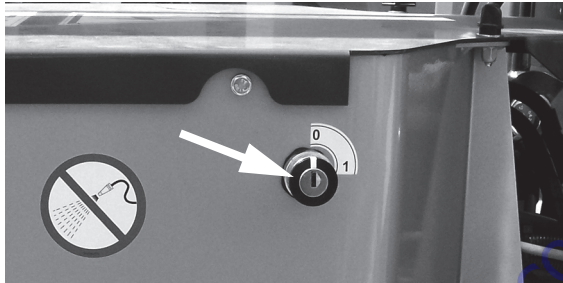

2. The electric engine will auto start when a function is activated at the platform or ground control station.
3. Switch the ON/OFF switch on the lithium-ion battery pack to the OFF position when shutting down at the end of a work period. (0 symbol is OFF, 1 is ON)



**Figure 4-3. Ground/Emergency Control Box - Lithium Ion**

- |  |  |
|--|--|
| 1. Platform/Remote Platform Position                   | 3. Platform/Remote Ground Maintenance Position - (Turned CounterClockWise) |
| 2. Ground Control Position - (Turn ClockWise and Hold) | 4. Function Enable Indicator   |



## SECTION 4 - MACHINE OPERATION

### 4.4 BASE AND BOOM/JIB ALIGNMENT

The machine has two reflectors/photocells that check if the boom assembly is completely lowered and retracted, the jib is lowered, and the turntable is aligned with the base. (see photos)

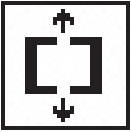

When these conditions are met this symbol will display in position (6) on the Platform/Remote Control LCD display.

**UNLESS THESE CONDITIONS ARE MET, DRIVE, STEER, TRACK WIDTH ADJUSTMENT, AND OUTRIGGER MOVEMENT IS PREVENTED.**

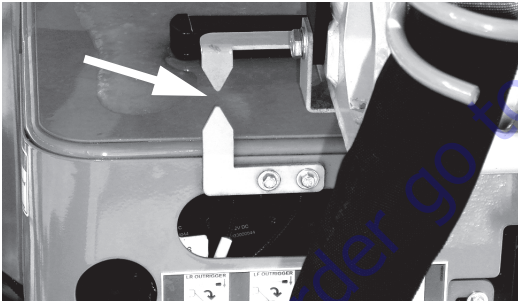

**Base/Boom Alignment - Visual Indicator**

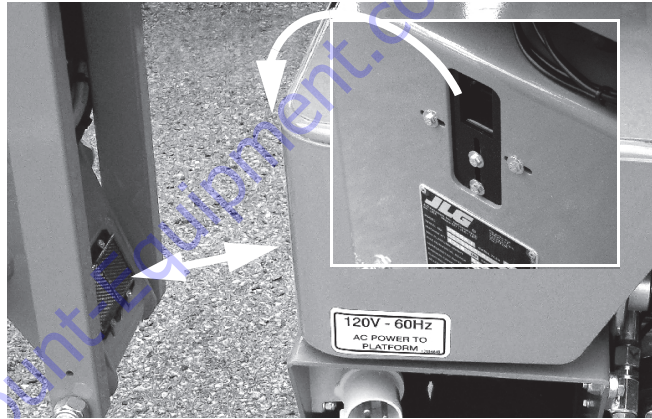

**Boom/Jib and Base Alignment - Reflectors/Photocells**

## 4.5 TRACKS - DRIVING, STEERING AND TRACK WIDTH ADJUST

### **⚠ WARNING**

KEEP EVERYONE A DISTANCE OF AT LEAST 3 FT. (1M) FROM THE MACHINE WHEN OPERATING THE TRACKS.

**NOTE:** *The base and boom/jib must be aligned and retracted before this function will operate, see Section 4.4, BASE AND BOOM/JIB ALIGNMENT.*

### Track Width Adjust

### **NOTICE**

**DO NOT WIDEN OR NARROW THE TRACKS WIDTH WHEN PARKED WITH THE TRACKS ON THE GROUND. THE MACHINE MUST BE TRAVELLING OR RAISED ON ITS OUTRIGGERS WHEN OPERATING THIS FUNCTION.**

Press and hold button 3 for widening or button 9 for narrowing the track.

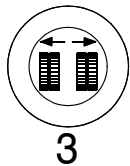

3

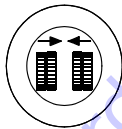

9

### Travelling (Drive and Steer)

### **⚠ WARNING**

USE EXTREME CAUTION WHEN APPROACHING A CREST OF ANY TERRAIN OBSTACLE. CHECK FOR CURBS, LARGE STONES, OR OTHER TERRAIN OBSTACLES INCLUDING OVERHEAD OBSTACLES AS THE MACHINE WILL MAKE UNCONTROLLED PIVOTING MOTIONS WHEN THE CENTER OF GRAVITY (CENTER OF TRACK FRAME) SHIFTS OVER AN EDGE. SLOW DOWN TO MINIMIZE ACCELERATION DURING PIVOTING MOVEMENT.

USE EXTREME CAUTION WHEN DRIVING IN REVERSE.

- To drive straight forward or reverse, move the controllers for both tracks at the same time, direction and position.
- Always fully widen the track prior to driving, if possible, for easier steering and increased stability.
- Always travel in the slow speed setting unless the travel path is firm, level and uniform.

### Travelling (Grades and Side Slopes)

### **⚠ WARNING**

DO NOT DRIVE MACHINE ON GRADES EXCEEDING 15 DEGREES (26.7%).

USE RAMPS WHEN TRAVELLING ON STEPS OR OTHER SURFACES THAT ARE NOT SMOOTH OR HAVE GOOD TRACTION.

## SECTION 4 - MACHINE OPERATION

**WHEN DRIVING ON SIDE-SLOPES, EXTEND THE LOW SIDE OUTRIGGERS UNTIL THEY ARE CLOSE TO THE GROUND TO HELP PREVENT A TIP-OVER IF A CHANGE IN SURFACE OCCURS. (SEE FIGURE 4-4.) DRIVE ON SIDE-SLOPES WITH THE BOOM STOWED. DO NOT DRIVE ON SIDESLOPES WHICH EXCEED 10 DEGREES.**

CUT-OUT CONDITION	EMPTY BASKET	BASKET WITH MORE THAN 40 Kg
Longitudinal Limit	16° (jib closed); 13° (jib open)	13°
Tracks Extended Side Limit	15°	15°
Tracks Retracted Side Limit	10°	10°

The machine is equipped with automatic tilt sensing during driving, the possible driving speeds are adjusted according to the weight in platform, undercarriage retracted or extended, position of JIB and inclination of the ground.

In case of approach to dangerous inclinations for machine's stability, both lateral and longitudinal, an alarm is activated and afterwards further movement is prohibited. The only allowed operation to exit this condition is activate the movement override, pressing button 8 on platform/remote control, (*displays TRACK ON allowing 8 seconds of drive time with each press of the override button*) and reposition the machine to a safer condition, reducing the inclination. It is absolutely forbidden to increase the inclination of the

machine as it could cause machine tipping with consequent danger for operator or people nearby the machine.

It is the operator's responsibility to run the machine safely, checking the ground conditions, evaluating the obstacles and dangers in the working area, and following the rules of this manual and indications on decals and display of the machine.

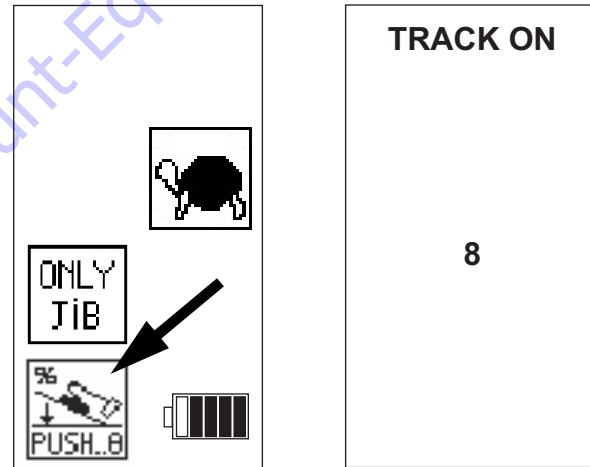

**LCD - Showing Maximum Incline Exceeded - While Driving**

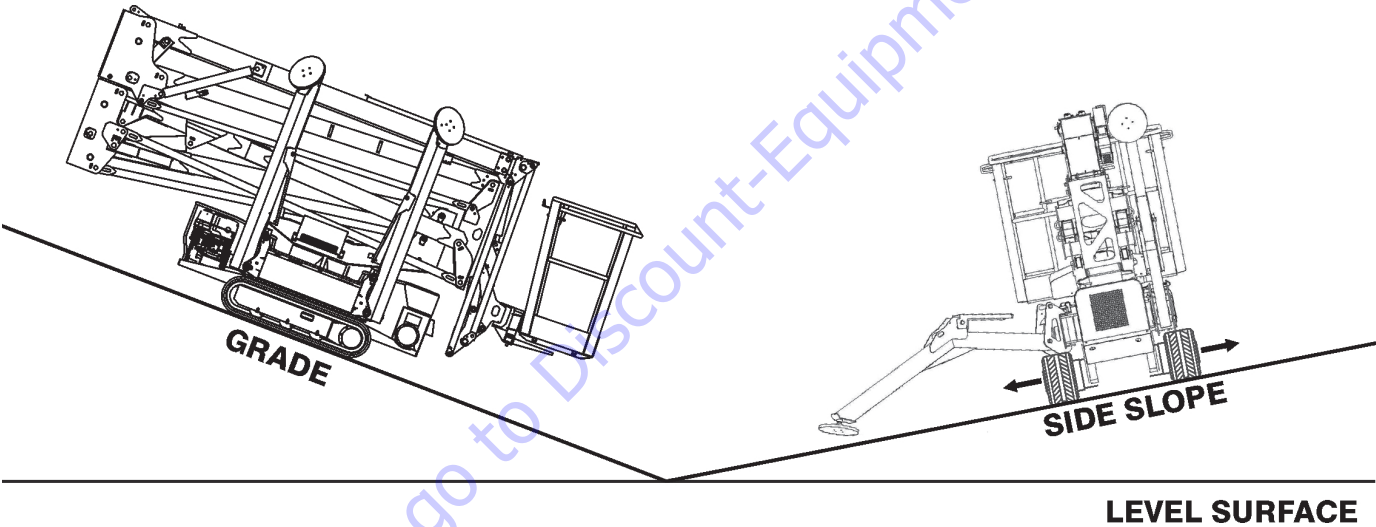

Figure 4-4. Grade and Side Slope Definition

## SECTION 4 - MACHINE OPERATION

### Jib Position for Travelling

It is necessary to raise the JIB arm when driving up or down slopes that exceed 10° and but less than the max. 15° to prevent the jib from contacting the ground.

#### NOTICE

**ONLY PERFORM THIS OPERATION WHEN IT IS NECESSARY. IN ALL OTHER SITUATIONS, DRIVE WITH THE BOOM AND JIB FULLY LOWERED AND ALIGNED.**



The permission to use the JIB is indicated by the icon in position 5 on the remote control display panel.

Before lifting the jib arm in the traversing phase, the following conditions must be verified:

- All outriggers must be lifted from the ground
- There must be no operator in the basket
- The platform/remote control box must be removed from the platform and used from the ground.

**NOTE:** The aerial part safety device by-pass key must not have been activated after the machine has been closed and aligned.

If any of these conditions have not been met, the use of the JIB is not possible and one of the following error displays appears.

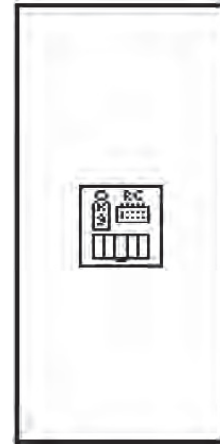
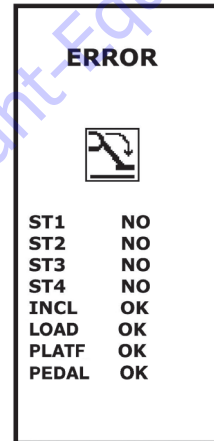

After these conditions have been met, make sure that there are no obstacles in the Jib working area and operate as follows:

- Activate the joystick for moving the JIB arm. If a different joystick is activated an error message will appear on the display.



- After the slope has been passed, for which the jib had to be raised, fully lower the jib and continue travelling.
- With the JIB raised, ALWAYS travel at minimum speed and keep the JIB as near as possible to the ground.

### 4.6 OUTRIGGER OPERATION

#### **⚠ WARNING**

**BE CERTAIN THAT THE OUTRIGGER PADS ARE SET ON A FIRM AND HORIZONTAL SURFACE. DO NOT SET THE OUTRIGGER PADS ON INCLINED, VERTICAL, OR SLIPPERY SURFACES.**

#### **NOTICE**

**THE OUTRIGGERS WILL NOT OPERATE UNLESS THE BOOM AND JIB ARE COMPLETELY LOWERED, RETRACTED AND ALIGNED WITH THE BASE.**

**NOTE:** *The base and boom/jib must be aligned and stowed before this function will operate, see Section 4.4, BASE AND BOOM/JIB ALIGNMENT.*

If one of the outriggers does not come into contact with the ground while being set, the engine will turn off or, the self-leveling attempt will stop. This situation may be due to the slope on which the outriggers are being set up on exceeds the allowed slope for proper set up at the end of the stabilization phase. If the machine is to be lifted even further from the ground after the outriggers are properly set, push and hold the outrigger automatic set and level button.

## SECTION 4 - MACHINE OPERATION

---

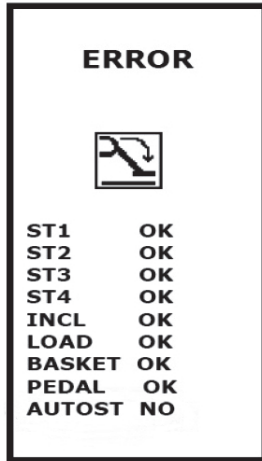

If the functions are selected when one of the above listed conditions is missing, an error message will appear on the platform/remote control display indicating which of the conditions are OK and which are not. If the condition is that an outrigger is not set properly, the message will also indicate which outrigger is not set properly.

ST1: if OK outrigger 1 is set properly.

ST2: if OK outrigger 2 is set properly.

ST3: if OK outrigger 3 is set properly.

ST4: if OK outrigger 4 is set properly.

INCL: if OK the machine is set up on an accepted slope.

LOAD: if OK the load in the platform is acceptable.

PLATFORM: if OK the platform/remote control box is in the proper location in the platform.

PEDAL: If OK the footswitch is correctly depressed.

AUTOST: when using the auto stabilizer set button 7, if OK, stabilizers are set properly.

If NO, button 7 was released before tilt sensor detected machine was level and stabilizers were not set properly.

## Setting Outriggers From the Platform/Remote Console

(Reference Figure 4-5. for item numbers)

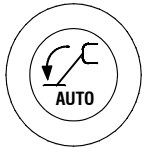

7

Either - Press and hold the outrigger auto-set and level button 7 (item 7) until OK appears on the platform LCD display.

or

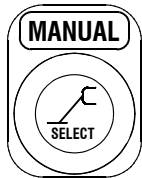

2

Operate each outrigger separately by pressing button 2 (item 2) to select which outrigger to control (each outrigger is numbered 1 thru 4, see decal, each press of button 2 displays the outrigger selected on the LCD display). Press button 1 (item 1) to retract or button 7 (item 7) to set that outrigger. The OK will appear on the display when the outriggers are set properly and the unit is level.

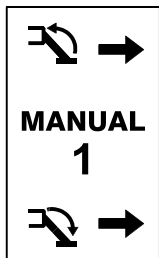

**Note:** To cycle back to outrigger auto-set mode, press button 2 (item 2) until the LCD display shows the normal operating icons.

### **⚠ WARNING**

**CHECK THE BUBBLE LEVEL TO CONFIRM UNIT IS LEVEL (BUBBLE IS COMPLETELY IN THE 1° GREEN (CENTER) AREA) AND THAT THE TRACKS ARE OFF THE GROUND BEFORE OPERATING THE BOOM FUNCTIONS. IF THE BUBBLE IN THE LEVEL IS NOT IN THE GREEN AREA, AFTER USING THE AUTO-LEVEL FUNCTION, SHUT DOWN THE MACHINE AND HAVE THE MACHINE REPAIRED BY A QUALIFIED SERVICE TECHNICIAN.**

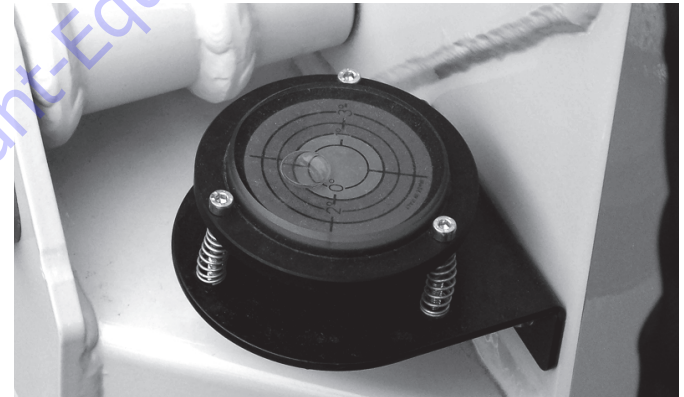

Each outrigger has a yellow light installed. All lights will be on steady if the outriggers are positioned to the full operation area. No lights will be on if the outriggers are not set properly.



## SECTION 4 - MACHINE OPERATION

### NOTICE

IF ONE OF THE ORANGE LIGHTS LOCATED ON EACH OUTRIGGER SHOULD REMAIN ON WHEN THAT OUTRIGGER IS LIFTED FROM THE GROUND, STOP THE MACHINE IMMEDIATELY AND CALL A QUALIFIED JLG SERVICE TECHNICIAN AS THIS INDICATES A PROBLEM WITH THE CORRESPONDING OUTRIGGER MICRO SWITCH.

### WARNING

IF THE SLOPE EXCEEDS 12°, THE MACHINE IS NOT CAPABLE OF PROPERLY SETTING THE OUTRIGGERS AND LEVELING ITSELF. OPERATION OF THE BOOM AND PLATFORM FUNCTIONS WILL NOT BE ALLOWED IN THIS CONDITION. THE MACHINE IS CONSIDERED STABILIZED WHEN LEVELED TO LESS THAN 1° AND THE TRACKS ARE LIFTED AT LEAST 2 IN. (5 CM) FROM THE GROUND.

STABILIZING THE MACHINE WITH AN INCLINATION DEGREE HIGHER THAN THE ONE ALLOWED COULD CAUSE INSTABILITY OF THE MACHINE

If the platform ladder is higher than 16 in. (40 cm) off the ground when the ladder is lowered, when setting the machine on outriggers from the ground position, lower the outriggers until the ladder is less than 16 in. (40 cm) off the ground. Then enter the platform to properly set the machine up on outriggers.

### Retracting The Outriggers

(Reference Figure 4-5. for item numbers)

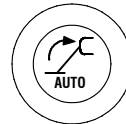

1

Either - Press and hold button no. 1 (*item 1*) of the remote control.

The 4 outriggers will all retract at the same time and lower the machine.

or



2

Operate each outrigger separately by pressing button 2 (*item 2*) to select which outrigger to control (*each outrigger is numbered 1 thru 4, see decal at each outrigger, each press of button 2 displays the outrigger selected on the LCD display*). Press button 1 (*item 1*) to retract or button 7 (*item 7*) to set that outrigger.

**Note:** To cycle back to outrigger auto-retract mode, press button 2 (*item 2*) until the LCD display shows the normal operating icons.

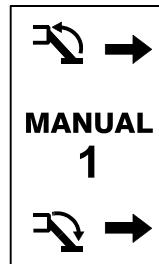

## 4.7 BOOM/PLATFORM OPERATION

### NOTICE

THE BOOM WILL NOT OPERATE UNTIL THE OUTRIGGERS ARE PROPERLY SET AND MACHINE IS LEVELED.

AT PLATFORM/REMOTE CONTROL STATION, TWIST THE EMERGENCY STOP BUTTON CLOCKWISE TO BE IN THE OUT POSITION, START ENGINE AND ACTIVATE FOOTSWITCH FOR ALL PLATFORM/ REMOTE CONTROL FUNCTIONS.

ALWAYS STOW (RAISE) THE LADDER AFTER ENTERING OR EXITING THE PLATFORM TO PREVENT IT BEING DAMAGED WHEN OPERATING THE MACHINE.

If the operator attempts to raise the JIB with more than the allowed capacity in the platform a maximum weight reminder icon appears in the middle of the platform/remote LCD display and the function stops.

**NOTE:** *At low temperatures start the motor and let it run for a few minutes, so that the hydraulic oil circulates and reaches at least 50°F (10°C) before operating the platform.*

### Overload Alarm

If the platform is overloaded all the boom functions are stopped, "Overload in Platform" error message appears on the platform/remote display and the alarm sounds. To restore the boom functions it is necessary to remove the extra load.

### ⚠ WARNING

TO AVOID SERIOUS INJURY, DO NOT OPERATE MACHINE IF ANY CONTROL LEVER OR SWITCH CONTROLLING PLATFORM MOVEMENT DOES NOT RETURN TO THE 'OFF' OR NEUTRAL POSITION WHEN RELEASED. IF THE PLATFORM DOES NOT STOP WHEN A CONTROL SWITCH OR LEVER IS RELEASED, REMOVE YOUR FOOT FROM THE FOOT SWITCH AND/OR USE EMERGENCY STOP SWITCH TO STOP THE MACHINE.

If the platform is lifted from the proper mounting position during the use of the machine, an alarm will sound and all the movements of the machine will stop. An error message will appear on the LCD display of the platform/remote control.

### Engine Pre-Heat

*(Item 23, Figure 4-5.)*

Allows pre-heating of the gasoline engine. One press on the button sets the engine at 2200 RPM for 20 seconds, in order to pre-heat the engine and improve machine operation after initial start.

### Platform Level Adjustment

*(Item 13, Figure 4-5.)*

**NOTE:** *During normal operation of the machine, the platform will automatically maintain its position.*

- To manually Level Up, turn the select switch clockwise and hold until desired position is reached.

## SECTION 4 - MACHINE OPERATION

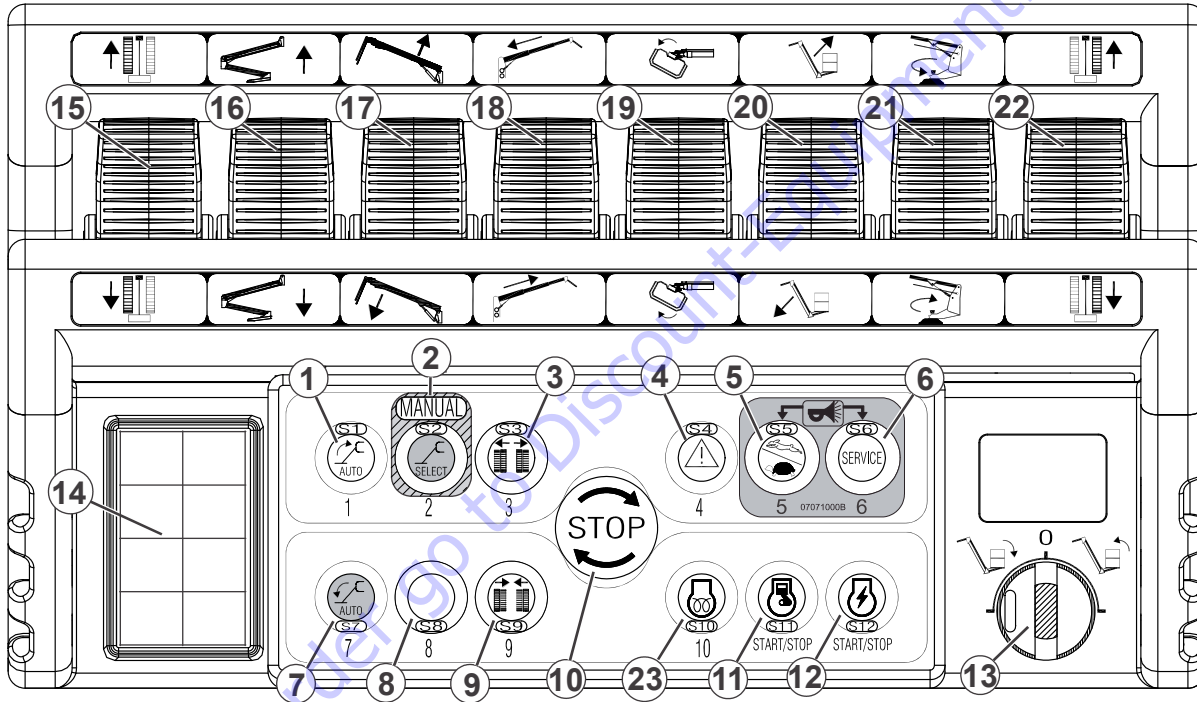

Figure 4-5. Platform/Remote Control Box

- To manually Level Down, turn the select switch counter clockwise and hold until desired position is reached.

### **⚠ WARNING**

**ONLY USE THE PLATFORM LEVELING OVERRIDE FUNCTION FOR SLIGHT LEVELING OF THE PLATFORM. INCORRECT USE COULD CAUSE THE LOAD/OCCUPANT TO SHIFT OR FALL. FAILURE TO DO SO COULD RESULT IN DEATH OR SERIOUS INJURY.**

### **Raise And Lower The Tower Boom**

*(Item 16, Figure 4-5.)*

- To raise the tower boom, depress the foot switch and move the controller forward.
- To lower the tower boom, depress the foot switch and move the controller backwards.

### **Raise And Lower The Main Boom**

*(Item 17, Figure 4-5.)*

- To raise the main boom, depress the foot switch and move the controller forward.
- To lower the main boom, depress the foot switch and move the controller backwards.

### **Telescope The Main Boom**

*(Item 18, Figure 4-5.)*

- To extend the main boom, depress the foot switch and move the controller backward.

- To retract the main boom, depress the foot switch and move the controller forward.

### **Platform Rotation (Item 19, Figure 4-5.)**

- To rotate the platform to the right, depress the foot switch and move the controller forward.
- To rotate the platform to the left, depress the foot switch and move the controller backwards.

### **Raise And Lower The Jib (Item 20, Figure 4-5.)**

- To raise the jib, depress the foot switch and move the controller forward.
- To lower the jib, depress the foot switch and move the controller backwards.

### **Swinging The Boom (Item 21, Figure 4-5.)**

### **⚠ WARNING**

**WHEN SWINGING THE BOOM MAKE SURE THERE IS AMPLE ROOM FOR THE BOOM AND UPRIGHT TO CLEAR SURROUNDING WALLS, PARTITIONS AND EQUIPMENT.**

**ALSO WHEN SWINGING THE BOOM WITH WHEN THE BOOM IS LOWERED BE CERTAIN THE BOOM/JIB/PLATFORM ARE HIGH ENOUGH TO AVOID CONTACT WITH THE OUTRIGGERS.**

- To swing the boom to the right, depress the foot switch and move the controller forward.
- To swing the boom to the left, depress the foot switch and move the controller backwards.

## SECTION 4 - MACHINE OPERATION

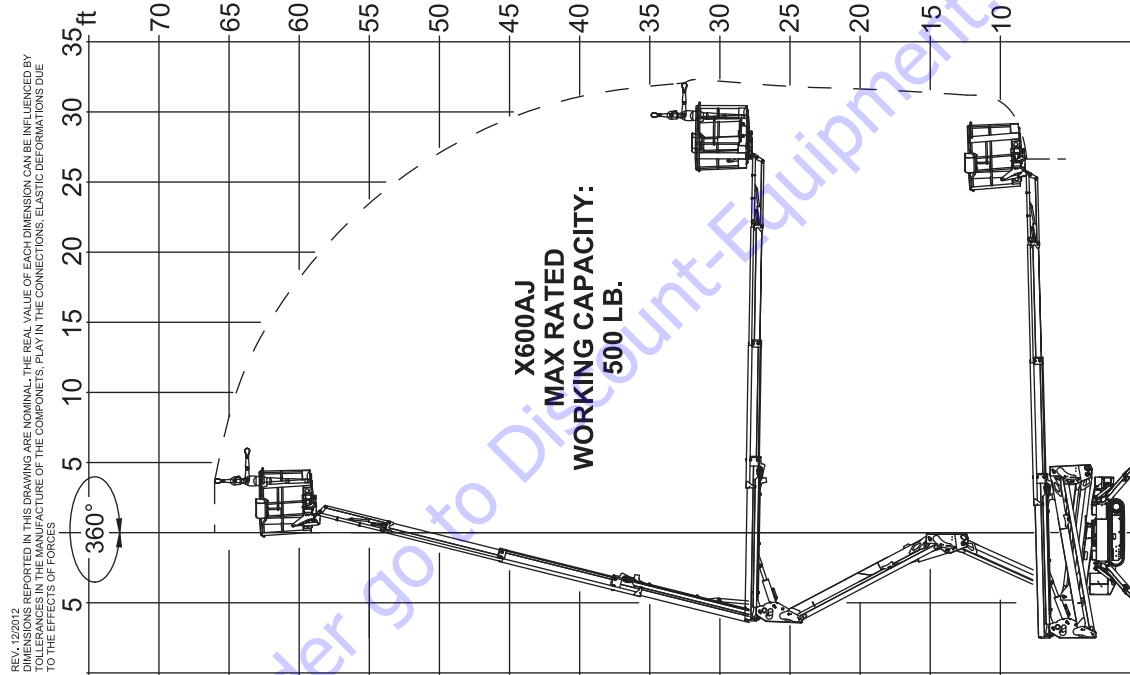

Figure 4-6. Platform - Load/Reach Chart - X600AJ

### SkyGuard Operation (If Equipped)

The SkyGuard™ feature is used to provide enhanced control panel protection. When the SkyGuard™ sensor is activated, functions that were in use at the time of actuation will reverse or cutout and the ground alarm will beep. The table below outlines these functions.



**NOTE:** Reverse motion can be stopped by the operator by releasing the footswitch, depressing the emergency stop button, or by releasing pressure on the SkyGuard™ sensor.

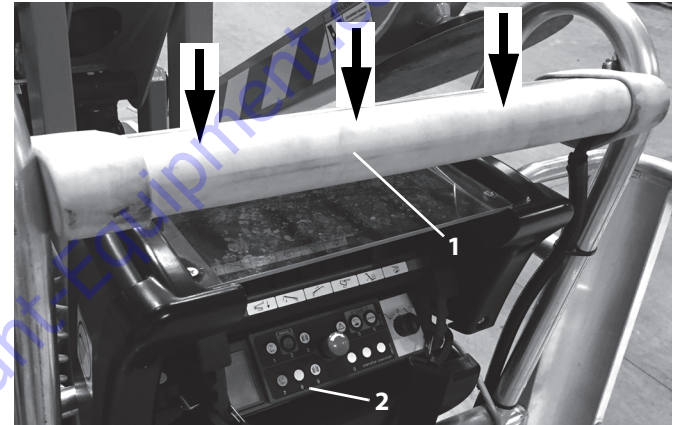

- 1. SkyGuard™ Sensor
- 2. SkyGuard™ Override Switch (button number 8)

**Figure 4-7. SkyGuard™ Sensor and Override Switch Location**

**Table 4-1. SkyGuard™ Function Table**

Main Lift Up	Main Lift Dn	Main Tele In	Main Tele Out	Swing	Drive Forward	Drive Reverse	Tower Lift Up	Tower Lift Down	Platform Level	Platform Rotate	Jib Lift
R	C	C	R	R	C	C	R	C	C	C	C
R = Indicates Reversal is Activated											
C = Indicates Cutout is Activated											
N/A Indicates the function does not exist for this model											

## SECTION 4 - MACHINE OPERATION

---

### 4.8 PLATFORM REMOVAL/INSTALLATION

The platform may only be removed to allow passage through areas measuring a minimum of 39 in. (99cm).

**NOTE:** *If the platform is removed only track movement is allowed.*

#### Platform Removal

1. Remove the platform/remote control box from the mounting support.
2. Loosen and remove the aluminum caps that secure the platform to the jib platform mounting posts.



3. Lift the platform off the mounting posts in an upward direction. Place platform aside for later installation.

#### Platform Installation

1. Lift the platform and align the platform mounts with the jib mounting posts and lower until seated.
2. Secure the platform to the jib mounting posts with the aluminum threaded caps. Do not overtighten.
3. Re-install the platform/remote control box into the mounting support on the platform.

### 4.9 BATTERY CHARGING - GAS/AC-ELECTRIC

**NOTE:** Be sure that the machine is parked in a well ventilated area free of flames and sparks.

- Only plug the charger into a properly grounded outlet.
- Do not use ground adaptors or modify plug. Do not touch non-insulated portion of output connector or non-insulated battery terminal.
- Always disconnect the AC supply before making or breaking the connections to the battery.
- Do not open or disassemble charger.
- Do not operate charger if the AC supply cord is damaged or if the charger has been damaged in any way.

### Battery Charging - Daily

#### **⚠ CAUTION**

**BEFORE CONNECTING THE BUILT-IN CHARGER TO THE RECEPTACLE, ENSURE THE KEY ON THE ENGINE IS POSITIONED TO OFF.**

The machine has a built-in battery charger. To activate this feature connect the machine to an appropriately grounded AC receptacle and activate the charging switch behind the clear plastic door. (See photo) Verify the battery disconnect switch is on.

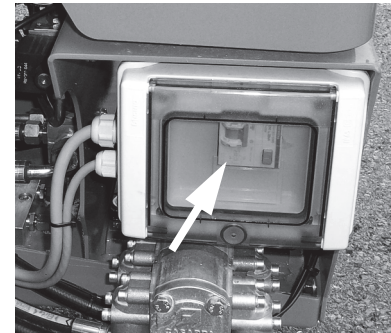



### 4.10 BATTERY CHARGING - LITHIUM-ION MACHINE

To check the battery condition on the lithium ION equipped machine, power up the machine and use the special indicator shown at position 8 on the platform control station LCD display.



or;

Check the three (3) phase charge indicator (*item 2*) on the side of the Lithium-Ion battery pack. This indicator shows the current charge state of the lithium-ion battery pack as follows;

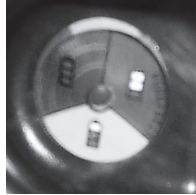

Red: first phase of recharging.

Yellow: second phase of recharging.

Green: third equalization phase of recharging.

Green: equalization/standby phase. When you're in this phase, batteries can be considered charged. The charger is doing the batteries voltage equalization at first and then it's in standby maintaining batteries at max charge. The time for equalization can be of some hours but it's not necessary to complete it in order to consider the recharge phase completed.

If the machine is powered on while charging, the LCD display on the platform control station also shows the machine charge indicator.



### Charging the Battery Pack

#### **NOTICE**

**DO NOT LEAVE THE MACHINE IN CONTINUOUS CHARGING FOR TIME PERIODS EXCEEDING 24 HOURS.**

**REMEMBER, THE CHARGE WORKS EVEN IF THE ELECTRONIC BOARD OF THE MACHINE IS TURNED OFF. SO THE BATTERIES CAN BE CHARGING EVEN IF THE REMOTE CONTROL IS OFF.**

**CHARGE THE MACHINE USING ONLY THE BATTERY CHARGER INSTALLED ON IT. THE USE OF A CHARGER OTHER THAN THAT PROVIDED VOIDS ANY KIND OF WARRANTY ON BATTERIES.**

Approximate time required to fully recharge the battery pack:

- Full Recharge - 4 hrs. - 120V AC
- 80% Recharge - 2 hrs. - 120V AC

The batteries can be charged during machine operation, (*obviously the charging times in this case will be longer*).

- The batteries can be charged when they are not fully depleted.
- If the charge is less than 20% an audible warning signal will be activated whenever the electric motor is started, to alert the user to charge the machine.

- If the charge is less than 10%, in addition to the audible warning signal, reduced speed is activated and an icon comes on in position 4 on the platform station LCD display.

To start charging the battery connect the main AC power supply to the **AC socket (item 1 - photo)** located on the right rear of the machine next to the electric engine.

After a few seconds the **charge indicator (item 2 - photo)** located on the right-hand side of the machine on the lithium-ion battery pack turns red, meaning the battery has started charging.

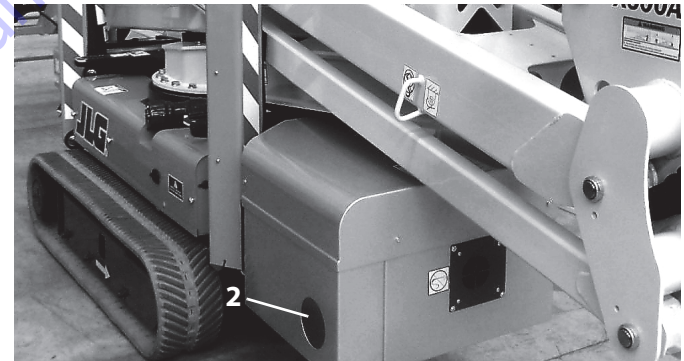
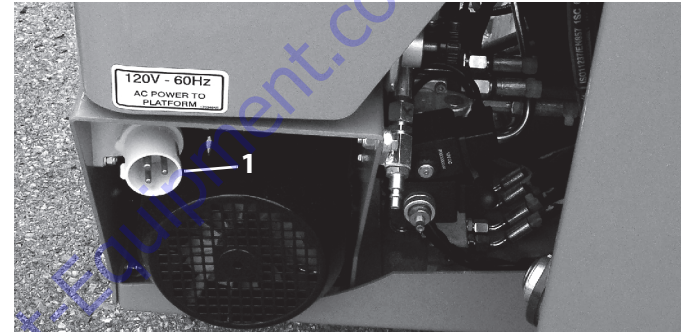

### **WARNING**

**THE BATTERY CHARGER SUPPLIED WITH THE LIFT WAS DESIGNED TO ENSURE SAFE AND RELIABLE PERFORMANCE. IT IS ALREADY FITTED ON THE MACHINE AND DOES NOT NEED ANY ADJUSTMENT OR CONFIGURATION BY THE USER; NONETHELESS, TO AVOID INJURY AND DAMAGE TO THE BATTERY CHARGER, THE FOLLOWING ESSENTIAL PRECAUTIONS MUST BE OBSERVED:**

- Carefully read the installation instructions contained in this manual. For future reference, keep the manual in a safe place.
- Do not place the battery charger near sources of heat.
- As the battery charger is sealed and without forced ventilation, its performance depends on the ambient temperature and the type of installation.
- Be certain the type of power supply available corresponds to the voltage specified and indicated on the battery charger rating plate or in this Operation/Maintenance Manual. If any questions, contact your local JLG Service Center or the local electrical company.
- An AC class circuit breaker can be used as protection device for the battery charger power supply, however it is recommended to use a class A or even better class B device.
- In regard to safety and electromagnetic compatibility, the battery charger features a three pin plug with ground, which can only be plugged into an grounded socket. If the plug does not go into the socket, most probably the socket is old and not grounded. In this

case, contact an electrician to have the socket replaced. Do not use adapters to resolve ungrounded circuit plug problems.

- Ensure the power cable is undamaged. If the cable is worn or damaged, have it replaced immediately.
- If extensions or multiple sockets are used, make sure that these support the total rated current.
- Disconnect the power supply before connecting or disconnecting the battery.
- Do not use the battery charger to charge the batteries of other vehicles; the battery charger installed was specially designed to charge the type of lithium batteries used on this machine. Do not attempt to charge any other type of batteries.
- Do not attempt to repair the battery charger. Opening the cover may expose the user to the risk of electric shock.
- Do not open the battery charger, opening it may affect the index of protection (IP) even after it has been closed again.
- If the battery charger is not working correctly or is damaged, disconnect it immediately from the power outlet and the battery socket and contact your local JLG Service Center.

### **Charge Curve**

The battery charger features just one charge curve (IU1a) plus balancing and maintenance, designed specifically for charging the lithium-ion battery pack on this machine.

### 4.11 SHUT DOWN AND PARK

#### CAUTION

**WHEN PARKING THE MACHINE ON A SLOPE OR UNEVEN GROUND WITH THE OUTRIGGERS RETRACTED, PARK WITH THE TRACKS IN THE FULLY WIDENED POSITION AND BLOCK THE TRACKS USING WEDGES TO PREVENT MACHINE MOVEMENTS.**

1. Drive machine to a reasonably well protected area.
2. Ensure the boom and jib are in the stowed (aligned) position.
3. Remove all load and allow engine to operate 3-5 minutes at LOW setting to permit reduction of internal engine temperatures.
4. Shut down the gas/electric engine with the same button on the platform/remote control station used to start it. Complete machine shut down will take approximately 1 minute, LCD display OFF.
5. At ground and platform controls, push-in the emergency stop buttons and remove the key at the ground controls. Turn off the engine and remove the key.
6. Close the platform control console lid. If necessary to protect instruction placards, warning decals and operating controls from hostile environment, place a cover over this area.

7. If machine is to be shut down for long periods of time, turn the battery disconnect switch, RED handle located on the electrical/battery tray housing, to the POWER OFF position. (photos below and next page)

**POWER ON**  
Clockwise



**POWER OFF**  
Counter-Clockwise



**BATTERY DISCONNECT - GAS/AC-ELECTRIC**

## SECTION 4 - MACHINE OPERATION

### POWER ON

Clockwise

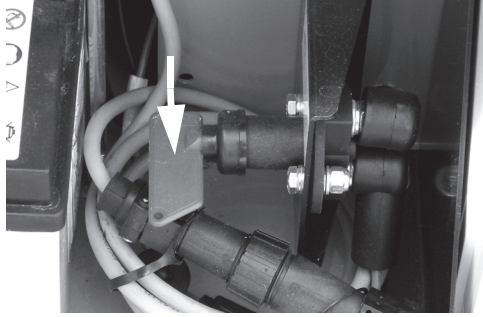

### POWER OFF

Counter-  
Clockwise

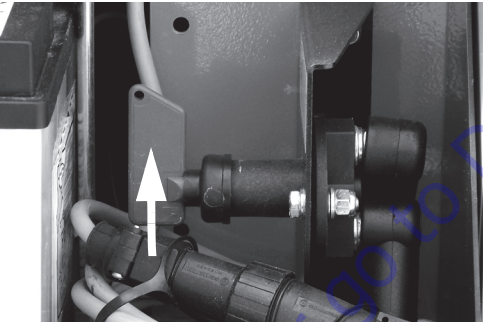

**BATTERY DISCONNECT - LITHIUM-ION - ELECTRIC**  
(Mounted Inside Left-Side Electrical Component Compartment)

## 4.12 LIFTING AND TIE DOWN

### Lifting - Outrigger Lifting Rings

1. Determine gross weight of machine, refer to the serial number tag, or weigh the individual unit to find out the gross vehicle weight.
2. Configure the machine in the transport position;
  - a. place the booms in the stowed position and properly aligned
  - b. all outriggers are fully retracted
  - c. tracks are fully widened
  - d. Remove all loose items from the machine
3. Lift machine using only the lifting lugs on the fork lift pockets, on both sides of the machine. (See Figure 4-8.)
4. Use a lifting bar capable of supporting the full weight of the machine, with a distance between the attach points a minimum of 21.65 in. (550mm) to maximum of 28.75 in. (730mm)
5. Properly adjust the lifting bar and rigging to prevent damage to the machine and so the machine remains level and balanced.

**⚠ DANGER**

**TO LIFT THE MACHINE A SEPARATE WIRE ROPE/CHAIN/SLING MUST BE ATTACHED TO EACH OF THE (4) LIFTING LUGS USING THE APPROPRIATE**

LIFTING POINTS AS INDICATED IN FIGURE 4-8. OTHERWISE THE MACHINE MAY NOT BALANCE PROPERLY AND MOVE UNEXPECTEDLY.

### **NOTICE**

THE USE OF ROPES, CHAINS OR SLINGS WITH LENGTH LESS THAN 10 ft. (3m) COULD CAUSE PERMANENT DAMAGE TO THE MACHINE OUTRIGGERS.

As the weight of the machine is not spread equally over the four lifting lugs, the minimum required capacity of the four ropes, chains or slings used must be: no less than 4,409 lb. (2000 kg) and their length no less than 10 ft. (3m) and all identical.

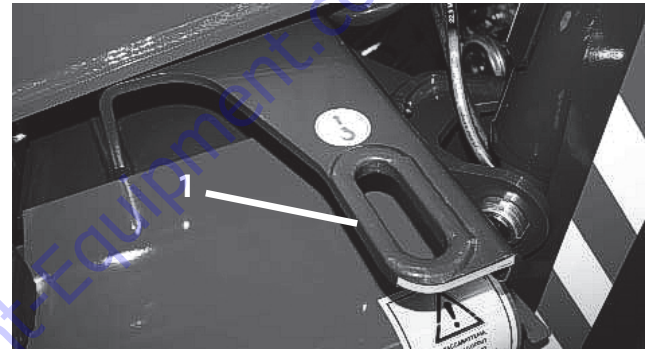

**Figure 4-8. Lifting Machine - Lifting Lugs Location**

1. Lifting Lugs (4 - 1 Each Corner)

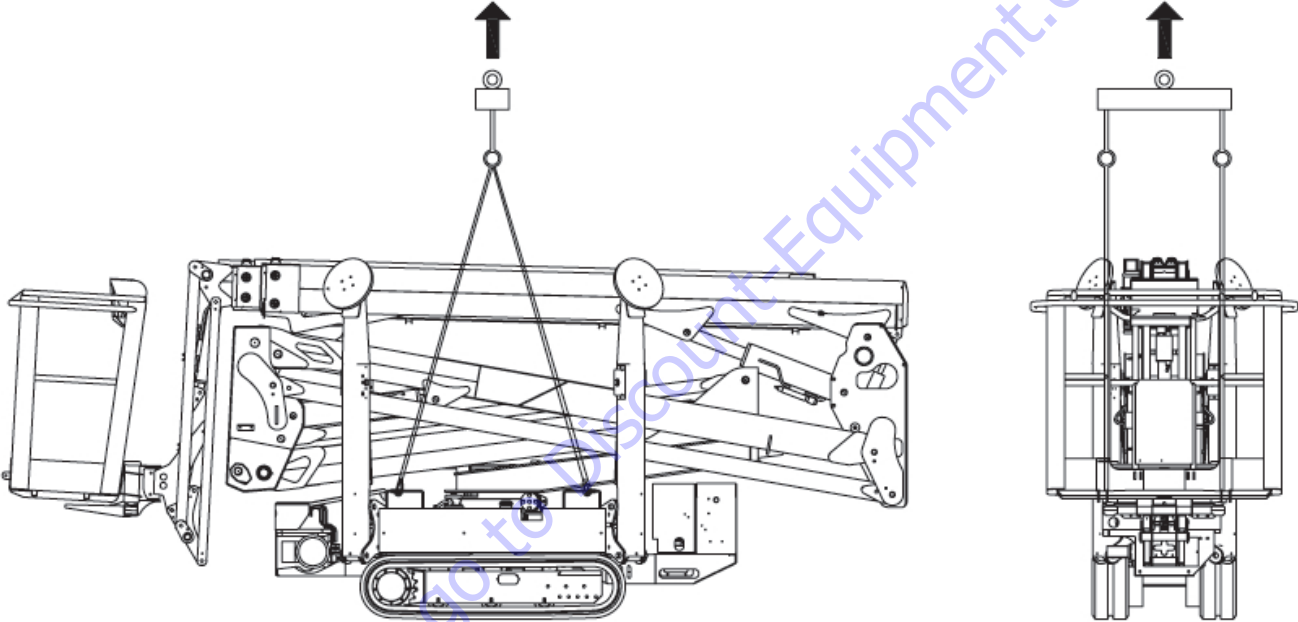
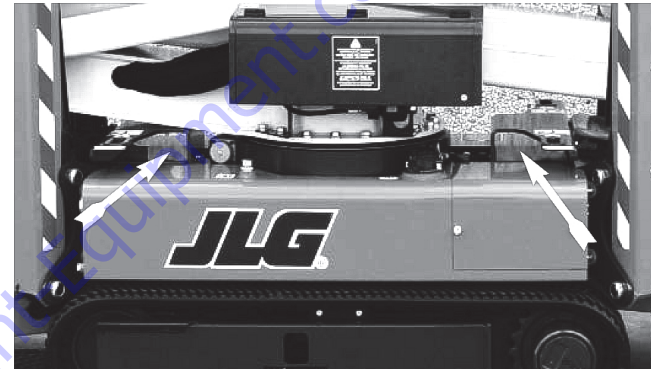

**Figure 4-9. Lifting Machine - Lifting Bar Rigging**

### Lifting - Fork Lift Pockets

The machine is equipped with two tubular fork lift pockets designed to lift the machine using a forklift of suitable capacity.

1. Determine gross weight of machine, refer to the serial number tag, or weigh the individual unit to find out the gross vehicle weight.
2. Configure the machine in the transport position;
  - a. place the booms in the stowed position and properly aligned
  - b. all outriggers are fully retracted
  - c. tracks are fully widened
  - d. Remove all loose items from the machine
3. Adjust forks of fork lift to the proper width for the lifting pockets on machine.
4. Carefully approach the machine with fork lift truck being careful not to damage any machine components. Insert the forks into the lifting pockets on the machine and carefully lift machine.
5. Move machine to new location.

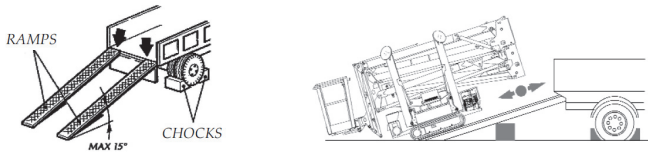

**Figure 4-10. Lifting Machine - Fork Lift Pockets Location**



## SECTION 4 - MACHINE OPERATION

### Loading and Unloading the Machine on Transport Vehicles Using Ramps



The JLG platform offers high maneuverability and stability even in travelling (stowed) configuration.

Despite this, the user must work with care even when carrying out the simplest operations.

#### **⚠ DANGER**

**ALWAYS LOAD/UNLOAD THE MACHINE WITH UNDERCARRIAGE (TRACKS) EXTENDED TO WIDEST WIDTH.**

#### **Loading**

For example, follow the procedure below to load the machine onto a truck/trailer:

- It is recommended to load/unload the machine using the remote control while at the side of the machine, keeping a MINIMUM distance of 3 feet (1m).
- Park the truck/trailer on a flat surface;

- Make sure that the ramps do not exceed the maximum inclination of 15°;
- Make sure that the ramps and the trailer have the capacity to support the machine and are free from debris or slippery material;
- Position the ramps parallel to each other at a distance equal to the space between the drive tracks;
- Climb the ramps, proceeding with the basket facing backwards;
- When approaching the loading surface, before the change in inclination, ALWAYS check that the JIB arm is COMPLETELY RETRACTED. Then proceed with great care in order to prevent sudden jolts when passing from the sloping ramps to the truck/trailer flatbed;
- Position the machine so that none of its parts protrude from the transport vehicle.

#### **UnLoading**

Unload the machine following the same instructions given above.

- During travel and when changing slope, make sure not to damage the safety devices positioned under the basket.
- If the change in inclination is excessive, adjust the angle of the ramps or, if this is not possible, use longer ramps. It is also possible to use the jib arm as described earlier.

### Tie Down

(See Figure 4-11.)

#### **NOTICE**

**WHEN TRANSPORTING THE MACHINE, THE BOOM MUST BE FULLY LOWERED INTO THE BOOM REST.**

- Travel up ramps with the platform behind the machine.
- Do not contact the ground with the jib or bottom of platform when loading/unloading. Operate the machine from the ground remote position and raise the jib to prevent contact with the ground. See "Jib Position for Travelling" on page 4-10.
- ALWAYS load/unload the machine with the track fully widened.

1. Configure the machine to the transport position;
  - a. place the booms in the stowed position and properly aligned
  - b. all outriggers are fully retracted
  - c. tracks are fully widened
  - d. remove all loose items from the machine
2. Secure the chassis using straps or chains of adequate strength.

#### **⚠ CAUTION**

**DO NOT MAKE CONNECTIONS AT POINTS DIFFERENT THAN THOSE IDENTIFIED BY THE TIE DOWN LOCATION DECAL SHOWN - SEE FIGURE 4-11. THIS COULD CAUSE PERMANENT DAMAGE RESULTING IN THE COLLAPSE OF THE PRODUCT.**

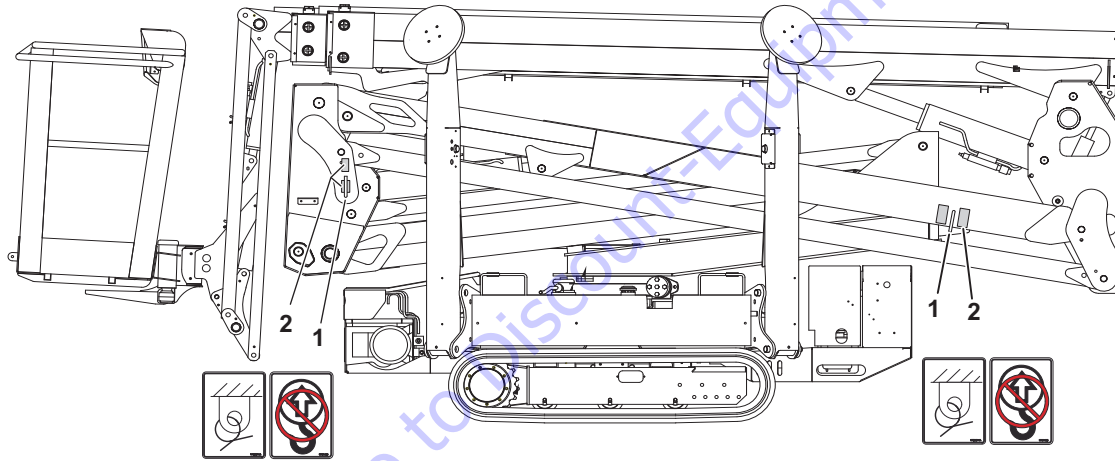

**Figure 4-11. Machine Tie-Down Points (both sides of machine)**

1. Tie-Down Loop

2. Tie-Down Decal

4.13 MACHINE DECALS



Figure 4-12. Decal installation - Standard - Left Side

# SECTION 4 - MACHINE OPERATION

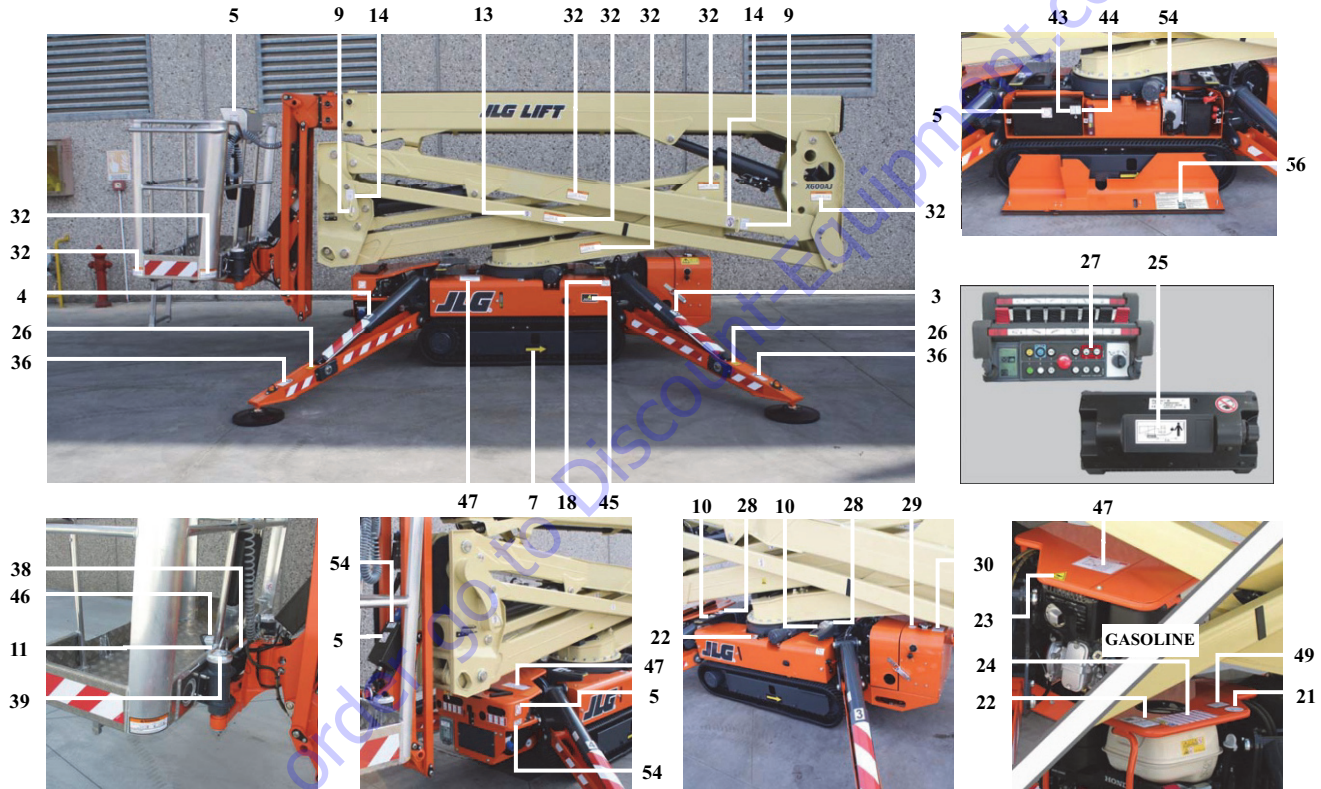

Figure 4-13. Decal Installation - Standard - Right Side

Table 4-2. X600AJ - Decal Installation - Standard (See Figure 4-12. and Figure 4-13.)

ITEM #	PART NUMBER	DESCRIPTION
		<b>DECAL INSTALLATION</b>
1	06555500	Decal, Outrigger Number 1
2	06555600	Decal, Outrigger Number 2
3	06555700	Decal, Outrigger Number 3
4	06555800	Decal, Outrigger Number 4
5	1001125483	Decal, Do Not High Pressure Wash
6	1706898	Decal, Emergency Stop
7	06040500	Decal, Forward Direct Arrow
8	1701640	Decal, Read The Manual
9	1703814	Decal, Tie-Down Anchor
10	07071200	Decal, Lifting Lug
11	1704277	Decal, Platform Lanyard Attach Point
12	06164700	Decal, Hydraulic Oil Filter
13	07056700	Decal, Not A Lifting Point
14	1701499	Decal, Do Not Lift From This Anchor Point
15	06706500	Decal, Platform Alignment
16	06998800	Decal, Platform Manual Diverter Pump
17	07242000	Decal, Remote Control, 3-Position Selector
18	1702155	Decal, Battery Master Switch
19	1701504	Decal, Hydraulic Oil
20	06165000	Decal, Hydraulic Oil Level
21	06060000	Decal, Engine Oil Level

## SECTION 4 - MACHINE OPERATION

Table 4-2. X600AJ - Decal Installation - Standard (See Figure 4-12. and Figure 4-13.)

ITEM #	PART NUMBER	DESCRIPTION
22	1701542	Decal, Gasoline Fuel Only
22	1701505	Decal, Diesel Fuel Only
23	06056300	Decal, Burn Hazard
24	06232100	Decal, Danger - Flammable - Gasoline
25	07240300	Decal, Keep 3 ft./1m Away When Operating With Tele /Radio Commands
26	07320400	Decal, Stabilizer Load - Lower On A Firm/Stable Surface Only
27	07071000	Decal, Lower Onto A Firm/Stable Surface Only
28	07350300	Decal, Fork Truck Lifting Pocket
29	03214200	Decal, Liquid Refrigerant
30	06594500	Decal, Liquid Refrigerant Reservoir
31	07506500	Decal, Emergency Stop
32	07056100	Decal, Crushing Danger
33	1706387	Decal, Crushing Danger
34	1706099	Decal, Crushing Danger
35	1702868	Decal, Crushing Danger - Hand
36	07056200	Decal, Crushing Danger - Lower Limb
37	1706386	Decal, Danger While Lowering
38	07051100	Decal, Danger of Falling - Replace Pin
39	07051000	Decal, Danger of Falling - Unlock Only When Allowed
40	1706133	Decal, Danger of Tilting
41	07058600	Decal, Stabilizer Positioning
42	07045300	Decal, Ground Control - Engine Start

**Table 4-2. X600AJ - Decal Installation - Standard (See Figure 4-12. and Figure 4-13.)**

<b>ITEM #</b>	<b>PART NUMBER</b>	<b>DESCRIPTION</b>
43	07042100	Decal, Boom Bypass System
44	07042200	Decal, Track Bypass System
45	1702901	Decal, Instructions For Emergency Manual Pump
46	3252347	Decal, Pedal
47	1706128	Decal, Danger of Electrocutation
48	1703813	Decal, Explosion Hazard - Battery
49	1704972	Decal, Explosion Hazard
50	—	Not Used
51	1706385	Decal, Lower Sliding Bar After Entering Platform
52	1705514	Decal, CSA Conformation
53	1706135	Decal, Platform Use
54	07056400	Decal, Danger - 120V - 60Hz
55	07056300	Decal, Danger - 220V - 50/60Hz
56	075039GB	Decal, Emergency Descent Instructions
57	072423GB	Decal, Maximum Platform Capacity - X600AJ
58	072424GB	Decal, Distributor Valve Ground Control - Side
59	072425GB	Decal, Distributor Valve Ground Controls - Rear - Left Side
60	072426GB	Decal, Distributor Valve Ground Controls - Rear - Right Side



## SECTION 4 - MACHINE OPERATION



Figure 4-14. Decal installation - Lithium-Ion - Left Side



Figure 4-15. Decal Installation - Lithium-Ion - Right Side



**TO PURCHASE THIS PRODUCT PLEASE CONTACT US**



**Equipment Financing and  
Extended Warranties Available**



**Discount-Equipment.com is your online resource for  
commercial and industrial quality parts and equipment sales.**

**561-964-4949**

**visit us on line @ [www.discount-equipment.com](http://www.discount-equipment.com)**

Select an option below to find your Equipment

**Search by Manufacturer**

**Search by Product Type**

**Request a Quote**

We sell worldwide for the brands: Genie, Terex, JLG, MultiQuip, Mikasa, Essick, Whiteman, Mayco, Toro Stone, Diamond Products, Generac Magnum, Airman, Haulotte, Barreto, Power Blanket, Nifty Lift, Atlas Copco, Chicago Pneumatic, Allmand, Miller Curber, Skyjack, Lull, Skytrak, Tsurumi, Husquvarna Target, Stow, Wacker, Sakai, Mi-T-M, Sullair, Basic, Dynapac, MBW, Weber, Bartell, Bennar Newman, Haulotte, Ditch Runner, Menegotti, Morrison, Contec, Buddy, Crown, Edco, Wyco, Bomag, Laymor, EZ Trench, Bil-Jax, F.S. Curtis, Gehl Pavers, Heli, Honda, ICS/PowerGrit, IHI, Partner, Imer, Clipper, MMD, Koshin, Rice, CH&E, General Equipment, Amida, Coleman, NAC, Gradall, Square Shooter, Kent, Stanley, Tamco, Toku, Hatz, Kohler, Robin, Wisconsin, Northrock, Oztec, Toker TK, Rol-Air, APT, Wylie, Ingersoll Rand / Doosan, Innovatech, Con X, Ammann, Mecalac, Makinex, Smith Surface Prep, Small Line, Wanco, Yanmar

## SECTION 5. EMERGENCY PROCEDURES

### 5.1 GENERAL

This section explains the steps to be taken in case of an emergency situation while operating.

### 5.2 INCIDENT NOTIFICATION

JLG Industries, Inc. must be notified immediately of any incident involving a JLG product. Even if no injury or property damage is evident, the factory should be contacted by telephone and provided with all necessary details.

In USA -  
JLG Phone: 877-JLG-SAFE (554-7233)  
(8am till 4:45pm EST)

Outside USA: 240-420-2661

E-mail: ProductSafety@JLG.com

Failure to notify the manufacturer of an incident involving a JLG Industries product within 48 hours of such an occurrence may void any warranty consideration on that particular machine.

### NOTICE

FOLLOWING ANY ACCIDENT, THOROUGHLY INSPECT THE MACHINE AND TEST ALL FUNCTIONS FIRST FROM THE GROUND CONTROLS, THEN FROM

THE PLATFORM CONTROLS. **DO NOT LIFT ABOVE 10 FT. (3M) UNTIL YOU ARE SURE THAT ALL DAMAGE HAS BEEN REPAIRED, IF REQUIRED, AND THAT ALL CONTROLS ARE OPERATING CORRECTLY.**

### 5.3 EMERGENCY OPERATION

#### Power Main Cut-Off Switch Location

A battery cut-off switch - RED handle (*photo shows power OFF*) is located on the outside of the battery/electrical box tray at the left front of the machine just behind the outrigger mount. When switched off - handle turn all the way in direction of arrow - all electrical power to the machine is shut down.



Gas/Diesel/AC-Electric

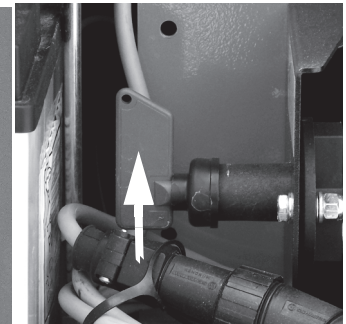

Lithium-Ion-Electric

## SECTION 5 - EMERGENCY PROCEDURES

### Operator Unable to Control Machine

IF THE PLATFORM OPERATOR IS PINNED, TRAPPED OR UNABLE TO OPERATE OR CONTROL MACHINE:

1. Other personnel should operate the machine from ground controls only as required.
2. Other qualified personnel on the platform may use the platform controls. DO NOT CONTINUE OPERATION IF CONTROLS DO NOT FUNCTION PROPERLY.
3. Cranes, forklift trucks or other equipment can be used to remove platform occupants and stabilize motion of the machine.

### Platform or Boom Caught Overhead

If the platform or boom becomes jammed or snagged in overhead structures or equipment, rescue platform occupants prior to freeing the machine.

**NOTE:** *The engine runs the hydraulic pump which provides the hydraulic pressure for the hydraulic system. The electric power provides power for the hydraulic proportional valve solenoids to open and close which operate various solenoids and relays on the hydraulic system. In the event either/or both are not operating properly, the following procedures will allow the lowering of the boom and platform.*

### Manual Descent with Engine Running and Electrical Power

#### CAUTION

**ENSURE BOOM IS NOT POSITIONED OVER THE OUTRIGGERS OR OVERHEAD OF PERSONNEL BEFORE LOWERING.**

#### Using Platform/Remote Control Box from Platform

(See Figure 5-1.)

The manual descent system is provided as an emergency means to lower personnel in the platform.

1. Check that the emergency stop button (*item 10*) is in the ON position by turning it clockwise.
2. Press and hold down button 4 (*item 4*) with the hazard symbol on the platform/remote control box. The LCD display (*item 14*) will indicate the triangle symbol seen on the button in LCD position 8. 
3. Select a boom function to operate by moving its controller in the direction for lowering.
4. When finished, release the emergency lowering switch (*item 4*).
5. Position (*press*) the emergency stop switch to the OFF position.

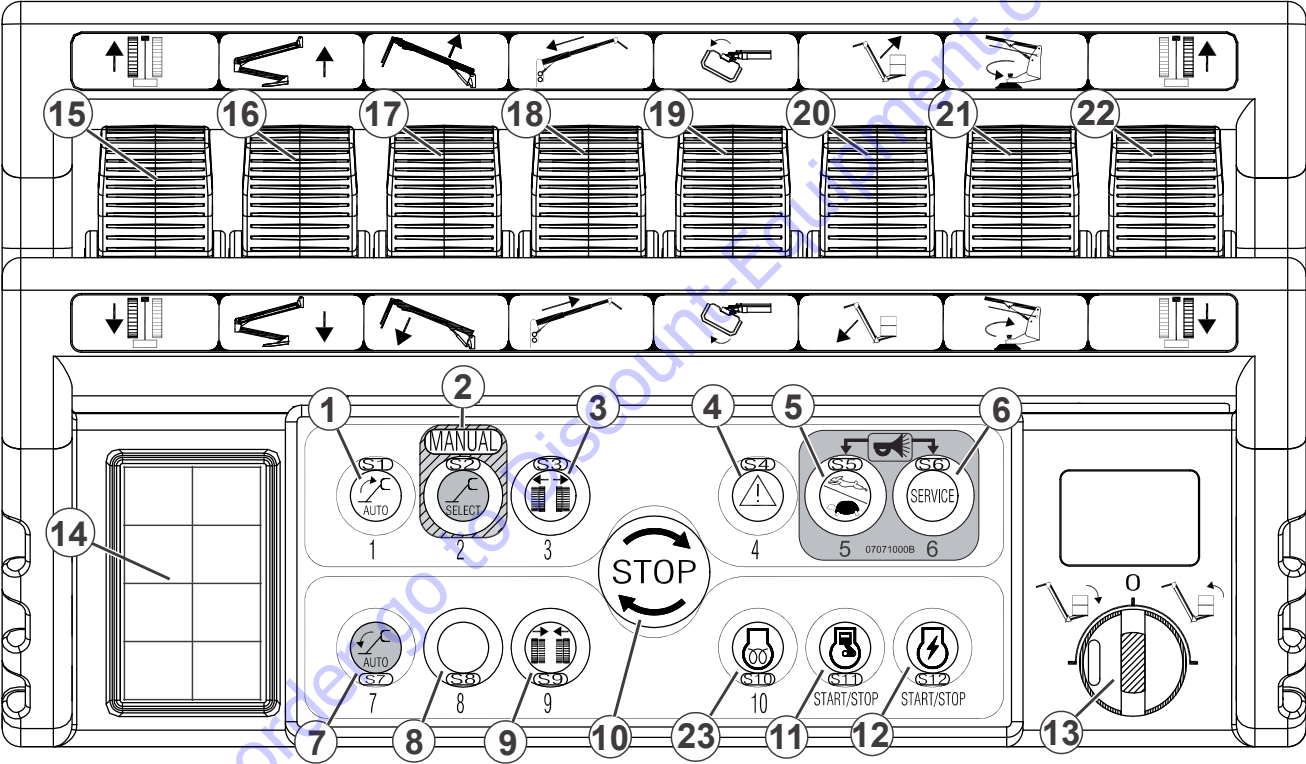

Figure 5-1. Platform/Remote Control Station

## SECTION 5 - EMERGENCY PROCEDURES

---

### Using Emergency/Ground Controls from Ground

**NOTE:** See Section 3.1 on page 3-3 to determine which Ground Control Station is equipped on your machine.

(See Figure 5-2. or Figure 5-3.)

### CAUTION

**ENSURE BOOM IS NOT POSITIONED OVER THE OUTRIGGERS OR OVER-HEAD OF PERSONNEL BEFORE LOWERING.**

1. Be certain the emergency stop button is in the ON position by turning it clockwise.
2. Start the engine, if not already running.
3. At the Emergency/Ground Control box, turn the key switch all the way clockwise and hold.
4. Check that the green (*machine stabilized*) indicator light on the Emergency/Ground Control box is on.
5. Operate the appropriate manual control lever next to it's proportional valve under the cover of the valve distributor. See decal on valve distributor cover for boom component and direction to operate lever for desired movement.
6. When finished, release the key switch back to the neutral position.
7. Position (*press*) the emergency stop switch in to the OFF position to shut machine down.



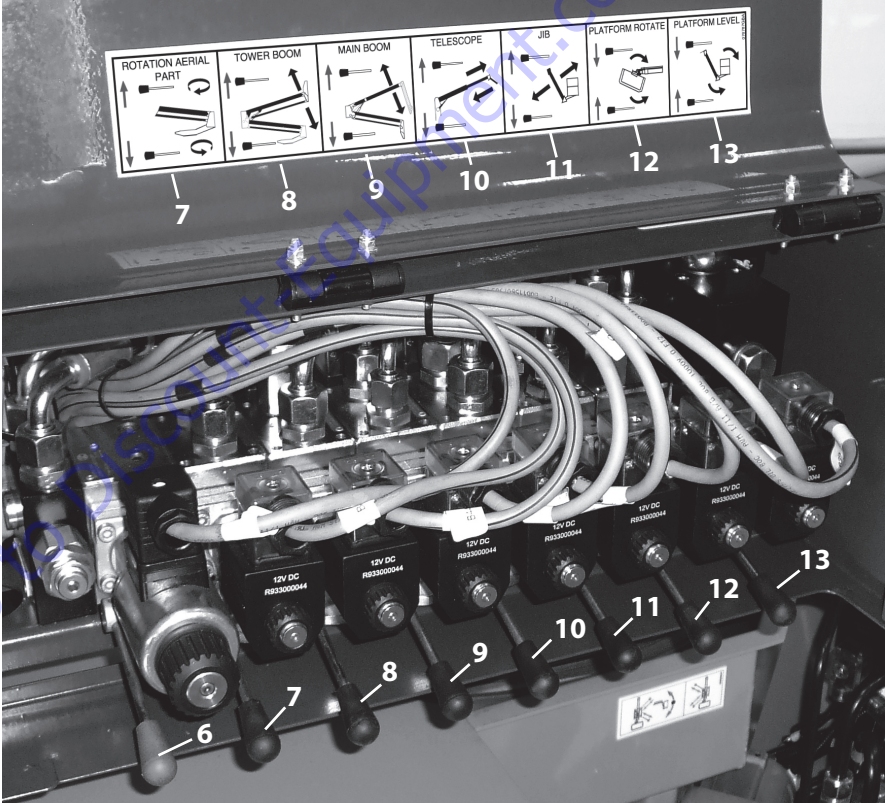
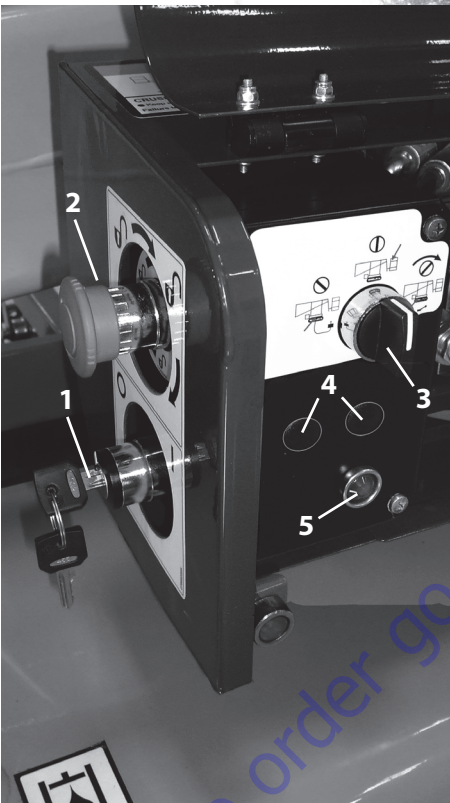

Figure 5-2. Ground Control Station - with Enable Lever

## SECTION 5 - EMERGENCY PROCEDURES

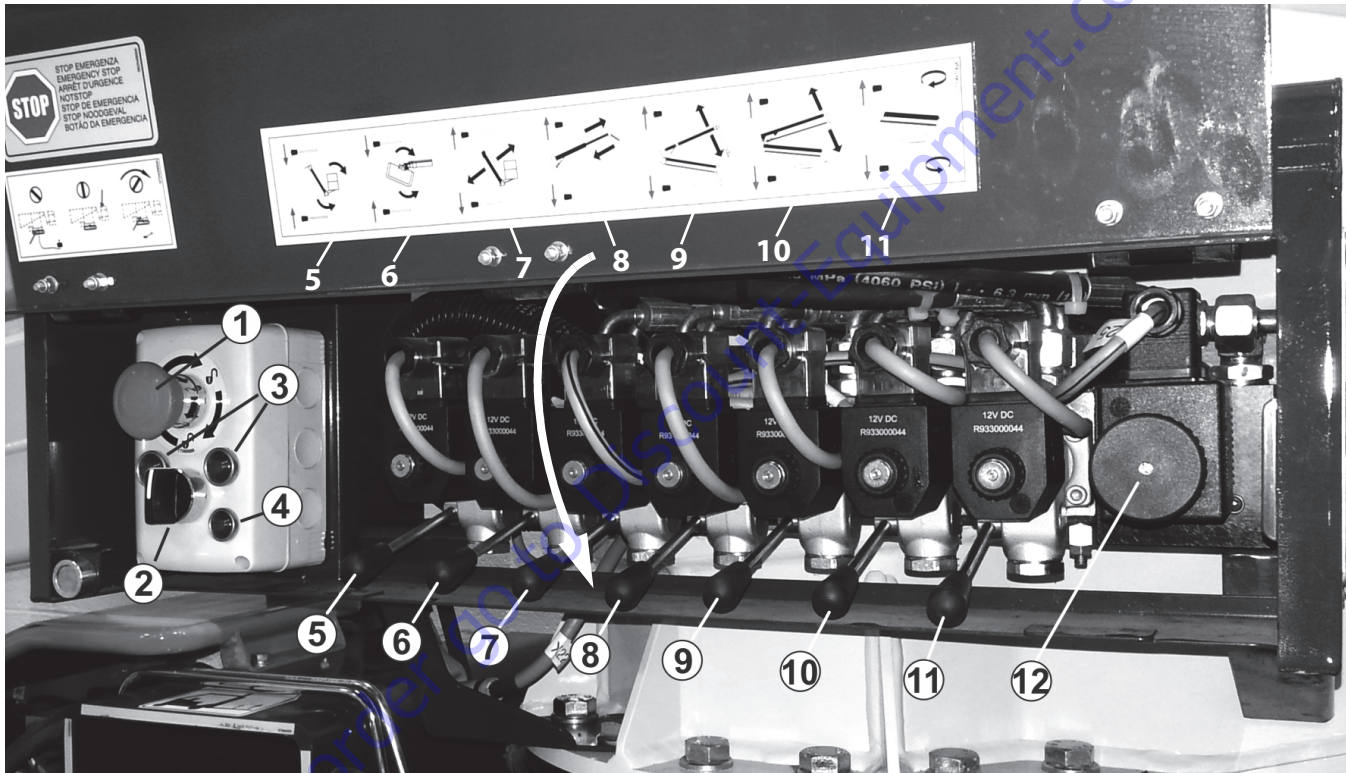

Figure 5-3. Ground Control Station - Boom Control Valve - with Enable Knob

### Manual Descent with Engine Running but without Electrical Power (Combustion Engines Only)

(See Figure 5-2. or Figure 5-3.)

#### CAUTION

**ENSURE BOOM IS NOT POSITIONED OVER THE OUTRIGGERS OR OVER-HEAD OF PERSONNEL BEFORE LOWERING.**

1. Operate the boom control valves at the ground control valve distributor.
2. Ensure the machine is level and all outriggers are properly deployed on a firm surface. If outrigger movement is required first, See "Outrigger/Track Movement Emergency Procedure:" on page 5-10.

**NOTE:** *The distributor enable valve adjusts the speed of the boom movements (pressure flow) when using the boom control valves at the valve distributor. Without electrical power you must manually open this valve by pressing it in before operating the boom controls.*

3. Always carry out movement at the slowest possible speed.
4. Make boom movements in the following sequence:
  - fully lower jib
  - fully lower tower boom
  - fully lower main boom
5. When emergency operation is complete, release the proportional valve to the closed position.
6. At the engine, turn the key to the off position.

## SECTION 5 - EMERGENCY PROCEDURES

### Manual Descent without Engine and Electrical Power Using Hand Pump Mounted to Hydraulic Tank on Right side of Machine

#### Platform Retrieval Sequence

1. Ensure the machine is level and all outriggers are properly deployed on a firm surface. If outrigger movement is required first, See "Outrigger/Track Movement Emergency Procedure:" on page 5-10.
2. Locate and remove the manual hydraulic pump handle secured to the top cover above the outrigger/track ground control proportional valve groups at the rear of the machine.
3. Install the pump handle on the hydraulic pump (*item 1 - Figure 5-4.*) and secure in place with the provided screw.
4. The manual pump lever (*item 2 - Figure 5-4.*) on the pump must be;  
**Positioned Up** - for **right side** outrigger, track and boom functions. (See - *Figure 5-5.*)  
**Positioned Down** - for **left side** outrigger and track functions.

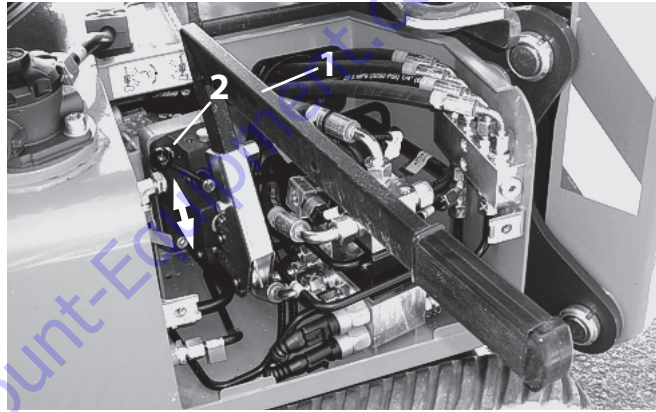

Figure 5-4. Hand Pump - At Front Of Hydraulic Tank

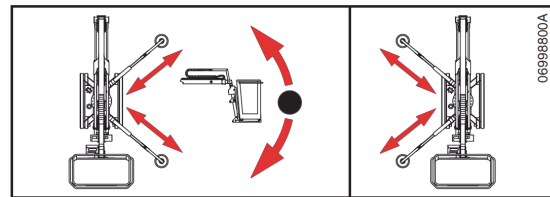

Figure 5-5. Hand Pump Control Decal

### **⚠ WARNING**

NEVER WORK UNDER AN ELEVATED PLATFORM UNTIL PLATFORM HAS BEEN SAFELY RESTRAINED FROM ANY MOVEMENT BY BLOCKING OR OVERHEAD SLING.

### **⚠ WARNING**

NEVER REACH THROUGH, UNDER, OR OVER THE BOOM'S PATH OF TRAVEL TO THE GROUND CONTROL PANEL. IF NO ASSISTANT IS AVAILABLE, PROCEED WITH THE FOLLOWING STEPS.

### **NOTICE**

TO AVOID CONTACT BETWEEN THE JIB AND OUTRIGERS, DO NOT ATTEMPT TO MANUAL SWING WITH THE BOOMS AND JIB FULLY LOWERED.

1. Open the cover on the Ground Control Station (see *Figure 5-2. or Figure 5-3.*), located on the hydraulic tank side of the machine.

At the ground control valve distributor perform the following steps as required;

2. If not already aligned, first swing the turntable inline with the chassis so that the turntable and base indicator arrows are aligned.

**NOTE:** *This will eliminate the possibility of an elevated or extended boom being positioned overhead of person-*

*nel at the pump and eliminate the risk of lowering the jib onto an outrigger.*

- a. **Depress the enable valve lever/button** (*Figure 5-2. or Figure 5-3.*).
- b. **Activate the swing control lever** in the desired direction of travel while pumping the hand pump until the turntable is aligned with the chassis.
- c. **Activating the lever up** while pumping will swing the platform to the clockwise.
- d. **Activating the lever down** while pumping will swing the platform to the counterclockwise.

**NOTE:** *All of the following functions require the enable button (*Figure 5-2. or Figure 5-3.*) to be depressed while pumping the hydraulic hand pump and operating the function lever.*

3. Retracting the main boom (*if necessary*).

With the aid of an assistant, while pumping the hand pump, activate the telescope function lever (*Figure 5-2. or Figure 5-3.*) at the ground controls, to retract the main boom.

4. Lowering the jib (*if necessary*).

While pumping the hand pump, activate the jib lift function lever (*Figure 5-2. or Figure 5-3.*) in the appropriate direction to lower the jib.

## SECTION 5 - EMERGENCY PROCEDURES

---

5. Lowering the Tower Boom (*if necessary*).

While pumping the handpump, activate the tower boom lift function lever (*Figure 5-2. or Figure 5-3.*) in the appropriate direction to lower the tower boom.

6. Lowering the Main Boom (*if necessary*).

With the aid of an assistant, activate the main boom lift function lever (*Figure 5-2. or Figure 5-3.*) in the appropriate direction to lower the main boom.

7. Rotating the platform (*if necessary*).

Activate the appropriate platform rotate function lever (*Figure 5-2. or Figure 5-3.*) to rotate the platform.

8. Leveling the platform (*if necessary*).

Activate the appropriate platform level function lever (*Figure 5-2. or Figure 5-3.*) to level the platform.

9. Release the enable button when finished all boom functions.

10. Remove the manual pump handle from the pump and secure back to its original position on top of the outrigger/track valve cover at the rear of the machine.

### **Outrigger/Track Movement Emergency Procedure:**

#### **Outrigger/Track Movement Using the Hydraulic Hand Pump on Right Side of Machine**

#### **⚠ WARNING**

**PLACE THE MACHINE INTO TRANSPORT CONFIGURATION ONLY AFTER HAVING ALIGNED AND FULLY LOWERED AND RETRACTED THE BOOM AND JIB.**

#### **⚠ WARNING**

**WHEN RETRACTING THE OUTRIGGERS, THE MACHINE CAN BECOME UNBALANCED IF ONE OR MORE OUTRIGGERS ARE OFF OF THE GROUND AT ANY ONE TIME. RETRACT OUTRIGGERS EQUALLY, TO KEEP MACHINE BALANCED.**

#### **Outrigger Functions:**

1. At the rear of the machine, locate the three and four ground control proportional valve groups with manual override levers. The manual override levers on these proportional valves provide function to the right and left side outriggers and right and left track functions.
2. Locate and remove the manual pump handle secured to the top cover above the ground control proportional valve groups at the rear of the machine.
3. Install the pump handle on the manual hydraulic pump on top of the hydraulic tank on right side of

machine, secure in place with the provided screw.  
(*item 3 - Figure 5-4.*)

- Set the lever on the hydraulic hand pump (*item 2 - Figure 5-4.*), it must be **positioned up** to provide hydraulic pressure to operate **right side** outrigger, track functions, and boom components. When **positioned down** hydraulic pressure is provided to the **left side** outrigger, and track functions. (*See following decal.*)

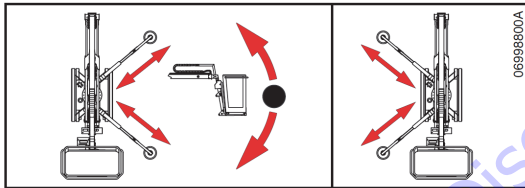

### For left side (operator's (platform) perspective) Outrigger and Track Functions

- Locate the proportional flow valve on the left side of the chassis attached to the group of four valves (*item 1 - Figure 5-6.*). Push and hold the black knob before activating any function lever.
- The lever on the hydraulic hand pump (*item 2 - Figure 5-4.*) must be **positioned down** to manually provide pressure to operate **left side** outrigger and track functions.

- With the aid of an assistant, activate the lever up or down for the desired direction on the appropriate valve solenoid while pumping the handle to achieve the desired function movement.

- 1st valve (*item 2 - Figure 5-6.*) (far left (at rear of machine) in the group of four) operates Left Rear Outrigger.
- 2nd valve (*item 3 - Figure 5-6.*) from the left in the group of four operates Left Front Outrigger.
- 3rd valve (*item 4 - Figure 5-6.*) from the left in the group of four operates the Left Track Drive functions.

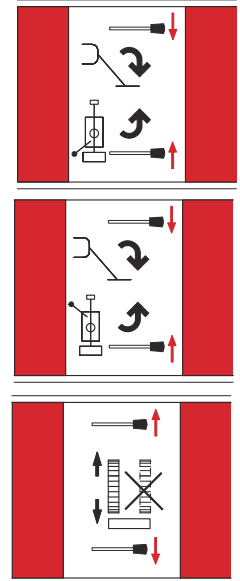

## SECTION 5 - EMERGENCY PROCEDURES

- 4th valve (item 5 - Figure 5-6.) from left in the group of four, operates track extension and retraction.

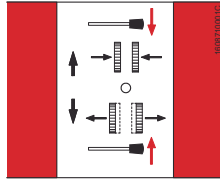

### For right side (operator's (platform) perspective) Outrigger and Track Functions:

8. Locate the proportional flow valve on the right side of the chassis attached to the group of three valves (item 6 - Figure 5-6.). Push and hold the black knob before activating any function lever.
9. The lever on the hydraulic hand pump (item 2 - Figure 5-4.) must be **positioned up** to manually provide pressure to operate **right side** outrigger and track functions.
10. With the aid of an assistant, activate the lever for the desired direction on the appropriate valve solenoid (valve description below) while pumping the pump handle to achieve the desired function movement.

- 1st valve (item 7 - Figure 5-6.) (far right-right side of machine in the group of three) operates Right Rear Outrigger

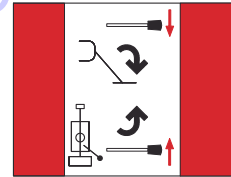

- 2nd valve (item 8 - Figure 5-6.) from the right in the group of three operates Right Front Outrigger

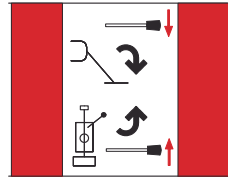

- 3rd valve (item 9 - Figure 5-6.) from the right in the group operates the Right Track Drive functions.

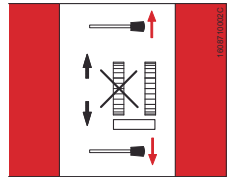

11. Remove the manual pump handle from the pump and secure it in its original position.



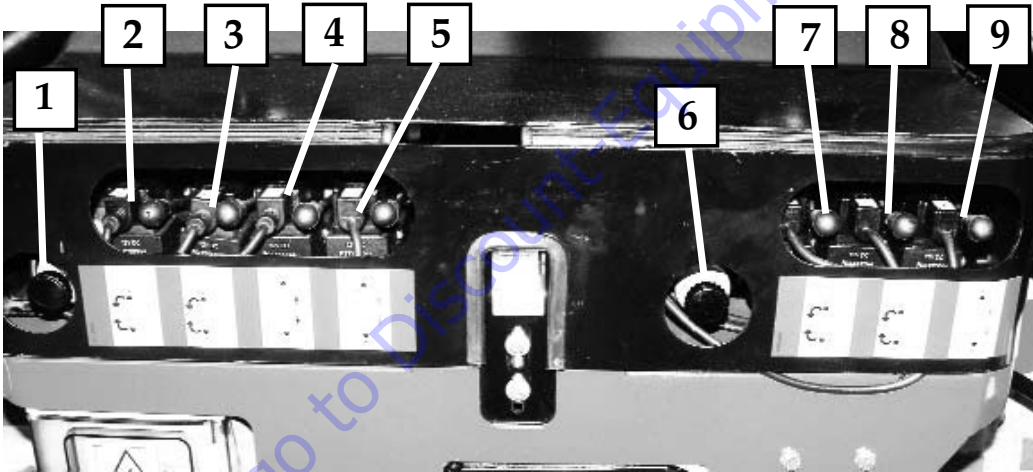

**Figure 5-6. Ground Component Valves - Outriggers/Track Control - Location**

## SECTION 5 - EMERGENCY PROCEDURES

### 5.4 SAFETY DEVICES BYPASS KEY USE

#### **⚠ WARNING**

**THIS FEATURE MUST ONLY BE USED AS DESCRIBED BELOW. THE MACHINE COULD TIP OVER IF THESE DIRECTIONS ARE NOT FOLLOWED.**

The machine requires a key for bypassing the platform safety systems. To activate the safety device bypass switch (item 2 - photo), locate the key set. From the factory the key set is fastened to the cover screw mounting tab (item 1 - photo) on the left side of the electrical components compartment on the right side of the machine.

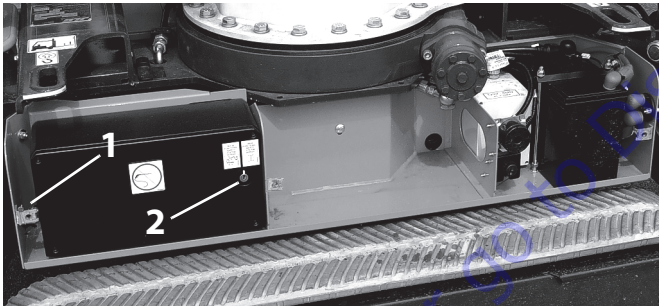

Remove the key and insert it into the bypass key switch (item 2 - photo).

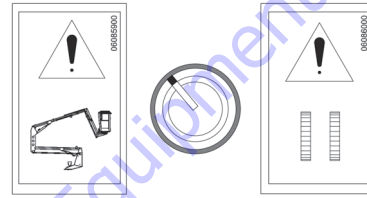

- Turn the key to the LEFT for boom operations.
- Turn the key to the right for TRACK operation.

After using the safety device bypass, a qualified JLG mechanic must be contacted to determine the reason for needing to use this feature.

Return the key to the where you found it and secure it in that location.

The safety device circuit board records every time the safety device bypass key is activated along with the movements made during these operations.

#### **⚠ WARNING**

**THE SAFETY DEVICE BYPASS ALLOWS OPERATION OF THE MACHINE WITH AN OVERLOAD IN THE PLATFORM. THE OVERLOAD ALARM WILL SOUND AND THE OVERLOAD ICON WILL BE ON THE PLATFORM/REMOTE CONTROL BOX DISPLAY. REMOVE THE OVERLOAD FROM THE PLATFORM BEFORE OPERATION.**

### Using The Emergency Descent In The Case Of An Outrigger Losing Contact With The Ground

One or more of the outriggers may lose contact with the ground which will result in the platform/remote control box functions being inoperable except for emergency lowering.

To restore platform/remote control box functions, lower and retract the booms and then reposition the machine and properly set the outriggers.

Use the emergency descent from the platform if possible by using the following sequence, fully retract main boom, fully lower jib, fully lower tower boom, and fully lower main boom.

If this is not possible, have a properly trained person on the ground bypass the platform safety devices and allow the operator in the platform to lower and retract the booms or allow emergency manual operations to bring the platform back to the ground.

1. Locate and use the safety device bypass key as stated above.
2. Activate the safety device bypass by turning the key in a counterclockwise direction and hold it in position (see decal).
3. The safety devices BYPASS icon will appear on the platform/remote control box display.



4. Operate the machine from the platform/remote control ONLY carrying out operations that allow the tower boom lowering, main boom retract and jib lowering. The main boom must be fully retracted prior to operating swing and main boom lowering functions.

### **⚠ WARNING**

**NEVER PERFORM OPERATIONS DIFFERENT TO THOSE LISTED OR THAT CAN IN SOME WAY REDUCE THE STABILITY OF THE MACHINE. THE ORDER OF THE BOOM MOVEMENTS MUST BE DONE IN A WAY TO PREVENT ANY OPERATION THAT REDUCES THE STABILITY OF THE MACHINE.**

5. Once the booms and jib are fully lowered and aligned, release the key and follow the instructions above to secure the key.

## SECTION 5 - EMERGENCY PROCEDURES

### Machine Realignment Emergency Procedure

**THIS OPERATION MUST ONLY BE PERFORMED WITH THE BOOMS AND JIB FULLY LOWERED AND RETRACTED.**

During transport, the turntable may swing and become out of alignment with the base. If this occurs, one of the two EMERGENCY PROCEDURES given below can be used:

#### Machine Realignment:

1. Open the electric components compartment;
2. Locate and use the safety device bypass key as described above;
3. Activate the safety device bypass by turning the key in a counterclockwise direction and holding it in position (see decal beside key switch);
4. The safety devices BYPASS icon will appear on the platform/remote control box LCD display. 
5. Realign the machine while operating the swing function from the platform/remote control box.
6. Once the machine is aligned, release the key and store it as stated above.

**Movement Of The Tracks With The Machine Not Aligned: OPERATION ONLY ALLOWED TO GO TO A CONDITION SUITABLE TO CARRY OUT THE PROCEDURE INDICATED IN "MACHINE REALIGNMENT" ABOVE. ALL OTHER USE IS PROHIBITED.**

1. Open the electric components compartment;
2. Locate and use the safety device bypass key as described above;
3. Activate the safety device bypass key by turning it in a clockwise direction and holding it in position (see decal);
4. The safety devices BYPASS icon will appear on the platform/remote control box display. 
5. Operate the drive/steer controls with extreme caution.
6. Move the machine to a proper location to perform "Machine Realignment" procedure to realign the machine.
7. At the end of the operation release the key and store it as is described above.

The control circuit board records every activation of the safety device bypass key.

**TO PURCHASE THIS PRODUCT PLEASE CONTACT US**



**Equipment Financing and  
Extended Warranties Available**



**Discount-Equipment.com is your online resource for  
commercial and industrial quality parts and equipment sales.**

**561-964-4949**

**visit us on line @ [www.discount-equipment.com](http://www.discount-equipment.com)**

Select an option below to find your Equipment

**Search by Manufacturer**

**Search by Product Type**

**Request a Quote**

We sell worldwide for the brands: Genie, Terex, JLG, MultiQuip, Mikasa, Essick, Whiteman, Mayco, Toro Stone, Diamond Products, Generac Magnum, Airman, Haulotte, Barreto, Power Blanket, Nifty Lift, Atlas Copco, Chicago Pneumatic, Allmand, Miller Curber, Skyjack, Lull, Skytrak, Tsurumi, Husquvarna Target, Stow, Wacker, Sakai, Mi-T-M, Sullair, Basic, Dynapac, MBW, Weber, Bartell, Bennar Newman, Haulotte, Ditch Runner, Menegotti, Morrison, Contec, Buddy, Crown, Edco, Wyco, Bomag, Laymor, EZ Trench, Bil-Jax, F.S. Curtis, Gehl Pavers, Heli, Honda, ICS/PowerGrit, IHI, Partner, Imer, Clipper, MMD, Koshin, Rice, CH&E, General Equipment, Amida, Coleman, NAC, Gradall, Square Shooter, Kent, Stanley, Tamco, Toku, Hatz, Kohler, Robin, Wisconsin, Northrock, Oztec, Toker TK, Rol-Air, APT, Wylie, Ingersoll Rand / Doosan, Innovatech, Con X, Ammann, Mecalac, Makinex, Smith Surface Prep, Small Line, Wanco, Yanmar

## **SECTION 6. GENERAL SPECIFICATIONS AND OPERATOR MAINTENANCE**

### **6.1 INTRODUCTION**

This section of the manual provides additional necessary information to the operator for proper operation and maintenance of this machine.

The maintenance portion of this section is intended as information to assist the machine operator to perform daily maintenance tasks only, and does not replace the more thorough Preventive Maintenance and Inspection Schedule included in the Service and Maintenance Manual.

#### **NOTICE**

**IT IS GOOD PRACTICE TO AVOID PRESSURE-WASHING ELECTRICAL/ELECTRONIC COMPONENTS. IN THE EVENT PRESSURE-WASHING THE MACHINE IS NEEDED, ENSURE THE MACHINE IS SHUT DOWN BEFORE PRESSURE-WASHING. SHOULD PRESSURE WASHING BE UTILIZED TO WASH AREAS CONTAINING ELECTRICAL/ELECTRONIC COMPONENTS, JLG INDUSTRIES, INC. RECOMMENDS A MAXIMUM PRESSURE OF 750 PSI (52 BAR) AT A MINIMUM DISTANCE OF 12 INCHES (30.5 CM) AWAY FROM THESE COMPONENTS. IF ELECTRICAL/ELECTRONIC COMPONENTS ARE SPRAYED, SPRAYING MUST NOT BE DIRECT AND BE FOR BRIEF TIME PERIODS TO AVOID HEAVY SATURATION.**

**6.2 OPERATING SPECIFICATIONS**

**Table 6-1. Operating Specifications**

Model	X600AJ
Maximum work load (capacity)	500 lb. (230 kg)
Max. Vertical Platform Height	59.22 ft. (18.05 m)
Max. Horizontal Platform Reach	31.82 ft. (9.70m)

**Dimensional Data**

**Table 6-2. Dimensional Data**

Model	X600AJ
Overall Width ( <i>with platform removed-tracks retracted</i> )	31.29 in. (80cm)
Outriggers Deployed Width	9.58 ft. x 9.58 ft. (2.92 m x 2.92 m)
Stowed Height	78.66 in. (1.998m)
Stowed Length	16 ft. 5 in. (5.01m)
Approach angle with Jib Lowered	20°
Departure angle	20°

## SECTION 6 - GENERAL SPECIFICATIONS AND OPERATOR MAINTENANCE

### Chassis

**Table 6-3. Chassis Data**

Model	X600AJ
Maximum Travel Grade w/ boom in stowed position (gradeability)	15° (26%)
Maximum Travel Side Slope w/ boom in stowed position	12° (21%)
Turning radius	0°
Maximum ground pressure per track (psi)	9.2 psi (0.64 daN/cm <sup>2</sup> )
Maximum ground pressure per outrigger	45 psi (3.04 daN/cm <sup>2</sup> )
Maximum outrigger pad load (per pad)	4,833 ft.-lb. (2,150 daN)
Outrigger pad diameter	11.8 in (300 mm)
Max drive speed (Gas Engine) w/ 2nd Speed	0.31 mph (0.5 km/hr) 0.81 mph (1.3 km/hr) 1.55 mph (2.5 km/hr)
Max hydraulic system pressure	Track/Outrigger: 2,393 psi (165 bar) Boom: 2,683 psi (185 bar)
Maximum wind speed	28 mph (12.5m/s)
Maximum manual force	90 lb. (400 N)
Electrical system voltage	
Charger/Platform Plug - AC:	120V
Gasoline Engine/Start Battery/System - DC:	12V
Lithium-Ion Battery Pack/Electric Motor:	72V

**Table 6-3. Chassis Data**

Model	X600AJ
Gross machine weight (platform empty)	
Gas Engine:	6,350 lb. (2880 kg)
72V Lithium-Ion:	6,571 lb. (2980 kg)

### Capacities

**Table 6-4. Capacities**

Model	X600AJ
Hydraulic Tank	10.56 gal. (40 L)
Fuel Tank	Gasoline: 1.55 gal. (5.9 L)
Engine Oil	Gasoline: 0.3 gal. (1.1 L)



## SECTION 6 - GENERAL SPECIFICATIONS AND OPERATOR MAINTENANCE

### Engine Data

Table 6-5. Honda iGX440 Specifications

Model	X600AJ
Type	Gasoline/Air cooled
Number of cylinders	1
Displacement	27 cu. in. (440 cm <sup>3</sup> )
Output	12.74 hp (9.5 kW)
High engine speed	3600 RPM
Torque (Max.)	22 ft. lb. / 29.8 Nm @ 2500 RPM

### Lithium-Ion Specifications

Table 6-6. Lithium Ion Specifications

Model	X600AJ
<b>Battery Pack</b> No. of cells in the battery pack: Rated voltage of each cell: Max. cell voltage: Min. cell voltage: Features of complete pack: *Charge cycles: Cathode: Anode: Memory effect:	22 cells 3.2 volt 3.65 volt 2.5 volt 72 volt @ 100 Amp/hr 2000 cycles Lithium Ion Phosphate (LiFePO <sub>4</sub> ) Graphite NO
<b>Battery Charger</b> Type: Necessary time to recharge:	120 V (+/- 10%) - 50/60 Hz 8 hrs to Balance - 6 hrs. to 80% of recharge
<b>Electric System</b>	72 volt for the batteries - 12 volt for the machine
<b>Electric Motor</b>	72 volt - three phase - 3500 watt
* The charge cycles have to be considered based on the fact that there is not memory effect in the lithium batteries, i.e. 2000 charges at 100% or 4000 charges at 50%, etc..	

## SECTION 6 - GENERAL SPECIFICATIONS AND OPERATOR MAINTENANCE

### Machine Major Component Weights

**Table 6-7. Major Component Weights**

Model	X600AJ
Engine (tank full) Gasoline:	86 lb. (39 kg)
Lithium Ion Battery Pack (72V)	401 lb. (182kg)
Boom Sections Combined	3,104 lb. (1408 kg)
Lift Cylinders	Level Cylinder: 17.6 lb. (8 kg) Jib Cylinder: 26.4 lb. (12 kg) 3rd boom level cylinder: 117.5 lb. (53.3 kg) Lift cylinder: 15.4 lb. (7 kg) Upper lift cylinder: 117.5 lb. (53.3 kg) Swing Actuator: 37.4 lb. (17 kg) Telescope cylinder: 135.5 lb. (61.5 kg)
Platforms 2- occupant:	79,3 lb. (36 kg)
Chassis	2,802 lb. (1271 kg)

### Performance

**Table 6-8. Function Speeds**

FUNCTION	X600AJ TIME (SECONDS)
Telescope	Extend: 21 - 28 Retract: 16 - 20
Tower Boom	Up: 30 - 35 Down: 30 - 35
Upper Boom	Up: 35 - 40 Down: 35 - 40
Basket Rotate	Right: 7 - 10 Left: 7 - 10
Swing	Left: 45 - 50 Right: 45 - 50
Jib	Up: 7 - 10 Down: 7 - 10
Basket Level	Up: 33 - 55 Down: 37 - 50

**6.3 SERVICE/MAINTENANCE**

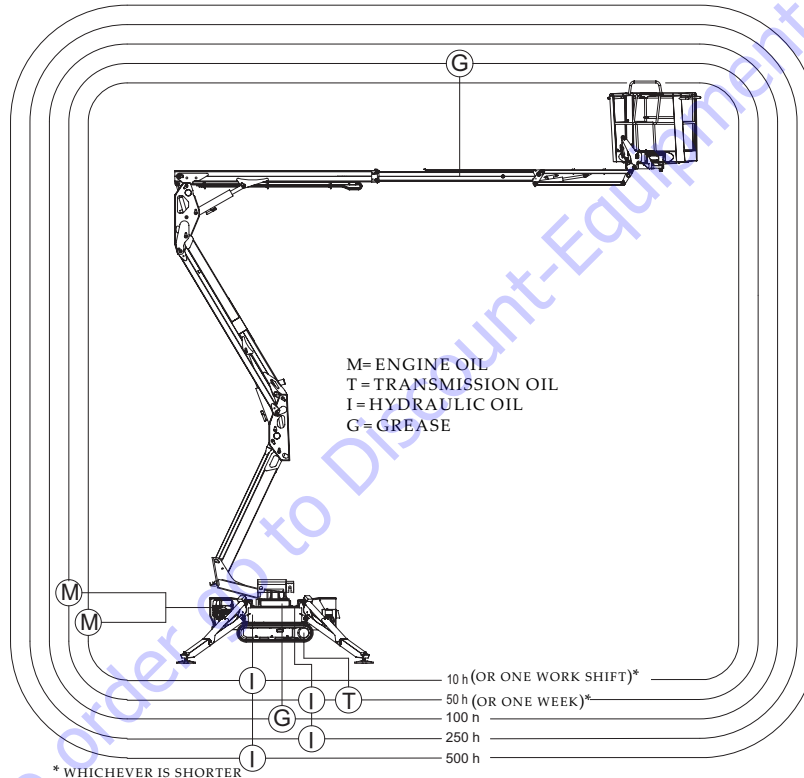

**Figure 6-1. Lubrication and Maintenance Point Locations**

**⚠ WARNING**

FOLLOW THE LUBRICATION INTERVALS INDICATED AND USE ONLY THE RECOMMENDED LUBRICANTS IN ORDER TO PROTECT PINS AND CONNECTIONS FROM WEAR.

**Lubrication**

(See Figure 6-1.)

**Hydraulic Oil**

**Table 6-9. Hydraulic Oil Specifications**

Hydraulic System Operating Temperature Range	Viscosity Grade
14deg F (-10 deg C) and 104deg F (+40deg C)	ISO VG 46
14deg F (-10 deg C) or above 104deg F (+40deg C)	ISO 68

**NOTE:** When adding or replacing hydraulic oil only use JLG approved hydraulic oil. Do not mix oils unless directed by JLG.

**Recommended Gearbox Oils**

600 XP 150

EP 150

Blasia 150

Spartan EP150

**Engine Oil**

SAE 10W30

**Greasing and Lubrication**

Recommended lubricants

Contact Grease EP (blue in color) be used to grease the turntable and cylinder pins on the chassis

GR MU EP1 Grease be used to grease the expansion guide of the chassis, the track tension valve, and basket support pins

White EP NLGI 2 Grease be used on the boom extensions

Either MU EP1 or Esso Beacon EP2 be used to grease the coupler and belt tensioner

**Greasing Locations (See Figure 6-1.)**

**NOTE:** Use a brush to spread grease onto telescopic boom wear pad areas.

## SECTION 6 - GENERAL SPECIFICATIONS AND OPERATOR MAINTENANCE

### Hydraulic Oil Specifications

Fluid  Description	Proprieties		Base				Classifications		
	Viscosity at 40°C (cst, Typical)	Viscosity Index	Mineral Oils	Vegetable Oils	Syntetic	Syntetic Polyol Esters	Readily Biodegradable*	Virtually Non-toxic**	Fire Resistant***
Pakelo Hydraulic EP Extra ISO 68	68	180	X						
Pakelo Hydraulic EP Extra ISO 46	46	160	X						
GeolubeECO Hydraulic ISO 46 (P/N 17527700)	47.3	144				X	X		
Pakelo Hydraulic EP Extra ISO 32	32	160	X						
Pakelo Hydraulic EP Extra ISO 22	22	180	X						
SHELL TELLUS S3V 68	68	180	X						
SHELL TELLUS S3V 46	46	160	X						
MobilEAL EnviroSynH46 (P/N2300029)	46	145				X	X		
SHELL TELLUS S3V 32	32	160	X						
SHELL TELLUS S3V 22	22	180	X						

**Figure 6-2. Hydraulic Oil Specifications**

\* Readily biodegradable classification indicates one of the following: CO2 Conversion > 60% per EPA 560/6-82-003 / CO2 Conversion > 80% per CEC-L-33-A-93.

\*\* Virtually Non-toxic classification indicates an LC50 > 5000 per OECD 203.

\*\*\* Fire Resistant classification indicates Factory Mutual Research Corp. (FMRC) Approval.

## SECTION 6 - GENERAL SPECIFICATIONS AND OPERATOR MAINTENANCE

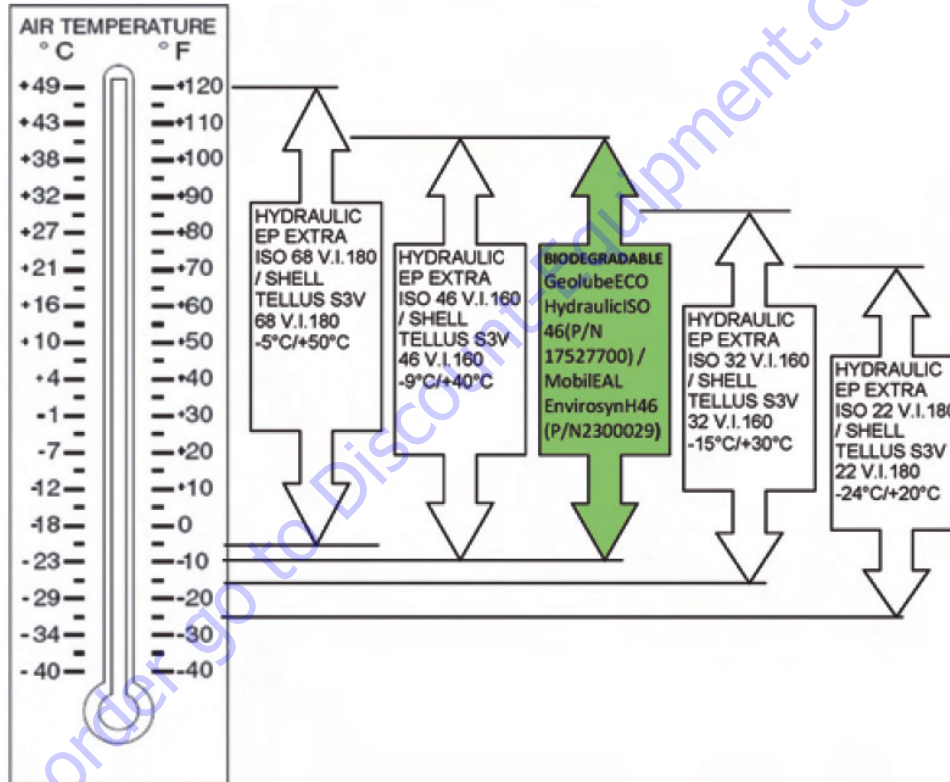

Figure 6-3. Hydraulic Oil Operating Temperatures

## SECTION 6 - GENERAL SPECIFICATIONS AND OPERATOR MAINTENANCE

### HONDA GAS ENGINE

PART	INTERVENTION	BEFORE STARTING	AS NEEDED	INTERVAL (HOURS)						
				10	50	100	250	500	1000	2000
DRY AIR FILTER	CHECK, CLEAN	•								
	CHANGE							•		
ENGINE OIL	CHECK LEVEL	•		•						
	CHANGE				•*		•			
OIL SUMP	CLEAN					•				
FUEL TANK AND NET	CLEAN							•		
HYDRAULIC OIL	CHECK LEVEL	•								
	CHANGE								•	
HYDRAULIC OIL FILTER	CHANGE CARTRIDGE				•*		•			
ARTICULATED JOINT POINTS	GREASE				•*	•				
BATTERY	CHECK ELECTROLYTE LEVEL		•							
REDUCTION GEAR OIL	CHECK LEVEL					•				
	CHANGE					•*			•	
MACHINE	GENERAL PERIODICAL CHECKS								•	•*
EXTENSION ARM INTERNAL SLIDING RING	CHECK WEAR						•			
	CHANGE								•	
TURNTABLE BOLT TIGHTENING	CHECK						•*	•		
PLATFORM MOUNT PIN NUTS	CHECK TORQUE 200 Nm								•	#



- \* First time service interval then per chart thereafter.
- \*\* Every 3 months or 1000 hrs of operation.
- \*\*\* Every 5 years or 2000 hrs of operation.
- # Check every year. If the torque is not correct replace the nuts with two new nuts of the same specification. Install dry without using oil or grease to specified torque.

Figure 6-4. Component Maintenance Intervals - with Honda Engine

## SECTION 6 - GENERAL SPECIFICATIONS AND OPERATOR MAINTENANCE

LITHIUM-ION  
MACHINE

PART	MAINTENANCE WORK	BEFORE STARTING	AS NEEDED	INTERVAL (HOURS)						
				10	50	100	250	500	1000	2000
HYDRAULIC OIL	CHECK LEVEL	•								
	CHANGE								•	
HYDRAULIC OIL FILTER	REPLACE CARTRIDGE				• *		•			
ARTICULATE JOINT POINTS	GREASING				• *	•				
REDUCTION GEAR OIL	CHECK LEVEL					•				
	CHANGE				• *				•	
MACHINE	GENERAL PERIODICAL CHECKS								•	• *
EXTENSION ARM INTERNAL SLIDING RING	CHECK WEAR						•			
	REPLACE								•	
TURNTABLE BOLT TIGHTENING	CHECK						• *	•		



\* First time service interval then per chart thereafter.

\*\* Every 3 months or 1000 hrs of operation.

\*\*\* Every 5 years or 2000 hrs of operation.

# Check every year. If the torque is not correct replace the nuts with two new nuts of the same specification. Install dry without using oil or grease to specified torque.

**Figure 6-5. Component Maintenance Intervals - X600AJ - Lithium-Ion Machine**



## SECTION 6 - GENERAL SPECIFICATIONS AND OPERATOR MAINTENANCE

### Engine Air Filter

Honda  
Gas

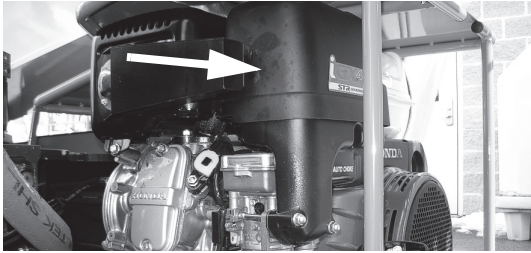

Lube Point(s) - Replaceable Paper Element, or Foam Filter Element

Interval - Check daily. Replace paper element after 500 hrs of operation, sooner if operating in a dusty environment.

The foam element can be washed out in warm soapy water, then rinse and let dry, Dip in clean engine oil and squeeze out the excess oil. If too much oil is left in the foam the engine will smoke when started.

### Engine Oil

Honda  
Gas

DIPSTICK

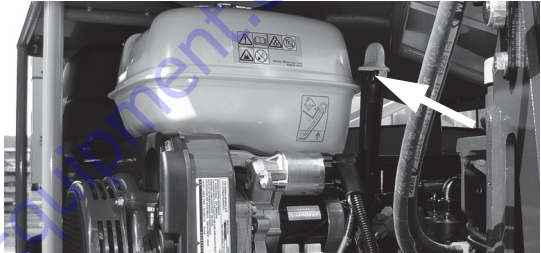

Lube Point(s) - Fill Cap/Dip Stick Tube

Capacity - Gasoline 0.3 gal (1.1L)

Diesel 0.39 gal (1.5 L)

Interval - Check fill level on dipstick daily. Do not overfill.  
Change oil per maintenance interval chart -  
(Figure 6-4.)

## SECTION 6 - GENERAL SPECIFICATIONS AND OPERATOR MAINTENANCE

### Engine Fuel Filter/Sediment Bowl (if equipped)

Honda  
Gas

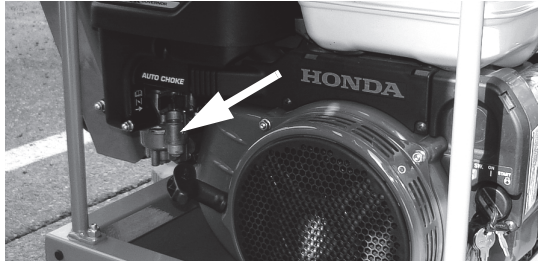

Interval - Clean or replace every 500 hours

### Hydraulic Oil

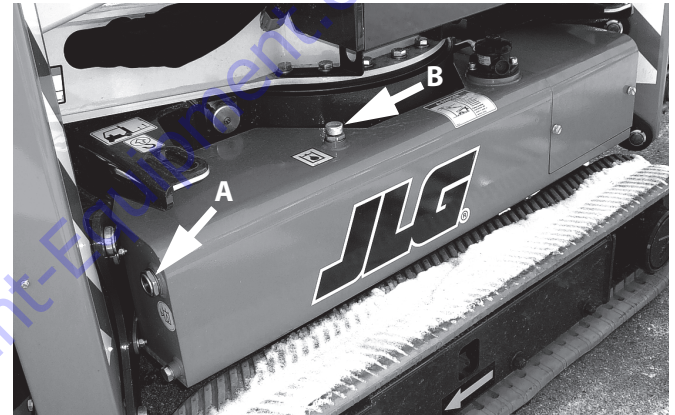

Lube Point(s) - Fill Cap

Capacity - 6.6 gallons (25 liters)

Interval - Check level daily. Change every two years or 1200 hours of operation

**NOTE:** Hydraulic oil levels are to be checked with the machine in transport position while on a firm, level and uniform surface. Oil level must be half-way in the level indicator (Indicator-A). To add hydraulic oil use (cap-B).

## SECTION 6 - GENERAL SPECIFICATIONS AND OPERATOR MAINTENANCE

### Hydraulic Oil Filter Cartridge

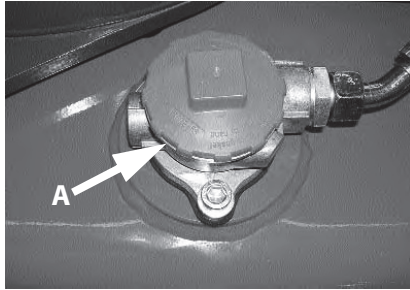

Lube Point(s) - Filter Cap (Indicator A)

Interval - Replace after first 50 hours of use. Replace thereafter every 250 hours and every time the hydraulic oil is replaced.

### Rubber Track Maintenance/Replacement

#### Check track tension

Stop the machine on a firm, level, and uniform surface. Raise the machine off the surface using the outriggers. Measure distance A from the bottom of the roller to the inside of the rubber belt. The rubber track tension is to be between 0.4 inches (10mm) and 0.6 inches (15mm).

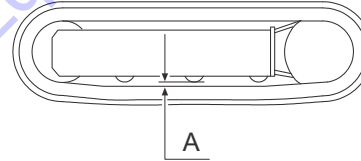

**NOTE:** If the track is out of tolerance immediately discontinue use of the machine

#### **⚠ WARNING**

**THE GREASE CONTAINED WITHIN THE HYDRAULIC TRACK IS PRESSURIZED. NEVER LOOSEN GREASING VALVE 1 MORE THAN ONE (1) TURN. NEVER LOOSEN GREASE VALVE 2.**

## SECTION 6 - GENERAL SPECIFICATIONS AND OPERATOR MAINTENANCE

1. Ensure all debris has been removed between the wheel teeth and track links.
2. Remove the screws from the adjustment access lid
- 3.

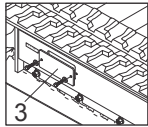
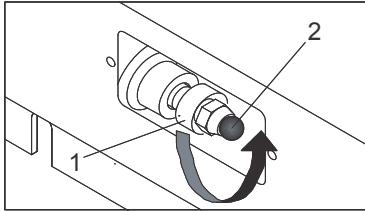

3. Loosening of the track.
4. Slowly unscrew valve 1 in the counterclockwise direction. Do not exceed one (1) screw rotation.
5. If the grease does not begin to drain, slowly rotate the track.
6. Once correct track tension has been achieved, turn grease valve 1 clockwise to tighten valve.
7. Clean area of all trace grease.



### Tightening of the track

- Connect a grease gun to grease valve (2) and add grease until belt tension is within the specified values.

**NOTE:** If the track does not return to the specified values by following the above procedure immediately discontinue use and contact service personnel.

### Checking the rubber tracks

- If broken steel ropes are noted discontinue use until damaged components are replaced

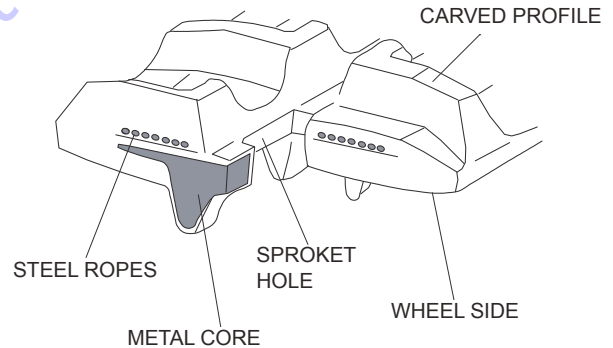

- If broken metal cores are noted discontinue use until damaged components are replaced

## SECTION 6 - GENERAL SPECIFICATIONS AND OPERATOR MAINTENANCE

- If metal cores are separating discontinue use of the machine until the damaged components are replaced.

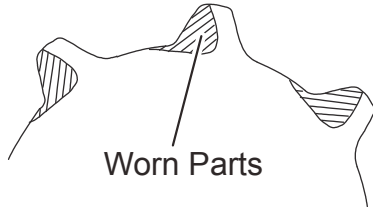

- If abrasive or fatigue cracks are noted it is recommended the machine be removed from service until the components are replaced.



### Track Torque

It is extremely important to apply and maintain proper track mounting torque.

### **⚠ WARNING**

**TRACK NUTS MUST BE INSTALLED AND MAINTAINED AT THE PROPER TORQUE TO PREVENT LOOSENING OF THE TRACK, BROKEN STUDS, AND POSSIBLE DANGEROUS SEPARATION OF THE TRACK FROM THE TEETH.**

### Replacing Rubber Tracks

1. Elevate the machine on firm, level and uniform surface utilizing the outriggers.
2. Remove the screws and remove cover 3 as shown in figure.

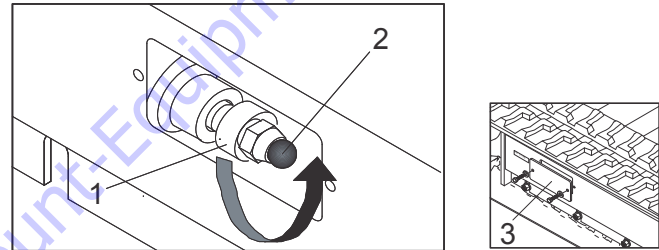

3. To loosen the track, slowly unscrew valve 1 in a counter-clockwise direction. Do NOT exceed one (1) rotation.
4. Allow grease to drain. If grease does not drain, slowly rotate the track.
5. Insert three steel pipes 4 between the rollers of the track. Turn the driving wheel backwards 5 to engage the track tensioning wheel. Apply an outward force 6 to lift the track from the track tensioning wheel.

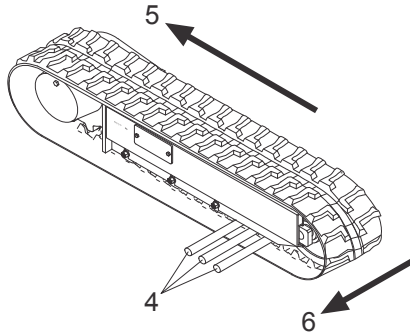

### Wear Pad Inspection

Check for distance between wear pads and boom sections. Distance is to be no more than 1/32nd inch.

### Turntable Attach Bolts

Ensure the bolts of the coupling elements (turntable) are torqued to 183 ft-lb. (248 Nm)

### Installation of Rubber Track

1. Ensure all hydraulic cylinder grease have been removed
2. Align the track links with the wheel teeth. Position the other end of the track on the track tensioning wheel
3. Slowly rotate the drive wheel in reverse while, using one steel pipe, pushing the track plate inside the frame.
4. Verify the track links have engaged the wheel teeth in the track tensioning wheel
5. Adjust track tension (see Loosening/Tightening track section).

## SECTION 6 - GENERAL SPECIFICATIONS AND OPERATOR MAINTENANCE

---

### Battery Maintenance and Charging - Gas/AC-Electric

**NOTE:** *The battery is a maintenance free battery. Do NOT attempt to open a maintenance-free sealed battery.*

#### External Battery Charger Use

#### **WARNING**

**WHEN AN EXTERNAL BATTERY CHARGER IS TO BE USED, CHARGING HARNESS MUST BE PLUGGED INTO A GROUNDED RECEPTACLE. IF RECEPTACLE IS NOT GROUNDED AND A MALFUNCTION SHOULD OCCUR, THE MACHINE COULD CAUSE SERIOUS ELECTRICAL SHOCK.**

1. Open battery cover.
2. Disconnect the terminal clamps from the battery poles.
3. Connect the cables of the charger to the battery poles. and turn on the battery charger

**NOTE:** *Re-charge voltage should never exceed 14.7 volts and the load intensity shall be 0.2% of the value indicated below and on the lid of the battery.*

4. When charging is completed turn off the battery charger before disconnecting the cables from the battery poles
5. Return the terminal clamps to the battery poles and lubricate with the appropriate product
6. Close battery cover.

#### **NOTICE**

**IT IS GOOD PRACTICE TO AVOID PRESSURE-WASHING ELECTRICAL/ELECTRONIC COMPONENTS. IN THE EVENT PRESSURE-WASHING THE MACHINE IS NEEDED, ENSURE THE MACHINE IS SHUT DOWN BEFORE PRESSURE-WASHING. SHOULD PRESSURE WASHING BE UTILIZED TO WASH AREAS CONTAINING ELECTRICAL/ELECTRONIC COMPONENTS, JLG INDUSTRIES, INC. RECOMMENDS A MAXIMUM PRESSURE OF 750 PSI (52 BAR) AT A MINIMUM DISTANCE OF 12 INCHES (30.5 CM) AWAY FROM THESE COMPONENTS. IF ELECTRICAL/ELECTRONIC COMPONENTS ARE SPRAYED, SPRAYING MUST NOT BE DIRECT AND BE FOR BRIEF TIME PERIODS TO AVOID HEAVY SATURATION.**

### 6.4 ELECTRIC MOTOR MAINTENANCE

Periodically check the condition of the following electric motor components.

#### Electric Motor

The electric motor is located inside of the rear hydraulic valve distributor support cover.

- POWER SUPPLY TERMINALS

Check tightness of the nuts on the power supply terminals and make sure the insulation is intact.

- FAN

Keep air intakes clean and make sure the fan can rotate freely.

- BEARINGS

Check the condition of the bearings, in the event of noise contact JLG for replacement, the life of the bearings is reduced significantly in heavy duty operating conditions.

**NOTE:** *This motor is "brushless" therefore no brushes need to be checked or replaced.*



### 6.5 PLATFORM/REMOTE CONTROL SERVICE MENU

#### Service Button

A SERVICE button is present on the remote control which allows to view the status of the machine parameters and is an aid in the safety checks of the machine.

By pressing the SERVICE button a numerical menu is displayed on the LCD display, each of these menu items can be accessed by pressing the corresponding platform/remote control buttons (*numbered 1 thru 9*) below the buttons.

1 - INPUT

2 - LANGUAGE

3 - ERRORS

4 - RAMPS

5 - CURRENT

6 - W. HOURS

7 - SETUP

8 - JOYSTICK

9 - EXIT

MENUS 4; 5; CANNOT BE ACCESSED

## SECTION 6 - GENERAL SPECIFICATIONS AND OPERATOR MAINTENANCE

### Menu Input

The signals that arrive at the board from the various sensors mounted on the machine and from the platform/remote control commands are displayed. The status of the input and the following selection to scroll the menu appears for each screen:

- 1 - PREV - access the previous input
- 2 - NEXT - access the successive input
- 9 - ESC - escape from the INPUT menu

<b>ST1 GND A</b>	<b>ON</b>	Outrigger N° 1 on the ground – the switch is released and A line is closed
	<b>OFF</b>	Outrigger N° 1 lifted – the switch is pressed and A line is opened
<b>ST1 GND B</b>	<b>ON</b>	Outrigger N° 1 on the ground – the switch is released and B line is closed
	<b>OFF</b>	Outrigger N° 1 lifted – the switch is pressed and B line is opened
<b>ST1 OPEN A</b>	<b>ON</b>	Do not consider
	<b>OFF</b>	Do not consider
<b>ST1 OPEN B</b>	<b>ON</b>	Do not consider
	<b>OFF</b>	Do not consider
<b>ST2 GND A</b>	<b>ON</b>	Outrigger N° 2 on the ground – the switch is released and A line is closed
	<b>OFF</b>	Outrigger N° 2 lifted – the switch is pressed and A line is opened
<b>ST2 GND B</b>	<b>ON</b>	Outrigger N° 2 on the ground – the switch is released and B line is closed
	<b>OFF</b>	Outrigger N° 2 lifted – the switch is pressed and B line is opened

## SECTION 6 - GENERAL SPECIFICATIONS AND OPERATOR MAINTENANCE

<b>ST2 OPEN A</b>	<b>ON</b>	Do not consider
	<b>OFF</b>	Do not consider
<b>ST2 OPEN B</b>	<b>ON</b>	Do not consider
	<b>OFF</b>	Do not consider
<b>ST3 GND A</b>	<b>ON</b>	Outrigger N° 3 on the ground – the switch is released and A line is closed
	<b>OFF</b>	Outrigger N° 3 lifted – the switch is pressed and A line is opened
<b>ST3 GND B</b>	<b>ON</b>	Outrigger N° 3 on the ground – the switch is released and B line is closed
	<b>OFF</b>	Outrigger N° 3 lifted – the switch is pressed and B line is opened
<b>ST3 OPEN A</b>	<b>ON</b>	Do not consider
	<b>OFF</b>	Do not consider
<b>ST3 OPEN B</b>	<b>ON</b>	Do not consider
	<b>OFF</b>	Do not consider
<b>ST4 GND A</b>	<b>ON</b>	Outrigger N° 4 on the ground – the switch is released and A line is closed
	<b>OFF</b>	Outrigger N° 4 lifted – the switch is pressed and A line is opened
<b>ST4 GND B</b>	<b>ON</b>	Outrigger N° 4 on the ground – the switch is released and B line is closed
	<b>OFF</b>	Outrigger N° 4 lifted – the switch is pressed and B line is opened

## SECTION 6 - GENERAL SPECIFICATIONS AND OPERATOR MAINTENANCE

<b>ST4 OPEN A</b>	<b>ON</b>	Do not consider
	<b>OFF</b>	Do not consider
<b>ST4 OPEN B</b>	<b>ON</b>	Do not consider
	<b>OFF</b>	Do not consider
<b>BYPASAE A</b>	<b>ON</b>	The aerial part safeties are disconnected through the key button (emergency condition) – “A” line of the aerial part safeties by-pass button is closed.
	<b>OFF</b>	The aerial part safeties are connected (normal working condition) – “A” line of the aerial part safeties by-pass button is opened
<b>BYPASAE B</b>	<b>ON</b>	The aerial part safeties are disconnected through the key button (emergency condition) – “B” line of the aerial part safeties by-pass button is closed.
	<b>OFF</b>	The aerial part safeties are connected (normal working condition) – “B” line of the aerial part safeties by-pass button is opened
<b>BYPASCB A</b>	<b>ON</b>	The ground part safeties are disconnected through the key button (emergency condition)– “A” line of the ground part safeties by-pass button is closed.
	<b>OFF</b>	The ground part safeties are connected (normal working condition) – “A” line of the ground part safeties by-pass button is opened

## SECTION 6 - GENERAL SPECIFICATIONS AND OPERATOR MAINTENANCE

<b>BYPASCB B</b>	<b>ON</b>	The ground part safeties are disconnected through the key button (emergency condition)– “B” line of the ground part safeties by-pass button is closed.
	<b>OFF</b>	The ground part safeties are connected (normal working condition) – “B” line of the ground part safeties by-pass button is opened
<b>EM GRND A</b>	<b>ON</b>	Emergency stop on the ground is released –“A” line of the emergency stop is closed
	<b>OFF</b>	Emergency stop on the ground is pressed – “A” line of the emergency stop is opened
<b>EM GRND B</b>	<b>ON</b>	Emergency stop on the ground is released –“B” line of the emergency stop is closed
	<b>OFF</b>	Emergency stop on the ground is pressed – “B” line of the emergency stop is opened
<b>FOTO A</b>	<b>ON</b>	Photocell A receives the signal from the reflector (Aerial part closed and aligned)
	<b>OFF</b>	Photocell A does not receive the signal from the reflector (Aerial part opened)
<b>FOTO B</b>	<b>ON</b>	Photocell B receives the signal from the reflector (Aerial part closed and aligned)
	<b>OFF</b>	Photocell B does not receive the signal from the reflector (Aerial part opened)
<b>EM.R.C.GND</b>	<b>ON</b>	The emergency stop on ground remote control is released.
	<b>OFF</b>	The emergency stop on ground remote control is pressed or the ground remote control is disconnected

## SECTION 6 - GENERAL SPECIFICATIONS AND OPERATOR MAINTENANCE

<b>PROXIMITY</b>	<b>ON</b>	Turret is not almost completely rotated, contact is close, the 1 <sup>st</sup> -2 <sup>nd</sup> arm is not above the engine
	<b>OFF</b>	Turret is almost completely rotated, contact is open, the 1 <sup>st</sup> -2 <sup>nd</sup> arm is above the engine

<b>EM.R.C.GND</b>	<b>ON</b>	The stop button on ground remote control is released.
	<b>OFF</b>	The stop button on ground remote control is pressed or the ground remote control is disconnected
<b>ST12 CLOSED</b>	<b>ON</b>	The pressure switch of outriggers 1 and 2 closes the contact – the outriggers are at end run and the max pressure valve is opened
	<b>OFF</b>	The pressure switch contact of outriggers 1 and 2 is opened – the outriggers are open, partially open or already closed
<b>ST34 CLOSED</b>	<b>ON</b>	The pressure switch of outriggers 3 and 4 closes the contact – the outriggers are at end run and the max pressure valve is opened
	<b>OFF</b>	The pressure switch contact of outriggers 3 and 4 is opened – the outriggers are open, partially open or already closed
<b>TEMP ALRM A</b> <i>Option reserved for some markets</i>	<b>ON</b>	The temperature external probe reached the maximum value – “A” line of the temperature probe is closed
	<b>OFF</b>	The temperature external probe hasn’t reached the maximum value – “A” line of the temperature probe is open

## SECTION 6 - GENERAL SPECIFICATIONS AND OPERATOR MAINTENANCE

<b>TEMP ALRM B</b> <i>Option reserved for some markets</i>	<b>ON</b>	The temperature external probe reached the maximum value – “B” line of the temperature probe is closed
	<b>OFF</b>	The temperature external probe hasn’t reached the maximum value – “B” line of the temperature probe is open
<b>POS.1 ARM</b>	<b>ON</b>	The switch of 1-2 arm position is released, contact is close, the 1 <sup>st</sup> -2 <sup>nd</sup> arm is open
	<b>OFF</b>	The switch of 1-2 arm position is pressed, contact is open, the 1 <sup>st</sup> -2 <sup>nd</sup> arm is closed
<b>TRACK OPEN</b>	<b>ON</b>	Tracks are in wide position. Widening cylinders switches are pressed, contact is closed
	<b>OFF</b>	Tracks are not in full wide position. Widening cylinders switches are released, contact is open
<b>FREE</b>		Do not consider this signal
<b>EMRG. COMM</b>	<b>ON</b>	The control position key selector for aerial part operation from the ground is activated (emergency condition)
	<b>OFF</b>	The control position key selector for aerial part operation is released (normal working condition)
<b>MICROROPES</b> <i>To consider only for LL20JP - X600AJ</i>	<b>ON</b>	The cables of the extension are OK. The control switch of the cables on extension is released and the line is closed (normal working condition)
	<b>OFF</b>	At list one cable on the extension is out of order. The control switch of the cables on extension is pressed and the line is open (emergency condition)

## SECTION 6 - GENERAL SPECIFICATIONS AND OPERATOR MAINTENANCE

<b>START M.TE</b>	<b>ON</b>	The ground button for engine start is pressed
	<b>OFF</b>	The ground button for engine start is released
<b>MOTOR TEMP</b> <i>To consider only for X20JP - X600AJ</i>	<b>ON</b>	The engine reached the max functioning temperature (emergency condition – the engine remains at min)
	<b>OFF</b>	The engine maintains the correct functioning temperature (normal working condition)
<b>MOTOR PRES</b> <i>To consider only for X20JP - X600 AJ</i>	<b>ON</b>	The engine oil pressure is inadequate (emergency condition – engine turns off)
	<b>OFF</b>	The engine oil pressure is OK
<b>START M.EL</b>	<b>ON</b>	The ground button for electric motor start is pressed
	<b>OFF</b>	The ground button for electric motor start is released
<b>GND/BASKET</b>	<b>ON</b>	The control position key selector is positioned on “basket”
	<b>OFF</b>	The control position key selector is positioned on “ground”
<b>MICROJIB A</b>	<b>ON</b>	The JIB is closed – the control switch is released and “A” line is closed
	<b>OFF</b>	The JIB is open – the control switch is pressed and “A” line is open
<b>MICROJIB B</b>	<b>ON</b>	The JIB is closed – the control switch is released and “B” line is closed
	<b>OFF</b>	The JIB is open – the control switch is pressed and “B” line is open



## SECTION 6 - GENERAL SPECIFICATIONS AND OPERATOR MAINTENANCE

<b>PEDAL</b>	<b>ON</b>	The pedal is pressed– the pedal electric line is closed
	<b>OFF</b>	The pedal is released – the pedal electric line is open
<b>FREE B</b>		Do not consider this signal
<b>EM.BASK.A</b>	<b>ON</b>	The stop button on remote control in basket is released – “A” line is closed
	<b>OFF</b>	The stop button on remote control in basket is pressed or the ground remote control is disconnected – “A” line is open
<b>EM.BASK. B</b>	<b>ON</b>	The stop button on remote control in basket is released – “B” line is closed
	<b>OFF</b>	The stop button on remote control in basket is pressed or the ground remote control is disconnected – “B” line is open
<b>POSM1 A</b>	<b>ON</b>	Do not consider
	<b>OFF</b>	Do not consider
<b>POSM1 B</b>	<b>ON</b>	Do not consider
	<b>OFF</b>	Do not consider
<b>POSM2 A</b>	<b>ON</b>	Do not consider
	<b>OFF</b>	Do not consider

## SECTION 6 - GENERAL SPECIFICATIONS AND OPERATOR MAINTENANCE

<b>POSM2 B</b>	<b>ON</b>	Do not consider
	<b>OFF</b>	Do not consider
<b>POSM3 A</b>	<b>ON</b>	Do not consider
	<b>OFF</b>	Do not consider

<b>POSM3 B</b>	<b>ON</b>	Do not consider
	<b>OFF</b>	Do not consider
<b>POSM4 A</b>	<b>ON</b>	Do not consider
	<b>OFF</b>	Do not consider
<b>POSM4 B</b>	<b>ON</b>	Do not consider
	<b>OFF</b>	Do not consider
<b>R.C. BASKET</b>	<b>ON</b>	The remote control is in the support in basket
	<b>OFF</b>	The remote control is not in the support in basket

## SECTION 6 - GENERAL SPECIFICATIONS AND OPERATOR MAINTENANCE

<b>INCLIN. X</b>	<b>0</b>	Indicates the inclination of the machine on the X axis in tenth of degrees (accelerometer A)
	<b>0</b>	Indicates the inclination of the machine on the X axis in tenth of degrees (accel B)
<b>INCLIN. Y</b>	<b>0</b>	Indicates the inclination of the machine on the Y axis in tenth of degrees (accelerometer A)
	<b>0</b>	Indicates the inclination of the machine on the Y axis in tenth of degrees (accel B)
<b>LOAD</b>	<b>94</b>	Indicates the weight in Kg in the basket
<b>POS. 1E2</b>	<b>0</b>	Do not consider
<b>POS. 3</b>	<b>2398</b>	Indicates the opening of the 3 arm cylinder in tenths of a millimetre
<b>ROTATION A</b>	<b>180</b>	Do not consider
<b>MOTOR RPM Diesel Only</b>	<b>2200</b>	Indicate the engine RPM

## SECTION 6 - GENERAL SPECIFICATIONS AND OPERATOR MAINTENANCE

<b>CURRENT A</b>	<b>2,5</b>	Indicates (in tenth of mA) the current ECM1-2 is sending to the aerial part proportional valve or to the left-side undercarriage proportional valve (values less than 5 not relevant)
<b>CURRENT B</b>	<b>45,3</b>	Indicates (in tenth of mA) the current ECM1-2 is sending to the right-side undercarriage proportional valve (values less than 5 not relevant)
<b>CURRENT C</b>	<b>0</b>	Do not consider
<b>TEMPERAT.</b>	<b>37,6</b>	Indicates the temperature of the control module in C°
<b>SUPPLY (V)</b>	<b>12,1</b>	Indicates the batteries voltage, or the output voltage from the battery charger
<b>BATTERY %</b>	<b>100</b>	Only for Lithium version: indicates the % level of charge of the pack

### Errors Menu

Indicates the agreement (OK) or not (FAULT) status of the sensors that have a double control.

The sensors are listed on different screens use:

- 1 - PREV - access the previous input
- 2 - NEXT - access the successive input
- 9 - ESC - escape from the INPUT menu

If the OK symbol appears at the side of the sensor it means that the two elements of the same sensor sent identical information.

If the FAULT symbol appears at the side of the sensor it means that the two elements of the same sensor sent inconsistent information.

The last page of the error menu describes the error code relating to the battery charger system, inverter or battery pack. (See "Lithium-Ion Machine Fault Codes" on page 6-36.)

Errors are indicated by the "spanner" icon in position 7 on the remote control display (See "" on page 3-16.).



If there are operating problems with the machine and the "spanner" icon is shown on the display, do not operate machine until repaired by a JLG factory trained technician.

### Working Hours Menu

Indicates the number of machine working hours.

### Set-up Menu

The items in this menu cannot normally be accessed.

### Joystick Menu

Displays the signal that each individual Joystick sends to the main board.

## 6.6 LITHIUM-ION MACHINE ONLY - ADDITIONAL MAINTAINANCE INFORMATION

### Cleaning the Machine

#### **⚠ WARNING**

WHEN WASHING THE MACHINE, THE MAIN POWER SWITCH MUST BE DISENGAGED, THE KEY REMOVED AND THE EMERGENCY STOP BUTTON PRESSED.

- Washing the outside of the machine;

Never use flammable liquids. Adopt the above safety measures to prevent sparks due to short-circuits.

If washing the track with a cleaning solution, carefully cover all the vital parts and above all the electrical components. Follow the instructions provided by the manufacturer of the cleaning solution.

Clean the machine using only water-soluble detergents.

The more often the machine is cleaned, the more it will need to be re-greased (*see lubrication chart*).

Do not wet the electric motors and the other electrical components directly.

Do not aim the spray directly onto decals and rating plates.

- Cleaning the electrical system;

#### **⚠ WARNING**

NEVER CLEAN THE INVERTER OR THE ELECTRIC MOTOR WITH WATER, AS THIS MAY CAUSE DAMAGE TO THE ELECTRICAL SYSTEM.

#### **NOTICE**

Only use dry detergents, in accordance with the manufacturers' instructions. Never remove covers, guards and the like.

Clean the electrical system using a dry, non-metallic brush and low pressure air.

- After cleaning

Dry the machine carefully before starting it again (for example using compressed air).

#### **⚠ WARNING**

IF, DESPITE ALL THE PRECAUTIONS, MOISTURE HAS PENETRATED INTO THE ELECTRIC MOTOR OR OTHER PARTS OF THE ELECTRIC SYSTEM, THESE MUST BE DRIED USING COMPRESSED AIR TO AVOID THE RISK OF SHORT CIRCUITS.

**Battery Pack System Components and Maintenance**

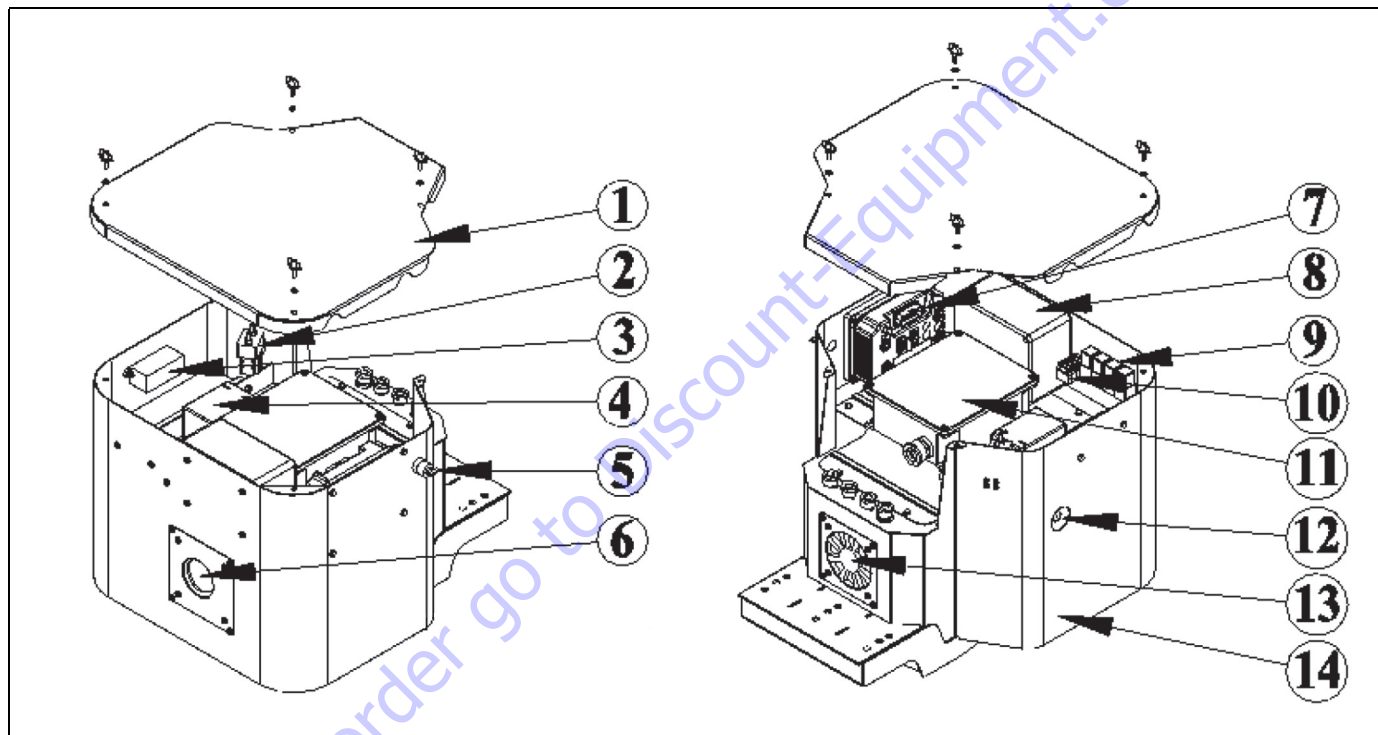

**Figure 6-6. Example of Lithium-Ion Battery Pack Components**

1. Battery Case Cover
2. External Main Contactor
3. 160A Fuse
4. 12V - 55Ah Battery Charger
5. On/off Key Switch
6. Suction Fan
7. Inverter
8. 72V/12V DC/DC
9. Relay
10. Fuses
11. Battery Management System
12. Battery Charge Indicator
13. Blower Fan
14. Battery Case - 22 Cells (100Ah)

### CAUTION

**WHEN RECHARGING THE BATTERY PACK AND DURING ANY OTHER MAINTENANCE OPERATION ON THE BATTERY PACK, IT IS NECESSARY TO USE AT LEAST THE PERSONAL PROTECTIVE EQUIPMENT (PPE) LISTED BELOW.**

- Eye protection devices  
Protective glasses, for protection against sprays of hazardous materials.
- Hand protection devices  
Hand protection gloves, for protection and insulation during work on live parts.
- Foot protection devices  
Shoes with antistatic coating able to insulate the worker during work on the electrical parts of the system.



## SECTION 6 - GENERAL SPECIFICATIONS AND OPERATOR MAINTENANCE

### Lithium-Ion Machine Fault Codes

(See "Errors Menu" on page 6-32 info for display information)

**Table 6-10. Inverter Fault Codes**

CODE	DESCRIPTION
1	Wrong Config Cause - EEPROM memory not configured. Solution - Contact Hinowa after sales service.
8	Watch Dog Cause - Inverter cannot start or stop electric motor. Solution - Check connections and continuity of electric motor. If OK, replace inverter.
13	Eeprom KO Cause - EEPROM hardware or software problem. Solution - Replace inverter.
16	Aux output KO Cause - Problem with electromechanical brake. Solution - This is generally a temporary problem due to certain working conditions. If problem persists, replace inverter.
17	Logic failure #3 Cause - Activated in the event of high inverter current peaks. Solution - This is generally a temporary problem due to certain working conditions. If problem persists, replace inverter.
18	Logic Failure #2 Cause - Internal fault in the inverter. Solution - Replace inverter.

**Table 6-10. Inverter Fault Codes**

CODE	DESCRIPTION
19	Logic failure #1 Cause - Sudden voltage surge or voltage drop. Solution - This is a temporary problem due to certain working conditions. If problem persists, replace inverter.
30	VMN low Cause - Inverter power supply voltage is lower than battery voltage, or alternatively incorrect connection to positive battery pole. Solution - Check connection to positive battery pole. If problem persists, replace inverter.
31	VMN High Cause - One motor phase not connected correctly or faulty. Solution - Check motor phases. If problem persists, replace inverter.
37	Contact closed Cause - Relay remains closed when power to coil is disconnected. Solution - Check relay.
38	Contact Open Cause - Inverter supplies power to relay coil but contact does not close. Solution - Check relay and power supply to coil.
49	I=0 Ever Cause - Feedback current from motor sensor not constantly at 0. Solution - Check connection to motor.

## SECTION 6 - GENERAL SPECIFICATIONS AND OPERATOR MAINTENANCE

**Table 6-10. Inverter Fault Codes**

CODE	DESCRIPTION
53	STBY I high Cause – Internal fault detected in the inverter. Solution – This is generally a temporary problem due to certain working conditions. If problem persists, replace inverter.
60	Capacitor Charge Cause – Internal fault in the inverter. Solution – Check connections and motor phases.
61	High temperature Cause – High temperature inside the inverter. Solution – Improve cooling to inverter. If fault persists, contact JLG after-sales service.
65	Motor temperature Cause – High motor temperature. Solution – Temporarily stop machine to allow motor to cool down.
67	Can Bus KO Cause – Inverter doesn't receive any information from Can Bus line. Solution – Check connections using multifunction tester.
70	Encoder Error Cause – Problem detected with encoder (=motor speed sensor). Solution – Check speed sensor connection. Anomaly may also have been caused by fault with bearing.

**Table 6-10. Inverter Fault Codes**

CODE	DESCRIPTION
73	Thermis sensor KO Cause – Signal from temperature sensor greater than 4.95 Volts or less than 0.1 Volt. Solution – This is generally a temporary problem due to certain working conditions. If problem persists, replace inverter.
74	Driver shorted Cause – Relay power supply fault. Solution – Check relay power supply. This is generally a temporary problem due to certain working conditions. If problem persists, replace inverter.
75	Driver shorted Cause – Relay power supply fault. Solution – Check relay power supply. This is generally a temporary problem due to certain working conditions. If problem persists, replace inverter.
76	Coil shorted Cause – Problem detected with relay coil. Solution – Make sure relay coil is intact.
78	VACC not OK Cause – Solution – This is generally a temporary problem due to certain working conditions. If problem persists, replace inverter.

## SECTION 6 - GENERAL SPECIFICATIONS AND OPERATOR MAINTENANCE

---

**Table 6-10. Inverter Fault Codes**

CODE	DESCRIPTION
79	Incorrect start Cause – Incorrect starting procedure. Solution – Check electrical connections. This is generally a temporary problem due to certain working conditions. If problem persists, replace inverter.
86	Pedal wire KO Cause – Solution – This is generally a temporary problem due to certain working conditions. If problem persists, replace inverter.
93	Wrong set batt Cause – With power connected, battery test detected incorrect batteries fitted. Solution – Replace batteries with the original ones supplied directly by JLG.
94	Current sensor KO Cause – Set up procedure for maximum current in progress. Solution – Contact JLG after-sales service.
99	Check up needed Cause – Solution – Contact Hinowa after.sales service.

### BMS Fault Codes - (Battery Management System)

(See "Errors Menu" on page 6-32 info for display information)

**NOTE:** The CODE column indicates the CAN CODE in the message sent by the battery charger. The normal mains voltage tolerance is the rated value  $\pm 15\%$ .

#### CODE – TYPE OF ERROR

A99E01 – Configuration error

A99E02 – Incorrect voltage

A99E03 – Incorrect temperature

A99E04 – Excess discharge current

A99E05 – Excess charge current

A99E06 – Pre.charge error

A99E07 – No 12 V power supply

A99E08 – No 12 V power supply

A99E09 – High battery compartment temperature

A99E10 – High electronic board temperature

A99E11 – Incorrect self.protection device temperature

A99E12 – Fault on all temperature sensors

A99E13 – Temperature sensor fault

A99E14 – Earth connection fault

A99E01 – Incorrect system configuration

A99E02 – Incorrect voltage

A99E03 – Incorrect temperature

A99E04 – Excess discharge current

A99E05 – Excess charge current

A99E06 – Pre.charge error

A99E07 – No 12 V power supply

A99E08 – No 12 V power supply

A99E09 – High battery compartment temperature

A99E15 – Bootloader error

A99E16 – Secondary protection

A99E17 – Control device error

A99E18 – Power board error

A99E19 – I2C module not ready

A99E20 – I2C TX error

A99E21 – I2C RX error

A99E22 – I2C RX error 2

A99E23 – AD error

A99E99 – General error

## SECTION 6 - GENERAL SPECIFICATIONS AND OPERATOR MAINTENANCE

### Battery Charger Fault Codes

(See "Errors Menu" on page 6-32 info for display information)

**Table 6-11. Battery Charger Fault Codes**

CODE	DESCRIPTION	STATUS	ACTION
8	Internal logic fault.	Battery charger stops working.	Contact service dept. or change product.
13	Communication problem with external memory.	Battery charger stops working.	Contact service dept. or change product.
18	Extended shutdown or power failure.	Battery charger stops supplying power. Operation resumes as soon as alarm conditions are no longer present or after restarting.	If problem is a power failure, check battery charger mains power supply.
19	Internal logic fault.	Battery charger stops working.	Contact service dept. or change product.
240	Digital input is open and managed as hardware start-stop.	Battery charger stops charging until digital input closes.	Close digital input.
241	Problem in CANBUS communication with other systems in the network.	The way this is managed may change based on different firmware releases.	Check correct operation of CANBUS system.
242	Error when reading internal memory on microcontroller.	Battery charger stops working.	Contact service dept. or change product.
244	Mains voltage lower than maximum operating range tolerance.	Battery charger won't start charging until mains voltage returns within normal operating range.	Make sure mains voltage is within correct operating parameters.
245	Abnormal current draw in primary section.	Battery charger stops supplying power. Operation resumes as soon as alarm conditions are no longer present.	If problem persists, contact service dept. or change product.

## SECTION 6 - GENERAL SPECIFICATIONS AND OPERATOR MAINTENANCE

**Table 6-11. Battery Charger Fault Codes**

CODE	DESCRIPTION	STATUS	ACTION
246	Stage 1 ended by timeout without reaching control voltage.	Battery charger stops working.	Make sure battery capacity is compatible or check that battery is compliant with battery charger. If battery is correct and problem persists, contact service dept.
248	Temperature inside battery charger too high.	If internal temperature exceeds 80°C, battery charger reduces power to 80%, while it stops operating altogether if internal temperature exceeds 90°C. Battery charger starts at full power again when internal temperature falls below 70°C.	
249	Battery temperature too high.	If temperature exceeds 55°C or is less than -20°C, battery charger stops working. When battery temperature falls below 45°C or exceeds -10°C battery charger resumes normal operation.	
251	Power failure detected.	Battery charger stops supplying power. Operation resumes as soon as alarm conditions are no longer present.	If problem persists, check battery charger mains power supply.
252	Short-circuit in battery charger output.	Battery charger stops working.	Turn off battery charger and resolve short circuit at output. If problem persists, contact service dept. or change product.
253	Mains voltage higher than maximum operating range tolerance.	Battery charger won't start charging until mains voltage returns within normal operating range.	Make sure mains voltage is within correct operating parameters.

### 6.5 LITHIUM-ION BATTERY PACK - HANDLING IN DANGEROUS CONDITIONS

The battery cells must be handled correctly in order to ensure proper and safe use. However, if mistakes are made in handling the cells, causing explosion or venting, the user has to be equipped so as to be able to face this emergency. The aim of this section is to adequately train the user on safe handling of the cells that have been subjected to extreme conditions.

#### ***These Conditions Are As Follows:***

1. Hot cells
2. Cells that have released substances or vented
3. Exploded cells
4. Fire enveloping the lithium batteries

### Procedure For Handling Hot Cells

As soon as it has been established that the temperature of a cell has risen considerably, the first action is the evacuation of personnel from the affected area. The area has to be isolated and nobody can enter if not strictly necessary.

If possible, before leaving the area, the person who first identified the problem has to check if there is an external short-circuit and resolve it as soon as possible. After the short-circuit has been resolved, the cell will start to cool down. However, the area has to remain isolated until the cell reaches ambient temperature and is removed from the area. The temperature of the cell has to be checked periodically using a remote sensor such as an infrared sensor. If the cell remains hot the following actions must be assessed.

#### ***Minimum Equipment Required:***

- Infrared temperature probe
- Safety glasses
- Hard hat with impact resistant face visor
- Non-conductive pliers
- Hand, arm and body protection

### Start Procedure;

1. Evacuate the area as soon as abnormal cell temperature has been established.
2. Periodically check the temperature of the cell using a remote sensor for the first two hours or until one of the following cases occur:
  - The cell starts to cool down
  - The cell vents
  - The cell explodes
3. If the cell starts cooling, check the temperature every hour until ambient temperature has been reached.
4. If a temperature sensor is not available, do not handle the cell for a minimum of 24 hours.
5. Remove the cell from the work area when ambient temperature has been reached and return to normal operations.
6. Dispose of the cell in accordance with existing legislation (in the country in question) on hazardous materials.

*The procedures in cases of venting or explosion are examined in the following paragraphs.*

### Procedure For Handling Vented Cells

In normal conditions a cell does not show leaks or venting, however a cell may vent or release substances if the critical temperature is reached or if the protective glass/metal seal breaks due to severe mechanical conditions.

The severity of the leak consequent to venting ranges from slight leak around the seal to a violent leak of substances through the vent. In some cases, if the cell is not plugged, it may behave as a projectile.

The electrolyte inside the cell may cause very serious irritation to the respiratory tract, eyes and skin. In addition, venting may cause the emission of highly corrosive vapors in the work environment. In this case, all protective equipment suited to limit exposure to toxic fumes must be available.

### Minimum Equipment Required;

- Class D fire extinguisher
- Eye protection or face shield
- Respirator with filter for hydrochloric acid and sulphur dioxide
- Neoprene gloves
- Acid-resistant lab coats
- Baking soda, calcium oxide or acid absorbent in kit form
- Vermiculite
- Plastic bags



## **SECTION 6 - GENERAL SPECIFICATIONS AND OPERATOR MAINTENANCE**

---

### **Start Procedure;**

In the event of electrolyte release from the cells, proceed as follows:

1. Evacuate the people exposed to fumes from the area.
2. Air the environment until the complete removal of the cell and until the characteristic pungent odour has disappeared.
3. If the cell is too hot, allow it to cool to ambient temperature before handling it (see "Procedure For Handling Hot Cells" on page 6-42).
4. Wear safety equipment: coat, gloves, mask and filters, and move the cell to a well-ventilated area.
5. Place every cell in a sealable plastic bag and remove the excess air, then seal the bag.
6. Place a cup of vermiculite in a second bag, place the first bag in the second and seal it.
7. Place everything in a third bag with some baking soda and seal the bag.
8. Absorb and collect the leaked electrolyte with absorbent material or baking soda.
9. Place the absorbent material in a bag and seal it.
10. Clean the area with plenty of water.
11. Dispose of the hazardous material in accordance with the local legislation in force.

### **First Aid In The Event Of Contact With The Electrolyte**

#### **EYES**

Immediately wash the eyes in abundant running water for at least 15 minutes, keeping the eyelids open and flushing the eye and back of the eyelid. Immediately seek medical help.

#### **SKIN**

Wash in cold water under a shower, remove contaminated garments. Continue washing for at least 15 minutes. Seek medical help where necessary.

#### **RESPIRATORY TRACT**

Move the person(s) outdoors into the open air. If the person(s) has difficulty breathing, have oxygen administered by trained personnel. If breathing stops, apply mouth-to-mouth resuscitation and immediately seek emergency medical help.

### Procedure For Exploded Cells

The explosion of lithium batteries is not likely, it is a rare event that only occurs when an abnormal condition causes the temperature to rise and reach a critical point. However, in the event of lithium battery explosion the environment will quickly be filled with dense white smoke which will cause serious irritation to the respiratory tract, eyes and skin. Precautions must be taken to limit exposure to these fumes.

#### Minimum Equipment Required;

- Class D fire extinguisher
- Class ABC extinguisher for any secondary fires
- Eye protection or face shield
- Respirator with filter for hydrochloric acid and sulphur dioxide
- Neoprene gloves
- Acid-resistant lab coats
- Baking soda, calcium oxide or acid absorbent in kit form
- Vermiculite
- Plastic bags

#### Start Procedure;

In the event of cell explosion, proceed as follows:

1. Evacuate personnel from the areas contaminated by smoke.
2. Ventilate the rooms until the cell has been removed from the area and until the characteristic pungent odor has disappeared.
3. Even if this is quite unlikely, there may be fires as a consequence of the explosion. The ways these emergencies are faced are described in the following paragraph.
4. The exploded cell may be hot. Allow it to cool down to ambient temperature before handling it (see Procedure for handling hot cells).
5. Wear safety equipment: coat, gloves, mask and filters.
6. In case of explosion the area around the cell will be covered by a black carbonaceous material which contains metallic parts of the cell. Cover the carbonaceous residues with a 50/50 mixture of baking soda and vermiculite or other absorbent material. Avoid contact between the metallic residues and charged cells, as this condition may cause a short.circuit.
7. Place the contaminated material in a sealable plastic bag and remove the excess air.
8. Seal the bag.
9. Place a cup of vermiculite in a second bag, place the first bag in the second and seal it.

## **SECTION 6 - GENERAL SPECIFICATIONS AND OPERATOR MAINTENANCE**

---

10. Clean the area with plenty of water and keep cleaning with water and soap.
11. Dispose of the hazardous material in accordance with the local legislation in force.

### ***First Aid In The Event Of Contact With The Electrolyte;***

#### **EYES**

Immediately wash the eyes in abundant running water for at least 15 minutes, keeping the eyelids open and flushing the eye and back of the eyelid. Immediately seek medical help.

#### **SKIN**

Wash in cold water under a shower, remove contaminated garments. Continue washing for at least 15 minutes. Seek medical help where necessary.

#### **RESPIRATORY TRACT**

Move the casualty outdoors into the open air. If the person(s) has difficulty breathing, have oxygen administered by trained personnel. If breathing stops, apply mouth-to-mouth resuscitation and immediately seek emergency medical help.

### **Lithium Battery Fire**

All metals may burn in certain conditions, which depend on certain factors such as: physical state, presence of oxidizing atmospheres and severity of the source of ignition. Alkali metals such as lithium may burn in normal atmospheres. In addition, lithium reacts explosively with water to form hydrogen and the presence of small quantities of water may set fire to the material and the hydrogen gas that is released. Once metal fires start they are very hard to extinguish with ordinary equipment. This is partly due to the strong heat produced by the burning metal, whose temperature may reach 1832° F (1000° C). In addition, lithium may react with certain materials commonly used in fire extinguishers, like water and CO<sub>2</sub>. Special extinguishers are required, designed for controlling and extinguishing lithium fires.

In particular, graphite-based extinguishers (Lith-x) are used. Usually these extinguishers work by forming a crust or a layer of material on the surface of the burning metal. Lith-x, which is a common graphite-based agent, may be used with an extinguisher or spread over the fire. In the event of lithium fire, the room may fill with a dense white smoke, mostly formed by lithium oxide and other metal oxides. This condition may cause serious damage to the respiratory tract, skin and eyes. All precautions needed to limit exposure to these fumes must be adopted. It should be noted that this procedure is applicable only to fires on individual

## SECTION 6 - GENERAL SPECIFICATIONS AND OPERATOR MAINTENANCE

cells. Larger fires have to be managed only by professionally trained personnel.

Finally, it should be noted that in the presence of combustible materials other than lithium it is advisable to use different types of extinguishers in conjunction to better ensure the extinguishing action of each on the appropriate material, however do not use water or CO2 extinguishers directly on lithium fires.

### **Minimum Equipment Required;**

- Class D fire extinguisher
- Class ABC extinguisher for any secondary fires
- Breathing apparatus
- Fireproof clothing
- Fireproof gloves
- Mask or protective glasses
- Non.conductive pliers
- Dustpan, mineral oil

### **Start Procedure;**

1. In the event of fire on one cell, a team of experienced fire-fighting personnel has to be contacted. The personnel must be properly trained to fight lithium battery fires.
2. Evacuate personnel from all areas and sound the fire alarm.

3. The fire-fighting personnel go to the area where the fire is located and gather all the information regarding the situation and the person who gave the alarm.
4. Quarantine the area. Air the rooms until the burning material has been removed from the area and the characteristic pungent odor has disappeared.
5. Two members of the team enter the area with appropriate safety equipment.

**NOTE:** *Lithium melts at 356° F (180° C). It becomes highly reactive and when it catches fire it may eject molten lithium particles. For this reason the surrounding cells may overheat and cause a violent explosion. The fire-fighting personnel must pay attention to any dangerous materials located near the fire.*

6. Completely cover the fire with extinguishing material. Never leave the fire unattended as it may develop again.
7. If necessary, extinguish the secondary fires with suitable extinguishers.
8. After all the material has burned and cooled down, carefully mix the residual material to prevent resumption of the fire.
9. Put the material in a metal drum, cover the surface with plenty of extinguishing material.
10. The residual material may contain un-reacted lithium, therefore limit exposure to rain by covering, for example, with mineral oil.

## **SECTION 6 - GENERAL SPECIFICATIONS AND OPERATOR MAINTENANCE**

---

11. Wear safety equipment: coat, gloves, mask and filters.
12. The area around the cell will be covered by a black carbonaceous deposit which contains metallic parts of the cell. Cover the carbonaceous residue with a 50/50 mixture of baking soda and vermiculite or other absorbent material. Avoid contact between the metallic residue and charged cells as this condition may cause a short.circuit.
13. Place the contaminated material in a sealable plastic bag and remove the excess air.
14. Seal the bag.
15. Place a cup of vermiculite in a second bag, place the first bag in the second and seal it.
16. Clean the area with plenty of water and keep cleaning with water and soap.
17. Dispose of hazardous material in accordance with the local legislation in force.

### ***First Aid In The Event Of Contact With The Electrolyte;***

#### **EYES**

Immediately wash the eyes in abundant running water for at least 15 minutes, keeping the eyelids open and flushing the eye and back of the eyelid. Immediately seek medical help.

#### **SKIN**

Wash in cold water under a shower, remove contaminated garments. Continue washing for at least 15 minutes. Seek medical help where necessary.

#### **RESPIRATORY TRACT**

Move the person(s) outdoors into the open air. If the person(s) has difficulty breathing, have oxygen administered by trained personnel. If breathing stops apply mouth-to-mouth resuscitation and immediately seek emergency medical help.

**TO PURCHASE THIS PRODUCT PLEASE CONTACT US**



**Equipment Financing and  
Extended Warranties Available**



**Discount-Equipment.com is your online resource for  
commercial and industrial quality parts and equipment sales.**

**561-964-4949**

**visit us on line @ [www.discount-equipment.com](http://www.discount-equipment.com)**

Select an option below to find your Equipment

**Search by Manufacturer**

**Search by Product Type**

**Request a Quote**

We sell worldwide for the brands: Genie, Terex, JLG, MultiQuip, Mikasa, Essick, Whiteman, Mayco, Toro Stone, Diamond Products, Generac Magnum, Airman, Haulotte, Barreto, Power Blanket, Nifty Lift, Atlas Copco, Chicago Pneumatic, Allmand, Miller Curber, Skyjack, Lull, Skytrak, Tsurumi, Husquvarna Target, Stow, Wacker, Sakai, Mi-T-M, Sullair, Basic, Dynapac, MBW, Weber, Bartell, Bennar Newman, Haulotte, Ditch Runner, Menegotti, Morrison, Contec, Buddy, Crown, Edco, Wyco, Bomag, Laymor, EZ Trench, Bil-Jax, F.S. Curtis, Gehl Pavers, Heli, Honda, ICS/PowerGrit, IHI, Partner, Imer, Clipper, MMD, Koshin, Rice, CH&E, General Equipment, Amida, Coleman, NAC, Gradall, Square Shooter, Kent, Stanley, Tamco, Toku, Hatz, Kohler, Robin, Wisconsin, Northrock, Oztec, Toker TK, Rol-Air, APT, Wylie, Ingersoll Rand / Doosan, Innovatech, Con X, Ammann, Mecalac, Makinex, Smith Surface Prep, Small Line, Wanco, Yanmar



3121637



An Oshkosh Corporation Company



[www.Discount-Equipment.com](http://www.Discount-Equipment.com)

To order go to [www.Discount-Equipment.com](http://www.Discount-Equipment.com)